



Prepared for

DTE Electric Company
One Energy Plaza
Detroit, Michigan 48226

ALTERNATE LINER DEMONSTRATION DIVERSION BASIN

**BELLE RIVER POWER PLANT
East China Township, Michigan**

Prepared by

Geosyntec 
consultants

Geosyntec Consultants of Michigan

3011 West Grand Boulevard, Suite 2300
Detroit, Michigan 48202

GLP8017

April 2023

TABLE OF CONTENTS

1. INTRODUCTION.....	1-1
1.1 Background	1-1
1.2 Purpose.....	1-2
1.3 Report Organization.....	1-2
1.4 Terms of Reference	1-2
2. CHARACTERIZATION OF SITE HYDROGEOLOGY	2-1
2.1 Introduction	2-2
2.2 Site Geology.....	2-2
2.2.1 Diversion Basin Site-Specific Geology.....	2-2
2.3 Uppermost Aquifer Field Testing and Hydrogeology.....	2-3
2.4 Summary of Data Used for Site Characterization.....	2-3
2.5 ALD-Specific Site Investigation Details.....	2-4
2.5.1 Cone Penetration Tests.....	2-4
2.5.2 Sonic Drilling	2-5
2.5.3 Laboratory Testing	2-5
2.6 Conceptual Site Model.....	2-5
3. POTENTIAL FOR INFILTRATION	3-1
3.1 Site-Specific Soil and Porewater Details	3-1
3.1.1 Soil Samples for Hydraulic Conductivity Testing	3-1
3.1.2 Site-Specific Porewater Testing and Results.....	3-2
3.2 Hydraulic Conductivity Testing Procedure.....	3-2

3.3 Hydraulic Conductivity Test Results and Assessment.....	3-3
4. FATE AND TRANSPORT MODEL ANALYSES	4-1
4.1 Introduction	4-1
4.2 Groundwater Protection Standards.....	4-2
4.3 Consideration of Background Groundwater Concentrations	4-2
4.4 CCR Porewater Quality Results.....	4-2
4.5 Fate and Transport Model	4-3
4.5.1 Analysis Model.....	4-3
4.5.2 Proposed Mathematical and Associated Computer Model	4-3
4.5.3 Fate and Transport Model Inputs	4-4
4.6 Fate and Transport Analysis Results and Evaluation.....	4-7
4.6.1 Fate and Transport Baseline Model Results.....	4-7
4.6.2 Sensitivity Analysis.....	4-7
4.6.3 Reliability of Computer Model	4-9
4.6.4 Degree of Conservativeness in Model Results.....	4-9
5. SUMMARY	5-1
6. CERTIFICATION.....	6-1
7. REFERENCES	7-1
Table 4-2 – Baseline Fate and Transport Results.....	7-2

LIST OF TABLES

Table 2-1 – Field and Laboratory Testing Summary

Table 2-2 – Pore Pressure Dissipation Tests Results

Table 3-1 – Chemistry Results of Site-Specific Filtered CCR Porewater

Table 3-2 – Summary of Hydraulic Conductivity Tests Results

Table 3-3 – Summary of Compatibility Tests - Hydraulic Conductivity and Pore Volumes Passed Results

Table 3-4 – Summary of Compatibility Tests - pH Results

Table 3-5 – Summary of Compatibility Tests - Electrical Conductivity Results

Table 3-6 – Summary of Compatibility Tests - Termination Criteria

Table 4-1 – Groundwater Protection Standards

Table 4-2 – Baseline Fate and Transport Results

Table 4-3 – Background and Predicted Concentrations Compared to GWPS

Table 4-4 – Sensitivity Analysis Model Inputs

Table 4-5 – Sensitivity Analysis Model Results

LIST OF FIGURES

Figure 1-1 – Site Plan

Figure 2-1 – Field Investigation Locations

Figure 2-2 – Site Map with Cross Section Transects

Figure 2-3 – Cross Section A-A'

Figure 2-4 – Cross Section B-B'

Figure 2-5 – Cross Section C-C'

Figure 3-1 – Filtered BAB and DB Porewater Sample Piper Diagram

Figure 3-2 – B1-ST-1 (7-9') PV Passed with Time

Figure 3-3 – B1-ST-1 (7-9') Hydraulic Conductivity with Time

Figure 3-4 – B1-ST-1 (7-9') Hydraulic Conductivity with PV

Figure 3-5 – B1-ST-1 (7-9') pH of Inflow and Outflow with Time

Figure 3-6 – B1-ST-1 (7-9') Electrical Conductivity (EC) with Time

Figure 3-7 – B2-ST-1 (1-3') PV Passed with Time

Figure 3-8 – B2-ST-1 (1-3') Hydraulic Conductivity with Time

Figure 3-9 – B2-ST-1 (1-3') Hydraulic Conductivity with PV

Figure 3-10 – B2-ST-1 (1-3') pH of Inflow and Outflow with Time

Figure 3-11 – B2-ST-1 (1-3') Electrical Conductivity (EC) with Time

Figure 3-12 – B2-ST-4 (47-49') PV Passed with Time

Figure 3-13 – B2-ST-4 (47-49') Hydraulic Conductivity with Time

Figure 3-14 – B2-ST-4 (47-49') Hydraulic Conductivity with PV

Figure 3-15 – B2-ST-4 (47-49') pH of Inflow and Outflow with Time

Figure 3-16 – B2-ST-4 (47-49') Electrical Conductivity (EC) with Time

Figure 3-17 – B3-ST-5 (77-79') PV Passed with Time

Figure 3-18 – B3-ST-5 (77-79') Hydraulic Conductivity with Time

Figure 3-19 – B3-ST-5 (77-79') Hydraulic Conductivity with PV

Figure 3-20 – B3-ST-5 (77-79') pH of Inflow and Outflow with Time

Figure 3-21 – B3-ST-5 (77-79') Electrical Conductivity (EC) with Time

Figure 3-22 – B4-ST-3 (47-49') PV Passed with Time

Figure 3-23 – B4-ST-3 (47-49') Hydraulic Conductivity with Time

Figure 3-24 – B4-ST-3 (47-49') Hydraulic Conductivity with PV

Figure 3-25 – B4-ST-3 (47-49') pH of Inflow and Outflow with Time

Figure 3-26 – B4-ST-3 (47-49') Electrical Conductivity (EC) with Time

Figure 3-27 – B5-ST-5 (87-89') PV Passed with Time

Figure 3-28 – B5-ST-5 (87-89') Hydraulic Conductivity with Time

Figure 3-29 – B5-ST-5 (87-89') Hydraulic Conductivity with PV

Figure 3-30 – B5-ST-5 (87-89') pH of Inflow and Outflow with Time

Figure 3-31 – B5-ST-5 (87-89') Electrical Conductivity (EC) with Time

Figure 4-1 – Fate and Transport Conceptual Model

LIST OF APPENDICES

Appendix A – Monitoring Well Slug Test Results

Appendix B – Monitoring Well Logs

Appendix C – 1970s Boring Logs

Appendix D – 2016 Boring Logs

Appendix E – 2020 Boring Logs

Appendix F – 1970s Laboratory Test Results

Appendix G – 2016 Laboratory Test Results

Appendix H – 2020 Laboratory Test Results

Appendix I1 – CPT Logs

Appendix I2 – PPD Test Results

Appendix J – Chemistry Analysis of Site-Specific Water

Appendix K – ALD Hydraulic Conductivity Test Results

Appendix L – Groundwater Protection Standard Calculations

Appendix M – Fate and Transport Model Inputs

Appendix N – Fate and Transport Model Outputs

1. INTRODUCTION

This report has been prepared to provide the Alternate Liner Demonstration (ALD) of Belle River Power Plant Diversion Basin (DB), one of two coal combustion residuals (CCR) units at the site, in accordance with 40 CFR Part 257 as amended on November 12, 2020 (CCR Part B Rule). **Figure 1-1** provides the site location.

This report concludes that there is no reasonable probability that water from the DB will cause a release to the groundwater that will exceed the groundwater protection standards (GWPS) at the waste boundary over the projected active life of the CCR unit.

1.1 Background

DTE Electric Company (DTE) submitted the Alternate Liner Demonstration Application for the DB to the United States Environmental Protection Agency (USEPA) on November 30, 2020 [1] in accordance with the CCR Rule. Soon after, DTE started the field and laboratory investigation studies to meet the requirements of the CCR Rule.

One of the requirements of the CCR Rule is to conduct hydraulic conductivity testing using site-specific permeant liquid. The CCR Rule acknowledges that these tests may last a long time such that the operator of the CCR unit may need to submit an extension request for the laboratory testing program, and submit a preliminary ALD.

DTE submitted extension requests due to “analytical limitation” under separate covers, dated September 1, 2021 [2] and September 1, 2022 [3]. The extension requests detailed the compatibility testing program results through August 12, 2022. The USEPA has not yet responded to the extension requests.

The Part B Rule does not require the submittal of a preliminary ALD (PALD) by November 30, 2021 if an extension request is submitted in accordance with §257.71(d)(2)(ii)(A). However, DTE provided a PALD [4] out of an abundance of caution and with confidence in the performance of the liner system as a “place holder” to comply with the requirement to submit an ALD by November 30, 2021.

The PALD detailed the site investigation, conceptual site model, laboratory study, and fate and transport model concluding that there is no reasonable probability that water from the DB will cause a release to the groundwater that will exceed the GWPS at the waste boundary over the projected active life of the CCR unit. This ALD includes additional data analyzed subsequent to the submittal of the PALD, and confirms the appropriateness of the hydraulic conductivities used in the PALD fate and transport model.

1.2 Purpose

The purpose of this report is to provide the final ALD including the approach, analysis details, and results in accordance with the CCR Rule.

1.3 Report Organization

The remainder of this report is organized as follows:

- Section 2 – provides the field and laboratory investigation details, information on site geology/hydrogeology, and conceptual site model details.
- Section 3 – provides results of hydraulic conductivity testing, termination criteria details, chemistry testing of site-specific porewater, and discussion of results.
- Section 4 – provides analysis approach, details, GWPS, and evaluation of results as to whether the DB meets the ALD requirement of the CCR Rule.
- Section 5 – provides a summary of the report.
- Section 6 – provides certification.
- Section 7 – provides references.

1.4 Terms of Reference

This report was prepared by Mike Coram C.P.G., Clinton Carlson Ph.D., P.E., Jesse Varsho P.E., and reviewed by John Seymour, P.E. of Geosyntec Consultants of Michigan, Inc.(Geosyntec).

2. CHARACTERIZATION OF SITE HYDROGEOLOGY

The CCR Rule requires the following:

§257.71(d)(ii)(A) Characterization of site hydrogeology. A characterization of the variability of site-specific soil and hydrogeology surrounding the surface impoundment that will control the rate and direction of contaminant transport from the impoundment. The owner or operator must provide all of the following as part of this line of evidence:

(1) Measurements of the hydraulic conductivity in the uppermost aquifer from all monitoring wells associated with the impoundment(s) and discussion of the methods used to obtain these measurements;

(2) Measurements of the variability in subsurface soil characteristics collected from around the perimeter of the CCR surface impoundment to identify regions of substantially higher conductivity;

(3) Documentation that all sampling methods used are in line with recognized and generally accepted practices that can provide data at a spatial resolution necessary to adequately characterize the variability of subsurface conditions that will control contaminant transport;

(4) Explanation of how the specific number and location of samples collected are sufficient to capture subsurface variability if:

(i) Samples are advanced to a depth less than the top of the groundwater table or 20 ft beneath the bottom of the nearest water body, whichever is greater, and/or

(ii) Samples are spaced further apart than 200 ft around the impoundment perimeter;

(5) A narrative description of site geological history; and

(6) Conceptual site models with cross-sectional depictions of the site environmental sequence stratigraphy that include, at a minimum:

(i) The relative location of the impoundment with depth of ponded water noted;

(ii) Monitoring wells with screening depth noted;

(iii) Depiction of the location of other samples used in the development of the model;

(iv) The upper and lower limits of the uppermost aquifer across the site;

(v) The upper and lower limits of the depth to groundwater measured from monitoring wells if the uppermost aquifer is confined; and

(vi) Both the location and geometry of any nearby points of groundwater discharge or recharge (e.g., surface waterbodies) with potential to influence groundwater depth and flow measured around the unit.

2.1 Introduction

This section provides information on site geology and hydrogeology, data used in site characterization, a summary of ALD-specific field and laboratory study, and a conceptual site model built using the Environmental Visualization System (EVS).

2.2 Site Geology

The surficial topography of St. Clair County is characterized by a low-relief floodplain, stream terrace, and lakeshore deposits. The subsurface geology of the area is defined by glacial deposits, which range in thickness from 100- to 400-feet (ft) thick. These glacial sediments, including lacustrine, till, and sand and gravel outwash deposits, were deposited on the underlying bedrock. Throughout St. Clair County the underlying bedrock varies but is primarily fine-grained siliclastic rock, mostly shale with some sandstone [1].

The St. Clair River is the major surface water body in the county and runs along the eastern boundary of the county. Shallow regional groundwater flow would be expected to be to the east towards the St. Clair River. The DB is located approximately one mile west of the St. Clair River.

2.2.1 Diversion Basin Site-Specific Geology

The geology of St. Clair County consists of approximately 100 to 400 ft of glacial deposits, primarily lacustrine deposits, till, and, to a lesser extent, sand and gravel outwash, overlying a variety of bedrock surfaces. The glacial material underlying the DB appears to be glaciolacustrine clays with local sand lenses. The uppermost aquifer unit appears to be associated with ice contact directly above the bedrock surface (Bedford Shale).

The DB is underlain by 115 to 130 ft of unconsolidated sediments, with the uppermost aquifer unit directly above the Bedford Shale. The uppermost aquifer unit is laterally consistent throughout the DB. During Geosyntec's ALD investigation in December 2020, cone penetration tests (CPT) and pore pressure dissipation (PPD) tests were performed to determine hydraulic conductivity of the underlying clay-rich deposits. The results of the PPD tests are summarized in Section 2.5.1.

The CPT data confirm that the underlying deposits are consistently low hydraulic conductivity units.

The uppermost aquifer unit within the DB is a confined, silty aquifer that directly overlies the Bedford Shale. It is approximately three to five feet in thickness and is encountered at approximately 115 to 130 ft below ground surface (bgs) directly below the bottom of the DB. To the northwest, the silty aquifer transitions into a sandy aquifer and increases in thickness; specifically, in the vicinity of the Bottom Ash Basins (BABs) located to the northwest. For the purposes of this report, the silty aquifer unit within the DB is considered the “uppermost aquifer unit” and is further discussed in Section 2.3.

2.3 Uppermost Aquifer Field Testing and Hydrogeology

TRC calculated the hydraulic conductivities within the CCR monitoring wells set within the upper portion of the uppermost aquifer using single well hydraulic conductivity tests (e.g., slug tests) performed in 2016 by TRC [1]. Test results are provided in **Appendix A** and are included in the conceptual site model. The monitoring well logs and construction details are presented in **Appendix B**. As calculated by TRC, the hydraulic conductivity of the uppermost aquifer using wells at the DB (MW-16-05 and MW-16-07) is approximately 0.2 ft/day (7.0E-5 centimeters per second [cm/s]). This relatively low hydraulic conductivity indicates that the uppermost aquifer has low groundwater yield potential across the site. As discussed in the TRC Initial Application for Alternative Liner Demonstration, the potential horizontal groundwater flow is to the west-northwest. The uppermost aquifer is further discussed in Section 2.6.

2.4 Summary of Data Used for Site Characterization

Data from three separate investigations were used to characterize the subsurface stratigraphy and soil characteristics for the site. Historical investigations included a 1973-1974 investigation performed by Bechtel and a 2016 investigation performed by TRC, which are included in the initial ALD Application [1]. Data from Geosyntec’s 2020 ALD Investigation were used to supplement the previous data sets. In total, these three investigations included 56 investigative locations that included 22 soil borings, 13 monitoring wells and 16 CPTs. **Figure 2-1** provides investigation locations.

Boring logs from the 1970s, 2016, and 2020 field investigations are provided in **Appendices C** through **E**, respectively. These investigations extend across the site and include the DB and BABs, which is approximately 400 ft northwest of DB. Considering the proximity of both CCR units, field investigation data are used for both the DB and BABs.

Field testing included pocket penetrometer tests on fine-grained soils, slug tests for the monitoring wells screened in the uppermost aquifer, and PPD tests at CPT locations. Lab testing included

grain size distributions, Atterberg limits, water content, dry and/or total unit weight, specific gravity, and hydraulic conductivity testing. Type of tests, standards and number of tests are summarized in **Table 2-1**. Laboratory test results are provided in **Appendices F** through **H** for the 1970s, 2016, and 2020 laboratory studies, respectively.

It is Geosyntec's opinion that the combined data used in building the site model are sufficient to capture the variability that may exist in soil conditions.

2.5 ALD-Specific Site Investigation Details

The scope of work for the ALD-Specific Site Investigation (SI) was completed in December 2020 and included drilling and sampling and advancing a CPT probe through the native soils. The purpose of the fieldwork was to obtain nominally undisturbed samples for hydraulic conductivity testing and to supplement the existing data set to characterize the alternate liner materials in accordance with the CCR Rule. Investigations were conducted generally at 200-ft intervals but adjusted in the field as necessary to avoid underground utility lines, overhead power lines, and access issues, as needed. Investigations extended down to 100 ft bgs to an elevation of approximately 490 ft, which is lower than the groundwater elevation, and 20 ft below the nearest water body that is St. Clair River with a bottom elevation of approximately 525 ft.

The following sections provide a summary of the fieldwork completed during the SI.

2.5.1 Cone Penetration Tests

Eight CPTs were completed around the DB in approximate 200 ft intervals along the east and south sides. Similarly, eight CPTs were completed around the BABs. Due to access issues to the area directly north and west of the DB, additional CPT locations were added to the south and southwest and CPT-08B/C was moved to the first accessible location west/northwest of the DB. The CPT locations are provided in **Figure 2-1**. CPTs were advanced from the ground surface to refusal or to approximately 100 ft bgs. PPD tests were conducted to estimate in-situ hydraulic conductivity at select depths; at a minimum, these tests were conducted near the sonic borings and at the elevation near where undisturbed samples were collected for laboratory hydraulic conductivity testing.

In total, 12 PPD tests were completed at CPTs advanced around the DB, and 16 PPD tests were completed at CPTs advanced around the BABs. Hydraulic conductivity values were estimated to range between 7.97E-9 cm/s and 1.63E-6 cm/s around the DB, and range between 9.76E-9 cm/s and 2.81E-6 cm/s around the BABs. Hydraulic conductivity values are similar between soils underlying the DB and BABs. Results are summarized in **Table 2-2**. These values are consistent with TRC's 2018 Natural Clay Liner Equivalency Evaluation Report [1].

CPT logs are provided in **Appendix I1**, and PPD tests are provided in **Appendix I2**.

2.5.2 Sonic Drilling

In December 2020, six soil borings were advanced at the site to evaluate the subsurface geology, collect undisturbed samples for hydraulic conductivity testing, and collect additional soil samples for characterization of native soils and the embankment. Soil samples were collected continuously in 2- to 10-ft sections from the ground surface to the termination of the soil boring. Geosyntec staff were present to log each boring and describe the soil samples in accordance with the Unified Soil Classification System (USCS).

Shelby tubes were collected from the DB embankment soils, and native soils at approximately 20 ft intervals from each of the sonic borings in accordance with ASTM D1587 [5]. The soil borings were advanced to depths of approximately 100 ft-bgs to within the uppermost aquifer and/or into the top of the underlying shale bedrock. Sonic drilling locations are provided in **Figure 2-1**. Boring logs are provided in **Appendix E**. Soil stratigraphy is discussed in Section 2.6.

2.5.3 Laboratory Testing

A suite of index testing and hydraulic conductivity testing was conducted on select soil samples. Fourteen soil samples were collected from six borings from depths between 5 ft-bgs and 90 ft-bgs for hydraulic conductivity testing to capture soft to very stiff soils. Details of hydraulic conductivity testing are provided in Section 3.

Index testing included:

- 24 Moisture Content tests (ASTM D2216)
- 4 Specific Gravity tests (ASTM D854)
- 22 Grain Size Mechanical Sieve tests (ASTM D6913)
- 21 Atterberg Limits tests (ASTM D4318)

Note that these tests are included in **Table 2-1**. Test results are provided in **Appendix H**.

2.6 Conceptual Site Model

An EVS model was developed for the site based on data collected during the field investigations from the 1970s, 2016, and 2020. The EVS model centralized all the data to develop a comprehensive conceptual site model. Based on the EVS model, the overall conceptual site model of the DB lithology is relatively consistent with low hydraulic conductivity clay-rich deposits with non-interconnected sand seams at greater depths. Within the DB footprint, the uppermost aquifer

unit sits directly above the bedrock and is relatively consistent at approximately 10 ft thick across the DB.

Specific to the DB, cross-sections (**Figures 2-2 through 2-5**) were created from the EVS model and analyzed to determine the various changes in lithology within the clay confining unit directly underlying the DB and the characteristics of the uppermost aquifer unit which sits directly on the bedrock. Upon review of the transects, the lithology beneath the DB consists of (from the ground surface downward) (1) clay, (2) clay with sand, (3) uppermost aquifer unit, and (4) shale bedrock. These units are consistent with historical reports and TRC's November 2020, Initial Application for Alternate Liner Demonstration [1]. There were some discrepancies, in that the second clay unit was described as silty instead of sandy. Based on CPT and geotechnical index testing during Geosyntec's 2020 ALD investigation, the lower clay was re-interpreted as "clay with sand" mainly due to the increased sand seams that were encountered. The clay within the "clay with sand" unit is relatively constant stiff gray clay. Therefore, the lithology directly underlying the DB consists of the following:

- (1) Clay – 35 to 40 ft thick directly beneath the DB. This unit consists of mainly soft to medium stiff clay and minimal sand seams. None of the sand seams are interconnected or considered an aquifer unit.
- (2) Clay with sand – This unit was encountered at approximately 35 to 40 ft bgs with a thickness of approximately 80 to 90 ft. This unit consists of stiffer gray clay with increasing sand seams. Although there are more frequent sand seams, most are less than 2 ft in thickness and have hydraulic conductivity values greater than $1.0E-7$ cm/s except for one location which is discussed in more detail below. The data supports that none of the sand seams are interconnected or considered an aquifer unit. Consequently, because the sands are isolated, the unit behaves like a low hydraulic conductivity clay unit.
- (3) Uppermost Aquifer Unit – This unit was encountered at approximately 115 to 130 ft bgs. The thickness of the unit is relatively consistent at 3- to 5-ft thick and directly sits atop the bedrock. This silty unit is saturated and considered the uppermost aquifer unit within the DB. There is a transition from the silty aquifer beneath the DB to a thicker sandy aquifer beneath the BABs located to the north/northwest of the DB. Both are considered the "uppermost aquifer unit" on the cross sections and within the EVS model.
- (4) Shale bedrock – This unit was encountered at approximately 100-130 ft bgs.

During Geosyntec's 2020 investigation, CPT tests were conducted and PPD tests were completed at CPT-08B, CPT-08C, CPT-11, CPT-12 and CPT-13B to estimate the hydraulic conductivity of the lithology. In addition, laboratory testing was conducted on individual grab samples from the three sonic borings around DB for long-term breakthrough potential and is further discussed in

Section 3. Based on the review of the PPD test data, values ranged between $7.97\text{E-}9$ cm/s and $1.63\text{E-}6$ cm/s around the DB. The CPT-derived highest hydraulic conductivity value of $1.63\text{E-}6$ cm/s was calculated at CPT-13B from a sand seam at 490 ft above mean sea level (AMSL) (approximately 100 ft bgs) within the (2) clay with sand unit. PPD tests at CPT-13 and CPT-12 located next to CPT-13B indicated hydraulic conductivities less than $1.0\text{E-}7$ cm/s. Therefore, the (1) clay and (2) clay with sand lithologies beneath the DB have adequate hydraulic conductivity values to be considered a low hydraulic conductivity unit and is consistent with TRC's 2018 Natural Clay Liner Equivalency Evaluation Report [1].

Below the clay with sand is the uppermost aquifer unit that mainly consists of silt. This unit directly overlies the Bedford shale. Beyond the DB, the EVS model predicts this unit extending to the BABs with increasing sands. The hydraulic head in the (3) uppermost aquifer unit associated with the DB is approximately 575 ft AMSL [1] with a gradient to the west-northwest.

The bottom of the DB is at an elevation of approximately 576 ft and the bottom of the clay underlying the DB is at an elevation of approximately 450 ft AMSL, thus more than 120 ft of low hydraulic conductivity clay-rich deposits ((1) clay and (2) clay with sand) separate the bottom of the DB from the underlying (3) uppermost aquifer unit.

3. POTENTIAL FOR INFILTRATION

The CCR Rule requires:

§257.71(d)(ii)(B) Potential for infiltration. A characterization of the potential for infiltration through any soil-based liner components and/or naturally occurring soil that control release and transport of leachate. All samples collected in the field for measurement of saturated hydraulic conductivity must be sent to a certified laboratory for analysis under controlled conditions and analyzed using recognized and generally accepted methodology. Facilities must document how the selected method is designed to simulate on-site conditions. The owner or operator must also provide documentation of the following as part of this line of evidence:

- (1) The location, number, depth, and spacing of samples relied upon is supported by the data collected in paragraph (d)(1)(ii)(A) of this section and is sufficient to capture the variability of saturated hydraulic conductivity for the soil-based liner components and/or naturally occurring soil;*
- (2) The liquid used to pre-hydrate the samples and measure long-term hydraulic conductivity reflects the pH and major ion composition of the CCR surface impoundment porewater;*
- (3) That samples intended to represent the hydraulic conductivity of naturally occurring soils (i.e., not mechanically compacted) are handled in a manner that will ensure the macrostructure of the soil is not disturbed during collection, transport, or analysis; and*
- (4) Any test for hydraulic conductivity relied upon includes, in addition to other relevant termination criteria specified by the method, criteria that equilibrium has been achieved between the inflow and outflow, within acceptable tolerance limits, for both electrical conductivity and pH.*

3.1 Site-Specific Soil and Porewater Details

3.1.1 Soil Samples for Hydraulic Conductivity Testing

Fourteen site-specific soil samples were collected for hydraulic conductivity testing. Considering the extent of existing field investigation data, including CPTs with PPDs and earlier borings, Geosyntec believes that the collected samples are sufficient to capture the variability of hydraulic conductivity in the natural soils present at the DB.

3.1.2 Site-Specific Porewater Testing and Results

Site-specific CCR porewater samples were collected from both the DB and the BABs for geochemical analyses to assess the representative composition of an “aggressive” solution for use in the hydraulic conductivity compatibility testing. Due to the high turbidity of basin waters, samples were filtered through a 0.45-micron filter to evaluate dissolved concentrations. Site-specific porewater samples were tested for CCR Rule Appendix III and Appendix IV parameters as well as additional major cations (sodium, magnesium, potassium), anions (total alkalinity), iron, and manganese.

All porewater samples were found to be slightly basic, with pH concentrations ranging from 7.87 to 9.01 SU. Total dissolved solids (TDS) concentrations of all three samples are similar, ranging from 200 to 300 milligrams per liter (mg/L). All three samples have TDS concentrations < 1000 mg/L, which is defined by the United States Geological Survey (USGS) as “freshwater”. The DB and BAB samples have similar major ion compositions, as illustrated on the Piper diagram in **Figure 3-1**. The anion composition is very similar for all three samples and consists of predominantly sulfate with some alkalinity and very little chloride. The cation composition is predominantly calcium and monovalent cations (potassium/sodium), with a smaller proportion of magnesium. The DB sample has a slightly higher relative percentage of calcium and lower monovalent cations compared to the BAB samples.

The analytical results are provided in **Appendix J** and tabulated in **Table 3-1**. Results were used to calculate total ionic strength for each sample. Total ionic strength is a measure of the combined ion concentrations in a solution and can represent the salinity of a sample. Total ionic strength was calculated for each sample using geochemical modeling software Geochemist’s Workbench (GWB) v12.0.4. The GWB thermodynamic dataset ‘thermo.com.V8.R6_.tdat’ was used for the calculations in order to incorporate all tested parameters. Analytical results for each parameter were input into GWB in units of mg/L and the ionic strength of each sample was calculated in units of molality (m).

Both BAB samples contained similar ionic strength values (0.0088 and 0.0080 m) compared to the slightly higher ionic strength of the DB sample (0.0106 m). Thus, the DB sample is considered to be the more aggressive solution and was used for compatibility testing as described in Section 3.2.

3.2 Hydraulic Conductivity Testing Procedure

Eight soil samples were tested for hydraulic conductivity, k , using deionized water in accordance with ASTM D5084 [6] to establish a baseline hydraulic conductivity. The other six samples were selected for compatibility testing in accordance with ASTM D7100 [7] using site-specific porewater. The use of ASTM D7100 is discussed in the preamble of the CCR Rule and deemed appropriate by USEPA.

ASTM D7100 termination criteria require the following conditions:

- The ratio of outflow to inflow is between 0.75 and 1.25.
- The hydraulic conductivity is steady, defined as four or more consecutive hydraulic conductivity measurements falling within $\pm 25\%$ of the mean value for hydraulic conductivity if the mean hydraulic conductivity is greater than or equal to $1.0\text{E-}8$ cm/s or within $\pm 50\%$ if the mean hydraulic conductivity is less than $1.0\text{E-}8$ cm/s, and a plot or tabulation of the hydraulic conductivity versus time shows no significant upward or downward trend;
- At least 2 pore volumes (PV) of flow has passed through the sample; and
- pH and electrical conductivity of effluent are within 10% of that for the influent with no significant increasing or decreasing trends.

3.3 Hydraulic Conductivity Test Results and Assessment

The final measured hydraulic conductivities based on ASTM D5084 for the samples range from $2.7\text{E-}9$ to $2.2\text{E-}8$ cm/s. **Table 3-2** presents a summary of the measured hydraulic conductivities for the samples and more details are provided in **Appendix H**.

Results for the hydraulic conductivity compatibility tests are provided in **Appendix K** with measurements through December 23, 2022 and summarized in **Table 3-3**. The table provides sample ID, the start date for testing, amount of PV passed through the sample, and hydraulic conductivity measurements.

A set of figures are included to present:

- PV passed with time;
- hydraulic conductivity with time;
- hydraulic conductivity versus PV passed;
- pH of inflow and outflow with time; and
- electrical conductivity (EC) of inflow and outflow with time.

These plots are provided in **Figures 3-2** through **3-31**.

The final measured hydraulic conductivities of samples range between $4.4\text{E-}9$ and $2.1\text{E-}8$ cm/s. The amount of PV that passed through the samples range from 2.8 to 10.5. All samples have passed

more than 2 PV to satisfy the termination criterion. The hydraulic conductivities generally remained steady with time and PV passed.

pH measurements are provided in **Table 3-4**. The average pH of inflow ranges from 8.2 to 8.4, and the average pH of outflow ranges from 8.2 to 8.4. The average pH of outflow are within 10 percent of the average pH of inflow.

EC measurements are provided in **Table 3-5**. The average EC of inflow ranges from 1,030 to 1,098, and the average EC of outflow ranges from 874 to 1,381. The EC measurements of outflow are within 10% of the EC measurements of inflow for sample B1-ST-1. The EC measurements of outflow were within 10% of the EC measurements of inflow for the other samples for at least one measurement; however, the outflow and inflow EC measurements are not within 10% as of December 2022.

Table 3-6 summarizes if the samples have reached the termination criteria for PV, hydraulic conductivity, pH, and EC in December 2022. As summarized in the table, all samples have reached the termination criteria for PV passed, hydraulic conductivity, and pH. One sample (B1-ST-1) has reached the termination criterion for EC, though the other samples satisfied this criterion at some point during testing. Overall, the average hydraulic conductivity measurements for the samples ($6.9\text{E-}9$ to $2.6\text{E-}8$ cm/s) have remained steady or slightly decreased from the average measurements ($8.2\text{E-}9$ to $2.2\text{E-}8$ cm/s) presented in the PALD [4]. Only the average hydraulic conductivity measured for sample B4-ST-3 ($1.8\text{E-}8$ to $2.6\text{E-}8$ cm/s) increased from the PALD [4].

The results do not present inflow versus outflow data. The project team decided to keep the inflow constant to provide a more stable hydraulic gradient across the sample, more accurate estimation of hydraulic conductivity, , faster testing, and more control in the testing procedure. It is Geosyntec's opinion that the inflow/outflow criterion was satisfied during the two years of testing because of the consistently low hydraulic conductivity results and constant hydraulic conductivity measurements (not significantly increasing or decreasing)..

4. FATE AND TRANSPORT MODEL ANALYSES

The CCR Rule requires:

§257.71(d)(ii) (C) Mathematical model to estimate the potential for releases. Owners or operators must incorporate the data collected for paragraphs (d)(1)(ii)(A) and (d)(1)(ii)(B) of this section into a mathematical model to calculate the potential groundwater concentrations that may result in downgradient wells as a result of the impoundment. Facilities must also, where available, incorporate the national-scale data on constituent concentrations and behavior provided by the existing risk record. Application of the model must account for the full range of site current and potential future conditions at and around the site to ensure that high-end groundwater concentrations have been effectively characterized. All the data and assumptions incorporated into the model must be documented and justified.

(1) The models relied upon in this paragraph (d)(1)(ii)(C) must be well- established and validated, with documentation that can be made available for public review.

(2) The owner or operator must use the models to demonstrate that, for each constituent in appendix IV of this part, there is no reasonable probability that the peak groundwater concentration that may result from releases to groundwater from the CCR surface impoundment throughout its active life will exceed the groundwater protection standard at the waste boundary.

(3) The demonstration must include the peak groundwater concentrations modeled for all constituents in appendix IV of this part attributed both to the impoundment in isolation and in addition to background.

4.1 Introduction

A fate and transport model analysis was performed to evaluate whether the peak groundwater concentrations that may result from releases to the groundwater from the DB exceeds the GWPS at the waste boundary throughout its active life.

The model considers flow of CCR porewater Constituents of Concern (COCs) migrating through the bottom of the DB down to the uppermost aquifer. The model does not consider additional migration of COCs horizontally to the waste boundary. If considered, the horizontal groundwater flux would reduce the concentrations of the COCs, thus, the model presents a conservative assessment.

According to §257.71(2)(ii)(C)(3), the owner must submit “...a final demonstration that updates only the finalized hydraulic conductivity data to confirm that the model results in the preliminary demonstration are accurate.” The hydraulic conductivity used in the calculation of the Darcy

velocity for the baseline fate and transport model corresponds to the geometric mean of all available data. For the PALD [4], a hydraulic conductivity of $2.15\text{E-}8$ cm/s was used for the baseline model. The recalculated geometric mean hydraulic conductivity based on the updated laboratory test results presented in Section 3.3 is approximately $2.14\text{E-}8$ cm/s, or a decrease of less than 1%. Furthermore, a sensitivity analysis was performed as part of the fate and transport analyses in the PALD [4] that captured this change in hydraulic conductivity data within the range of hydraulic conductivities evaluated. Therefore, the model results for the fate and transport analysis presented in the PALD [4] are considered accurate and not updated for this ALD. The following sections summarize the fate and transport analyses from the PALD for convenience.

As discussed in Section 4.6.1, the results of the model predict COC concentrations that are very low such that there is no reasonable probability that water from the DB will cause releases to the groundwater that will exceed the GWPS at the waste boundary over the projected active life of the DB.

4.2 Groundwater Protection Standards

Groundwater samples from TRC's 2016 and 2017 sampling events were tested for Appendix IV COCs and represent eight rounds of background groundwater data. The data were used to calculate site-specific background levels (background) for Appendix IV COCs. **Appendix L** provides the memorandum describing the statistical calculations.

To develop GWPS for the ALD, the federal Maximum Contaminant Level (MCL), Regional Screening Levels, and site-specific background were evaluated and the highest value was selected as the GWPS in accordance with the CCR Rule. Where MCL are not available Regional Screening Levels were used. GWPS are provided in **Table 4-1**.

4.3 Consideration of Background Groundwater Concentrations

The site-specific background has been considered and is a factor when determining if GWPS have been exceeded. At the DB, naturally occurring background concentrations are generally much lower than the GWPS. The predicted groundwater concentrations and the peak background concentrations are further discussed in Section 4.6.1.

4.4 CCR Porewater Quality Results

CCR porewater quality samples from the DB and the BABs were collected in December of 2020 and January of 2021. Samples were analyzed for Appendix III and IV parameters by ALS Environmental in Holland, MI. Analytical results were compared for each parameter and the highest CCR porewater concentration was used as the established concentration of the constituent (C_o) when calculating the predicted groundwater concentrations (PGC_i), as discussed further below. The CCR porewater quality data is summarized in **Table 4-2**.

In addition to the site-specific CCR porewater concentrations, 90th percentile concentrations from the 2014 EPA study [8] were considered in the analysis. This data is summarized in **Table 4-2**.

4.5 Fate and Transport Model

4.5.1 Analysis Model

A one-dimensional fate and transport model was designed to further understand the potential for contaminant transport from the DB to the uppermost aquifer. The model was developed with a contaminant transport process through the clay and clay with sand layers under the DB. Contaminant transport processes are discussed in Section 4.5.2.

The modeling program POLLUTE [9] was selected for the one-dimensional fate and transport evaluation. POLLUTE uses the input parameters to perform calculations for individual transport processes, and then uses the semi-analytical solution for the various transportation process (see Section 4.5.2) to yield predicted concentrations at the various specified times and distances.

Model setup and inputs are discussed in detail in the following sections and are summarized by layer in **Figure 4-1**.

4.5.2 Proposed Mathematical and Associated Computer Model

4.5.2.1 *Mathematical Model*

The potential transport mechanisms that may occur at the DB for the various modeled layers include advection, mechanical dispersion and diffusion. For porous media, these transport mechanisms can be represented by the following one-dimensional flow equation [10]:

$$\textbf{Equation No. 1:} \quad n \frac{\delta c}{\delta t} = nD \frac{\delta^2 c}{\delta z^2} - V_{\alpha} \frac{\delta c}{\delta z} - \rho K_d \frac{\delta c}{\delta t} - n\lambda c$$

Where:

c = concentration at any point

D = coefficient of hydrodynamic dispersion in the vertical direction

n = porosity of the geologic layer

K_d = distribution coefficient

V_α = Darcy velocity in the vertical direction

ρ = dry density of soil

λ = decay constant of the contaminant species

t = time

POLLUTE utilizes the transport phenomena as governed by Equation No. 1.

4.5.2.2 *Predicted Groundwater Concentrations*

This model uses an initial concentration value of one (1), which represents a unit concentration of any constituent in the CCR porewater. The results from the model can thus be used as a prediction factor for estimating the future concentration of any constituent of concern in groundwater. Multiplying the output prediction factor by the initial CCR porewater concentration provides the predicted groundwater concentration at the end of the model run. The following equation (Equation No. 2) illustrates this concept:

$$\text{Equation No. 2: } \text{PGC}_t = \text{PF}_t * C_o$$

Where:

PGC_t = predicted groundwater concentration after t years.

PF_t = prediction factored after t years, which is the output of the model.

C_o = established CCR porewater concentration of the constituent of concern.

4.5.3 Fate and Transport Model Inputs

4.5.3.1 *Initial CCR Porewater or Source Concentration*

The initial CCR porewater concentration input value used was unity (1). This value is unitless because it represents unit CCR porewater concentration of any given constituent. Therefore, the model results represent a fraction of the initial CCR porewater concentration for any constituent.

4.5.3.2 *Number of Layers and Layer Thickness*

Two layers were modeled at the site: the clay layer and the clay with sand layer. At the DB, the clay layer has an average thickness of 36 ft; the clay with sand layer has an average thickness of 84 ft. The average thickness of each layer was derived from an isopach map generated by subtracting the surface representing the bottom of the layer from the surface representing the top of the layer and averaging the difference over the footprint of the DB. Model documentation for the average thickness of each layer can be found in **Appendix M**.

POLLUTE also allows layers to be subdivided into sublayers, which allows the predicted concentration distribution within a layer to be calculated. The clay layer was divided into 20 sublayers at the DB. The clay with sand layer was divided into 50 sublayers at the DB.

4.5.3.3 *Modeling Period*

The model was run for the operating period of 55 years. This modeling period captures the amount of time elapsed from the 1980s, when operations started at the DB, to 2034, which is the end of the projected active life of the DB.

4.5.3.4 *Talbot Parameters*

POLLUTE uses a Laplace transform to find the solution to the advection-dispersion equation. The numerical inversion of the Laplace transform depends on the Talbot parameters. The model provides default values for the parameters, or they can be selected by the user. The default Talbot parameters were used in this demonstration [11].

4.5.3.5 *Boundary Conditions*

POLLUTE allows the user to select between multiple upper and lower boundary conditions. The top boundary condition typically represents the bottom of the CCR unit as a potential source. The top boundary can be specified as either zero flux, constant concentration, or finite mass. A constant concentration was assumed as it provides conservative model results because it assumes that the leachate quality will remain constant at the maximum measured values over time.

The lower boundary can be specified as either zero flux, constant concentration, fixed outflow, or infinite thickness. For this model, an infinite thickness lower boundary was used. Therefore, the model output is a prediction factor of contaminant concentration in groundwater at the interface between the clay with sand layer and the underlying uppermost aquifer.

4.5.3.6 *Darcy Vertical Velocity*

POLLUTE requires a Darcy velocity to be input for the model as a whole. The Darcy velocity was calculated for the DB using a vertical gradient and the vertical hydraulic conductivity of the clay with sand layer. For the DB, the vertical gradient was calculated using hydrogeologic data from the uppermost aquifer and the elevation of the typical operation water level within the DB. These parameters were chosen to produce a conservative value for the Darcy velocity. A Darcy velocity value of $2.03\text{E-}4$ m/year was calculated for the DB as provided in **Appendix M**. The hydraulic conductivity value used for the calculation of Darcy velocity is the average (geometric mean) of historical and current lab testing for the vertical hydraulic conductivity data.

4.5.3.7 *Hydrodynamic Dispersion Coefficient*

The vertical coefficient of hydrodynamic dispersion is a required input for each layer within the POLLUTE model. The hydrodynamic dispersion coefficient is calculated using Equation No. 3:

$$\text{Equation No. 3: } D = D^* + av$$

Where:

D = the hydrodynamic dispersion coefficient (m²/year);

D* = the effective diffusion coefficient (m²/year).

a = the dispersivity (m);

v = the groundwater seepage velocity (m/year).

For this demonstration, a coefficient of hydrodynamic dispersion value (D) of 0.19 m²/year was input into the model. This value was based on the effective diffusion coefficient (D*) for chloride 0.19 m²/year, as calculated by Rowe et al. [12]. The coefficient of chloride was chosen as it is considered to have a high capacity for diffusion compared to other constituents of interest. Therefore, it is a conservative constituent to model among the COCs.

The second part of Equation 3, the product of dispersivity and groundwater seepage velocity, is related to dispersion. Rowe et al. [12] discusses when the seepage velocity (2.03E-4 m/year) is low (i.e., clay soils), diffusion will control the hydrodynamic dispersion (D) and dispersion is negligible.

4.5.3.8 *Effective Porosity and Density Input*

The average porosity of each model layer was estimated using laboratory data as discussed in Section 2. The model shows good agreement between porosity values and geologic layers, with the overlying clay unit having lower porosities than the underlying clay with sand unit. An average of 51 percent porosity was used for the clay layer, while an average of 63 percent porosity was used for the clay with sand layer.

Based on empirical data provided by Sara [13], the laboratory porosity data was converted to effective porosities. Effective porosity values of 0.41 and 0.51 were used for the clay and clay with sand layers, respectively.

Density values from laboratory testing were also used to determine a suitable model input. The average density of 1,500 kg/m³ (94.2 pcf) was estimated from the available data. This value was used in the POLLUTE model.

4.5.3.9 *Adsorption Coefficient and Degradation*

Adsorption and degradation of constituents can play a significant role in the impedance of contaminant migration in the subsurface. Within POLLUTE, the adsorption coefficient simulates the impedance of constituents or sorption of contaminants in the modeled layers, while degradation simulates the breakdown of contaminants over time. In this model, adsorption and degradation are assumed to be zero, which provides a more conservative model result.

4.6 Fate and Transport Analysis Results and Evaluation

4.6.1 Fate and Transport Baseline Model Results

The modeling was performed to evaluate predicted groundwater quality based on the hydrogeology of the site. At the DB, the baseline model calculated a PF_t of 6.35E-40. With both the C_o and PF_t established, the PGC_t (i.e., predicted concentration) was calculated and compared to the established GWPS for the DB. As provided in **Table 4-3**, the predicted groundwater quality results are below the GWPS levels. In addition, the predicted concentrations were added to the highest concentrations that were measured in the 2016-2017 groundwater sampling events and compared to the GWPS. The combined results from predicted concentrations and the highest measured concentrations are below the GWPS (see **Table 4-3**). Therefore, no impacts to groundwater above GWPS are predicted over the duration of the active life of the DB.

The driving mechanism for the transport is chemical diffusion, because the advective flow would take more than a thousand years for a water molecule to travel from the bottom of the DB to the uppermost aquifer. **Appendix M** provides calculations for the time of travel.

The baseline model outputs for the DB are included in **Appendix N**.

4.6.2 Sensitivity Analysis

Many of the model inputs are specific to the site. Given the potential for sampling bias, uncertainty, and natural variation, a sensitivity analysis was conducted to evaluate the impact on the variation of the model inputs. The analysis focused on changes to the model output, or PF_t , given a variation to a single model input as discussed in the following sections. A summary of the sensitivity analyses model input values is provided in **Table 4-4**.

The resulting PF_t from each sensitivity analysis was compared to a threshold prediction value, $PF_{\text{threshold}}$. The $PF_{\text{threshold}}$ value represents the PF_t at which impacts to groundwater are predicted for Appendix IV COCs at the top of the uppermost aquifer under the DB. $PF_{\text{threshold}}$ is calculated using Equation 4:

$$\text{Equation No. 4: } PF_{\text{threshold}} = \min \left\{ \frac{GWPS_1}{C_1}, \frac{GWPS_2}{C_2}, \dots, \frac{GWPS_i}{C_i}, \dots, \frac{GWPS_n}{C_n} \right\}$$

Where:

$PF_{\text{threshold}}$ = threshold prediction factor

$GWPS_i$ = groundwater protection standard for constituent ‘i’

C_i = maximum porewater concentration of the COC ‘i’

4.6.2.1 *Darcy Velocity*

A sensitivity analysis was completed to evaluate the impact of Darcy velocity. A Darcy velocity of 4.07E-4 m/year was selected as the value to use for this analysis. This value is double the baseline value calculated during this demonstration and thus serves as a suitable value for input to the sensitivity analysis.

4.6.2.2 *Coefficient of Hydrodynamic Dispersion*

Model sensitivity to the coefficient of hydrodynamic dispersion was evaluated by increasing and decreasing the input value by 25%. The initial input value was derived from laboratory testing [12], and thus a 25% increase and decrease is considered a satisfactory variation for the purposes of a sensitivity analysis.

4.6.2.3 *Porosity and Effective Porosity*

Model sensitivity to the porosity and effective porosity was evaluated by increasing and decreasing the input value by the minimum and maximum range of values calculated from the laboratory results.

4.6.2.4 *Layer Thickness*

The isopach maps (**Appendix M**) were used to calculate the maximum and minimum thickness for the clay and clay with sand layers. Using those values as inputs, four additional models were run for the DB to evaluate model sensitivities to layer thickness. In each model only one variable was changed.

4.6.2.5 *Modeling Period*

The modeling period used was 55 years (the “baseline”). To further evaluate the impact of modeling runtime on the resultant PF_t , one model was run with a modeling period of 85 years, to capture the post-closure care period.

4.6.2.6 *Sensitivity Results*

Additional fate and transport model runs were completed to evaluate model sensitivities to changing model inputs. As shown in **Table 4-5**, using more conservative model input parameters resulted in PF_t values ranging from 5.19E-47 to 1.14E-32. This demonstrates that the DB will not impact groundwater quality assuming conditions more conservative than the baseline scenario. The sensitivity modeling results are presented in **Table 4-5** whereas the model outputs are included in **Appendix N**.

4.6.3 Reliability of Computer Model

The computer-based fate and transport model used for this analysis is based on rigorous and proven analytical solutions to the advection-dispersion equation for layered deposits. These equations were derived with the intent of modeling the physical and chemical transport of contaminants from waste impoundments. Widespread use, comprehensive documentation, and abundant publications ([10], [14], [11], [15], [16]) demonstrate the versatility of this modeling approach for assessing groundwater impacts. The outputs obtained from models conducted in POLLUTE can be compared to those obtained using other approaches to solving the advection-dispersion equation.

4.6.4 Degree of Conservativeness in Model Results

Input parameters for the baseline models were based on site-specific data whenever possible. When not possible, input values were derived from an understanding of the site and relevant peer-reviewed literature. If a high degree of uncertainty was present, conservative input values were selected. A summary of the various conservative assumptions are listed below:

- The maximum measured CCR porewater concentration for each constituent was used for the fate and transport model prediction table;
- Constant CCR porewater concentration or a constant mass was used for the entire modeling period. A specific mass could have been assumed for modeling purposes which would have resulted in decreased CCR porewater concentrations over time, but to be conservative the model considered constant CCR porewater concentration over time;
- Adsorption can significantly reduce the concentrations of metal constituents as they move through soils, especially clays which would retard or slow down the migration. To be conservative, the model assumes no adsorption would occur over time;
- Degradation of concentrations (input values) through either the biologic or chemical process was assumed not to occur during the modeling period. By assuming no degradation, the model overestimates the predicted groundwater quality over time; and

- The CCR Rule requires compliance at the waste boundary. The analysis only considers vertical flow from the bottom of the DB to the top of the uppermost aquifer; the analysis does not consider a horizontal flow towards the waste boundary, which would further lower the predicted concentration levels for COCs.

5. SUMMARY

This ALD has been prepared to assess if the DB meets the ALD requirements per the CCR Rule. The data included comprehensive field and laboratory investigation data collected from the 1970s to 2020. The 2020 field and laboratory investigation studies were conducted specifically to fill data gaps and to address the CCR Rule requirements. The data were incorporated into an EVS model to create a comprehensive conceptual site model to understand the lithology beneath the DB and as a basis for the fate and transport analysis. The EVS model was relatively consistent with historical representations of the geology associated with the DB.

Site-specific water was collected from the DB and BABs and tested to assess which one of the CCR units had the more aggressive water. Water from DB was deemed to be more aggressive and used for compatibility testing to estimate the impacts on hydraulic conductivity of site-specific soil samples. The results of the testing program are presented in this ALD. .

A comprehensive subsurface stratigraphy model was created using the available data set incorporated into the conceptual site model. Fate and transport analyses were conducted to assess whether there is a reasonable probability that water from the DB may result in a release to the groundwater during its active life that would exceed the GWPS at the waste boundary. The baseline fate and transport analysis was conducted using the available site-specific data and an operating period of 55 years, which captures the period from the 1980s, when operations started at the DB, to 2034, which is the end of the projected active life of the DB.

The analysis considered different contaminant transport mechanisms including, advection, dispersion, and diffusion. The analysis indicates that advective flow would take more than a thousand years for a water molecule to travel from the bottom of the DB to the uppermost aquifer. Therefore, the analysis results indicate that, due to the low hydraulic conductivity of the in-situ soils, chemical diffusion is the dominant transport mechanism compared to advection or seepage velocity. Consequently, the hydraulic conductivity testing described in Section 3 is sufficient to characterize hydraulic conductivity and demonstrate the performance of the alternate liner system as it relates to advection or seepage flow.

A sensitivity analysis was performed as part of additional fate and transport analyses to account for sampling bias, uncertainty, and natural variation in site-specific inputs. Predicted groundwater concentrations for both the baseline and sensitivity analyses are below GWPS. The sensitivity analyses results show that there is no reasonable probability that water from the DB will result in a release to the groundwater that would exceed the GWPS at the waste boundary over the projected active life of the DB.

7. REFERENCES

- [1] TRC, "Initial Application for an Alternative Liner Demonstration - Belle River Power Plant, Diversion Basin Coal Combustion Residuals Unit," November 2020.
- [2] Geosyntec Consultants and Excel Geotechnical Testing, "Extension Request for Belle River Power Plant Diversion Basin Alternative Liner Demonstration," September 2021.
- [3] Geosyntec Consultants and Excel Geotechnical Testing, "Extension Request for Belle River Power Plant Diversion Basin Alternative Liner Demonstration," September 2022.
- [4] Geosyntec Consultants, "Preliminary Alternative Liner Demonstration Diversion Basin, Belle River Power Plant, East China Township, MI," 2021.
- [5] American Society for Testing and Materials, "Standard Practice for Thin-walled Tube Sampling for Fine-grained Soils," ASTM D1587, 2015.
- [6] American Society for Testing and Materials, "Standard Test Methods for Measurement of Hydraulic Conductivity of Saturated Porous Materials Using a Flexible Wall Permeameter," ASTM D5084, 2016.
- [7] American Society for Testing and Materials, "Standard Test Method for Hydraulic Conductivity Compatibility Testing of Soils with Aqueous Solutions," ASTM D7100, 2020.
- [8] United States Environmental Protection Agency, "Human and Ecological Risk Assessment of Coal Combustion Residuals," Regulation Identifier Number: 2050-AE81, 2014.
- [9] R. K. Rowe, J. R. Booker and M. J. Fraser, "POLLUTEv7.13," GAEA Technologies, Ltd., Windsor, Ontario, Canada, 2007.
- [10] R. K. Rowe, "Contaminant Migrating Through Groundwater: The Role of Analysis in The Design of Barriers," *Canadian Geotechnical Journal*, vol. 25, no. 4, pp. 778-798, 1988.
- [11] A. Talbot, "The Accurate Numerical Integration of Laplace Transforms," *Journal of Applied Mathematics*, vol. 23, no. 1, pp. 97-120, 1979.
- [12] R. K. Rowe, R. M. Quigley, R. W. I. Brachman and J. R. Booker, "Clayey Barrier Systems for Waste Disposal Facilities," London, England, 2004.

- [13] M. N. Sara, *Standard Handbook for Solid and Hazardous Waste Facility Assessments*, Chelsea, MI: Lewis Publishers, 1993.
- [14] R. K. Rowe, "Pollutant Transport Through Barriers," *Proceedings of ASCE Specialty Conference, Geotechnical Practice for Waste Disposal*, pp. 159-181, Ann Arbor, MI, June 1987.
- [15] R. K. Rowe and J. R. Booker, "An Efficient Analysis of Pollutant Migration Through Soil," in *Numerical Methods for Transient and Coupled Systems*, Lewis, Hinton, Bettess and Schrefler, Eds., New York, NY: John Wiley & Sons Ltd., 1987, pp. 13-42.
- [16] R. K. Rowe and J. R. Booker, "Contaminant Migration Through a Liner Underlain by Fractured Till and an Aquifer," *Geotechnical Research Center Report GEOT-12-89*; Faculty of Engineering Science, University of Western Ontario, 1989.

TABLES

Table 2-1 – Field and Laboratory Testing Summary

Test	Current ASTM	Number Used in Characterization
Pocket Penetrometer	WK27337	194
Slug Test	D4044	4
Grain Size Distribution	D6913	43
Atterberg Limits	D4318	72
Water Content	D2216	96
Unit Weight	D7263	64
Specific Gravity	D854	10
Hydraulic Conductivity	D5084/D7100	19/6
Cone Penetration Test	D3441	16

Table 2-2 – Pore Pressure Dissipation Tests Results

CPT ID	Lithology Unit	Hydraulic Conductivity (cm/s)
CPT-01B	Clay	1.80E-8
CPT-01B	Clay	3.61E-8
CPT-01B	Seam 2	8.54E-8
CPT-01B	Seam2	5.78E-7
CPT-01B	Seam 3	2.05E-8
CPT-01B	Seam 4	2.57E-8
CPT-03	Clay	9.76E-9
CPT-03	Clay	2.48E-8
CPT-03	Clay with Sand	3.14E-8
CPT-03	Clay with Sand	1.97E-8
CPT-03	Seam 3	2.81E-6
CPT-03	Seam 3	5.19E-7
CPT-03	Clay with Sand	2.96E-8
CPT-06B	Clay	3.33E-8
CPT-06B	Clay with Sand	1.96E-8
CPT-06B	Clay with Sand	2.34E-8
CPT-08B	Clay	1.91E-8
CPT-08B	Clay 2	3.35E-8
CPT-08C	Seam 2	2.97E-8
CPT-08C	Clay with Sand 2	8.03E-8
CPT-08C	Clay with Sand 2	2.97E-8
CPT-11	Clay	1.97E-8
CPT-11	Clay	2.64E-8
CPT-11	Clay with Sand 2	4.68E-8
CPT-11	Clay with Sand 4	3.86E-8
CPT-11	Clay with Sand 4	2.76E-8
CPT-12	Clay	7.97E-9
CPT-13B	Seam 3	1.63E-6

Table 3-1 – Chemistry Results of Site-Specific Filtered CCR Porewater

Sample ID	Unit	Bottom Ash Basin - North	Bottom Ash Basin - South	Diversion Basin
Alkalinity, Total (as CaCO ₃)	mg/L	88	60	100
Antimony	mg/L	0.01 U	0.01 U	0.01 U
Arsenic	mg/L	0.0085	0.007	0.0093
Barium	mg/L	0.94	0.58	0.59
Beryllium	mg/L	0.004	0.00216	0.004
Boron	mg/L	0.38	0.83	1.29
Cadmium	mg/L	0.004 U	0.004 U	0.004 U
Calcium	mg/L	83	54	80
Chloride	mg/L	9.0	9.6	14
Chromium	mg/L	0.0087	0.0049	0.01
Cobalt	mg/L	0.01	0.00554	0.0052
Fluoride	mg/L	0.26	0.52	0.31
Iron	mg/L	0.16	1.05	0.34

Sample ID	Unit	Bottom Ash Basin - North	Bottom Ash Basin - South	Diversion Basin
Lead	mg/L	0.006	0.0061	0.01
Lithium	mg/L	0.034	0.0174	0.031
Magnesium	mg/L	15.9	13.8	17.5
Manganese	mg/L	0.01	0.0145	0.0137
Mercury	mg/L	0.0004 U	0.0004 U	0.0004 U
Molybdenum	mg/L	0.035	0.046	0.058
pH	SU	7.87	8.71	9.01
Potassium	mg/L	5.9	7.5	7.6
Selenium	mg/L	0.00582	0.0057	0.0061
Sodium	mg/L	55	86	115
Sulfate	mg/L	100	110	130
Thallium	mg/L	0.01	0.00117	0.00516
Total Dissolved Solids	mg/L	200	220	300
Ionic Strength	molal (m)	0.0088	0.0080	0.0106

Notes:U – Analyzed but not detected above the method detection limit. The method detection limit is shown.

Table 3-2 – Summary of Hydraulic Conductivity Tests Results [6]

ID	Date	Hydraulic Conductivity (cm/s)
B1-ST-3 (36-38')	January 26, 2021	2.7E-9
B2-ST-2 (7-9')	January 26, 2021	2.0E-8
B2-ST-7 (97-99')	February 15, 2021	2.2E-8
B3-ST-1 (1-3')	February 8, 2021	9.6E-9
B4-ST-4 (67-69')	February 15, 2021	1.8E-8
B5-ST-2 (27-29')	February 15, 2021	2.1E-8
B6-ST-4 (47-49')	February 17, 2021	1.8E-8
B6-ST-7 (97-99')	February 17, 2021	1.2E-8

Table 3-3 – Summary of Compatibility Tests [7] - Hydraulic Conductivity and Pore Volumes Passed Results

ID	Date	Days After Injection	Hydraulic Conductivity (cm/s)	Pore Volumes Passed After Injection
B1-ST-1 (7-9')	March 15, 2021	0	1.2E-8	0
	December 23, 2022	648	4.4E-9	2.84
B2-ST-1 (1-3')	March 15, 2021	0	1.8E-8	0
	December 23, 2022	648	8.8E-9	5.21
B2-ST-4 (47-49')	March 15, 2021	0	2.4E-8	0
	December 23, 2022	648	1.8E-8	7.94
B3-ST-5 (77-79')	March 15, 2021	0	2.2E-8	0
	December 23, 2022	648	1.5E-8	10.55
B4-ST-3 (47-49')	March 15, 2021	0	2.7E-8	0
	December 23, 2022	648	2.1E-8	9.89
B5-ST-5 (87-89')	March 15, 2021	0	1.7E-8	0
	December 23, 2022	648	1.0E-8	8.36

Table 3-4 – Summary of Compatibility Tests [7] - pH Results

Sample ID	Parameter	pH Inflow	pH Outflow
B1-ST-1 (7-9')	Min	7.8	8.1
	Max	9.1	9.1
	Average	8.4	8.4
B2-ST-1 (1-3')	Min	7.8	7.9
	Max	8.9	9.1
	Average	8.3	8.3
B2-ST-4 (47-49')	Min	7.7	7.8
	Max	9.4	9.0
	Average	8.3	8.3
B3-ST-5 (77-79')	Min	7.5	7.6
	Max	9.1	8.9
	Average	8.3	8.2
B4-ST-3 (47-49')	Min	7.7	7.8
	Max	9.0	8.8
	Average	8.2	8.2
B5-ST-5 (87-89')	Min	7.6	7.7
	Max	8.9	9.2
	Average	8.3	8.2

Table 3-5 – Summary of Compatibility Tests [7] - Electrical Conductivity Results

Sample ID	Parameter	EC Inflow ($\mu\text{s}/\text{cm}$)	EC Outflow ($\mu\text{s}/\text{cm}$)
B1-ST-1 (7-9')	Min	622	1141
	Max	1315	1614
	Average	1094	1280
B2-ST-1 (1-3')	Min	560	856
	Max	1345	3050
	Average	1081	1381
B2-ST-4 (47-49')	Min	523	720
	Max	1312	2090
	Average	1070	1035
B3-ST-5 (77-79')	Min	579	672
	Max	1397	1133
	Average	1098	879
B4-ST-3 (47-49')	Min	518	632
	Max	1283	1637
	Average	1033	874
B5-ST-5 (87-89')	Min	555	655
	Max	1291	2010
	Average	1070	931

Table 3-6 – Summary of Compatibility Tests [7] - Termination Criteria

Sample ID	Termination Criterion Reached (as of December 23, 2022)			
	Pore Volumes Passed	Steady Hydraulic Conductivity	pH	Electrical Conductivity
B1-ST-1 (7-9')	Yes	Yes	Yes	Yes
B2-ST-1 (1-3')	Yes	Yes	Yes	No
B2-ST-4 (47-49')	Yes	Yes	Yes	No
B3-ST-5 (77-79')	Yes	Yes	Yes	No
B4-ST-3 (47-49')	Yes	Yes	Yes	No
B5-ST-5 (87-89')	Yes	Yes	Yes	No

Table 4-1 – Groundwater Protection Standards

Constituent	Unit	GWPS Selection	MCL/RSL	MW-16-05		MW-16-06		MW-16-07		MW-16-08		MW-16-10		MW-16-11/A	
				UTL	GWPS	UTL	GWPS	UTL	GWPS	UTL	GWPS	UTL	GWPS	UTL	GWPS
Antimony	mg/L	MCL	6.0E-03	2.0E-03	6.0E-03	2.0E-03	6.0E-03	2.0E-03	6.0E-03	2.1E-03	6.0E-03	2.1E-03	6.0E-03	3.2E-03	6.0E-03
Arsenic	mg/L	Background or MCL	1.0E-02	1.4E-02	1.4E-02	7.5E-03	1.0E-02	1.9E-02	1.9E-02	3.0E-02	3.0E-02	1.1E-02	1.1E-02	2.4E-02	2.4E-02
Barium	mg/L	MCL	2.0E+00	3.7E-01	2.0E+00	3.3E-01	2.0E+00	5.0E-01	2.0E+00	4.9E-01	2.0E+00	2.0E-01	2.0E+00	6.2E-01	2.0E+00
Beryllium	mg/L	MCL	4.0E-03	1.0E-03	4.0E-03	1.0E-03	4.0E-03	1.7E-03	4.0E-03	1.6E-03	4.0E-03	1.0E-03	4.0E-03	1.6E-03	4.0E-03
Cadmium	mg/L	MCL	5.0E-03	1.0E-03	5.0E-03	1.0E-03	5.0E-03	1.3E-03	5.0E-03	1.5E-03	5.0E-03	1.0E-03	5.0E-03	1.0E-03	5.0E-03
Chromium	mg/L	MCL	1.0E-01	4.7E-02	1.0E-01	1.4E-02	1.0E-01	2.7E-02	1.0E-01	5.5E-02	1.0E-01	3.2E-02	1.0E-01	1.8E-02	1.0E-01
Cobalt	mg/L	Background or RSL	6.0E-03	2.1E-02	2.1E-02	4.7E-03	6.0E-03	1.3E-02	1.3E-02	2.2E-02	2.2E-02	1.7E-02	1.7E-02	7.1E-03	7.1E-03
Fluoride	mg/L	MCL	4.0E+00	1.3E+00	4.0E+00	1.3E+00	4.0E+00	1.2E+00	4.0E+00	1.3E+00	4.0E+00	2.1E+00	4.0E+00	1.9E+00	4.0E+00
Lead	mg/L	Background or RSL	1.5E-02	2.3E-02	2.3E-02	4.4E-03	1.5E-02	1.2E-02	1.5E-02	2.2E-02	2.2E-02	3.5E-02	3.5E-02	7.7E-03	1.5E-02
Lithium	mg/L	Background	4.0E-02	6.7E-02	6.7E-02	5.5E-02	5.5E-02	9.2E-02	9.2E-02	1.1E-01	1.1E-01	1.2E-01	1.2E-01	1.5E-01	1.5E-01
Mercury	mg/L	MCL	2.0E-03	2.0E-04	2.0E-03	2.0E-04	2.0E-03	2.0E-04	2.0E-03	2.0E-04	2.0E-03	2.0E-04	2.0E-03	2.0E-04	2.0E-03
Molybdenum	mg/L	RSL	1.0E-01	4.3E-02	1.0E-01	3.0E-02	1.0E-01	1.0E-01	1.0E-01	6.7E-02	1.0E-01	5.0E-02	1.0E-01	4.9E-02	1.0E-01
Radium-226/228	pCi/L	Background or MCL	5.0E+00	5.5E+00	5.5E+00	2.6E+00	5.0E+00	5.8E+00	5.8E+00	7.6E+00	7.6E+00	3.2E+00	5.0E+00	2.6E+00	5.0E+00
Selenium	mg/L	MCL	5.0E-02	5.0E-03	5.0E-02	5.0E-03	5.0E-02	5.3E-03	5.0E-02	5.0E-03	5.0E-02	5.0E-03	5.0E-02	5.0E-03	5.0E-02
Thallium	mg/L	Background or MCL	2.0E-03	1.1E-03	2.0E-03	1.0E-03	2.0E-03	2.3E-03	2.3E-03	1.3E-03	2.0E-03	1.0E-03	2.0E-03	1.0E-03	2.0E-03

Notes:

MCL - Maximum Contaminant Level, EPA Drinking Water Standards and Health Advisories, April 2012.

RSL - Regional Screening Level from 83 FR 36435.

UTL - Upper Tolerance Limit (95%) of the background data set.

GWPS - Groundwater Protection Standard. Appendix IV GWPS is the higher of the MCL/RSL and UTL.

mg/L = milligrams per liter

pCi/L = picocuries per liter

Table 4-2 – Baseline Fate and Transport Results

	Constituent	Units	Maximum Observed Concentration	90th Percentile Concentration	Prediction Factor	Predicted Groundwater Quality		Most Conservative GWPS	Outcome - Site (Pass/Fail)	Outcome - 90th Percentile
						DB	90th Percentile			
Appendix IV	Antimony	mg/L	1.0E-02	4.0E-02	6.69E-40	6.69E-42	2.68E-41	6.0E-03	PASS	PASS
	Arsenic	mg/L	9.3E-03	7.8E-01	6.69E-40	6.22E-42	5.22E-40	1.0E-02	PASS	PASS
	Barium	mg/L	5.9E-01	2.1E-01	6.69E-40	3.95E-40	1.40E-40	2.0E+00	PASS	PASS
	Beryllium	mg/L	4.0E-03	1.0E-03	6.69E-40	2.68E-42	6.69E-43	4.0E-03	PASS	PASS
	Cadmium	mg/L	4.0E-03	6.0E-02	6.69E-40	2.68E-42	4.01E-41	5.0E-03	PASS	PASS
	Chromium	mg/L	1.0E-02	2.0E-01	6.69E-40	6.69E-42	1.34E-40	1.0E-01	PASS	PASS
	Cobalt	mg/L	5.2E-03	5.0E-02	6.69E-40	3.48E-42	3.35E-41	6.0E-03	PASS	PASS
	Fluoride	mg/L	4.4E-01	2.1E+01	6.69E-40	2.94E-40	1.42E-38	4.0E+00	PASS	PASS
	Lead	mg/L	1.0E-02	1.0E-01	6.69E-40	6.69E-42	6.69E-41	1.5E-02	PASS	PASS
	Lithium	mg/L	6.1E-02	4.5E-01	6.69E-40	4.08E-41	3.01E-40	4.0E-02	PASS	PASS
	Mercury	mg/L	4.0E-04	7.0E-06	6.69E-40	2.68E-43	4.68E-45	2.0E-03	PASS	PASS
	Molybdenum	mg/L	3.0E-01	7.1E+00	6.69E-40	2.01E-40	4.75E-39	1.0E-01	PASS	PASS
	Combined Radium	pCi/L	1.8E+00	-	6.69E-40	1.20E-39	-	5.0E+00	PASS	NA
	Selenium	mg/L	8.7E-03	3.2E-01	6.69E-40	5.82E-42	2.14E-40	5.0E-02	PASS	PASS
Thallium	mg/L	5.2E-03	3.0E-03	6.69E-40	3.45E-42	2.01E-42	2.0E-03	PASS	PASS	

Notes:

MCL - Maximum Contaminant Level, EPA Drinking Water Standards and Health Advisories, April 2012.

RSL - Regional Screening Level from 83 FR 36435.

UTL - Upper Tolerance Limit (95%) of the background data set.

GWPS - Groundwater Protection Standard. Appendix IV GWPS is the higher of the MCL/RSL and UTL.

mg/L = milligrams per liter

pCi/L = picocuries per liter

**Table 4-3
Background and Maximum Predicted Concentrations Compared to GWPS**

Constituent	Unit	GWPS Selection	MW-16-05				
			Data				
			Maximum Observed Concentration (A)	Maximum Predicted Concentration (B)	Combined Concentration (A+B)	GWPS	Pass/Fail
Antimony	mg/L	MCL	2.0E-03	6.7E-42	2.0E-03	6.0E-03	Pass
Arsenic	mg/L	Background	1.4E-02	6.2E-42	1.4E-02	1.4E-02	Pass
Barium	mg/L	MCL	3.4E-01	3.9E-40	3.4E-01	2.0	Pass
Beryllium	mg/L	MCL	1.0E-03	2.7E-42	1.0E-03	4.0E-03	Pass
Cadmium	mg/L	MCL	1.0E-03	2.7E-42	1.0E-03	5.0E-03	Pass
Chromium	mg/L	MCL	2.4E-02	6.7E-42	2.4E-02	1.0E-01	Pass
Cobalt	mg/L	Background	1.0E-02	3.5E-42	1.0E-02	2.1E-02	Pass
Fluoride	mg/L	MCL	1.3	2.9E-40	1.3	4.0	Pass
Lead	mg/L	Background	1.1E-02	6.7E-42	1.1E-02	2.3E-02	Pass
Lithium	mg/L	Background	6.2E-02	4.1E-41	6.2E-02	6.7E-02	Pass
Mercury	mg/L	MCL	2.0E-04	2.7E-43	2.0E-04	2.0E-03	Pass
Molybdenum	mg/L	RSL	4.3E-02	2.0E-40	4.3E-02	1.0E-01	Pass
Radium-226/228	pCi/L	Background	4.0E-03	1.2E-39	4.0E-03	5.E-03	Pass
Selenium	mg/L	MCL	5.0E-03	5.8E-42	5.0E-03	5.0E-02	Pass
Thallium	mg/L	MCL	1.0E-03	3.5E-42	1.0E-03	2.0E-03	Pass

Notes:

MCL - Maximum Contaminant Level, EPA Drinking Water Standards and Health Advisories, April 2012.

RSL - Regional Screening Level from 83 FR 36435.

UTL - Upper Tolerance Limit (95%) of the background data set.

GWPS - Groundwater Protection Standard. Appendix IV GWPS is the higher of the MCL/RSL and UTL.

mg/L = milligrams per liter

pCi/L = picocuries per liter

**Table 4-3
Background and Predicted Concentrations Compared to GWPS**

Constituent	Unit	GWPS Selection	MW-16-06				
			Data				
			Maximum Observed Concentration (A)	Maximum Predicted Concentration (B)	Combined Concentration (A+B)	GWPS	Pass/Fail
Antimony	mg/L	MCL	2.0E-03	6.7E-42	2.0E-03	6.0E-03	Pass
Arsenic	mg/L	MCL	7.9E-03	6.2E-42	7.9E-03	1.0E-02	Pass
Barium	mg/L	MCL	3.0E-01	3.9E-40	3.0E-01	2.0	Pass
Beryllium	mg/L	MCL	1.0E-03	2.7E-42	1.0E-03	4.0E-03	Pass
Cadmium	mg/L	MCL	1.0E-03	2.7E-42	1.0E-03	5.0E-03	Pass
Chromium	mg/L	MCL	1.4E-02	6.7E-42	1.4E-02	1.0E-01	Pass
Cobalt	mg/L	RSL	4.9E-03	3.5E-42	4.9E-03	6.0E-03	Pass
Fluoride	mg/L	MCL	1.30	2.9E-40	1.30	4.0	Pass
Lead	mg/L	RSL	4.8E-03	6.7E-42	4.8E-03	1.5E-02	Pass
Lithium	mg/L	Background	4.9E-02	4.1E-41	4.9E-02	5.5E-02	Pass
Mercury	mg/L	MCL	2.0E-04	2.7E-43	2.0E-04	2.0E-03	Pass
Molybdenum	mg/L	RSL	3.0E-02	2.0E-40	3.0E-02	1.0E-01	Pass
Radium-226/228	pCi/L	MCL	2.2E-03	1.2E-39	2.2E-03	5.0E-03	Pass
Selenium	mg/L	MCL	5.0E-03	5.8E-42	5.0E-03	5.0E-02	Pass
Thallium	mg/L	MCL	1.0E-03	3.5E-42	1.0E-03	2.0E-03	Pass

Notes:

MCL - Maximum Contaminant Level, EPA Drinking Water Standards and Health Advisories, April 2012.

RSL - Regional Screening Level from 83 FR 36435.

UTL - Upper Tolerance Limit (95%) of the background data set.

GWPS - Groundwater Protection Standard. Appendix IV GWPS is the higher of the MCL/RSL and UTL.

mg/L = milligrams per liter

pCi/L = picocuries per liter

**Table 4-3
Background and Predicted Concentrations Compared to GWPS**

Constituent	Unit	GWPS Selection	MW-16-07				
			Data				
			Maximum Observed Concentration (A)	Maximum Predicted Concentration (B)	Combined Concentration (A+B)	GWPS	Pass/Fail
Antimony	mg/L	MCL	2.0E-03	6.7E-42	2.0E-03	6.0E-03	Pass
Arsenic*	mg/L	Background	1.1E-02	6.2E-42	1.1E-02	1.0E-02	Pass
Barium	mg/L	MCL	4.5E-01	3.9E-40	4.5E-01	2.0	Pass
Beryllium	mg/L	MCL	1.7E-03	2.7E-42	1.7E-03	4.0E-03	Pass
Cadmium	mg/L	MCL	1.3E-03	2.7E-42	1.3E-03	5.0E-03	Pass
Chromium	mg/L	MCL	5.3E-02	6.7E-42	5.3E-02	1.0E-01	Pass
Cobalt*	mg/L	Background	9.2E-03	3.5E-42	9.2E-03	1.3E-02	Pass
Fluoride	mg/L	MCL	1.2	2.9E-40	1.2	4.0	Pass
Lead*	mg/L	RSL	8.7E-03	6.7E-42	8.7E-03	1.5E-02	Pass
Lithium	mg/L	Background	7.8E-02	4.1E-41	7.8E-02	9.2E-02	Pass
Mercury	mg/L	MCL	2.0E-04	2.7E-43	2.0E-04	2.0E-03	Pass
Molybdenum	mg/L	RSL	7.3E-02	2.0E-40	7.3E-02	1.0E-01	Pass
Radium-226/228	pCi/L	Background	4.5E-03	1.2E-39	4.5E-03	5.8E-03	Pass
Selenium	mg/L	MCL	5.3E-03	5.8E-42	5.3E-03	5.0E-02	Pass
Thallium	mg/L	Background	2.3E-03	3.5E-42	2.3E-03	2.E-03	Pass

Notes:

MCL - Maximum Contaminant Level, EPA Drinking Water Standards and Health Advisories, April 2012.

RSL - Regional Screening Level from 83 FR 36435.

UTL - Upper Tolerance Limit (95%) of the background data set.

GWPS - Groundwater Protection Standard. Appendix IV GWPS is the higher of the MCL/RSL and UTL.

mg/L = milligrams per liter

pCi/L = picocuries per liter

* - Anomalously high value removed, failed Dixon's Test for outliers at 1% significance

**Table 4-3
Background and Predicted Concentrations Compared to GWPS**

Constituent	Unit	GWPS Selection	MW-16-08				
			Data				
			Maximum Observed Concentration (A)	Maximum Predicted Concentration (B)	Combined Concentration (A+B)	GWPS	Pass/Fail
Antimony	mg/L	MCL	2.1E-03	6.7E-42	2.1E-03	6.0E-03	Pass
Arsenic	mg/L	Background	2.1E-02	6.2E-42	2.1E-02	3.0E-02	Pass
Barium	mg/L	MCL	4.3E-01	3.9E-40	4.3E-01	2.0	Pass
Beryllium	mg/L	MCL	1.6E-03	2.7E-42	1.6E-03	4.0E-03	Pass
Cadmium	mg/L	MCL	1.5E-03	2.7E-42	1.5E-03	5.0E-03	Pass
Chromium	mg/L	MCL	4.0E-02	6.7E-42	4.0E-02	1.0E-01	Pass
Cobalt	mg/L	Background	1.6E-02	3.5E-42	1.6E-02	2.2E-02	Pass
Fluoride	mg/L	MCL	1.3	2.9E-40	1.3	4.0	Pass
Lead	mg/L	Background	1.6E-02	6.7E-42	1.6E-02	2.2E-02	Pass
Lithium	mg/L	Background	9.6E-02	4.1E-41	9.6E-02	1.1E-01	Pass
Mercury	mg/L	MCL	2.0E-04	2.7E-43	2.0E-04	2.0E-03	Pass
Molybdenum	mg/L	RSL	5.8E-02	2.0E-40	5.8E-02	1.0E-01	Pass
Radium-226/228	pCi/L	Background	5.1E-03	1.2E-39	5.1E-03	7.6E-03	Pass
Selenium	mg/L	MCL	5.0E-03	5.8E-42	5.0E-03	5.0E-02	Pass
Thallium	mg/L	MCL	1.3E-03	3.5E-42	1.3E-03	2.0E-03	Pass

Notes:

MCL - Maximum Contaminant Level, EPA Drinking Water Standards and Health Advisories, April 2012.

RSL - Regional Screening Level from 83 FR 36435.

UTL - Upper Tolerance Limit (95%) of the background data set.

GWPS - Groundwater Protection Standard. Appendix IV GWPS is the higher of the MCL/RSL and UTL.

mg/L = milligrams per liter

pCi/L = picocuries per liter

**Table 4-3
Background and Predicted Concentrations Compared to GWPS**

Constituent	Unit	GWPS Selection	MW-16-10				
			Data				
			Maximum Observed Concentration (A)	Maximum Predicted Concentration (B)	Combined Concentration (A+B)	GWPS	Pass/Fail
Antimony	mg/L	MCL	2.1E-03	6.7E-42	2.1E-03	6.0E-03	Pass
Arsenic	mg/L	Background	1.1E-02	6.7E-42	1.1E-02	1.0E-02	Pass
Barium	mg/L	MCL	1.5E-01	3.9E-40	1.5E-01	2.0	Pass
Beryllium	mg/L	MCL	1.0E-03	2.7E-42	1.0E-03	4.0E-03	Pass
Cadmium	mg/L	MCL	1.0E-03	2.7E-42	1.0E-03	5.0E-03	Pass
Chromium	mg/L	MCL	2.1E-02	6.7E-42	2.1E-02	1.0E-01	Pass
Cobalt	mg/L	Background	1.2E-02	3.5E-42	1.2E-02	1.7E-02	Pass
Fluoride	mg/L	MCL	1.2	2.9E-40	1.2	4.0	Pass
Lead	mg/L	Background	7.0E-03	6.7E-42	7.0E-03	3.5E-02	Pass
Lithium*	mg/L	Background	9.1E-02	4.1E-41	9.1E-02	1.2E-01	Pass
Mercury	mg/L	MCL	2.0E-04	2.7E-43	2.0E-04	2.0E-03	Pass
Molybdenum	mg/L	RSL	3.3E-02	2.0E-40	3.3E-02	1.0E-01	Pass
Radium-226/228	pCi/L	MCL	2.0E-03	1.2E-39	2.0E-03	5.0E-03	Pass
Selenium	mg/L	MCL	5.0E-03	5.8E-42	5.0E-03	5.0E-02	Pass
Thallium	mg/L	MCL	1.0E-03	3.5E-42	1.0E-03	2.0E-03	Pass

Notes:

MCL - Maximum Contaminant Level, EPA Drinking Water Standards and Health Advisories, April 2012.

RSL - Regional Screening Level from 83 FR 36435.

UTL - Upper Tolerance Limit (95%) of the background data set.

GWPS - Groundwater Protection Standard. Appendix IV GWPS is the higher of the MCL/RSL and UTL.

mg/L = milligrams per liter

pCi/L = picocuries per liter

* - Anomalously high value removed, failed Dixon's Test for outliers at 1% significance

**Table 4-3
Background and Predicted Concentrations Compared to GWPS**

Constituent	Unit	GWPS Selection	MW-16-11/11A				
			Data				
			Maximum Observed Concentration (A)	Maximum Predicted Concentration (B)	Combined Concentration (A+B)	GWPS	Pass/Fail
Antimony	mg/L	MCL	3.1E-03	6.7E-42	3.1E-03	6.0E-03	Pass
Arsenic	mg/L	Background	1.7E-02	6.2E-42	1.7E-02	2.4E-02	Pass
Barium	mg/L	MCL	4.8E-01	3.9E-40	4.8E-01	2.0	Pass
Beryllium	mg/L	MCL	1.6E-03	2.7E-42	1.6E-03	4.0E-03	Pass
Cadmium	mg/L	MCL	1.0E-03	2.7E-42	1.0E-03	5.0E-03	Pass
Chromium	mg/L	MCL	3.9E-02	6.7E-42	3.9E-02	1.0E-01	Pass
Cobalt	mg/L	Background	3.4E-03	3.5E-42	3.4E-03	7.1E-03	Pass
Fluoride	mg/L	MCL	1.0	2.9E-40	9.5E-01	4.0	Pass
Lead	mg/L	RSL	5.2E-03	6.7E-42	5.2E-03	1.5E-02	Pass
Lithium	mg/L	Background	1.1E-01	4.1E-41	1.1E-01	1.5E-01	Pass
Mercury	mg/L	MCL	2.0E-04	2.7E-43	2.0E-04	2.0E-03	Pass
Molybdenum	mg/L	RSL	3.2E-02	2.0E-40	3.2E-02	1.0E-01	Pass
Radium-226/228	pCi/L	MCL	2.2E-03	1.2E-39	2.2E-03	5.0E-03	Pass
Selenium	mg/L	MCL	5.0E-03	5.8E-42	5.0E-03	5.0E-02	Pass
Thallium	mg/L	MCL	1.0E-03	3.5E-42	1.0E-03	2.0E-03	Pass

Notes:

MCL - Maximum Contaminant Level, EPA Drinking Water Standards and Health Advisories, April 2012.

RSL - Regional Screening Level from 83 FR 36435.

UTL - Upper Tolerance Limit (95%) of the background data set.

GWPS - Groundwater Protection Standard. Appendix IV GWPS is the higher of the MCL/RSL and UTL.

mg/L = milligrams per liter

pCi/L = picocuries per liter

* - Anomalously high value removed, failed Dixon's Test for outliers at 1% significance

Table 4-4 – Sensitivity Analysis Model Inputs

	Baseline	Sensitivity Analysis		Baseline	Sensitivity Analysis	Baseline	Sensitivity Analysis		Baseline	Sensitivity Analysis		Baseline	Sensitivity Analysis		Baseline	Sensitivity Analysis
	Thickness (m)	Max Thickness (m)	Min Thickness (m)	Dv (m/yr)	Dv (m/yr)	CoHD	CoHD +25%	CoHD -25%	Total Porosity	Max Porosity	Min Porosity	Effective Porosity	Eff. Porosity Max	Eff. Porosity Min	Modeling Period (years)	Modeling Period (years)
<i>Layer Properties</i>																
Clay	11.12	12.13	10.70	2.03E-04	4.07E-04	0.019	0.024	0.014	0.515	0.65	0.46	0.42	0.53	0.37	55	85
Clay with Sand	25.66	26.82	24.66	2.03E-04	4.07E-04	0.019	0.024	0.014	0.635	0.67	0.46	0.51	0.54	0.37	55	85

Dv = Vertical Darcy Velocity

CoHD = Coefficient of Hydrodynamic Dispersion

Table 4-5 – Sensitivity Analysis Model Results

Diversion Basin Sensitivity Analysis			
Model Name	Description	Prediction Factor	Pass?*
DB_Baseline	Baseline model for the Bottom Ash Basins.	6.35E-40	YES
DB_ExtendedRun	Model runtime was extended from 55 years to 85 years.	1.14E-32	YES
DB_Darcy	Darcy velocity was doubled.	9.60E-40	YES
DB_CoHD_High	Coefficient of Hydrodynamic Dispersion was increased by 25%.	8.53E-36	YES
DB_CoHD_Low	Coefficient of Hydrodynamic Dispersion was decreased by 25%.	5.19E-47	YES
DB_ClayPoro_High	Used the highest effective porosity in clay interval; derived from laboratory data in project database.	6.98E-40	YES
DB_ClayPoro_Low	Used the lowest effective porosity in clay interval; derived from laboratory data in project database.	6.08E-40	YES
DB_SandPoro_High	Used the highest effective porosity in clay with sand interval; derived from laboratory data in project database.	6.06E-40	YES
DB_SandPoro_Low	Used the lowest effective porosity in clay with sand interval; derived from laboratory data in project database.	8.29E-40	YES
DB_ClayThick	Used thickest clay interval seen in boring/well; derived from project database.	4.18E-41	YES
DB_ClayThin	Used thinnest clay interval seen in boring/well; derived from project database.	1.96E-39	YES
DB_SandThick	Used thickest clay with sand interval seen in boring/well; derived from project database.	2.76E-41	YES
DB_SandThin	Used thinnest clay sand interval seen in boring/well; derived from project database.	8.74E-39	YES
* Indicates value less than PF _{threshold} as discussed in Section 4.6.2.			

FIGURES

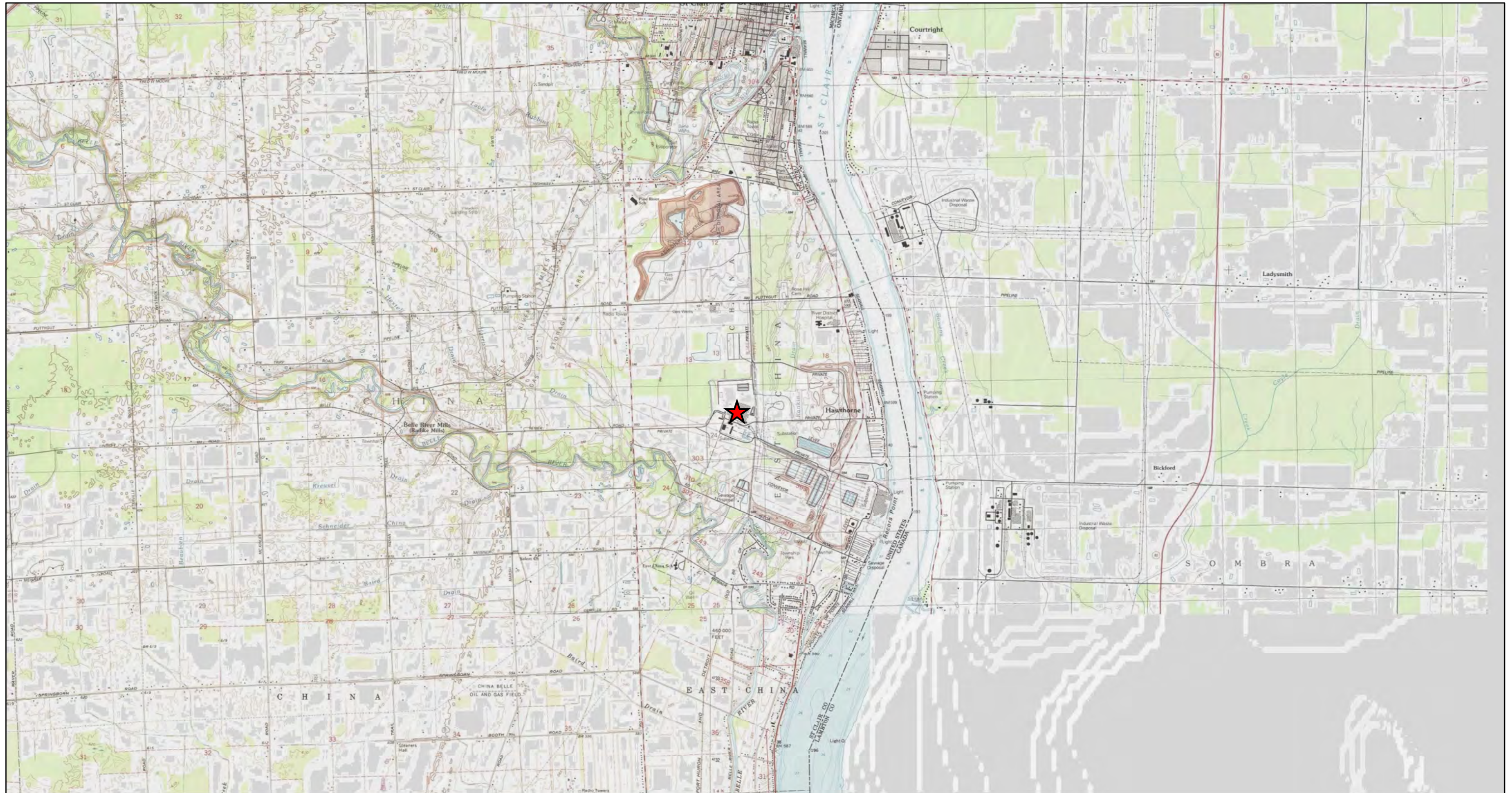

Legend
 Site Location



Site Location DTE Energy Belle River Power Plant 4505 King Road China Township, Michigan	
 Geosyntec Consultants of Michigan	
Detroit, Michigan	April 2023
Figure 1-1	



Maxar, Microsoft, Esri Community Maps Contributors, Province of Ontario, County of Lambton, SEMCOG, BuildingFootprintUSA, Esri Canada, Esri, HERE, Garmin, SafeGraph, INCREMENT P, METI/NASA, USGS, EPA, NPS, US Census Bureau, USDA, NRCan, Parks Canada

Boring Locations

- Boring - Geosyntec
- CPT - Geosyntec
- MW - TRC
- Boring - Bechtel

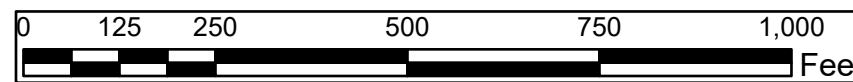

**Field Investigation Locations
Bell River Power Plant
China Township, MI**

Geosyntec
consultants
Geosyntec Consultants of Michigan

**Figure
2-1**

GLP8017

April 2023

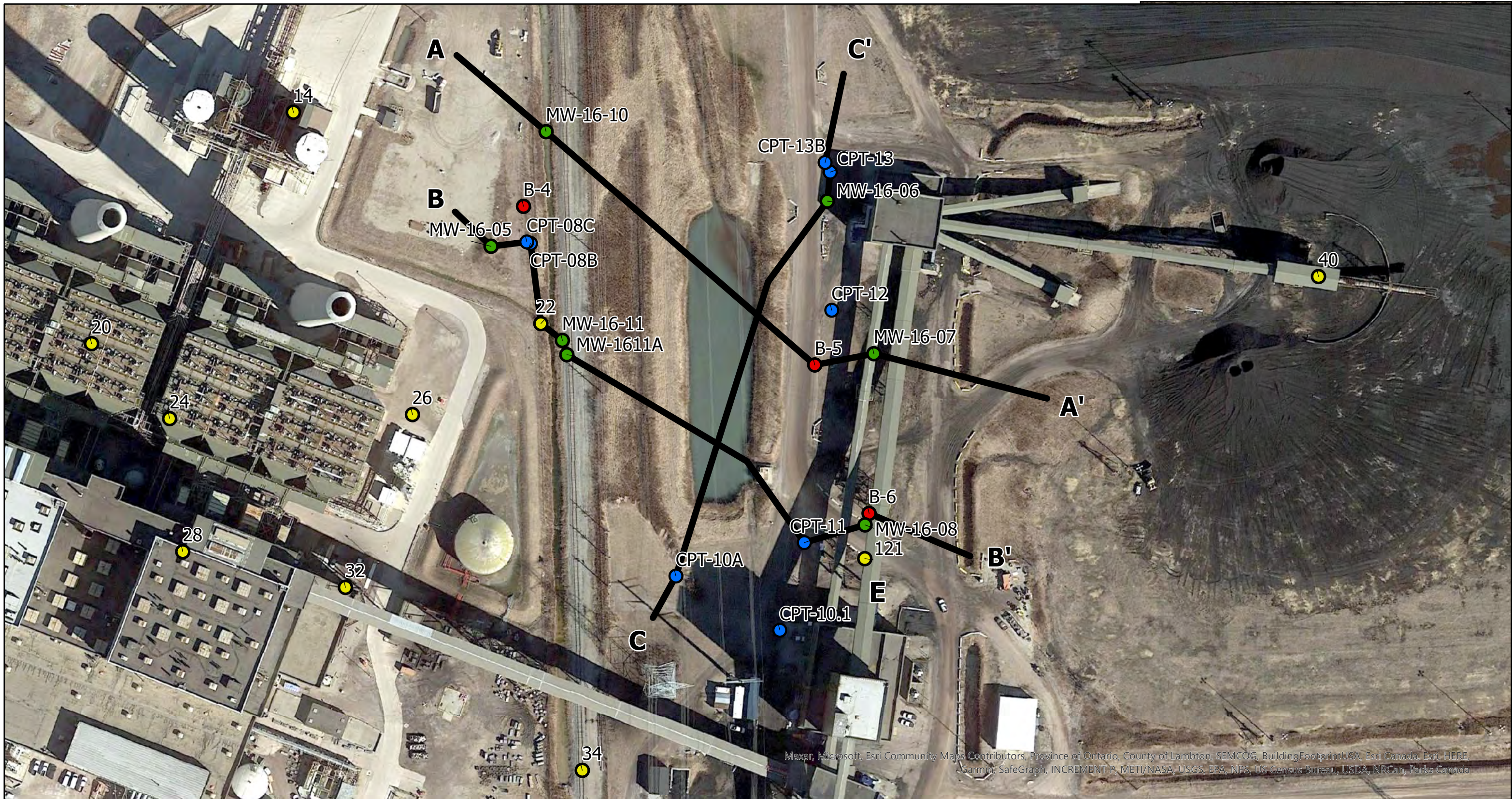

Maxar, Microsoft, Esri Community Maps Contributors, Province of Ontario, County of Lambton, SEMCOG, BuildingFootprintUSA, Esri Canada, Esri, HERE, Garmin, SafeGraph, INCREMENT P, METI/NASA, USGS, EPA, NPS, US Census Bureau, USDA, NRCan, Parks Canada

Boring Locations

- Boring - Geosyntec
- CPT - Geosyntec
- MW - TRC
- Boring - Bechtel

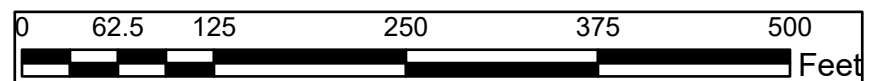

Cross Section Locations
Belle River Power Plant - Diversion Basin
China Township, MI

Geosyntec
 consultants
 Geosyntec Consultants of Michigan

Figure
2-2

GLP8017

April 2023



Legend

Boring Locations

- Boring - Geosyntec
- CPT - Geosyntec
- MW - TRC
- Boring - Bechtel

Service Layer Credits: Google Earth
Imagery dated 03/24/2019

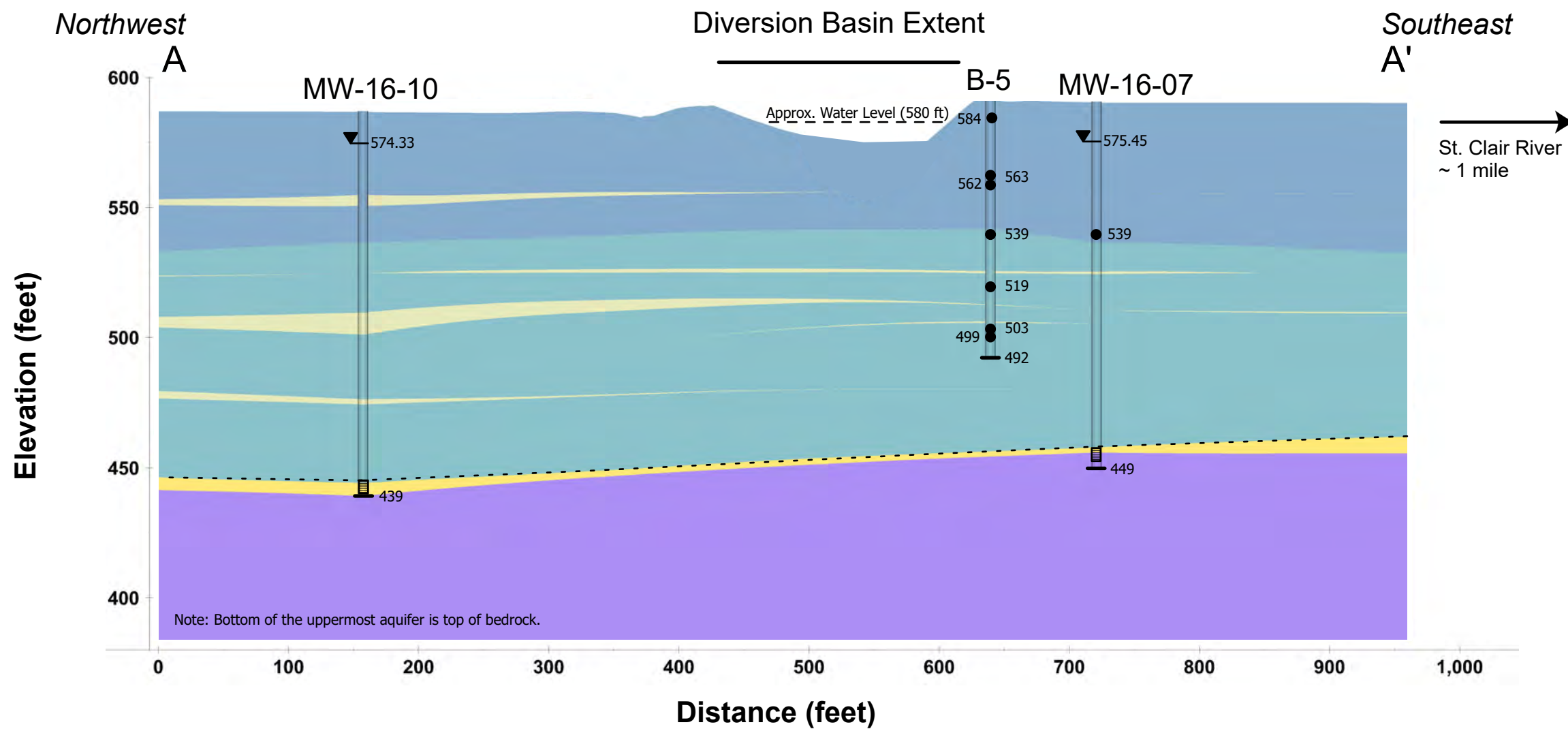

Lithology

- Clay
- Clay with Sand
- Sandy Seams
- Uppermost Aquifer
- Shale Bedrock

- ▼ Water Level of Uppermost Aquifer
- End of Investigation
- ▤ Well Screen Interval
- - - Top of Uppermost Aquifer Unit
- CPT Pore Pressure Dissipation Test
- Geotechnical Sample Elevation

Vertical Scale: 1-inch = 50-feet
Horizontal Scale: 1-inch = 100-feet
Elevations are in Average Mean Sea Level
Unit interfaces are interpreted from limited data and are approximate.

Cross-Section A-A' Belle River Power Plant - Diversion Basin China Township, MI

Geosyntec
consultants

Figure

2-3

GLP8017

April 2023

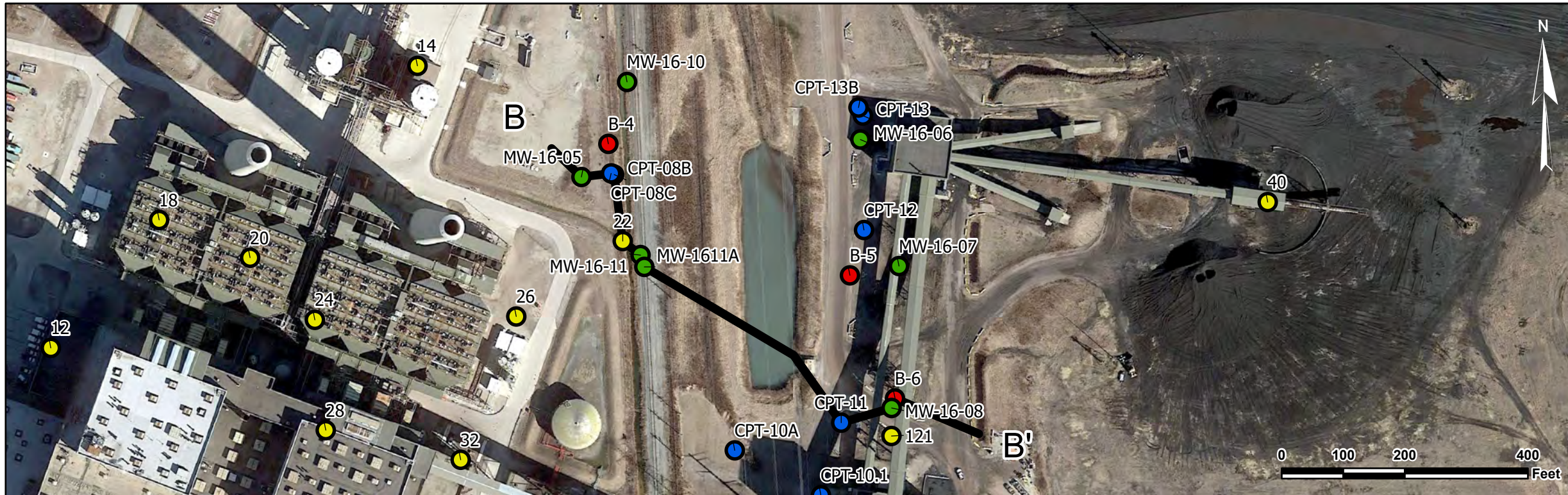

Legend

Boring Locations

- Boring - Geosyntec
- CPT - Geosyntec
- MW - TRC
- Boring - Bechtel

Service Layer Credits: Google Earth
Imagery dated 03/24/2019

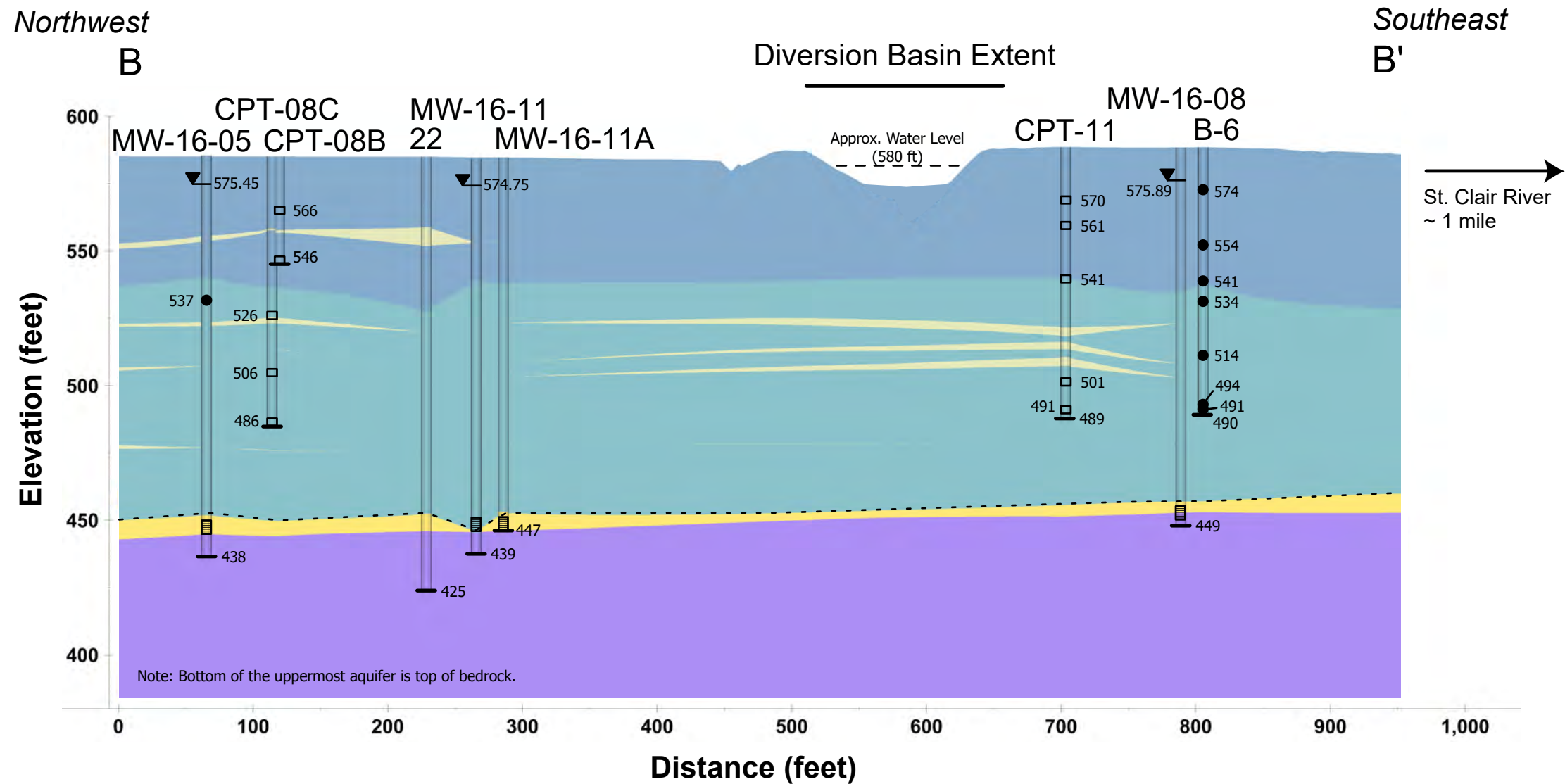

Lithology

- Clay
- Clay with Sand
- Sandy Seams
- Uppermost Aquifer
- Shale Bedrock

- ▼ Water Level of Uppermost Aquifer
- End of Investigation
- Well Screen Interval
- - - Top of Uppermost Aquifer Unit
- CPT Pore Pressure Dissipation Test
- Geotechnical Sample Elevation

Vertical Scale: 1-inch = 50-feet
Horizontal Scale: 1-inch = 100-feet
Elevations are in Average Mean Sea Level
Unit interfaces are interpreted from limited data and are approximate.

Cross-Section B-B'
Belle River Power Plant - Diversion Basin
China Township, MI

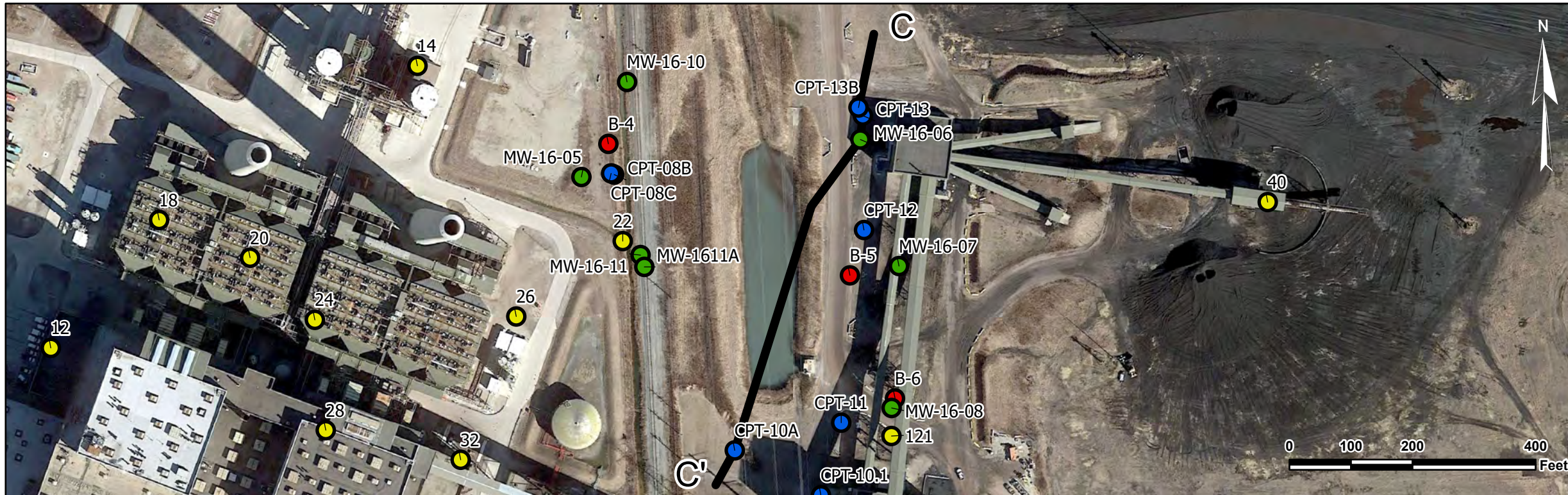

Legend

Boring Locations

- Boring - Geosyntec
- CPT - Geosyntec
- MW - TRC
- Boring - Bechtel

Service Layer Credits: Google Earth
Imagery dated 03/24/2019

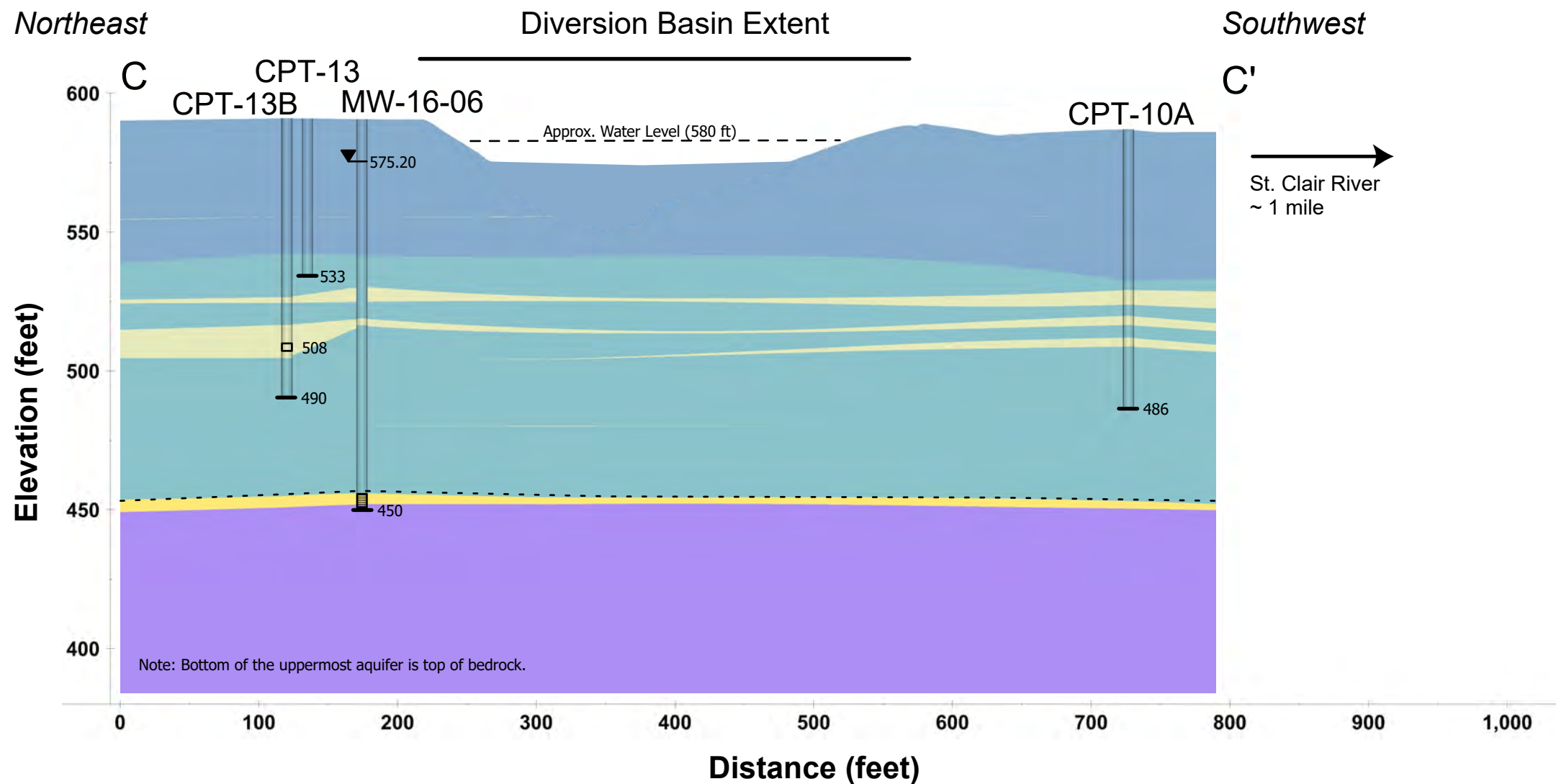

Lithology

- Clay
- Clay with Sand
- Sandy Seams
- Uppermost Aquifer
- Shale Bedrock

- ▼ Water Level of Uppermost Aquifer
- End of Investigation
- Well Screen Interval
- - - Top of Uppermost Aquifer Unit
- CPT Pore Pressure Dissipation Test
- Geotechnical Sample Elevation

Vertical Scale: 1-inch = 50-feet
Horizontal Scale: 1-inch = 100-feet
Elevations are in Average Mean Sea Level
Unit interfaces are interpreted from limited data and are approximate.

Cross-Section C-C' Belle River Power Plant - Diversion Basin China Township, MI

Geosyntec
consultants

Figure

2-5

GLP8017

April 2023

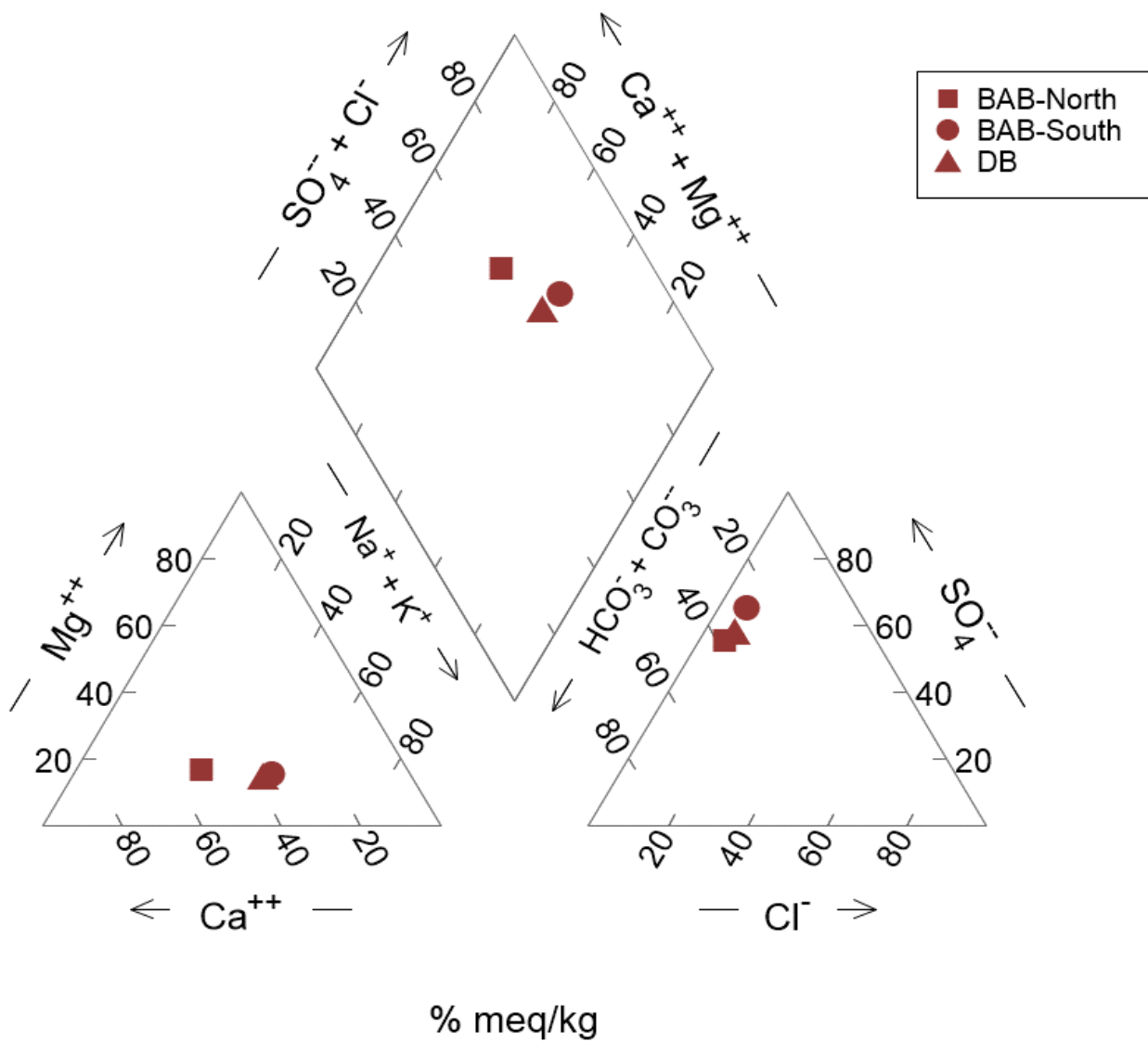

Note:
Results are shown in the relative percentage of milliequivalents per kilogram (meq/kg).

Filtered BAB and DB Porewater Sample Piper Diagram Belle River Power Plant St. Clair County, MI		Figure 3-1
 Geosyntec Consultants of Michigan		
GLP8017	April 2023	

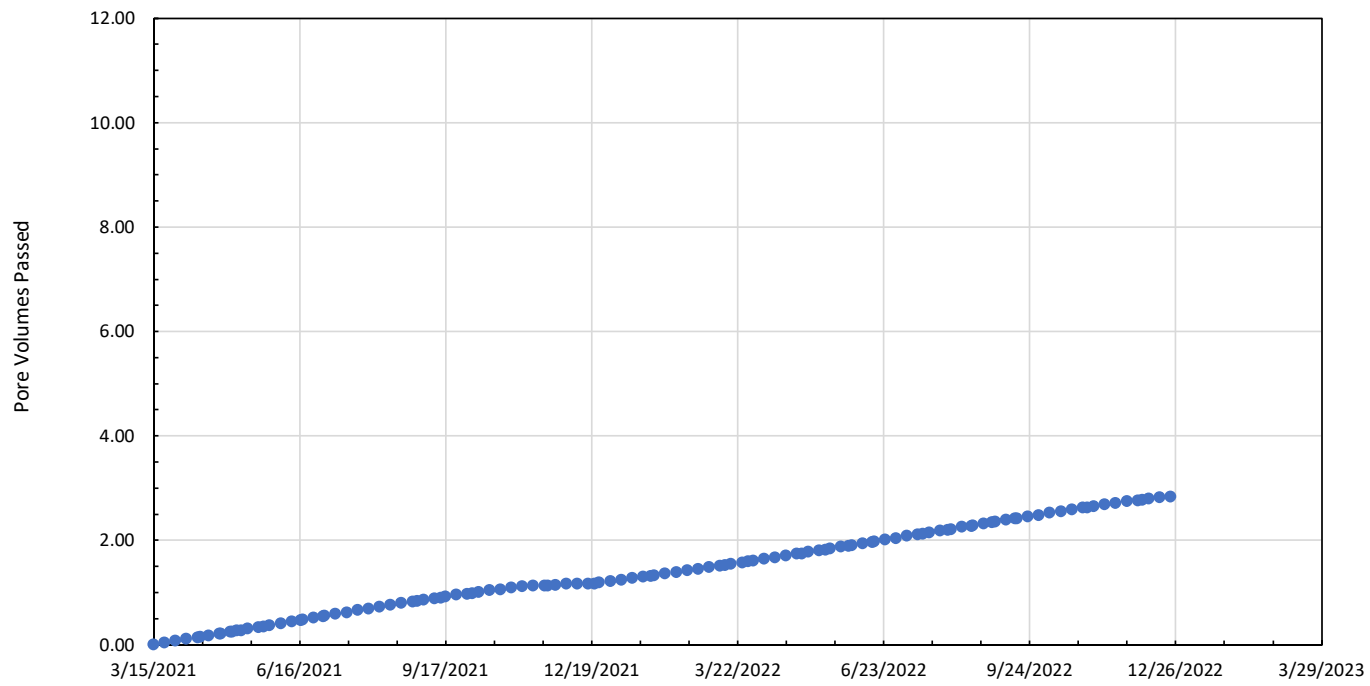

B1-ST-1 (7-9') PV Passed with Time

BELLE RIVER POWER PLANT
EAST CHINA TOWNSHIP, MICHIGAN





Figure

3-2

Detroit, MI

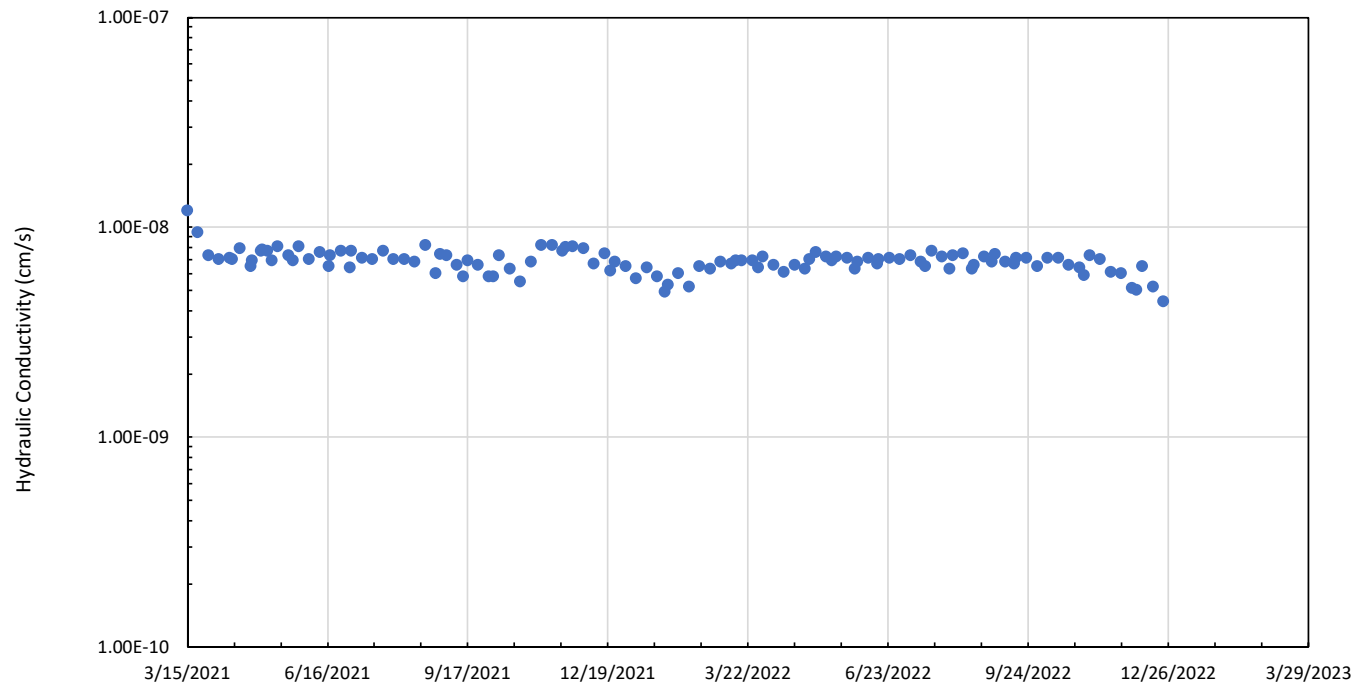
April 2023



B1-ST-1 (7-9') Hydraulic Conductivity with Time	
BELLE RIVER POWER PLANT EAST CHINA TOWNSHIP, MICHIGAN	
 <small>Geosyntec Consultants of Michigan</small>	
Detroit, MI	April 2023
Figure 3-3	

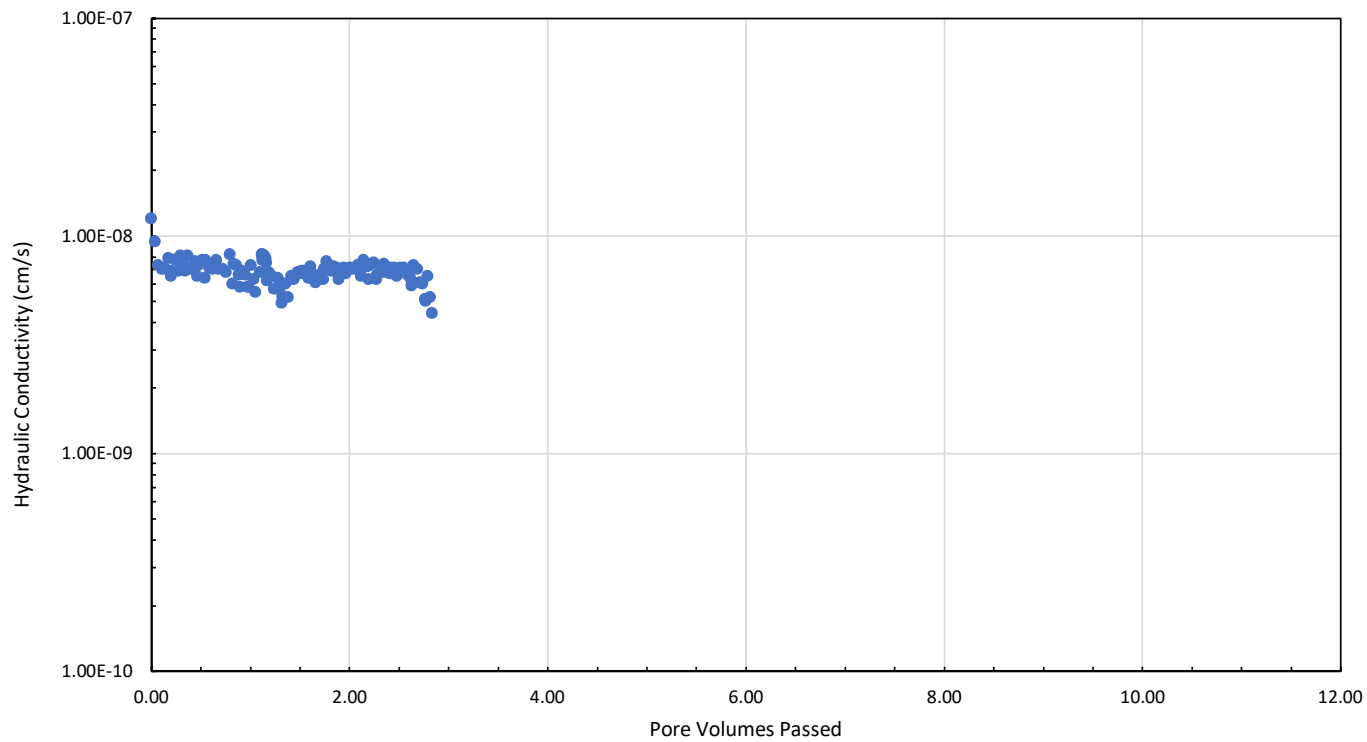

B1-ST-1 (7-9') Hydraulic Conductivity with PV

BELLE RIVER POWER PLANT
EAST CHINA TOWNSHIP, MICHIGAN





Figure

3-4

Detroit, MI

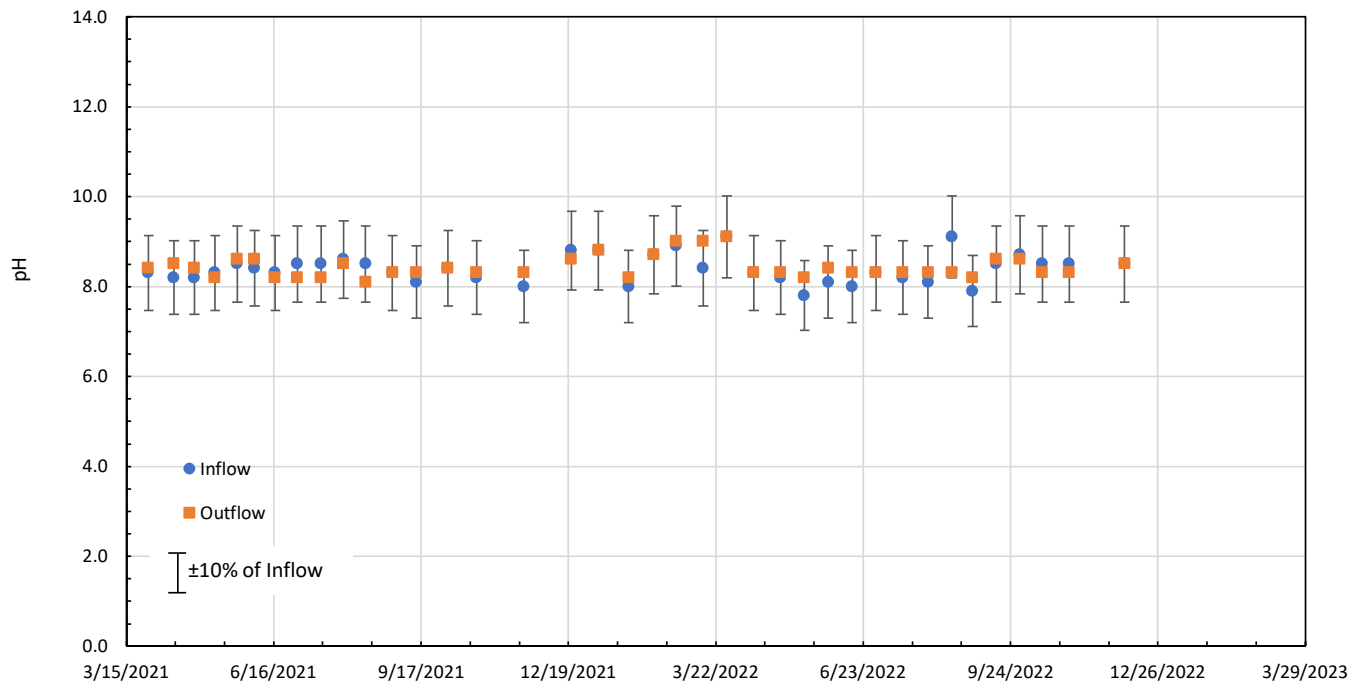
April 2023



B1-ST-1 (7-9') pH of Inflow and Outflow with Time	
BELLE RIVER POWER PLANT EAST CHINA TOWNSHIP, MICHIGAN	
 Geosyntec Consultants of Michigan	
Detroit, MI	Figure 3-5
April 2023	

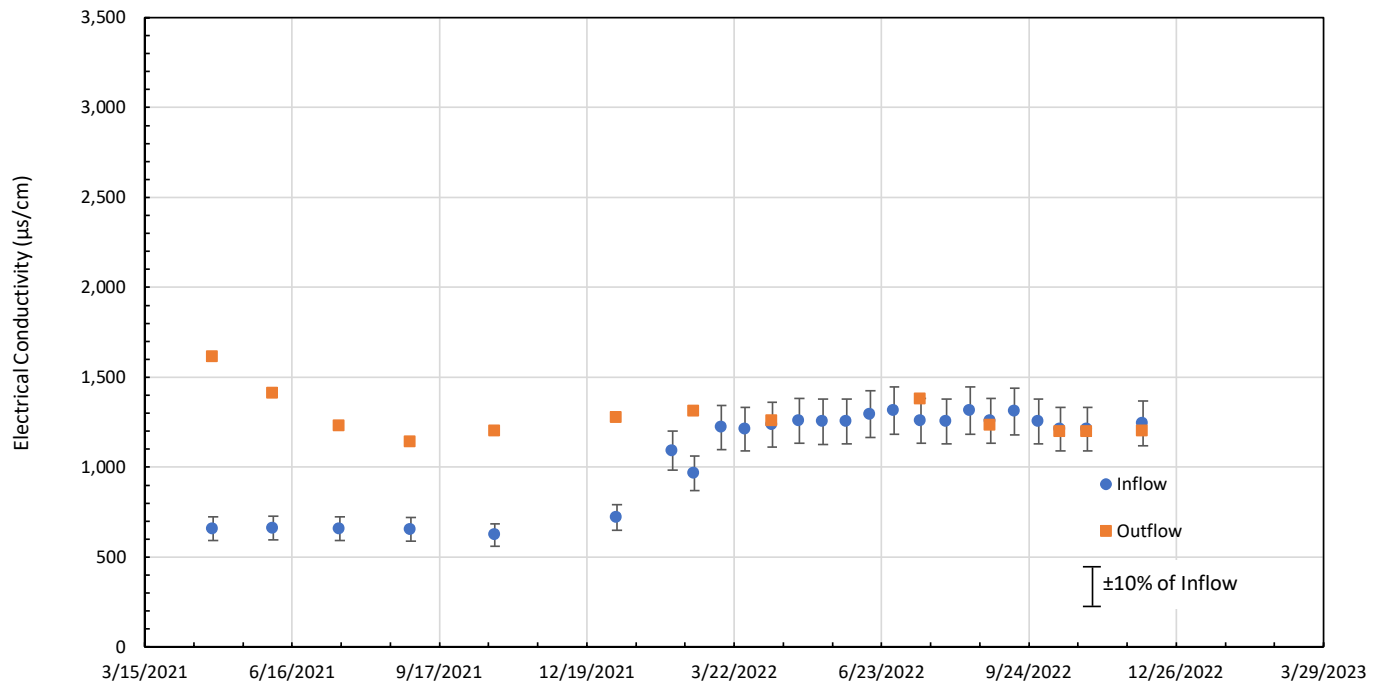

B1-ST-1 (7-9') Electrical Conductivity (EC) with Time	
BELLE RIVER POWER PLANT EAST CHINA TOWNSHIP, MICHIGAN	
 Geosyntec Consultants of Michigan	Figure
Detroit, MI	3-6
April 2023	

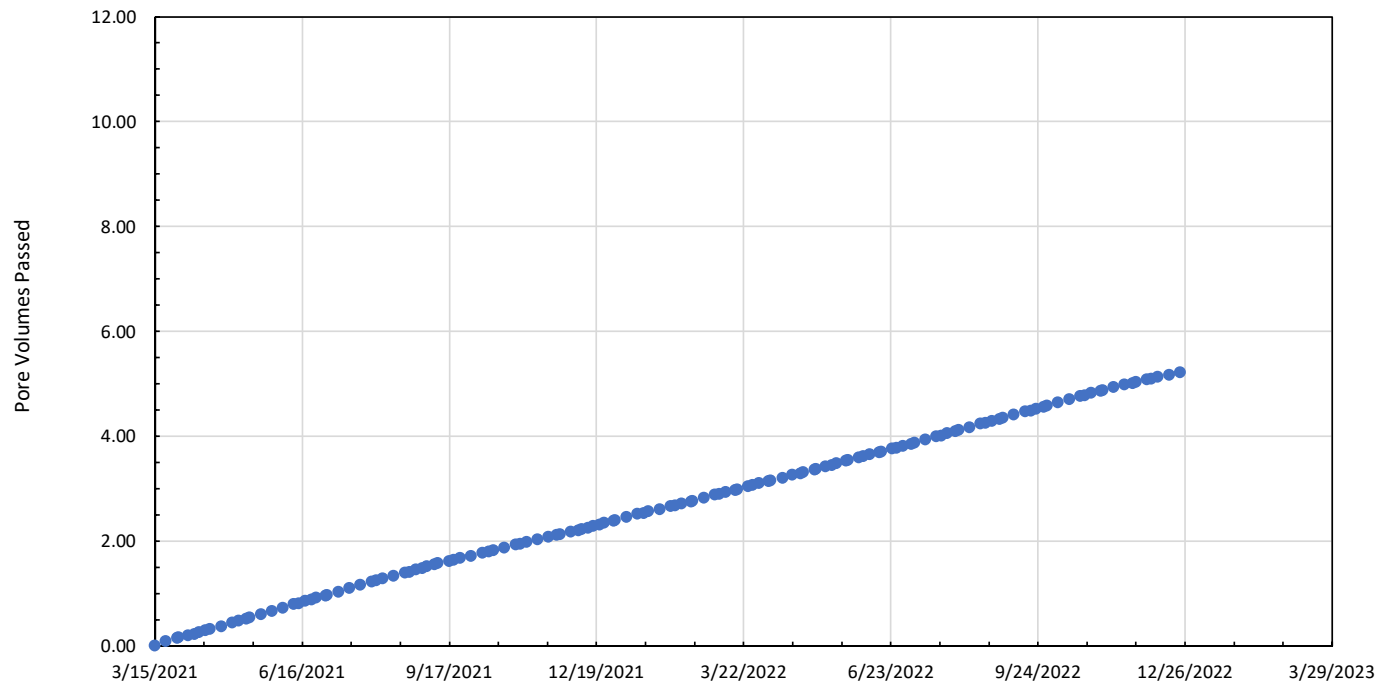

B2-ST-1 (1-3') PV Passed with Time

BELLE RIVER POWER PLANT
EAST CHINA TOWNSHIP, MICHIGAN





Figure

3-7

Detroit, MI

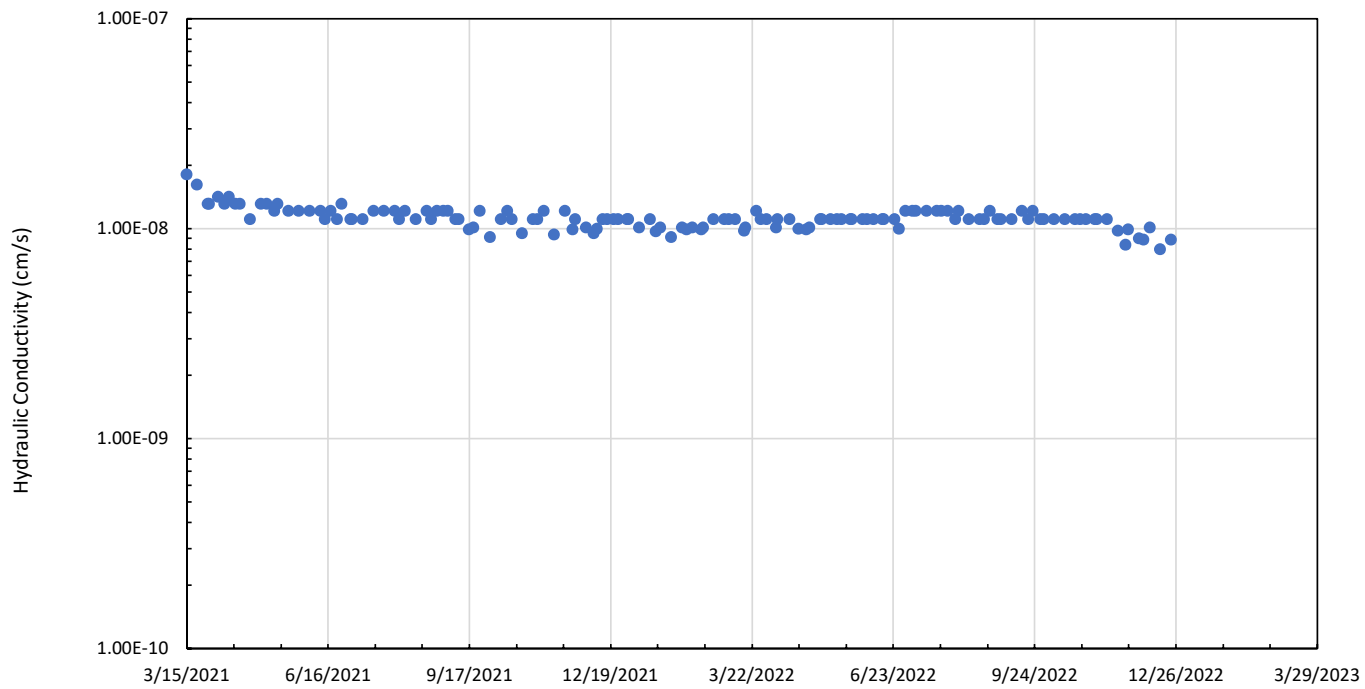
April 2023



B2-ST-1 (1-3') Hydraulic Conductivity with Time	
BELLE RIVER POWER PLANT EAST CHINA TOWNSHIP, MICHIGAN	
 Geosyntec Consultants of Michigan	
Detroit, MI	April 2023
Figure 3-8	

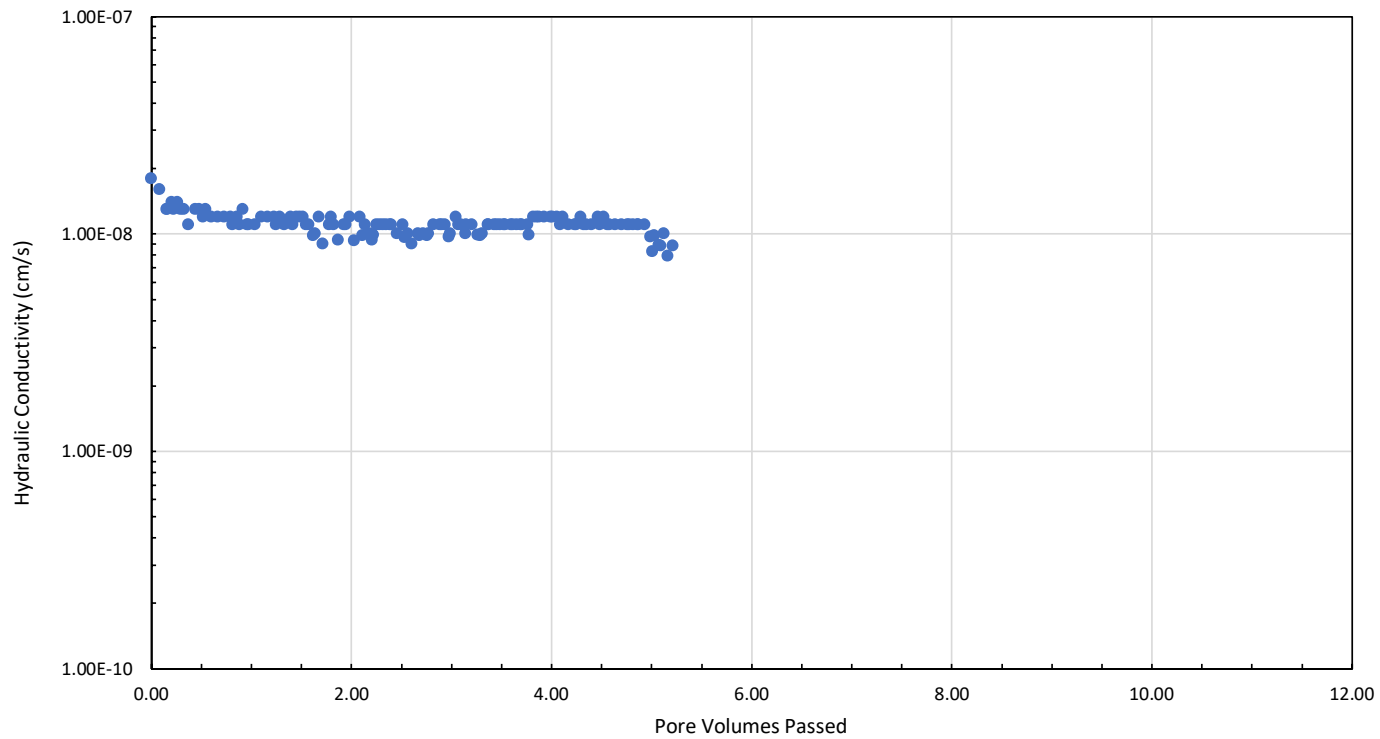

B2-ST-1 (1-3') Hydraulic Conductivity with PV

BELLE RIVER POWER PLANT
EAST CHINA TOWNSHIP, MICHIGAN





Figure

3-9

Detroit, MI

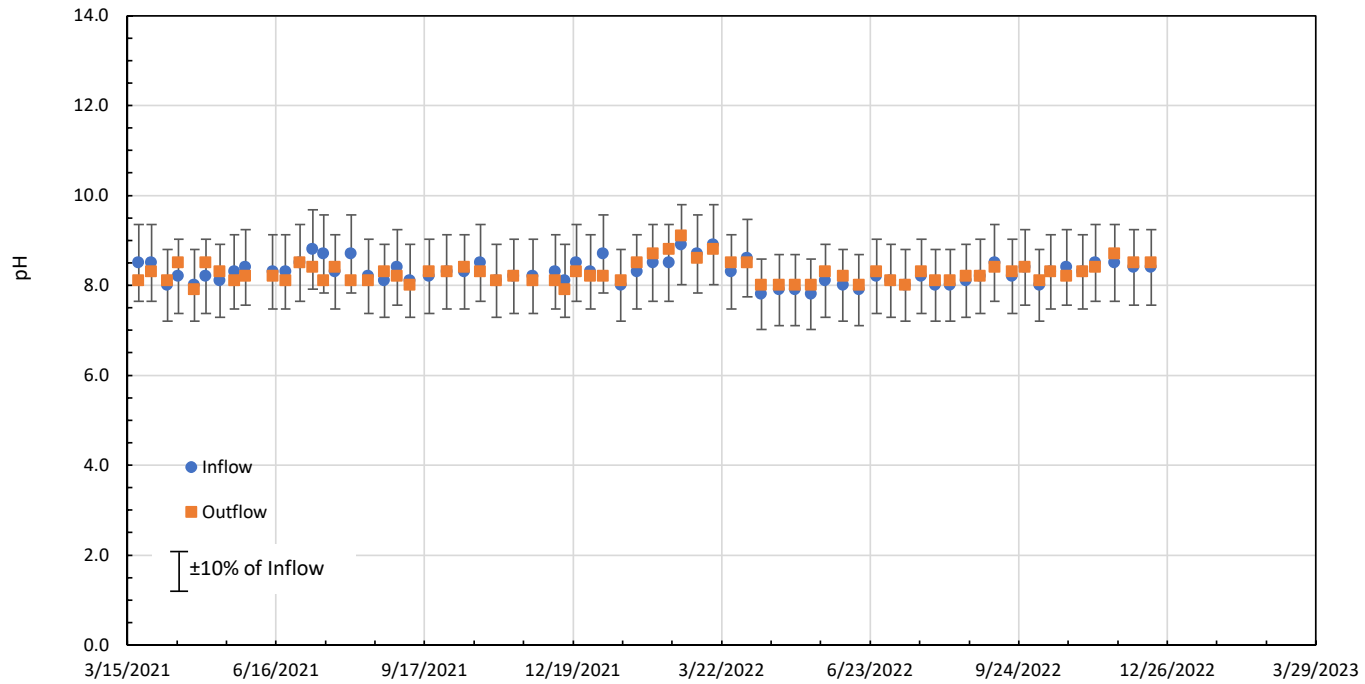
April 2023



B2-ST-1 (1-3') pH of Inflow and Outflow with Time	
BELLE RIVER POWER PLANT EAST CHINA TOWNSHIP, MICHIGAN	
 <small>Geosyntec Consultants of Michigan</small>	
Detroit, MI	Figure 3-10
April 2023	

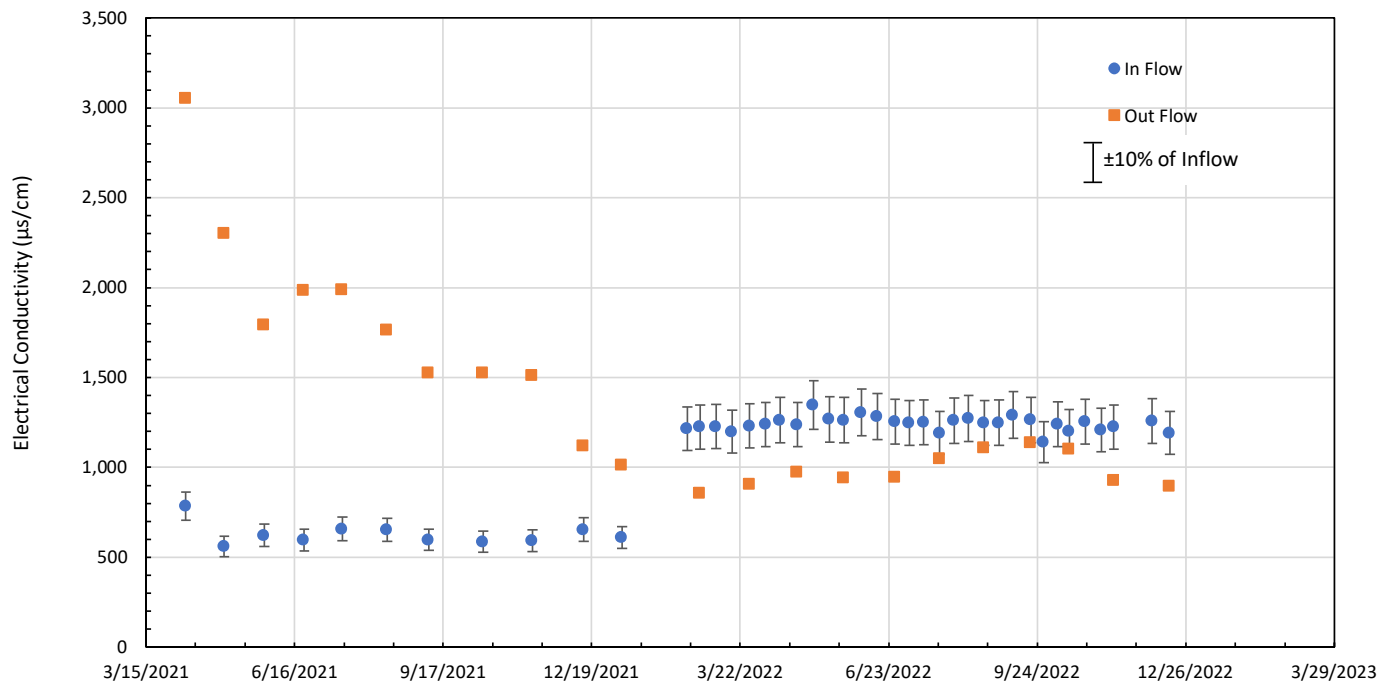

B2-ST-1 (1-3') Electrical Conductivity (EC) with Time

BELLE RIVER POWER PLANT
EAST CHINA TOWNSHIP, MICHIGAN



Figure

3-11

Detroit, MI

April 2023

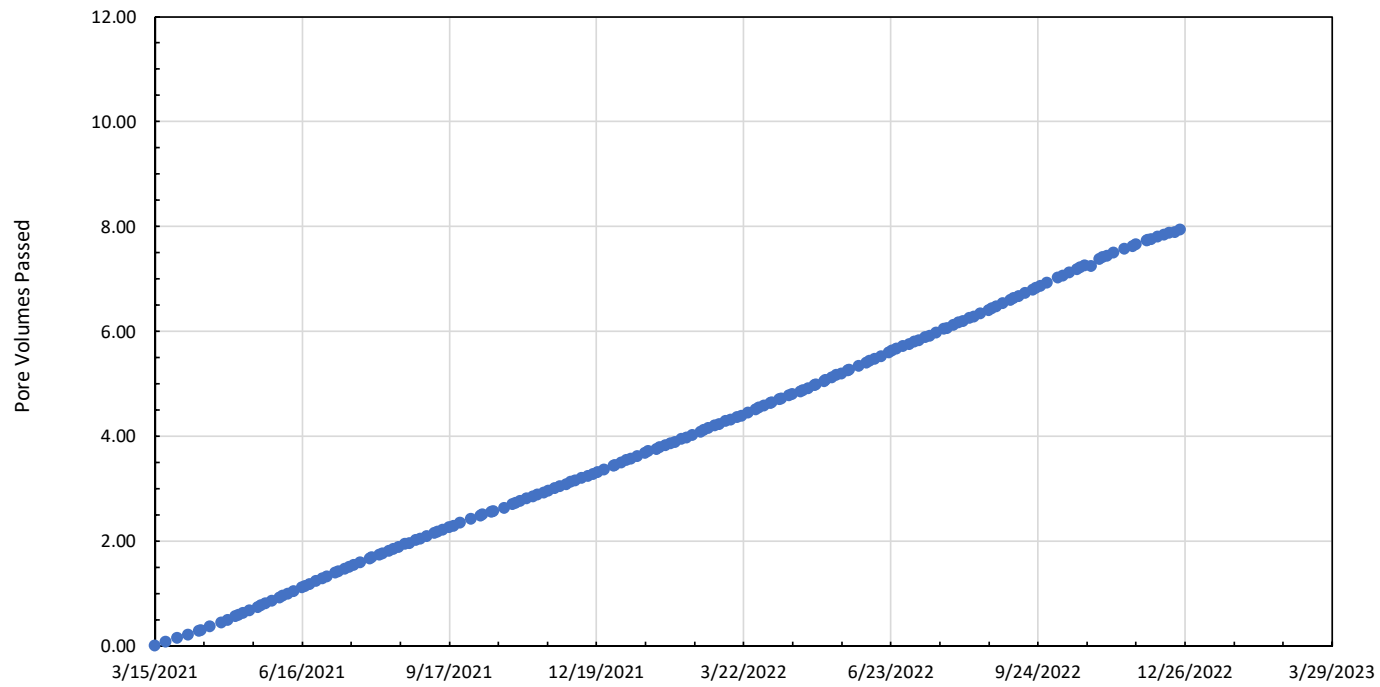

B2-ST-4 (47-49') PV Passed with Time

BELLE RIVER POWER PLANT
EAST CHINA TOWNSHIP, MICHIGAN





Figure

3-12

Detroit, MI

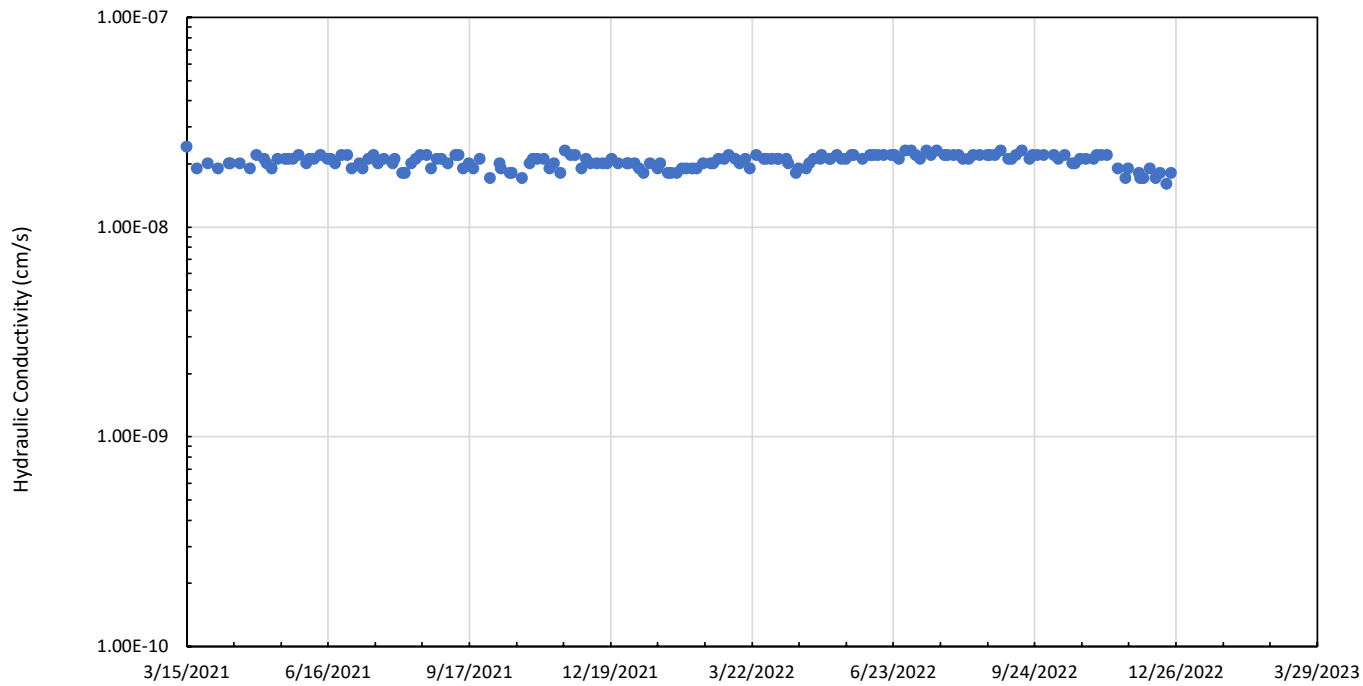
April 2023



B2-ST-4 (47-49') Hydraulic Conductivity with Time	
BELLE RIVER POWER PLANT EAST CHINA TOWNSHIP, MICHIGAN	
 <small>Geosyntec Consultants of Michigan</small>	
Detroit, MI	April 2023
Figure 3-13	

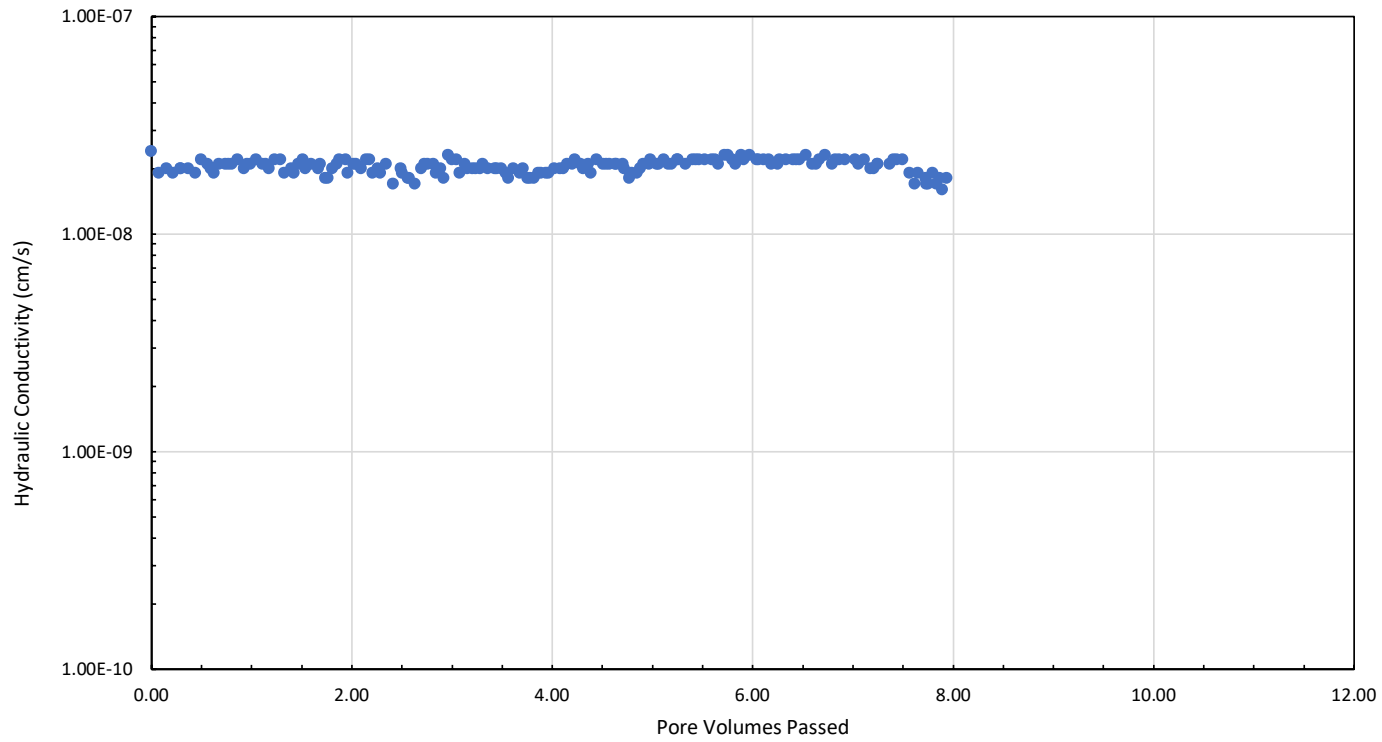

B2-ST-4 (47-49') Hydraulic Conductivity with PV	
BELLE RIVER POWER PLANT EAST CHINA TOWNSHIP, MICHIGAN	
 <small>Geosyntec Consultants of Michigan</small>	Figure
Detroit, MI	April 2023
3-14	

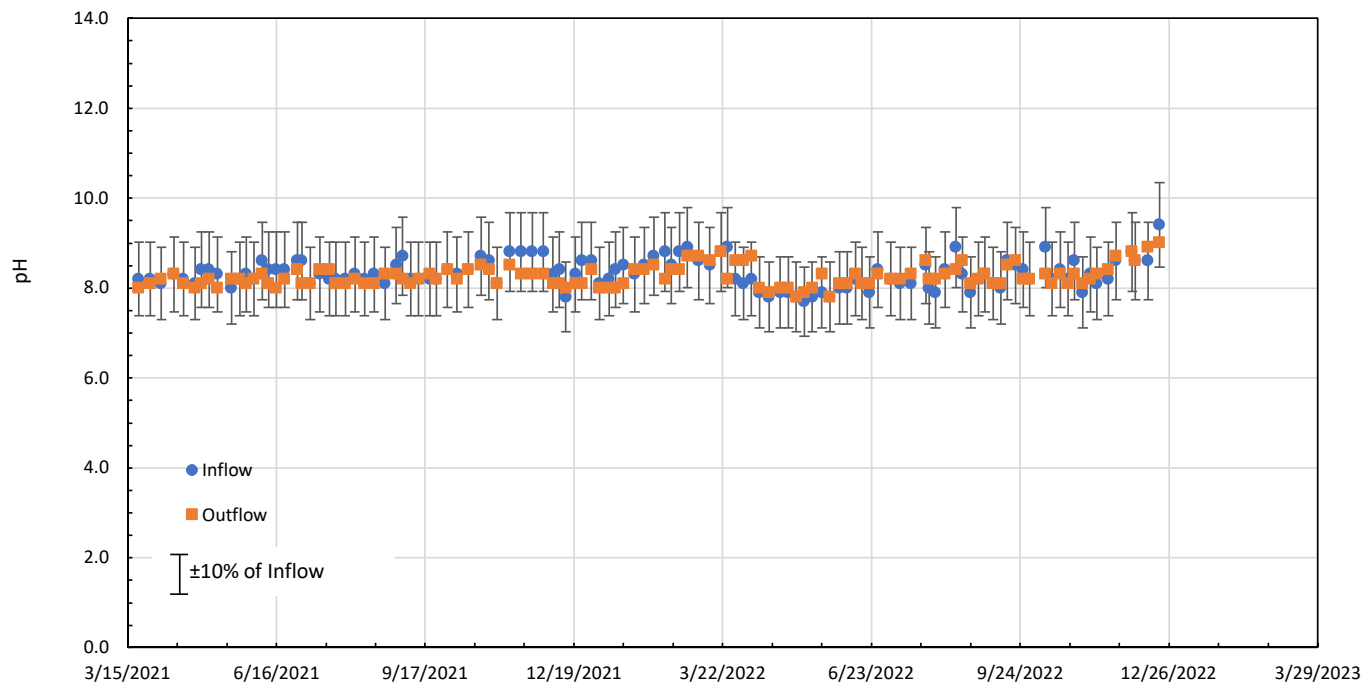

B2-ST-4 (47-49') pH of Inflow and Outflow with Time

BELLE RIVER POWER PLANT
EAST CHINA TOWNSHIP, MICHIGAN

Geosyntec
consultants
Geosyntec Consultants of Michigan

Figure

3-15

Detroit, MI

April 2023

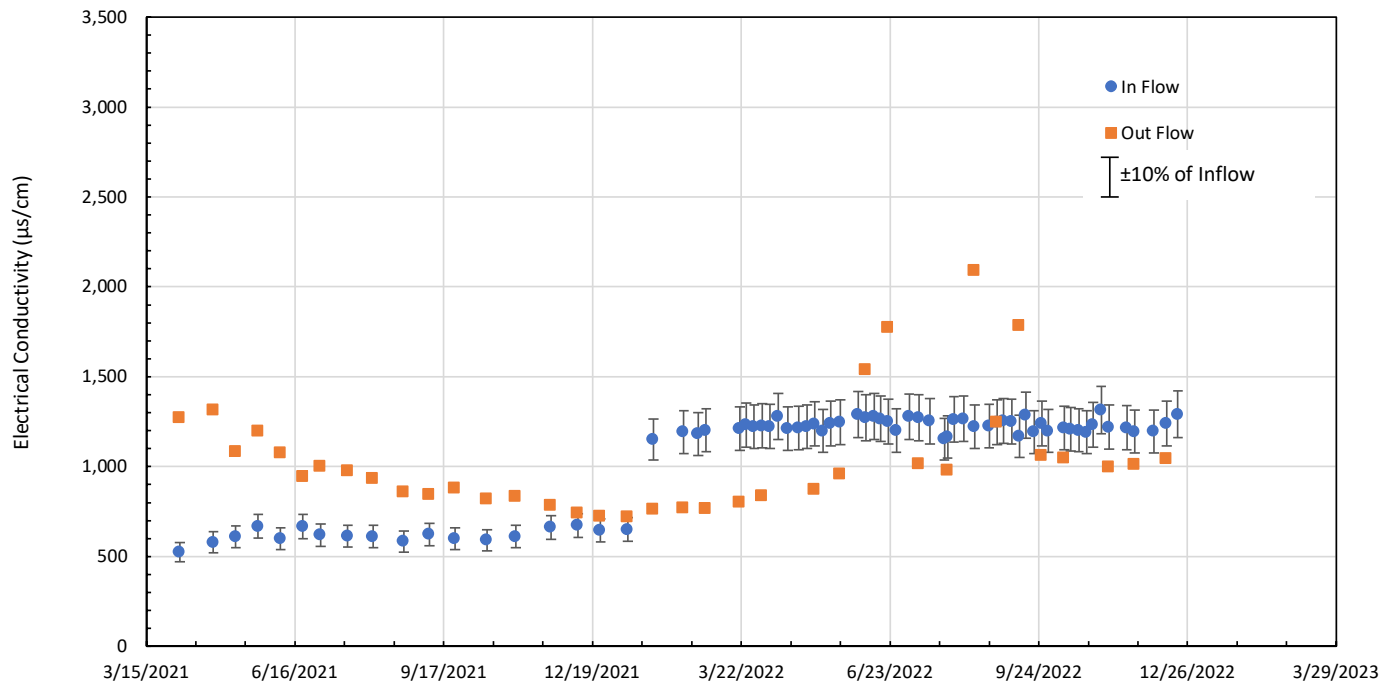

B2-ST-4 (47-49') Electrical Conductivity (EC) with Time	
BELLE RIVER POWER PLANT EAST CHINA TOWNSHIP, MICHIGAN	
 Geosyntec Consultants of Michigan	
Detroit, MI	Figure 3-16
April 2023	

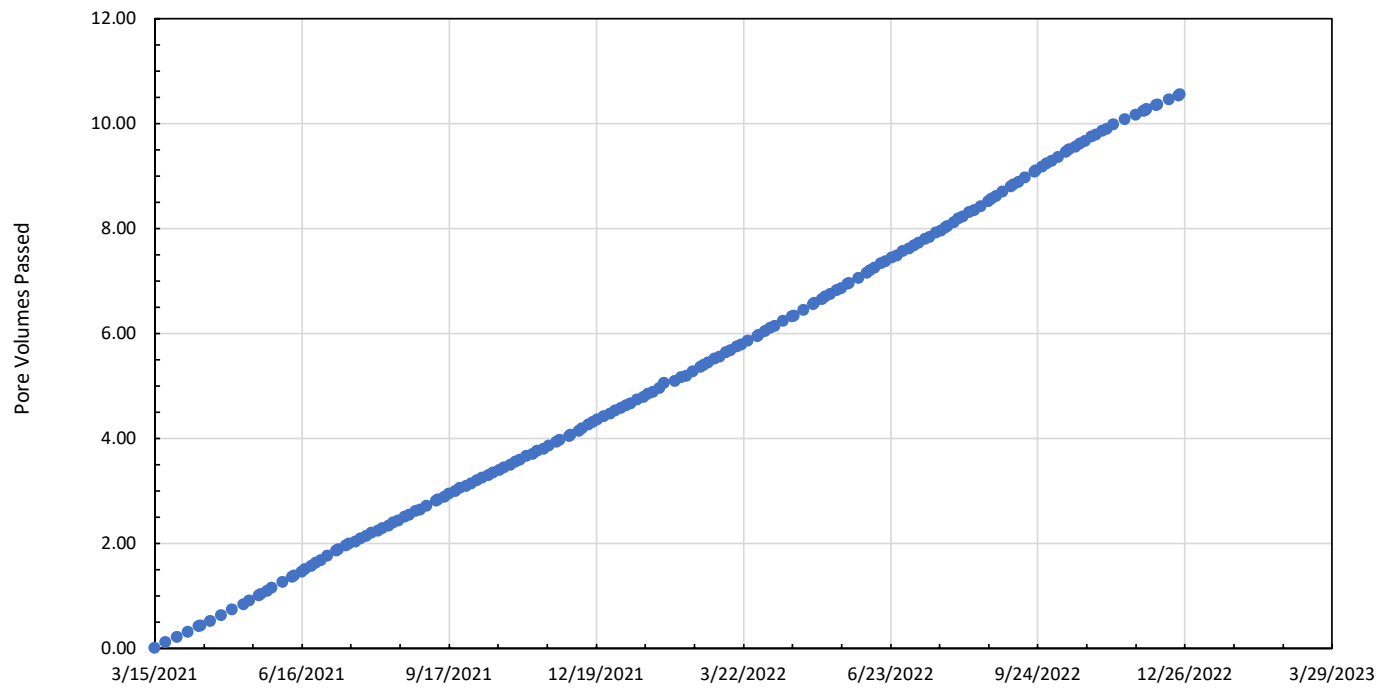

B3-ST-5 (77-79') PV Passed with Time

BELLE RIVER POWER PLANT
EAST CHINA TOWNSHIP, MICHIGAN





Figure

3-17

Detroit, MI

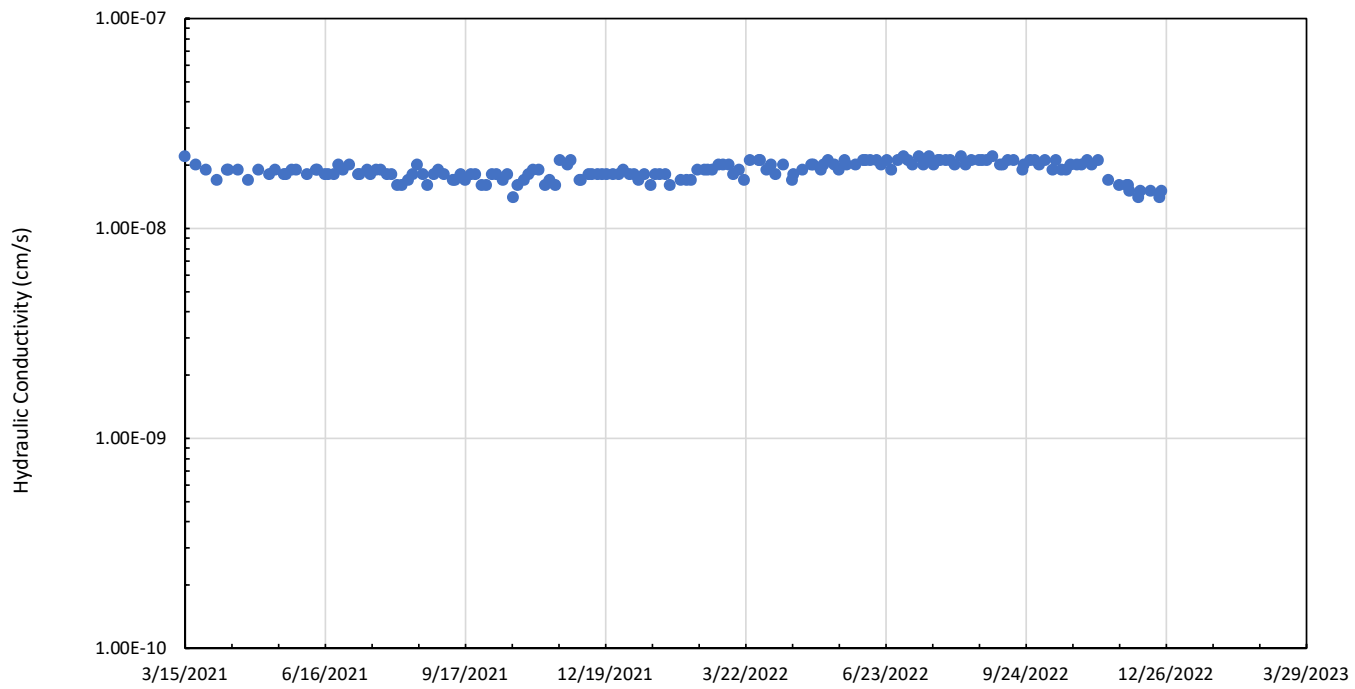
April 2023



B3-ST-5 (77-79') Hydraulic Conductivity with Time	
BELLE RIVER POWER PLANT EAST CHINA TOWNSHIP, MICHIGAN	
 <small>Geosyntec Consultants of Michigan</small>	
Detroit, MI	April 2023
Figure 3-18	

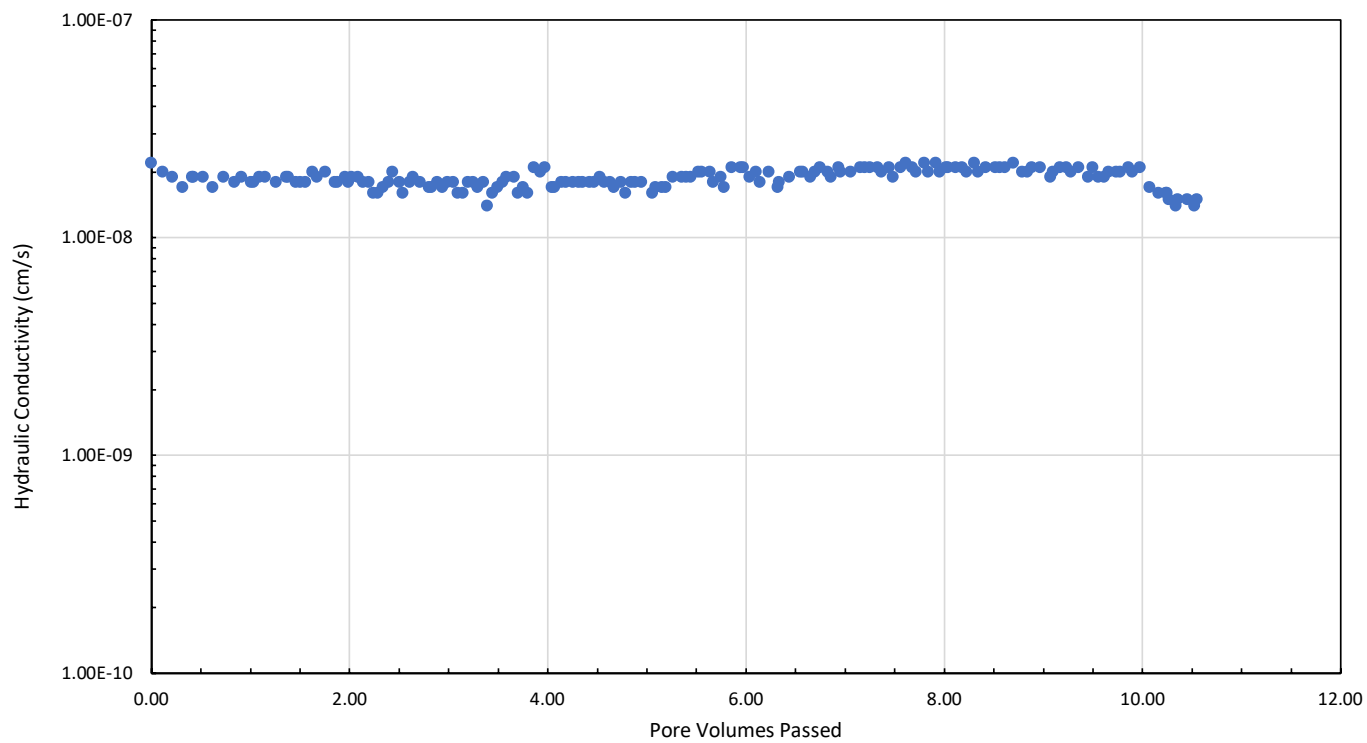

B3-ST-5 (77-79') Hydraulic Conductivity with PV	
BELLE RIVER POWER PLANT EAST CHINA TOWNSHIP, MICHIGAN	
	
<small>Geosyntec Consultants of Michigan</small>	
Detroit, MI	April 2023
Figure 3-19	

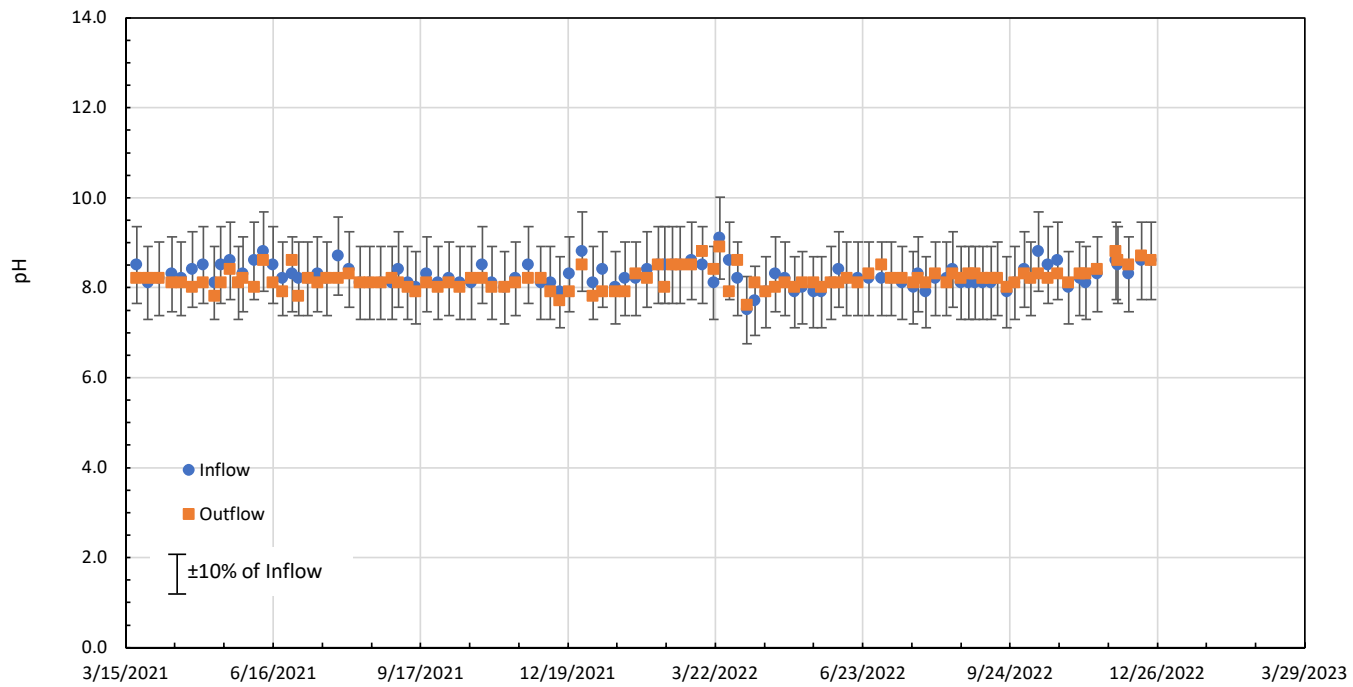

B3-ST-5 (77-79) pH of Inflow and Outflow with Time

BELLE RIVER POWER PLANT
EAST CHINA TOWNSHIP, MICHIGAN



Figure

3-20

Detroit, MI

April 2023

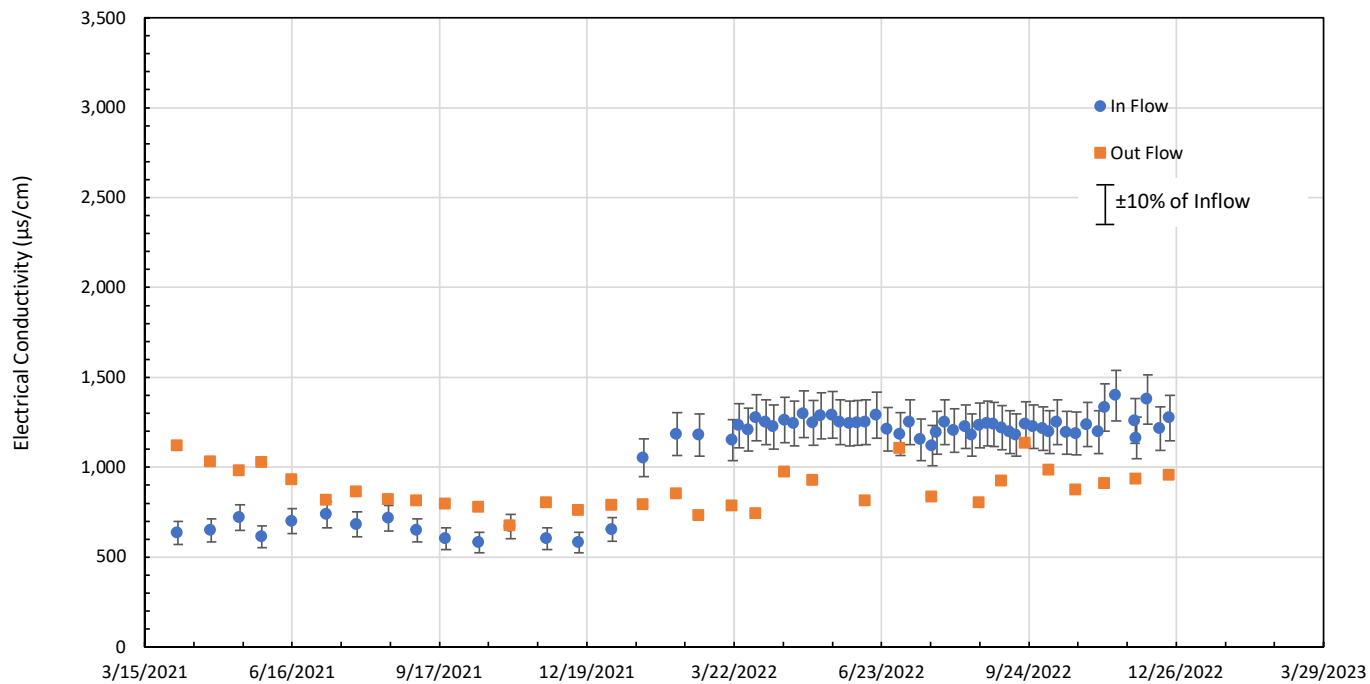

B3-ST-5 (77-79') Electrical Conductivity (EC) with Time	
BELLE RIVER POWER PLANT EAST CHINA TOWNSHIP, MICHIGAN	
 <small>Geosyntec Consultants of Michigan</small>	
Detroit, MI	April 2023
Figure 3-21	

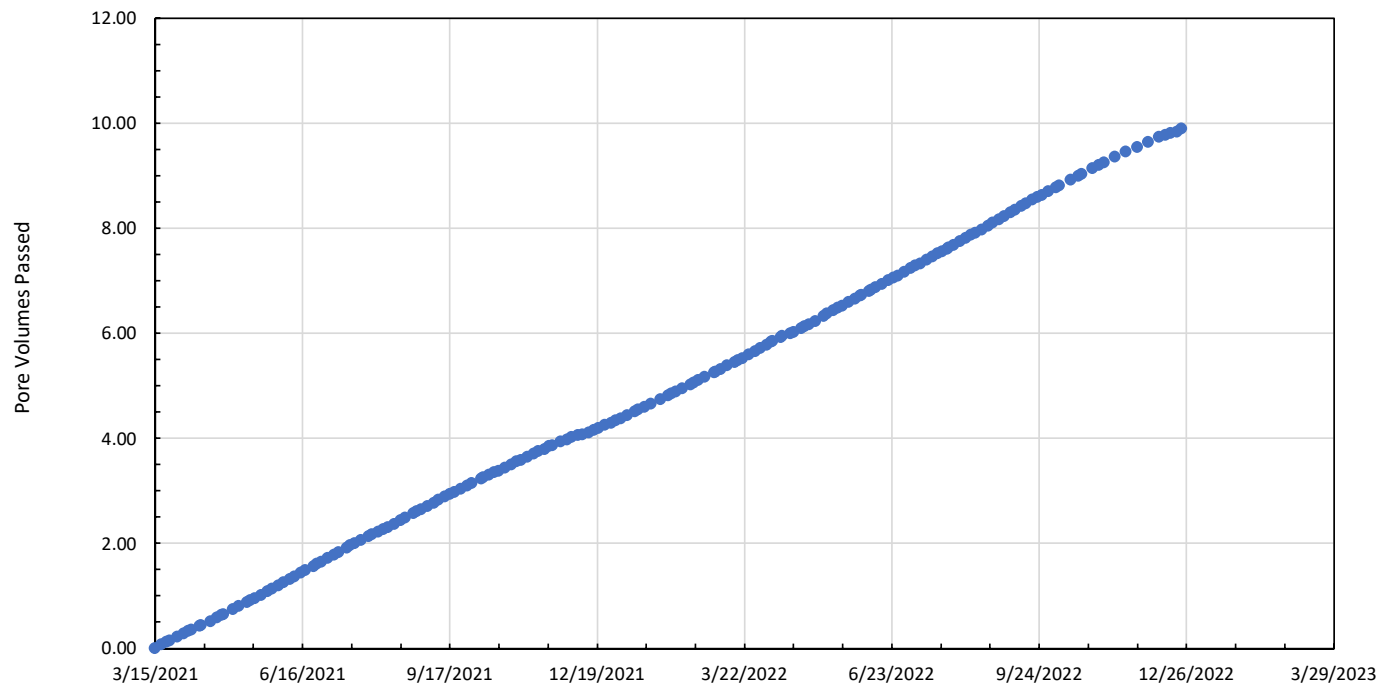

B4-ST-3 (47-49') PV Passed with Time

BELLE RIVER POWER PLANT
EAST CHINA TOWNSHIP, MICHIGAN





Figure

3-22

Detroit, MI

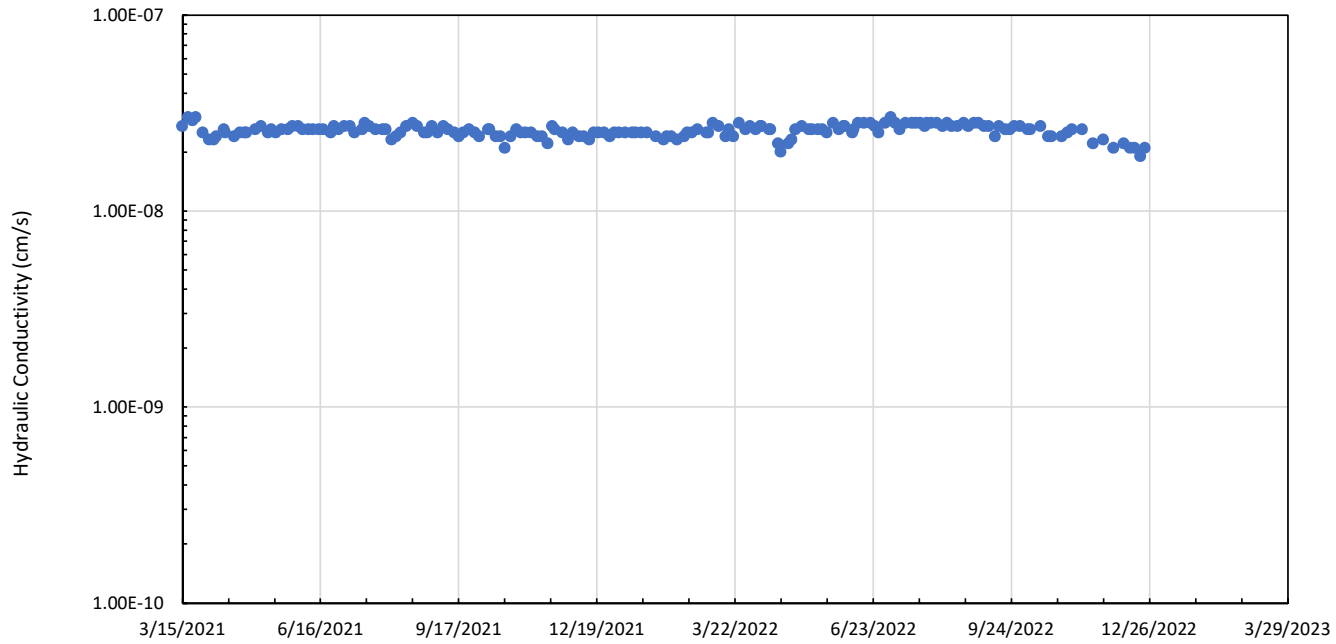
April 2023



B4-ST-3 (47-49') Hydraulic Conductivity with Time	
BELLE RIVER POWER PLANT EAST CHINA TOWNSHIP, MICHIGAN	
 <small>Geosyntec Consultants of Michigan</small>	
Detroit, MI	April 2023
Figure 3-23	

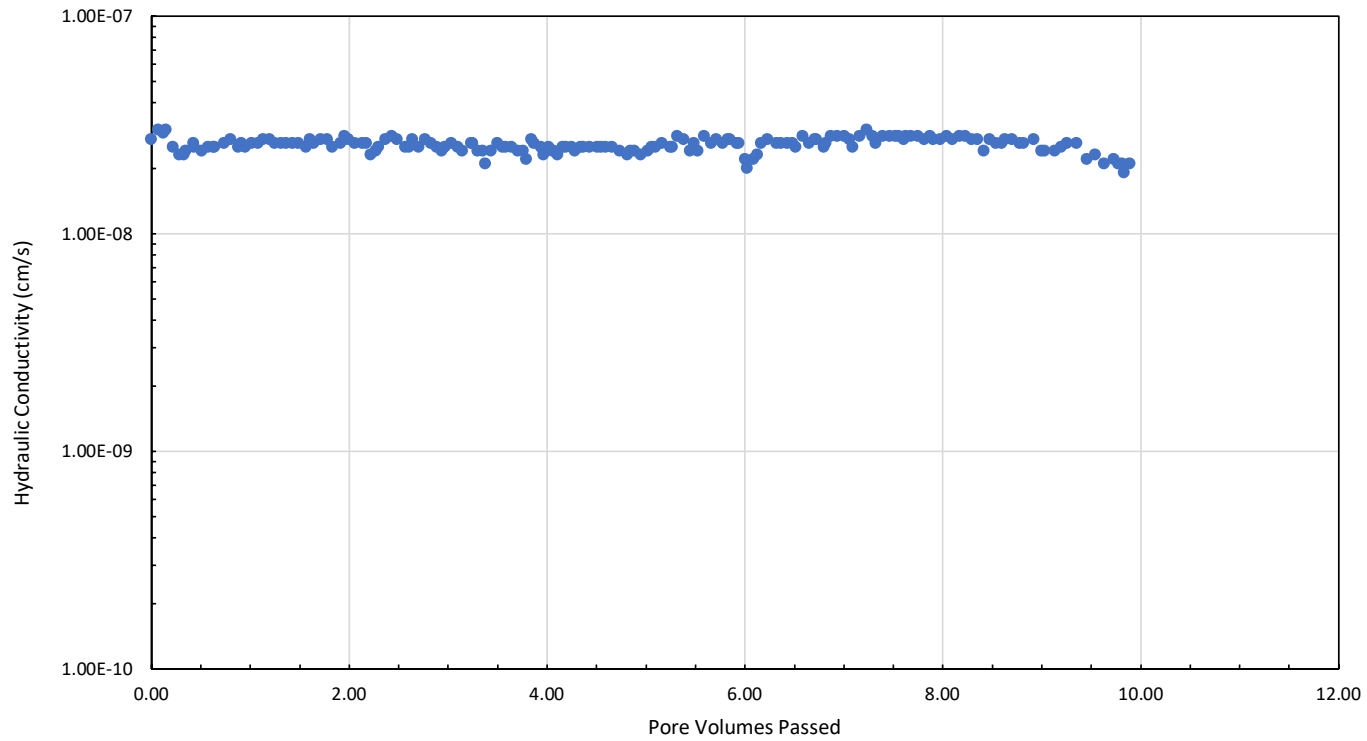

B4-ST-3 (47-49') Hydraulic Conductivity with PV	
BELLE RIVER POWER PLANT EAST CHINA TOWNSHIP, MICHIGAN	
 <small>Geosyntec Consultants of Michigan</small>	Figure
	3-24
Detroit, MI	April 2023

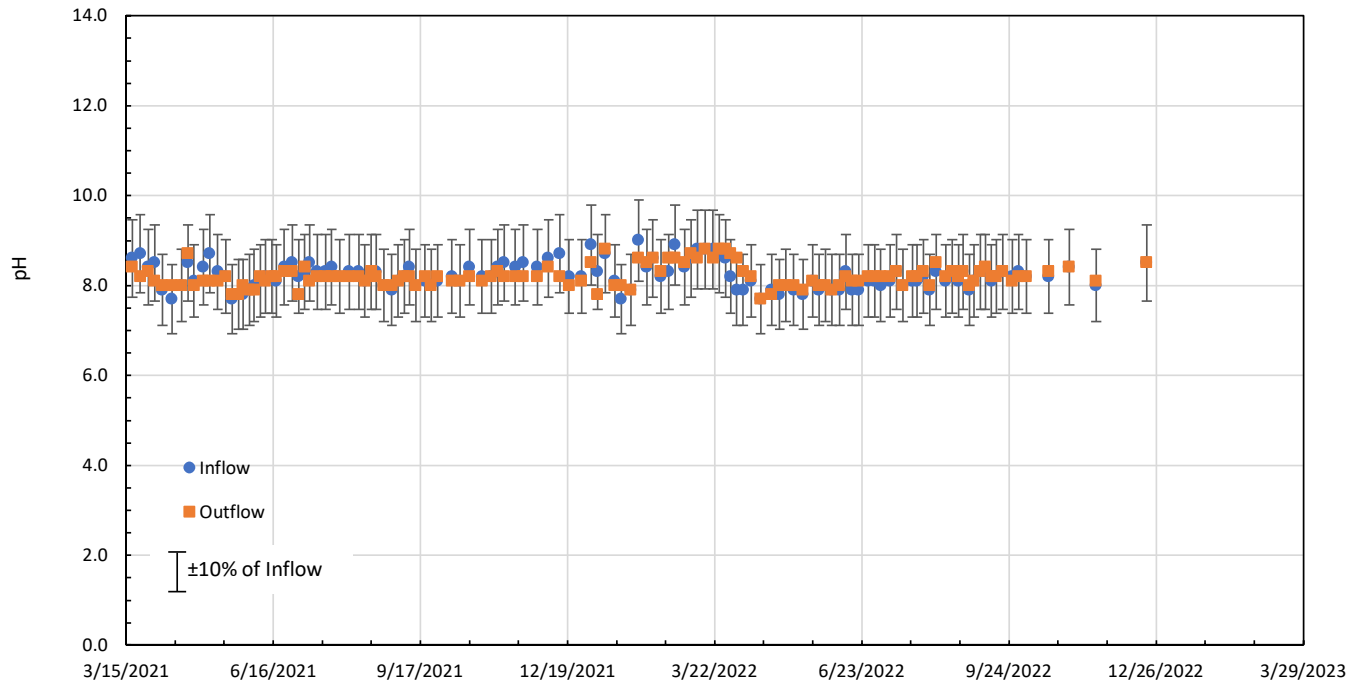

B4-ST-3 (47-49') pH of Inflow and Outflow with Time

BELLE RIVER POWER PLANT
EAST CHINA TOWNSHIP, MICHIGAN

Geosyntec
consultants
Geosyntec Consultants of Michigan

Detroit, MI April 2023

Figure 3-25

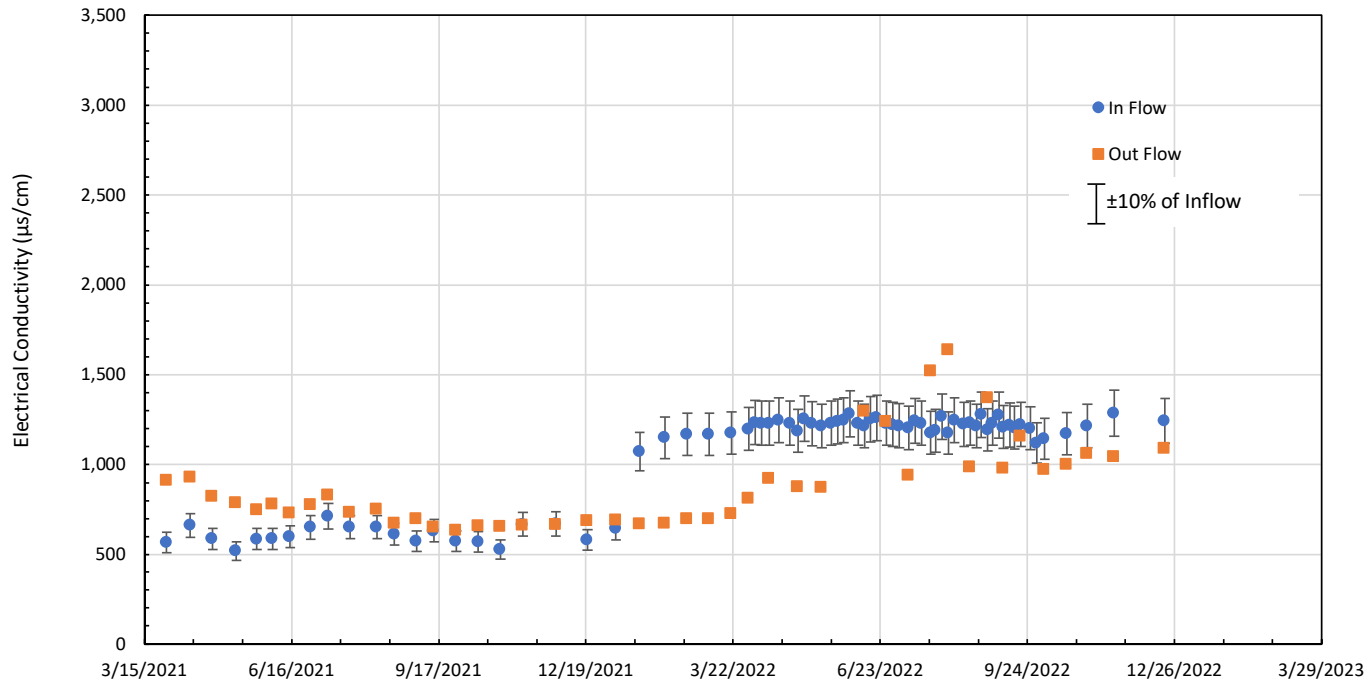

B4-ST-3 (47-49') Electrical Conductivity (EC) with Time

BELLE RIVER POWER PLANT
EAST CHINA TOWNSHIP, MICHIGAN



Figure

3-26

Detroit, MI

April 2023

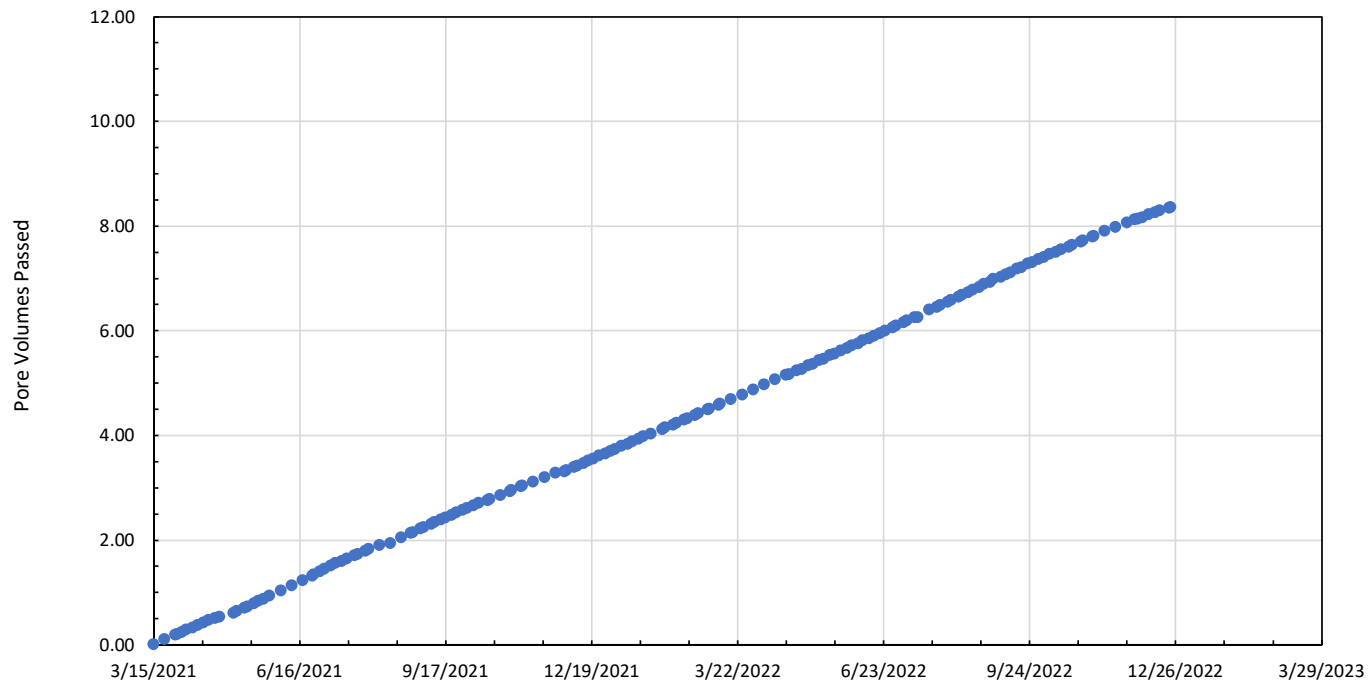

B5-ST-5 (87-89') PV Passed with Time

BELLE RIVER POWER PLANT
EAST CHINA TOWNSHIP, MICHIGAN





Figure

3-27

Detroit, MI

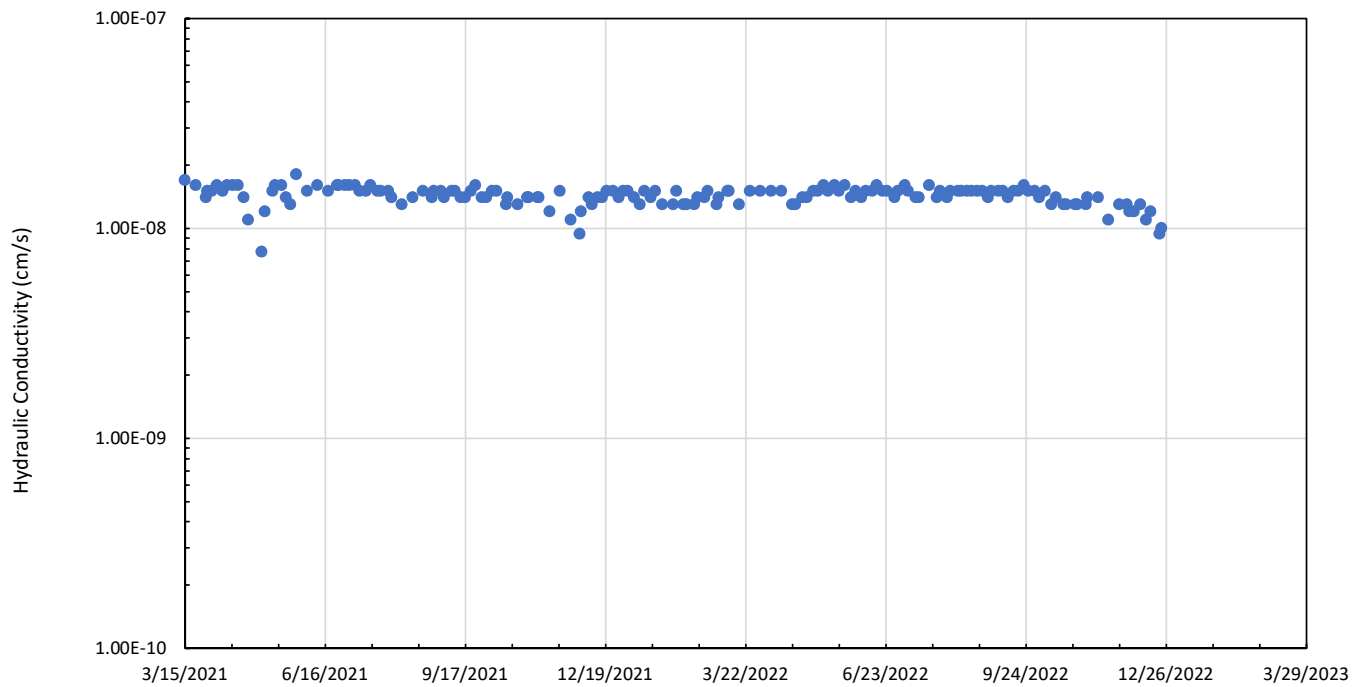
April 2023



B5-ST-5 (87-89') Hydraulic Conductivity with Time	
BELLE RIVER POWER PLANT EAST CHINA TOWNSHIP, MICHIGAN	
 <small>Geosyntec Consultants of Michigan</small>	
Detroit, MI	April 2023
Figure 3-28	

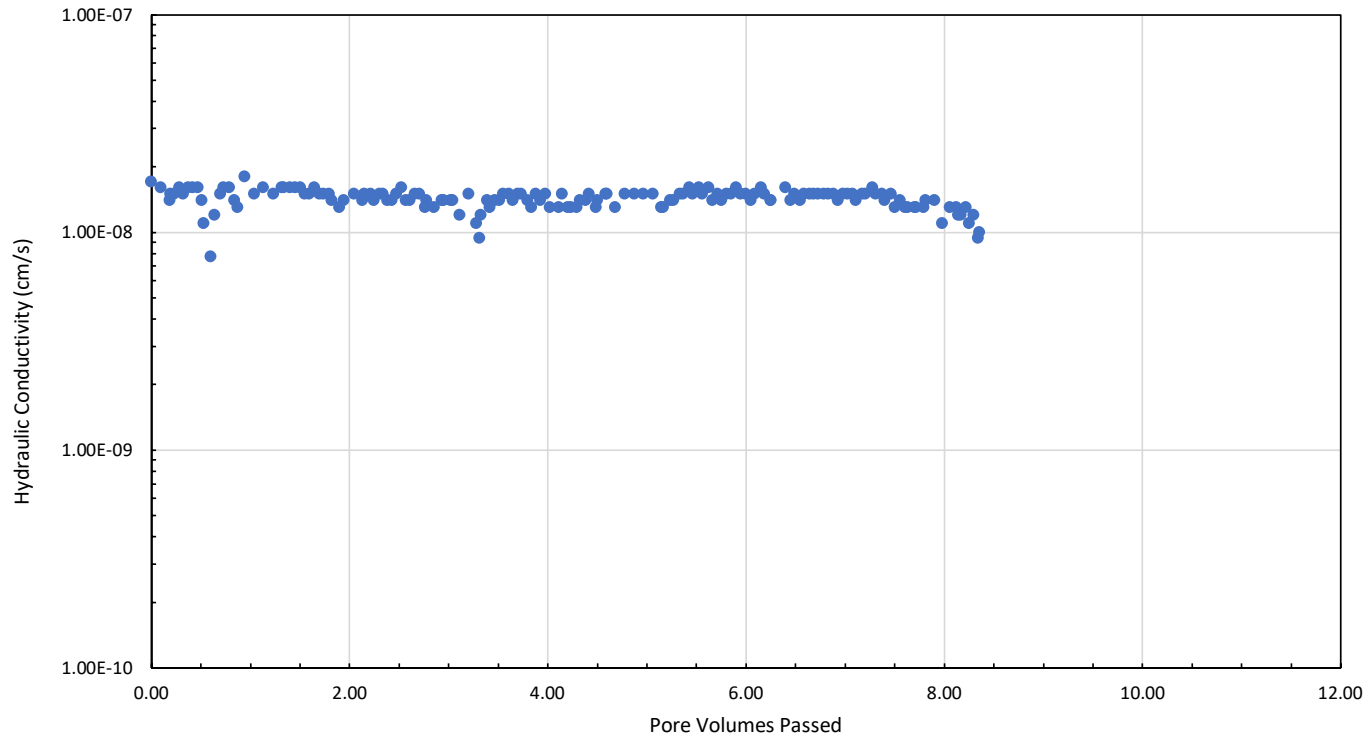

B5-ST-5 (87-89') Hydraulic Conductivity with PV

BELLE RIVER POWER PLANT
EAST CHINA TOWNSHIP, MICHIGAN



Figure

3-29

Detroit, MI

April 2023

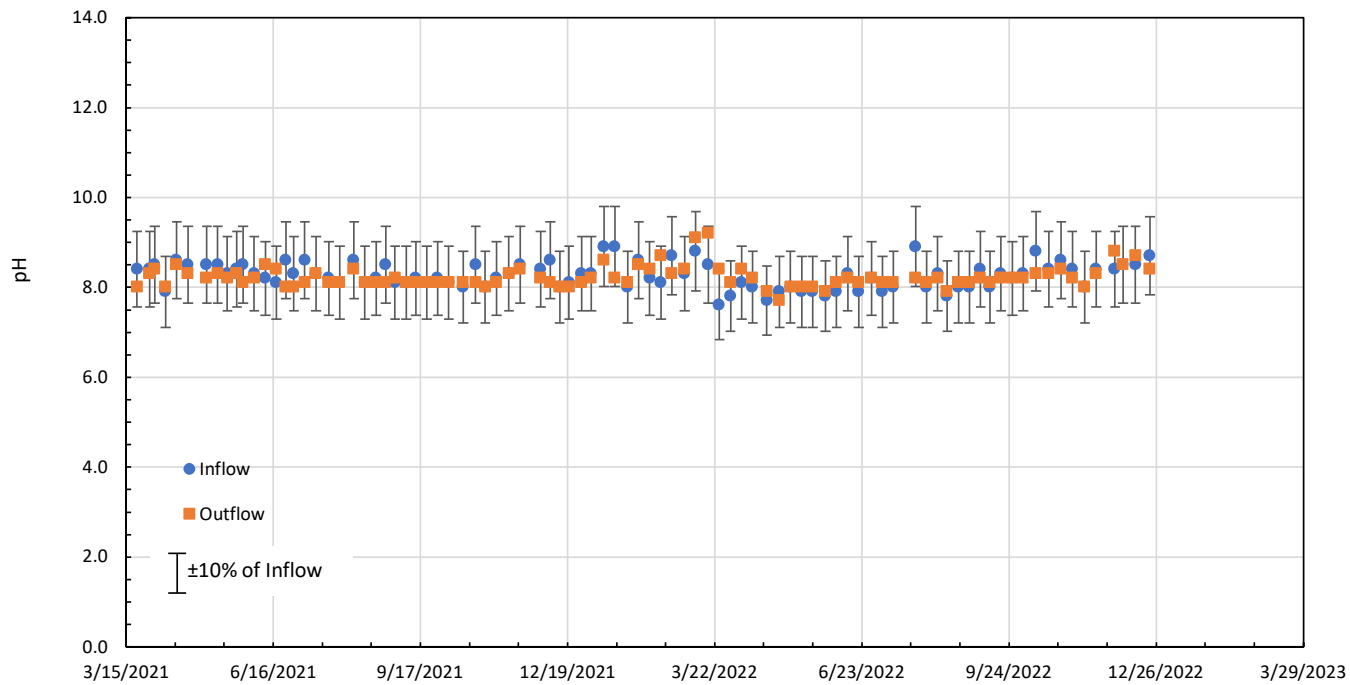



B5-ST-5 (87-89') pH of Inflow and Outflow with Time

BELLE RIVER POWER PLANT
EAST CHINA TOWNSHIP, MICHIGAN

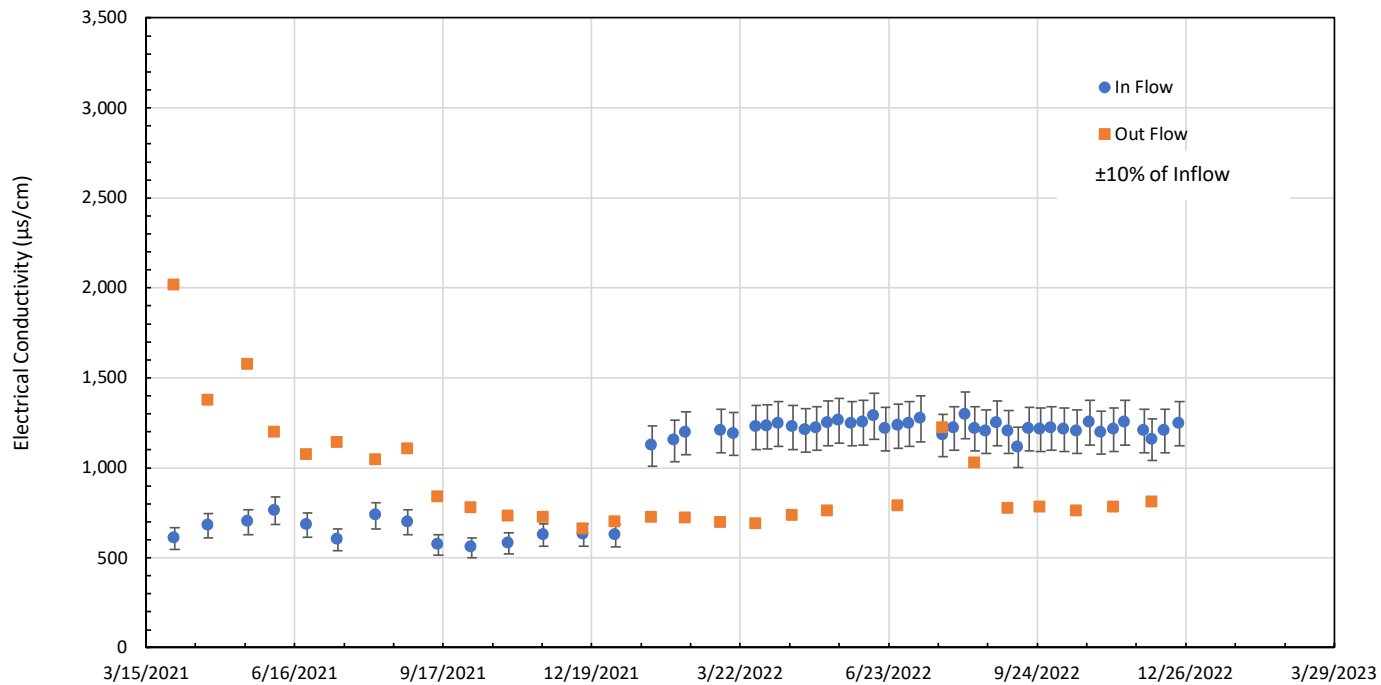

Figure
3-30





B5-ST-5 (87-89') Electrical Conductivity (EC) with Time	
BELLE RIVER POWER PLANT EAST CHINA TOWNSHIP, MICHIGAN	
 <small>Geosyntec Consultants of Michigan</small>	
Detroit, MI	Figure 3-31
April 2023	

CLAY LAYER - LAYER 1		
INPUT PARAMETER	UNITS	VALUE
DARCY VELOCITY	M/YR	7.24E-03
TOTAL THICKNESS	METERS	11.13
COEFFICIENT OF HYDODYNAMIC DISPERSION	M ² /a	0.019
EFFECTIVE POROSITY		0.42
DENSITY	KG/M3	1509
DISTRIBUTION COEFFICIENT	M ³ /KG	0
DEGRADATION		0

CLAY WITH SAND LAYER - LAYER 2		
INPUT PARAMETER	UNITS	VALUE
DARCY VELOCITY	M/YR	7.24E-03
TOTAL THICKNESS	METERS	25.66
COEFFICIENT OF HYDODYNAMIC DISPERSION	M ² /a	0.019
EFFECTIVE POROSITY		0.51
DENSITY	KG/M3	1509
DISTRIBUTION COEFFICIENT	M ³ /KG	0
DEGRADATION		0

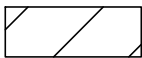
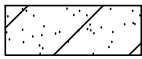
LEGEND

-  CLAY UNIT
-  CLAY WITH SAND UNIT
-  UPPER MOST AQUIFER

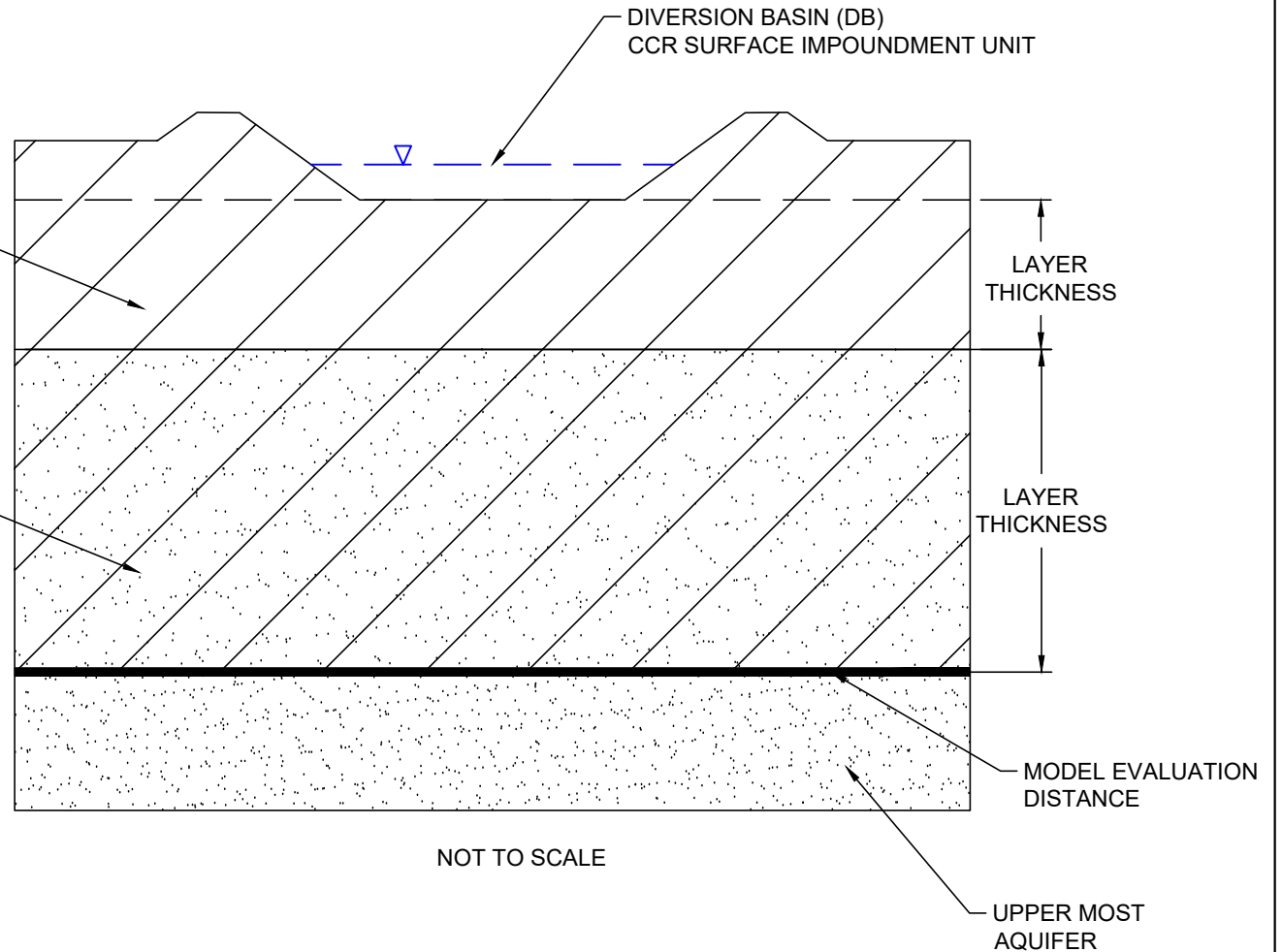

FATE AND TRANSPORT
CONCEPTUAL MODEL
BELLE RIVER ALD - DB

Geosyntec
consultants
Geosyntec Consultants of Michigan

FIGURE
4-1

PROJECT NO:

April 2023

**APPENDIX A – MONITORING WELL SLUG TEST
RESULTS**

2016 Slug Test Results

Hydraulic Conductivity Results
DTE Electric Company Belle River Power Plant
ChinaTownship, Michigan

Test Location ID	Date Performed	Test Type	Hydraulic Conductivity (K)	
			cm/sec	ft/day
MW-16-01b	3/1/2016	Falling Head	3.58E-04	1.015
		Rising Head	2.72E-04	0.770
		Average	3.15E-04	0.892
MW-16-04	3/1/2016	Falling Head	7.93E-05	0.225
		Rising Head	4.11E-05	0.116
		Average	6.02E-05	0.171
MW-16-05	3/1/2016	Falling Head	4.26E-05	0.121
		Rising Head	2.13E-05	0.060
		Average	3.19E-05	0.090
MW-16-07	3/1/2016	Falling Head	1.24E-04	0.350
		Rising Head	7.21E-05	0.204
		Average	9.79E-05	0.277
Minimum			3.19E-05	9.05E-02
Maximum			3.15E-04	8.92E-01
Geometric Mean			8.77E-05	0.249

Conversion:

$$\frac{1 \text{ cm}}{1 \text{ sec}} \times \frac{86,400 \text{ sec}}{1 \text{ day}} \times \frac{1 \text{ ft}}{30.48 \text{ cm}} = 2.83\text{E}+03 \frac{\text{ft}}{\text{day}}$$

Notes:

Slug test results calculated using the Bower-Rice (1976) Solution.

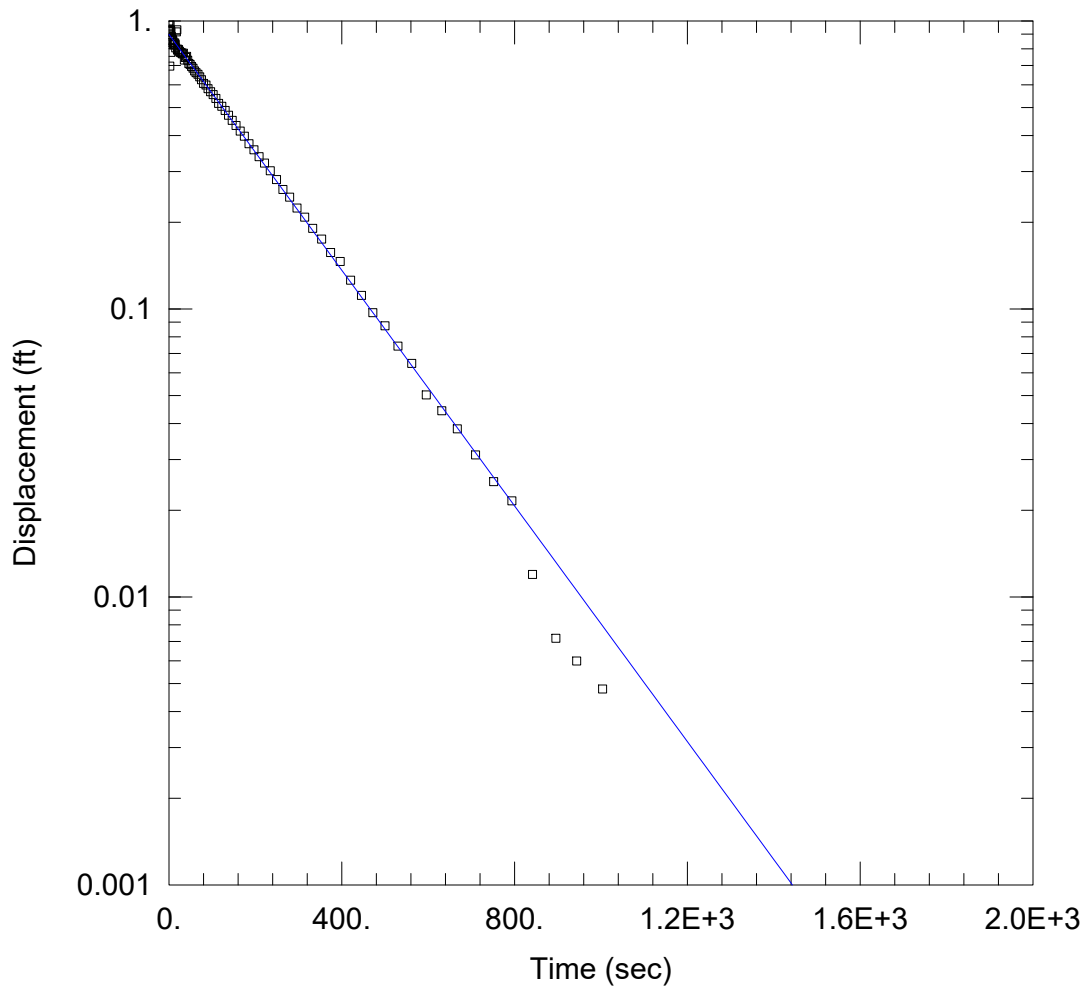

MW-16-01 FALLING HEAD SLUG TEST

Data Set: P:\...\MW-16-01_IN.aqt
 Date: 05/22/17

Time: 13:38:07

PROJECT INFORMATION

Company: TRC Environmental Corporation
 Client: DTE EC BRPP CCR
 Project: 231828.0003.0000
 Location: China Township, MI
 Test Well: MW-16-01
 Test Date: 4/13/16

AQUIFER DATA

Saturated Thickness: 52. ft

Anisotropy Ratio (Kz/Kr): 1.

WELL DATA (MW-16-01)

Initial Displacement: 0.835 ft
 Total Well Penetration Depth: 84.12 ft
 Casing Radius: 0.08333 ft

Static Water Column Height: 84.12 ft
 Screen Length: 5. ft
 Well Radius: 0.08333 ft

SOLUTION

Aquifer Model: Confined
 K = 0.0003581 cm/sec

Solution Method: Bowser-Rice
 y0 = 0.7491 ft

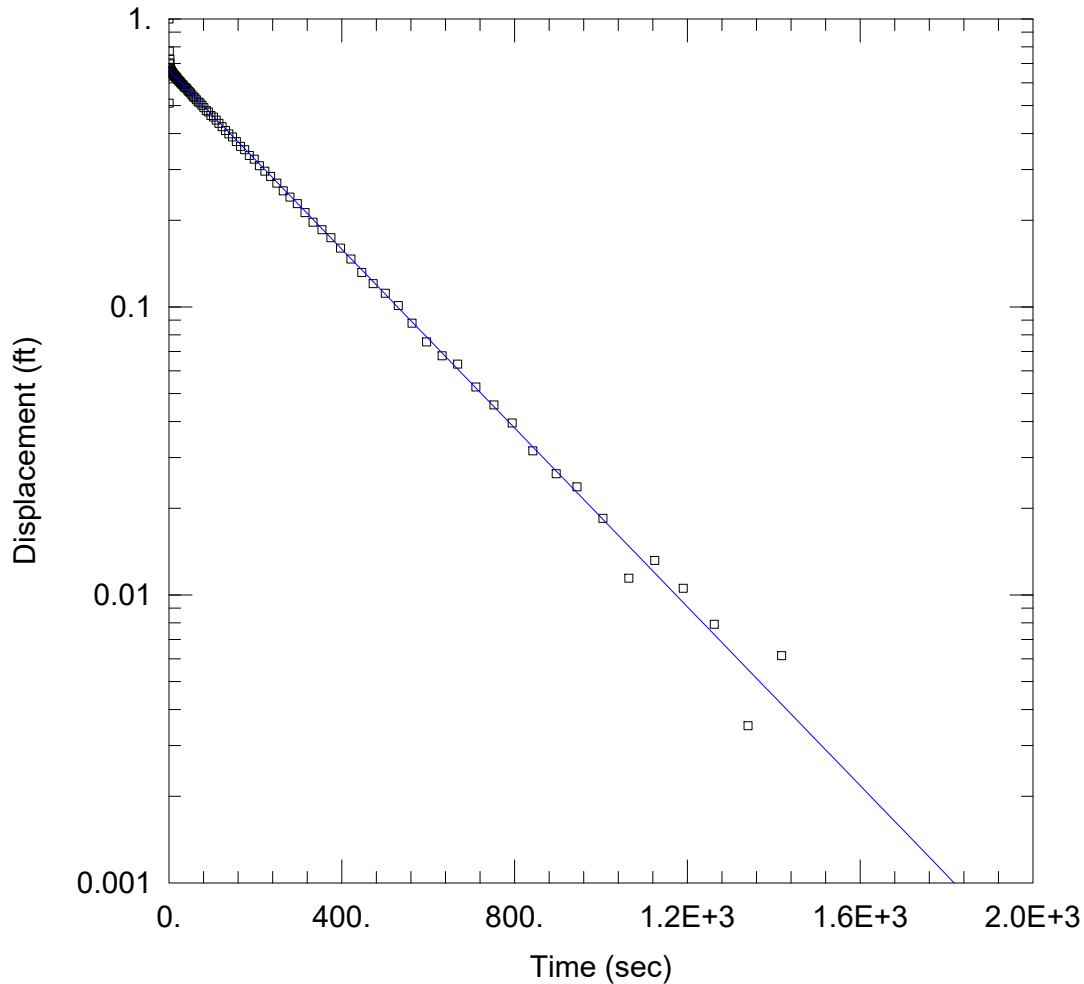

MW-16-01 RISING HEAD SLUG TEST

Data Set: P:\...\MW-16-01_OUT.aqt
 Date: 05/22/17

Time: 13:40:08

PROJECT INFORMATION

Company: TRC Environmental Corporation
 Client: DTE EC BRPP CCR
 Project: 231828.0003.0000
 Location: China Township, MI
 Test Well: MW-16-01
 Test Date: 4/13/16

AQUIFER DATA

Saturated Thickness: 52. ft

Anisotropy Ratio (Kz/Kr): 1.

WELL DATA (MW-16-01)

Initial Displacement: 1.138 ft
 Total Well Penetration Depth: 84.07 ft
 Casing Radius: 0.08333 ft

Static Water Column Height: 84.07 ft
 Screen Length: 5. ft
 Well Radius: 0.08333 ft

SOLUTION

Aquifer Model: Confined
 K = 0.0002716 cm/sec

Solution Method: Bowser-Rice
 y0 = 0.7541 ft

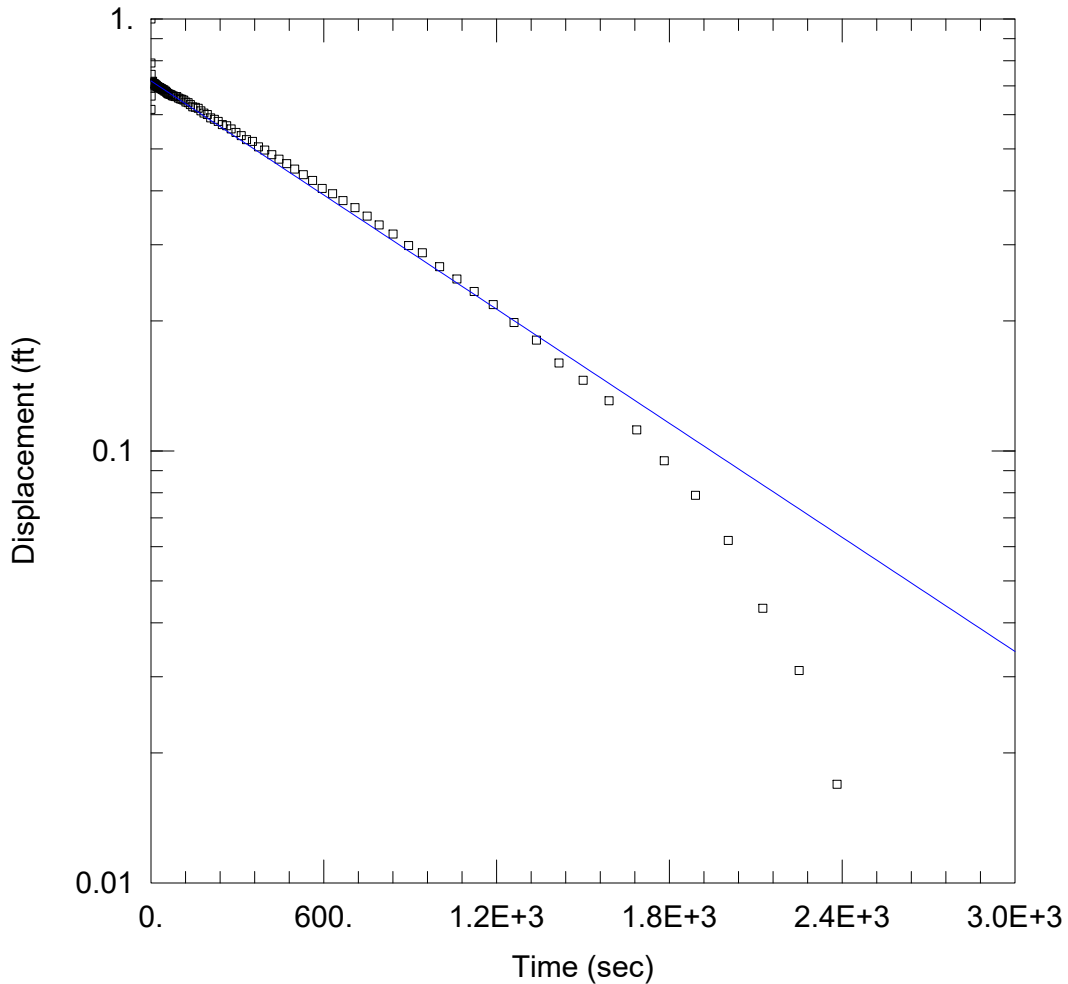

MW-16-04 FALLING HEAD SLUG TEST

Data Set: P:\...\MW-16-04_IN.aqt
 Date: 05/22/17

Time: 13:41:00

PROJECT INFORMATION

Company: TRC Environmental Corporation
 Client: DTE EC BRPP CCR
 Project: 231828.0003.0000
 Location: China Township, MI
 Test Well: MW-16-04
 Test Date: 4/13/16

AQUIFER DATA

Saturated Thickness: 23.5 ft

Anisotropy Ratio (Kz/Kr): 1.

WELL DATA (MW-16-04)

Initial Displacement: 1.064 ft
 Total Well Penetration Depth: 109.9 ft
 Casing Radius: 0.08333 ft

Static Water Column Height: 109.9 ft
 Screen Length: 5. ft
 Well Radius: 0.08333 ft

SOLUTION

Aquifer Model: Confined
 K = 7.93E-5 cm/sec

Solution Method: Bowser-Rice
 y0 = 0.7646 ft

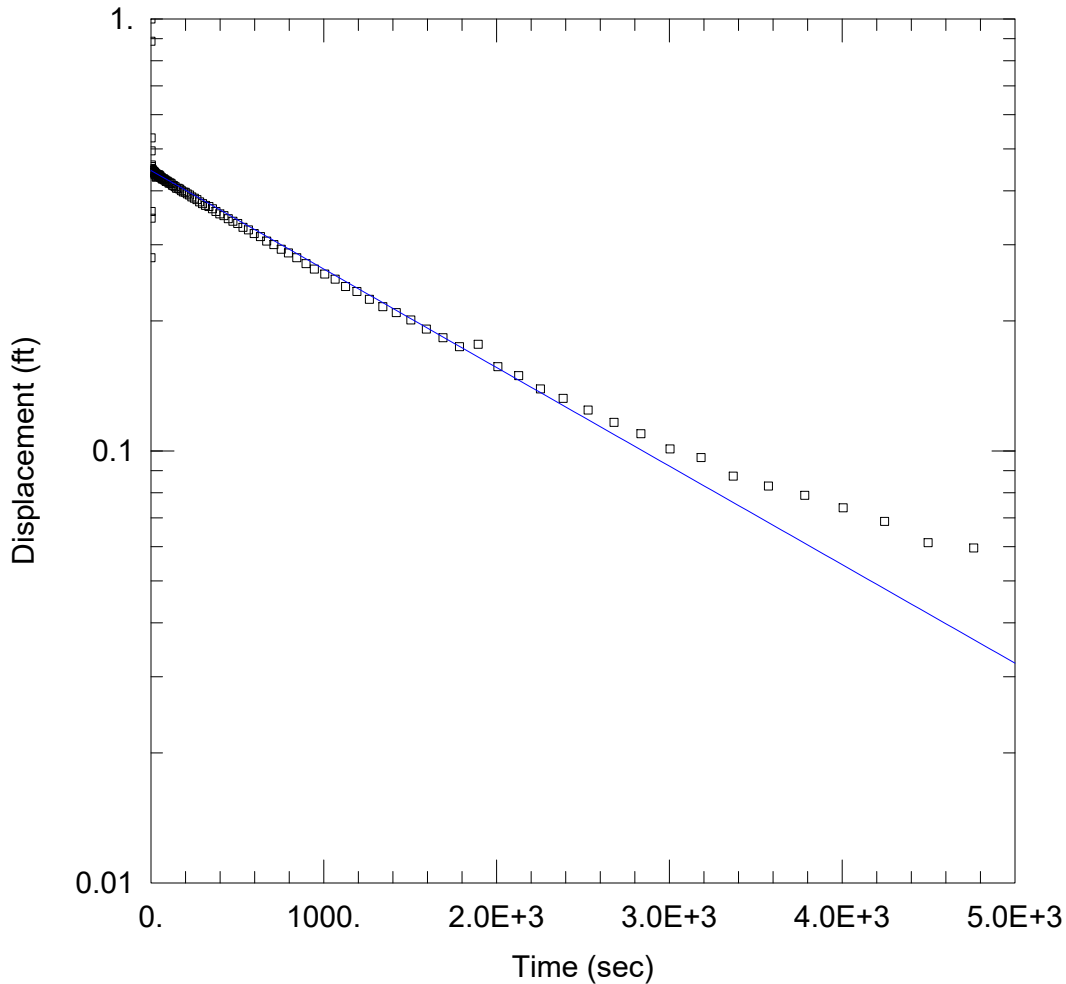

MW-16-04 RISING HEAD SLUG TEST

Data Set: P:\...\MW-16-04_OUT.aqt
 Date: 05/22/17

Time: 13:42:08

PROJECT INFORMATION

Company: TRC Environmental Corporation
 Client: DTE EC BRPP CCR
 Project: 231828.0003.0000
 Location: China Township, MI
 Test Well: MW-16-04
 Test Date: 4/13/16

AQUIFER DATA

Saturated Thickness: 23.5 ft Anisotropy Ratio (Kz/Kr): 1.

WELL DATA (MW-16-04)

Initial Displacement: 1.761 ft Static Water Column Height: 109.7 ft
 Total Well Penetration Depth: 109.7 ft Screen Length: 5. ft
 Casing Radius: 0.08333 ft Well Radius: 0.08333 ft

SOLUTION

Aquifer Model: Confined Solution Method: Bowser-Rice
 K = 4.108E-5 cm/sec y0 = 0.7851 ft

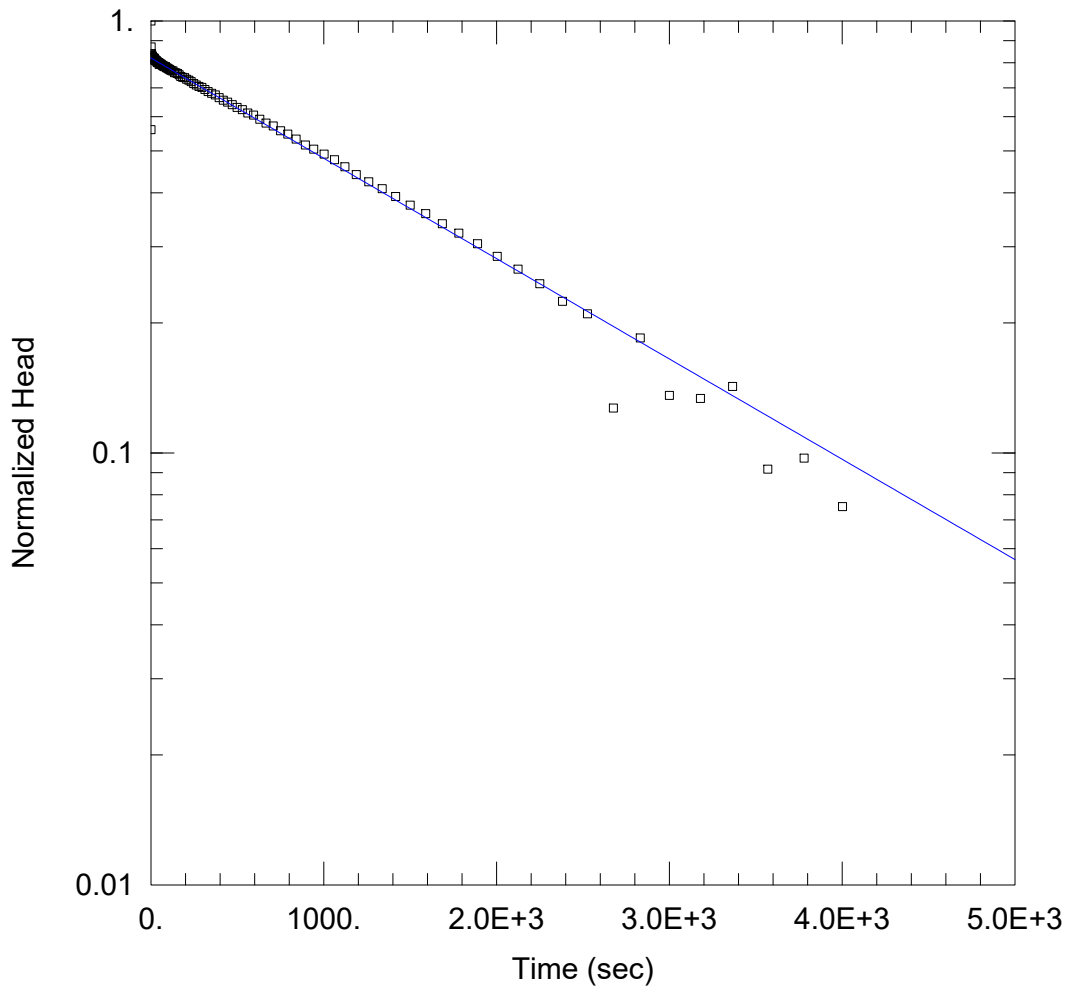

MW-16-05 FALLING HEAD SLUG TEST

Data Set: P:\...\MW-16-05_IN.aqt
 Date: 05/22/17

Time: 13:42:57

PROJECT INFORMATION

Company: TRC Environmental Corporation
 Client: DTE EC BRPP CCR
 Project: 231828.0003
 Location: China Township, MI
 Test Well: MW-16-05
 Test Date: 4/13/16

AQUIFER DATA

Saturated Thickness: 7. ft Anisotropy Ratio (Kz/Kr): 1.

WELL DATA (MW-16-05)

Initial Displacement: <u>0.905 ft</u>	Static Water Column Height: <u>130.7 ft</u>
Total Well Penetration Depth: <u>130.7 ft</u>	Screen Length: <u>5. ft</u>
Casing Radius: <u>0.08333 ft</u>	Well Radius: <u>0.08333 ft</u>

SOLUTION

Aquifer Model: <u>Confined</u>	Solution Method: <u>Bower-Rice</u>
K = <u>4.258E-5 cm/sec</u>	y0 = <u>0.7426 ft</u>

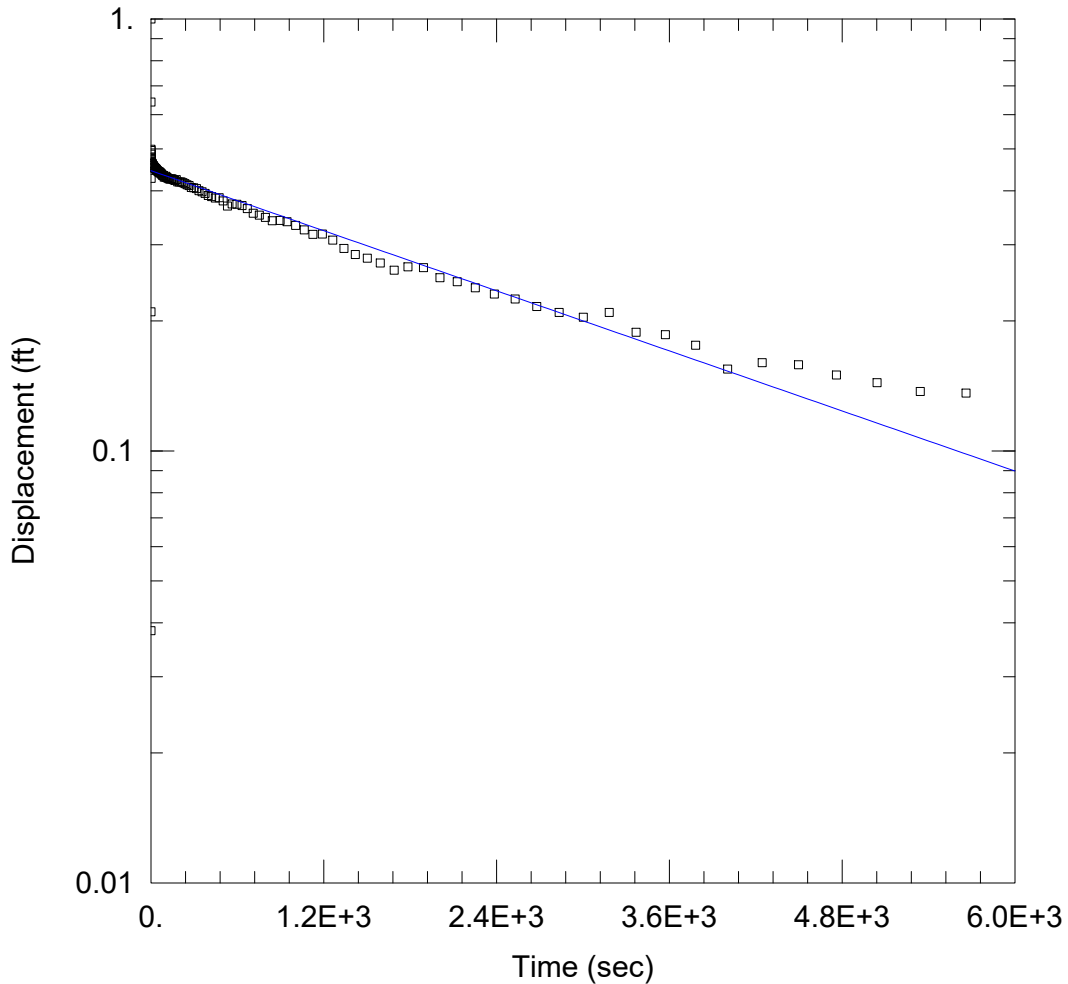

MW-16-05 RISING HEAD SLUG TEST

Data Set: P:\...\MW-16-05_OUT.aqt
 Date: 05/22/17

Time: 13:43:26

PROJECT INFORMATION

Company: TRC Environmental Corporation
 Client: DTE EC BRPP CCR
 Project: 231828.0003.0000
 Location: China Township, MI
 Test Well: MW-16-05
 Test Date: 4/13/16

AQUIFER DATA

Saturated Thickness: 7. ft

Anisotropy Ratio (Kz/Kr): 1.

WELL DATA (MW-16-05)

Initial Displacement: 1.668 ft
 Total Well Penetration Depth: 130.7 ft
 Casing Radius: 0.08333 ft

Static Water Column Height: 130.7 ft
 Screen Length: 5. ft
 Well Radius: 0.08333 ft

SOLUTION

Aquifer Model: Confined
 K = 2.125E-5 cm/sec

Solution Method: Bowser-Rice
 y0 = 0.743 ft

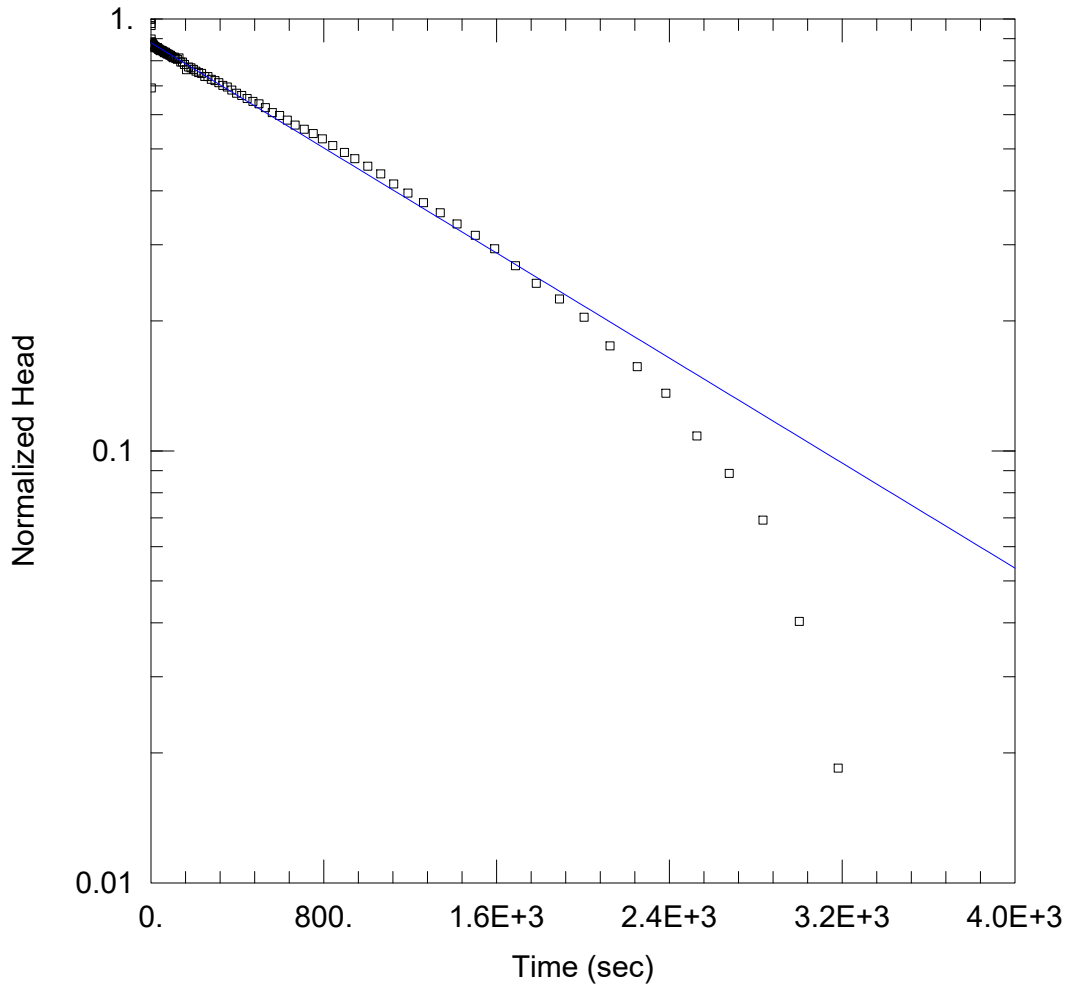

MW-16-07 FALLING HEAD SLUG TEST

Data Set: P:\...\MW-16-07_IN.aqt
 Date: 05/22/17

Time: 13:44:03

PROJECT INFORMATION

Company: TRC Environmental Corporation
 Client: DTE EC BRPP CCR
 Project: 231828.0003
 Location: China Township, MI
 Test Well: MW-16-07
 Test Date: 4/13/16

AQUIFER DATA

Saturated Thickness: 2. ft Anisotropy Ratio (Kz/Kr): 1.

WELL DATA (MW-16-07)

Initial Displacement: 0.868 ft Static Water Column Height: 124.9 ft
 Total Well Penetration Depth: 124.9 ft Screen Length: 5. ft
 Casing Radius: 0.08333 ft Well Radius: 0.08333 ft

SOLUTION

Aquifer Model: Confined Solution Method: Bowser-Rice
 K = 0.0001236 cm/sec y₀ = 0.7638 ft

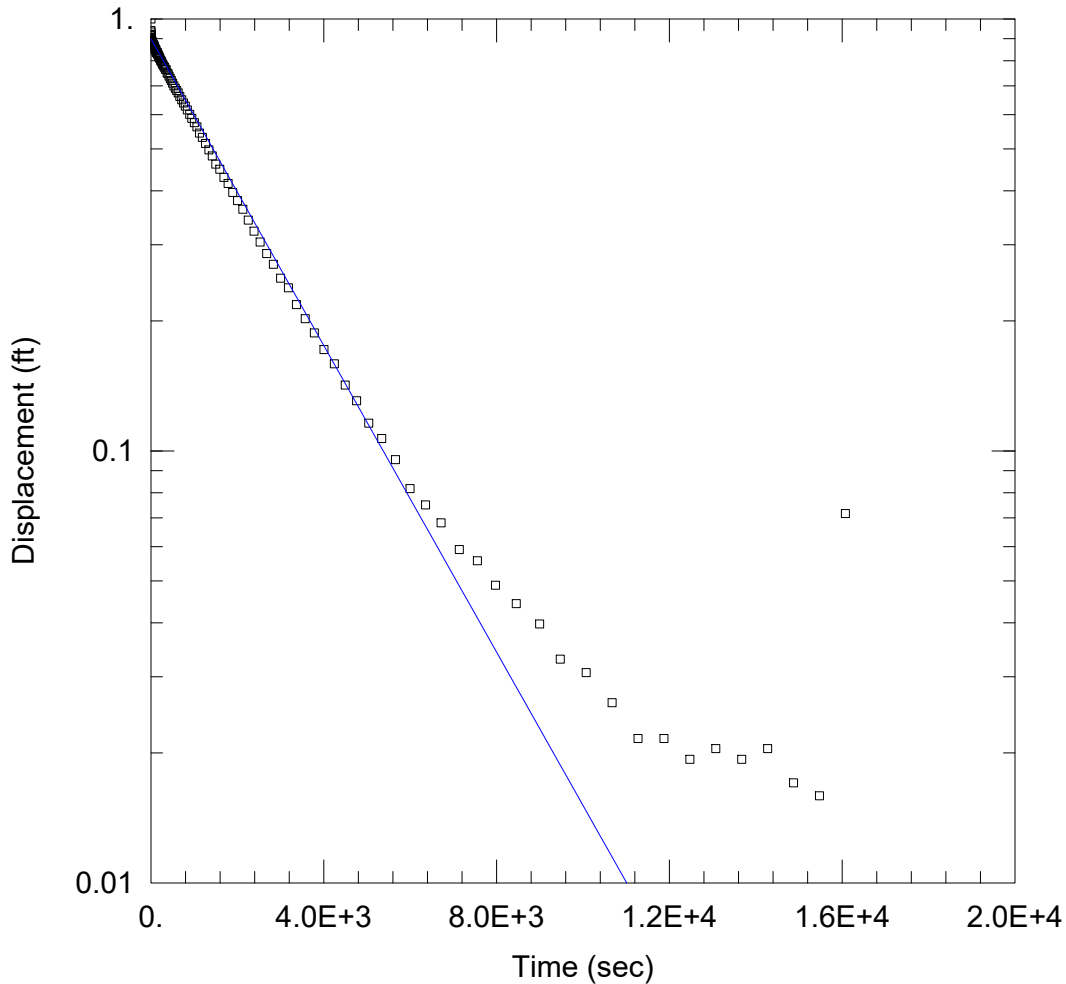

MW-16-07 RISING HEAD SLUG TEST

Data Set: P:\...\MW-16-07_OUT.aqt
 Date: 05/22/17

Time: 13:44:45

PROJECT INFORMATION

Company: TRC Environmental Corporation
 Client: DTE EC BRPP CCR
 Project: 231828.0003.0000
 Location: China Township, MI
 Test Well: MW-16-07
 Test Date: 4/13/16

AQUIFER DATA

Saturated Thickness: 2. ft

Anisotropy Ratio (Kz/Kr): 1.

WELL DATA (MW-16-07)

Initial Displacement: 0.88 ft
 Total Well Penetration Depth: 124.4 ft
 Casing Radius: 0.08333 ft

Static Water Column Height: 124.4 ft
 Screen Length: 5. ft
 Well Radius: 0.08333 ft

SOLUTION

Aquifer Model: Confined
 K = 7.212E-5 cm/sec

Solution Method: Bouwer-Rice
 y0 = 0.7909 ft

2021 Slug Test Results

2021 Hydraulic Conductivity Results Summary
DTE Electric Company Belle River Power Plant Bottom Ash Basins and Diversion Basin
4505 King Road, China Township, Michigan

Test	WC (ft)	K (cm/s)	K (ft/day)	Comment/K Geometric mean (cm/s)	K Geometric mean (ft/day)
MW-16-02 Slug In	85.8	NA	NA	Not a good match, use slug out test	NA
MW-16-02 Slug Out	85.8	4.2E-04	1.2	4.2E-04	1.2
MW-16-03 Slug In	123.1	9.8E-03	27.8	9.6E-03	27.4
MW-16-03 Slug Out	123.1	9.5E-03	26.9		
MW-16-06 Slug In	125.6	1.0E-04	0.28	1.0E-04	0.30
MW-16-06 Slug Out	125.6	1.1E-04	0.31		
MW-16-08 Slug In	124.9	1.2E-05	0.03	1.1E-05	0.03
MW-16-08 Slug Out	124.9	1.1E-05	0.03		
MW-16-09 Slug In	126.9	1.5E-04	0.43	1.5E-04	0.43
MW-16-09 Slug Out	126.9	1.5E-04	0.43		
MW-16-10 Slug In	135.3	3.6E-05	0.10	3.6E-05	0.10
MW-16-10 Slug Out	135.3	3.7E-05	0.10		
MW-16-11A Slug In	127.3	6.1E-05	0.17	6.3E-05	0.18
MW-16-11A Slug Out	127.3	6.5E-05	0.18		

K = Hydraulic Conductivity

NA = Not applicable

WC = water column height in well

A 5' long by 1" diameter slug was utilized to complete slug tests in these wells in September 2021.

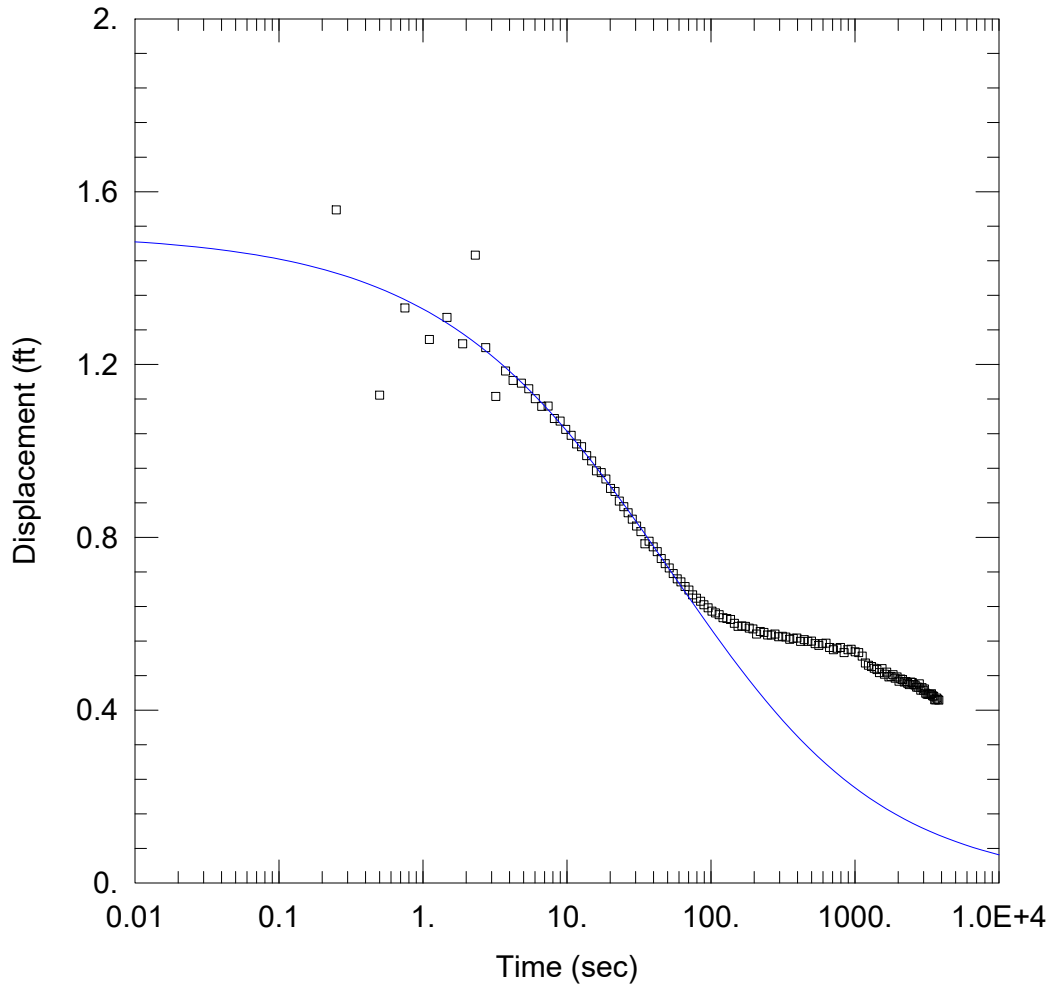

WELL TEST ANALYSIS

Data Set: P:_Vision\DTE\2021 Slug Tests\Belle River PP\MW-16-02 In.aqt
 Date: 10/29/21 Time: 11:44:26

PROJECT INFORMATION

Company: TRC
 Client: DTE
 Location: Belle River PP
 Test Well: MW-16-02
 Test Date: 9/17/2021

AQUIFER DATA

Saturated Thickness: 12. ft Anisotropy Ratio (Kz/Kr): 0.5

WELL DATA (MW-16-02)

Initial Displacement: 1.503 ft Static Water Column Height: 85.8 ft
 Total Well Penetration Depth: 5. ft Screen Length: 5. ft
 Casing Radius: 0.0861 ft Well Radius: 0.25 ft

SOLUTION

Aquifer Model: Confined Solution Method: Cooper-Bredehoeft-Papadopoulos
 T = 0.0006905 cm²/sec S = 3.692

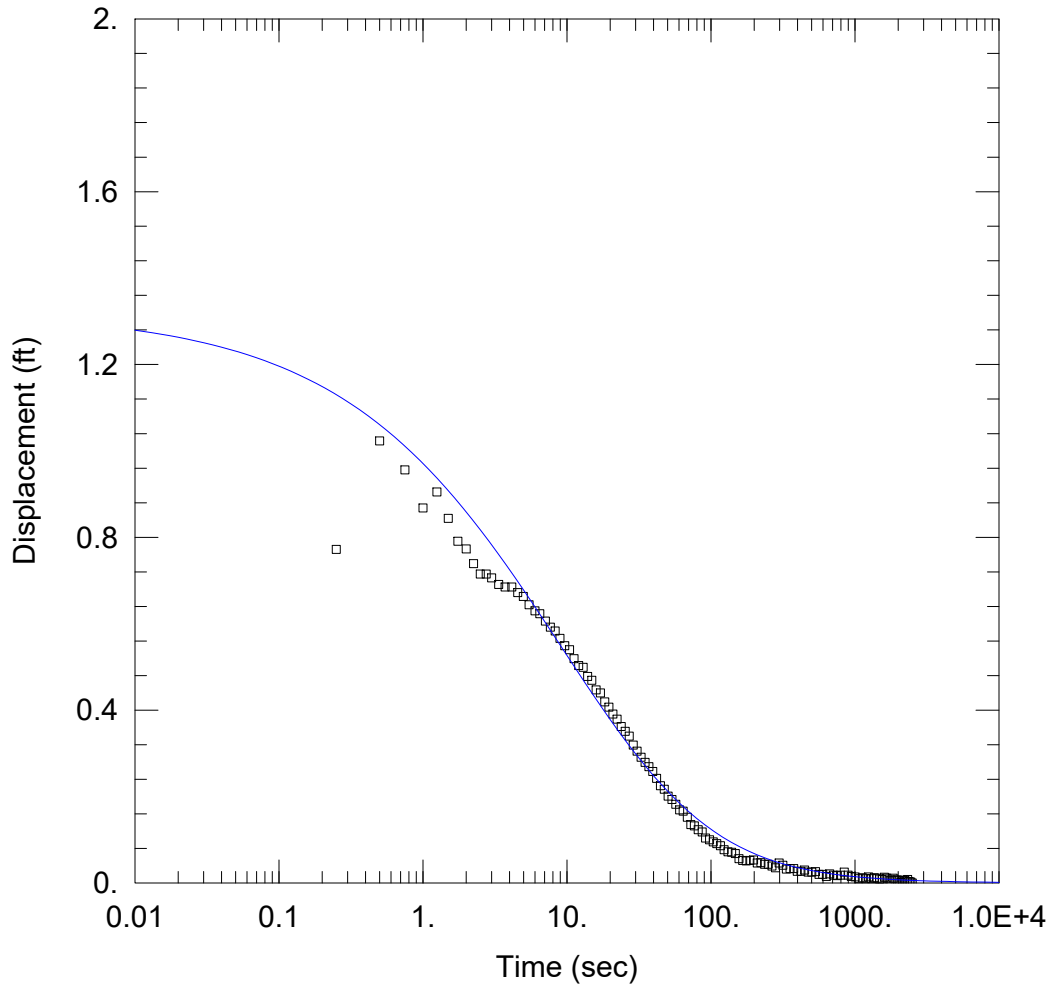

WELL TEST ANALYSIS

Data Set: P:_ Vision\DTE\2021 Slug Tests\Belle River PP\MW-16-02 Out.aqt
 Date: 10/29/21 Time: 11:46:12

PROJECT INFORMATION

Company: TRC
 Client: DTE
 Location: Belle River PP
 Test Well: MW-16-02
 Test Date: 9/17/2021

AQUIFER DATA

Saturated Thickness: 12. ft Anisotropy Ratio (Kz/Kr): 0.5

WELL DATA (MW-16-02)

Initial Displacement: 1.32 ft Static Water Column Height: 85.8 ft
 Total Well Penetration Depth: 5. ft Screen Length: 5. ft
 Casing Radius: 0.0861 ft Well Radius: 0.25 ft

SOLUTION

Aquifer Model: Confined Solution Method: Cooper-Bredehoeft-Papadopoulos
 T = 0.1533 cm²/sec S = 0.1

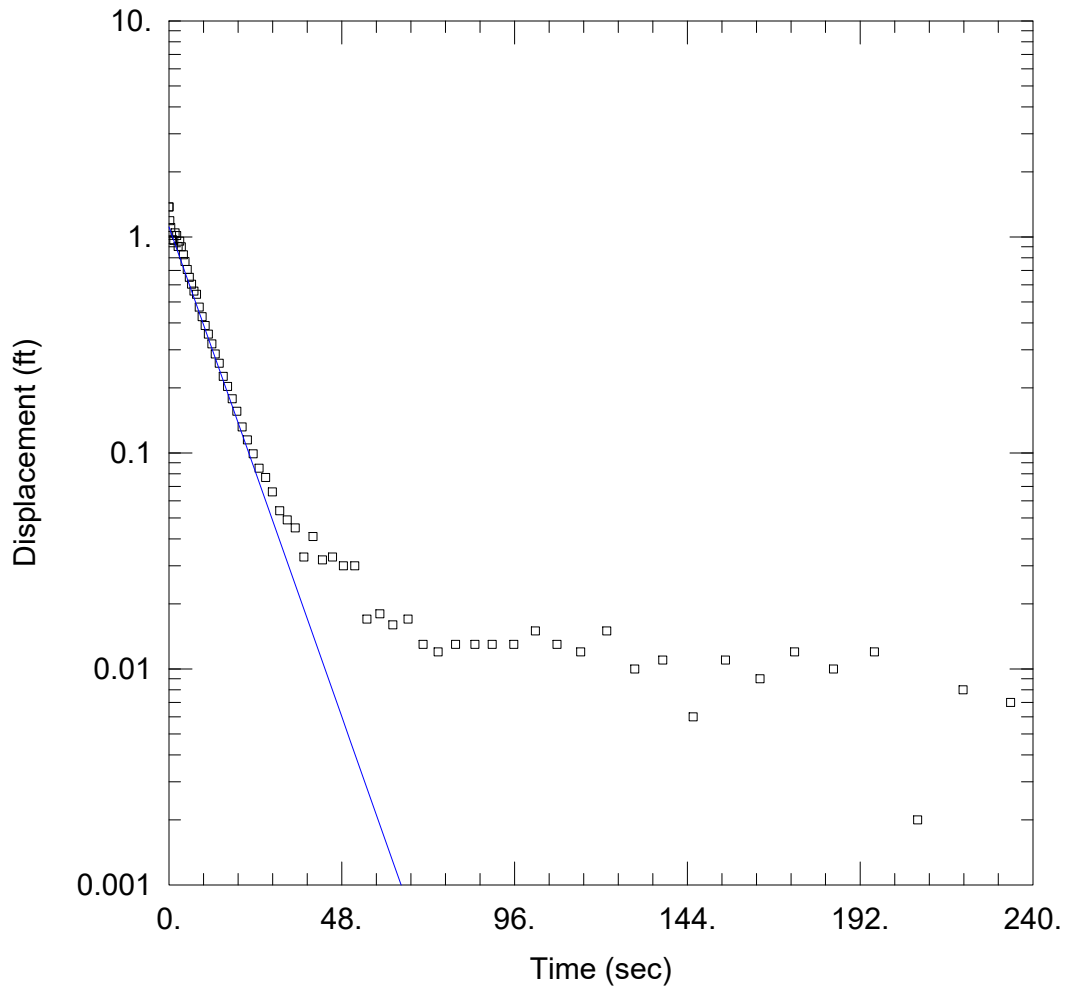

WELL TEST ANALYSIS

Data Set: P:_ Vision\DTE\2021 Slug Tests\Belle River PP\MW-16-03 In.aqt
 Date: 10/29/21 Time: 11:52:09

PROJECT INFORMATION

Company: TRC
 Client: DTE
 Location: Belle River PP
 Test Well: MW-16-03
 Test Date: 9/17/2021

AQUIFER DATA

Saturated Thickness: 12. ft Anisotropy Ratio (K_z/K_r): 0.5

WELL DATA (MW-16-03)

Initial Displacement: 1.376 ft Static Water Column Height: 123.1 ft
 Total Well Penetration Depth: 5. ft Screen Length: 5. ft
 Casing Radius: 0.0861 ft Well Radius: 0.25 ft

SOLUTION

Aquifer Model: Confined Solution Method: Hvorslev
 $K = 0.009782$ cm/sec $y_0 = 1.113$ ft

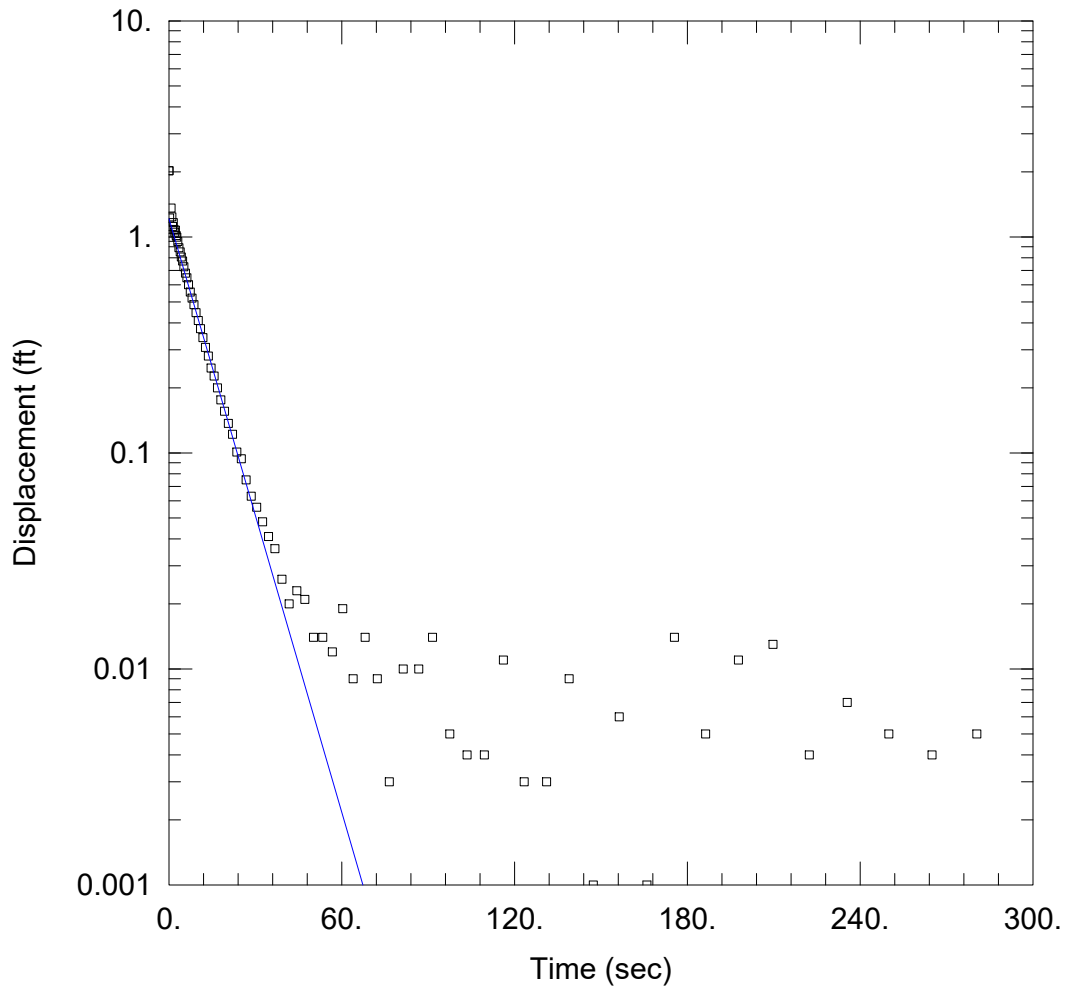

WELL TEST ANALYSIS

Data Set: P:_ Vision\DTE\2021 Slug Tests\Belle River PP\MW-16-03 Out.aqt
 Date: 10/29/21 Time: 11:53:59

PROJECT INFORMATION

Company: TRC
 Client: DTE
 Location: Belle River PP
 Test Well: MW-16-03
 Test Date: 9/17/2021

AQUIFER DATA

Saturated Thickness: 12. ft Anisotropy Ratio (Kz/Kr): 0.5

WELL DATA (MW-16-03)

Initial Displacement: 2.023 ft Static Water Column Height: 123.1 ft
 Total Well Penetration Depth: 5. ft Screen Length: 5. ft
 Casing Radius: 0.0861 ft Well Radius: 0.25 ft

SOLUTION

Aquifer Model: Confined Solution Method: Hvorslev
 K = 0.009488 cm/sec y0 = 1.215 ft

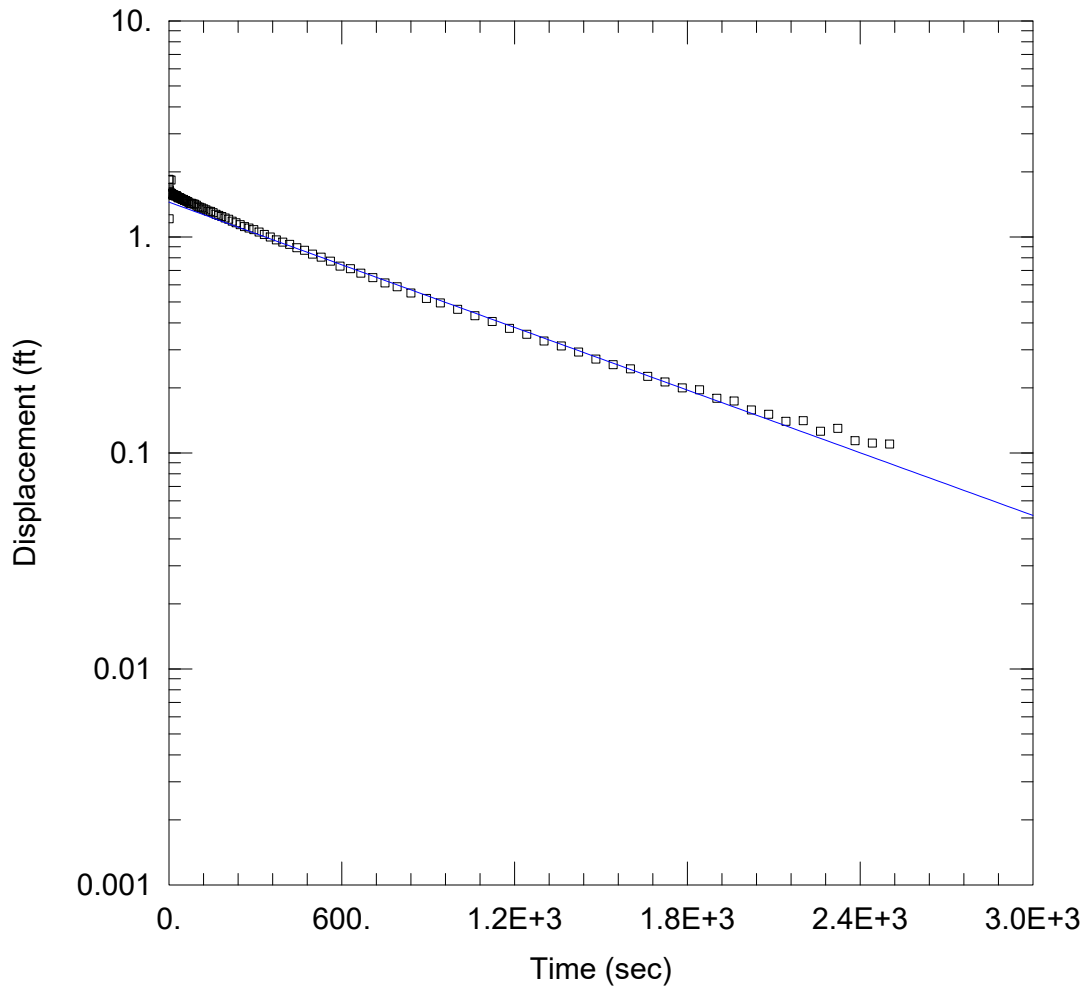

WELL TEST ANALYSIS

Data Set: P:_ Vision\DTE\2021 Slug Tests\Belle River PP\MW-16-06 In.aqt
 Date: 10/29/21 Time: 11:57:18

PROJECT INFORMATION

Company: TRC
 Client: DTE
 Location: Belle River PP
 Test Well: MW-16-06
 Test Date: 9/17/2021

AQUIFER DATA

Saturated Thickness: 6. ft Anisotropy Ratio (Kz/Kr): 0.5

WELL DATA (MW-16-06)

Initial Displacement: 1.847 ft Static Water Column Height: 125.6 ft
 Total Well Penetration Depth: 6. ft Screen Length: 5. ft
 Casing Radius: 0.0861 ft Well Radius: 0.25 ft

SOLUTION

Aquifer Model: Confined Solution Method: Hvorslev
 K = 0.0001002 cm/sec y0 = 1.449 ft

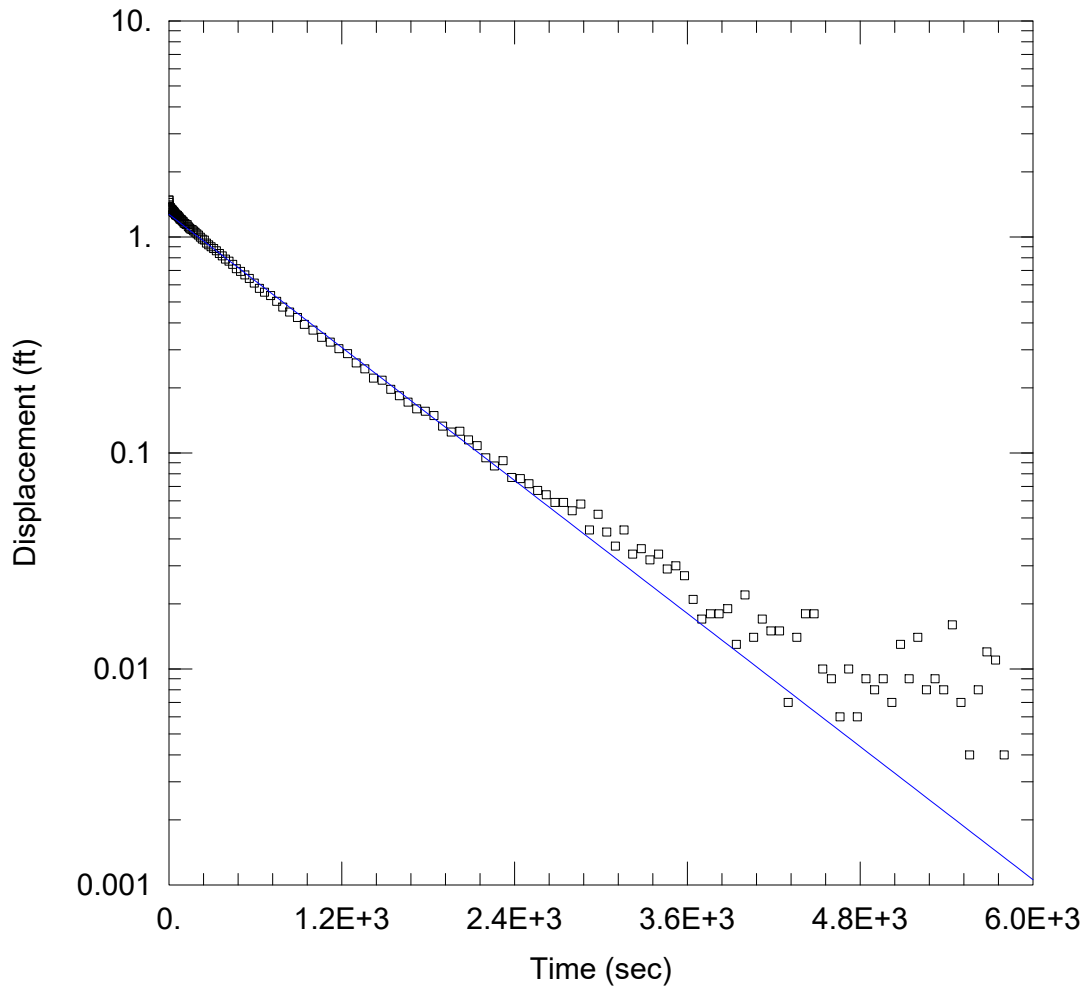

WELL TEST ANALYSIS

Data Set: P:_ Vision\DTE\2021 Slug Tests\Belle River PP\MW-16-06 Out.aqt
 Date: 10/29/21 Time: 11:58:41

PROJECT INFORMATION

Company: TRC
 Client: DTE
 Location: Belle River PP
 Test Well: MW-16-06
 Test Date: 9/17/2021

AQUIFER DATA

Saturated Thickness: 6. ft Anisotropy Ratio (K_z/K_r): 0.5

WELL DATA (MW-16-06)

Initial Displacement: 1.481 ft Static Water Column Height: 125.6 ft
 Total Well Penetration Depth: 6. ft Screen Length: 5. ft
 Casing Radius: 0.0861 ft Well Radius: 0.25 ft

SOLUTION

Aquifer Model: Confined Solution Method: Hvorslev
 $K = 0.0001063$ cm/sec $y_0 = 1.271$ ft

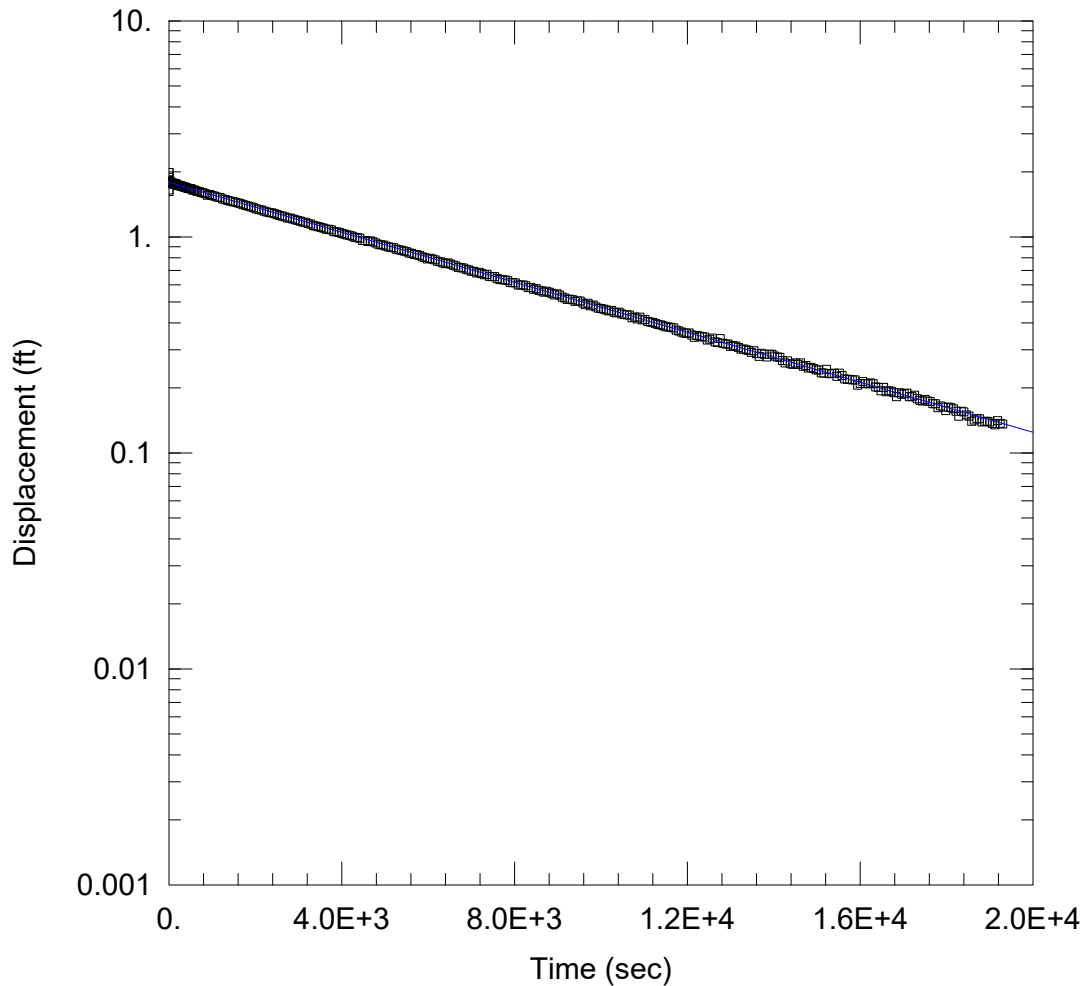

WELL TEST ANALYSIS

Data Set: P:_ Vision\DTE\2021 Slug Tests\Belle River PP\MW-16-08 In.aqt
 Date: 10/29/21 Time: 12:36:01

PROJECT INFORMATION

Company: TRC
 Client: DTE
 Location: Belle River PP
 Test Well: MW-16-08
 Test Date: 9/16/2021

AQUIFER DATA

Saturated Thickness: 7. ft Anisotropy Ratio (Kz/Kr): 0.5

WELL DATA (MW-16-08)

Initial Displacement: 1.987 ft Static Water Column Height: 124.9 ft
 Total Well Penetration Depth: 7. ft Screen Length: 5. ft
 Casing Radius: 0.0861 ft Well Radius: 0.25 ft

SOLUTION

Aquifer Model: Confined Solution Method: Hvorslev
 K = 1.199E-5 cm/sec y0 = 1.791 ft

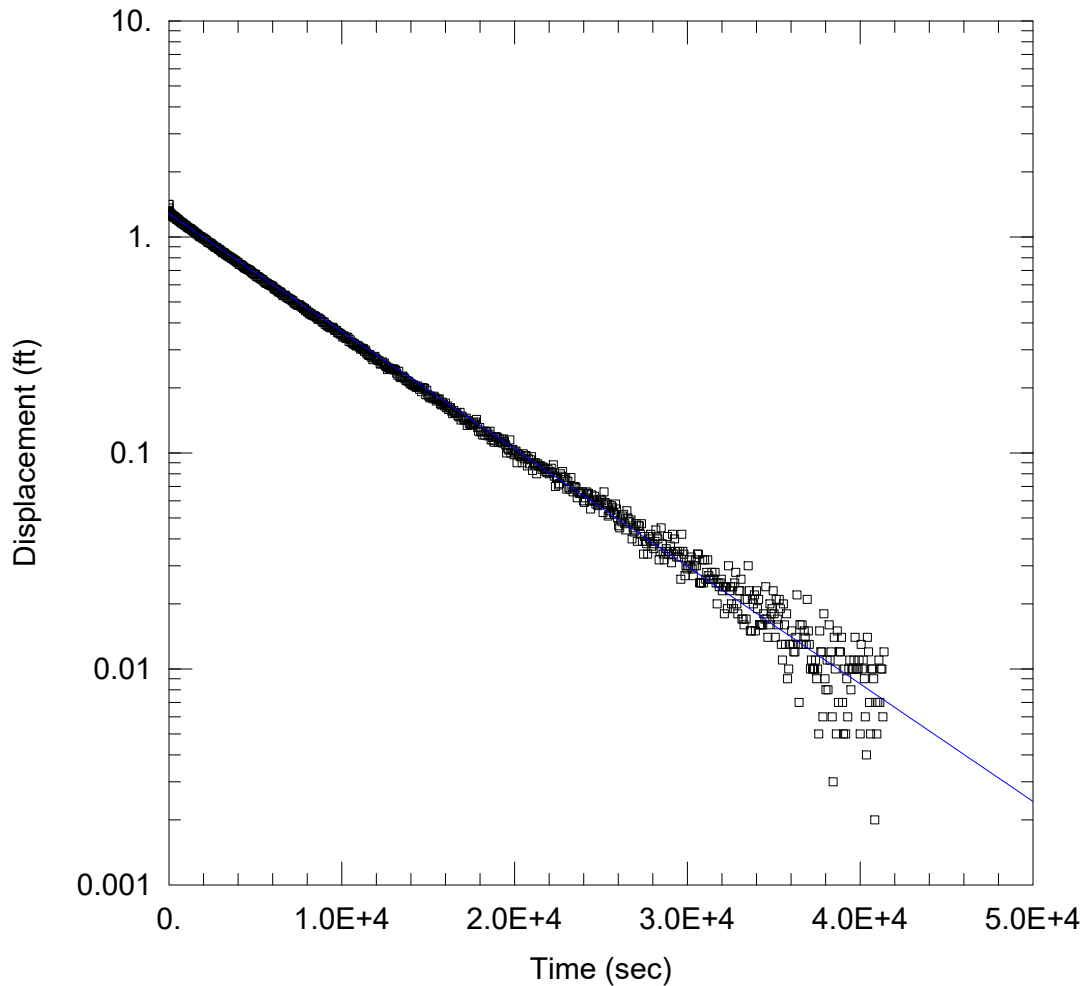

WELL TEST ANALYSIS

Data Set: P:_ Vision\DTE\2021 Slug Tests\Belle River PP\MW-16-08 Out.aqt
 Date: 10/29/21 Time: 12:38:13

PROJECT INFORMATION

Company: TRC
 Client: DTE
 Location: Belle River PP
 Test Well: MW-16-08
 Test Date: 9/16/2021

AQUIFER DATA

Saturated Thickness: 7. ft Anisotropy Ratio (K_z/K_r): 0.5

WELL DATA (MW-16-08)

Initial Displacement: 1.415 ft Static Water Column Height: 124.9 ft
 Total Well Penetration Depth: 7. ft Screen Length: 5. ft
 Casing Radius: 0.0861 ft Well Radius: 0.25 ft

SOLUTION

Aquifer Model: Confined Solution Method: Hvorslev
 $K = 1.127E-5$ cm/sec $y_0 = 1.279$ ft

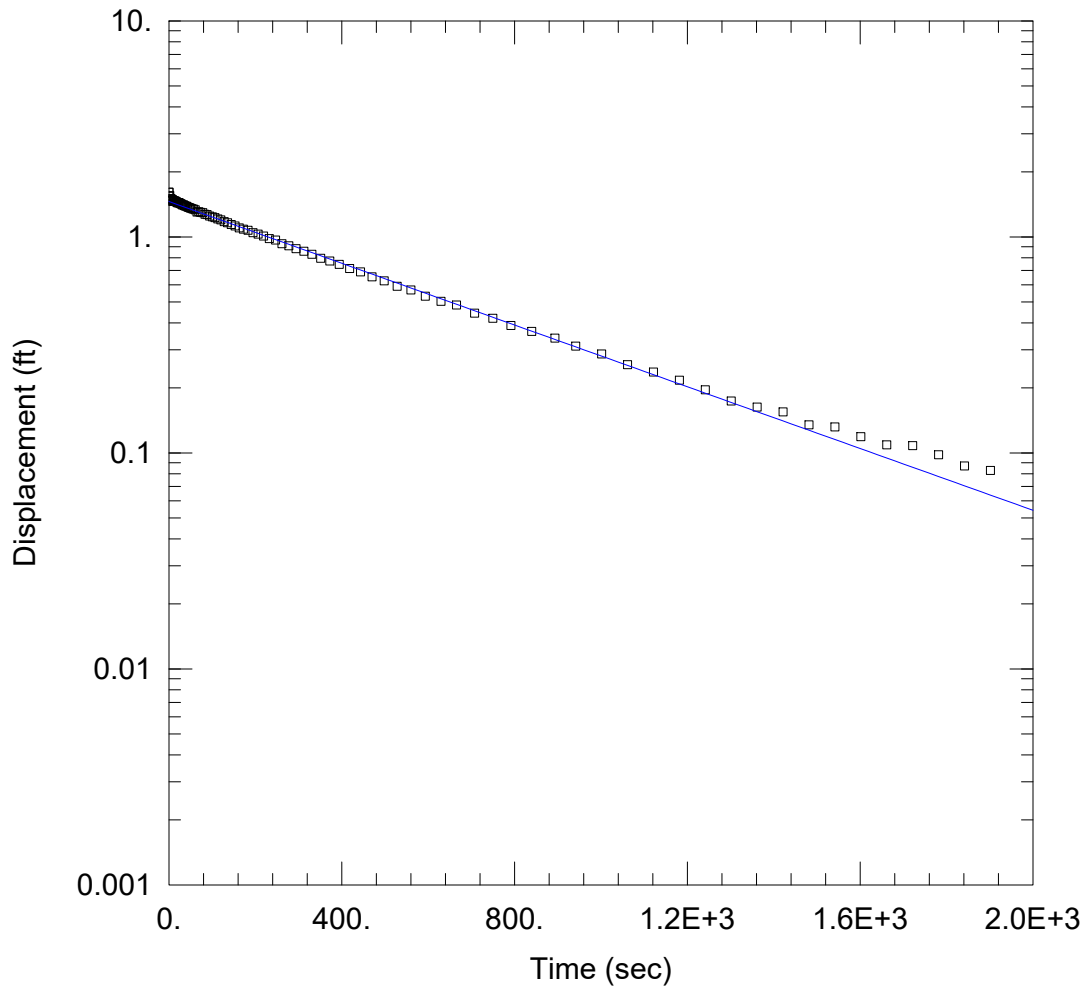

WELL TEST ANALYSIS

Data Set: P:_ Vision\DTE\2021 Slug Tests\Belle River PP\MW-16-09 In.aqt
 Date: 10/29/21 Time: 12:41:12

PROJECT INFORMATION

Company: TRC
 Client: DTE
 Location: Belle River PP
 Test Well: MW-16-09
 Test Date: 9/16/2021

AQUIFER DATA

Saturated Thickness: 12. ft Anisotropy Ratio (Kz/Kr): 0.5

WELL DATA (MW-16-09)

Initial Displacement: 1.611 ft Static Water Column Height: 126.9 ft
 Total Well Penetration Depth: 5. ft Screen Length: 5. ft
 Casing Radius: 0.0861 ft Well Radius: 0.25 ft

SOLUTION

Aquifer Model: Confined Solution Method: Hvorslev
 K = 0.000148 cm/sec y0 = 1.458 ft

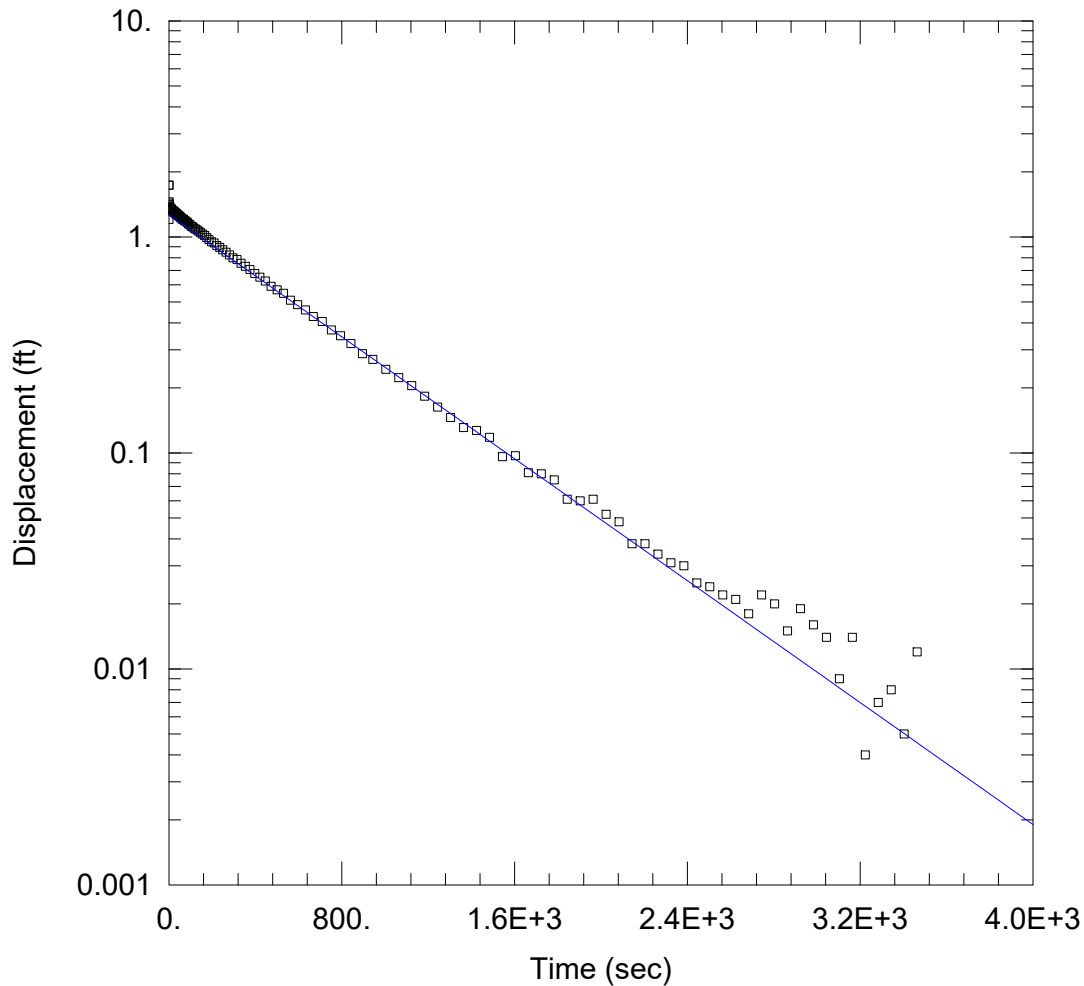

WELL TEST ANALYSIS

Data Set: P:_ Vision\DTE\2021 Slug Tests\Belle River PP\MW-16-09 Out.aqt
 Date: 10/29/21 Time: 12:43:28

PROJECT INFORMATION

Company: TRC
 Client: DTE
 Location: Belle River PP
 Test Well: MW-16-09
 Test Date: 9/16/2021

AQUIFER DATA

Saturated Thickness: 12. ft Anisotropy Ratio (K_z/K_r): 0.5

WELL DATA (MW-16-09)

Initial Displacement: 1.736 ft Static Water Column Height: 126.9 ft
 Total Well Penetration Depth: 5. ft Screen Length: 5. ft
 Casing Radius: 0.0861 ft Well Radius: 0.25 ft

SOLUTION

Aquifer Model: Confined Solution Method: Hvorslev
 $K = 0.0001461$ cm/sec $y_0 = 1.265$ ft

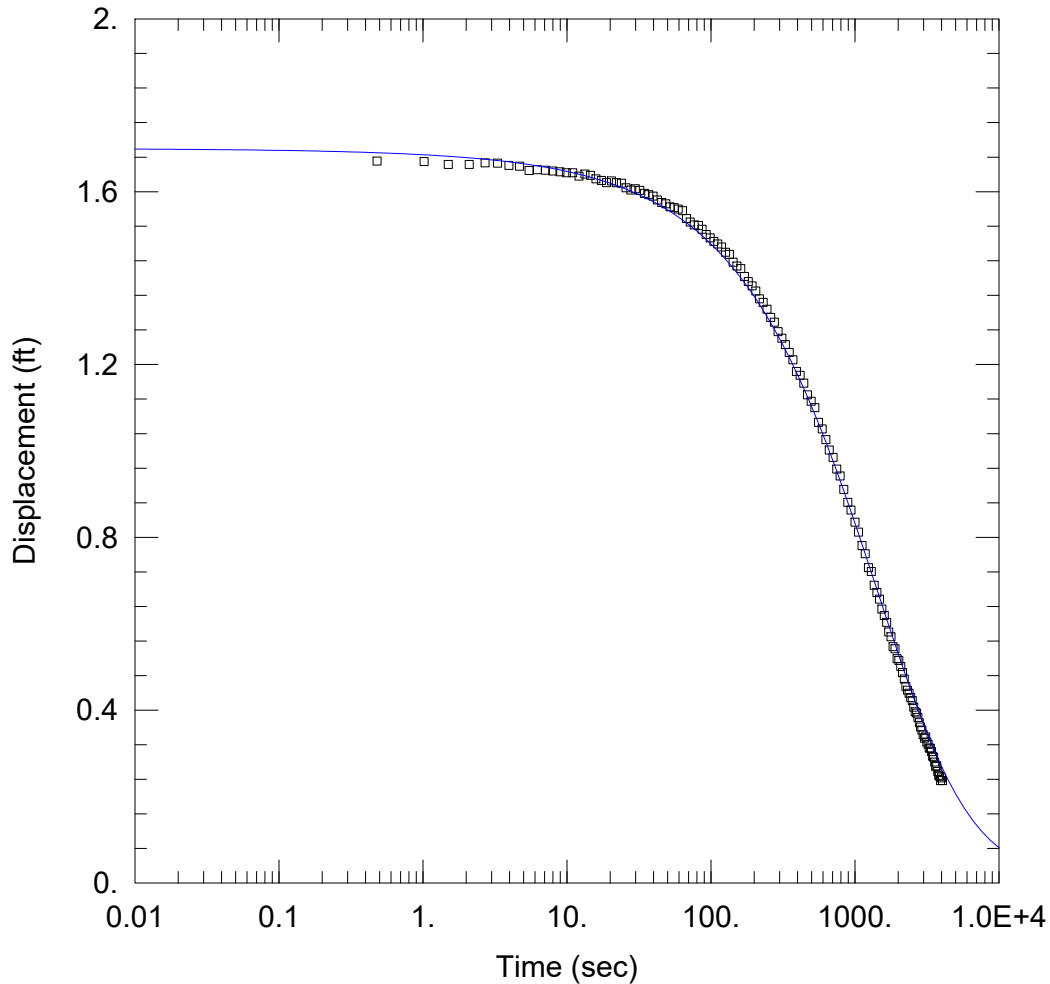

WELL TEST ANALYSIS

Data Set: P:_ Vision\DTE\2021 Slug Tests\Belle River PP\MW-16-10 In.aqt
 Date: 10/29/21 Time: 12:52:23

PROJECT INFORMATION

Company: TRC
 Client: DTE
 Location: Belle River PP
 Test Well: MW-16-10
 Test Date: 9/16/2021

AQUIFER DATA

Saturated Thickness: 5. ft Anisotropy Ratio (Kz/Kr): 0.5

WELL DATA (MW-16-10)

Initial Displacement: 1.7 ft Static Water Column Height: 135.3 ft
 Total Well Penetration Depth: 5. ft Screen Length: 5. ft
 Casing Radius: 0.0861 ft Well Radius: 0.25 ft

SOLUTION

Aquifer Model: Confined Solution Method: Cooper-Bredehoeft-Papadopoulos
 T = 0.005538 cm²/sec S = 0.001701

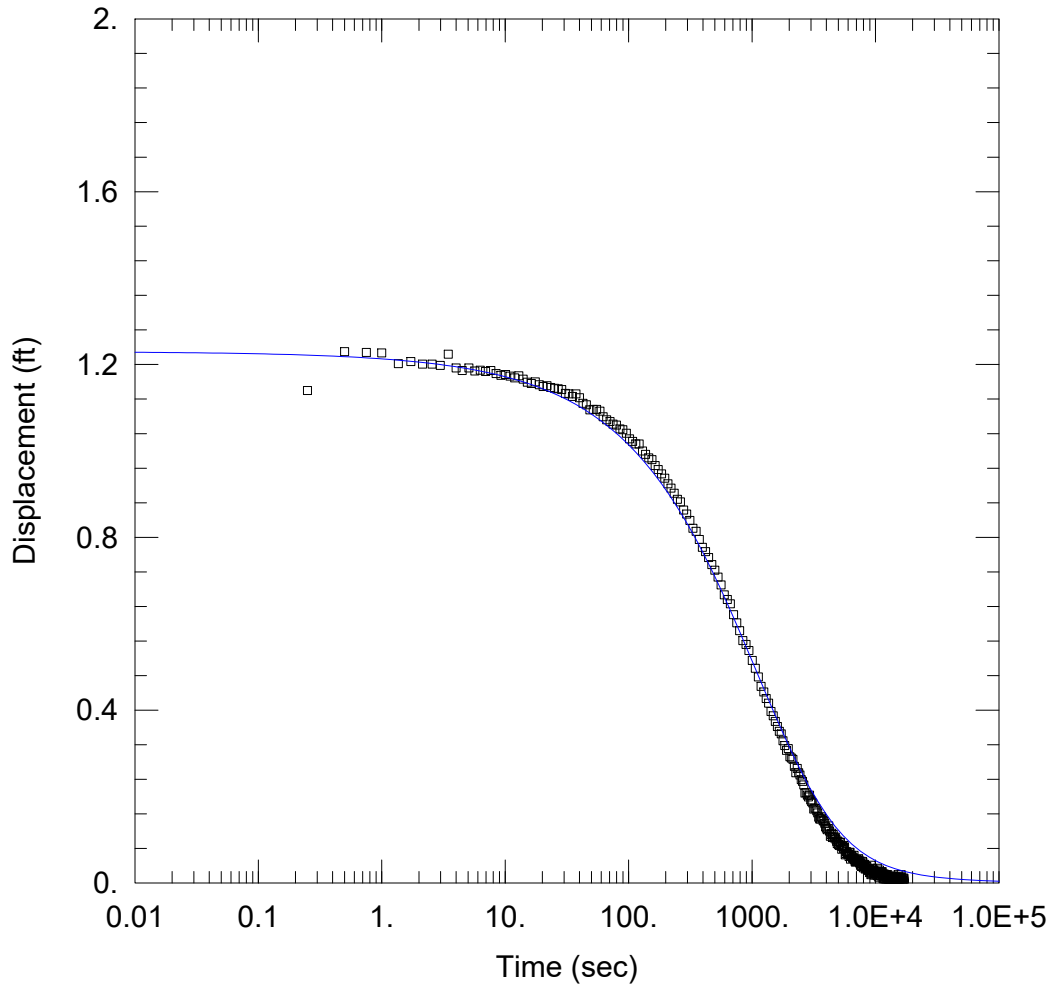

WELL TEST ANALYSIS

Data Set: P:_ Vision\DTE\2021 Slug Tests\Belle River PP\MW-16-10 Out.aqt
 Date: 10/29/21 Time: 12:54:58

PROJECT INFORMATION

Company: TRC
 Client: DTE
 Location: Belle River PP
 Test Well: MW-16-10
 Test Date: 9/16/2021

AQUIFER DATA

Saturated Thickness: 5. ft Anisotropy Ratio (Kz/Kr): 0.5

WELL DATA (MW-16-10)

Initial Displacement: 1.23 ft Static Water Column Height: 135.3 ft
 Total Well Penetration Depth: 5. ft Screen Length: 5. ft
 Casing Radius: 0.0861 ft Well Radius: 0.25 ft

SOLUTION

Aquifer Model: Confined Solution Method: Cooper-Bredehoeft-Papadopoulos
 T = 0.005626 cm²/sec S = 0.004752

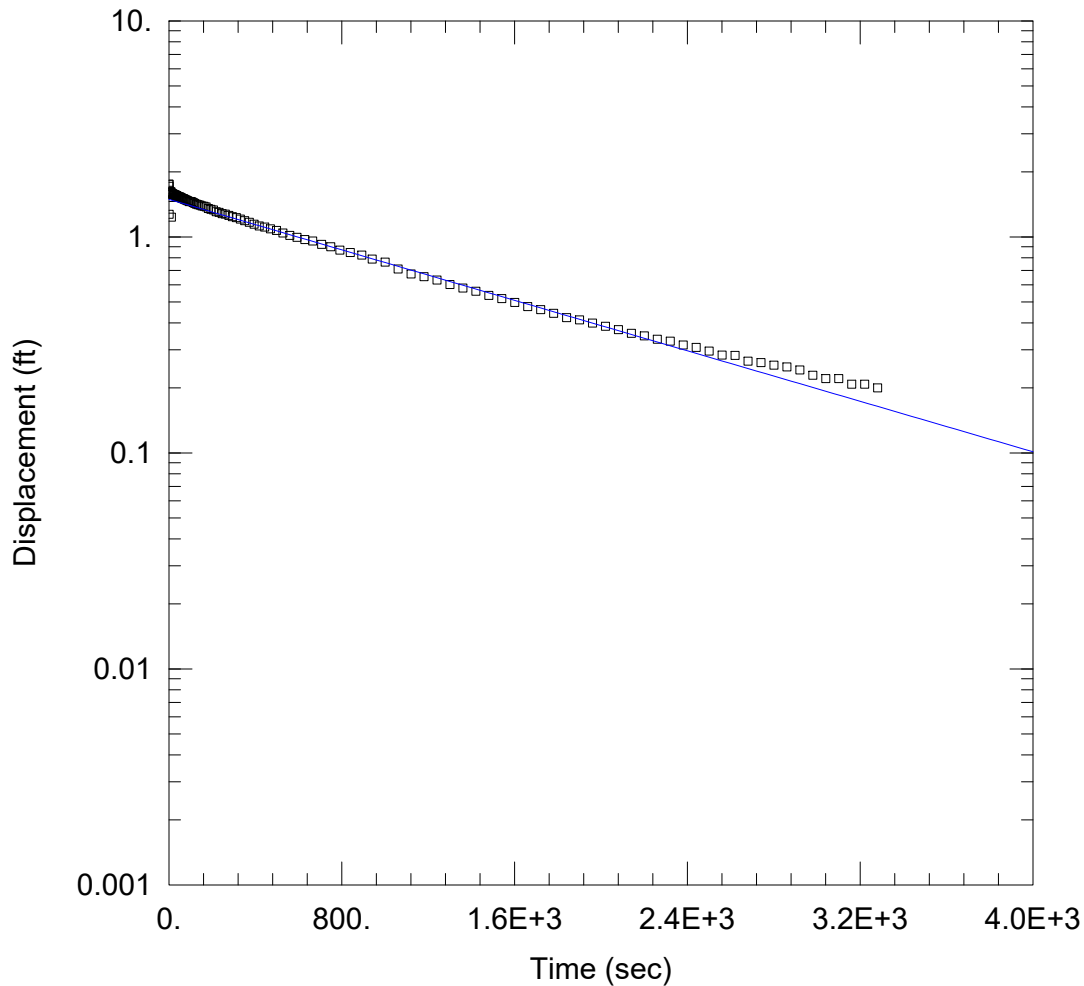

WELL TEST ANALYSIS

Data Set: P:_Vision\DTE\2021 Slug Tests\Belle River PP\MW-16-11A In.aqt
 Date: 10/29/21 Time: 12:59:49

PROJECT INFORMATION

Company: TRC
 Client: DTE
 Location: Belle River PP
 Test Well: MW-16-11A
 Test Date: 9/16/2021

AQUIFER DATA

Saturated Thickness: 7. ft Anisotropy Ratio (Kz/Kr): 0.5

WELL DATA (MW-16-11A)

Initial Displacement: 1.753 ft Static Water Column Height: 127.3 ft
 Total Well Penetration Depth: 7. ft Screen Length: 5. ft
 Casing Radius: 0.0861 ft Well Radius: 0.25 ft

SOLUTION

Aquifer Model: Confined Solution Method: Hvorslev
 K = 6.051E-5 cm/sec y0 = 1.492 ft

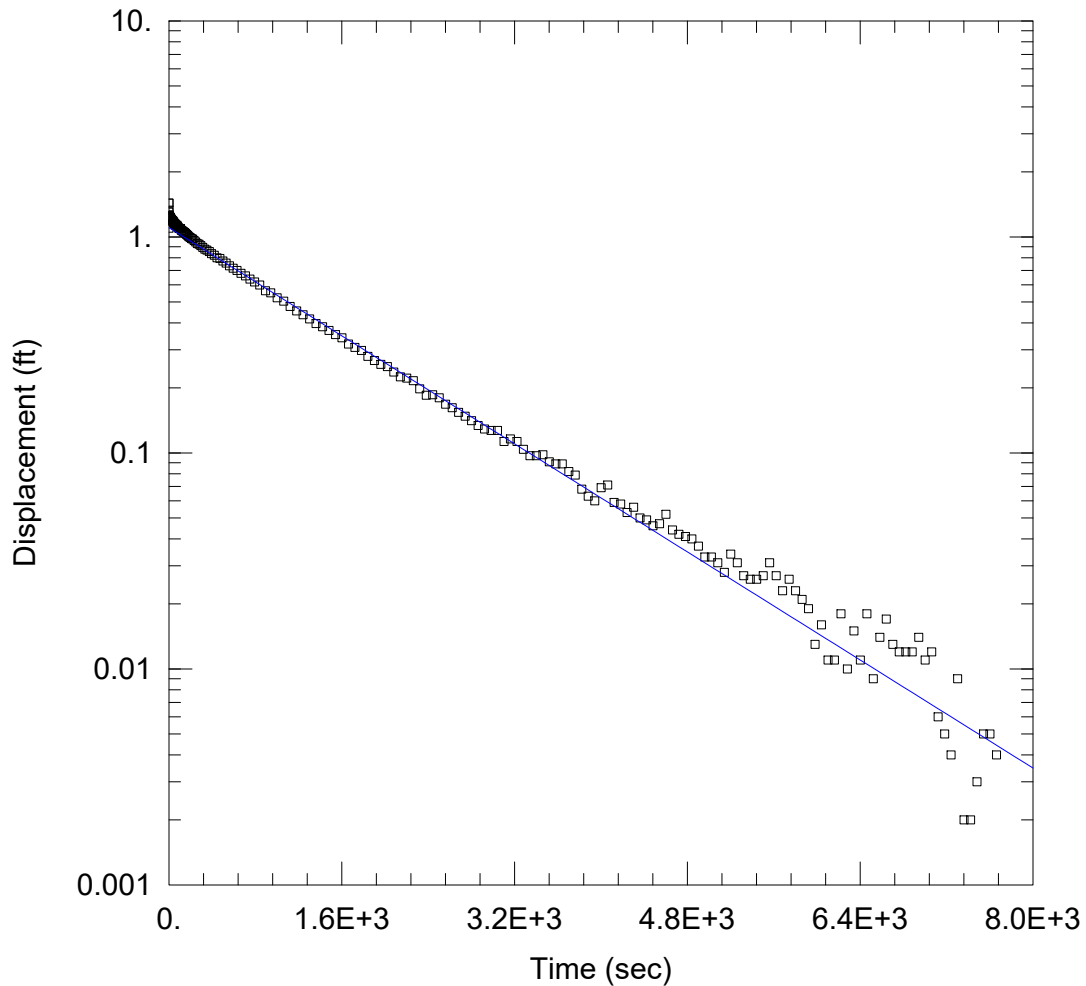

WELL TEST ANALYSIS

Data Set: P:_ Vision\DTE\2021 Slug Tests\Belle River PP\MW-16-11A Out.aqt
 Date: 10/29/21 Time: 13:00:15

PROJECT INFORMATION

Company: TRC
 Client: DTE
 Location: Belle River PP
 Test Well: MW-16-11A
 Test Date: 9/16/2021

AQUIFER DATA

Saturated Thickness: 7. ft Anisotropy Ratio (K_z/K_r): 0.5

WELL DATA (MW-16-11A)

Initial Displacement: 1.434 ft Static Water Column Height: 127.3 ft
 Total Well Penetration Depth: 7. ft Screen Length: 5. ft
 Casing Radius: 0.0861 ft Well Radius: 0.25 ft

SOLUTION

Aquifer Model: Confined Solution Method: Hvorslev
 $K = 6.477E-5$ cm/sec $y_0 = 1.103$ ft

APPENDIX B – MONITORING WELL LOGS



WELL CONSTRUCTION DIAGRAM

PROJ. NAME: DTE Electric Company Belle River Power Plant	WELL ID: MW-16-01
PROJ. NO: 231828.0003	DATE INSTALLED: 3/17/2016 INSTALLED BY: A. Knutson CHECKED BY: C. Scieszka

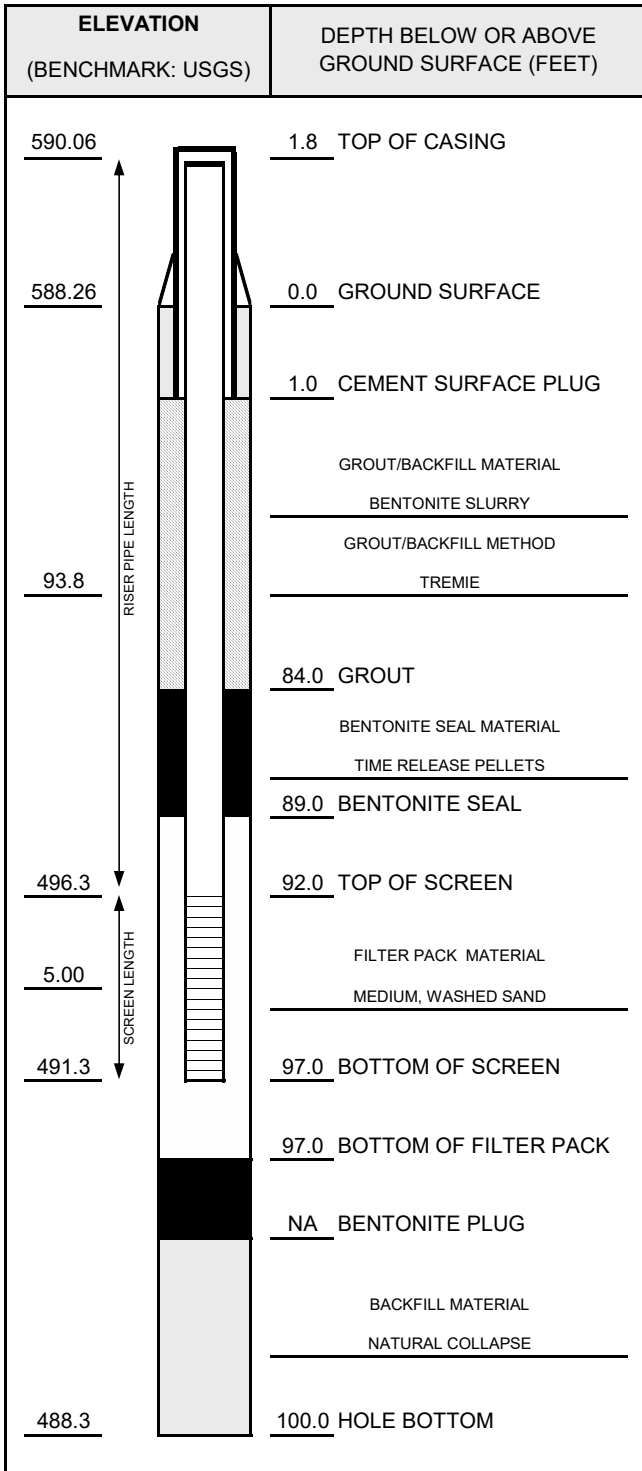

CASING AND SCREEN DETAILS	
TYPE OF RISER:	<u>2-INCH PVC</u>
PIPE SCHEDULE:	<u>40</u>
PIPE JOINTS:	<u>THREADED O-RINGS</u>
SCREEN TYPE:	<u>2-INCH PVC</u>
SCR. SLOT SIZE:	<u>0.01-INCH</u>
BOREHOLE DIAMETER:	<u>6</u> IN. FROM <u>0</u> TO <u>97</u> FT. <u>4</u> IN. FROM <u>97</u> TO <u>100</u> FT.
SURF. CASING DIAMETER:	<u> </u> IN. FROM <u> </u> TO <u> </u> FT. <u> </u> IN. FROM <u> </u> TO <u> </u> FT.

WELL DEVELOPMENT	
DEVELOPMENT METHOD:	<u>AIR LIFT</u>
TIME DEVELOPING:	<u>4</u> HOURS
WATER REMOVED:	<u>120</u> GALLONS
WATER ADDED:	<u>0</u> GALLONS
WATER CLARITY BEFORE / AFTER DEVELOPMENT	
CLARITY BEFORE:	<u>VERY TURBID</u>
COLOR BEFORE:	<u>BROWN /GREY</u>
CLARITY AFTER:	<u>CLEAR</u>
COLOR AFTER:	<u>NONE</u>
ODOR (IF PRESENT):	<u>NONE</u>

WATER LEVEL SUMMARY				
	MEASUREMENT (FEET)		DATE	TIME
DTB BEFORE DEVELOPING:	98.20	T/PVC	3/21/2016	--
DTB AFTER DEVELOPING:	100.32	T/PVC	4/13/2016	845
SWL BEFORE DEVELOPING:	12.92	T/PVC	3/21/2016	--
SWL AFTER DEVELOPING:	16.32	T/PVC	4/13/2016	845
OTHER SWL:		T/PVC		
OTHER SWL:		T/PVC		

PROTECTIVE CASING DETAILS		
PERMANENT, LEGIBLE WELL LABEL ADDED?	<input checked="" type="checkbox"/> YES	<input type="checkbox"/> NO
PROTECTIVE COVER AND LOCK INSTALLED?	<input checked="" type="checkbox"/> YES	<input type="checkbox"/> NO
LOCK KEY NUMBER:	<u>3120</u>	

NOTES:



WELL CONSTRUCTION DIAGRAM

PROJ. NAME: DTE Electric Company Belle River Power Plant	WELL ID: MW-16-02
PROJ. NO: 231828.0003	DATE INSTALLED: 3/15/2016 INSTALLED BY: A. Knutson CHECKED BY: C. Scieszka

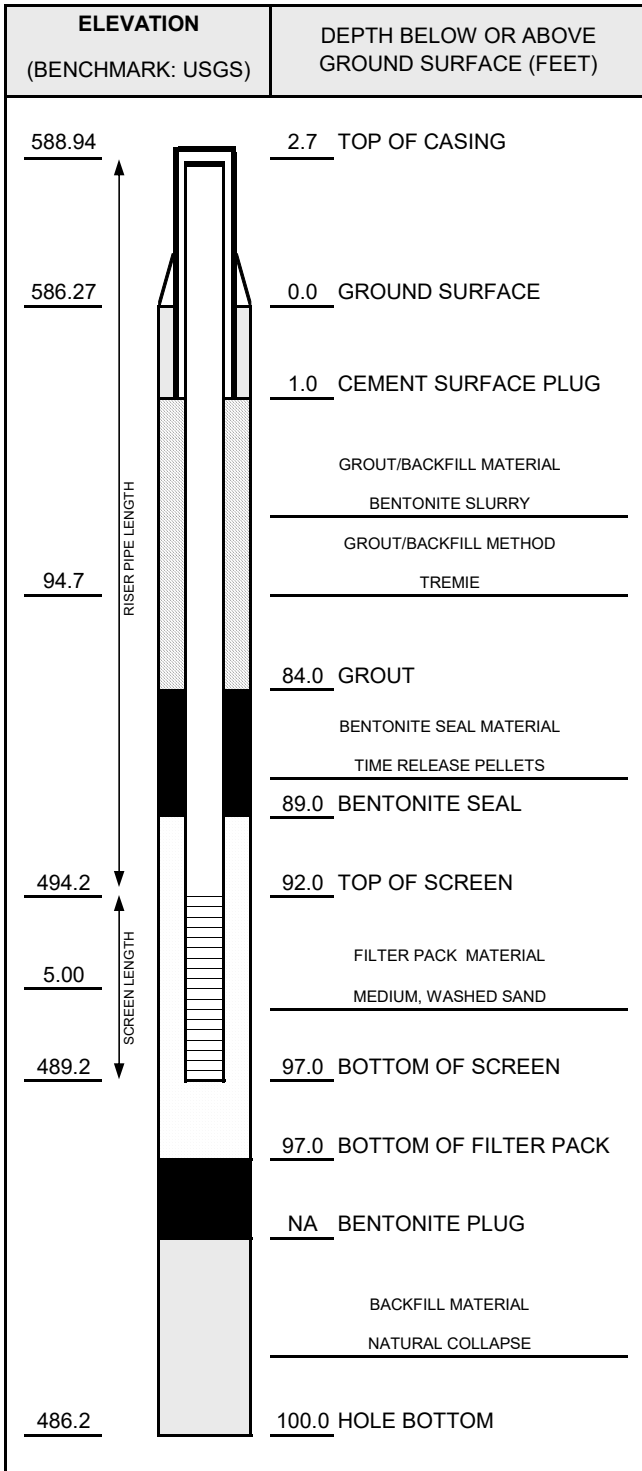

CASING AND SCREEN DETAILS	
TYPE OF RISER:	<u>2-INCH PVC</u>
PIPE SCHEDULE:	<u>40</u>
PIPE JOINTS:	<u>THREADED O-RINGS</u>
SCREEN TYPE:	<u>2-INCH PVC</u>
SCR. SLOT SIZE:	<u>0.01-INCH</u>
BOREHOLE DIAMETER:	<u>6</u> IN. FROM <u>0</u> TO <u>97</u> FT. <u>4</u> IN. FROM <u>97</u> TO <u>100</u> FT.
SURF. CASING DIAMETER:	<u> </u> IN. FROM <u> </u> TO <u> </u> FT. <u> </u> IN. FROM <u> </u> TO <u> </u> FT.

WELL DEVELOPMENT	
DEVELOPMENT METHOD:	<u>AIR LIFT</u>
TIME DEVELOPING:	<u>4</u> HOURS
WATER REMOVED:	<u>460</u> GALLONS
WATER ADDED:	<u>0</u> GALLONS
WATER CLARITY BEFORE / AFTER DEVELOPMENT	
CLARITY BEFORE:	<u>VERY TURBID</u>
COLOR BEFORE:	<u>BROWN /GREY</u>
CLARITY AFTER:	<u>CLEAR</u>
COLOR AFTER:	<u>NONE</u>
ODOR (IF PRESENT):	<u>NONE</u>

WATER LEVEL SUMMARY				
	MEASUREMENT (FEET)		DATE	TIME
DTB BEFORE DEVELOPING:	97.07	T/PVC	3/15/2016	--
DTB AFTER DEVELOPING:	100.20	T/PVC	4/13/2016	9:24
SWL BEFORE DEVELOPING:	14.56	T/PVC	3/15/2016	--
SWL AFTER DEVELOPING:	28.28	T/PVC	3/18/2016	--
OTHER SWL:	18.77	T/PVC	4/13/2016	9:24
OTHER SWL:		T/PVC		

PROTECTIVE CASING DETAILS		
PERMANENT, LEGIBLE WELL LABEL ADDED?	<input checked="" type="checkbox"/> YES	<input type="checkbox"/> NO
PROTECTIVE COVER AND LOCK INSTALLED?	<input checked="" type="checkbox"/> YES	<input type="checkbox"/> NO
LOCK KEY NUMBER:	<u>3120</u>	

NOTES:



WELL CONSTRUCTION DIAGRAM

PROJ. NAME: DTE Electric Company Belle River Power Plant	WELL ID: MW-16-03
PROJ. NO: 231828.0003	DATE INSTALLED: 6/1/2016 INSTALLED BY: J. Reed CHECKED BY: M. Powers

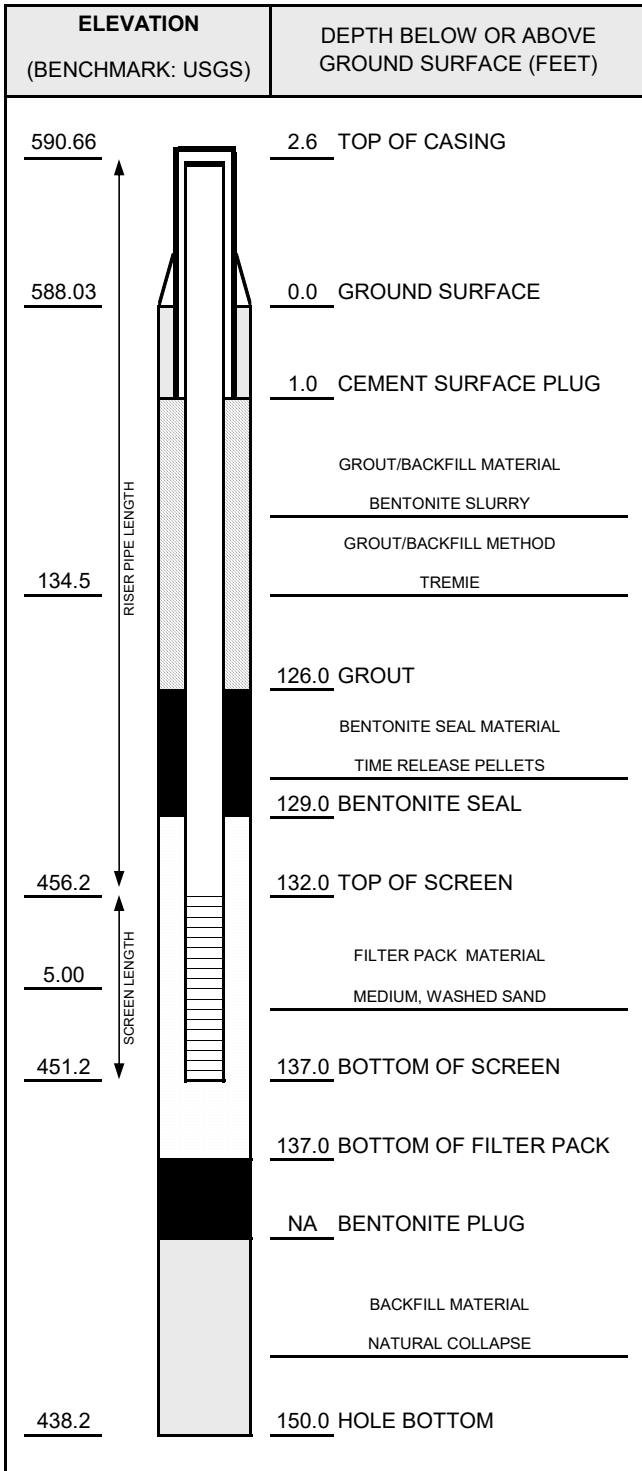

NOTES:

CASING AND SCREEN DETAILS	
TYPE OF RISER: <u>2-INCH PVC</u>	PIPE SCHEDULE: <u>40</u>
PIPE JOINTS: <u>THREADED O-RINGS</u>	SCREEN TYPE: <u>2-INCH PVC</u>
SCR. SLOT SIZE: <u>0.01-INCH</u>	BOREHOLE DIAMETER: <u>6</u> IN. FROM <u>0</u> TO <u>140</u> FT. <u>4</u> IN. FROM <u>140</u> TO <u>150</u> FT.
SURF. CASING DIAMETER: _____ IN. FROM _____ TO _____ FT. _____ IN. FROM _____ TO _____ FT.	

WELL DEVELOPMENT	
DEVELOPMENT METHOD: <u>AIR LIFT</u>	TIME DEVELOPING: <u>4</u> HOURS
WATER REMOVED: <u>60</u> GALLONS	WATER ADDED: <u>0</u> GALLONS
WATER CLARITY BEFORE / AFTER DEVELOPMENT	
CLARITY BEFORE: <u>TURBID</u>	COLOR BEFORE: <u>LIGHT GRAY</u>
CLARITY AFTER: <u>SLIGHTLY TURBID</u>	COLOR AFTER: <u>VERY LIGHT GRAY</u>
ODOR (IF PRESENT): <u>NONE</u>	

WATER LEVEL SUMMARY				
MEASUREMENT (FEET)			DATE	TIME
DTB BEFORE DEVELOPING:	140.00	T/PVC	6/8/2016	7:20
DTB AFTER DEVELOPING:	140.00	T/PVC	6/8/2016	14:30
SWL BEFORE DEVELOPING:	16.06	T/PVC	6/8/2016	7:20
SWL AFTER DEVELOPING:	15.32	T/PVC	6/8/2016	14:30
OTHER DTB:	140.41	T/PVC	6/9/2016	10:00
OTHER SWL:		T/PVC		

PROTECTIVE CASING DETAILS		
PERMANENT, LEGIBLE WELL LABEL ADDED?	<input checked="" type="checkbox"/> YES	<input type="checkbox"/> NO
PROTECTIVE COVER AND LOCK INSTALLED?	<input checked="" type="checkbox"/> YES	<input type="checkbox"/> NO
LOCK KEY NUMBER: <u>3120</u>		



WELL CONSTRUCTION DIAGRAM

PROJ. NAME: DTE Electric Company Belle River Power Plant	WELL ID: MW-16-04
PROJ. NO: 231828.0003	DATE INSTALLED: 3/8/2016 INSTALLED BY: A. Knutson CHECKED BY: C. Scieszka

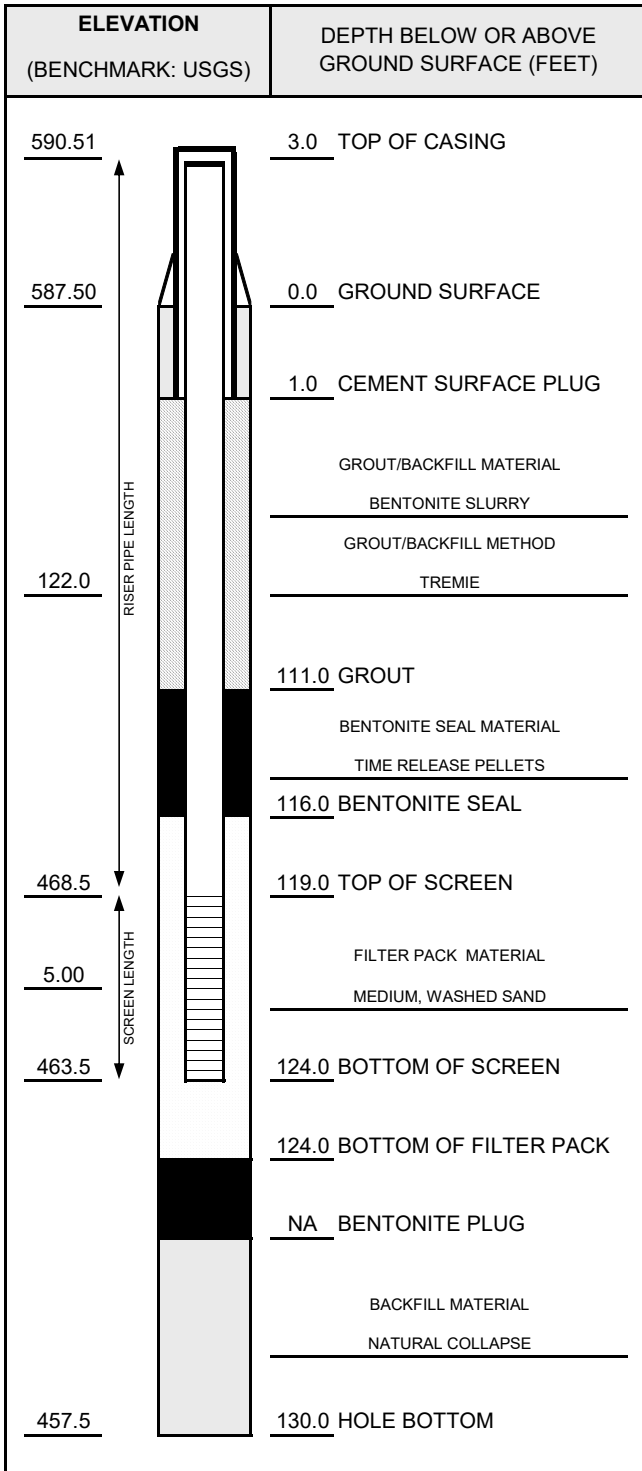

NOTES:

CASING AND SCREEN DETAILS	
TYPE OF RISER:	<u>2-INCH PVC</u>
PIPE SCHEDULE:	<u>40</u>
PIPE JOINTS:	<u>THREADED O-RINGS</u>
SCREEN TYPE:	<u>2-INCH PVC</u>
SCR. SLOT SIZE:	<u>0.01-INCH</u>
BOREHOLE DIAMETER:	<u>6</u> IN. FROM <u>0</u> TO <u>124</u> FT. <u>4</u> IN. FROM <u>124</u> TO <u>130</u> FT.
SURF. CASING DIAMETER:	<u> </u> IN. FROM <u> </u> TO <u> </u> FT. <u> </u> IN. FROM <u> </u> TO <u> </u> FT.

WELL DEVELOPMENT	
DEVELOPMENT METHOD:	<u>AIR LIFT</u>
TIME DEVELOPING:	<u>4</u> HOURS
WATER REMOVED:	<u>288</u> GALLONS
WATER ADDED:	<u>0</u> GALLONS
WATER CLARITY BEFORE / AFTER DEVELOPMENT	
CLARITY BEFORE:	<u>VERY TURBID</u>
COLOR BEFORE:	<u>BROWN /GREY</u>
CLARITY AFTER:	<u>CLEAR</u>
COLOR AFTER:	<u>NONE</u>
ODOR (IF PRESENT):	<u>NONE</u>

WATER LEVEL SUMMARY				
MEASUREMENT (FEET)			DATE	TIME
DTB BEFORE DEVELOPING:	123.97	T/PVC	3/8/2016	--
DTB AFTER DEVELOPING:	126.45	T/PVC	4/13/2016	9:31
SWL BEFORE DEVELOPING:	13.98	T/PVC	3/15/2016	14:30
SWL AFTER DEVELOPING:	13.46	T/PVC	3/18/2016	7:30
OTHER SWL:	16.91	T/PVC	4/13/2016	9:31
OTHER SWL:		T/PVC		

PROTECTIVE CASING DETAILS	
PERMANENT, LEGIBLE WELL LABEL ADDED?	<input checked="" type="checkbox"/> YES <input type="checkbox"/> NO
PROTECTIVE COVER AND LOCK INSTALLED?	<input checked="" type="checkbox"/> YES <input type="checkbox"/> NO
LOCK KEY NUMBER:	<u>3120</u>



WELL CONSTRUCTION DIAGRAM

PROJ. NAME: DTE Electric Company Belle River Power Plant	WELL ID: MW-16-05
PROJ. NO: 231828.0003	DATE INSTALLED: 3/4/2016
INSTALLED BY: A. Knutson	CHECKED BY: C. Scieszka

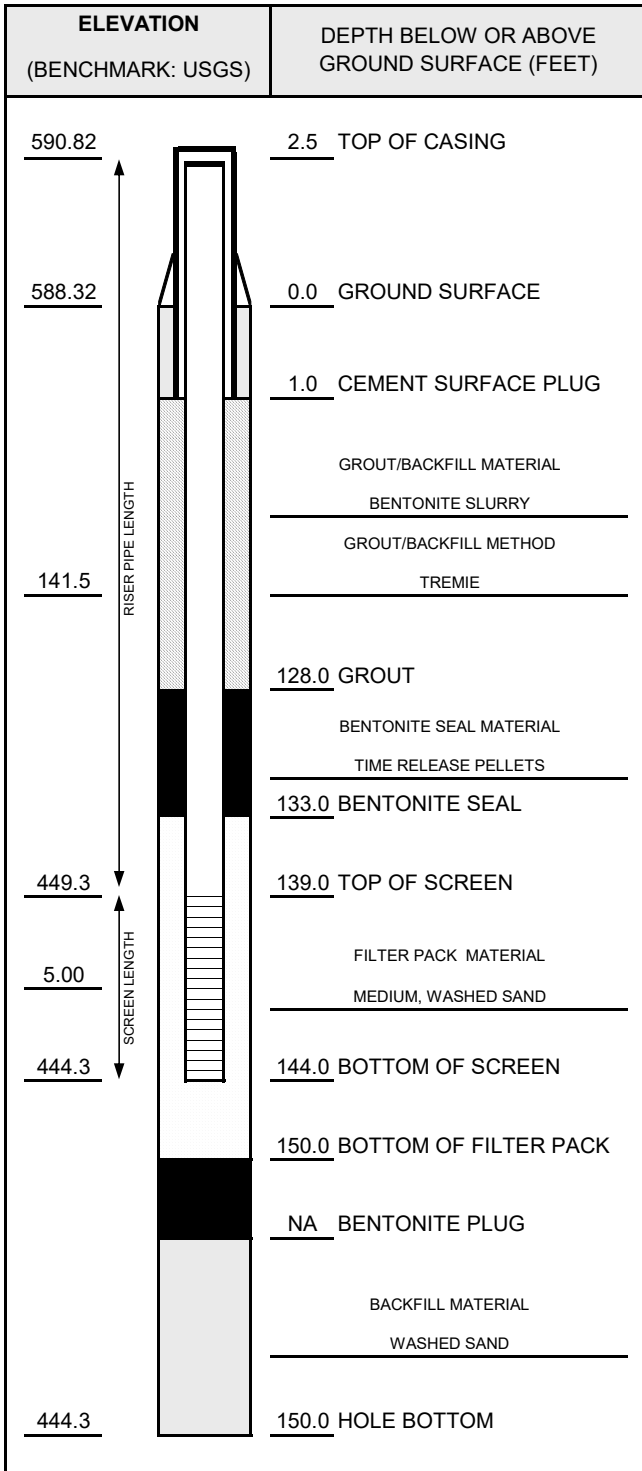

CASING AND SCREEN DETAILS	
TYPE OF RISER:	<u>2-INCH PVC</u>
PIPE SCHEDULE:	<u>40</u>
PIPE JOINTS:	<u>THREADED O-RINGS</u>
SCREEN TYPE:	<u>2-INCH PVC</u>
SCR. SLOT SIZE:	<u>0.01-INCH</u>
BOREHOLE DIAMETER:	<u>6</u> IN. FROM <u>0</u> TO <u>150</u> FT. <u> </u> IN. FROM <u> </u> TO <u> </u> FT.
SURF. CASING DIAMETER:	<u> </u> IN. FROM <u> </u> TO <u> </u> FT. <u> </u> IN. FROM <u> </u> TO <u> </u> FT.

WELL DEVELOPMENT	
DEVELOPMENT METHOD:	<u>AIR LIFT</u>
TIME DEVELOPING:	<u>4</u> HOURS
WATER REMOVED:	<u>300</u> GALLONS
WATER ADDED:	<u>0</u> GALLONS
WATER CLARITY BEFORE / AFTER DEVELOPMENT	
CLARITY BEFORE:	<u>VERY TURBID</u>
COLOR BEFORE:	<u>GREY</u>
CLARITY AFTER:	<u>CLEAR</u>
COLOR AFTER:	<u>NONE</u>
ODOR (IF PRESENT):	<u>NONE</u>

WATER LEVEL SUMMARY				
MEASUREMENT (FEET)			DATE	TIME
DTB BEFORE DEVELOPING:	144.03	T/PVC	3/4/2016	--
DTB AFTER DEVELOPING:	147.16	T/PVC	4/13/2016	9:55
SWL BEFORE DEVELOPING:	13.71	T/PVC	3/15/2016	--
SWL AFTER DEVELOPING:	14.13	T/PVC	3/18/2016	--
OTHER SWL:	16.87	T/PVC	4/13/2016	9:55
OTHER SWL:		T/PVC		

NOTES:

PROTECTIVE CASING DETAILS		
PERMANENT, LEGIBLE WELL LABEL ADDED?	<input checked="" type="checkbox"/> YES	<input type="checkbox"/> NO
PROTECTIVE COVER AND LOCK INSTALLED?	<input checked="" type="checkbox"/> YES	<input type="checkbox"/> NO
LOCK KEY NUMBER:	<u>3120</u>	



WELL CONSTRUCTION DIAGRAM

PROJ. NAME: DTE Electric Company Belle River Power Plant	WELL ID: MW-16-06
PROJ. NO: 231828.0003	DATE INSTALLED: 3/11/2016
INSTALLED BY: A. Knutson	CHECKED BY: C. Scieszka

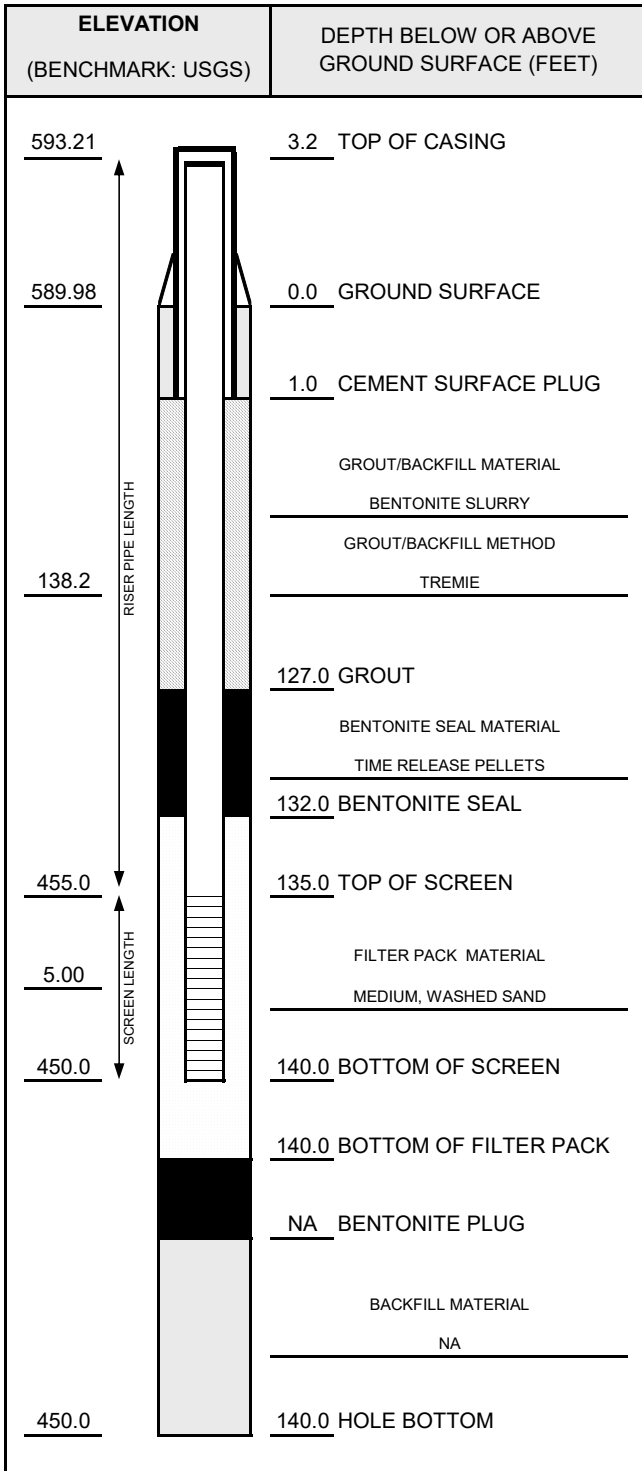

CASING AND SCREEN DETAILS	
TYPE OF RISER:	<u>2-INCH PVC</u>
PIPE SCHEDULE:	<u>40</u>
PIPE JOINTS:	<u>THREADED O-RINGS</u>
SCREEN TYPE:	<u>2-INCH PVC</u>
SCR. SLOT SIZE:	<u>0.01-INCH</u>
BOREHOLE DIAMETER:	<u>6</u> IN. FROM <u>0</u> TO <u>140</u> FT. <u> </u> IN. FROM <u> </u> TO <u> </u> FT.
SURF. CASING DIAMETER:	<u> </u> IN. FROM <u> </u> TO <u> </u> FT. <u> </u> IN. FROM <u> </u> TO <u> </u> FT.

WELL DEVELOPMENT	
DEVELOPMENT METHOD:	<u>AIR LIFT</u>
TIME DEVELOPING:	<u>4</u> HOURS
WATER REMOVED:	<u>50</u> GALLONS
WATER ADDED:	<u>0</u> GALLONS
WATER CLARITY BEFORE / AFTER DEVELOPMENT	
CLARITY BEFORE:	<u>VERY TURBID</u>
COLOR BEFORE:	<u>BROWN /GREY</u>
CLARITY AFTER:	<u>CLEAR</u>
COLOR AFTER:	<u>NONE</u>
ODOR (IF PRESENT):	<u>NOT MEASURED</u>

WATER LEVEL SUMMARY				
MEASUREMENT (FEET)			DATE	TIME
DTB BEFORE DEVELOPING:	135.07	T/PVC	3/8/2016	--
DTB AFTER DEVELOPING:	142.85	T/PVC	4/13/2016	10:01
SWL BEFORE DEVELOPING:	19.62	T/PVC	3/15/2016	14:30
SWL AFTER DEVELOPING:	14.90	T/PVC	3/18/2016	7:30
OTHER SWL:	17.65	T/PVC	4/13/2016	10:01
OTHER SWL:		T/PVC		

NOTES:

PROTECTIVE CASING DETAILS		
PERMANENT, LEGIBLE WELL LABEL ADDED?	<input checked="" type="checkbox"/> YES	<input type="checkbox"/> NO
PROTECTIVE COVER AND LOCK INSTALLED?	<input checked="" type="checkbox"/> YES	<input type="checkbox"/> NO
LOCK KEY NUMBER:	<u>3120</u>	



WELL CONSTRUCTION DIAGRAM

PROJ. NAME: DTE Electric Company Belle River Power Plant	WELL ID: MW-16-07
PROJ. NO: 231828.0003	DATE INSTALLED: 3/9/2016 INSTALLED BY: A. Knutson CHECKED BY: C. Scieszka

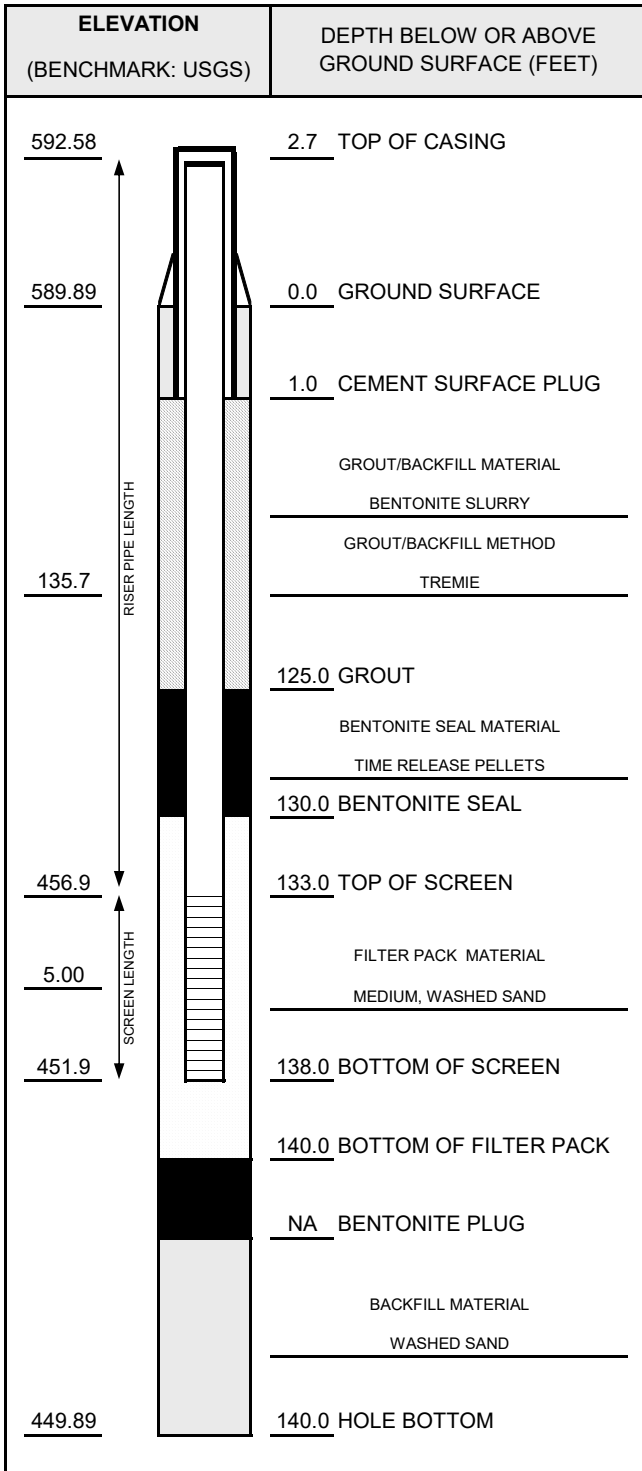

CASING AND SCREEN DETAILS	
TYPE OF RISER:	<u>2-INCH PVC</u>
PIPE SCHEDULE:	<u>40</u>
PIPE JOINTS:	<u>THREADED O-RINGS</u>
SCREEN TYPE:	<u>2-INCH PVC</u>
SCR. SLOT SIZE:	<u>0.01-INCH</u>
BOREHOLE DIAMETER:	<u>6</u> IN. FROM <u>0</u> TO <u>140</u> FT. <u> </u> IN. FROM <u> </u> TO <u> </u> FT.
SURF. CASING DIAMETER:	<u> </u> IN. FROM <u> </u> TO <u> </u> FT. <u> </u> IN. FROM <u> </u> TO <u> </u> FT.

WELL DEVELOPMENT	
DEVELOPMENT METHOD:	<u>AIR LIFT</u>
TIME DEVELOPING:	<u>4</u> HOURS
WATER REMOVED:	<u>120</u> GALLONS
WATER ADDED:	<u>0</u> GALLONS
WATER CLARITY BEFORE / AFTER DEVELOPMENT	
CLARITY BEFORE:	<u>VERY TURBID</u>
COLOR BEFORE:	<u>BROWN /GREY</u>
CLARITY AFTER:	<u>CLEAR</u>
COLOR AFTER:	<u>NONE</u>
ODOR (IF PRESENT):	<u>NONE</u>

WATER LEVEL SUMMARY				
	MEASUREMENT (FEET)		DATE	TIME
DTB BEFORE DEVELOPING:	138.02	T/PVC	3/9/2016	--
DTB AFTER DEVELOPING:	141.19	T/PVC	4/13/2016	11:56
SWL BEFORE DEVELOPING:	14.66	T/PVC	3/15/2016	--
SWL AFTER DEVELOPING:	14.25	T/PVC	3/18/2016	--
OTHER SWL:	16.83	T/PVC	4/13/2016	11:56
OTHER SWL:		T/PVC		

NOTES:

PROTECTIVE CASING DETAILS		
PERMANENT, LEGIBLE WELL LABEL ADDED?	<input checked="" type="checkbox"/> YES	<input type="checkbox"/> NO
PROTECTIVE COVER AND LOCK INSTALLED?	<input checked="" type="checkbox"/> YES	<input type="checkbox"/> NO
LOCK KEY NUMBER:	<u>3120</u>	



WELL CONSTRUCTION DIAGRAM

PROJ. NAME: DTE Electric Company Belle River Power Plant	WELL ID: MW-16-08
PROJ. NO: 231828.0003	DATE INSTALLED: 3/10/2016 INSTALLED BY: A. Knutson CHECKED BY: C. Scieszka

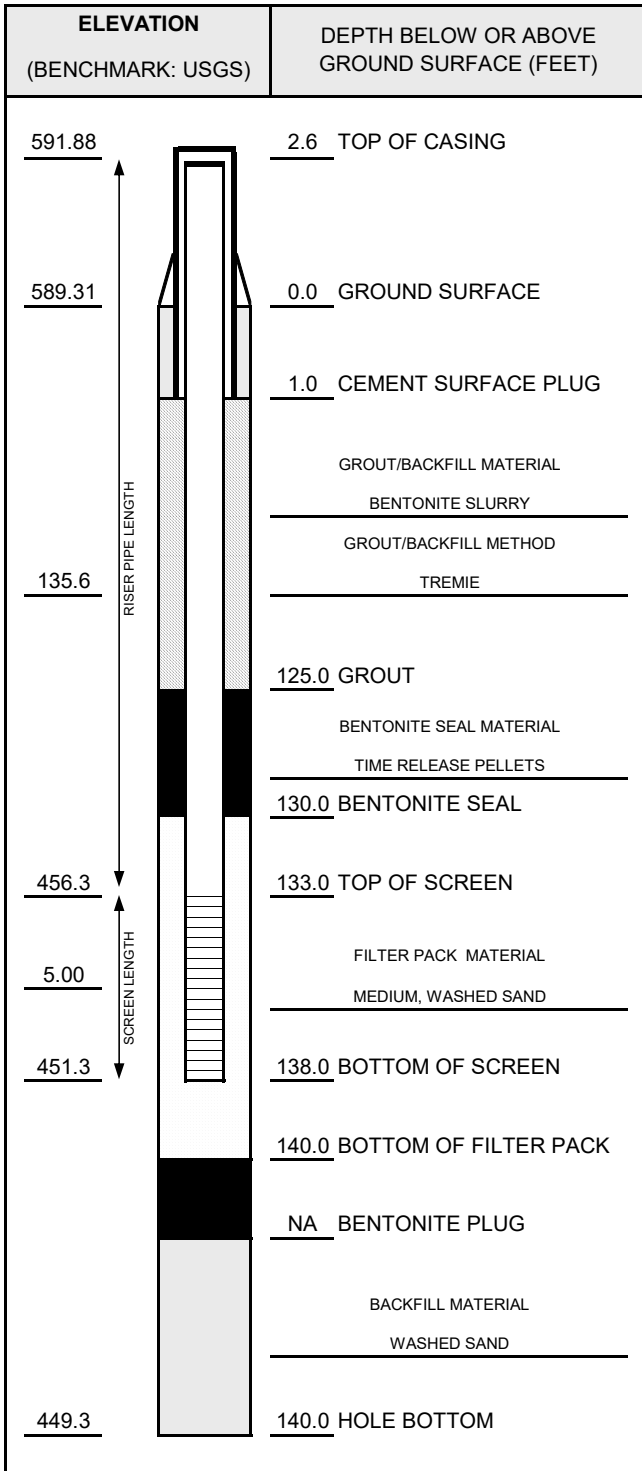

CASING AND SCREEN DETAILS	
TYPE OF RISER:	<u>2-INCH PVC</u>
PIPE SCHEDULE:	<u>40</u>
PIPE JOINTS:	<u>THREADED O-RINGS</u>
SCREEN TYPE:	<u>2-INCH PVC</u>
SCR. SLOT SIZE:	<u>0.01-INCH</u>
BOREHOLE DIAMETER:	<u>6</u> IN. FROM <u>0</u> TO <u>140</u> FT. <u> </u> IN. FROM <u> </u> TO <u> </u> FT.
SURF. CASING DIAMETER:	<u> </u> IN. FROM <u> </u> TO <u> </u> FT. <u> </u> IN. FROM <u> </u> TO <u> </u> FT.

WELL DEVELOPMENT	
DEVELOPMENT METHOD:	<u>AIR LIFT</u>
TIME DEVELOPING:	<u>4</u> HOURS
WATER REMOVED:	<u>125</u> GALLONS
WATER ADDED:	<u>0</u> GALLONS
WATER CLARITY BEFORE / AFTER DEVELOPMENT	
CLARITY BEFORE:	<u>VERY TURBID</u>
COLOR BEFORE:	<u>BROWN /GREY</u>
CLARITY AFTER:	<u>CLEAR</u>
COLOR AFTER:	<u>NONE</u>
ODOR (IF PRESENT):	<u>NONE</u>

WATER LEVEL SUMMARY				
	MEASUREMENT (FEET)		DATE	TIME
DTB BEFORE DEVELOPING:	137.94	T/PVC	3/11/2016	--
DTB AFTER DEVELOPING:	140.80	T/PVC	4/13/2016	12:00
SWL BEFORE DEVELOPING:	14.23	T/PVC	3/15/2016	14:30
SWL AFTER DEVELOPING:	14.23	T/PVC	3/18/2016	7:30
OTHER SWL:	15.79	T/PVC	4/13/2016	12:00
OTHER SWL:		T/PVC		

NOTES:

PROTECTIVE CASING DETAILS		
PERMANENT, LEGIBLE WELL LABEL ADDED?	<input checked="" type="checkbox"/> YES	<input type="checkbox"/> NO
PROTECTIVE COVER AND LOCK INSTALLED?	<input checked="" type="checkbox"/> YES	<input type="checkbox"/> NO
LOCK KEY NUMBER:	<u>3120</u>	



WELL CONSTRUCTION DIAGRAM

PROJ. NAME: DTE Electric Company Belle River Power Plant	WELL ID: MW-16-09
PROJ. NO: 231828.0003	DATE INSTALLED: 6/2/2016 INSTALLED BY: J. Reed CHECKED BY: M. Powers

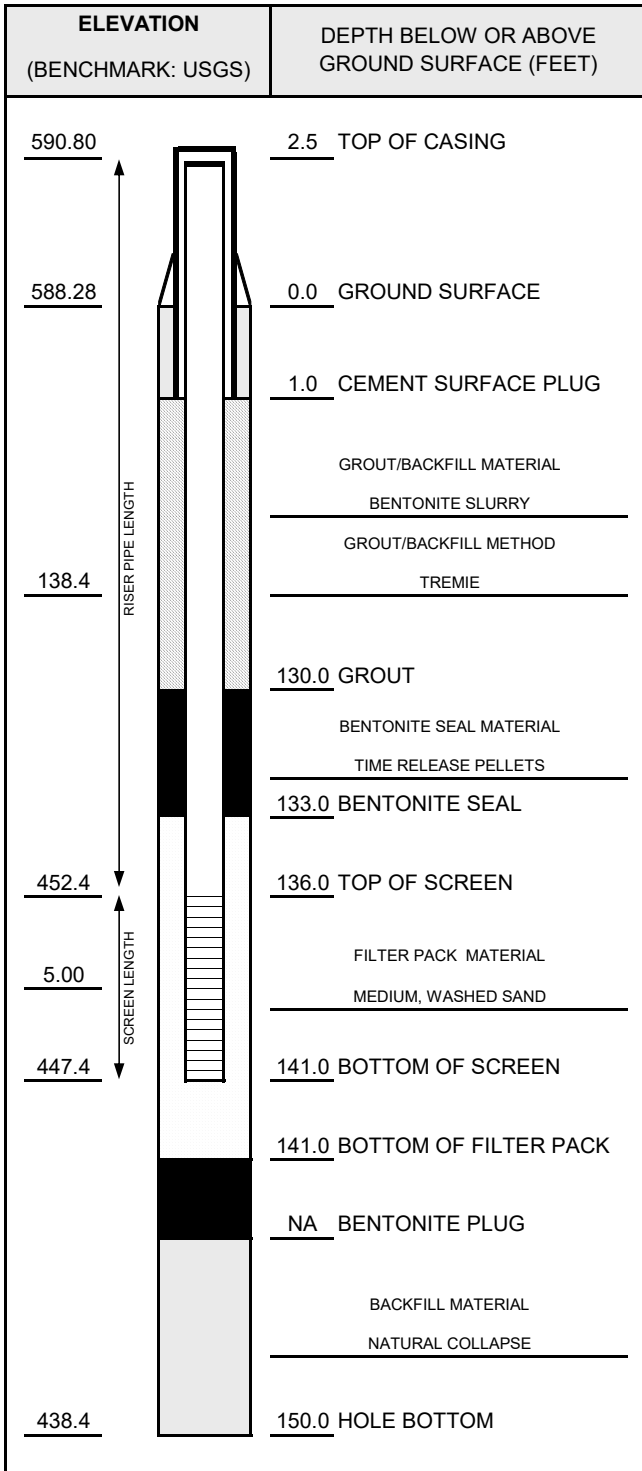

CASING AND SCREEN DETAILS	
TYPE OF RISER:	<u>2-INCH PVC</u>
PIPE SCHEDULE:	<u>40</u>
PIPE JOINTS:	<u>THREADED O-RINGS</u>
SCREEN TYPE:	<u>2-INCH PVC</u>
SCR. SLOT SIZE:	<u>0.01-INCH</u>
BOREHOLE DIAMETER:	<u>6</u> IN. FROM <u>0</u> TO <u>150</u> FT. <u> </u> IN. FROM <u> </u> TO <u> </u> FT.
SURF. CASING DIAMETER:	<u> </u> IN. FROM <u> </u> TO <u> </u> FT. <u> </u> IN. FROM <u> </u> TO <u> </u> FT.

WELL DEVELOPMENT	
DEVELOPMENT METHOD:	<u>AIR LIFT</u>
TIME DEVELOPING:	<u>7</u> HOURS
WATER REMOVED:	<u>30</u> GALLONS
WATER ADDED:	<u>0</u> GALLONS
WATER CLARITY BEFORE / AFTER DEVELOPMENT	
CLARITY BEFORE:	<u>TURBID</u>
COLOR BEFORE:	<u>GRAY</u>
CLARITY AFTER:	<u>VERY TURBID</u>
COLOR AFTER:	<u>GRAY</u>
ODOR (IF PRESENT):	<u>NONE</u>

WATER LEVEL SUMMARY				
	MEASUREMENT (FEET)		DATE	TIME
DTB BEFORE DEVELOPING:	140.00	T/PVC	6/7/2016	12:00
DTB AFTER DEVELOPING:	140.00	T/PVC	6/8/2016	10:25
SWL BEFORE DEVELOPING:	7.00	T/PVC	6/7/2016	12:00
SWL AFTER DEVELOPING:	117.42	T/PVC	6/8/2016	10:25
OTHER SWL:	16.76	T/PVC	6/9/2016	15:13
OTHER DTB:	144.30	T/PVC	6/9/2016	15:13

PROTECTIVE CASING DETAILS		
PERMANENT, LEGIBLE WELL LABEL ADDED?	<input checked="" type="checkbox"/> YES	<input type="checkbox"/> NO
PROTECTIVE COVER AND LOCK INSTALLED?	<input checked="" type="checkbox"/> YES	<input type="checkbox"/> NO
LOCK KEY NUMBER:	<u>3120</u>	

NOTES:



WELL CONSTRUCTION DIAGRAM

PROJ. NAME: DTE Electric Company Belle River Power Plant	WELL ID: MW-16-10
PROJ. NO: 231828.0003	DATE INSTALLED: 6/6/2016
INSTALLED BY: J. Reed	CHECKED BY: M. Powers

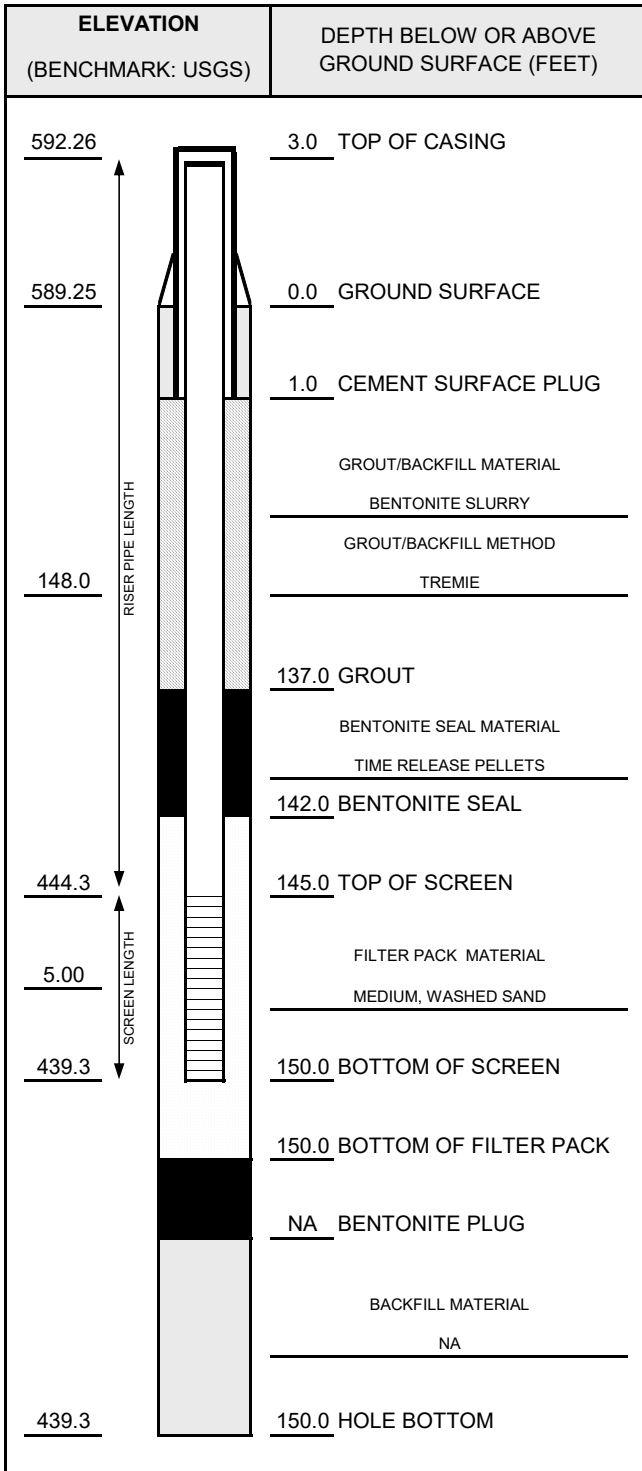

CASING AND SCREEN DETAILS	
TYPE OF RISER:	<u>2-INCH PVC</u>
PIPE SCHEDULE:	<u>40</u>
PIPE JOINTS:	<u>THREADED O-RINGS</u>
SCREEN TYPE:	<u>2-INCH PVC</u>
SCR. SLOT SIZE:	<u>0.01-INCH</u>
BOREHOLE DIAMETER:	<u>6</u> IN. FROM <u>0</u> TO <u>150</u> FT. <u> </u> IN. FROM <u> </u> TO <u> </u> FT.
SURF. CASING DIAMETER:	<u> </u> IN. FROM <u> </u> TO <u> </u> FT. <u> </u> IN. FROM <u> </u> TO <u> </u> FT.

WELL DEVELOPMENT	
DEVELOPMENT METHOD:	<u>AIR LIFT</u>
TIME DEVELOPING:	<u>4.5</u> HOURS
WATER REMOVED:	<u>85</u> GALLONS
WATER ADDED:	<u>60</u> GALLONS
WATER CLARITY BEFORE / AFTER DEVELOPMENT	
CLARITY BEFORE:	<u>VERY TURBID</u>
COLOR BEFORE:	<u>DARK GRAY</u>
CLARITY AFTER:	<u>VERY TURBID</u>
COLOR AFTER:	<u>DARK GRAY</u>
ODOR (IF PRESENT):	<u>NONE</u>

WATER LEVEL SUMMARY				
MEASUREMENT (FEET)			DATE	TIME
DTB BEFORE DEVELOPING:	151.30	T/PVC	6/9/2016	7:45
DTB AFTER DEVELOPING:	152.28	T/PVC	6/9/2016	16:50
SWL BEFORE DEVELOPING:	17.80	T/PVC	6/9/2016	7:45
SWL AFTER DEVELOPING:	59.44	T/PVC	6/9/2016	16:50
OTHER SWL:		T/PVC		
OTHER SWL:		T/PVC		

PROTECTIVE CASING DETAILS		
PERMANENT, LEGIBLE WELL LABEL ADDED?	<input checked="" type="checkbox"/> YES	<input type="checkbox"/> NO
PROTECTIVE COVER AND LOCK INSTALLED?	<input checked="" type="checkbox"/> YES	<input type="checkbox"/> NO
LOCK KEY NUMBER:	<u>3120</u>	

NOTES:



WELL CONSTRUCTION DIAGRAM

PROJ. NAME: DTE Electric Company Belle River Power Plant	WELL ID: MW-16-11
PROJ. NO: 231828.0003	DATE INSTALLED: 6/7/2016
INSTALLED BY: J. Reed	CHECKED BY: M. Powers

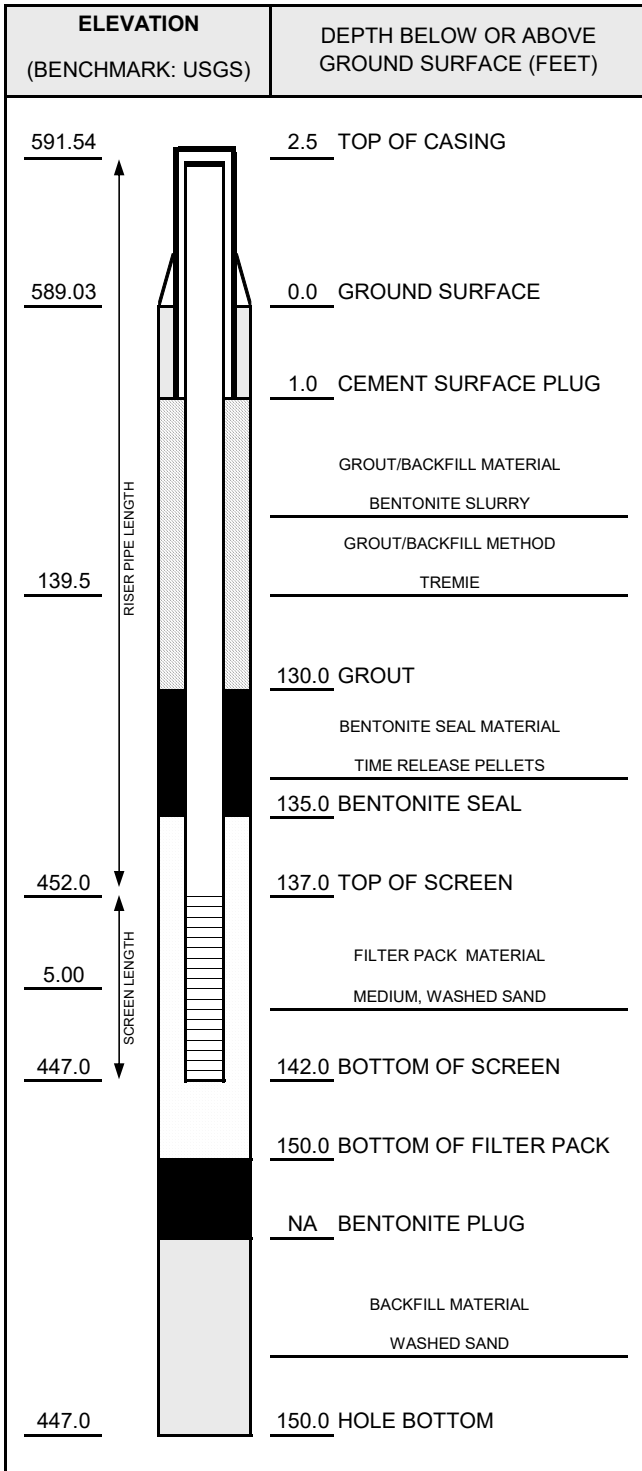

CASING AND SCREEN DETAILS	
TYPE OF RISER:	<u>2-INCH PVC</u>
PIPE SCHEDULE:	<u>40</u>
PIPE JOINTS:	<u>THREADED O-RINGS</u>
SCREEN TYPE:	<u>2-INCH PVC</u>
SCR. SLOT SIZE:	<u>0.01-INCH</u>
BOREHOLE DIAMETER:	<u>6</u> IN. FROM <u>0</u> TO <u>150</u> FT. <u> </u> IN. FROM <u> </u> TO <u> </u> FT.
SURF. CASING DIAMETER:	<u> </u> IN. FROM <u> </u> TO <u> </u> FT. <u> </u> IN. FROM <u> </u> TO <u> </u> FT.

WELL DEVELOPMENT	
DEVELOPMENT METHOD:	<u>AIR LIFT</u>
TIME DEVELOPING:	<u>3</u> HOURS
WATER REMOVED:	<u>84</u> GALLONS
WATER ADDED:	<u>60</u> GALLONS
WATER CLARITY BEFORE / AFTER DEVELOPMENT	
CLARITY BEFORE:	<u>VERY TURBID</u>
COLOR BEFORE:	<u>DARK GRAY</u>
CLARITY AFTER:	<u>VERY TURBID</u>
COLOR AFTER:	<u>GRAY</u>
ODOR (IF PRESENT):	<u>NONE</u>

WATER LEVEL SUMMARY				
	MEASUREMENT (FEET)		DATE	TIME
DTB BEFORE DEVELOPING:	141.36	T/PVC	6/9/2016	12:35
DTB AFTER DEVELOPING:	142.00	T/PVC	6/9/2016	15:45
SWL BEFORE DEVELOPING:	9.65	T/PVC	6/9/2016	12:35
SWL AFTER DEVELOPING:	116.00	T/PVC	6/9/2016	15:45
OTHER SWL:	16.67	T/PVC	6/21/2016	7:45
OTHER SWL:		T/PVC		

NOTES:

PROTECTIVE CASING DETAILS		
PERMANENT, LEGIBLE WELL LABEL ADDED?	<input checked="" type="checkbox"/> YES	<input type="checkbox"/> NO
PROTECTIVE COVER AND LOCK INSTALLED?	<input checked="" type="checkbox"/> YES	<input type="checkbox"/> NO
LOCK KEY NUMBER:	<u>3120</u>	



WELL CONSTRUCTION DIAGRAM

PROJ. NAME: DTE Electric Company Belle River Power Plant	WELL ID: MW-16-11A
PROJ. NO: 265996.0003	DATE INSTALLED: 5/12/2017 INSTALLED BY: Jake Krenz CHECKED BY: C. Scieszka

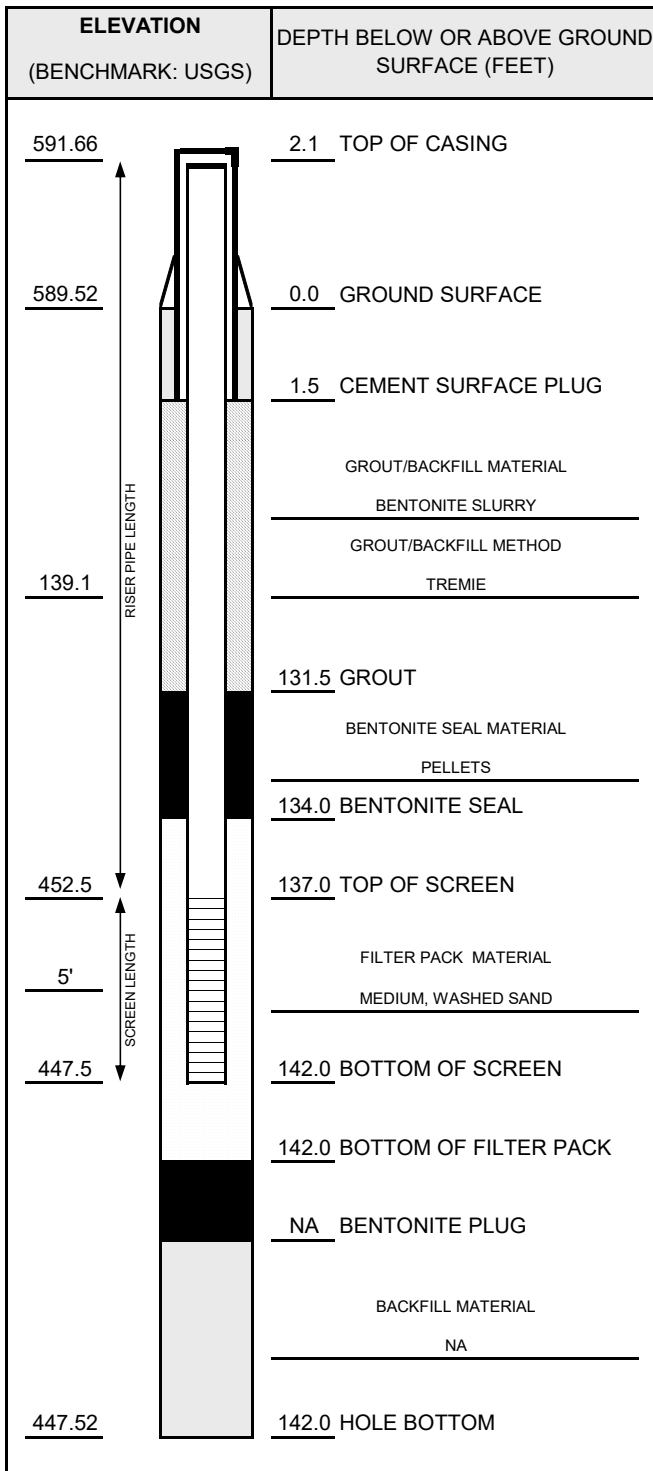

NOTES:

CASING AND SCREEN DETAILS	
TYPE OF RISER: <u>2-INCH PVC</u>	
PIPE SCHEDULE: <u>40</u>	
PIPE JOINTS: <u>THREADED O-RINGS</u>	
SOLVENT USED? <u>NO</u>	
SCREEN TYPE: <u>2-INCH PVC</u>	
SCR. SLOT SIZE: <u>0.01-INCH</u>	
BOREHOLE DIAMETER: <u>6</u> IN. FROM <u>0</u> TO <u>142</u> FT.	
	<u>NA</u> IN. FROM <u>NA</u> TO <u>NA</u> FT.
SURF. CASING DIAMETER: <u>NA</u> IN. FROM <u>NA</u> TO <u>NA</u> FT.	
	<u>NA</u> IN. FROM <u>NA</u> TO <u>NA</u> FT.

WELL DEVELOPMENT	
DEVELOPMENT METHOD: <u>AIR LIFT</u>	
TIME DEVELOPING: <u>3</u> HOURS	
WATER REMOVED: <u>110</u> GALLONS	
WATER ADDED: <u>0</u> GALLONS	
WATER CLARITY BEFORE / AFTER DEVELOPMENT	
CLARITY BEFORE: <u>Very Turbid</u>	
COLOR BEFORE: <u>Dark Gray</u>	
CLARITY AFTER: <u>Very Turbid</u>	
COLOR AFTER: <u>Light Gray</u>	
ODOR (IF PRESENT): <u>None</u>	

WATER LEVEL SUMMARY				
	MEASUREMENT (FEET)		DATE	TIME
DTB BEFORE DEVELOPING:	141.98	T/PVC	5/15/2017	0838
DTB AFTER DEVELOPING:	145.45	T/PVC	5/15/2017	1612
SWE BEFORE DEVELOPING:	17.79	T/PVC	5/15/2017	0838
SWE AFTER DEVELOPING:	90.12	T/PVC	5/15/2017	1612
OTHER SWE:		T/PVC		
OTHER SWE:		T/PVC		

PROTECTIVE CASING DETAILS	
PERMANENT, LEGIBLE WELL LABEL ADDED?	<input checked="" type="checkbox"/> YES <input type="checkbox"/> NO
PROTECTIVE COVER AND LOCK INSTALLED?	<input checked="" type="checkbox"/> YES <input type="checkbox"/> NO
LOCK KEY NUMBER: <u>3120</u>	

APPENDIX C - 1970s BORING LOGS

LOCATION: N 7,495 E 8,304 GROUND ELEVATION 586.5

DATE DRILLED: 11-26-73
12-3-73
SHEET 1 OF 1

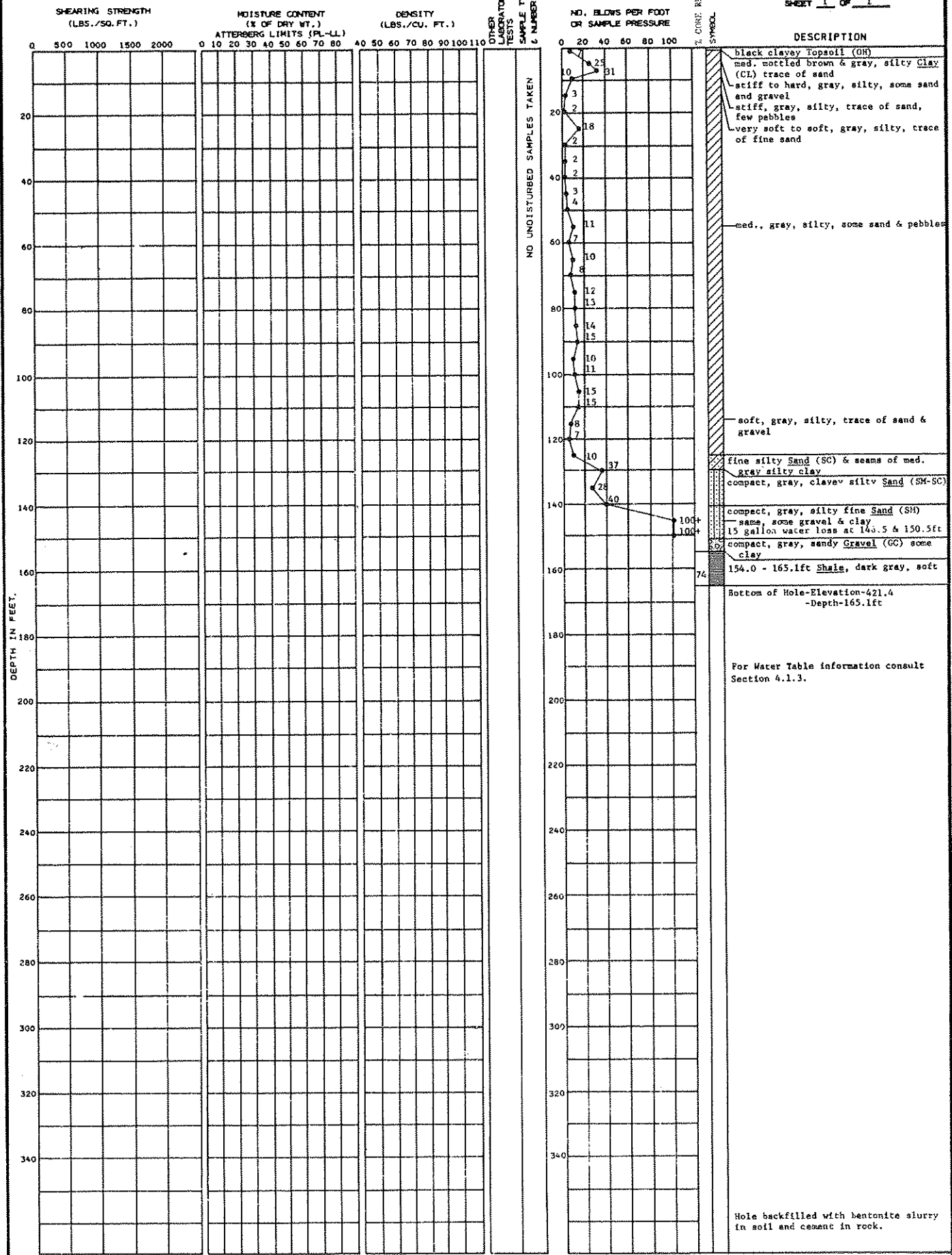

LOCATION: N 8,600
E 9,965

GROUND ELEVATION 503.1

DATE DRILLED: 11-9-73

SHEET 1 OF 1

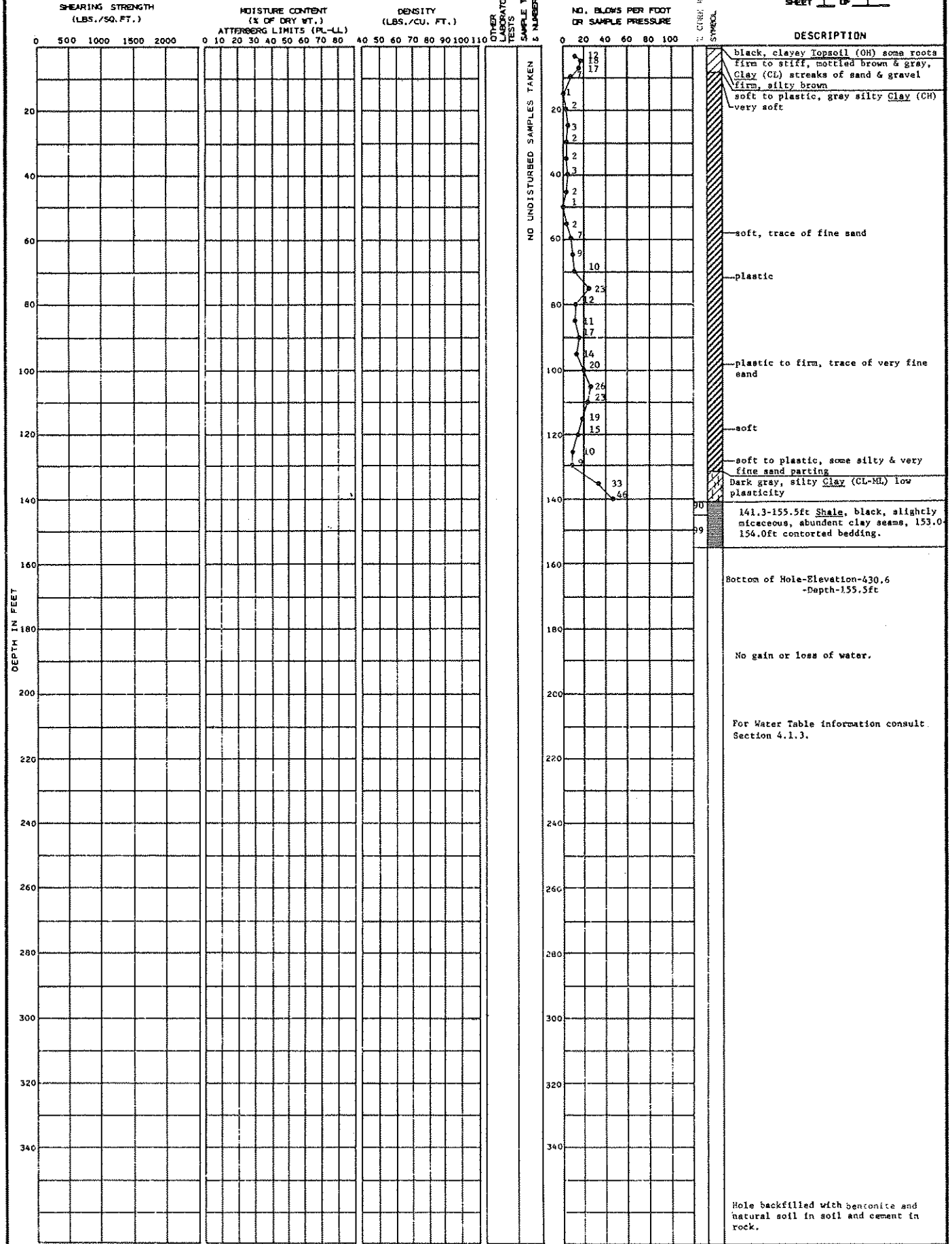

SOIL BORING NO. 10

LOCATION: N 7,884 E 9,005 GROUND ELEVATION 586.8

DATE DRILLED: 2-11-74
2-18-74

SHEET 1 OF 1

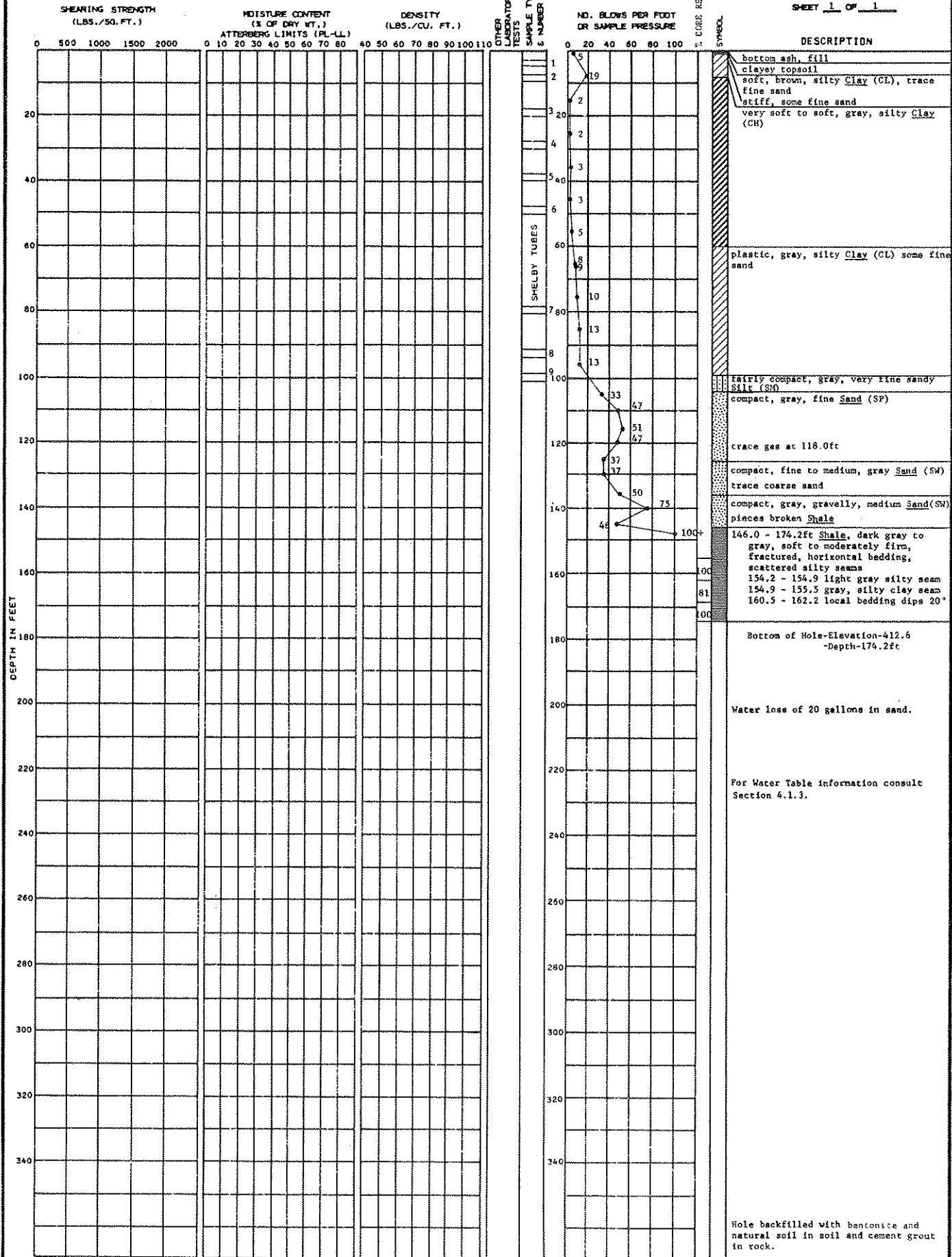

LOCATION: N 8,306
E 9,627

GROUND ELEVATION 586.6

DATE DRILLED: 1-28-74
1-31-76
SHEET 1 OF 1

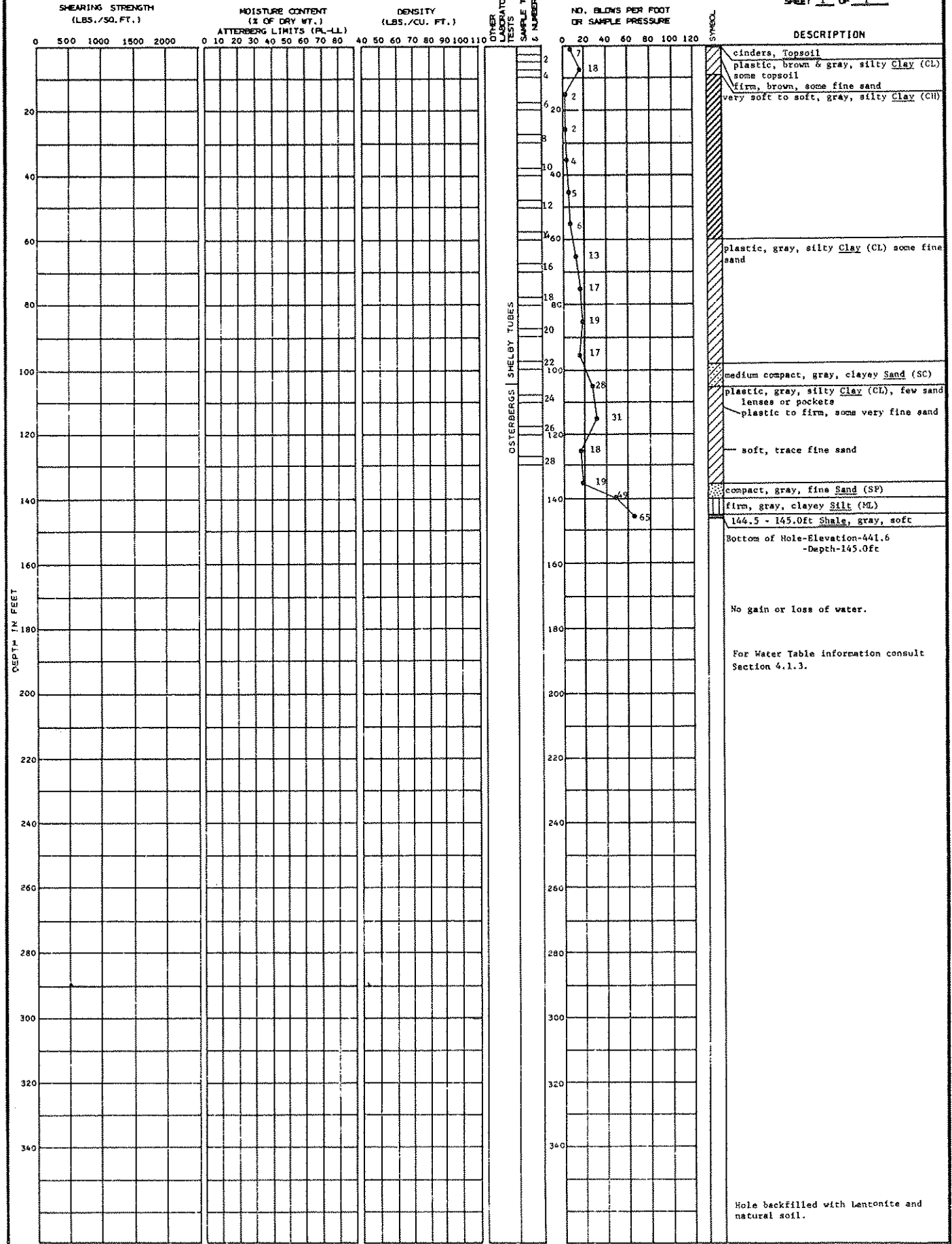

SOIL BORING NO. 14

BECHTEL Belle River

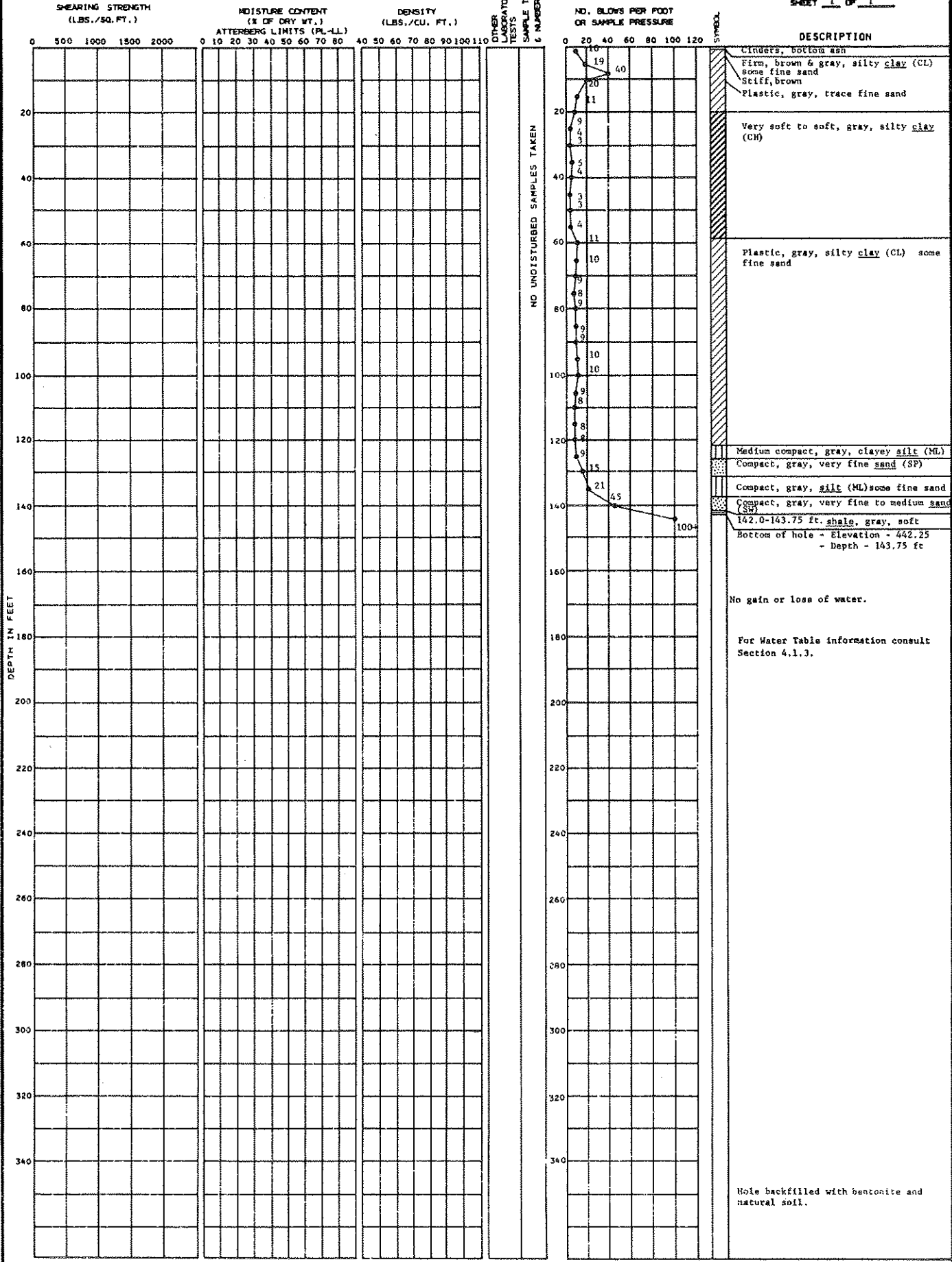

LOCATION: N 8,081 E 9,193 GROUND ELEVATION 586.0

DATE DRILLED: 1-16-74 1-29-74

SHEET 1 OF 1

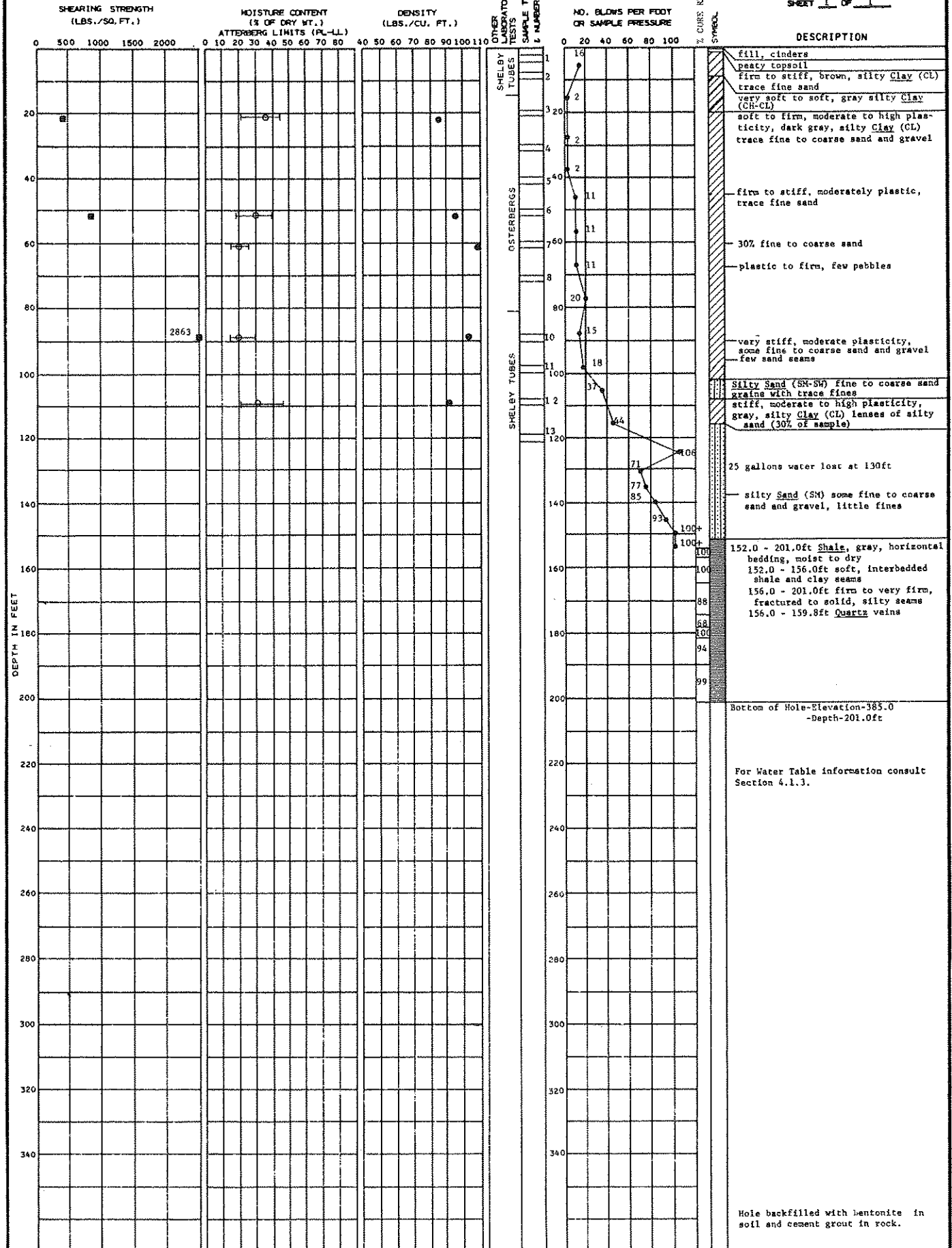

Unconsolidated Undrained Atterberg Limits Moisture Content

SOIL BORING NO. 18

BECHTEL Belle River

LOCATION: N 9,011 E 9,337 GROUND ELEVATION 586.5

DATE DRILLED: 1-17-74
1-23-74

SHEET 1 OF 1

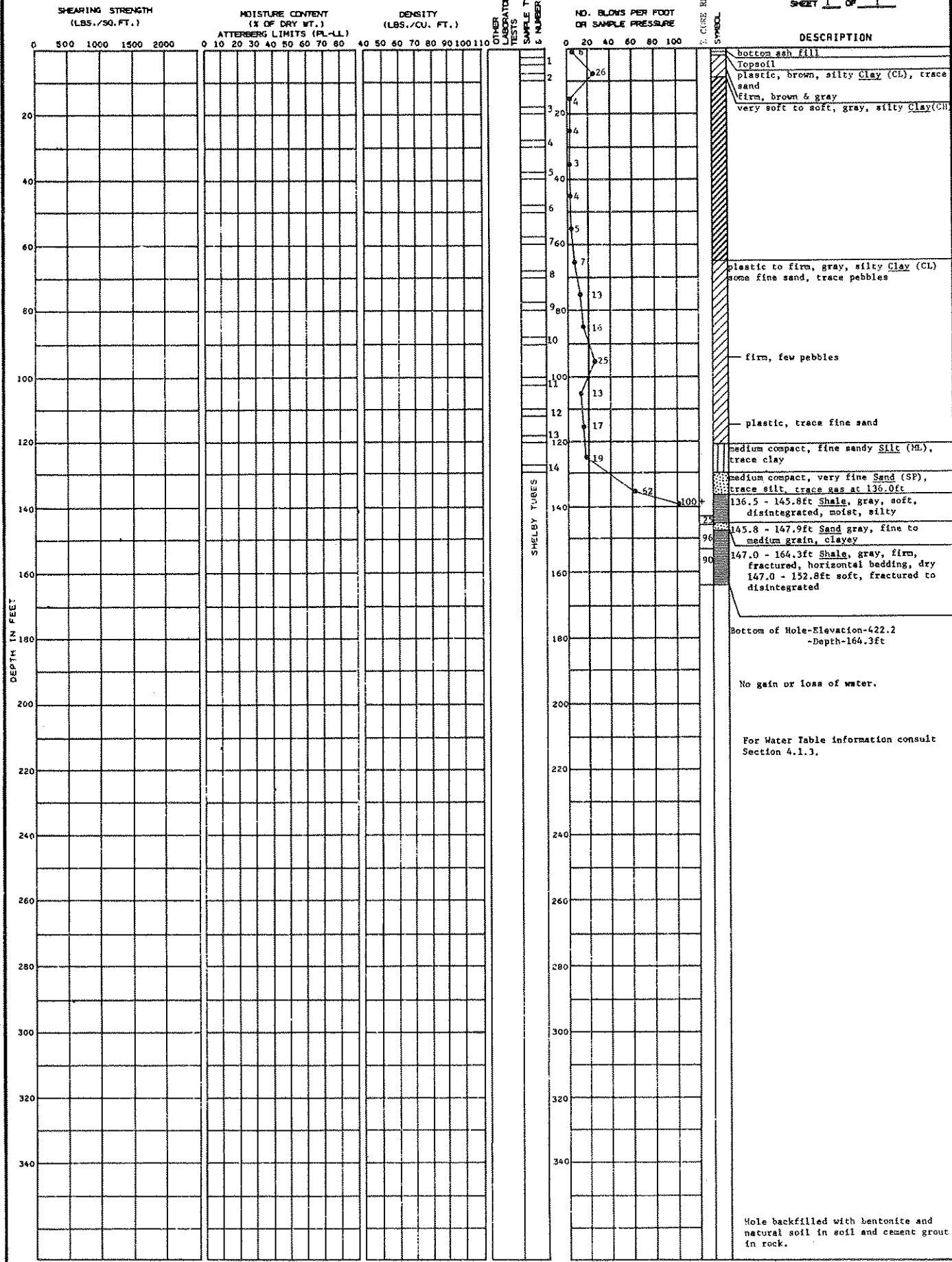

LOCATION: N.8,002
E.9,943

GROUND ELEVATION: 385.9

DATE DRILLED: 11-20-73

SHEET 1 OF 1

DEPTH IN FEET	SHEARING STRENGTH (LBS./SQ. FT.)	MOISTURE CONTENT (% OF DRY WT.)	DENSITY (LBS./CU. FT.)	OTHER LABORATORY TESTS	NO. UNDISTURBED SAMPLES TAKEN	NO. BLOWS PER FOOT OR SAMPLE PRESSURE	SYMBOL	DESCRIPTION
0								black clayey Topsoil (OH)
0						19		Firm to stiff, mottled brown, silty Clay (CL) trace of sand.
0						24		Plastic, gray, silty, some fine sand
0						2		very soft gray silty Clay (CH)
20						1		
20						2		
20						8		plastic, dark gray sandy Clay (CL) some pebbles.
20						2		soft, gray silty Clay (CH)
40						2		
40						2		
40						4		
40						8		
60						9		soft to plastic gray silty Clay (CL) some fine sand
60						11		
60						24		med., gray, silty
60						12		some sand & gravel
60						17		med., gray, silty
60						12		trace of sand, a few pebbles
80						17		
80						12		
80						13		
80						14		
100						16		
100						16		
100						18		
100						17		
120						12		med., gray silty Clay (CH)
120						11		Slight to low plasticity, dark gray, clayey Silt (CL-M)
120						15		138.5-160.5ft Shale, black, slightly micaceous, highly weathered to a depth of 140.75ft, crumbles easily.
140							93	
140							97	
160								Bottom of Hole-Elevation-425.4 -Depth-160.5ft
180								No gain or loss of water
200								For Water Table information consult Section 4.1.3.
220								
240								
260								
280								
300								
320								Hole backfilled with bentonite slurry in soil and cement grout in rock
340								

LOCATION: N 7,904
E 9,436

GROUND ELEVATION 586.3

DATE DRILLED: 1-30-74
2-5-74

SHEET 1 OF 1

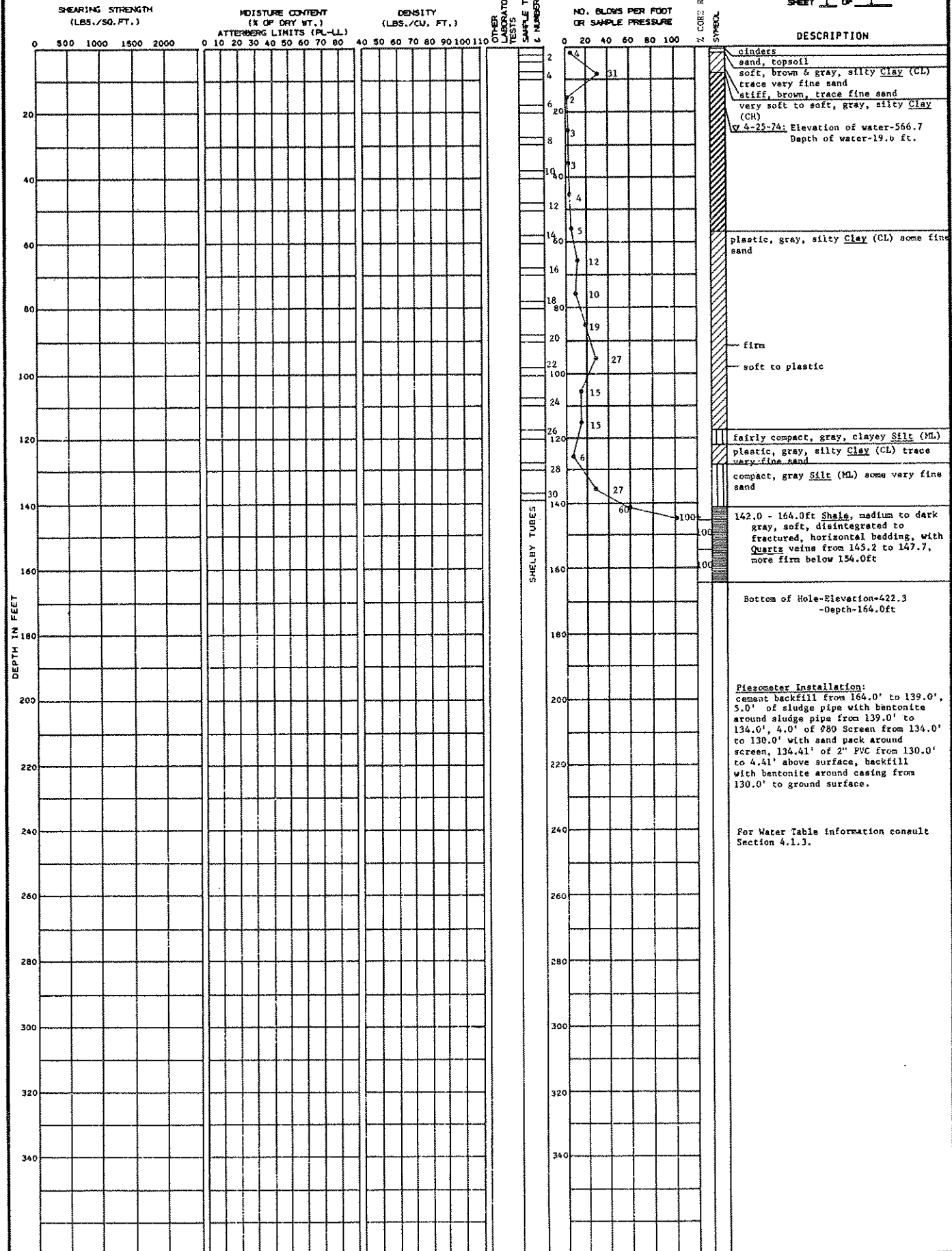

SOIL BORING NO. 24

BECHTEL Belle River

LOCATION: N 7,890
E 9,763

GROUND ELEVATION 585.6

DATE DRILLED: 12-12-73
12-19-73

SHEET 1 OF 1

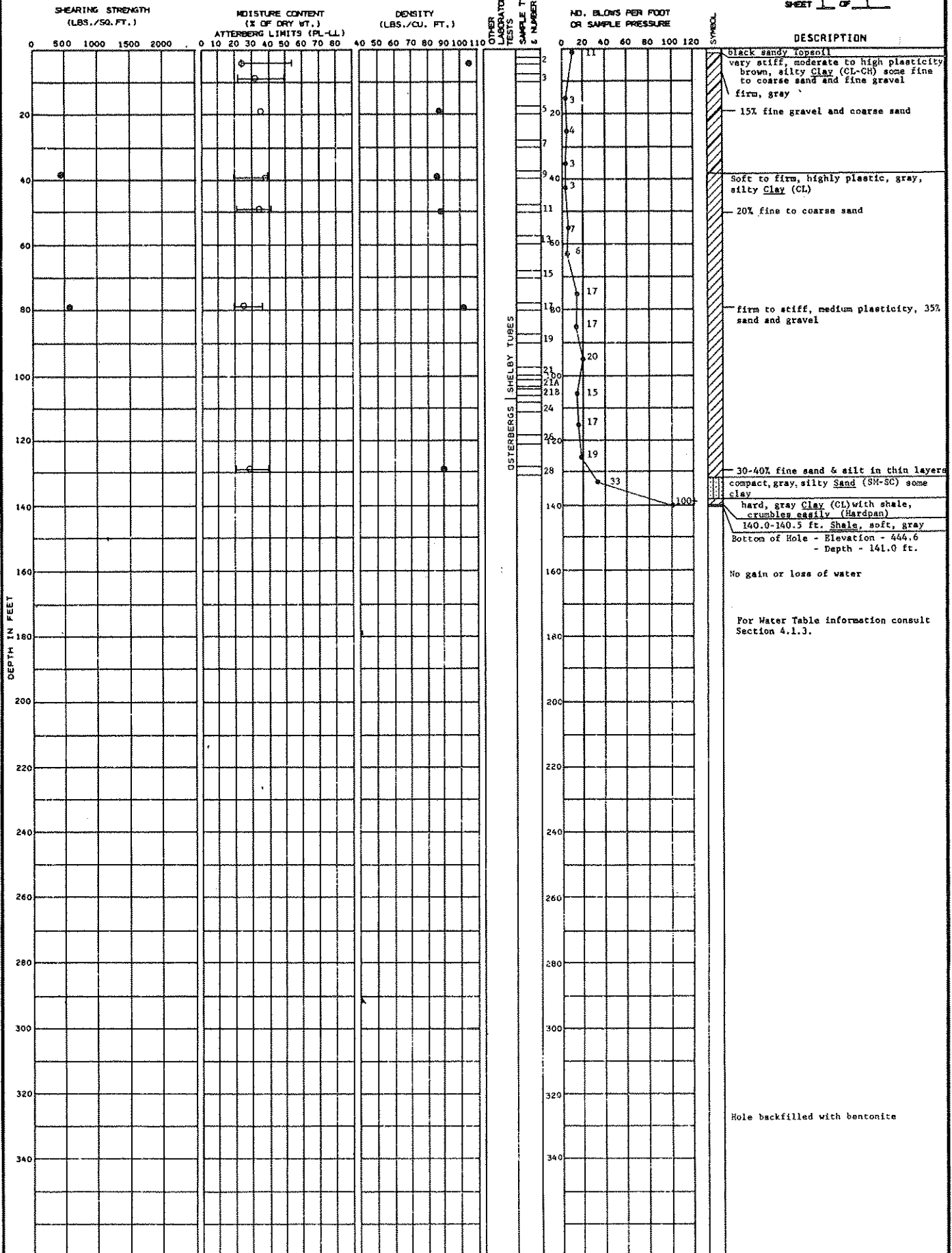

● Unconfined Compression
○ Atterberg Limits
○ Moisture Content

SOIL BORING NO. 26

BECHTEL Belle River

B-33

LOCATION: N 7,724 E 9,443 GROUND ELEVATION 585.8

DATE DRILLED: 1-15-74
1-22-74

SHEET 1 OF 1

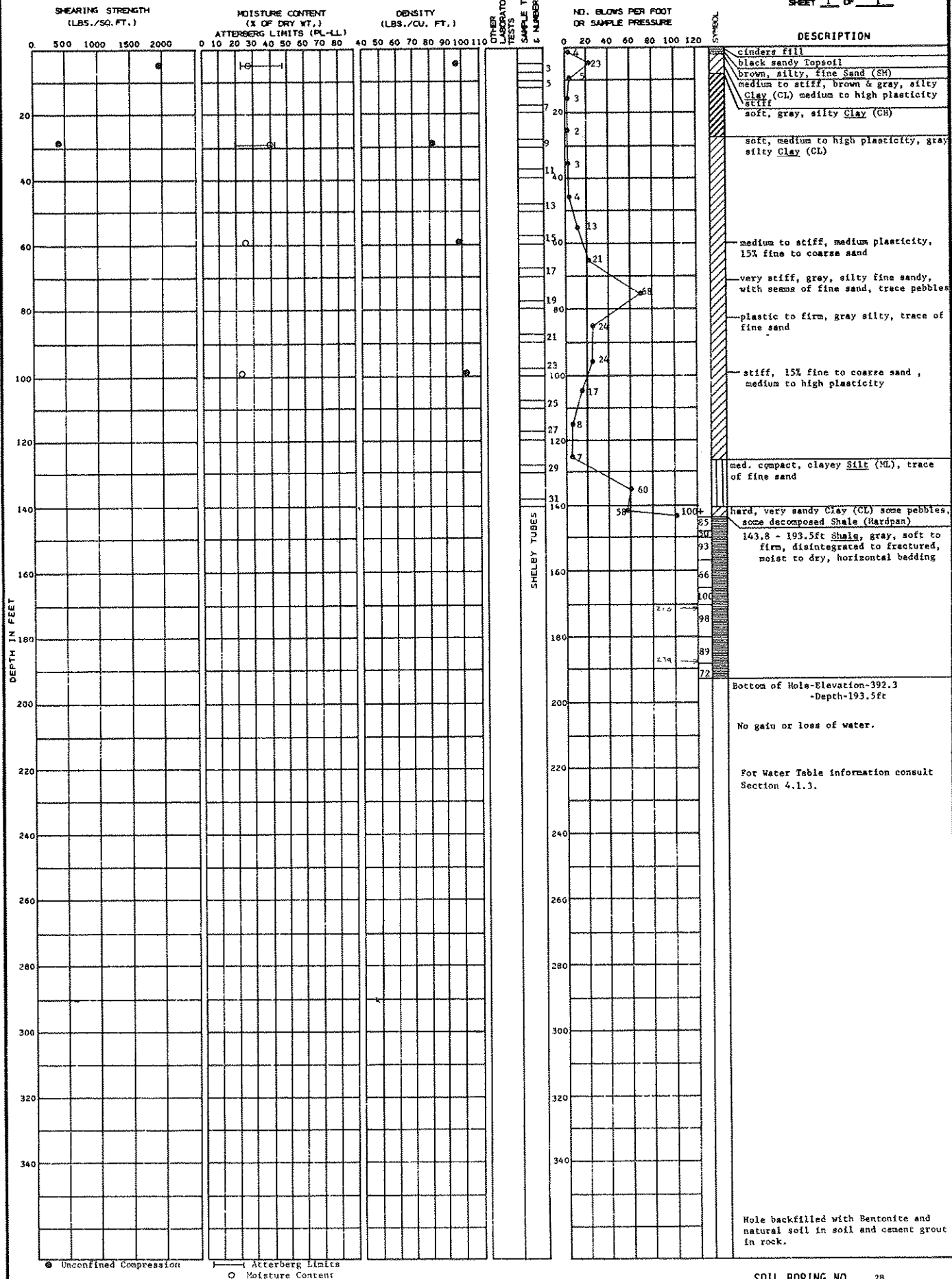

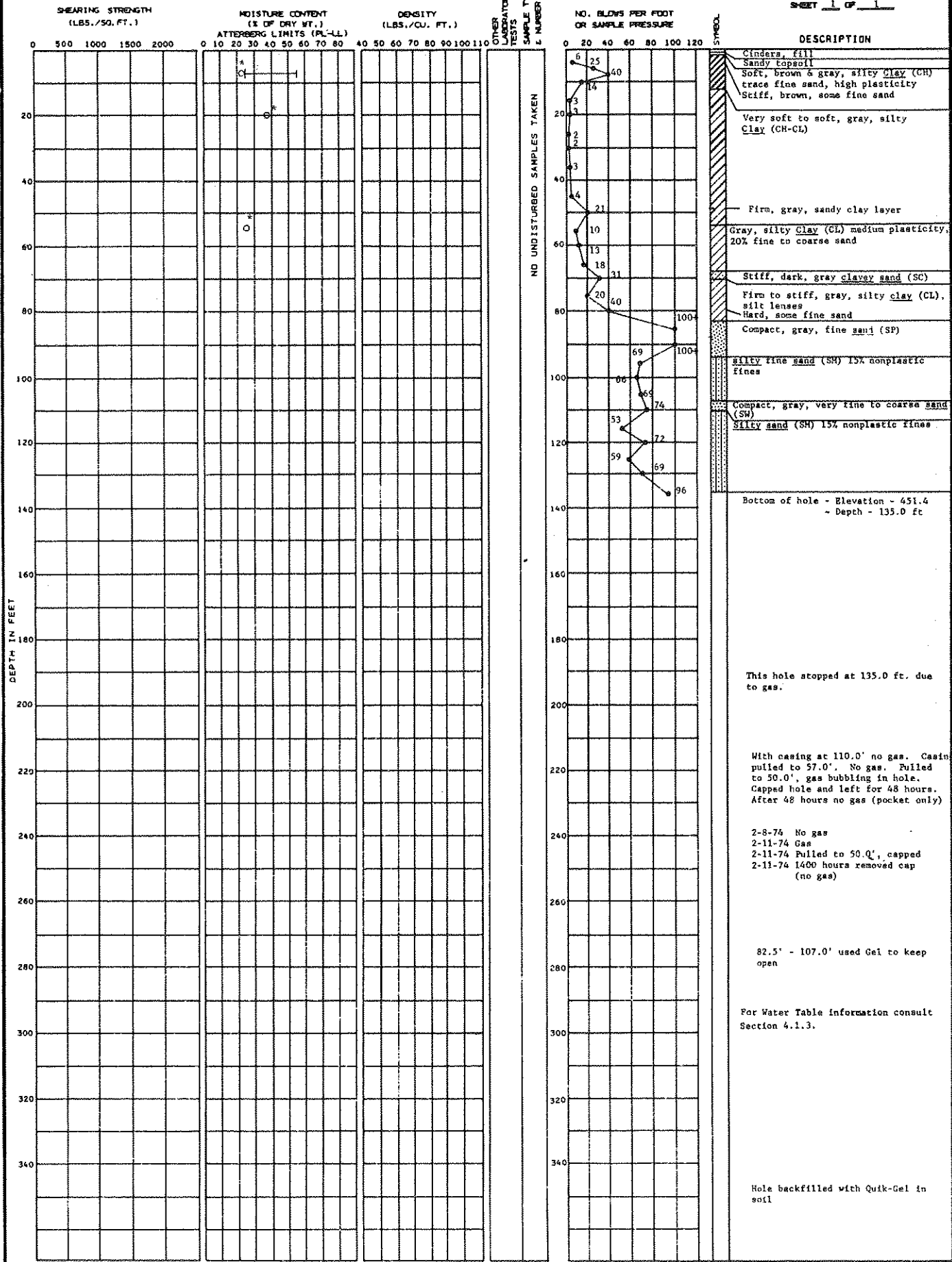

DESCRIPTION

Cinders, fill
Sandy topsoil
Soft, brown & gray, silty Clay (CH)
trace fine sand, high plasticity
Stiff, brown, some fine sand

Very soft to soft, gray, silty Clay (CH-CL)

Firm, gray, sandy clay layer

Gray, silty Clay (CL) medium plasticity, 20% fine to coarse sand

Stiff, dark, gray clayey sand (SC)

Firm to stiff, gray, silty clay (CL), silt lenses
Hard, some fine sand

Compact, gray, fine sand (SP)

silty fine sand (SM) 15% nonplastic fines

Compact, gray, very fine to coarse sand (SW)

Silty sand (SM) 15% nonplastic fines

Bottom of hole - Elevation - 451.4
- Depth - 135.0 ft

This hole stopped at 135.0 ft. due to gas.

With casing at 110.0' no gas. Casing pulled to 57.0'. No gas. Pulled to 50.0', gas bubbling in hole. Capped hole and left for 48 hours. After 48 hours no gas (pocket only)

2-8-74 No gas
2-11-74 Gas
2-11-74 Pulled to 50.0', capped
2-11-74 1400 hours removed cap (no gas)

82.5' - 107.0' used Gel to keep open

For Water Table Information consult Section 4.1.3.

Hole backfilled with Quik-Gel in soil

Atterberg Limits
O Moisture Content
* Sample Jar Unsealed

LOCATION: N 7,663 E 2,659 GROUND ELEVATION 586.6

DATE DRILLED: 2-6-74
2-12-74

SHEET 1 OF 1

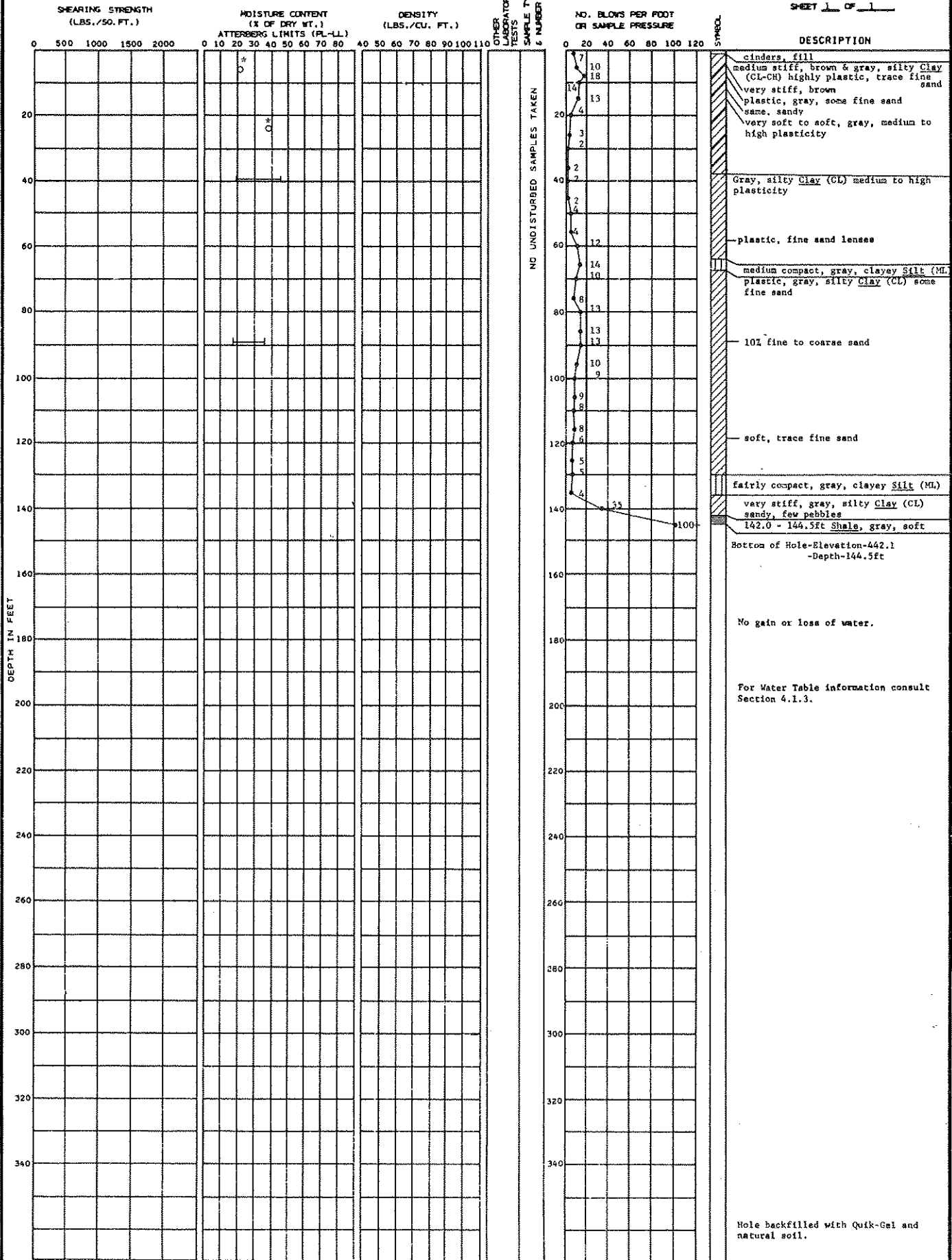

Atterberg Limits
 ○ Moisture Content
 * Sample Jar Unsealed

SOIL BORING NO. 32

BECHTEL Belle River

LOCATION: N 7,398 E 9,963 GROUND ELEVATION 586.0

DATE DRILLED: 11-8-73 SHEET 1 OF 1

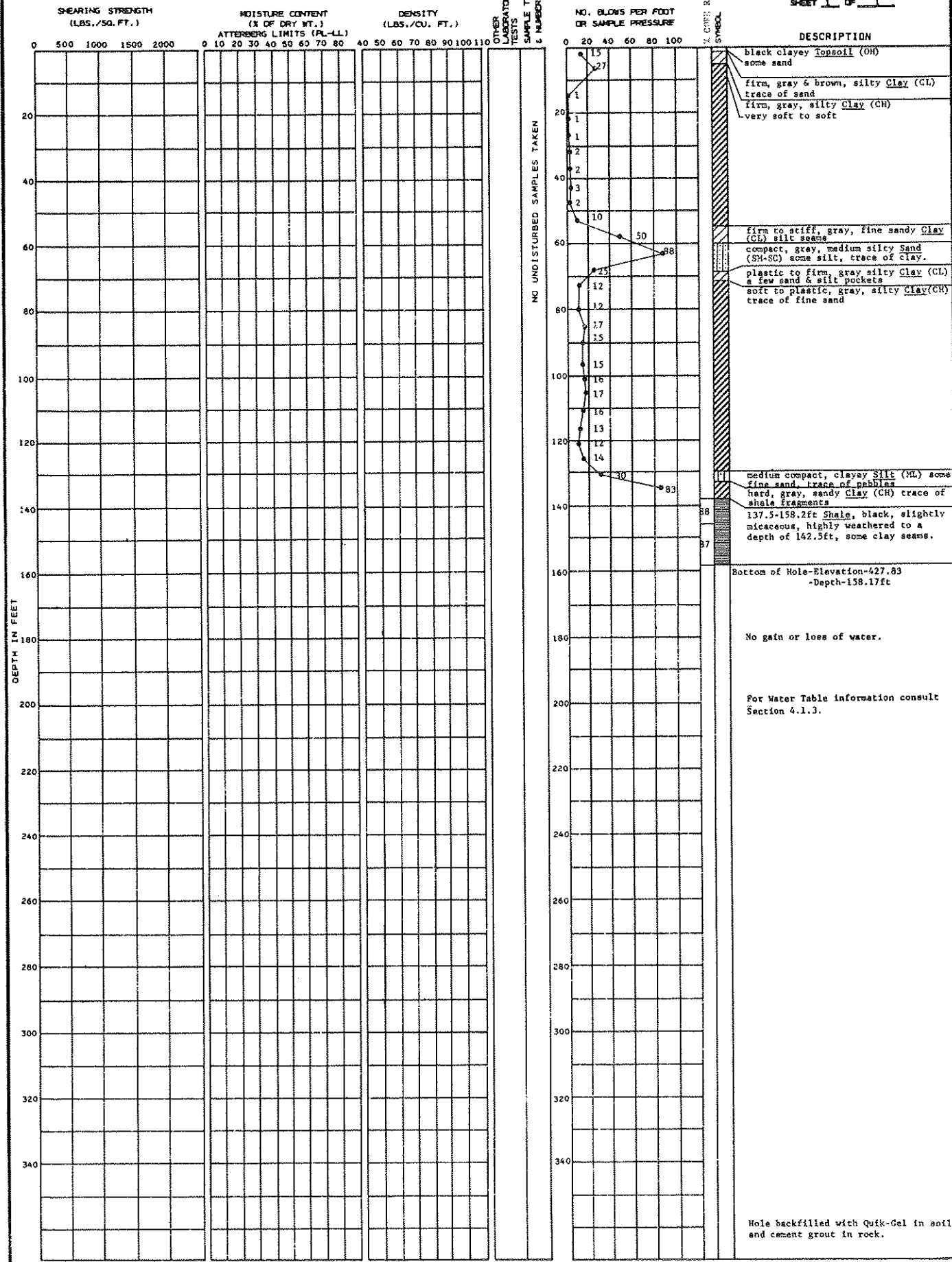

SOIL BORING NO. 34

BECHTEL Belle River

LOCATION: N 9,007
E 13,035

GROUND ELEVATION: 598.3

DATE DRILLED: 12-6-73
12-12-73

SHEET 1 OF 1

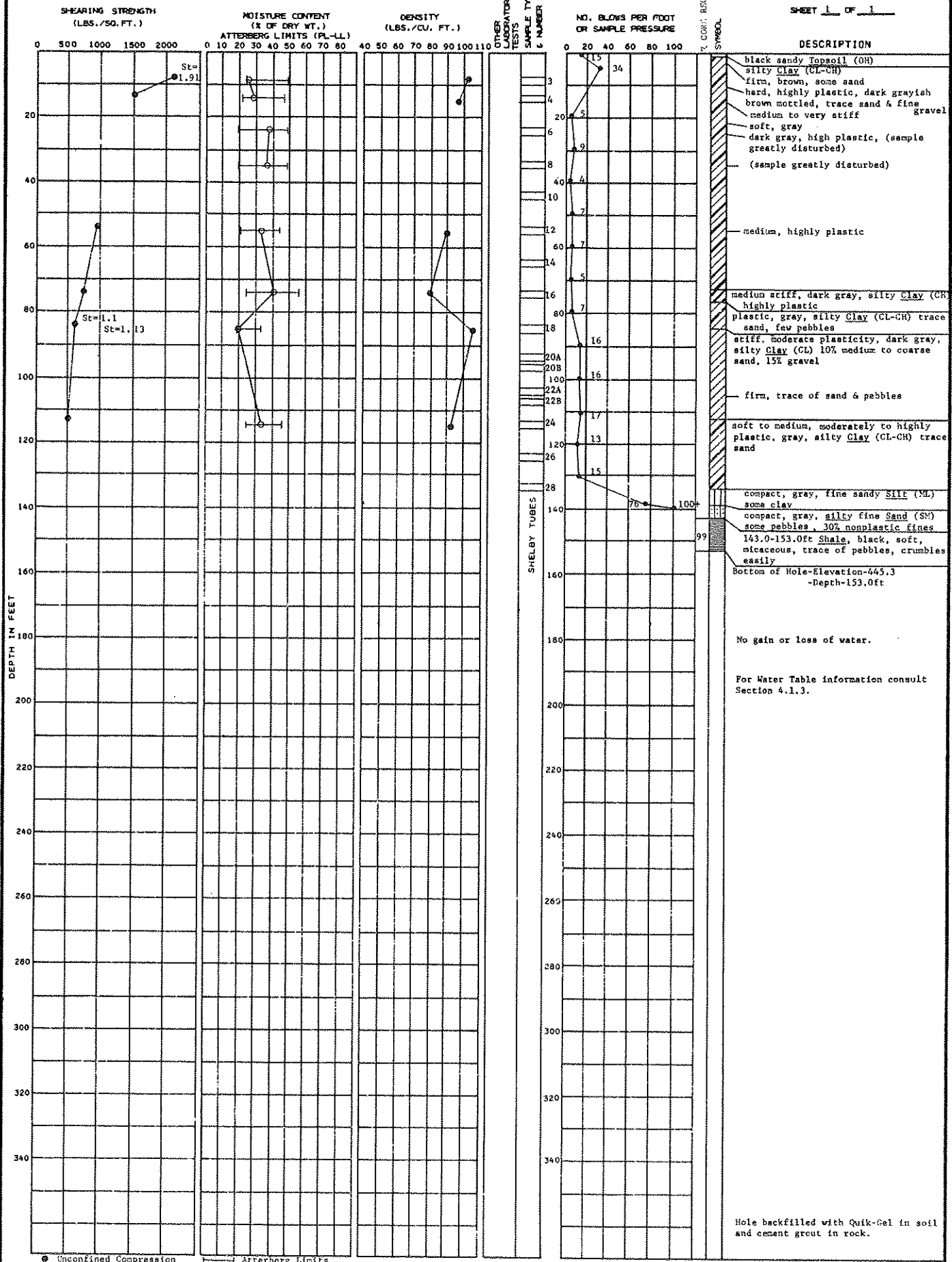

● Unconfined Compression
St = Sensitivity

○ Atterberg Limits
Moisture Content

LOCATION: N 8,003
E10,993 GROUND ELEVATION: 589.1

DATE DRILLED: 12-14-73
12-18-73

SHEARING STRENGTH
(LBS./SQ. FT.)

MOISTURE CONTENT
(% OF DRY WT.)
ATTERBERG LIMITS (PL-LI)

DENSITY
(LBS./CU. FT.)

OTHER
LABORATORY
TESTS
SAMPLE TYPE
& NUMBER

NO. BLOWS PER FOOT
ON SAMPLE PRESSURE

SHEET 1 OF 1

DESCRIPTION

DEPTH IN FEET

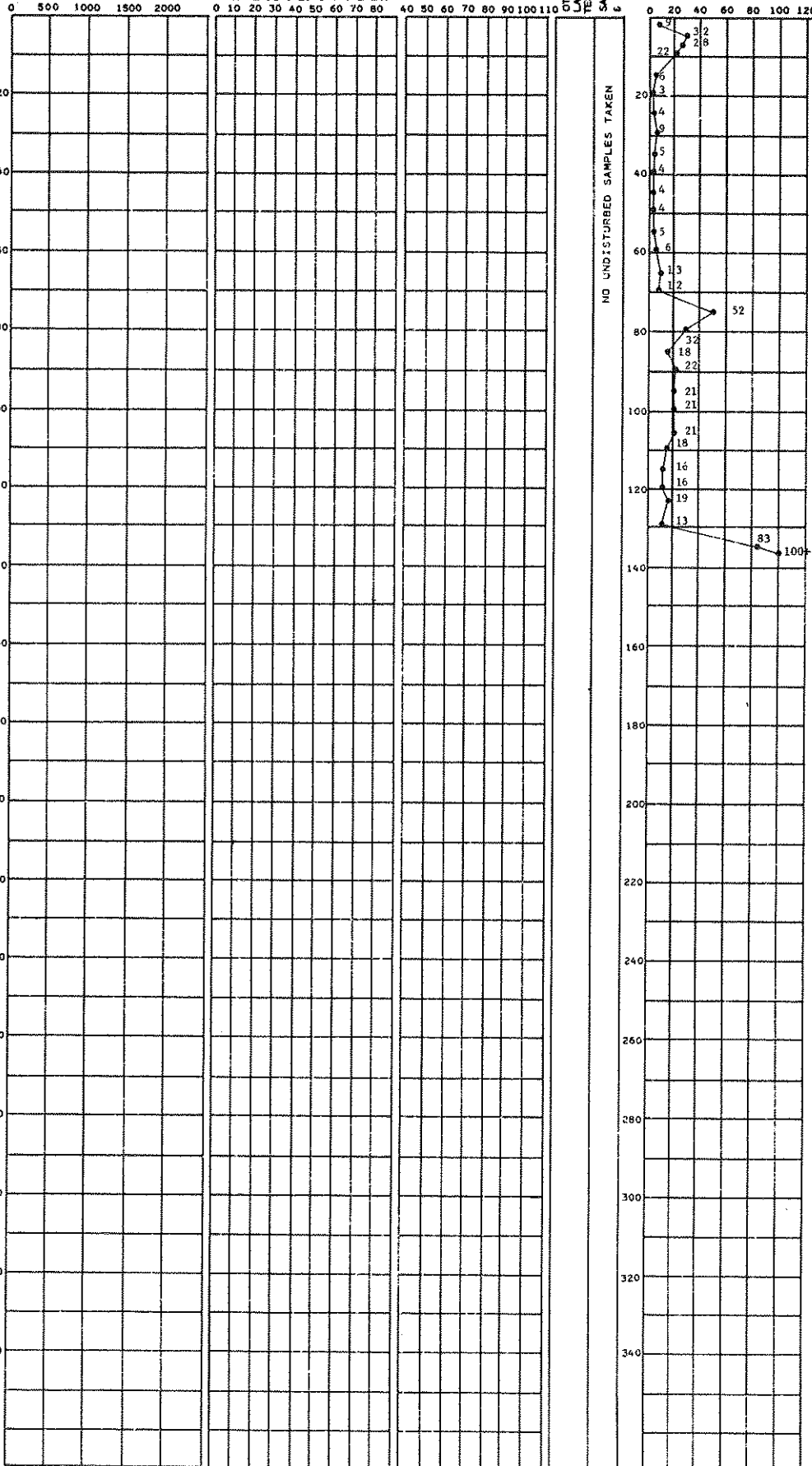

black clayey topsoil (OH)
 med., brown, silty Clay (CL) trace sand
 loose, brown, silty Sand (SM) trace pebbles
 stiff, brown & gray, silty Clay (CL) trace sand
 74-75-76: Elevation of water-580.8
 stiff, gray, trace sand
 soft
 very soft, gray silty Clay (CH)

plastic, gray, silty Clay (CL), trace sand & pebbles
 stiff, gray, sandy, silty, some pebbles
 med. gray, silty, some fine sand, few pebbles
 plastic to firm, gray, silty trace fine sand & pebbles

gray sandy Silt (ML) some clay

hard, gray, silty fine sandy Clay (CL) few pebbles trace shale
 135.3-136.6ft Shale, gray, very hard, clayey
 Bottom of Hole-Elevation-452.5
 -Depth-136.6ft

No gain or loss of water

Piezometer Installation:
 4' of 2" PVC Blank Casing from 84' to 80'; 5' #80 screen from 80' to 75', 78.48' of 2" PVC Blank Casing from 75' to 3.48' above ground surface. Sand pack around casing from bottom of hole to 70', bentonite seal around casing at top of sand pack, annulus backfilled with grout to ground surface.

For Water Table information consult Section 4.1.3.

SOIL BORING NO. 40

BECHTEL Belle River

LOCATION: N 8,016
E 12,991

GROUND ELEVATION 600.2

DATE DRILLED: 11-19-73
11-21-73

SHEET 1 OF 1

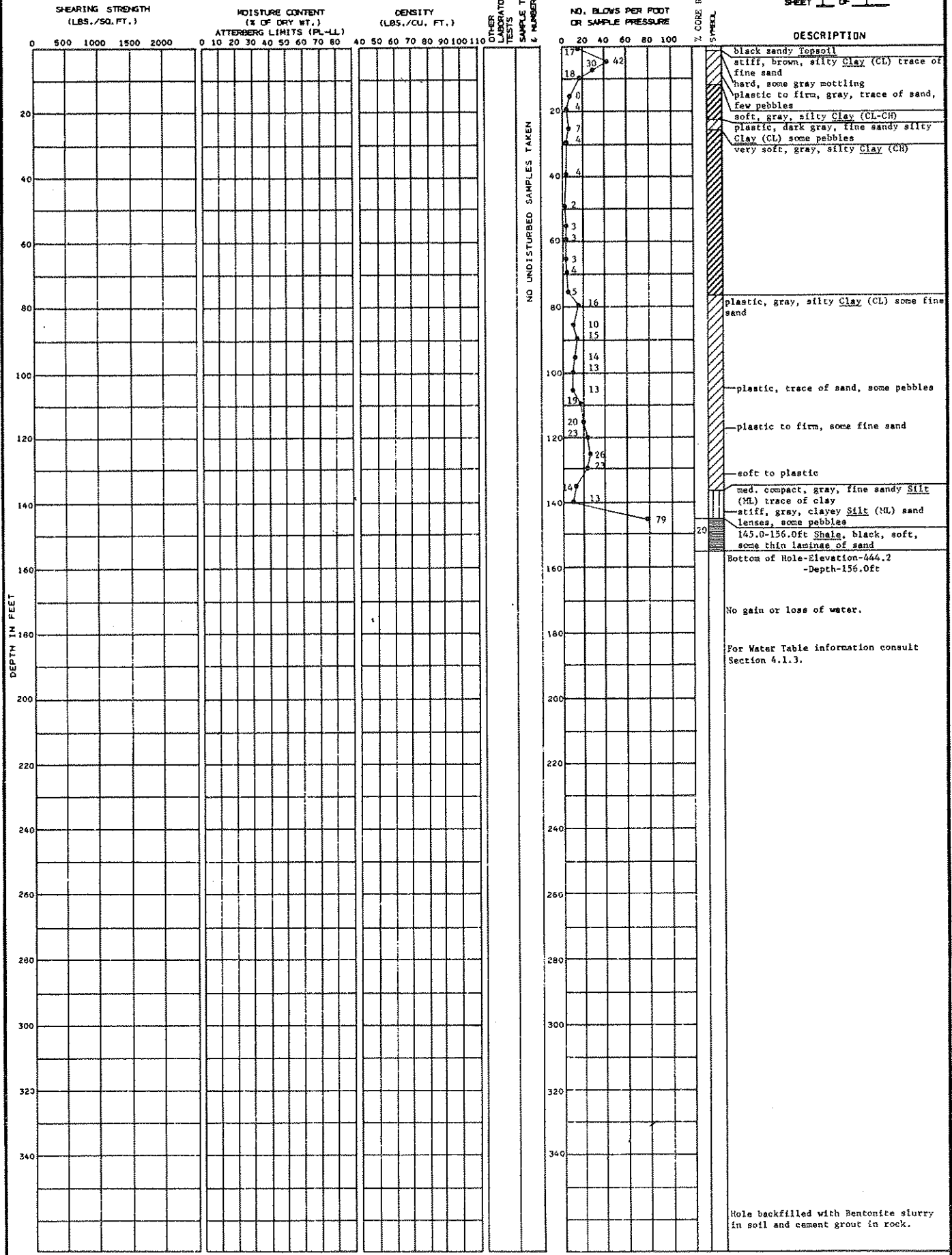

SOIL BORING NO. 42

BECHTEL Belle River

LOCATION: N 7,004
E13,000 GROUND ELEVATION 600.5

DATE DRILLED: 11-20-73

SHEET 1 OF 1

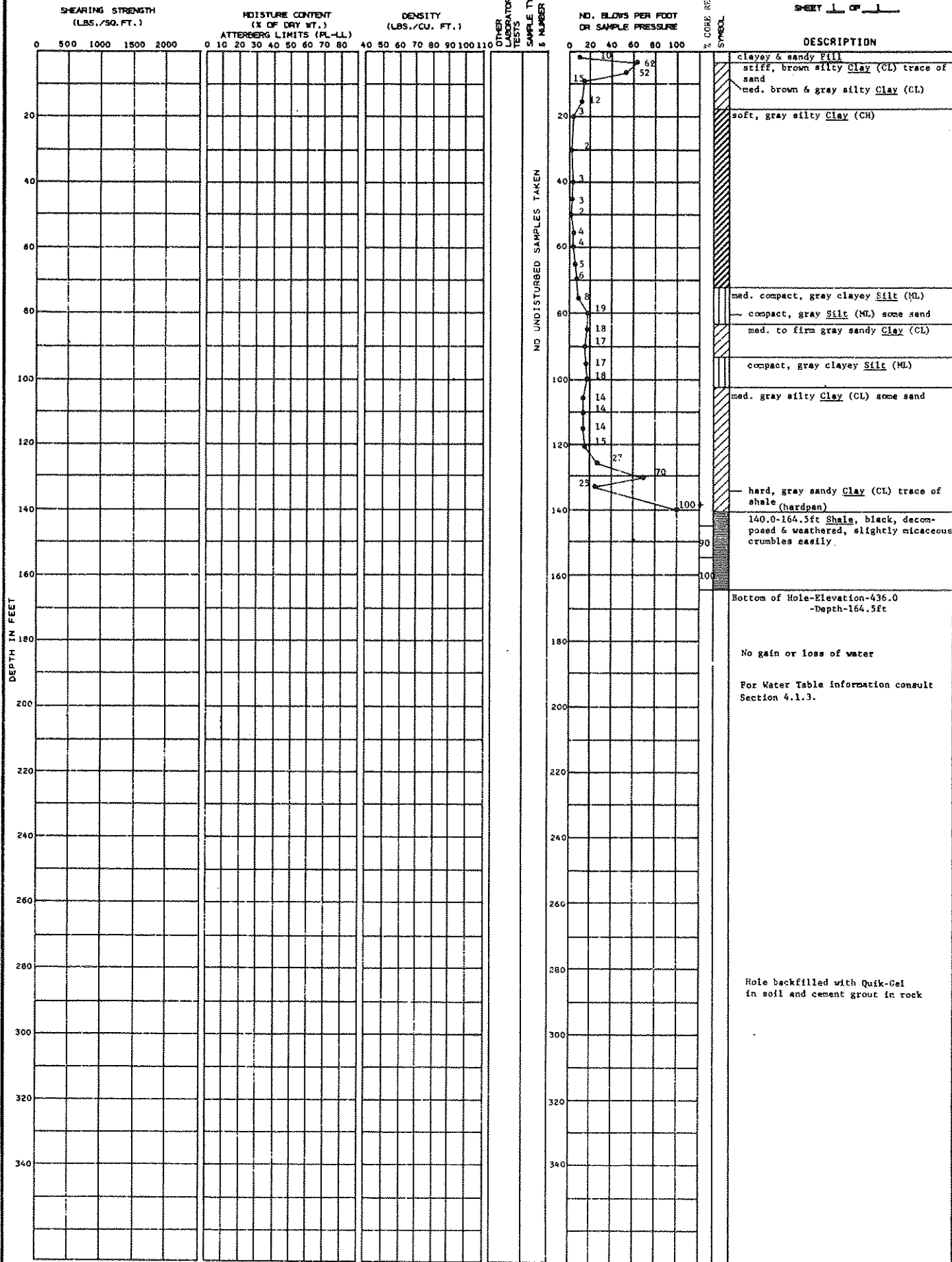

LOCATION: N 5,344
E 12,319

GROUND ELEVATION 588.2

DATE DRILLED: 1-22-74
1-28-74

SHEET 1 OF 1

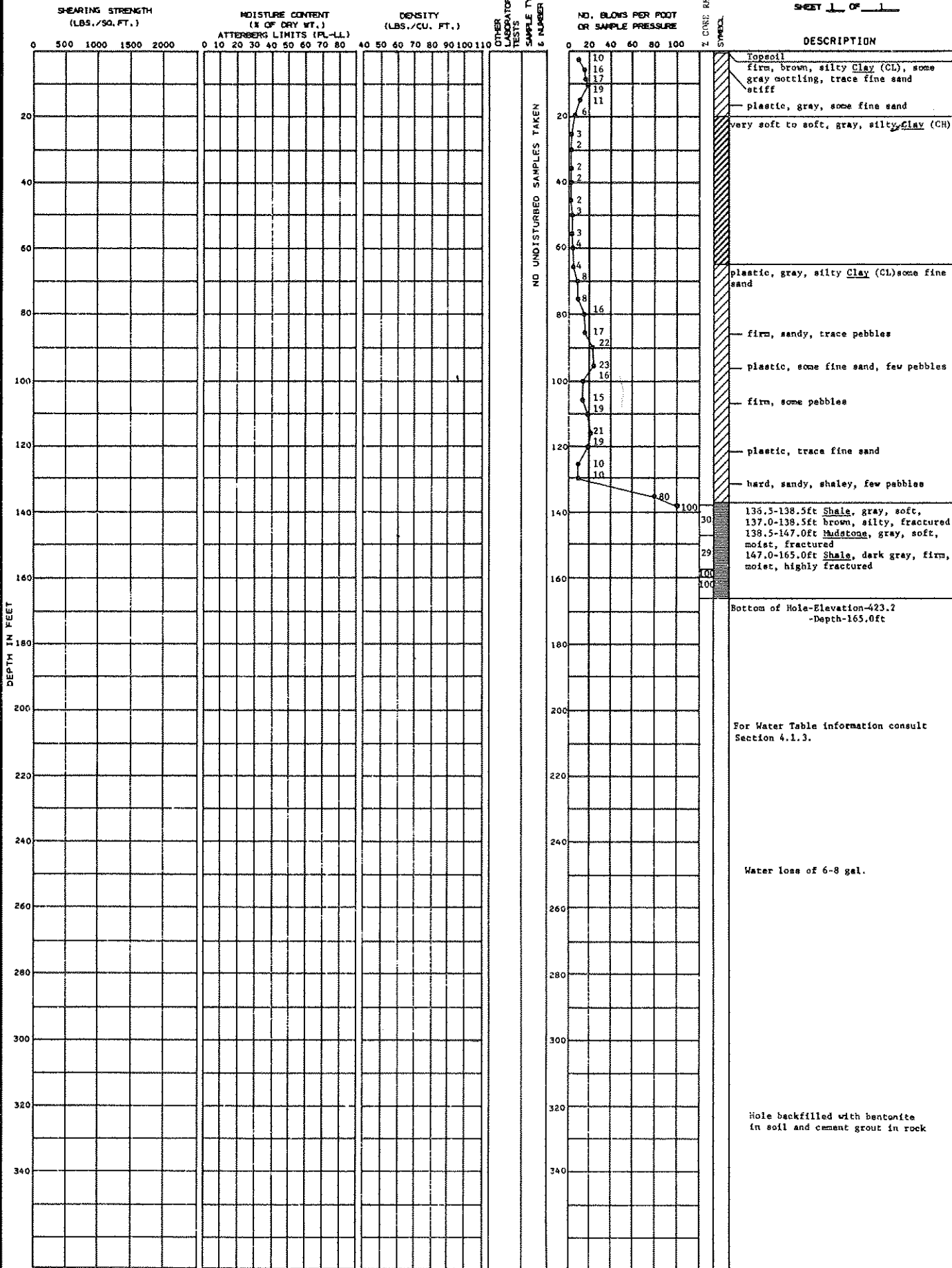

LOCATION: N 3,950
E 12,584

GROUND ELEVATION 587.5

DATE DRILLED: 1-14-74
1-23-74

SHEET 1 OF 1

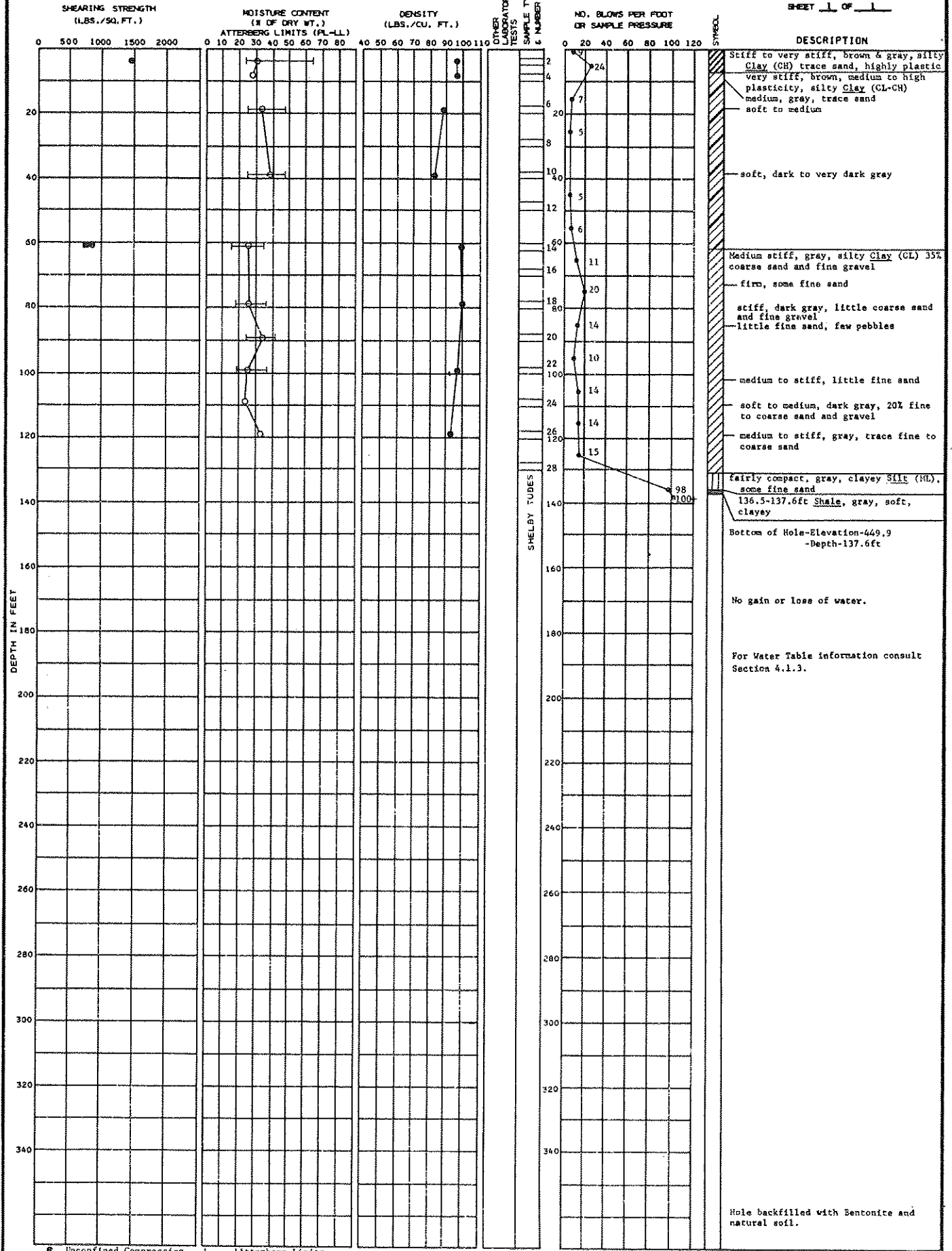

● Unconfined Compression
 ■ Unconsolidated Undrained
 — Atterberg Limits
 ○ Moisture Content

SOIL BORING NO. 48

BECHTEL Belle River

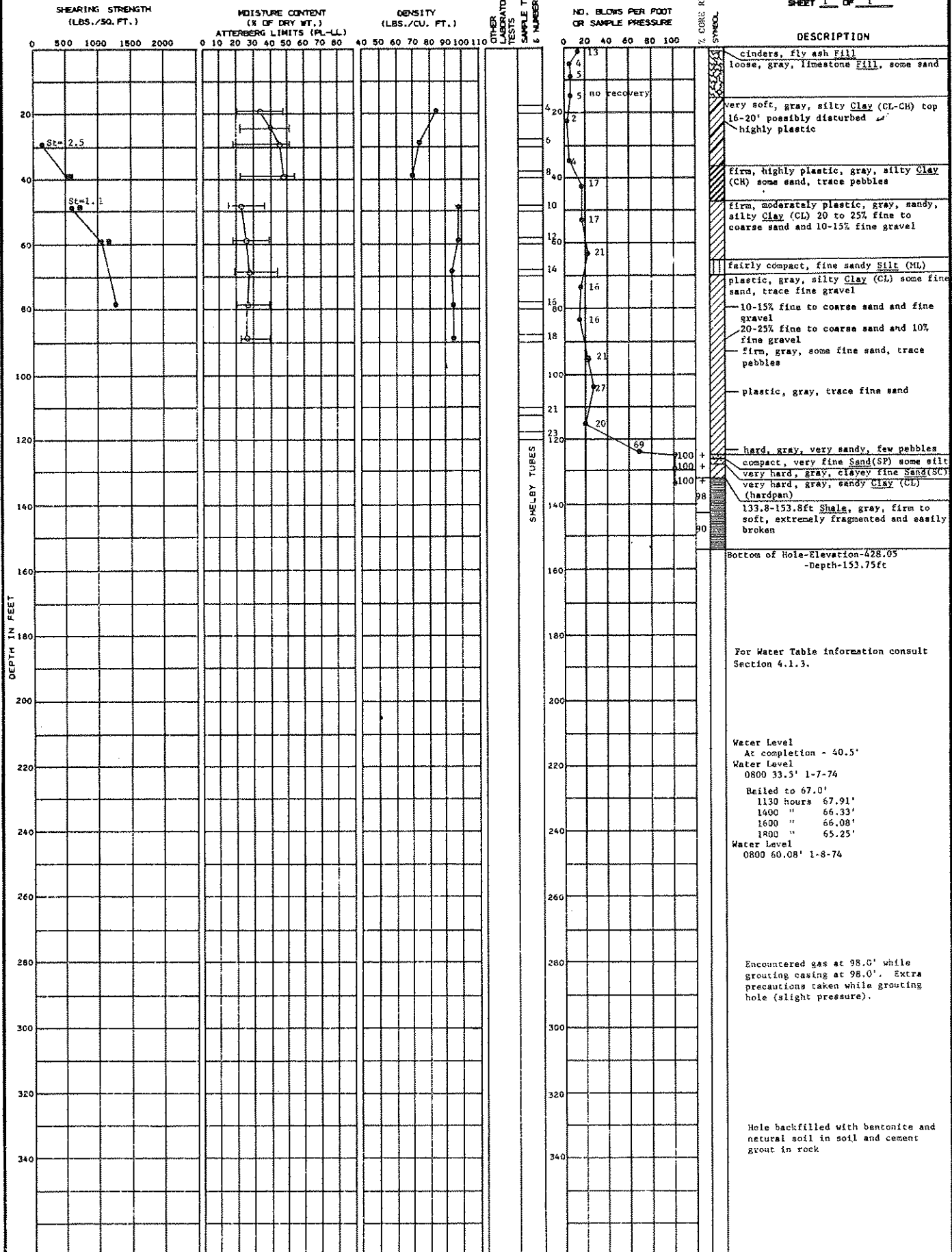

● Unconfined
 ■ Unconsolidated Undrained
 St = Sensitivity
 ○ Moisture Content
 — Atterberg Limits

SOIL BORING NO. 50

BECHTEL Belle River

LOCATION: N 2,052
E15,176

GROUND ELEVATION: 580.6

DATE DRILLED: 12-21-73
1-7-76

SHEET 1 OF 1

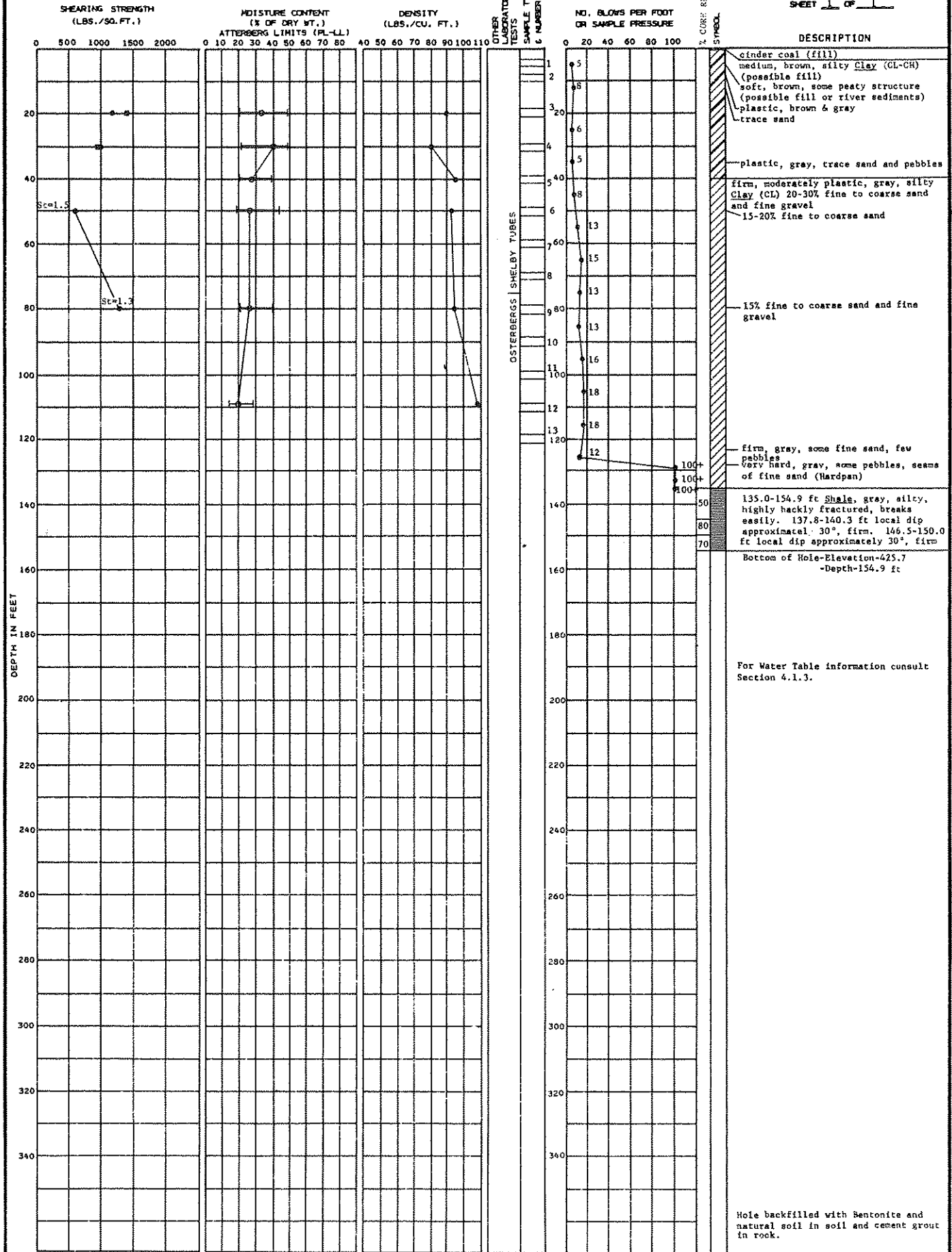

LOCATION: N 2,645
E 15,306

GROUND ELEVATION 547.9

DATE DRILLED: 3-29-74
SHEET 1 OF 1

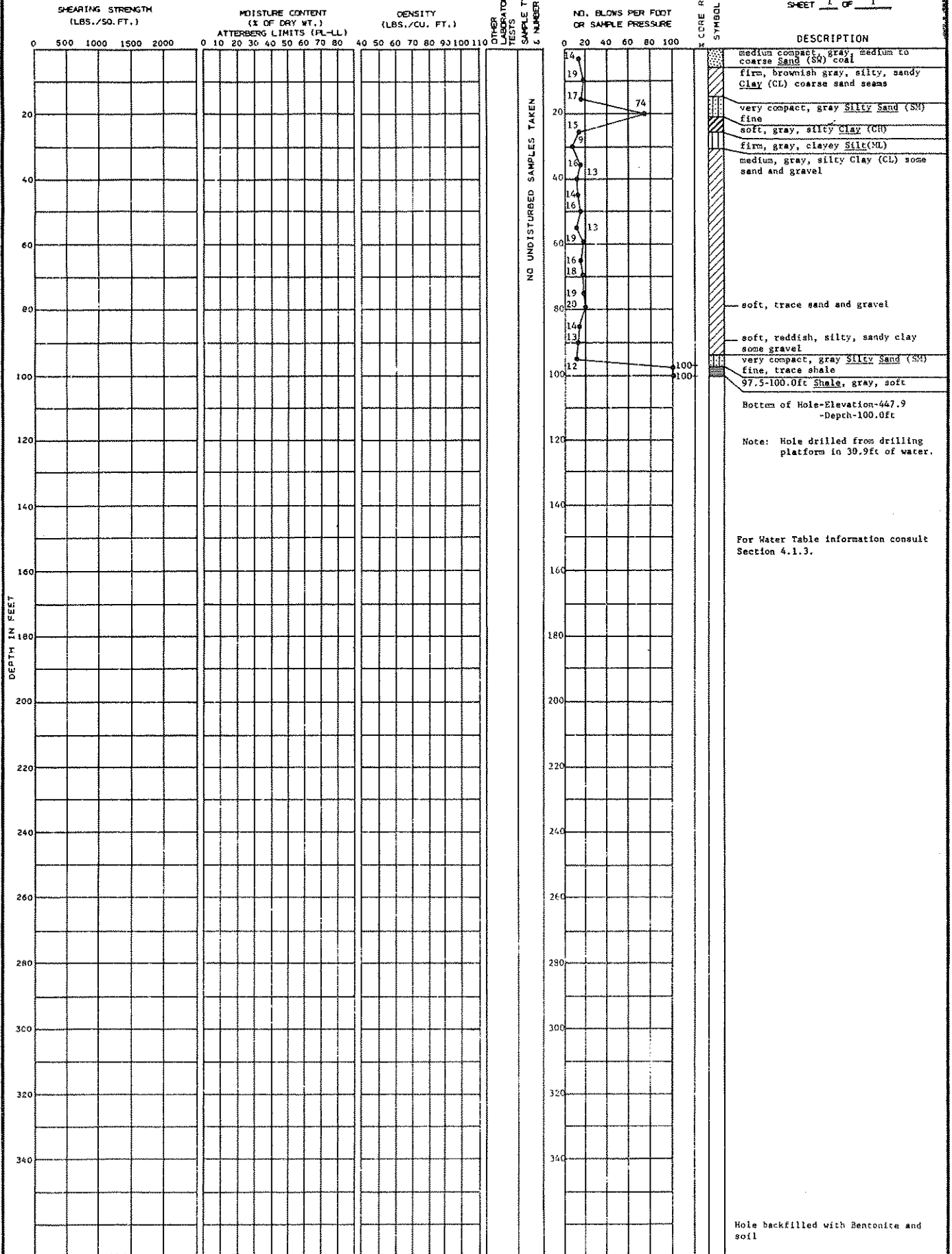

Bottom of Hole-Elevation-447.9
-Depth-100.0ft

Note: Hole drilled from drilling platform in 30.9ft of water.

For Water Table information consult Section 4.1.3.

Hole backfilled with Bentonite and soil

LOCATION: N 1,907 E 15,269 GROUND ELEVATION 543.3

DATE DRILLED: 3-20-74 3-25-74

SHEET 1 OF 1

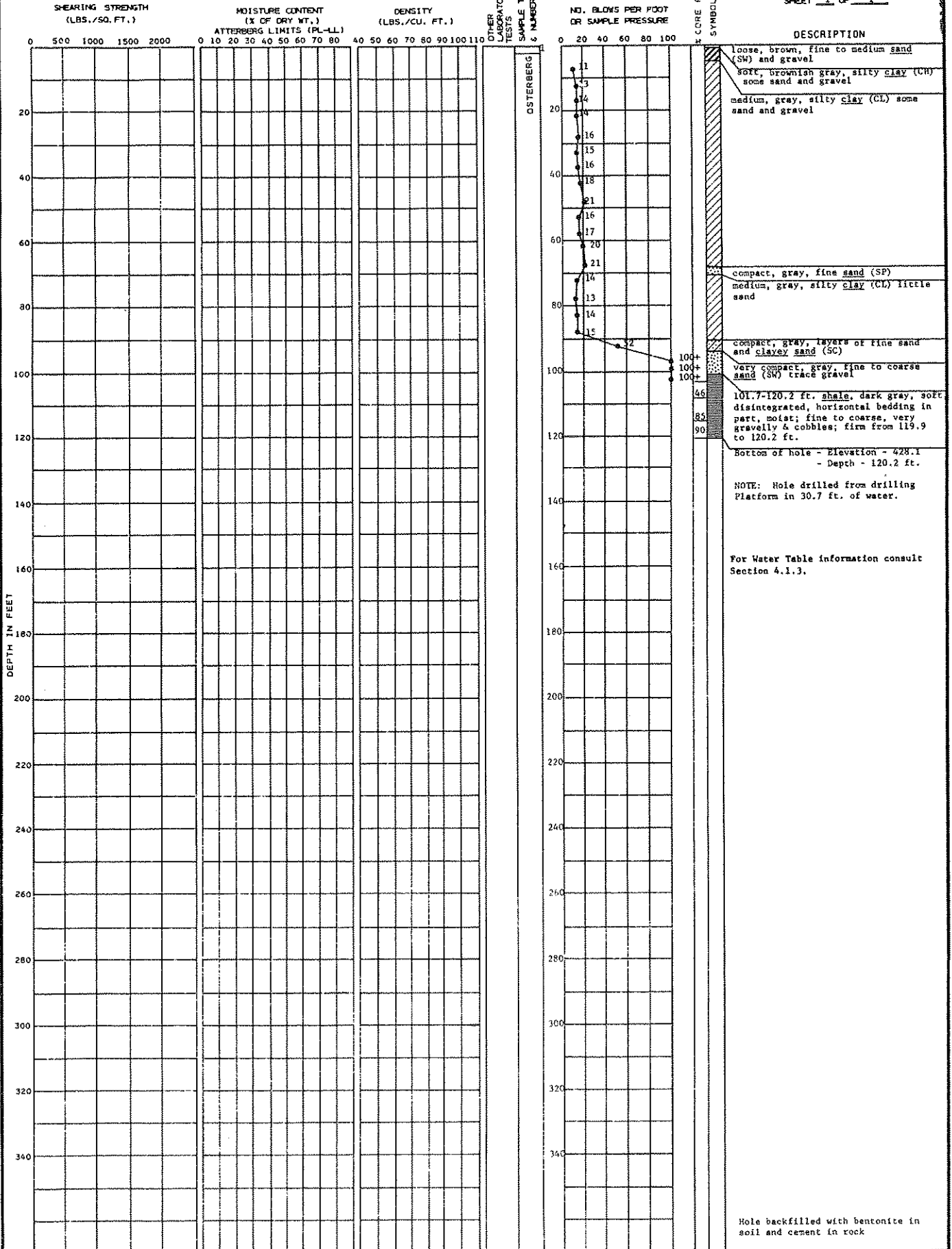

LOCATION: N 2393
E15140 GROUND ELEVATION 582.3

DATE DRILLED: 1-10-74
1-16-74

SHEET 1 OF 1

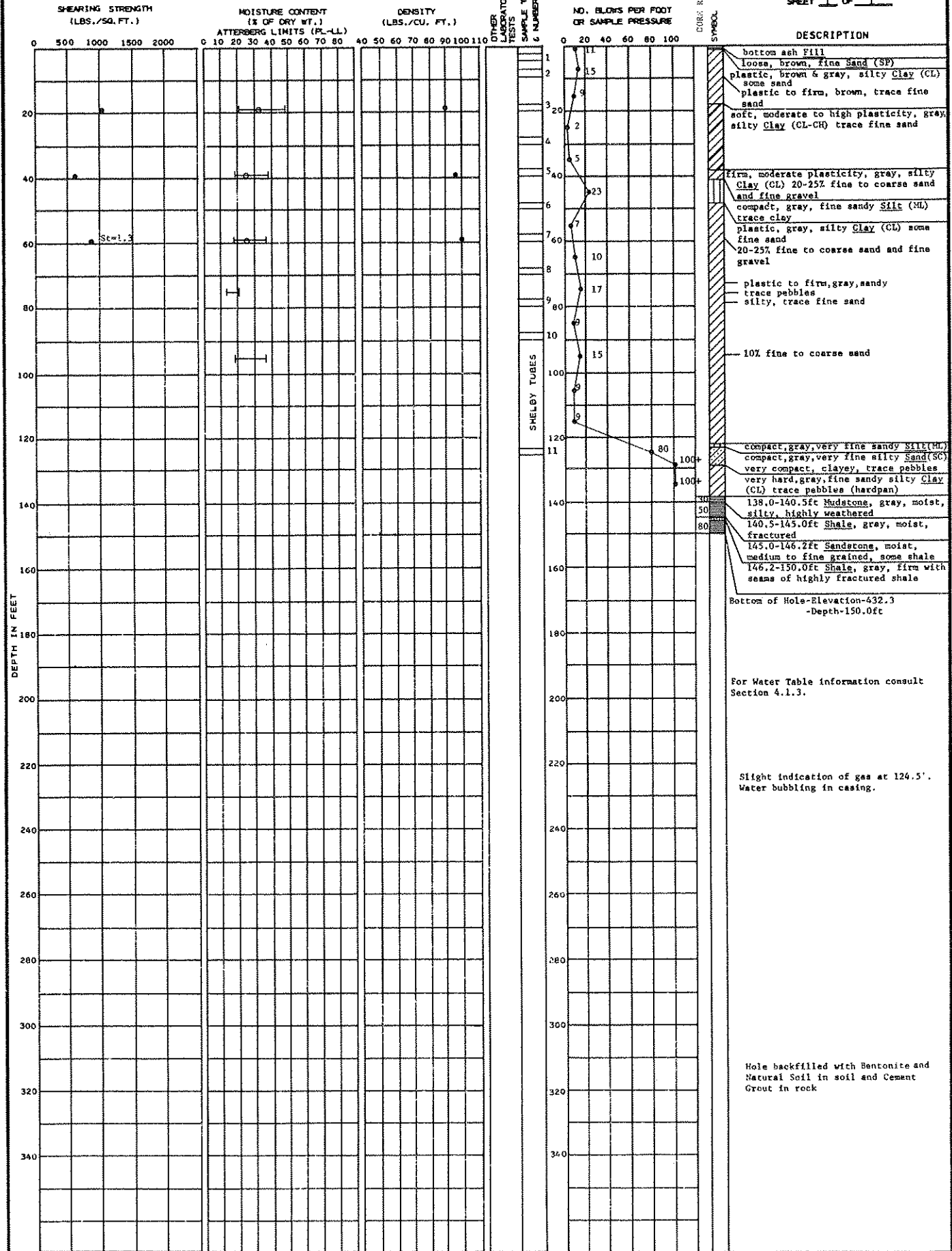

Unconfined
Moisture Content
Atterberg Limits
S_t = Sensitivity

LOCATION: N 5,283
E 14,042

GROUND ELEVATION 593.1

DATE DRILLED: 1-23-74
1-29-74

SHEET 1 OF 1

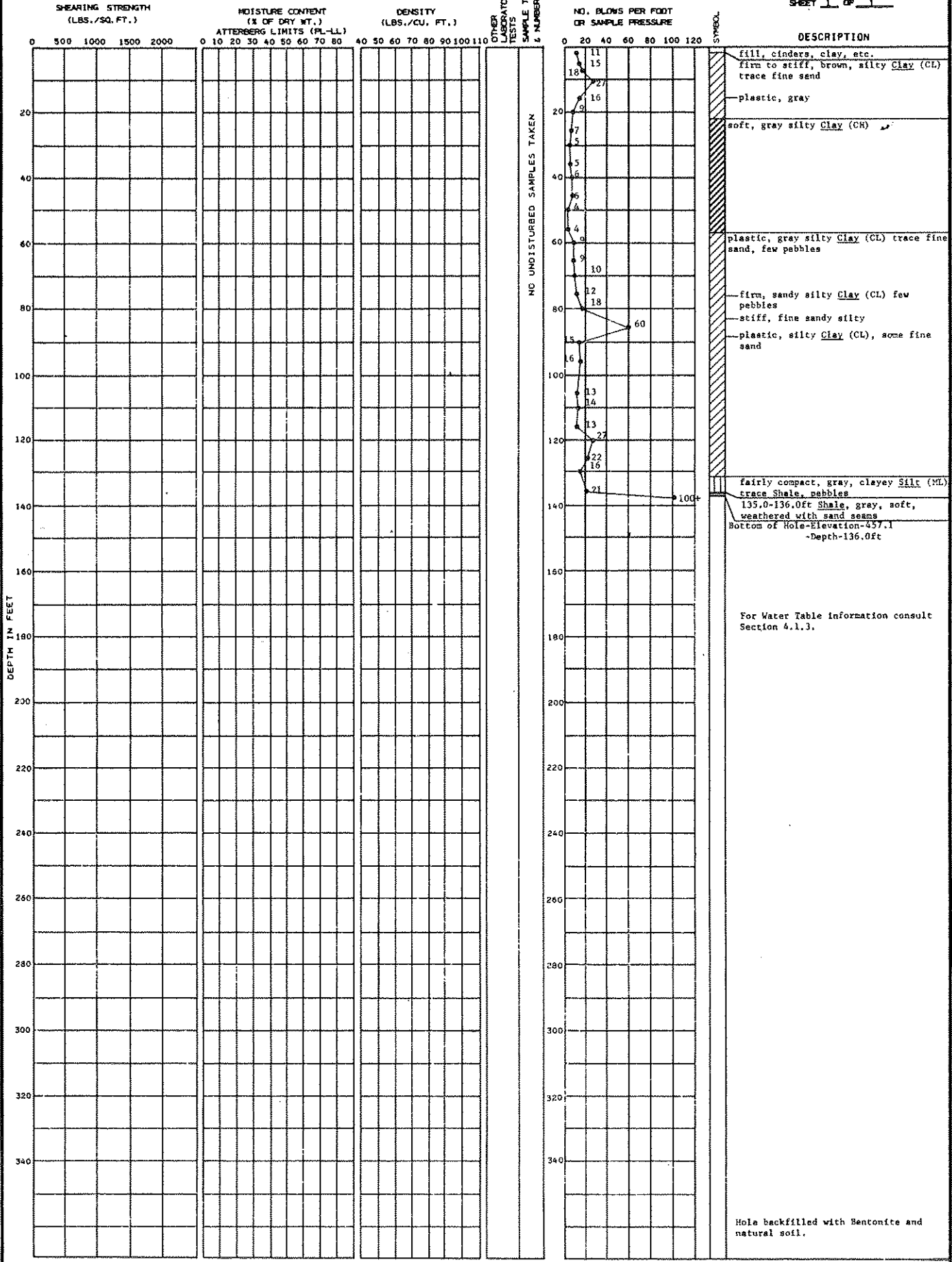

fairly compact, gray, clayey Silt (ML) trace Shale, pebbles
135.0-136.0ft Shale, gray, soft, weathered with sand seams
Bottom of Hole-Elevation-457.1
-Depth-136.0ft

For Water Table Information consult Section 4.1.3.

Hole backfilled with Bentonite and natural soil.

LOCATION: N 9,208.32 GROUND ELEVATION 587.6
 E 9,376.12

DATE DRILLED: 2-28-74
 3-7-74

SHEET 1 OF 1

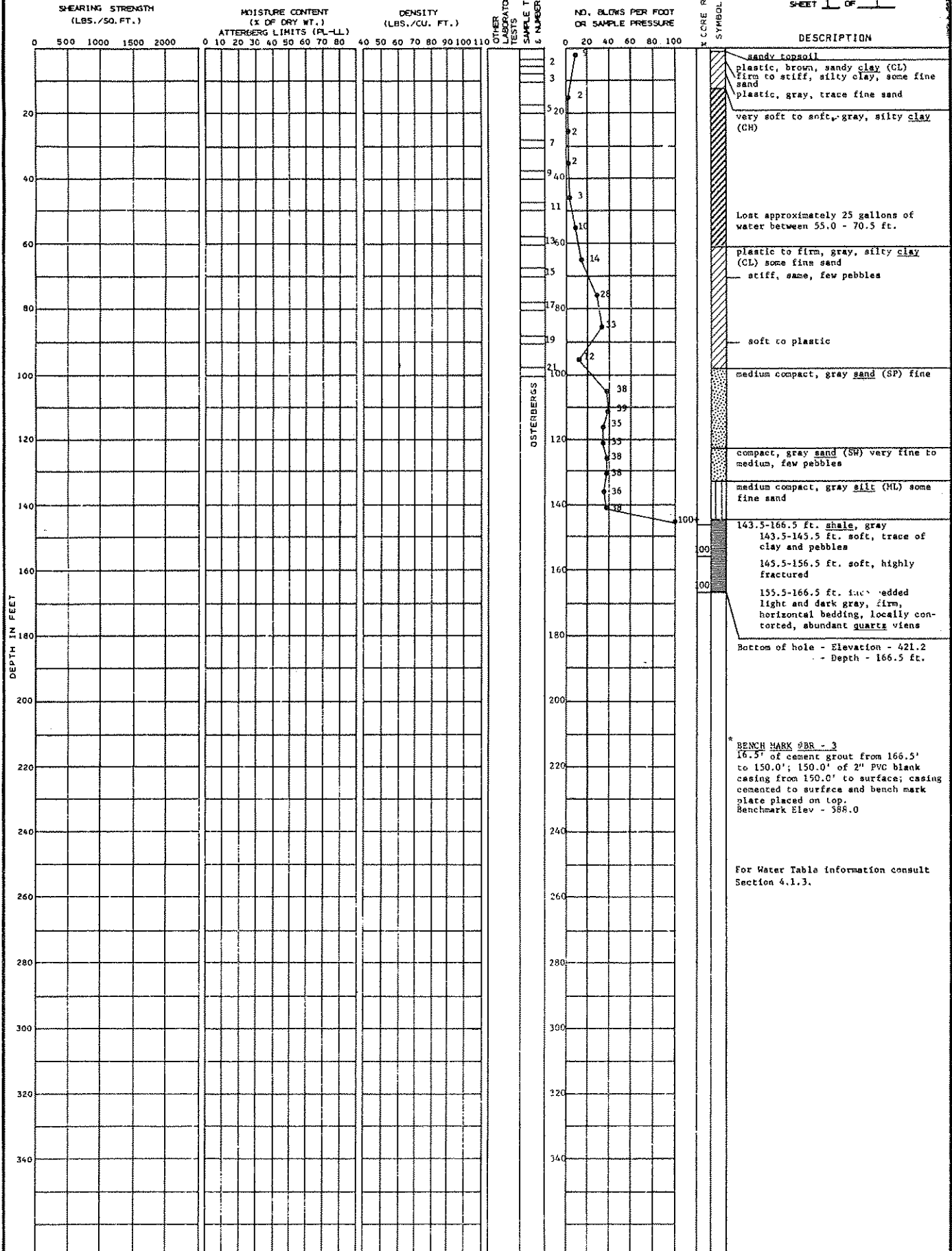

LOCATION: N 3,800 E 12,060 GROUND ELEVATION 586.0

DATE DRILLED: 2-12-74
2-26-74

SHEET 1 OF 1

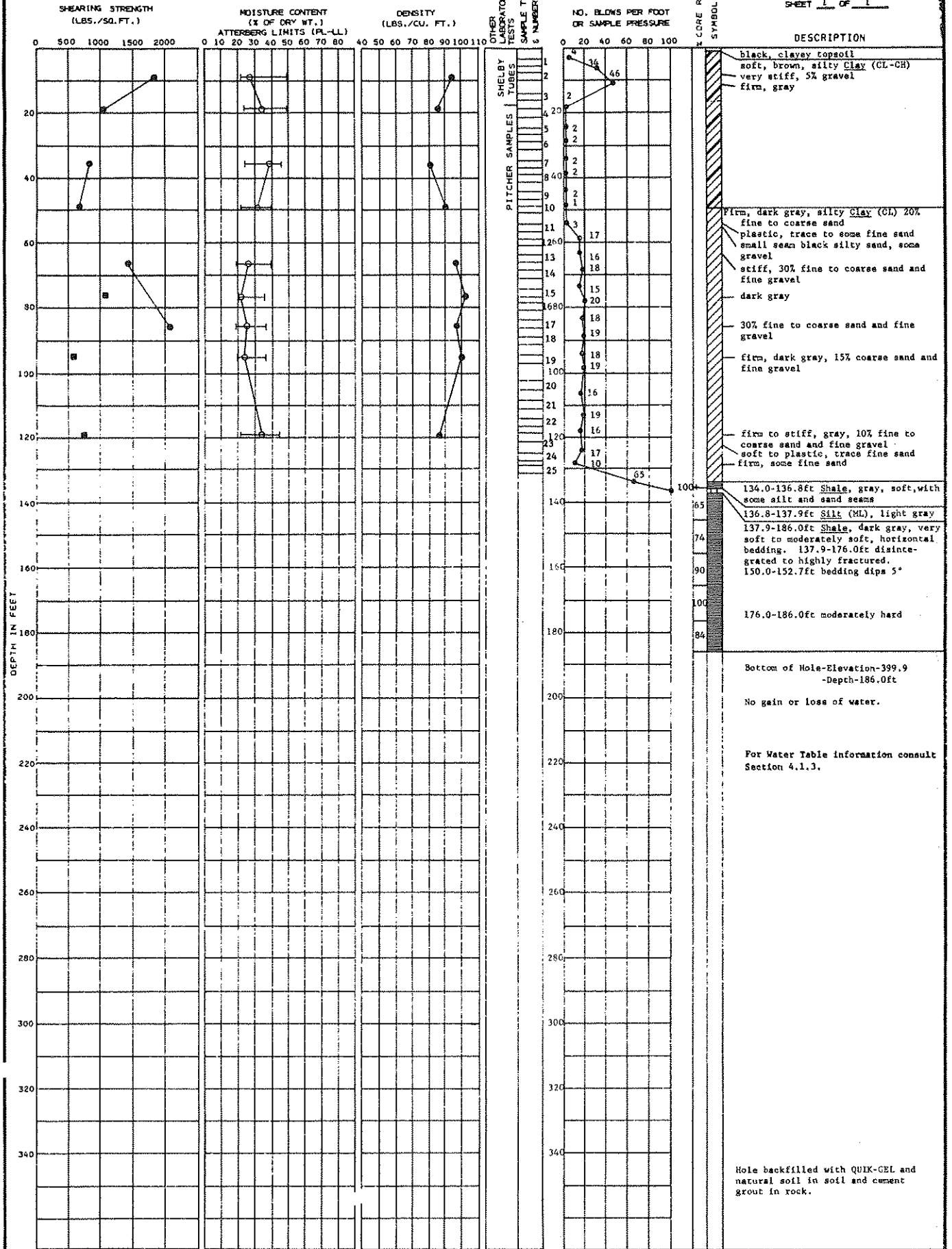

● Unconfined Compression
 ■ Unconsolidated Undrained
 — Atterberg Limits
 ○ Moisture Content

SOIL BORING NO. 101
 BECHTEL Belle River

LOCATION: N 4,435
E 12,350

GROUND ELEVATION 589.7

DATE DRILLED: 2-5-74
2-7-74

SHEET 1 OF 1

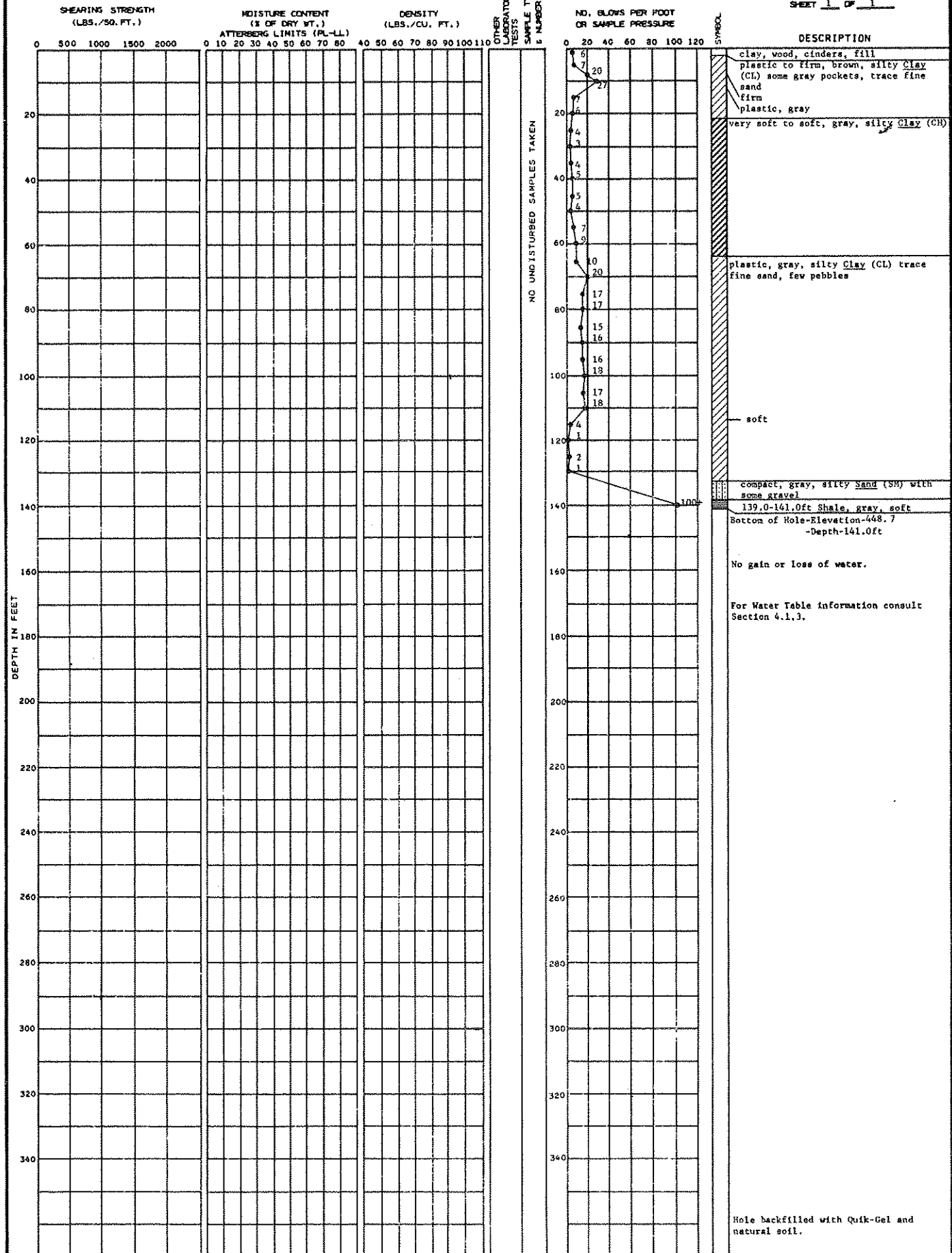

SOIL BORING NO. 103

BECHTEL Belle River

B-71

LOCATION: N 5,000 E 11,000 GROUND ELEVATION 588.3

DATE DRILLED: 2-26-74 3-5-74

SHEET 1 OF 1

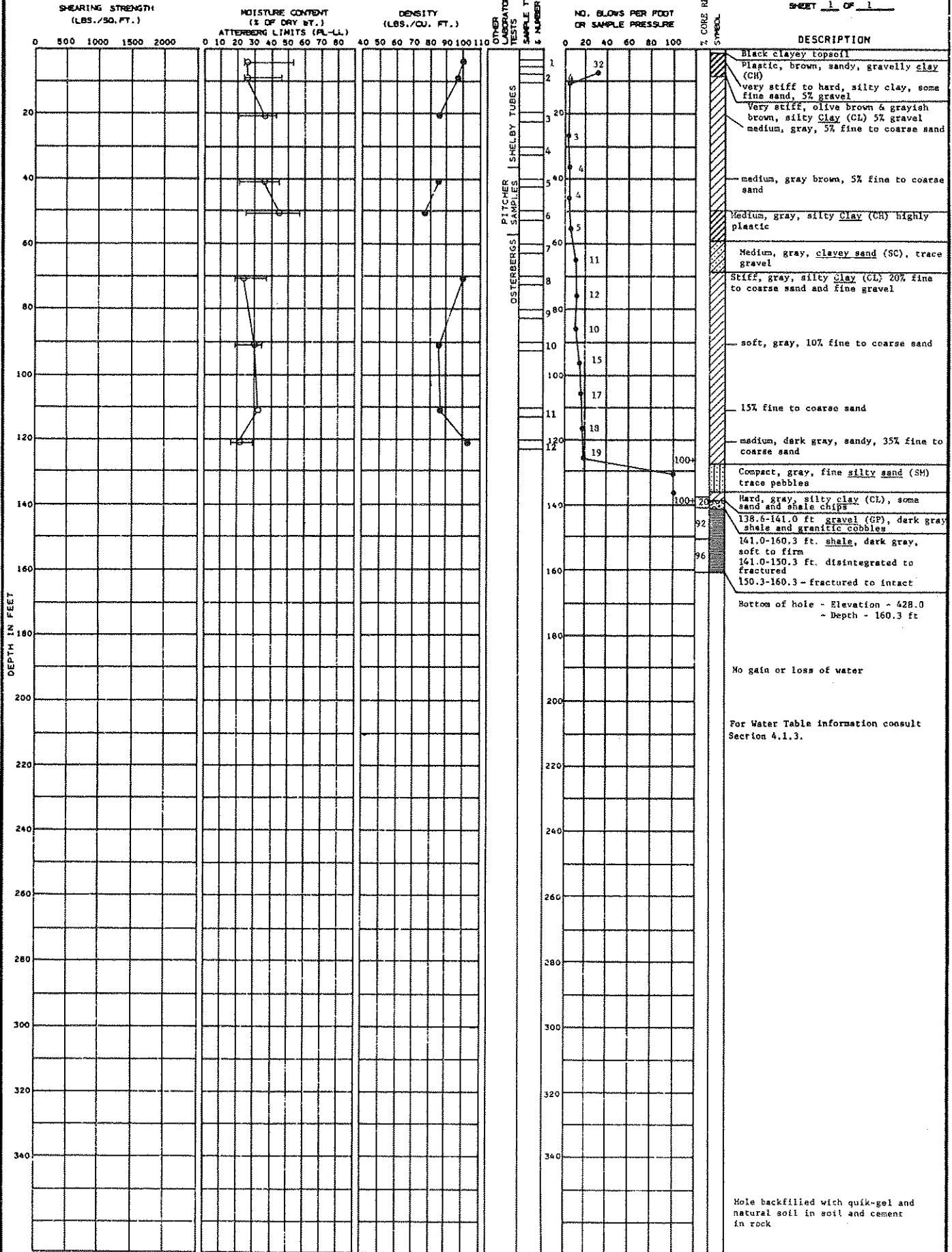

Atterberg Limits
○ Moisture Content

SOIL BORING NO. 105

BECHTEL Belle River

LOCATION: S 6,450 E 13,140 GROUND ELEVATION 600.7

DATE DRILLED: 2-26-74 3-6-74

SHEET 1 OF 1

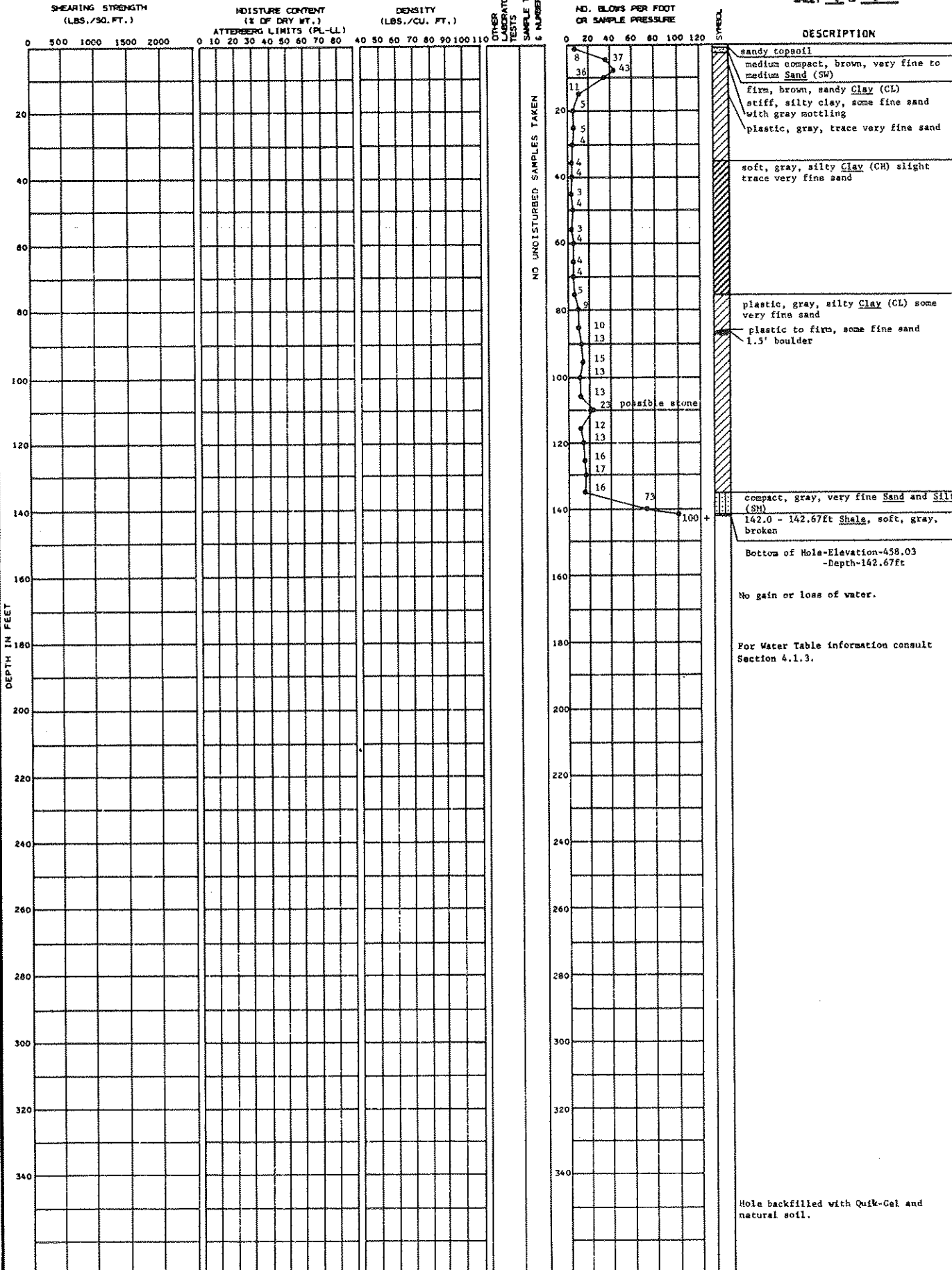

LOCATION: N 6,600 E 11,000 GROUND ELEVATION 588.5

DATE DRILLED: 2-21-74 2-26-74 SHEET 1 OF 1

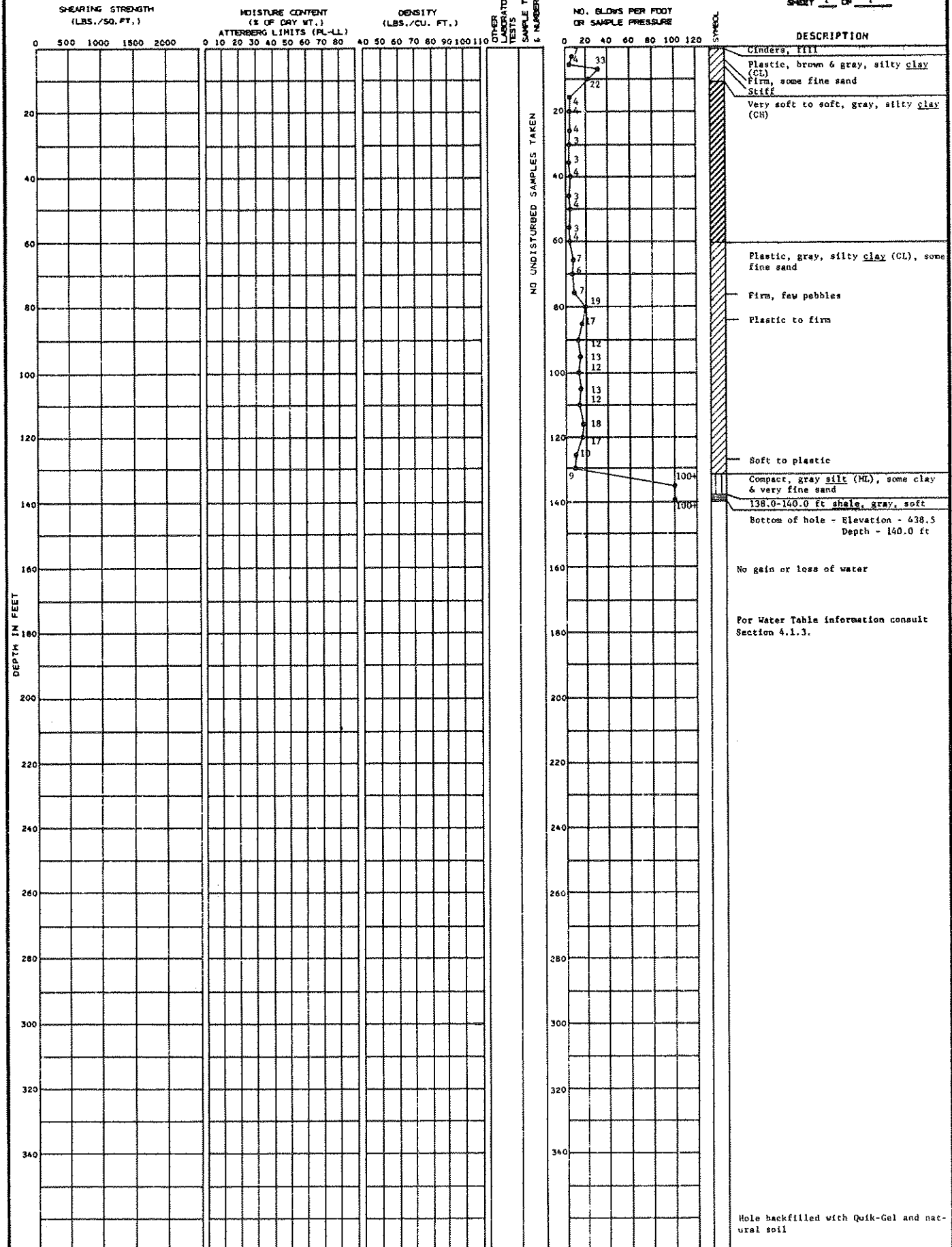

LOCATION: N 6,800 GROUND ELEVATION 587.4
E 9,350

DATE DRILLED: 2-27-74
3-5-74

SHEET 1 OF 1

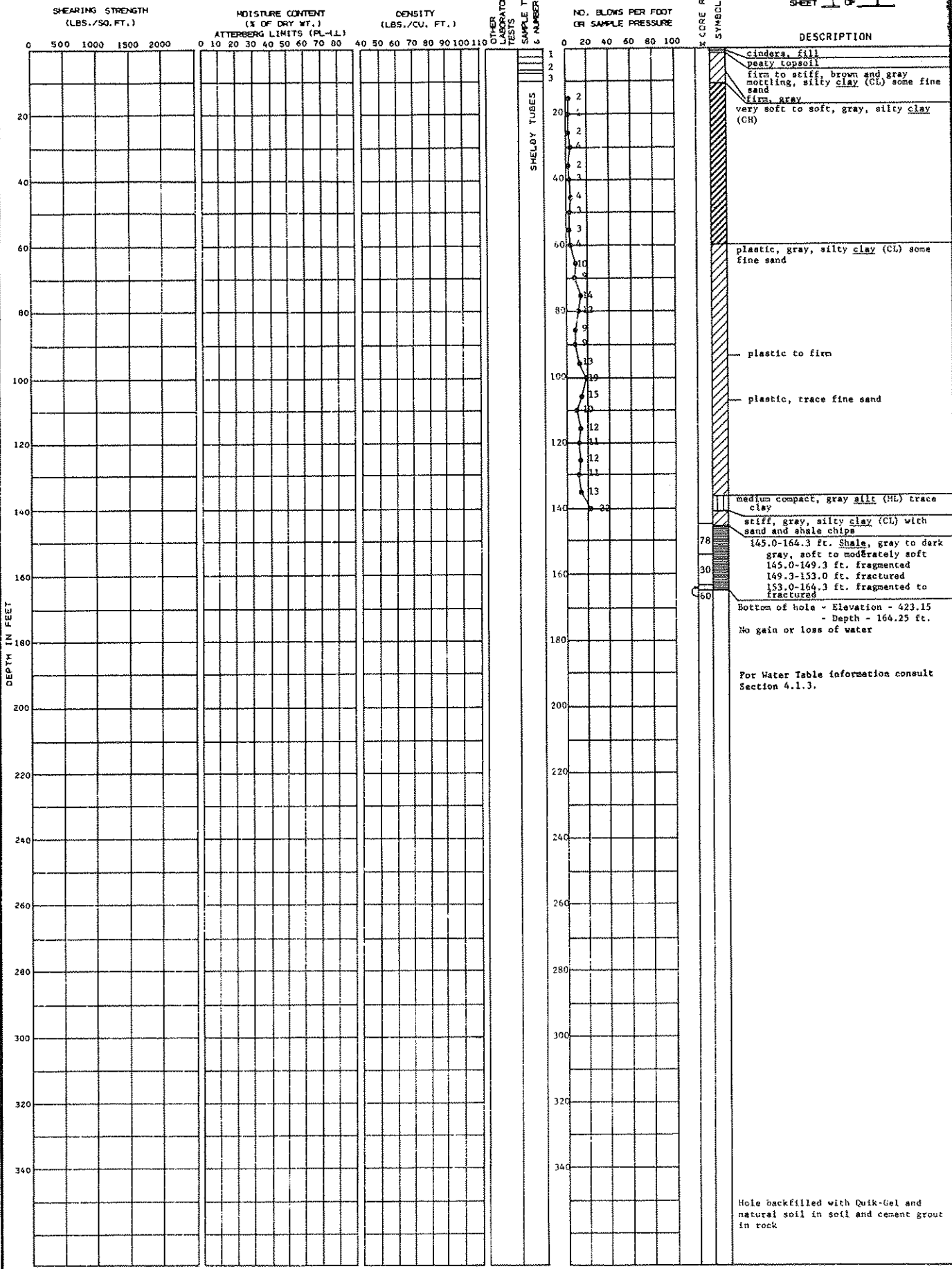

Hole backfilled with Quik-Gel and natural soil in soil and cement grout in rock

SOIL BORING NO. 113

BECHTEL Belle River

LOCATION: N 7,100 E13,260 GROUND ELEVATION 600.7

DATE DRILLED: 1-30-74 2-6-74

SHEET 1 OF 1

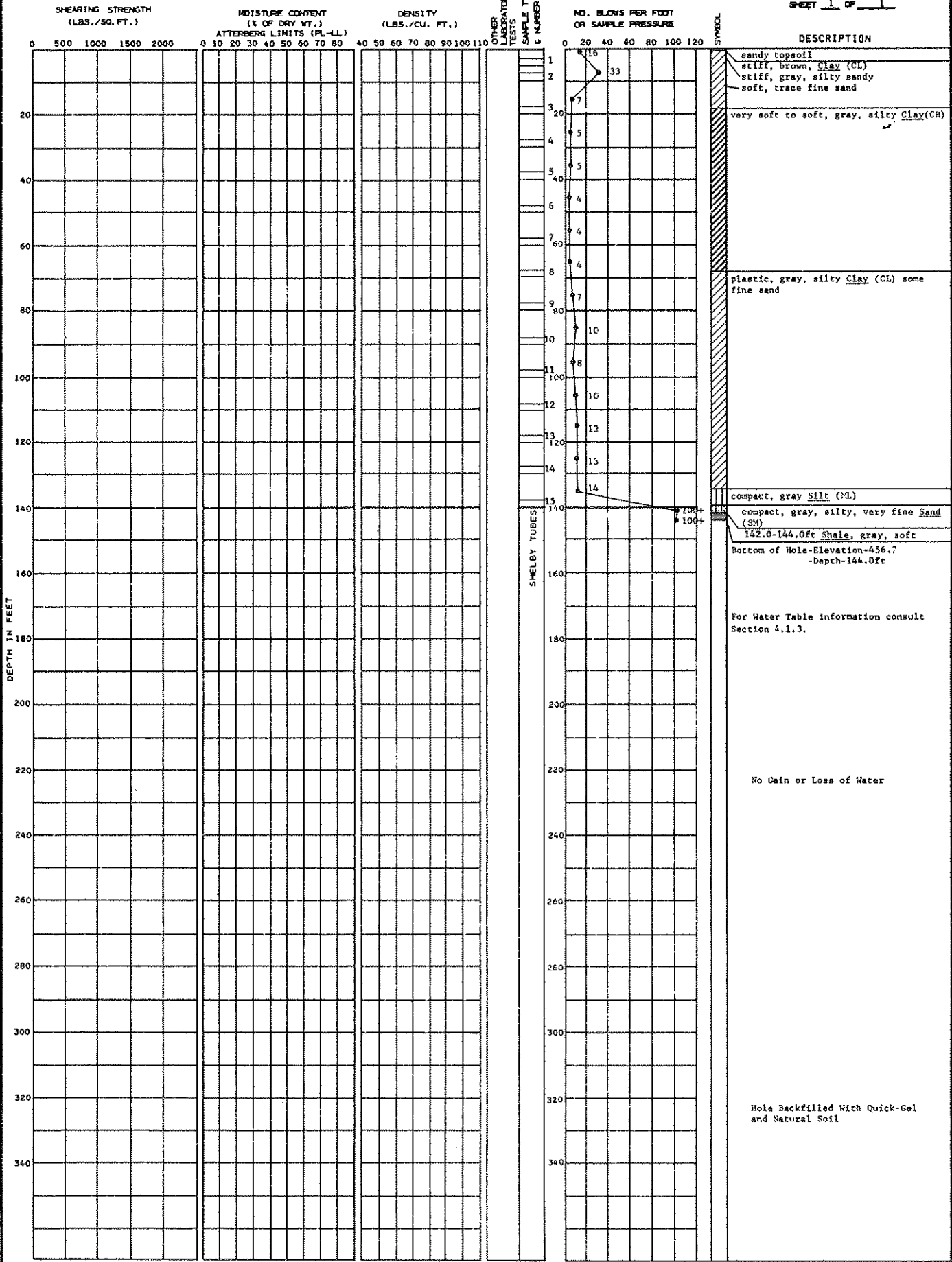

SOIL BORING NO. 115

BECHTEL Belle River

LOCATION: N 7,270
E 9,360

GROUND ELEVATION 585.5

DATE DRILLED: 2-5-74
2-12-74

SHEET 1 OF 1

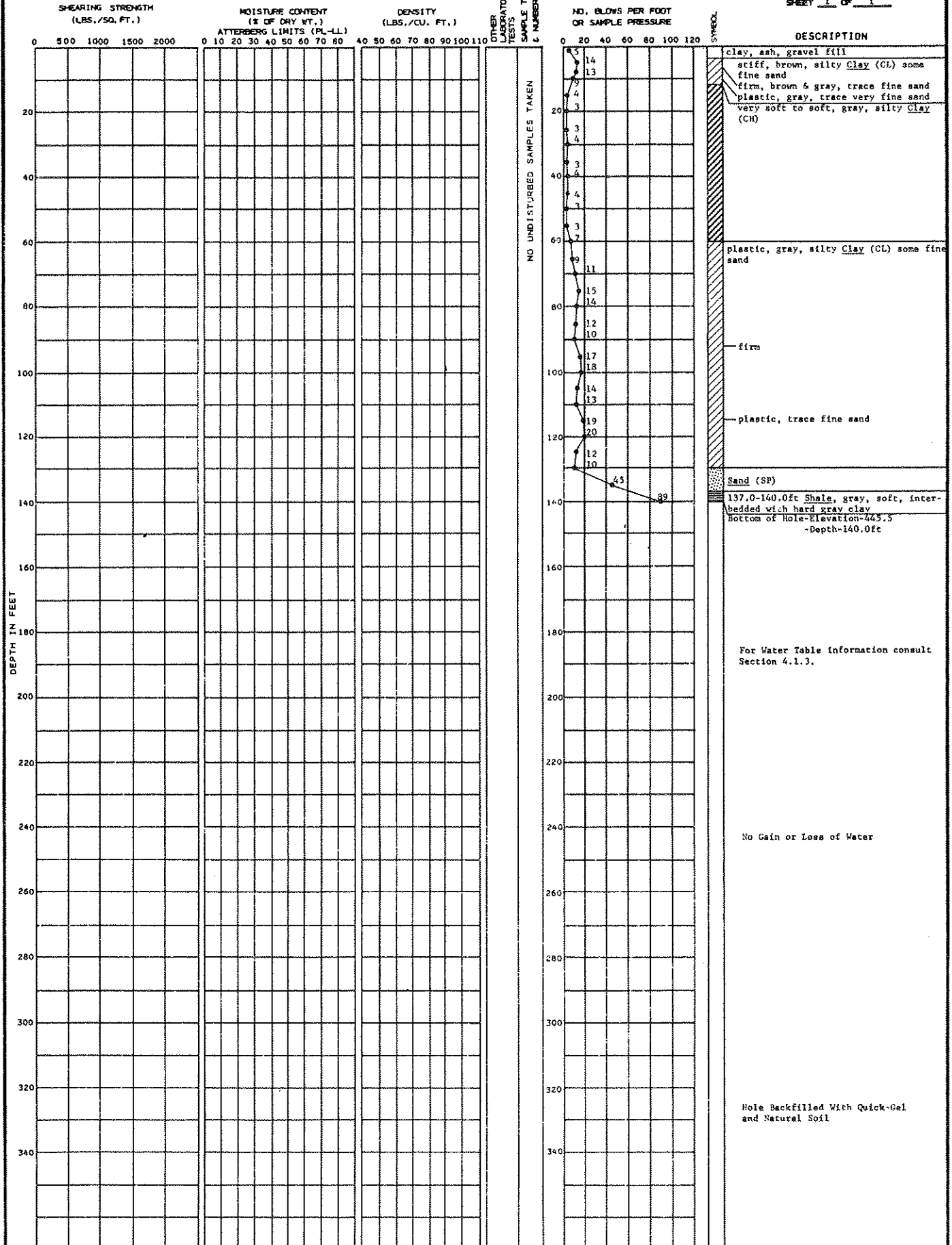

LOCATION: N 7,510
E11,380

GROUND ELEVATION: 588.8

DATE DRILLED: 1-29-74
2-5-74

SHEET 1 OF 1

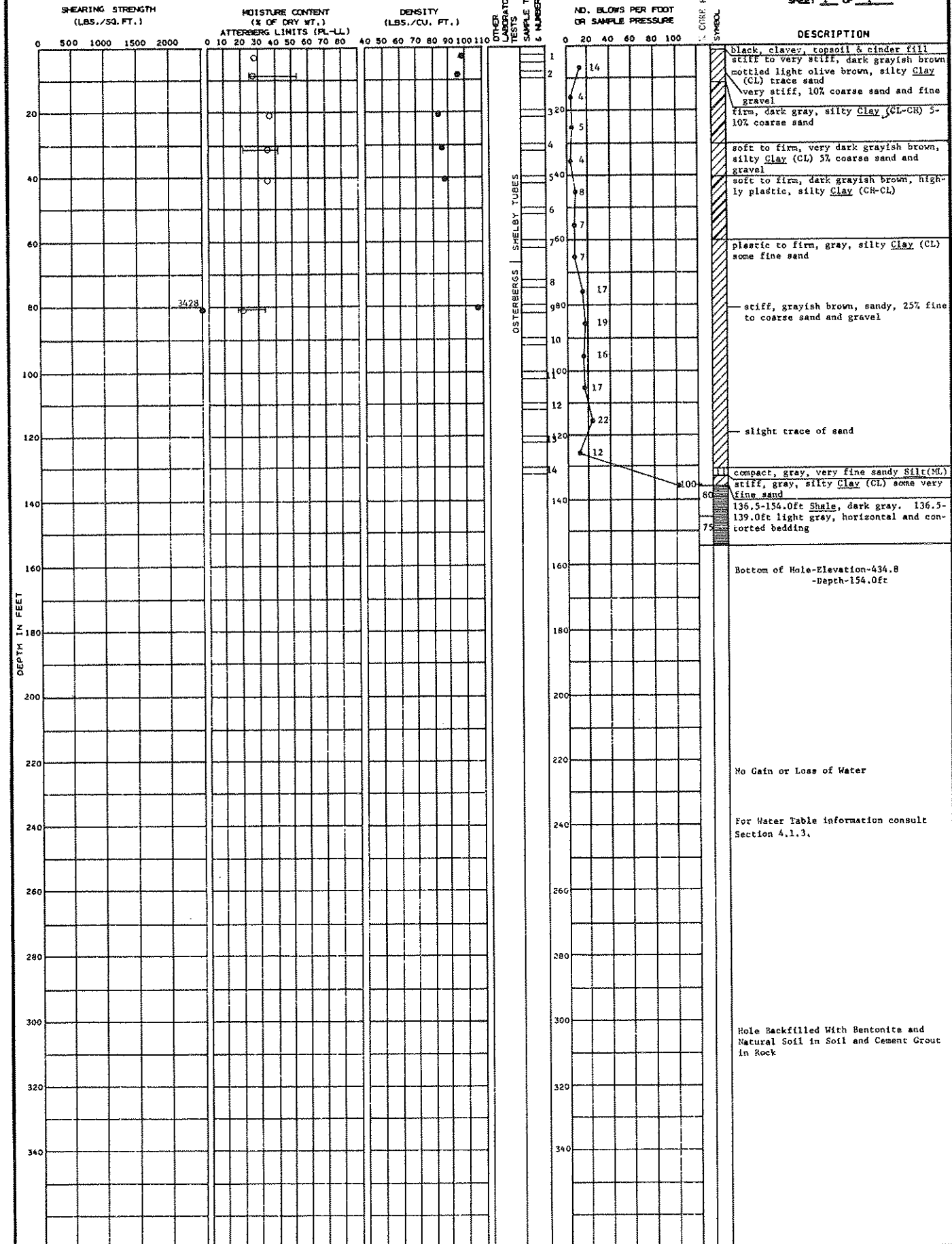

● Unconfined Compression
○ Atterberg Limits
○ Moisture Content

SOIL BORING NO. 119

BECHTEL Belle River

LOCATION: N 7,680 E 10,630 GROUND ELEVATION 587.9

DATE DRILLED: 2-14-74 2-19-74

SHEET 1 OF 1

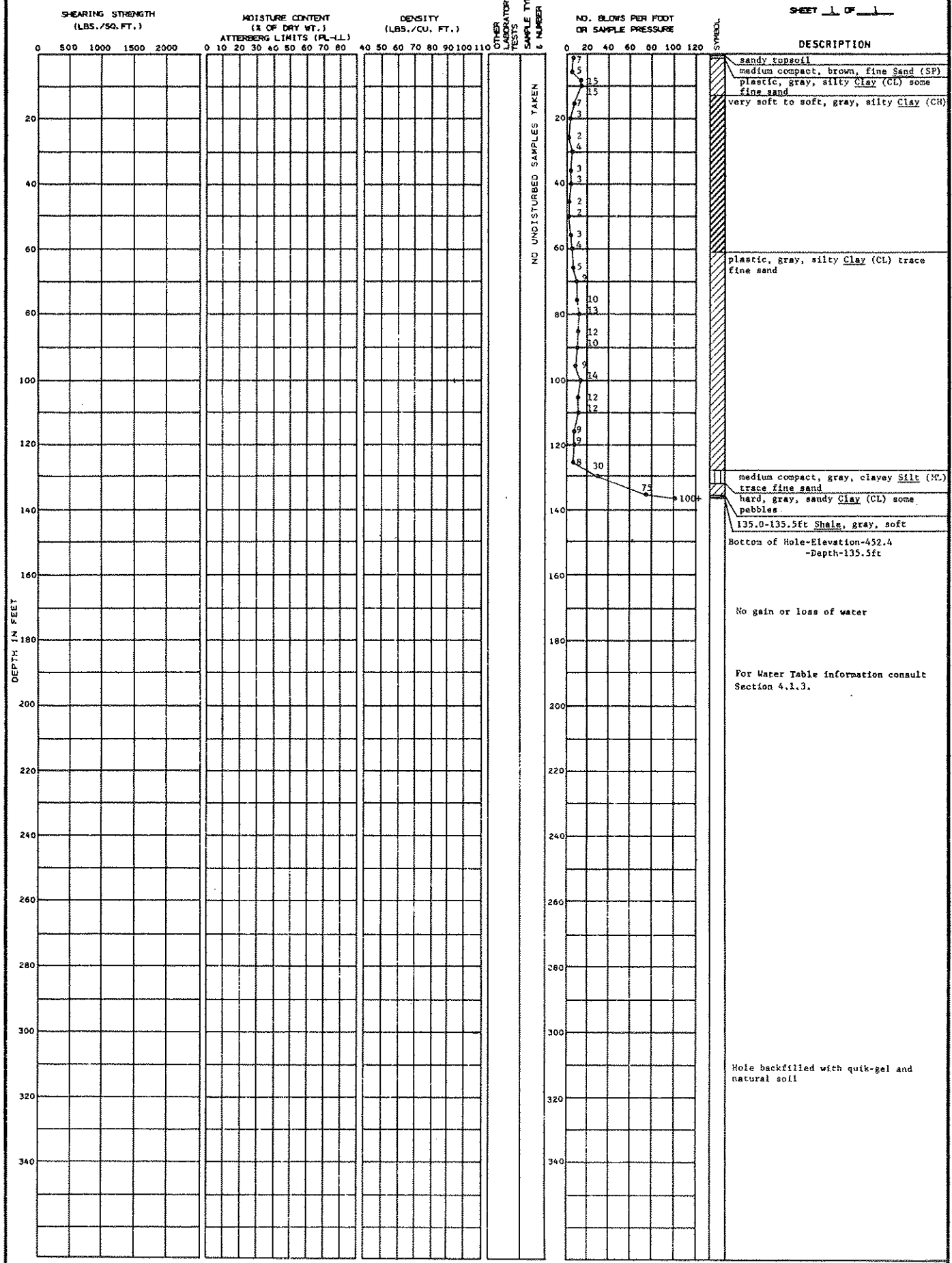

LOCATION: N 8,017
E 4,999

GROUND ELEVATION 588.9

DATE DRILLED: 3-25-74

SHEET 1 OF 1

SHEARING STRENGTH
(LBS./SQ. FT.)

MOISTURE CONTENT
(% OF DRY WT.)
ATTERBERG LIMITS (PL-LL)

DENSITY
(LBS./CU. FT.)

NO. BLOWS PER FOOT
OR SAMPLE PRESSURE

DESCRIPTION

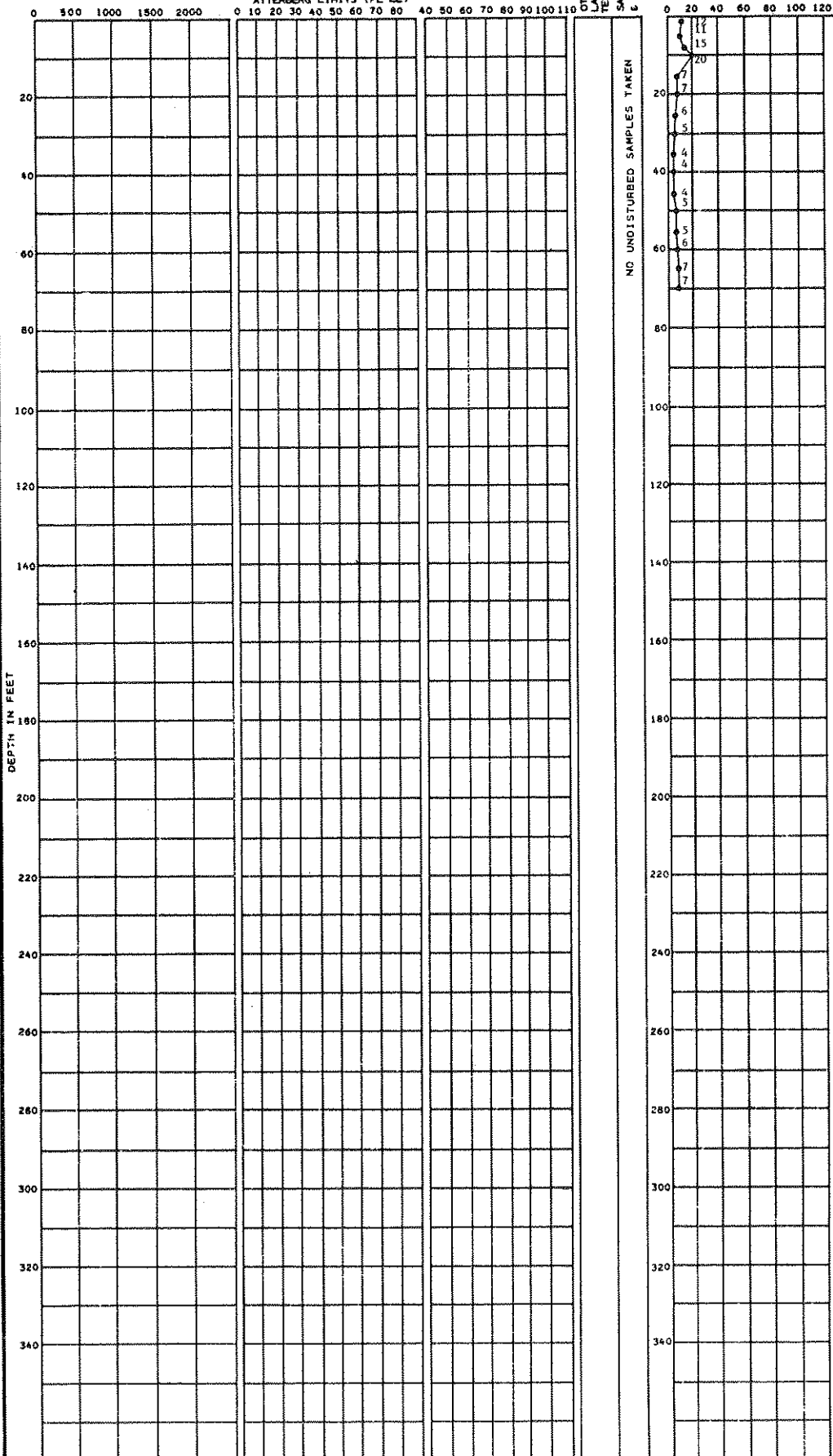

Gray, silty topsoil
 Medium, mottled brown & gray, silty sandy clay (CL), trace of pebbles
 Soft, gray, silty clay (CH), trace of sand

Bottom of hole - Elevation - 518.9
 - Depth - 70.0 ft

No gain or loss of water

For Water Table information consult Section 4.1.3.

Hole backfilled with Quik-Gel and natural soil

LOCATION: R 7,950 GROUND ELEVATION 588.8
 E 11,140

DATE DRILLED: 2-1-74
 2-6-74

SHEET 1 OF 1

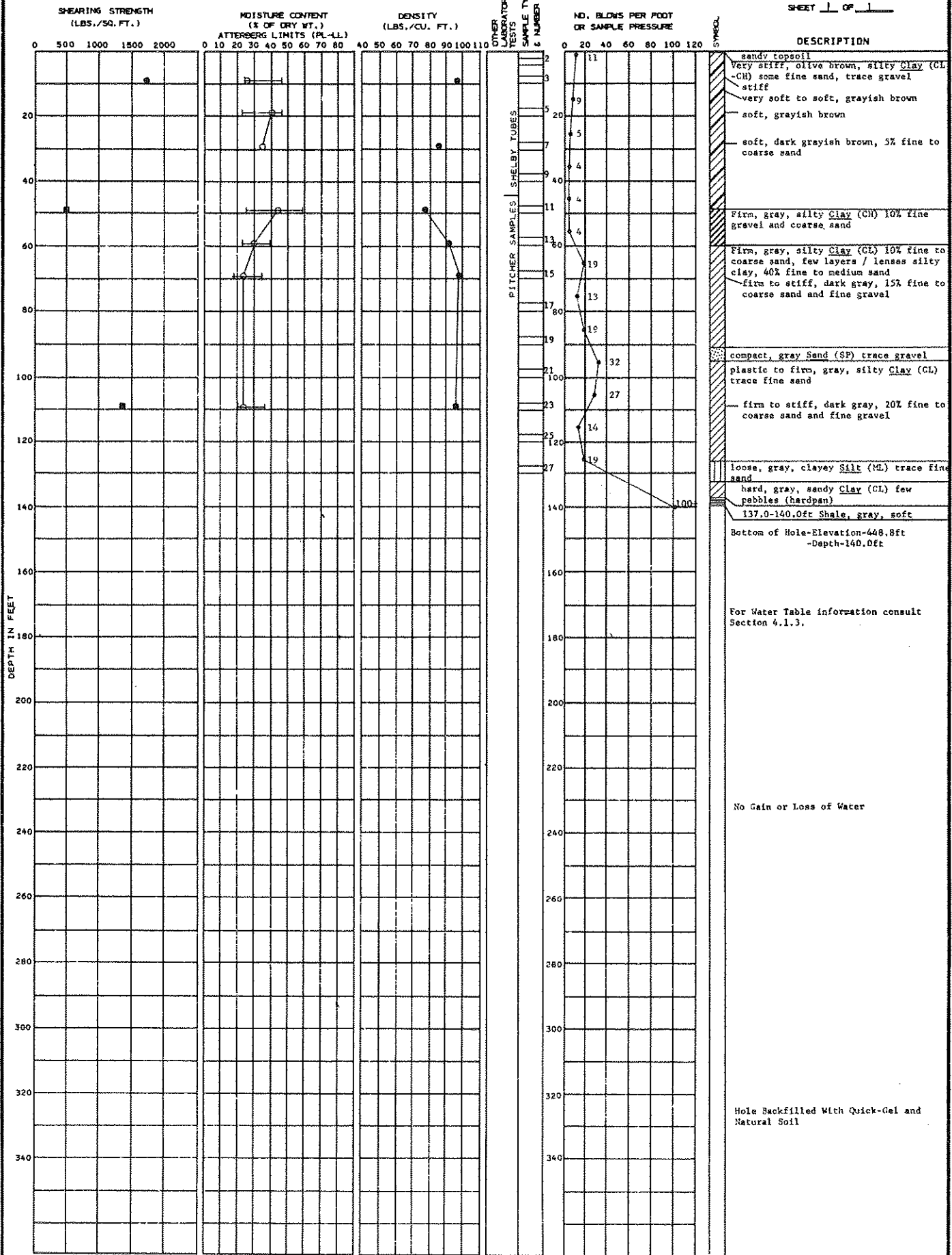

SOIL BORING NO. 126
 BECTEL Belle River

LOCATION: N 3,000
E 11,000 GROUND ELEVATION 589.5

DATE DRILLED: 2-7-74
2-13-74
SHEET 1 OF 1

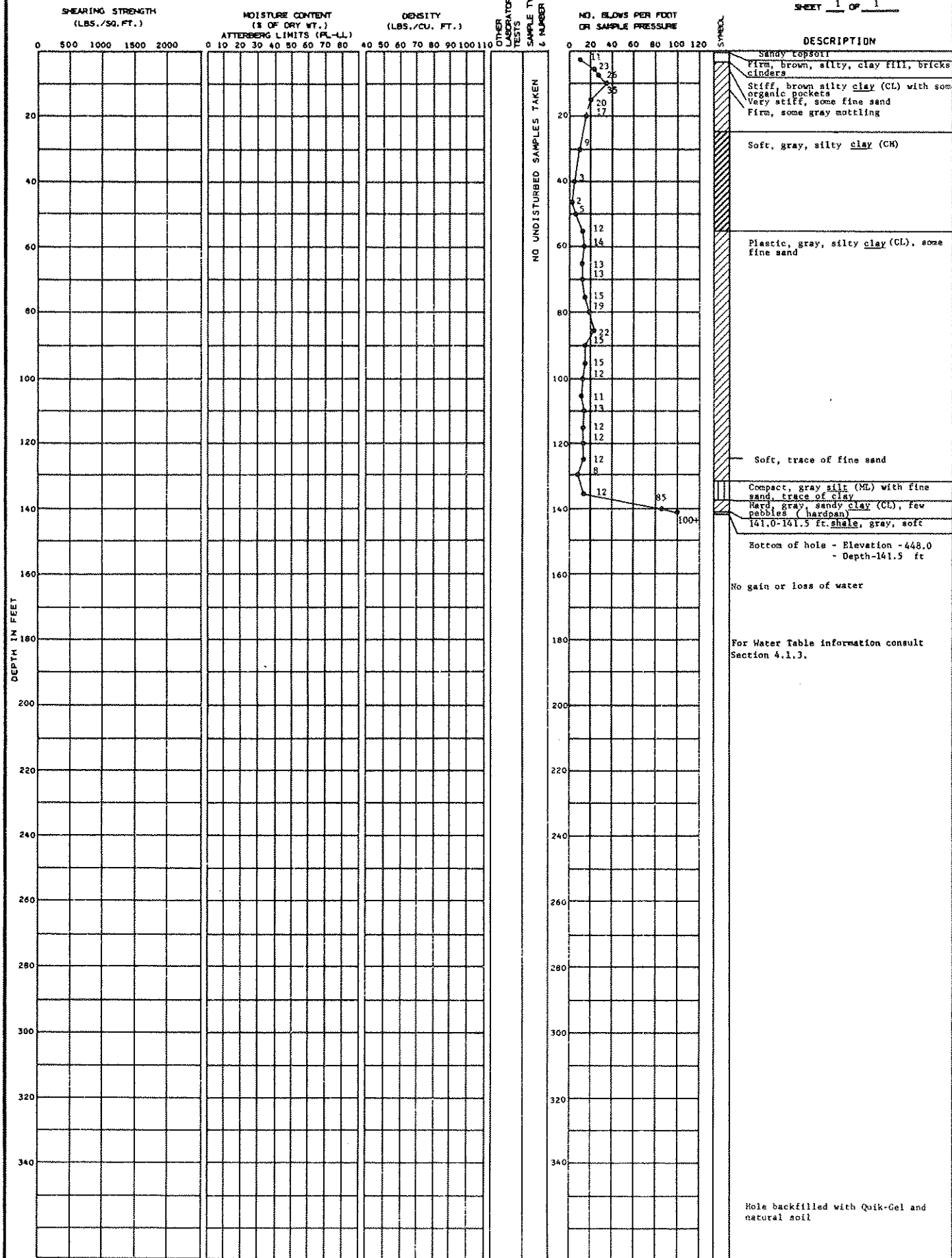

LOCATION: N 9,014 E 4,993 GROUND ELEVATION 595.3

DATE DRILLED: 3-26-74

3-28-74

SHEET 1 OF 1

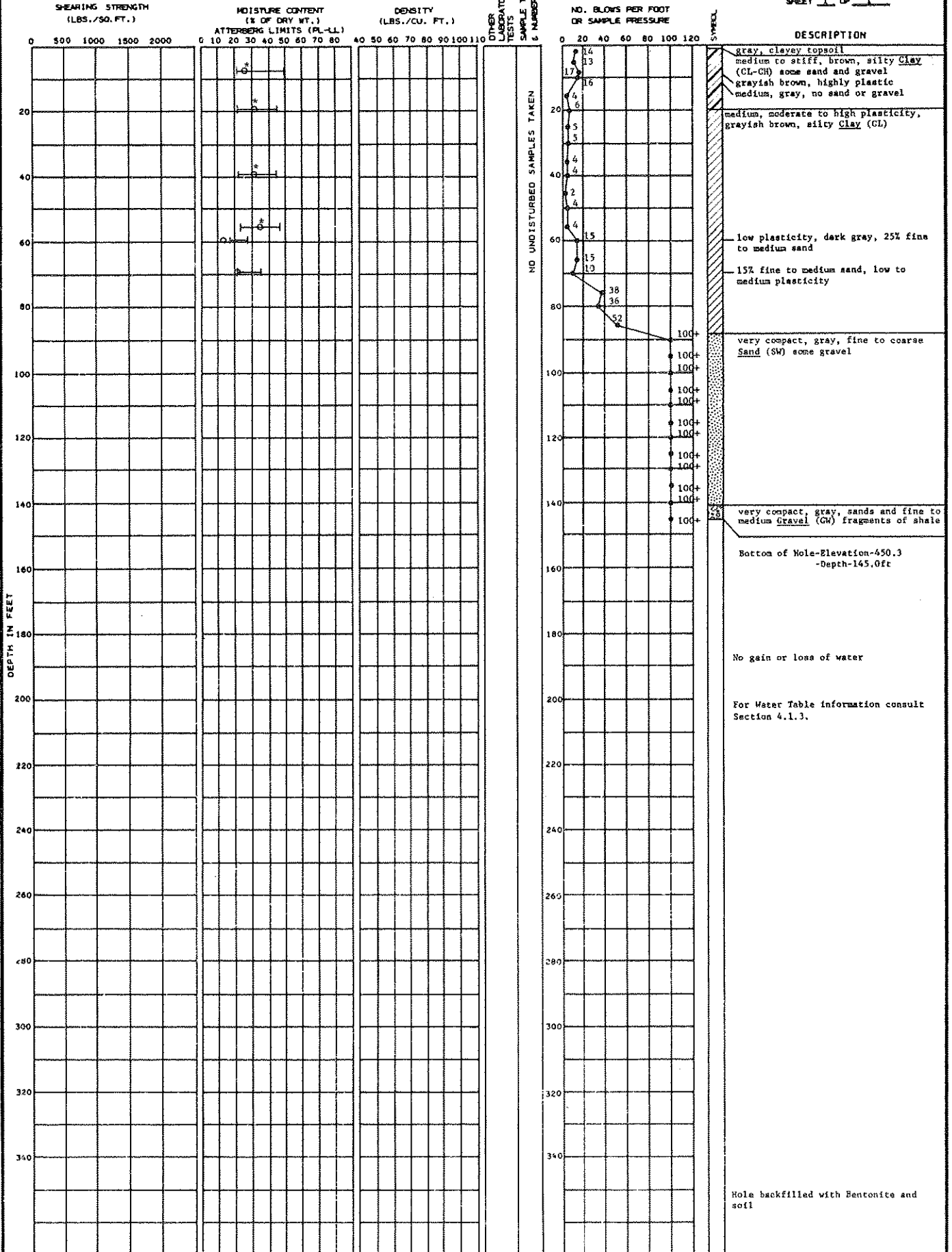

○ Water Content
 — Atterburg Limiter
 * Water content taken from unsealed jar sample.

SOIL BORING NO. 130

BECHTEL Bella River

LOCATION: N 10,050 E 4,995 GROUND ELEVATION 594.6

DATE DRILLED: 3-5-74 3-7-74 SHEET 1 OF 1

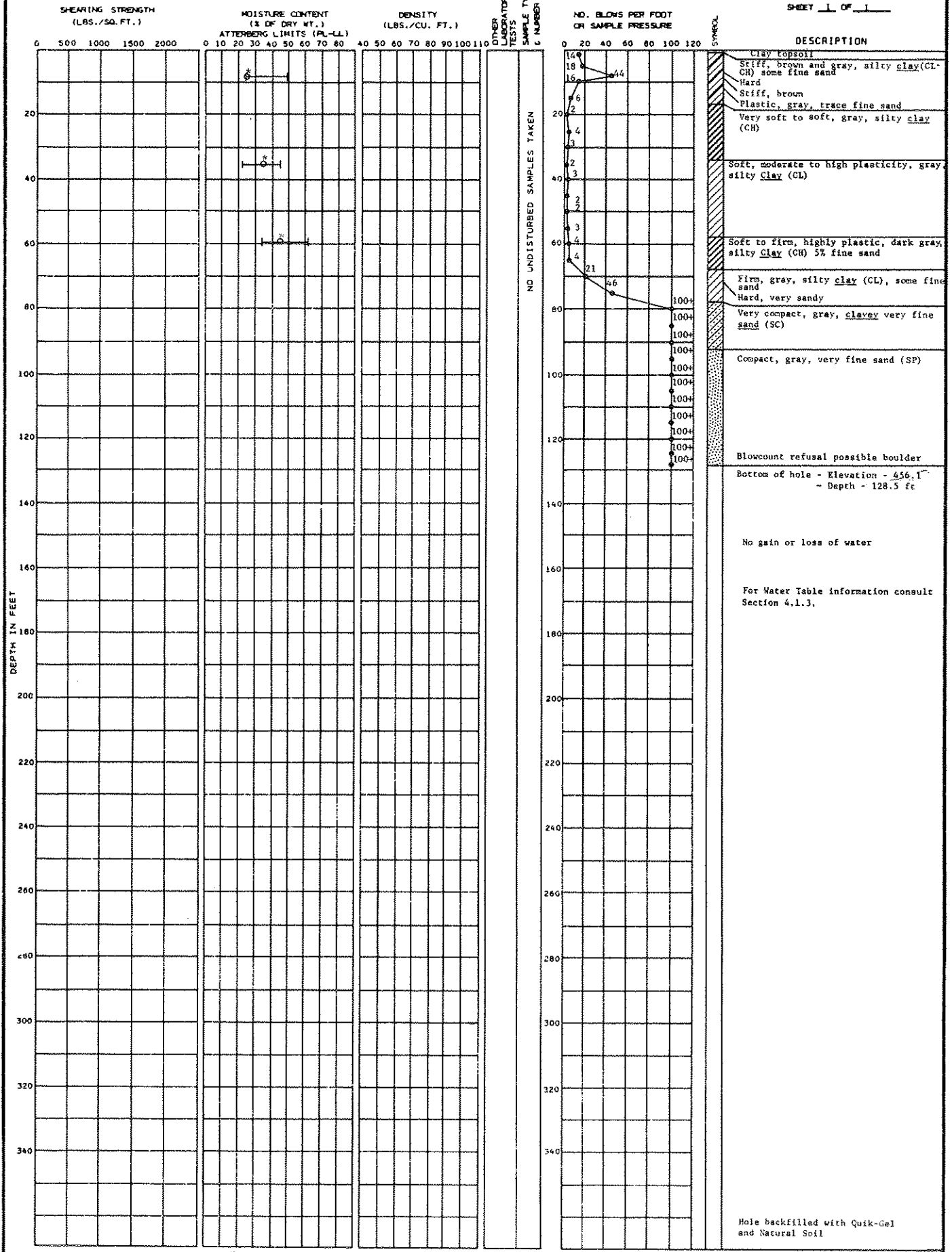

○ Water Content
 — Atterburg Limits
 * Water content taken from unsealed jar sample.

LOCATION: N 10,050 E 7,000 GROUND ELEVATION 590.2

DATE DRILLED: 3-8-74 3-13-74

SHEET 1 OF 1

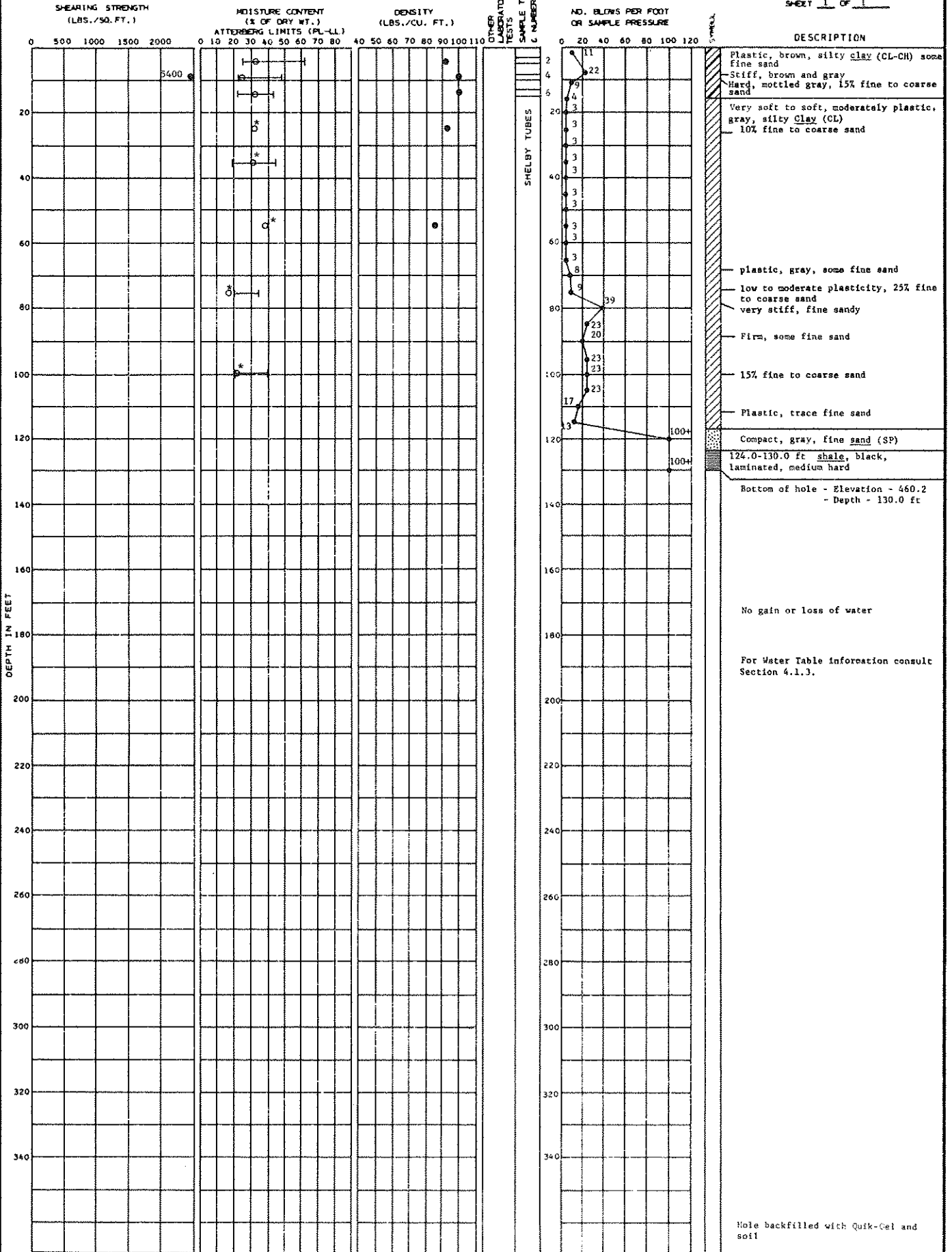

● Unconfined Compression
 ○ Moisture Content
 — Atterberg Limits
 * Water content taken from unsealed jar sample.

LOCATION: 10,030
S.977

GROUND ELEVATION

582.7

DATE DRILLED: 3-11-74
3-14-74

SHEET 1 OF 1

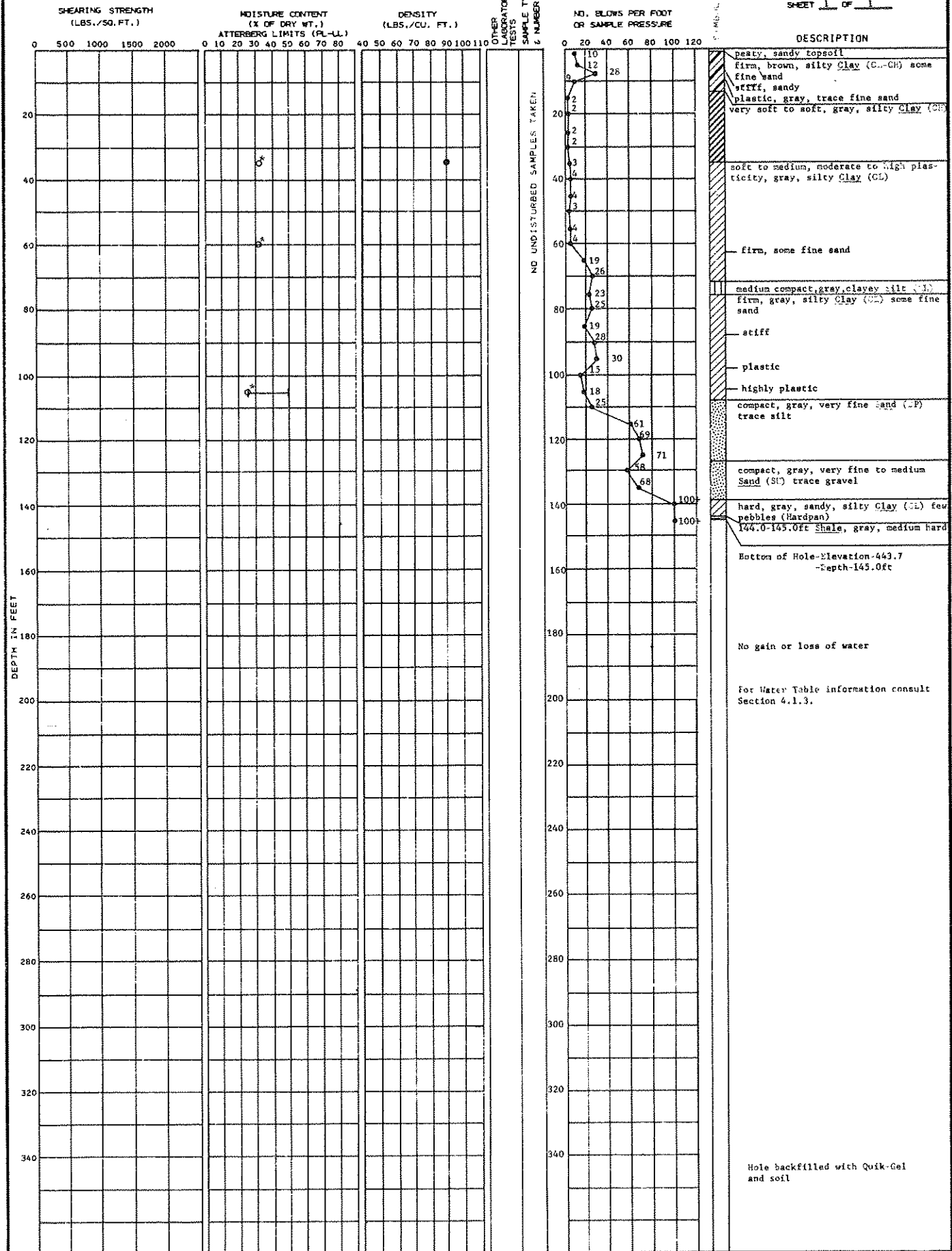

○ Water Content
Atterburg Limits
Water content taken from
unsealed jar sample.

SOIL BORING NO. 138

BECHTEL Belle River

LOCATION: 10.850 GROUND ELEVATION: 592.0
S. 003

DATE DRILLED: 3-19-74
3-20-74

SHEET 1 OF 1

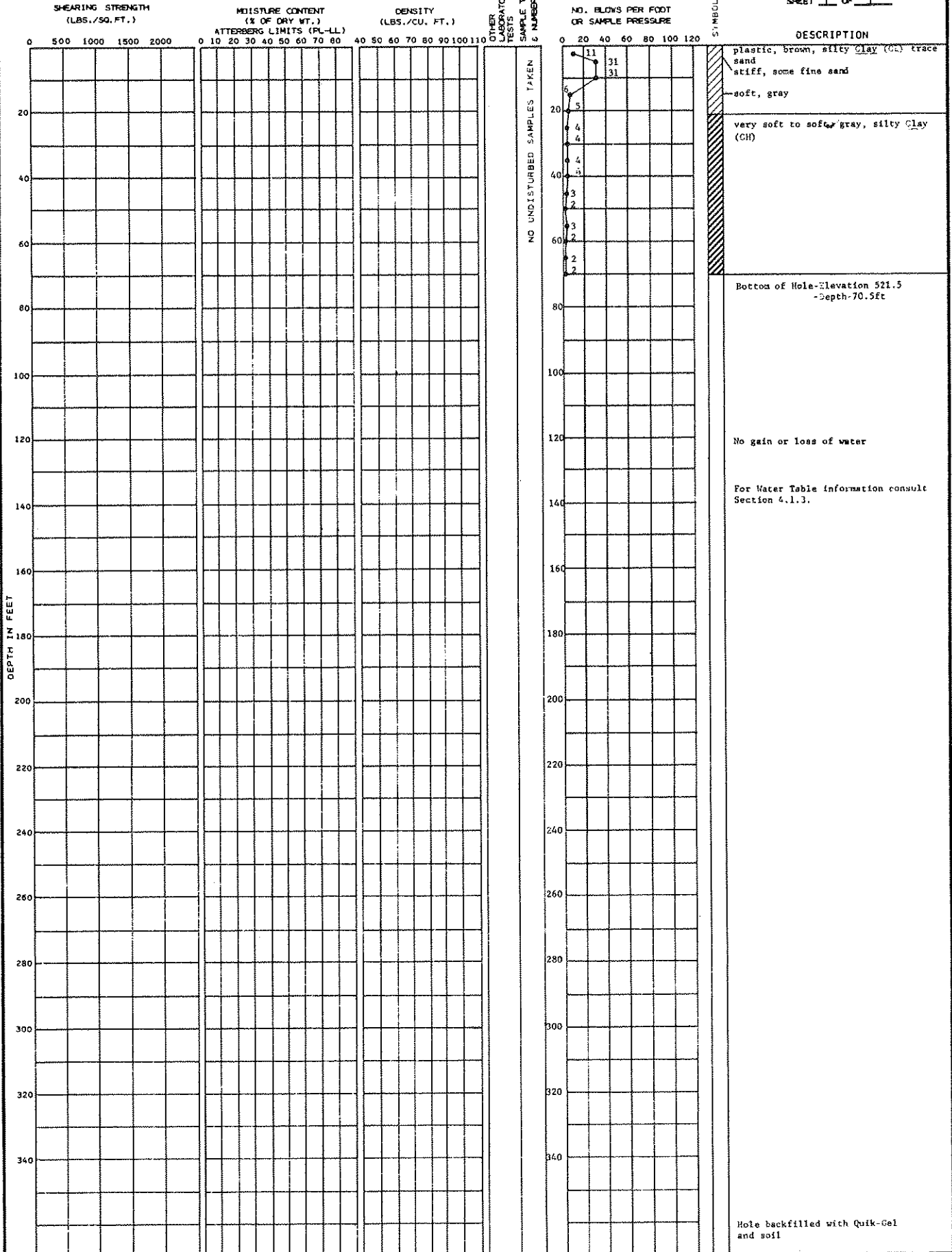

Bottom of Hole-Elevation 521.5
-Depth-70.5ft

No gain or loss of water

For Water Table information consult Section 4.1.3.

Hole backfilled with Quik-Gel and soil

SOIL BORING NO. 140

BECHTEL Belle River

LOCATION: 11,146 GROUND ELEVATION 589.0
 7,995

DATE DRILLED: 3-25-74
 3-27-74

SHEET 1 OF 1

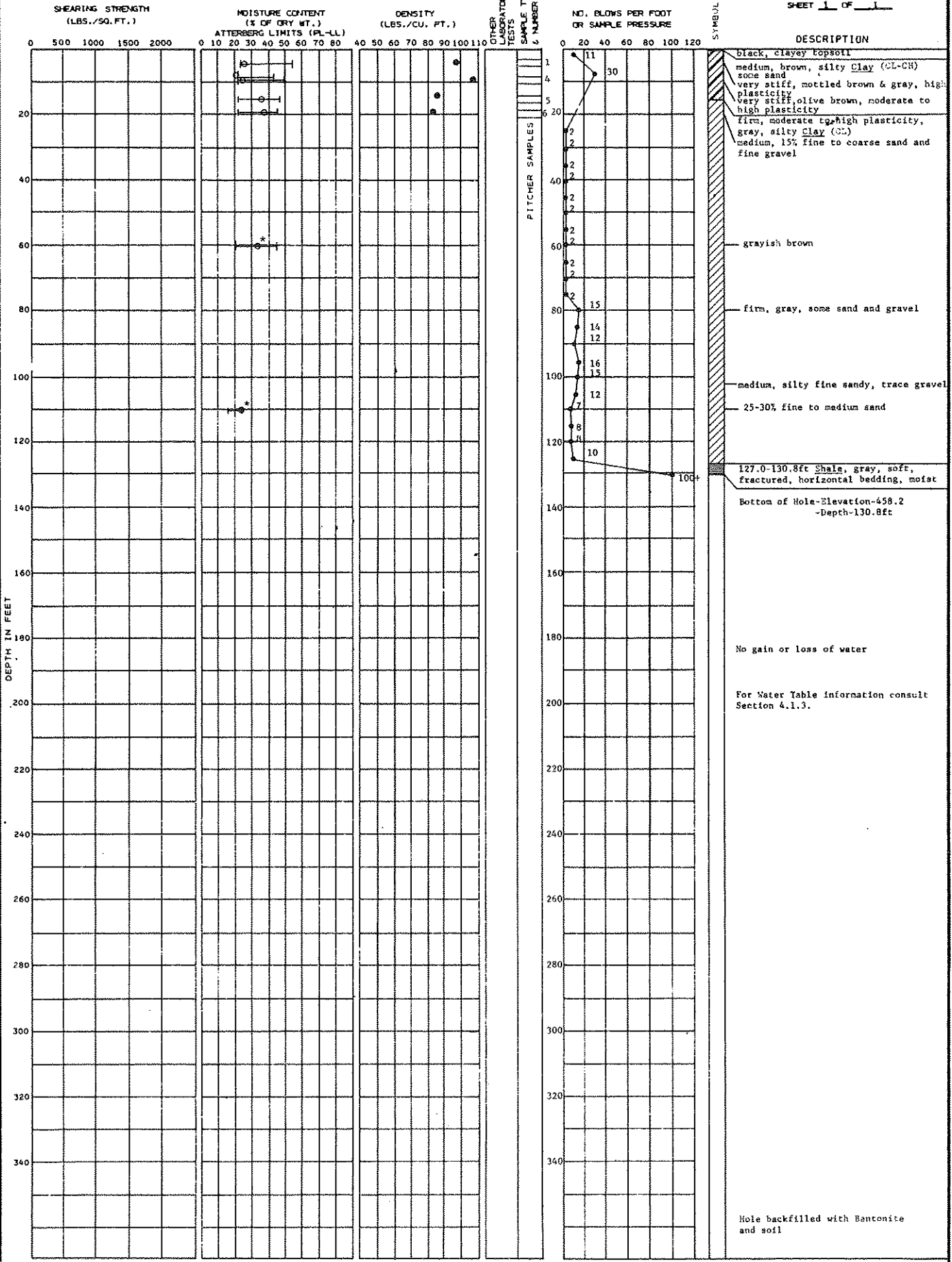

○ Moisture Content
 — Atterberg Limits
 * Water content taken from unsealed jar sample.

SOIL BORING NO. 142

BECHTEL Keller

LOCATION: N 12,000 E 5,000 GROUND ELEVATION: 597.5

DATE DRILLED: 3-13-74
3-15-74
SHEET 1 OF 1

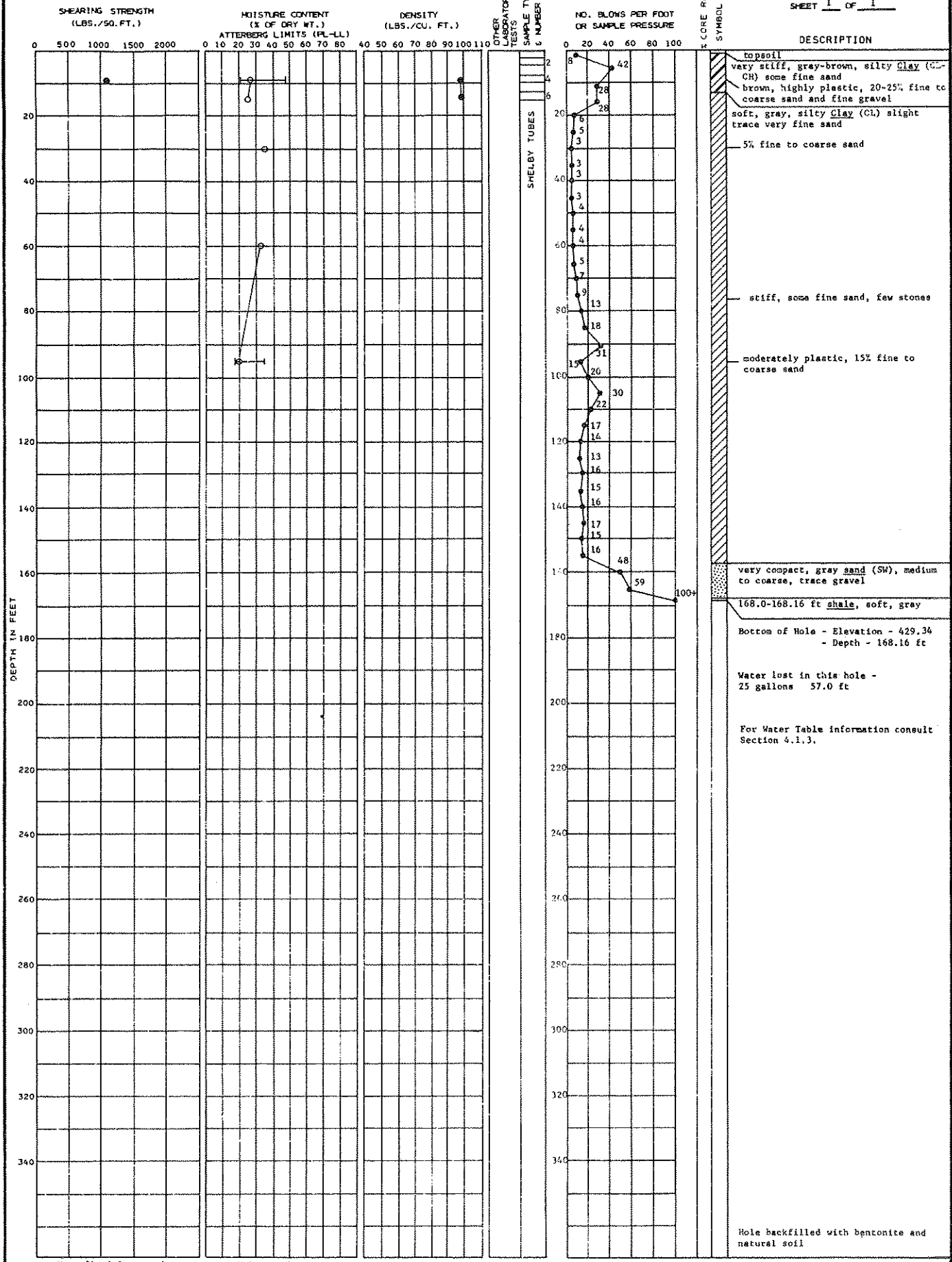

● Unconfined Compression ○ Moisture Content
— Atterburg Limits

LOCATION: N 12,000
E 7,000 GROUND ELEVATION 589.7

3-18-74
DATE DRILLED: 3-19-74

SHEET 1 OF 1

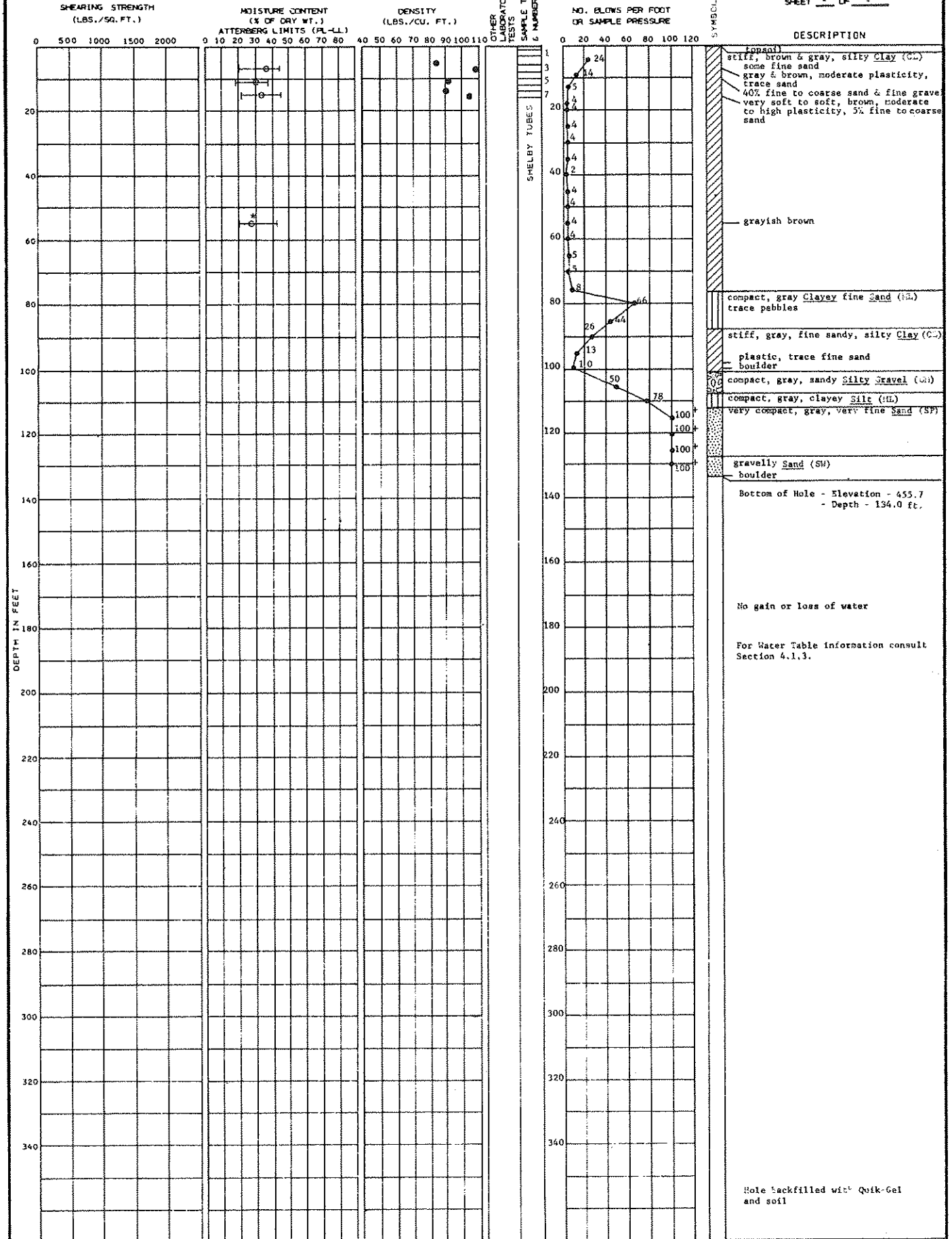

Bottom of Hole - Elevation - 455.7
- Depth - 134.0 ft.

No gain or loss of water

For Water Table Information consult Section 4.1.3.

Hole backfilled with Quik-Gel and soil

Moisture Content
Atterburg Limits
* Water content taken from unsealed jar sample.

LOCATION: N 13,061
E 5,006

GROUND ELEVATION: 598.6

DATE DRILLED: 3-28-74
SHEET 1 OF 1

DEPTH IN FEET	SHEARING STRENGTH (LBS./SQ. FT.)				MOISTURE CONTENT (% OF DRY WT.) ATTERBERG LIMITS (PL-LL)				DENSITY (LBS./CU. FT.)				OTHER LABORATORY TESTS	NO. UNDISTURBED SAMPLES TAKEN	SAMPLE TYPE & NUMBER	NO. BLOWS PER FOOT OR SAMPLE PRESSURE	SYMBOL	DESCRIPTION								
	0	500	1000	1500	2000	0	10	20	30	40	50	60							70	80	40	50	60	70	80	90
0																							11			Black, clayey topsoil
10																							13			Firm, brown & gray, silty, sandy clay (CL), trace of pebbles
20																							12			
30																							15			Soft, gray, silty clay (CH), trace of sand
40																							4			
50																							4			
60																							2			
70																							2			
80																							3			
90																							2			
100																							2			
110																							2			
120																							2			
130																							2			
140																							2			
150																							2			
160																							2			
170																							2			
180																							2			
190																							2			
200																							2			
210																							2			
220																							2			
230																							2			
240																							2			
250																							2			
260																							2			
270																							2			
280																							2			
290																							2			
300																							2			
310																							2			
320																							2			
330																							2			
340																							2			
350																							2			
360																							2			
370																							2			
380																							2			
390																							2			
400																							2			
410																							2			
420																							2			
430																							2			
440																							2			
450																							2			
460																							2			
470																							2			
480																							2			
490																							2			
500																							2			
510																							2			
520																							2			
530																							2			
540																							2			
550																							2			
560																							2			
570																							2			
580																							2			
590																							2			
600																							2			
610																							2			
620																							2			
630																							2			
640																							2			
650																							2			
660																							2			
670																							2			
680																							2			
690																							2			
700																							2			

Bottom of hole - Elevation - 528.6
- Depth - 70.0 ft

No gain or loss of water

For Water Table information consult Section 4.1.3.

Hole backfilled with Quik-Gel and natural soil

LOCATION: N 7455 E 9535 GROUND ELEVATION 585.2

DATE DRILLED: 9/28/77 9/30/77 SHEET 1 OF 1

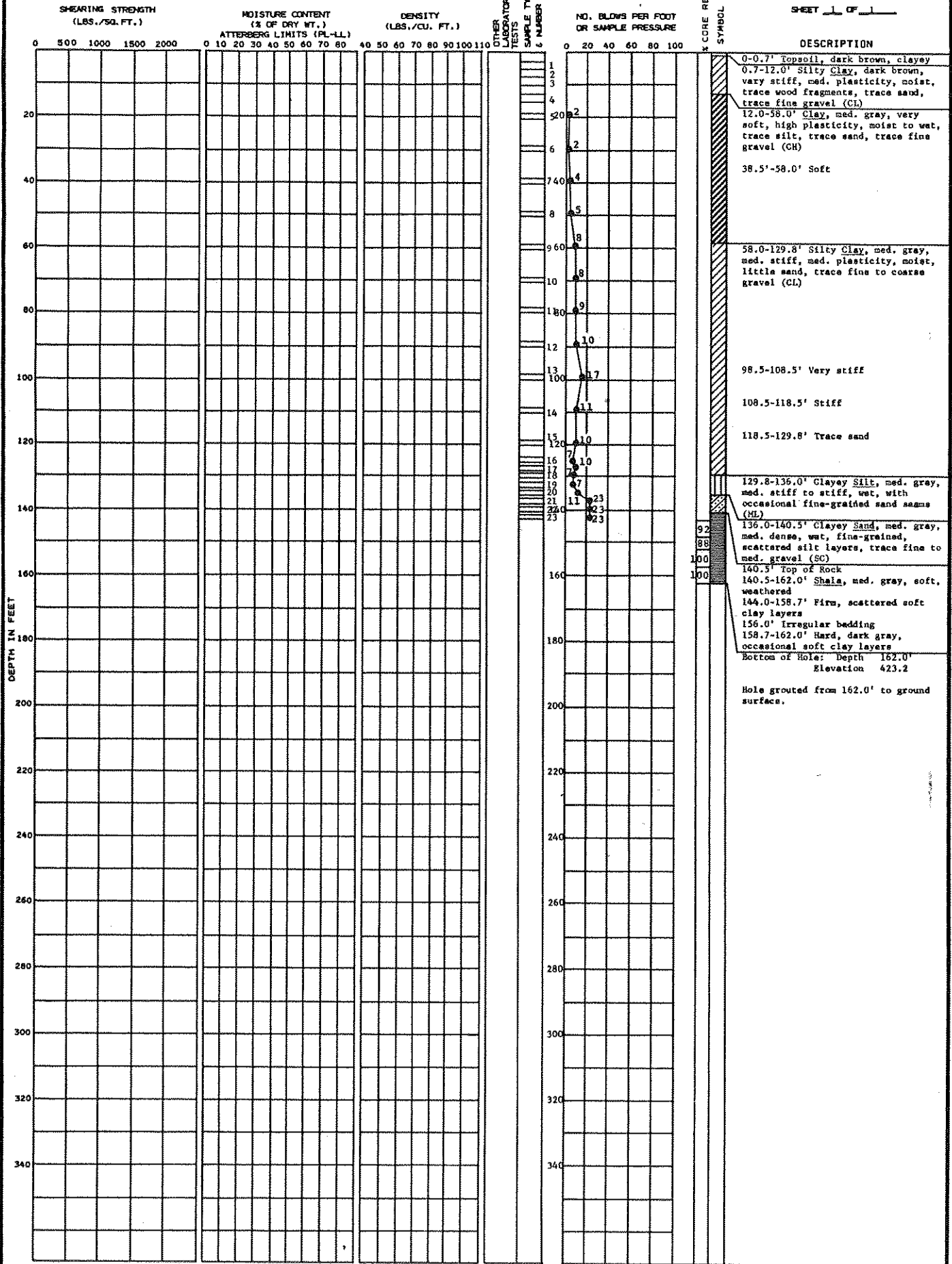

SOIL BORING NO. B-8 BECHTEL Belle River

LOCATION: N 7675 E 9100 GROUND ELEVATION 585.6

DATE DRILLED: 8/8/77 8/11/77

SHEET 1 OF 1

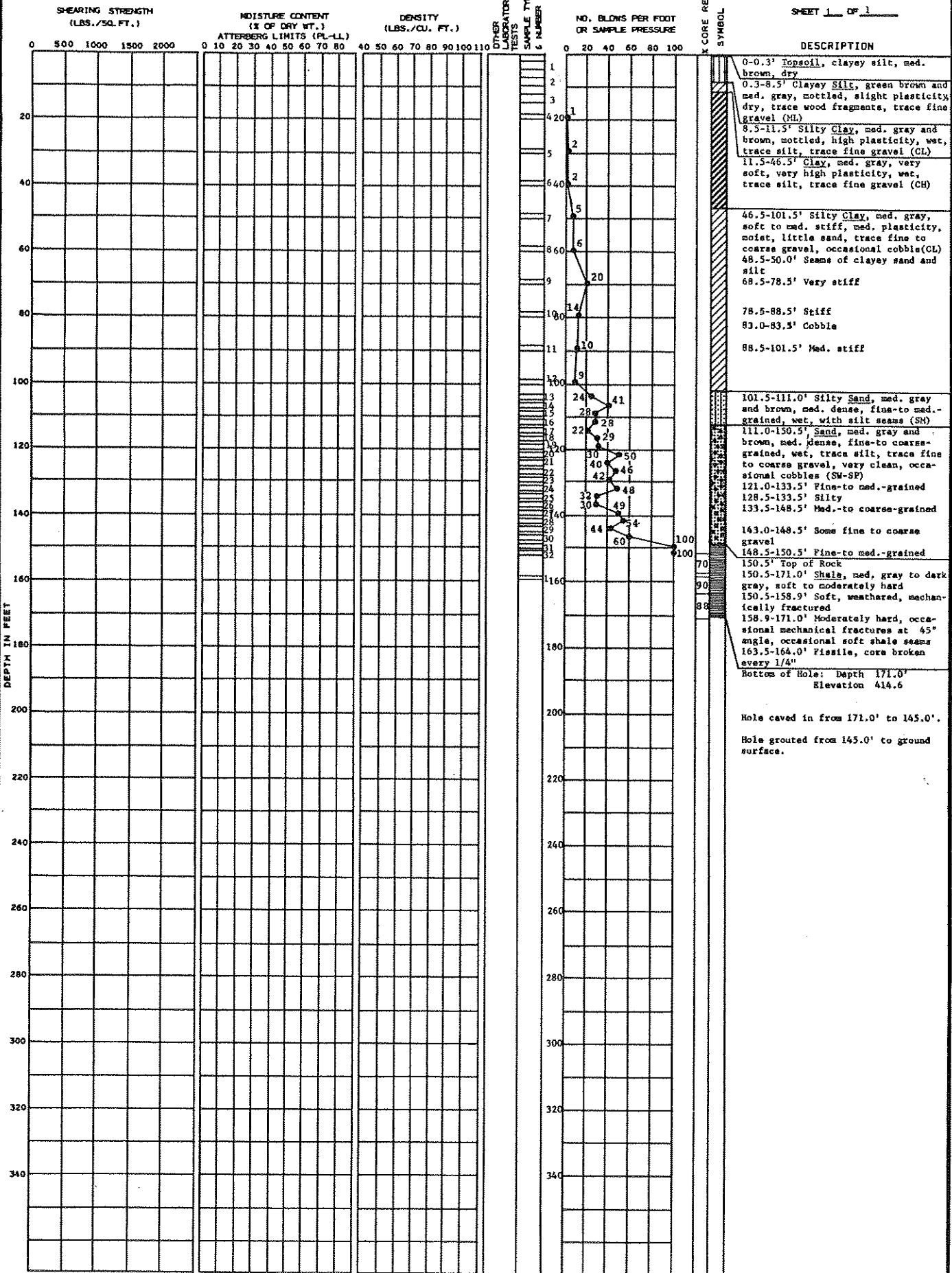

SOIL BORING NO. B-9

BECHTEL Belle River

LOCATION: N 7500 E 9388.7 GROUND ELEVATION 585.3

DATE DRILLED: 7/21/77
7/23/77
SHEET 1 OF 1

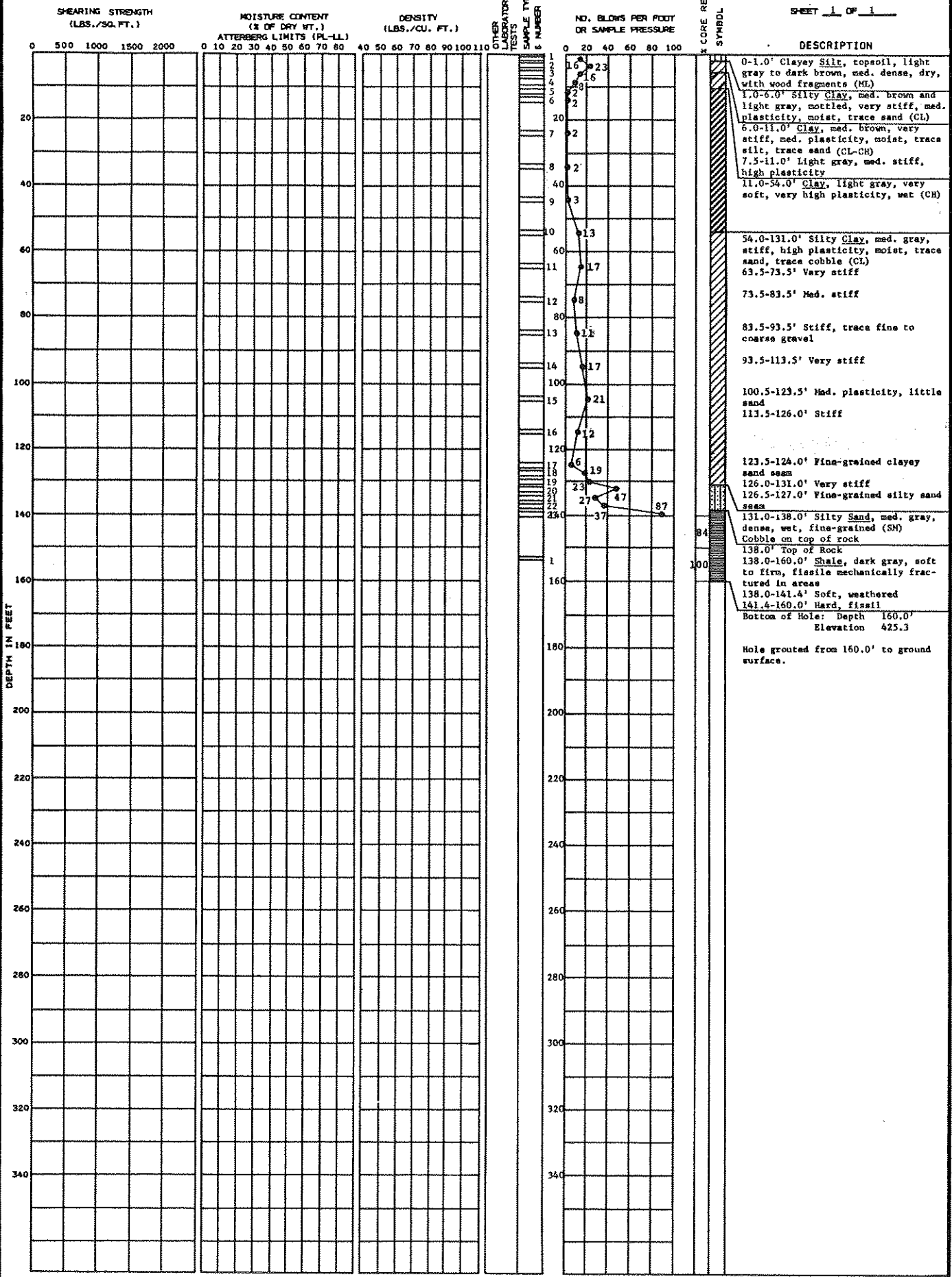

SOIL BORING NO. B-12
BECHTEL, Bella River

LOCATION: N 13,000 E 7,000 GROUND ELEVATION 590.6

DATE DRILLED: 3-27-74
3-28-74

SHEET 1 OF 1

DEPTH IN FEET	SHEARING STRENGTH (LBS./SQ. FT.)	MOISTURE CONTENT (% OF DRY WT.) ATTERBERG LIMITS (PL-LL)	DENSITY (LBS./CU. FT.)	OTHER LABORATORY TESTS	NO. BLOWS PER FOOT OR SAMPLE PRESSURE	SYMBOL	DESCRIPTION
0							black, clayey topsoil
0-20					20		medium, brown, silty Clay (CL) trace of sand and gravel
20-25					13		gray, silty
25-30					7		soft, gray, sandy, silty Clay (CH)
30-35					2		no sand
35-40					2		
40-45					2		
45-50					2		
50-55					2		
55-60					2		
60-65					2		
65-70					2		
70-75					2		
75-80					2		
80							Bottom of Hole-Elevation-520.1 -Depth-70.5ft
80-120							No gain or loss of water
120-340							For Water Table information consult Section 4.1.3.
340							Hole backfilled with Bentonite and soil

SOIL BORING NO. 150

BECHTEL Belle River

LOCATION: N 13,785 E 5,006 GROUND ELEVATION 599.0

DATE DRILLED: 3-7-74 3-14-74

SHEET 1 OF 1

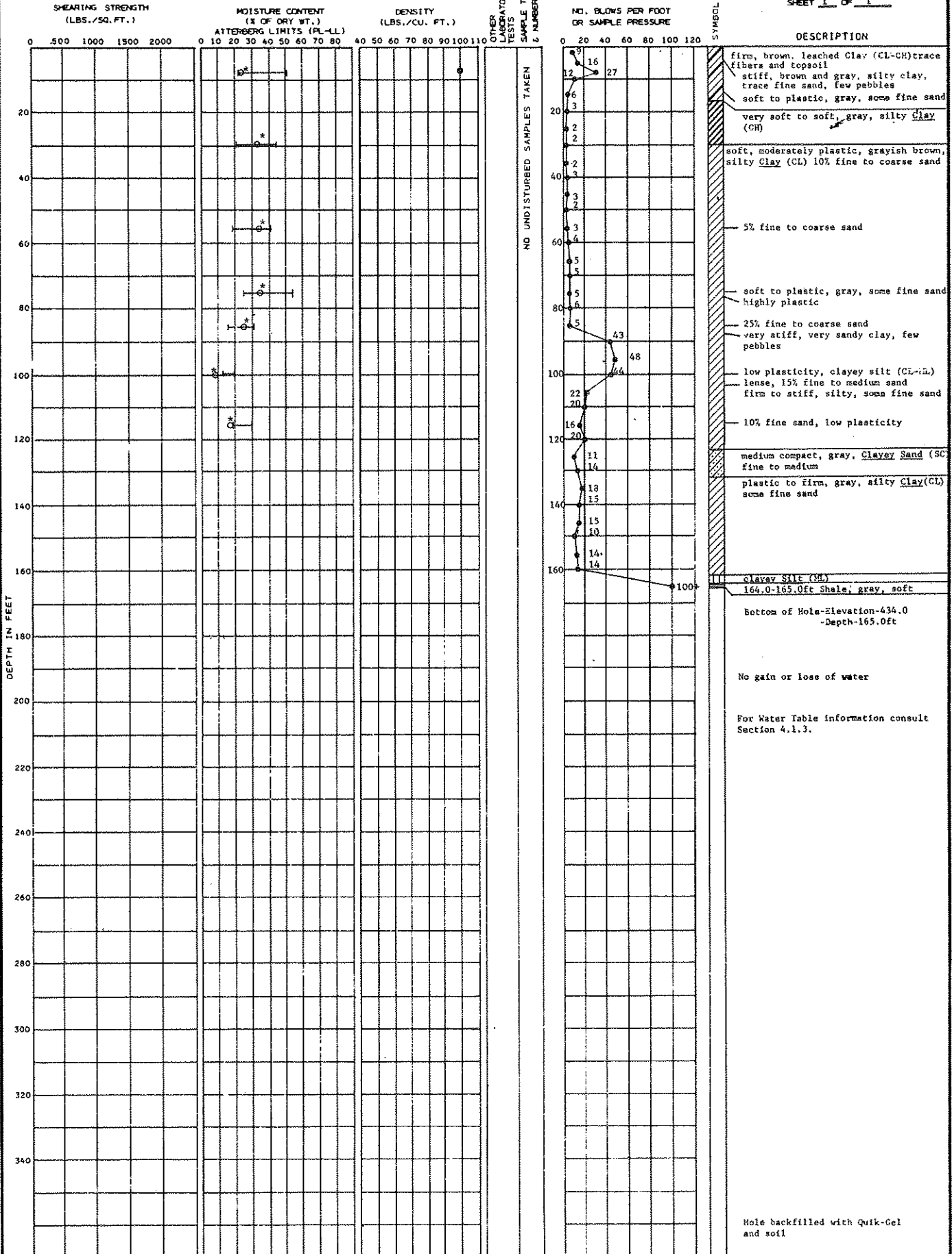

○ Moisture Content
 — Atterberg Limits
 * Water content taken from unsealed jar sample.

LOCATION: N 14,000 E 8,000 GROUND ELEVATION 591.5

DATE DRILLED: 4-5-74

SHEET 1 OF 1

DEPTH IN FEET	SHEARING STRENGTH (LBS./SQ. FT.)	MOISTURE CONTENT (X OF DRY WT.) ATTENBERG LIMITS (PL-LL)	DENSITY (LBS./CU. FT.)	OTHER LABORATORY TESTS	NO. BLOWS PER FOOT OR SAMPLE PRESSURE	SYMBOL	DESCRIPTION
0					14 30 22		Consolidated firm to stiff, brown, silty clay (CL) very stiff, trace gravel plastic to firm, gray
20					7		soft, gray, silty clay (CH)
40					4 4 3 2 2 2 2 2		
60							
80							Bottom of Hole - Elevation - 521.5 - Depth - 70.0 ft.
100							
120							No gain or loss of water
140							For Water Table information consult Section 4.1.3.
160							
180							
200							
220							
240							
260							
280							
300							
320							
340							Hole backfilled with Quik-Gel and soil

SOIL BORING NO. 157

BECHTEL Belle River

LOCATION: N 14,000 E 9,950 GROUND ELEVATION 591.3

DATE DRILLED: 4-3-74 SHEET 1 OF 1

DEPTH IN FEET	SHEARING STRENGTH (LBS./SQ. FT.)	MOISTURE CONTENT (% OF DRY WT.) ATTERBERG LIMITS (PL-LL)	DENSITY (LBS./CU. FT.)	NO. OF LABORATORY TESTS	SAMPLE TYPE	NO. BLOWS PER FOOT OR SAMPLE PRESSURE	SYMBOL	DESCRIPTION
0								GRAY SILT (ML)
0						17		loose to medium compact, brown to gray, silty sand (SM) fine to medium
0						15		firm, gray, silty clay (CL)
20						4		soft, gray, silty clay (CH)
40						2		
60						2		
80						2		
100						3		
120						4		
140						4		
160						5		
180								
200								
220								
240								
260								
280								
300								
320								
340								
								Bottom of Hole - Elevation - 521.3 - Depth - 70.0 ft.
								No gain or loss of water
								For Water Table information consult Section 4.1.3.
								Hole backfilled with Quik-Gel in soil

LOCATION: N 15,000
E 8,000

GROUND ELEVATION: 591.4

DATE DRILLED: 4-8-76

SHEET 1 OF 1

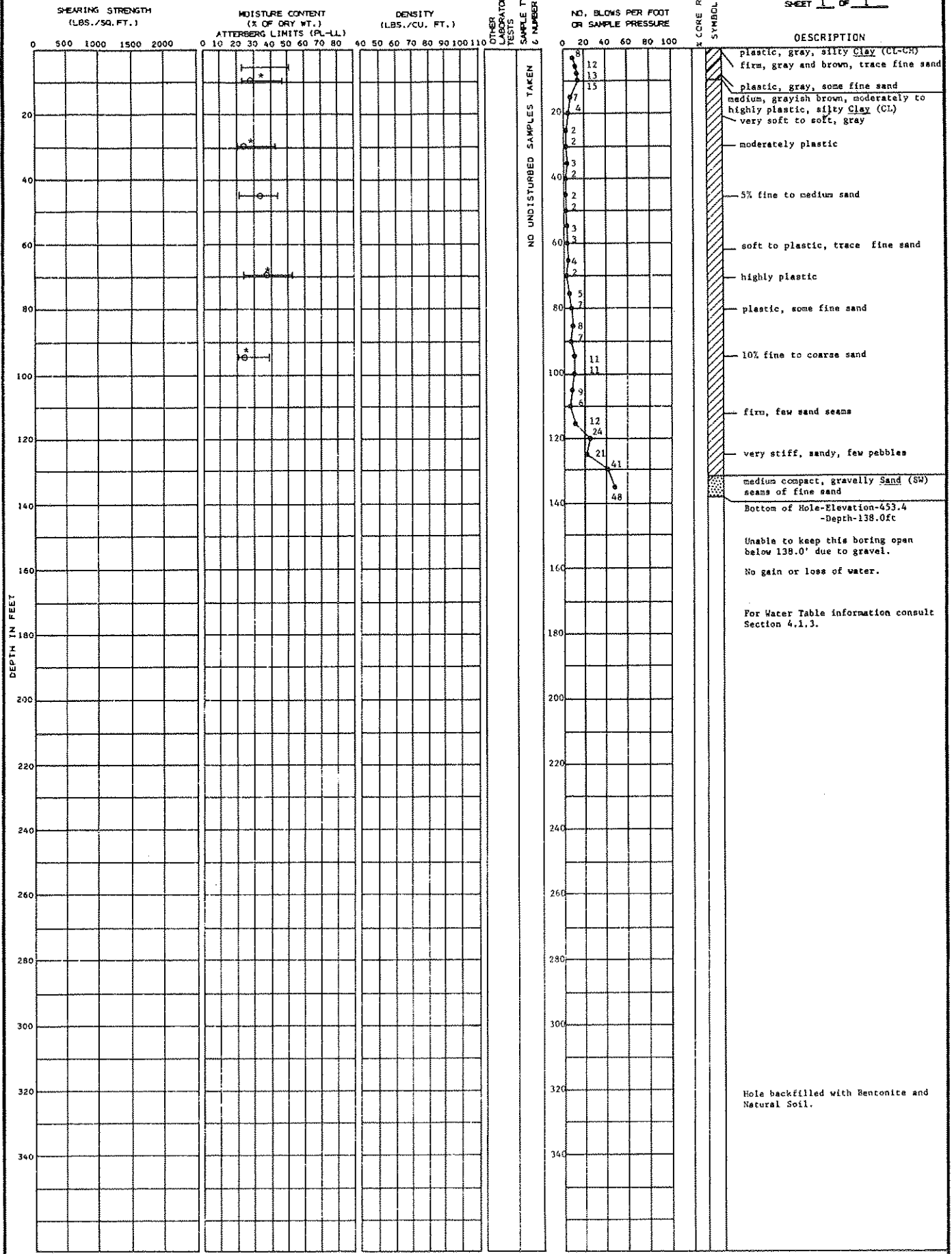

○ Moisture Content
 — Atterbury Limits
 * Water content taken from unsealed jar sample.

LOCATION: N 14,830 GROUND ELEVATION 594.3
 E 9,938

DATE DRILLED: 3-26-74
 3-27-74

SHEET 1 OF 1

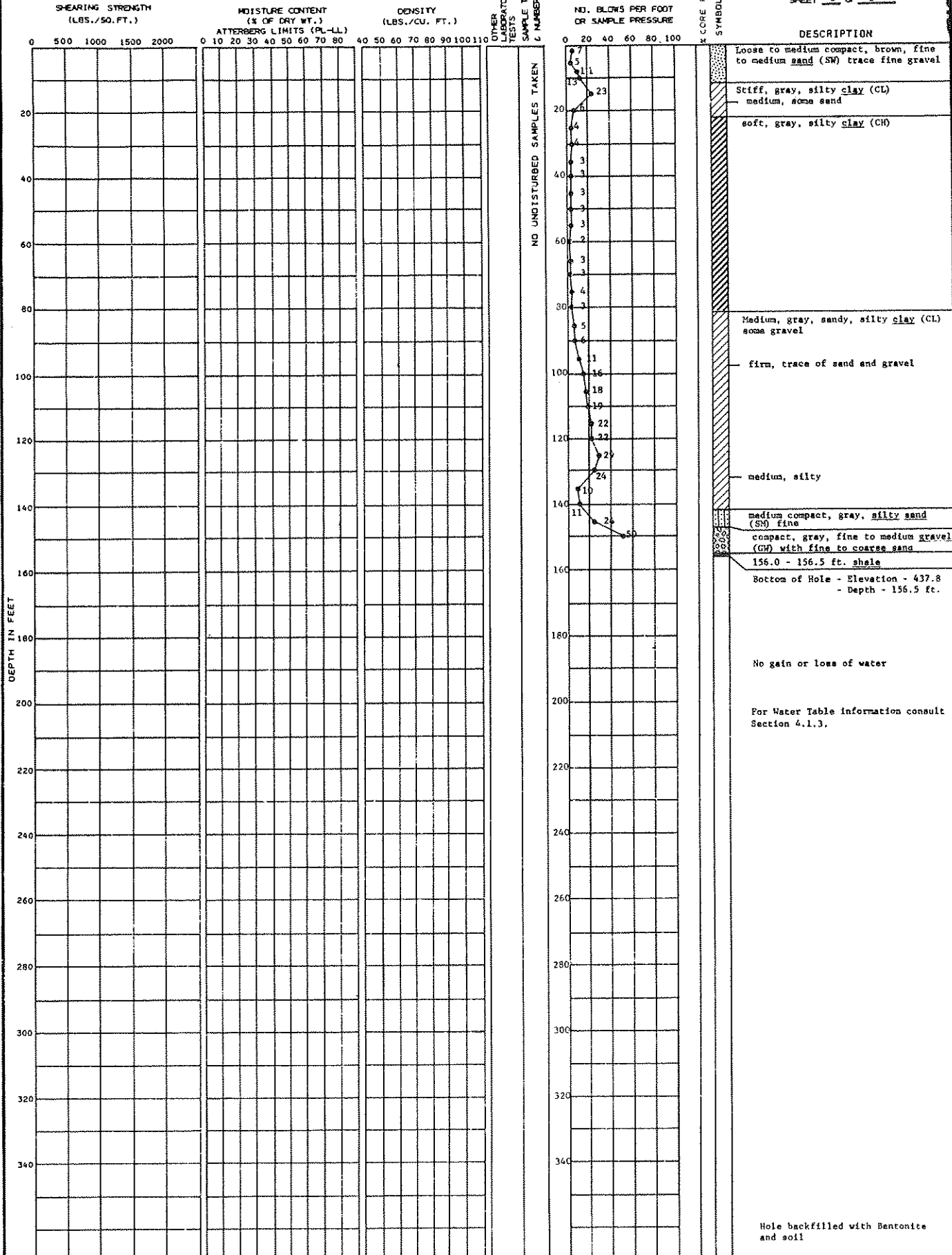

LOCATION: N 3,525
E 12,533

GROUND ELEVATION 590.8

DATE DRILLED: 3-5-74
3-7-74

SHEET 1 OF 1

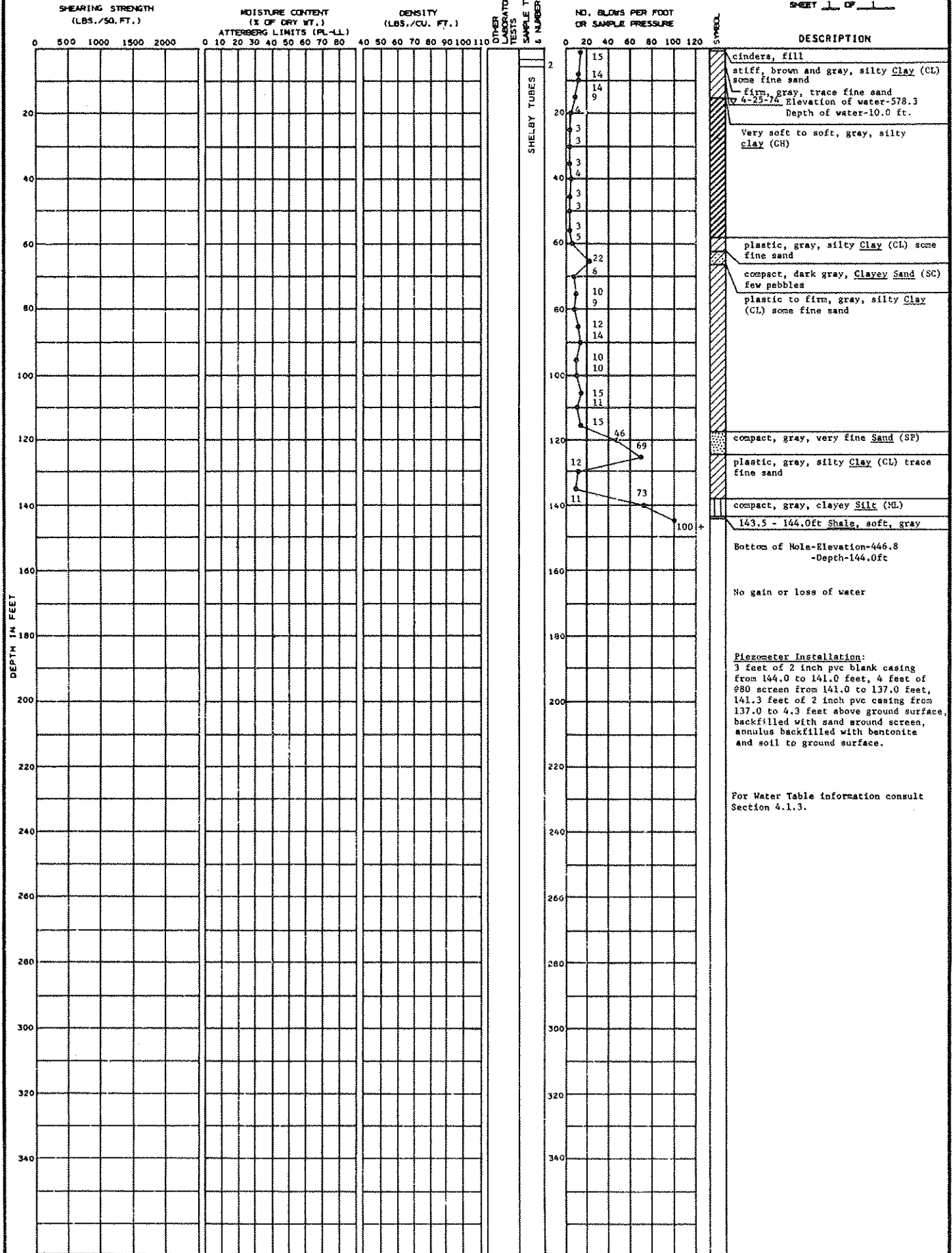

SOIL BORING NO. 181

BECHTEL Belle River

B-125

LOCATION: N 3,556 E 9,564 GROUND ELEVATION 586.1

DATE DRILLED: 3-15-74 3-19-74

SHEET 1 OF 1

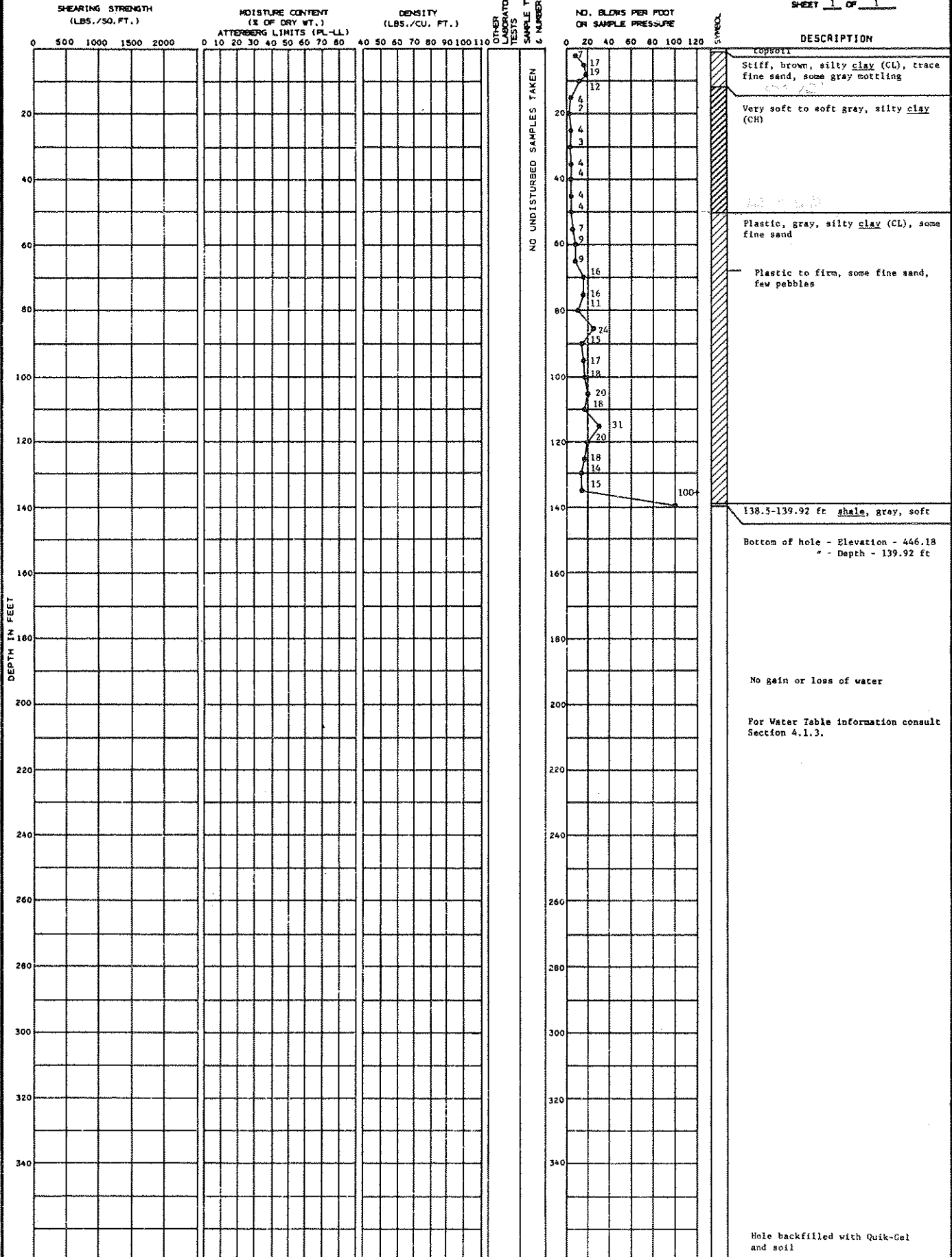

SOIL BORING NO. 184

BECHTEL Belle River

LOCATION: N 5,500
E 9,797 GROUND ELEVATION: 586.8

DATE DRILLED: 2-26-74
2-27-74

SHEET 1 OF 1

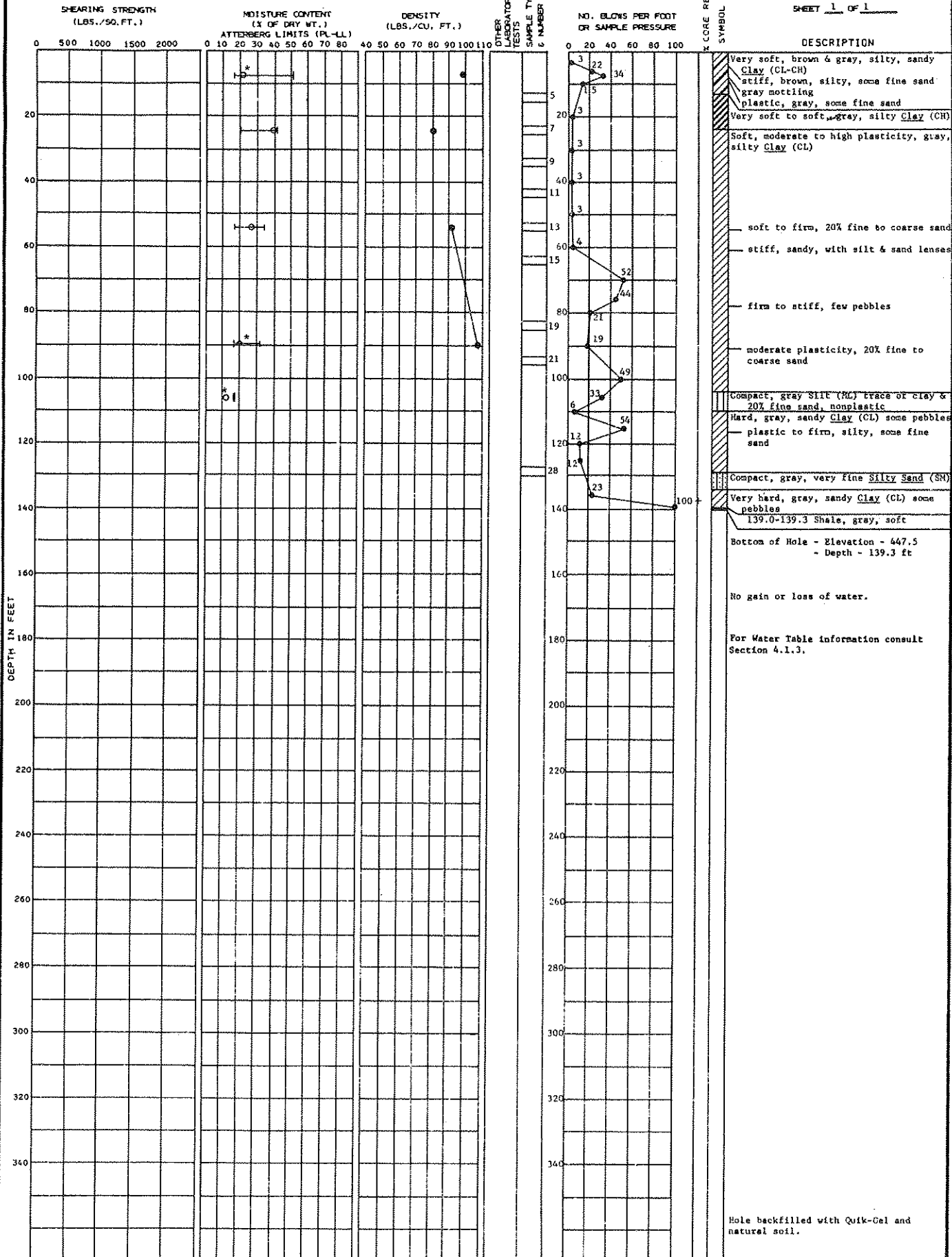

DESCRIPTION

Very soft, brown & gray, silty, sandy Clay (CL-CH)
stiff, brown, silty, some fine sand
gray mottling
plastic, gray, some fine sand
Very soft to soft, gray, silty Clay (CH)
Soft, moderate to high plasticity, gray, silty Clay (CL)
soft to firm, 20% fine to coarse sand
stiff, sandy, with silt & sand lenses
firm to stiff, few pebbles
moderate plasticity, 20% fine to coarse sand
Compact, gray Silt (ML) trace of clay & 20% fine sand, nonplastic
Hard, gray, sandy Clay (CL) some pebbles
plastic to firm, silty, some fine sand
Compact, gray, very fine Silty Sand (SM)
Very hard, gray, sandy Clay (CL) some pebbles
139.0-139.3 Shale, gray, soft

Bottom of Hole - Elevation - 447.5
- Depth - 139.3 ft

No gain or loss of water.

For Water Table information consult Section 4.1.3.

Hole backfilled with Quik-Gel and natural soil.

○ Moisture Content
— Atterberg Limits
* Water content taken from unsealed jar sample.

SOIL BORING NO. 186
BECHTEL Belle River

LOCATION: N 3500 E 11741 GROUND ELEVATION: 585.2

DATE DRILLED: 8/6/75 8/8/75

SHEET 1 OF 1

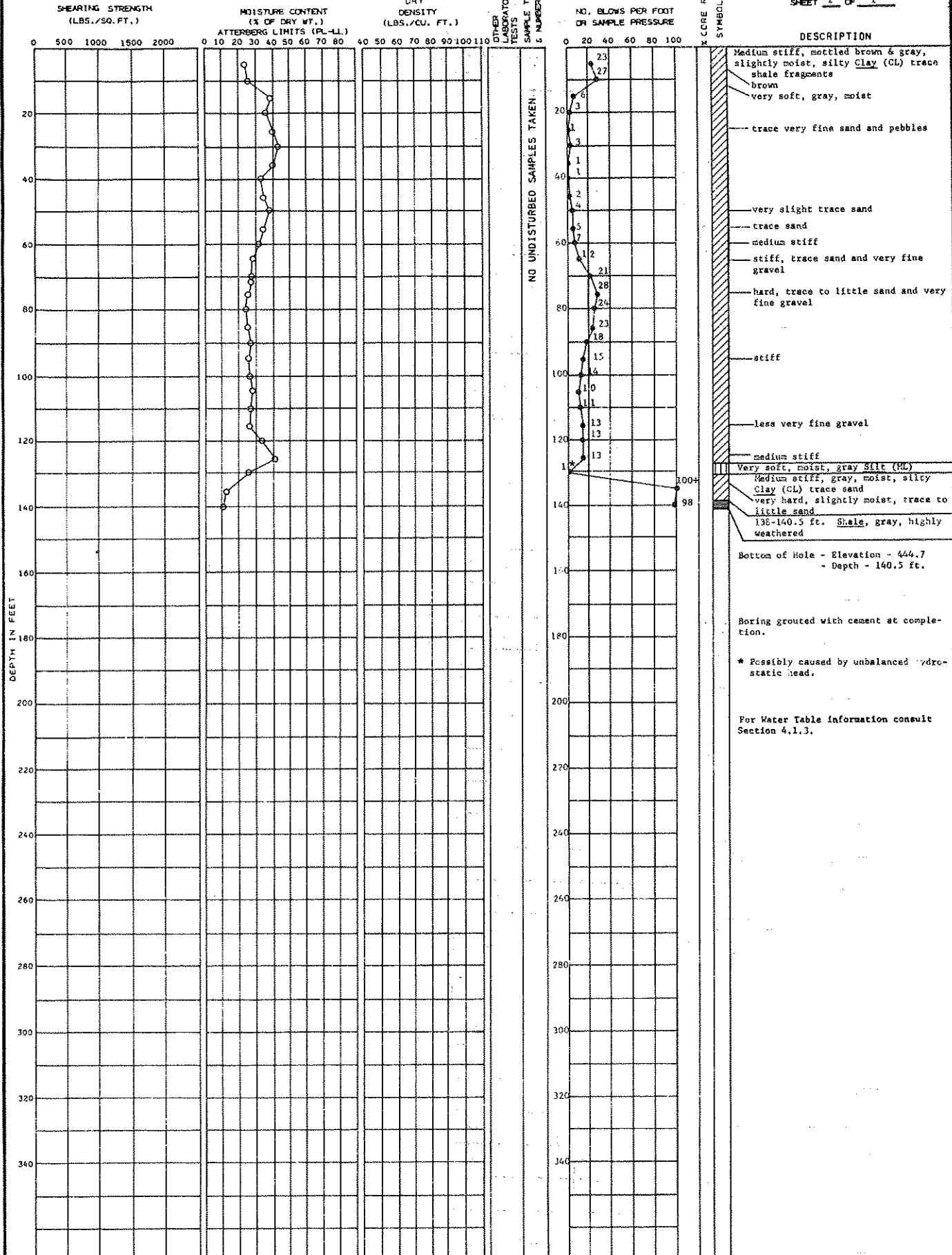

SOIL BORING NO. 191
BECHTEL BELLE RIVER

H 3558 GROUND ELEVATION 385.2
 LOCATION: E 11701

DATE DRILLED: 8/11/75
 8/14/75

SHEET 1 OF 1

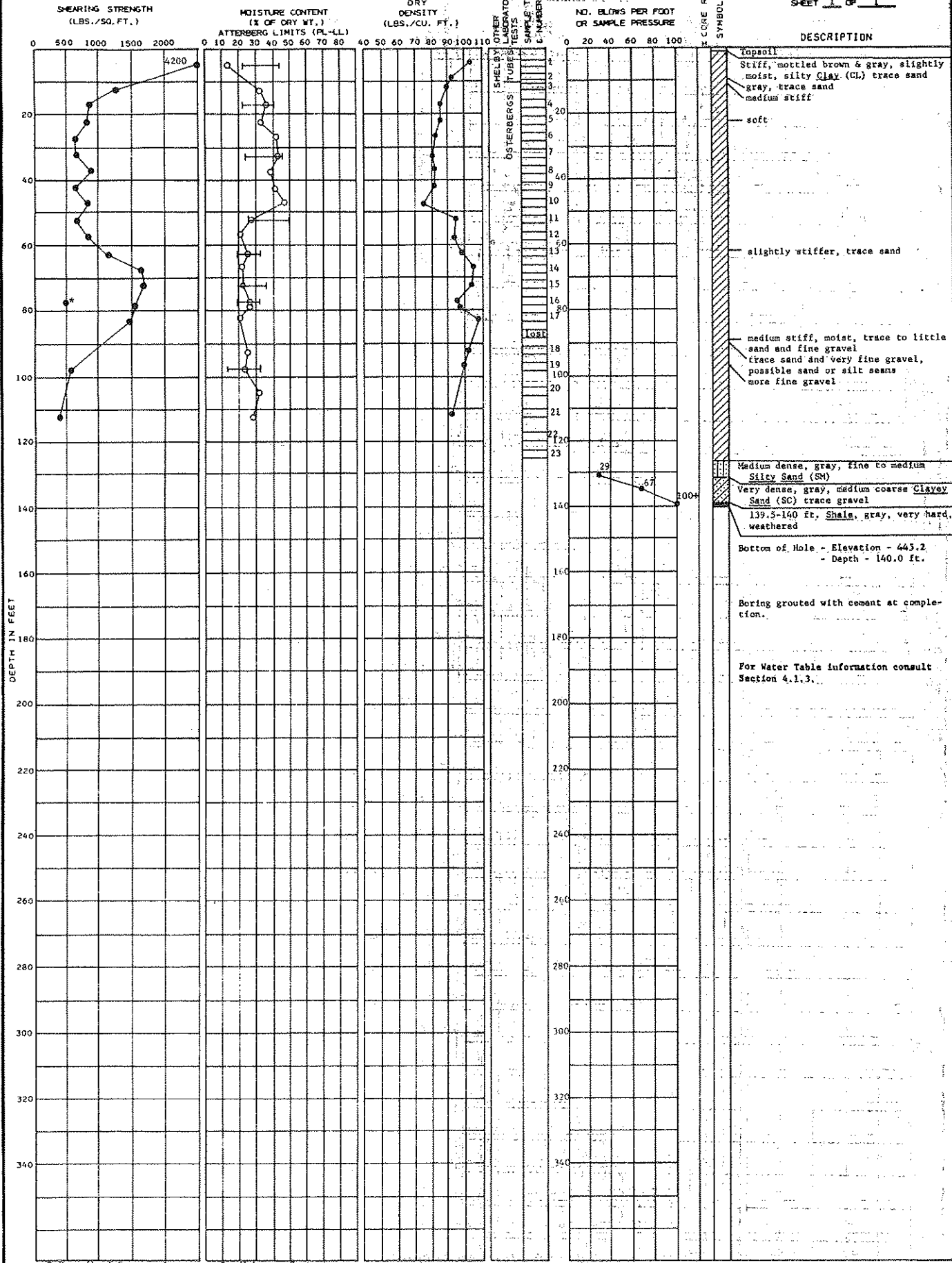

● Unconfined Compression
 * Sample contained sand seams.
 ○ Moisture Content
 — Atterberg Limits

SOIL BORING NO. 193
 BECHTEL BELLE RIVER

LOCATION: N 7800 E 9400 GROUND ELEVATION 585.1

DATE DRILLED: 8/17/77 8/22/77

SHEET 1 OF 1

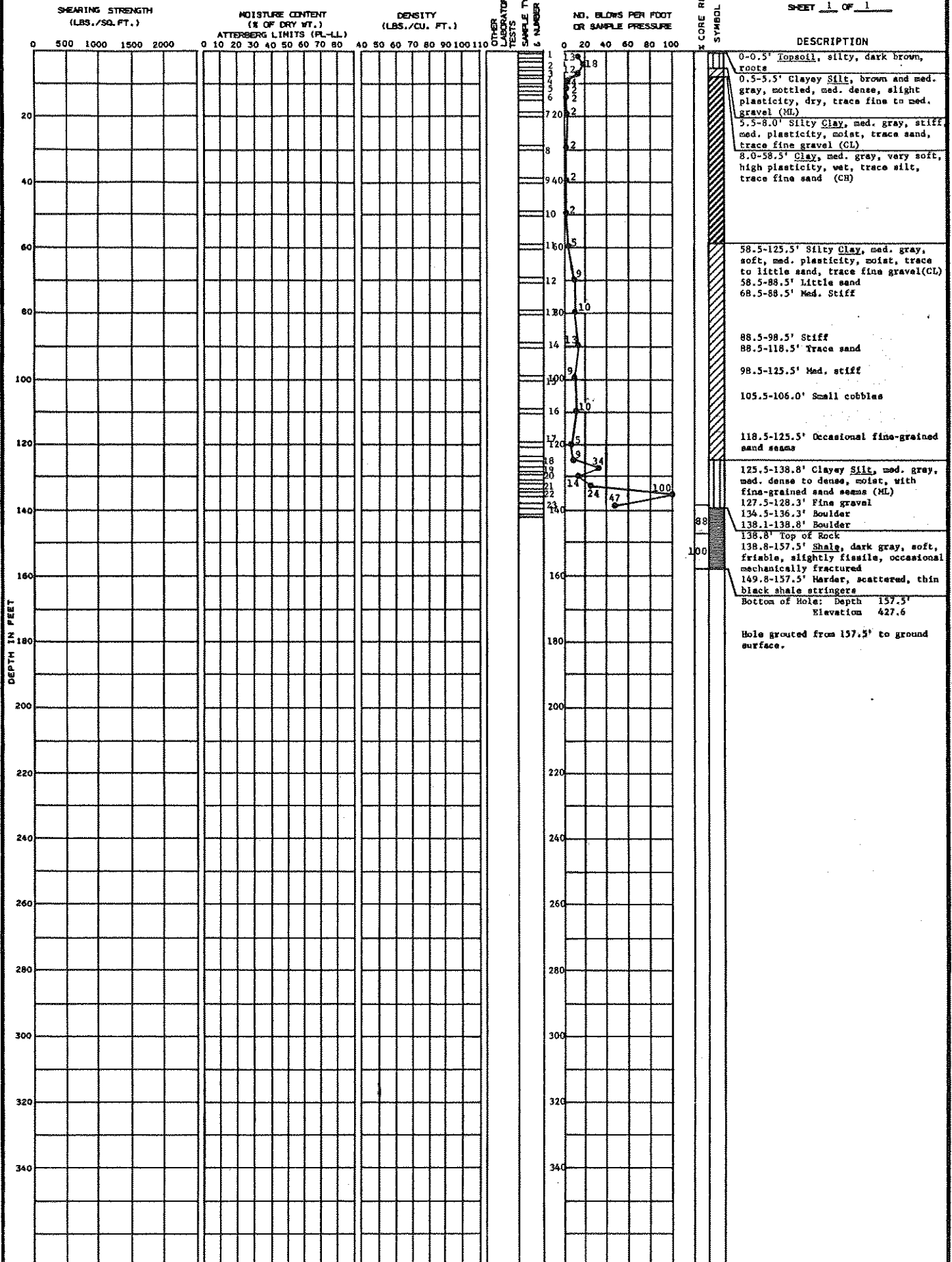

LOCATION: N 7500 E 9200 GROUND ELEVATION 585.0

DATE DRILLED: 8/23/77 8/25/77

SHEET 1 OF 1

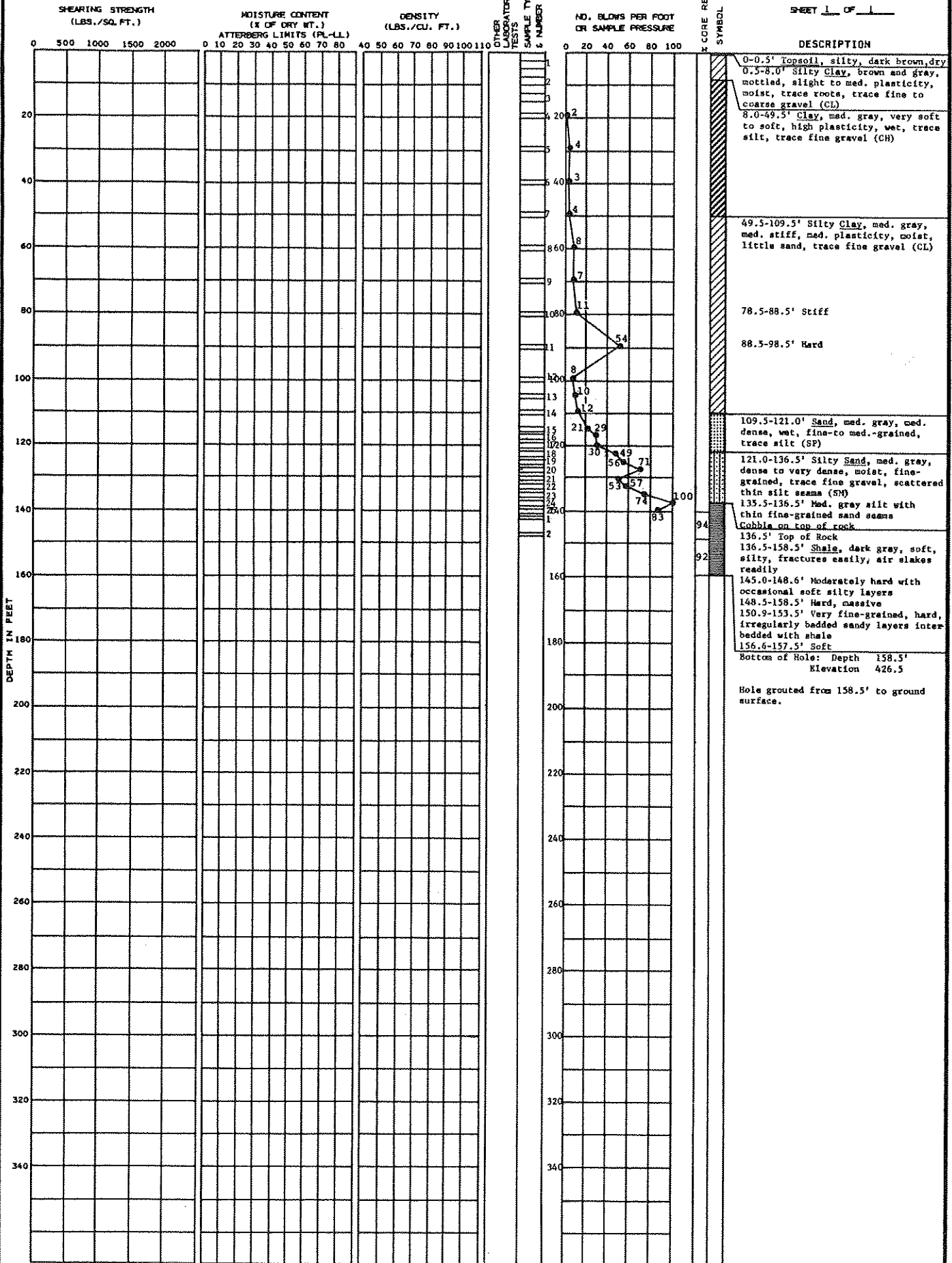

LOCATION: N 7850 E 9200 GROUND ELEVATION 585.5

DATE DRILLED: 8/2/77
8/4/77

SHEET 1 OF 1

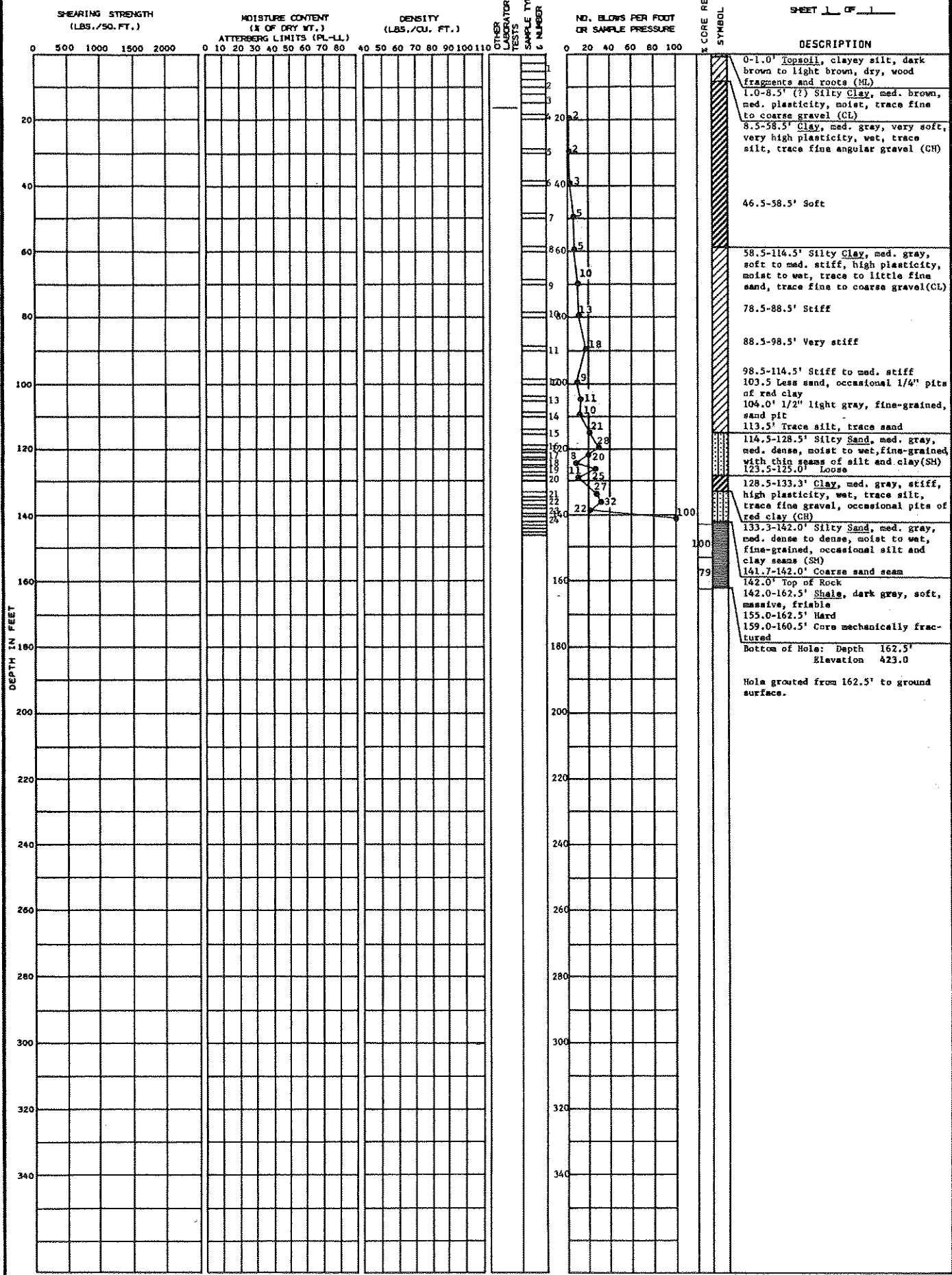

LOCATION: N 7600 E 9400 GROUND ELEVATION 584.8

DATE DRILLED: 7/26/77 8/1/77 SHEET 1 OF 1

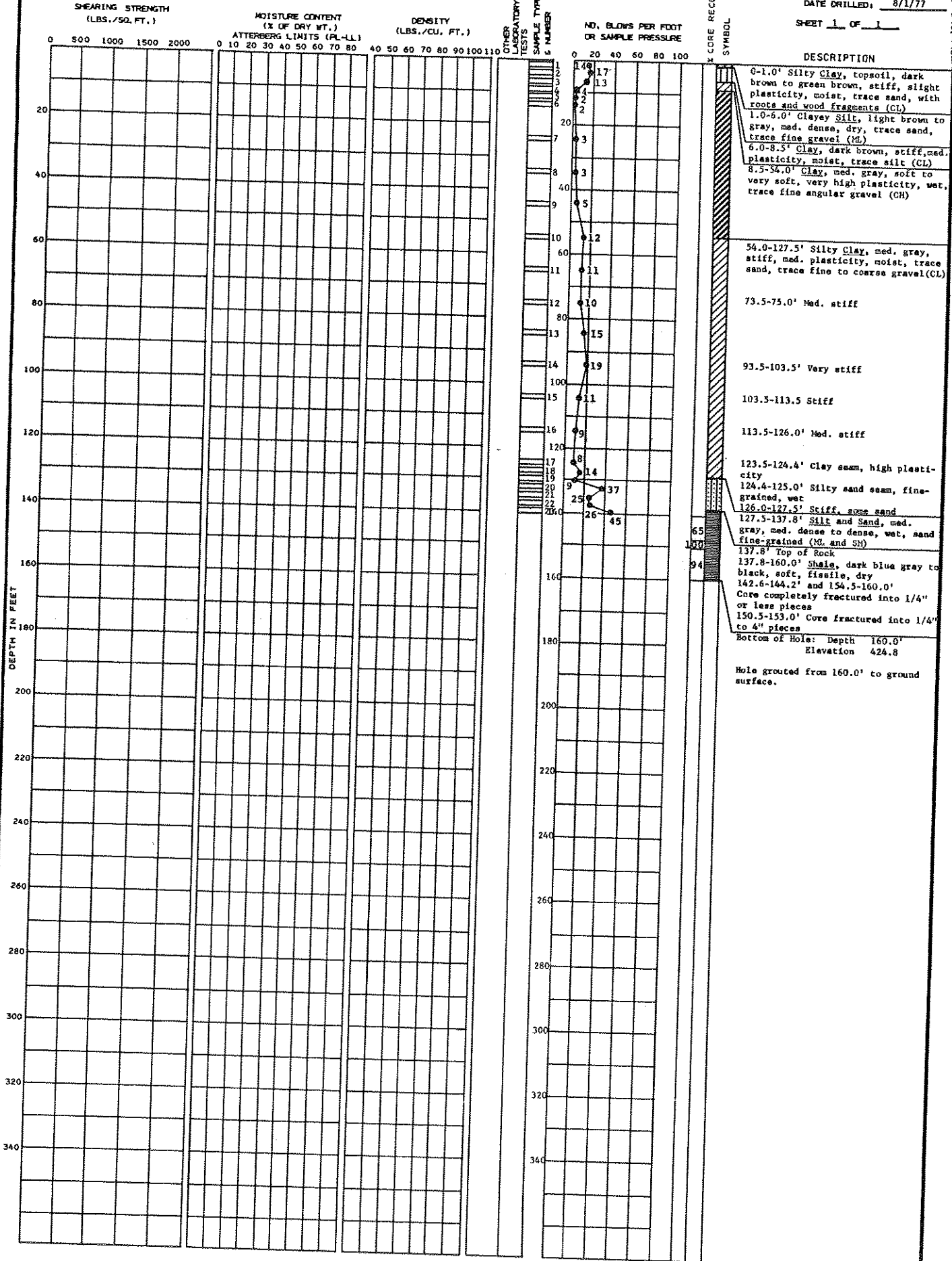

SOIL BORING NO. B-5 BECHTEL Belle River

LOCATION: N 7650 E 9550 GROUND ELEVATION 585.7

DATE DRILLED: 8/25/77 8/31/77

SHEET 1 OF 1

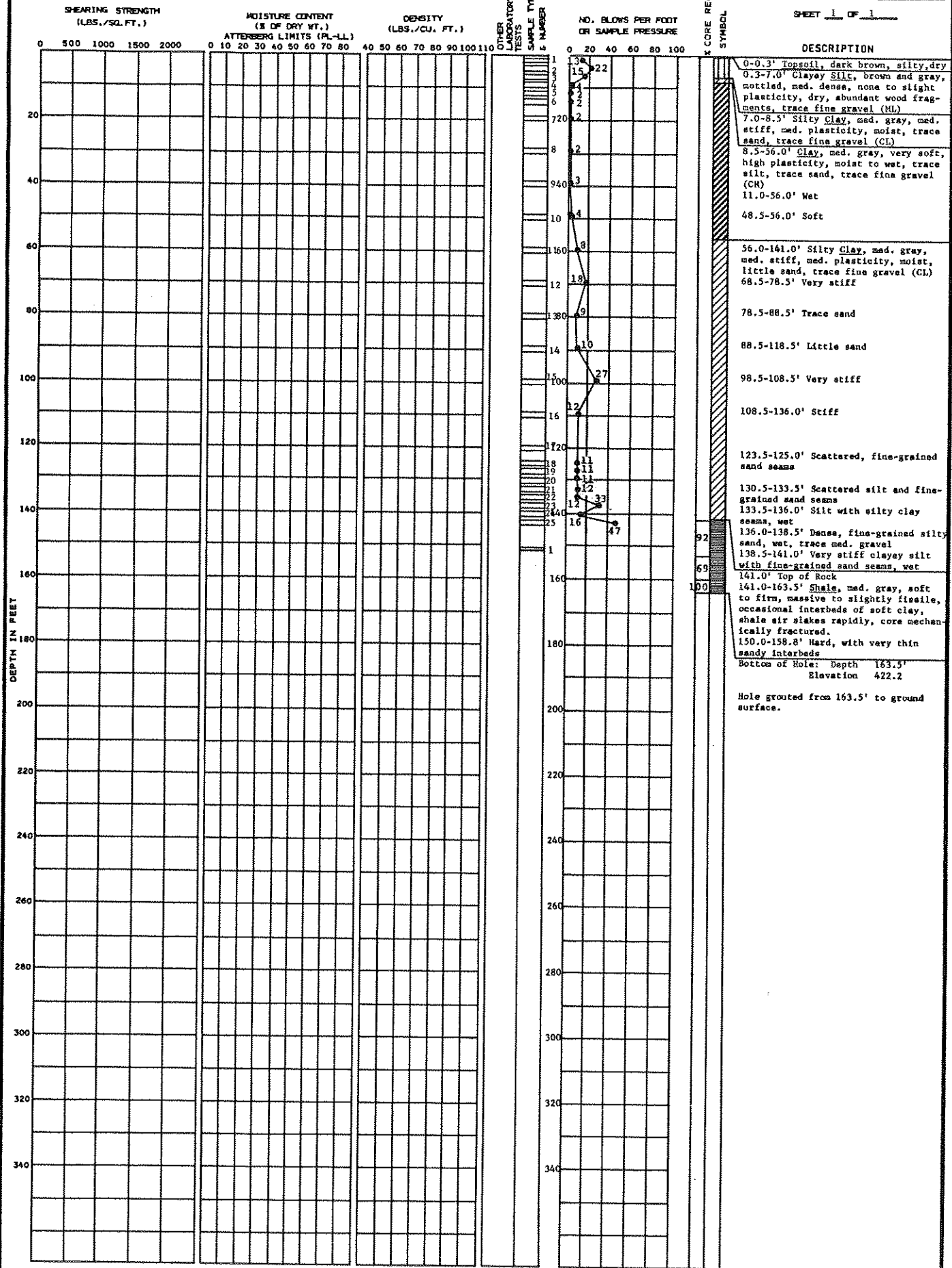

SOIL BORING NO. 8-6
BECHTEL Belle River

LOCATION: N 8180 E 9550 GROUND ELEVATION 585.3

DATE DRILLED: 8/12/77 8/17/77

SHEARING STRENGTH (LBS./SQ. FT.)

MOISTURE CONTENT (% OF DRY WT.) ATTERBERG LIMITS (PL-LL)

DENSITY (LBS./CU. FT.)

LABORATORY TESTS SAMPLE TYPE NUMBER

NO. BLOWS PER FOOT OR SAMPLE PRESSURE

CORE RECOVERY SYMBOL

SHEET 1 OF 1

DESCRIPTION

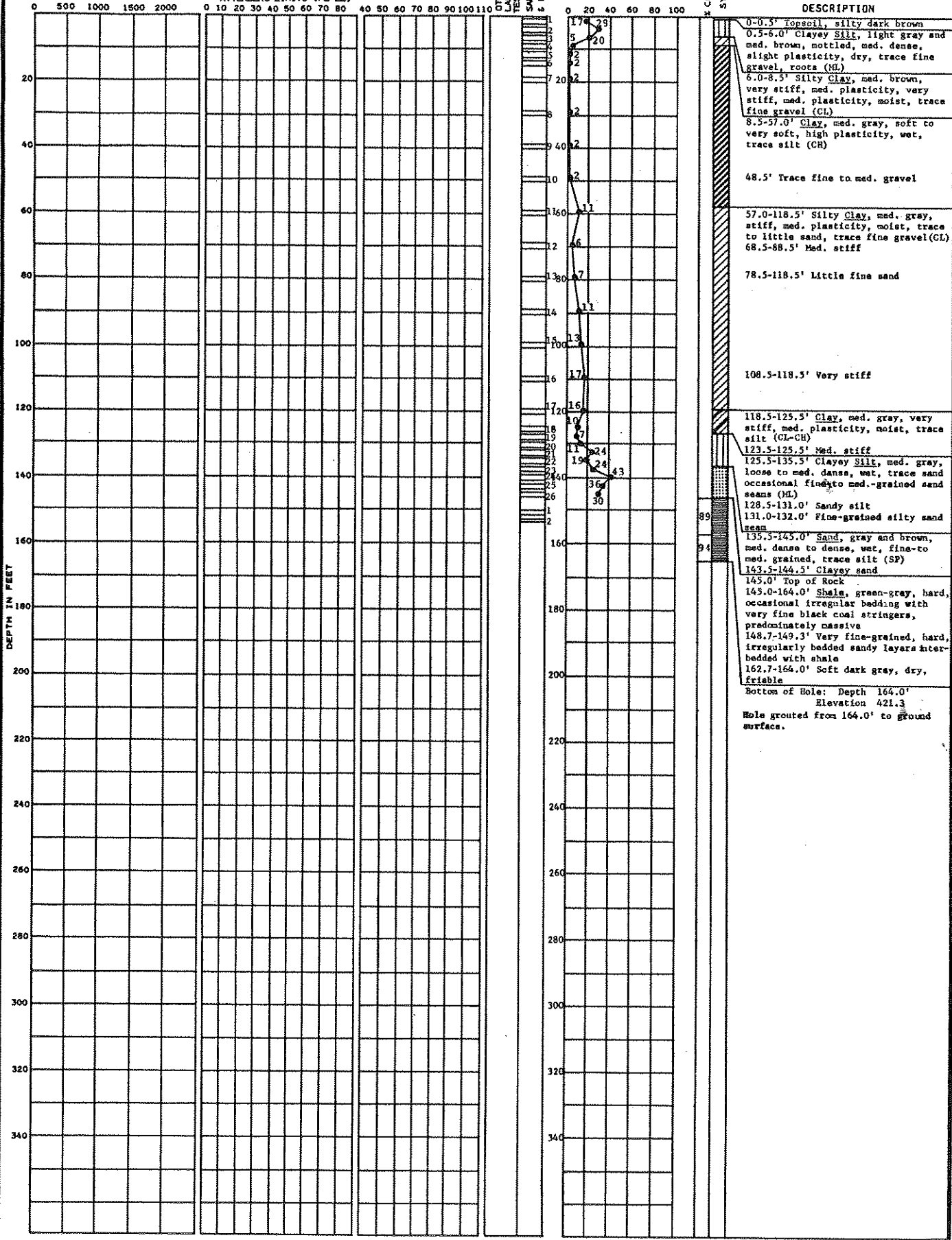

LOCATION: N 5270 E 15660 GROUND ELEVATION 580.0

DATE DRILLED: 9/7/77 9/14/77 SHEET 1 OF 1

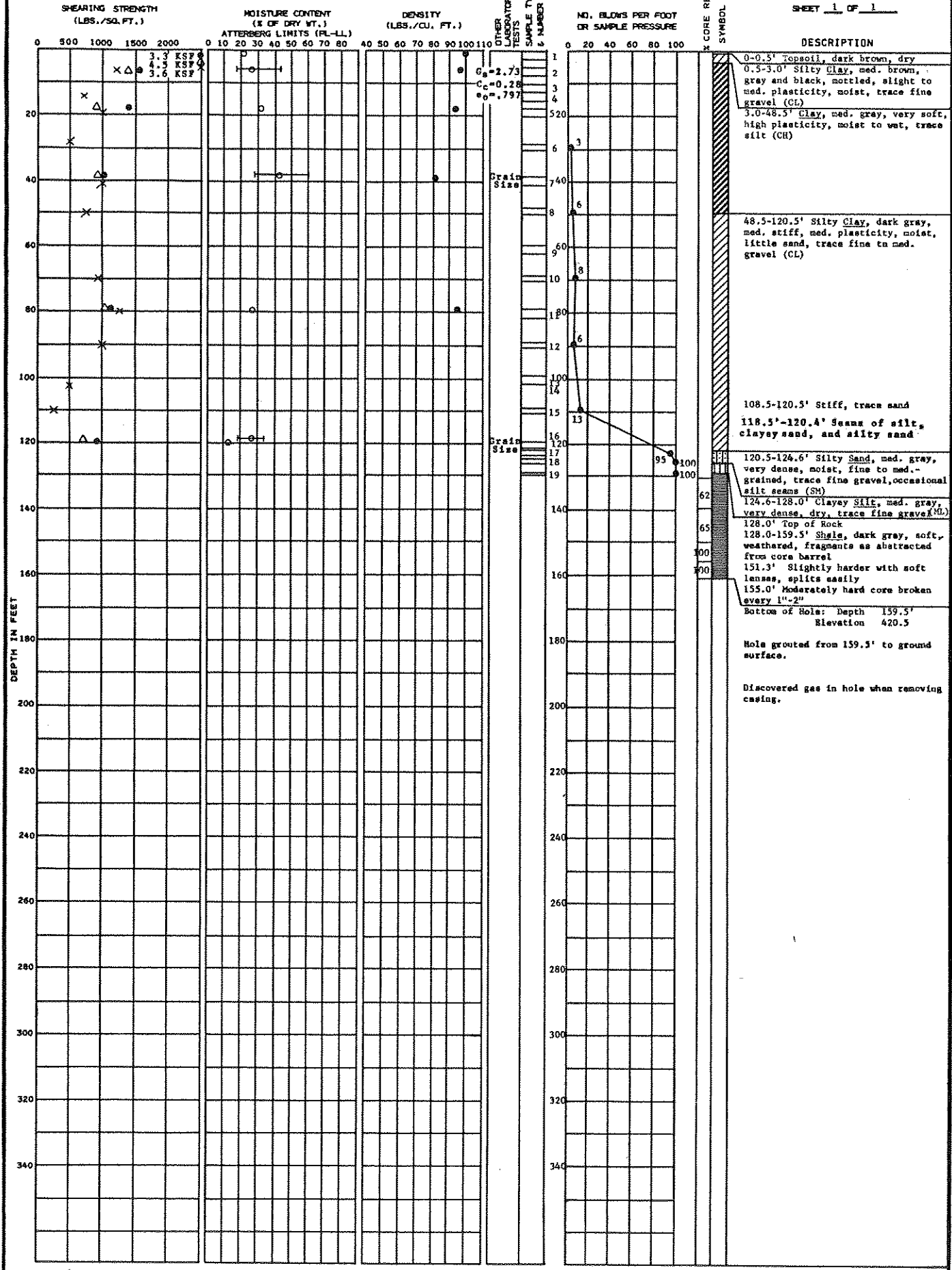

Δ Torvane G_s Specific Gravity
 ○ Unconsolidated Undrained C_c Compression Index
 ⊙ Unconfined Compression e₀ Initial Void Ratio
 — Atterberg Limits × Pocket Penetrometer

SOIL BORING NO. B-17
BECHTEL Belle River

LOCATION: N 5163
E 15744

GROUND ELEVATION 577.5 (Top of Water)

DATE DRILLED: 9/21/77
9/27/77

SHEET 1 OF 1

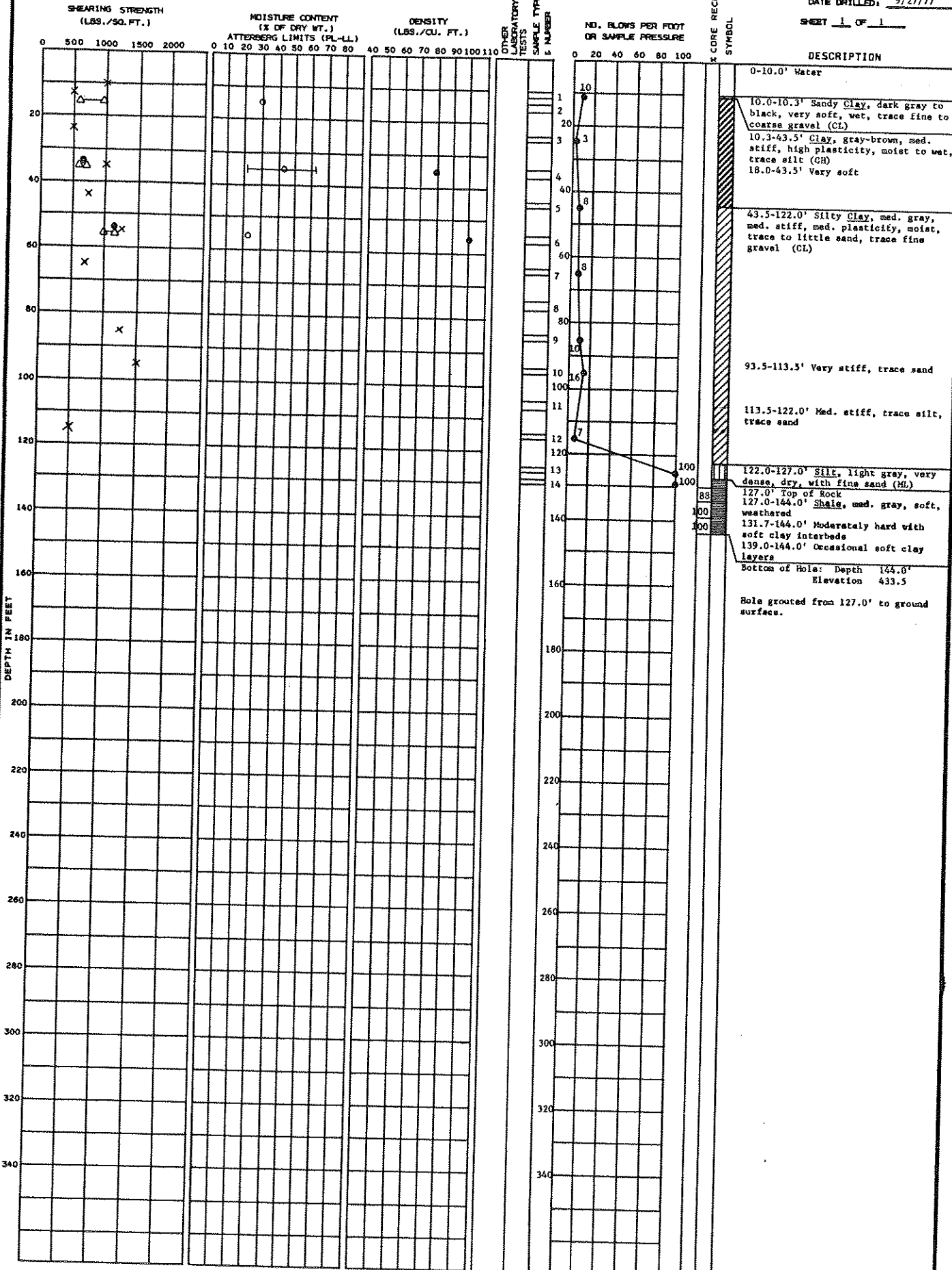

Δ Torvane
 I Atterberg Limits
 ● Unconfined Compression
 ○ Unconsolidated Undrained

X Pocket Penetrometer

SOIL BORING NO. B-22

BECHTEL Belle River

LOCATION: N 5364
E 15750

GROUND ELEVATION 577.5 (Top of Water)

DATE DRILLED: 9/15/77
9/21/77

SHEET 1 OF 1

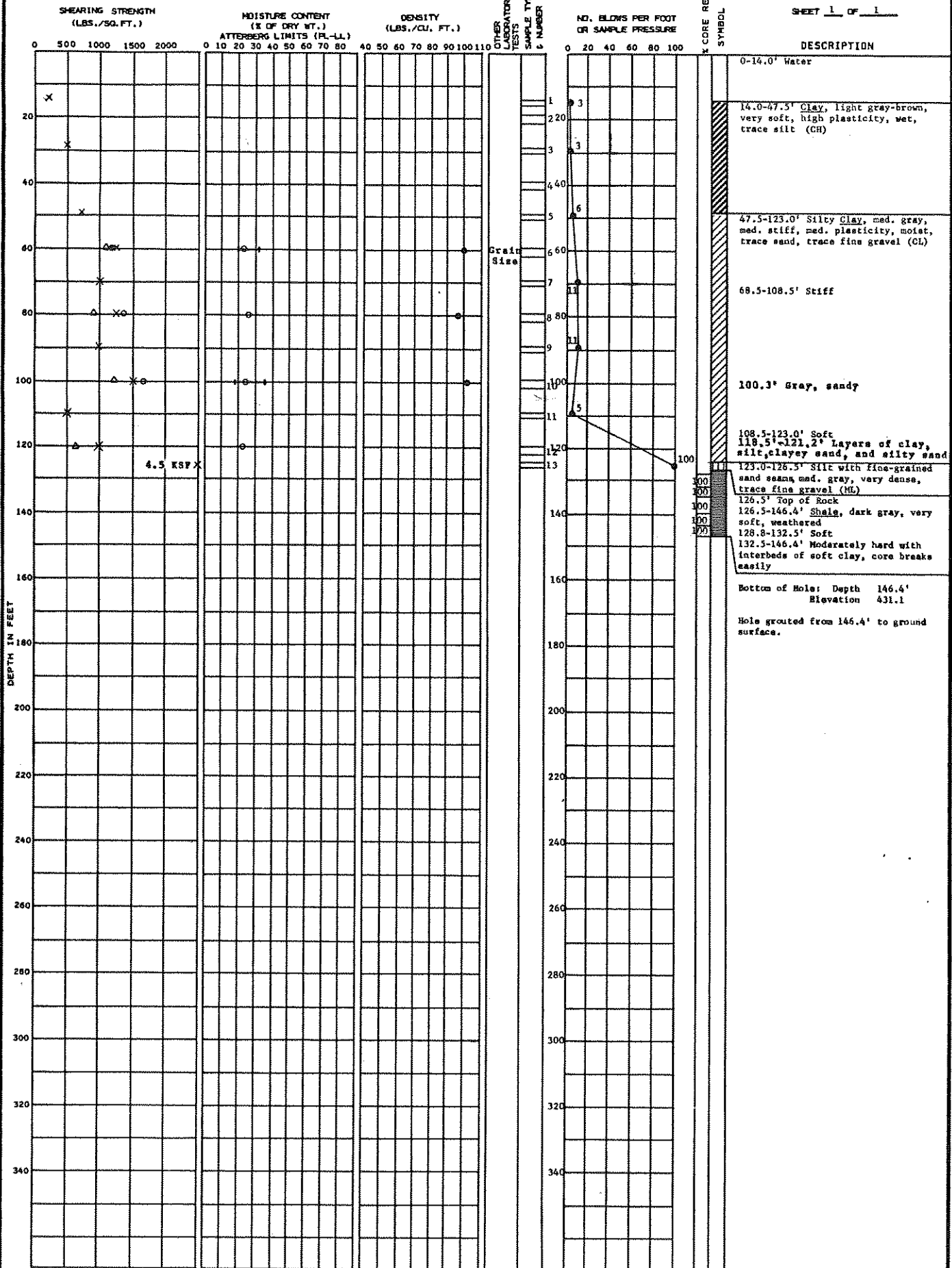

△ Ternary
 ○ Unconsolidated Undrained
 ● Unconfined Compression
 — Atterberg Limits
 × Pocket Penetrometer

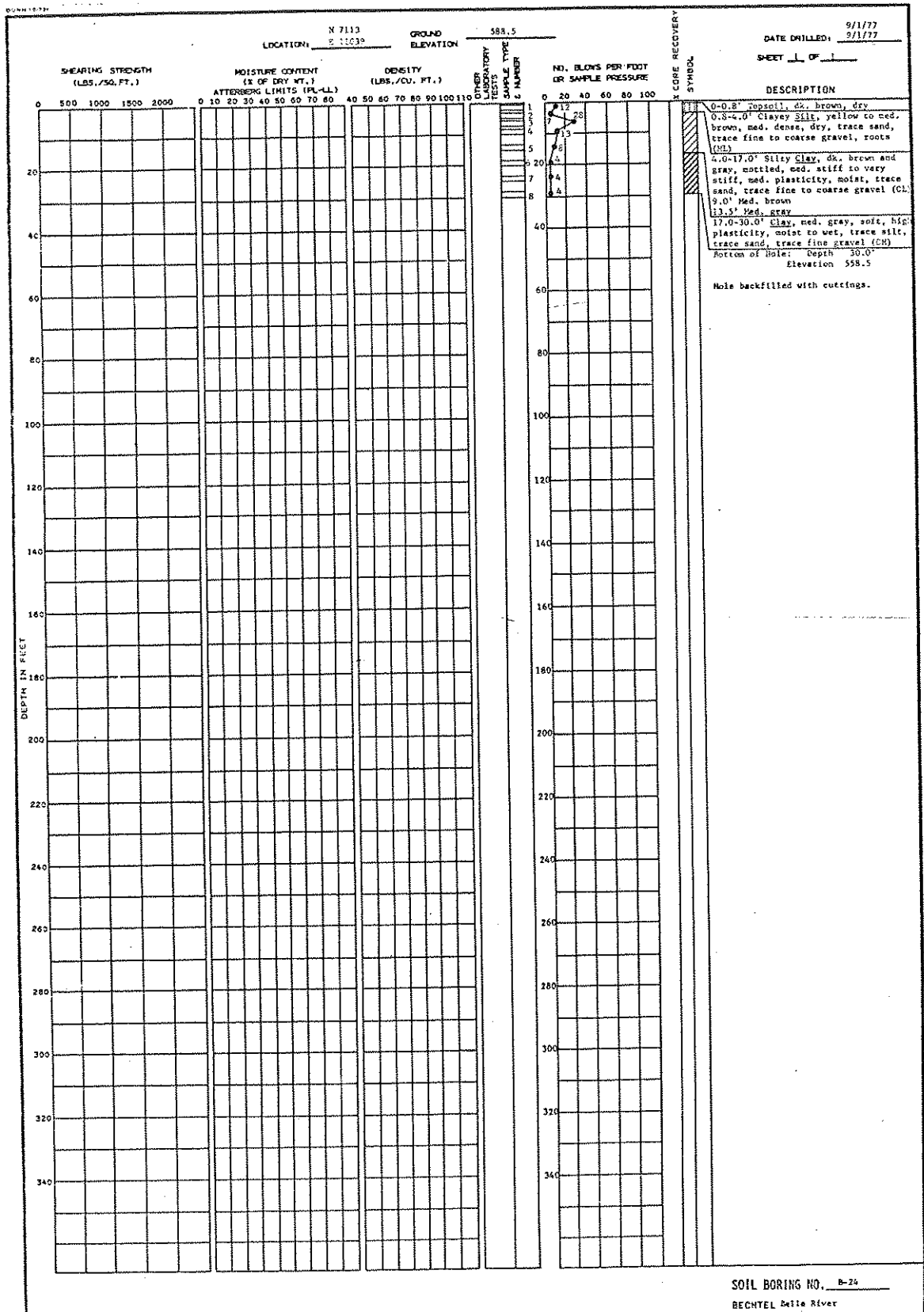

LOCATION: H 6921 Z 11501 GROUND ELEVATION: 587.5

DATE DRILLED: 9/1/77

SHEET 1 OF 1

DEPTH IN FEET	SHEARING STRENGTH (LBS./SQ. FT.)	MOISTURE CONTENT (% OF DRY WT.) ATTERBERG LIMITS (PL-LL)	DENSITY (LBS./CU. FT.)	OTHER LABORATORY TESTS	NO. BLOWS PER FOOT OR SAMPLE PRESSURE	CORE RECOVERY BY/WHEN	DESCRIPTION
0							0-0.7' Topsoil, dk. brown, dry
0.7					26		0.7-4.5' Silty Sand, tan and yellow, mottled, loose, damp, fine-grained (SM)
4.5							4.5-9.0' Silty Clay, brown and gray, mottled, stiff to very stiff, med. plasticity, moist, trace sand, trace fine to coarse gravel (CI)
9.0							9.0-30.0' Clay, med. gray, very soft, high plasticity, moist to wet, trace sand, trace fine gravel, trace silt (CH)
30.0							Bottom of Hole: Depth 30.0' Elevation 557.5
							Hole backfilled with cuttings.

LOCATION: N 6730 E 11963 GROUND ELEVATION 588.1

DATE DRILLED: 9/1/77 SHEET 1 OF 1

DEPTH IN FEET	SHEARING STRENGTH (LBS./SQ. FT.)	MOISTURE CONTENT (% OF DRY WT.) ATTERBERG LIMITS (PL-LL)	DENSITY (LBS./CU. FT.)	OTHER LABORATORY TESTS	NO. BLOWS PER FOOT OR SAMPLE PRESSURE	CORE RECOVERY SYMBOL	DESCRIPTION
0							0-0.7' Topsoil, dr. brown, dry
0.7					11		0.7-4.0' Silty Sand, tan and gold, mottled, med. dense, dry, fine-grained, roots (SM)
4.0					21		4.0-13.5' Silty Clay, gray and brown, mottled, med. stiff to very stiff, med. plasticity, moist, trace sand, trace fine gravel (CL)
13.5					3		6.0' Green brown
19.5					3		13.5-30.0' Clay, med. gray, soft, high plasticity, moist to wet, trace silt, trace fine gravel (CH)
30.0					3		Bottom of Hole: Depth 30.0' Elevation 558.1
340							Hole backfilled with cuttings.

LOCATION: N 6539 E 12425 GROUND ELEVATION 588.2

DATE DRILLED: 9/2/77

SHEET 1 OF 1

DEPTH IN FEET	SHEARING STRENGTH (LBS./SQ. FT.)	MOISTURE CONTENT (% OF DRY WT.) ATTERBERG LIMITS (PL-LL)	DENSITY (LBS./CU. FT.)	NO. BLOWS PER FOOT OR SAMPLE PRESSURE	CORE RECOVERY	SYMBOL	DESCRIPTION
0							0-1.0' Topsoil, dk. brown, silty, fine to med. gravel, dry (GO)
1				16			1.0-5.0' Clayey Silt, dk. brown, med. dense to dense, dry, trace sand, trace fine gravel (ML)
2				37			
3				21			
4							
5				14			5.0-30.0' Silty Clay, dk. brown, hard to very stiff, dry, med. plasticity, trace sand, trace fine to med. gravel (CL)
6				22			
7				12			13.5' Moist, dipping parting in sample med. brown with med. gray filling, with roots
8				7			19.0-28.3' Med. gray, stiff
20							23.5' green-brown and gray, mottled
40							28.5-30.0' Med. gray, med. stiff
60							Bottom of Hole: Depth 30.0'
80							Elevation 558.2
100							
120							
140							
160							
180							
200							
220							
240							
260							
280							
300							
320							
340							

LOCATION: N 6348 E 12890 GROUND ELEVATION 600.0

DATE DRILLED: 9/1/77

SHEET 1 OF 1

DEPTH IN FEET	SHEARING STRENGTH (LBS./SQ. FT.)	MOISTURE CONTENT (% OF DRY WT.) ATTERBERG LIMITS (PL-LL)	DENSITY (LBS./CU. FT.)	OTHER LABORATORY TESTS	NO. BLOWS PER FOOT OR SAMPLE PRESSURE	CORE RECOVERY SYMBOL	DESCRIPTION
0							0-1.0' Topsoil, dk. brown, silty, dry, sandy fill with coarse gravel
1							
2							
3							
4							1.0-6.0' Clayey Silt, green brown, med. dense, dry, trace sand (ML)
5							
6							6.0-30.0' Silty Clay, green brown, very stiff, slight plasticity, moist, trace sand, trace fine gravel (CL)
7							13.5' Med. gray, stiff to med. stiff, med. plasticity
8							28.5-30.0' Med. to high plasticity
40							Bottom of Hole: Depth 30.0' Elevation 570.0'
60							Hole backfilled with cuttings.
80							
100							
120							
140							
160							
180							
200							
220							
240							
260							
280							
300							
320							
340							

BURN 12-34

LOCATION: N 6156
E 13309 GROUND ELEVATION 528.8

DATE DRILLED: 9/2/77
9/2/77

DEPTH IN FEET	SHEARING STRENGTH (LBS./SQ. FT.)	MOISTURE CONTENT (% OF DRY WT.) ATTENDING LIMITS (PL-LL)	DENSITY (LBS./CU. FT.)	OTHER LABORATORY TESTS	NO. BLINDS PER FOOT OR SAMPLE PRESSURE	CORE RECOVERY SYMBOL	DESCRIPTION
0							0-0.3' Topsoil, dk. brown, dry
1							0.3-3.5' Clayey Silt, light brown and gray, mottled, med. dense, none to slight plasticity, dry, trace sand, trace fine to coarse gravel (G)
2							3.5-23.5' Silty Clay, med. brown and gray, lightly mottled, very stiff to hard, med. plasticity, moist, trace sand, trace fine gravel (CL)
3							23.5-30.0' Med. Gray, med. stiff to very soft, high plasticity, moist, trace silt (CH)
30.0'							Bottom of Hole: Depth 30.0' Elevation 568.8
30.0'							Note backfilled with cuttings.
40							
60							
80							
100							
120							
140							
160							
180							
200							
220							
240							
260							
280							
300							
320							
340							

SOIL BORING NO. B-34
BECTEL Belle River

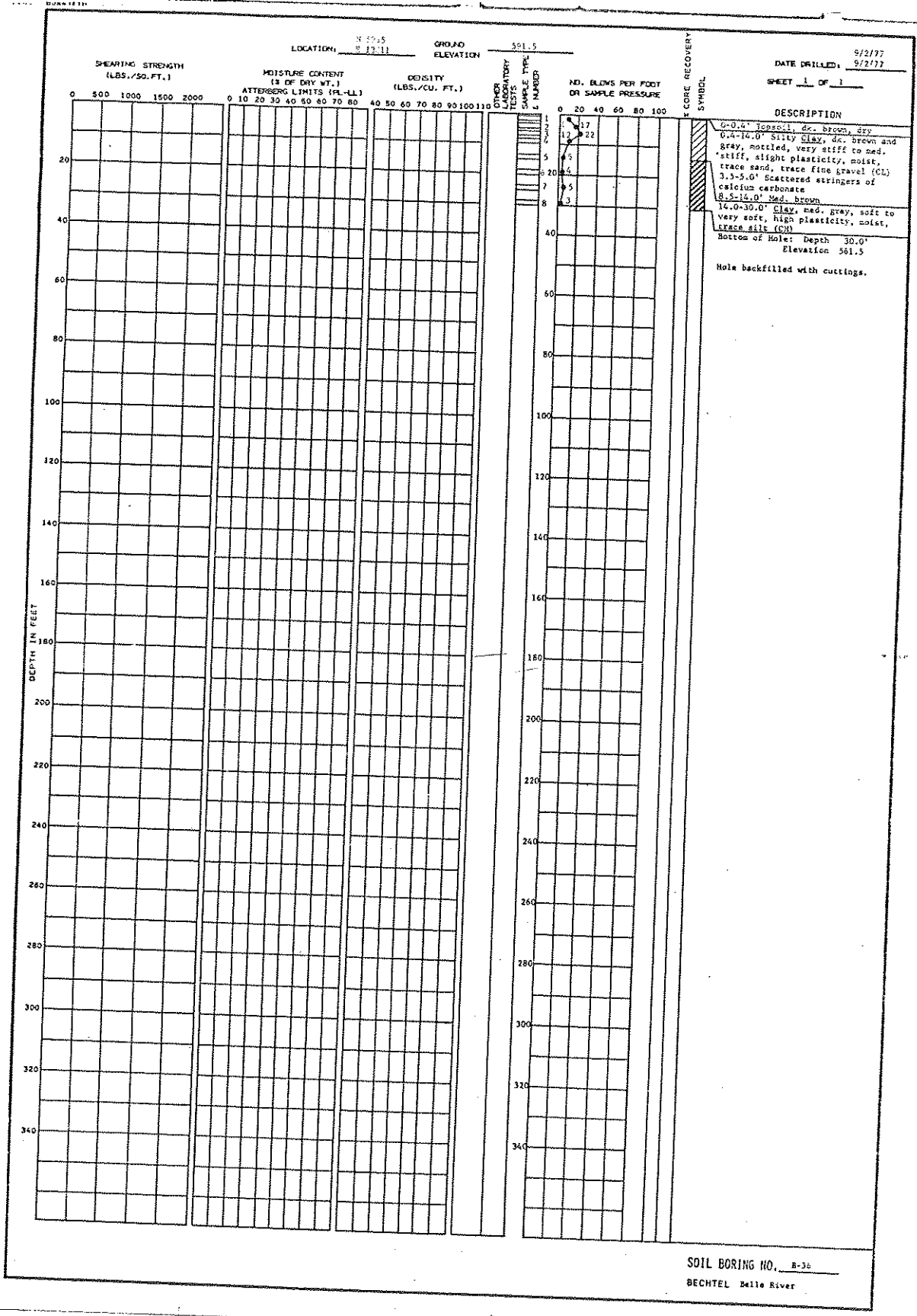

SOIL BORING NO. B-3b
BECHTEL Belle River

BUNN 11-12

LOCATION: J 5774 E 14272 GROUND ELEVATION 591.2

DATE DRILLED: 9/6/77 SHEET 1 OF 1

DEPTH IN FEET	SHEARING STRENGTH (LBS./SQ. FT.)				MOISTURE CONTENT (% OF DRY WT.)				DENSITY (LBS./CU. FT.)				LABORATORY TESTS & NUMBER	NO. BLOWS PER FOOT OR SAMPLE PRESSURE	CORE RECOVERY SYMBOL	DESCRIPTION									
	0	500	1000	1500	2000	0	10	20	30	40	50	60					70	80	40	80	60	70	80	90	100
0																									0-0.3' Topsoil, dk. brown, moist
0.5																									0.5-13.5' Silty clay, med. brown and gray, mottled, med. stiff, med. plasticity, trace sand, trace fine gravel (GL)
6.0																									6.0-8.5' Med. brown, very stiff
8.5																									8.5-13.5' Med. brown, stiff
13.5																									13.5-30.0' Clay, med. gray, med. stiff, high plasticity, moist, trace silt (CH)
23.5																									23.5-28.5' Very soft, moist to wet
28.5																									28.5-30.0' Soft
30.0																									Bottom of Hole: Depth 30.0' Elevation 561.2
																									Hole backfilled with cuttings.

SOIL BORING NO. B-39 BECHTEL Belle River

LOCATION: N 5532 GROUND ELEVATION: 590.2
 S 14735

DATE DRILLED: 9/6/77
 9/6/77

SHEET 1 OF 1

SHEARING STRENGTH (LBS./SQ. FT.)	MOISTURE CONTENT (% OF DRY WT.) ATTERBERG LIMITS (PL-LL)	DENSITY (LBS./CU. FT.)	NO. BLOWS PER FOOT ON SAMPLE PRESSURE	LABORATORY TESTS SAMPLE TYPE & NUMBER	DESCRIPTION
					0-0.4' Topsoil, dk. brown, dry
			21		0.4-13.5' Silty Clay, med. brown, med. stiff to very stiff, med. plasticity, moist, trace sand, trace fine gravel (CL)
			3		13.5-30.0' Clay, med. gray, soft to very soft, high plasticity, moist to wet, trace silt (CH)
					Bottom of Hole: Depth 30.0' Elevation 560.2
					Hole backfilled with cuttings.

SOIL BORING NO. E-50
 BECHTEL Belle River

SHEARING STRENGTH (LBS./SQ. FT.)		MOISTURE CONTENT (% OF DRY WT.)		DENSITY (LBS./CU. FT.)		NO. BLOWS PER FOOT OR SAMPLE PRESSURE	CORE RECOVERY SYMBOL	DESCRIPTION
0 500 1000 1500 2000	0 10 20 30 40 50 60 70 80	0 10 20 30 40 50 60 70 80	40 50 60 70 80 90 100 110	0 20 40 60 80 100				
								0-0.3' Topsoil, dk. brown, dry
						17		0.3-4.0' Clayey SILT, light brown, med. dense, dry, trace sand, trace fine to coarse gravel (G)
						20		4.0-18.5' Silty Clay, med. brown and gray, mottled, very stiff, med. plasticity, moist, trace sand, trace fine gravel (CL)
						23		8.2-18.5' Med. stiff
						24		18.5-30.0' Clay, med. gray, very soft, high plasticity, moist to wet, trace silt (CH)
								28.5-30.0' Soft
								Bottom of Hole: Depth 30.0' Elevation 559.9
								Hole backfilled with cuttings.

LOCATION N 5355
E 15258 GROUND ELEVATION 559.9

DATE DRILLED: 9/6/77
9/6/77

SHEET 1 OF 1

DEPTH IN FEET

SOIL BORING NO. B-42
BECHTEL Balls River

APPENDIX D – 2016 BORING LOGS



WELL CONSTRUCTION LOG

WELL NO. MW-16-01

Page 1 of 2

Facility/Project Name: DTE Electric Company Belle River Power Plant		Date Drilling Started: 2/29/16	Date Drilling Completed: 2/29/16	Project Number: 231828.0003	
Drilling Firm: Stock Drilling	Drilling Method: Sonic	Surface Elev. (ft) 588.17	TOC Elevation (ft) 591.30	Total Depth (ft bgs) 120.0	Borehole Dia. (in) 6/4
Boring Location: Approximately 188 feet off road to the S, W of bottom ash basins. N: 471155.70 E: 13625546.02		Personnel Logged By - A. Knutson Driller - A. Goldsmith		Drilling Equipment: TSi 150cc	
Civil Town/City/or Village: China Township	County: St. Clair	State: MI	Water Level Observations: While Drilling: Date/Time After Drilling: Date/Time 4/13/16 08:45		Depth (ft bgs) 14.52

SAMPLE NUMBER AND TYPE	RECOVERY (%)	BLOW COUNTS	DEPTH IN FEET	LITHOLOGIC DESCRIPTION	USCS	GRAPHIC LOG	WELL DIAGRAM	COMMENTS
1 CS	60		5	<p>SILTY CLAY WITH GRAVEL mostly clay, little to some silt, little fine to coarse gravel, few fine sand, low plasticity, dark gray (10YR 4/1), moist, medium stiff.</p> <p>CLAY mostly clay, trace fine to coarse gravel, high plasticity, brown (10YR 5/3), moist, stiff.</p> <p>Change to dark gray (10YR 4/1), very stiff at 5.0 feet.</p> <p>Change to soft at 8.0 feet.</p>	CL-ML			<p>Continuous sampling with 4-inch diameter casing from ground surface to terminus of soil boring, over-drilled with 6-inch diameter casing to install monitoring well.</p> <p>Original boring abandoned due to compromised screen. Redrilled and installed at survey location noted above within 10 feet of original location.</p>
2 CS	50		15	<p>Change to no gravel, dark gray (10YR 4/1) mottled with brown (10YR 5/3), very soft at 10.0 feet.</p>				
3 CS	100		25	<p>Change to dark gray (10YR 4/1) at 20.0 feet.</p>	CL			
4 CS	100		35					

SOIL BORING WELL CONSTRUCTION LOG 231828.0003.GPJ TRC CORP.GDT 7/14/16

Signature: *Chris Scieszka*

Firm: TRC Environmental Corporation 734.971.7080
1540 Eisenhower Place Ann Arbor, Michigan Fax 734.971.9022

Checked By: C. Scieszka



WELL CONSTRUCTION LOG

WELL NO. MW-16-01

Page 2 of 2

SAMPLE		BLOW COUNTS	DEPTH IN FEET	LITHOLOGIC DESCRIPTION	USCS	GRAPHIC LOG	WELL DIAGRAM	COMMENTS					
NUMBER AND TYPE	RECOVERY (%)												
5 CS	100		45	CLAY mostly clay, high plasticity, dark gray (10YR 4/1), moist, soft.	CL								
6 ST	100		50										
7 CS	100		55										
8 CS	80		65										
9 CS	100		75										
10 CS	100		85										
11 CS	100		95						SAND mostly fine sand, dark gray (10YR 4/1), saturated.	SP			
			100										
			100						End of boring at 100.0 feet below ground surface.				

SOIL BORING WELL CONSTRUCTION LOG 231828.0003.0000.GPJ TRC_CORP.GDT 7/14/16



WELL CONSTRUCTION LOG

WELL NO. MW-16-02

Page 1 of 2

Facility/Project Name: DTE Electric Company Belle River Power Plant		Date Drilling Started: 3/14/16	Date Drilling Completed: 3/15/16	Project Number: 231828.0003	
Drilling Firm: Stock Drilling	Drilling Method: Sonic	Surface Elev. (ft) 586.27	TOC Elevation (ft) 588.94	Total Depth (ft bgs) 100.0	Borehole Dia. (in) 6/4
Boring Location: 325 feet W of haul road, 5 feet N of road, N of bottom ash basins. N: 471409.06 E: 13625991.78		Personnel Logged By - A. Knutson Driller - A. Goldsmith		Drilling Equipment: TSi 150cc	
Civil Town/City/or Village: China Township	County: St. Clair	State: MI	Water Level Observations: While Drilling: Date/Time After Drilling: Date/Time 4/13/16 09:24		Depth (ft bgs) 16.07

SAMPLE NUMBER AND TYPE	RECOVERY (%)	BLOW COUNTS	DEPTH IN FEET	LITHOLOGIC DESCRIPTION	USCS	GRAPHIC LOG	WELL DIAGRAM	COMMENTS
1 CS	80		5	CLAY mostly clay, few silt, few coarse gravel, medium plasticity, dark gray (10YR 4/1) mottled with brown (10YR 5/3), stiff.				Continuous sampling with 4-inch diameter casing from ground surface to terminus of soil boring, over-drilled with 6-inch diameter casing to install monitoring well.
			7.0	Change to no gravel at 7.0 feet.				
2 CS	80		10	Change to high plasticity, dark gray (10YR 4/1), moist, very soft at 10.0 feet.				
			15					
			25					
3 CS	100		25					
			30					
			35					
4 CS	90		35					
			40					

SOIL BORING WELL CONSTRUCTION LOG 231828.0003.GPJ TRC CORP.GDT 7/14/16

Signature:  Firm: TRC Environmental Corporation 734.971.7080
1540 Eisenhower Place Ann Arbor, Michigan Fax 734.971.9022

Checked By: C. Scieszka



WELL CONSTRUCTION LOG

WELL NO. MW-16-02

Page 2 of 2

SOIL BORING WELL CONSTRUCTION LOG 231828.0003.0000.GPJ TRC CORP.GDT 7/14/16

SAMPLE		BLOW COUNTS	DEPTH IN FEET	LITHOLOGIC DESCRIPTION	USCS	GRAPHIC LOG	WELL DIAGRAM	COMMENTS
NUMBER AND TYPE	RECOVERY (%)							
5 CS	100		45	CLAY mostly clay, few silt, few coarse gravel, high plasticity, dark gray (10YR 4/1), moist, very soft.	CL			
6 CS	100		50	SILTY CLAY mostly clay, little to some silt, few fine sand, few fine to coarse gravel, high plasticity, dark gray (10YR 4/1), very soft.				
7 CS	50		55					
8 CS	100		60					
9 CS	100		65		CL-ML			
10 CS	100		70					
			75					
			80					
			85					
			90	CLAYEY SILT mostly silt, some clay, few fine sand, few coarse gravel, low plasticity, dark gray (10YR 4/1), moist, very soft.	ML-CL			
			95	SAND mostly fine to coarse sand, dark gray (10YR 4/1), saturated.				
			96.0	Change to fine sand at 96.0 feet.	SW			
			100	End of boring at 100.0 feet below ground surface.				



WELL CONSTRUCTION LOG

WELL NO. MW-16-03

Page 1 of 3

Facility/Project Name: DTE Electric Company Belle River Power Plant		Date Drilling Started: 5/25/16	Date Drilling Completed: 5/31/16	Project Number: 231828.0003	
Drilling Firm: Stock Drilling	Drilling Method: Sonic	Surface Elev. (ft) 588.03	TOC Elevation (ft) 590.66	Total Depth (ft bgs) 150.0	Borehole Dia. (in) 6/4
Boring Location: Approximately 100 feet W of haul road, N of bottom ash basins. N: 471391.78 E: 13626202.49		Personnel Logged By - J. Reed Driller - A. Goldsmith		Drilling Equipment: TSi 150cc	
Civil Town/City/or Village: China Township	County: St. Clair	State: MI	Water Level Observations: While Drilling: Date/Time After Drilling: Date/Time 6/8/16 14:30		Depth (ft bgs) 12.82

SAMPLE	NUMBER AND TYPE	RECOVERY (%)	BLOW COUNTS	DEPTH IN FEET	LITHOLOGIC DESCRIPTION	USCS	GRAPHIC LOG	WELL DIAGRAM	COMMENTS
	1	100		5	TOPSOIL SILTY CLAY mostly clay, some silt, few fine to medium sand, trace gravel, low to medium plasticity, dark gray (10YR 4/1) with trace orange mottling, moist, medium stiff to stiff.	CL-ML			Continuous sampling with 4-inch diameter casing from ground surface to terminus of soil boring, over-drilled with 6-inch diameter casing to install monitoring well.
	2	100		10.5	Change to gray (10YR 5/1) at 10.5 feet. CLAY mostly clay, few silt, trace to few fine to medium sand, medium plasticity, gray (10YR 5/1), moist, soft to medium stiff.				
	3	100		25	Change to trace to few fine to coarse sand at 25.0 feet.	CL			
	4	100		41.5	Change to trace fine to coarse sand at 41.5 feet.				

SOIL BORING WELL CONSTRUCTION LOG 231828.0003.GPJ TRC CORP.GDT 7/14/16

Signature: Firm: TRC Environmental Corporation 734.971.7080
1540 Eisenhower Place Ann Arbor, Michigan Fax 734.971.9022

Checked By: M. Powers



WELL CONSTRUCTION LOG

WELL NO. MW-16-03

SOIL BORING WELL CONSTRUCTION LOG 231828.0003.GPJ TRC CORP.GDT 7/14/16

SAMPLE		BLOW COUNTS	DEPTH IN FEET	LITHOLOGIC DESCRIPTION	USCS	GRAPHIC LOG	WELL DIAGRAM	COMMENTS
NUMBER AND TYPE	RECOVERY (%)							
5 CS	100		45	CLAY mostly clay, few silt, trace fine to coarse sand, medium plasticity, gray (10YR 5/1), moist, soft to medium stiff.				
6 CS	90		50					
			55		CL			
			60	Change to stiff at 60.5 feet. Change to medium stiff at 62.0 feet.				
7 CS	100		65	SANDY CLAY mostly clay, little to some sand, few silt, gray (10YR 5/1), moist, soft to medium stiff.	CL			
			70	CLAY mostly clay, few silt, few fine to coarse sand, gray (10YR 5/1), moist, stiff. Change to coal fragments present at 67.5 feet. Change to no coal fragments present at 68.0 feet.	CL			
8 CS	90		75	1-inch thick interval of silty fine to coarse sand at 75.0 feet.				
			80	SANDY SILT mostly silt, little to some fine to medium sand, gray (10YR 5/1), moist, medium dense.	ML			
			85	CLAY mostly clay, few silt, few fine to coarse sand, low to medium plasticity, gray (10YR 5/1), moist, stiff.				
			90	Change to medium soft at 90.0 feet.	CL			
			95	Change to few fine gravel from 94.0 to 95.0 feet. Change to trace fine gravel, medium stiff to stiff at 95.0 feet.				
10 CS	100		100					



WELL CONSTRUCTION LOG

WELL NO. MW-16-03

Page 3 of 3

SOIL BORING WELL CONSTRUCTION LOG 231828.0003.0000.GPJ TRC CORP.GDT 7/14/16

SAMPLE		BLOW COUNTS	DEPTH IN FEET	LITHOLOGIC DESCRIPTION	USCS	GRAPHIC LOG	WELL DIAGRAM	COMMENTS
NUMBER AND TYPE	RECOVERY (%)							
11	CS	100	105	CLAY mostly clay, few silt, few fine to coarse sand, trace fine gravel, medium plasticity, gray (10YR 5/1), medium stiff to stiff.				
			110	Change to low plasticity, soft to medium stiff at 111.0 feet.				
12	CS	100	115		CL			
			120					
13	CS	100	125					
			130	SANDY CLAY mostly clay, little to some fine to medium sand, few silt, trace to few fine gravel, low to medium plasticity, gray (10YR 5/1), moist, medium stiff.	CL			
			130	SILTY SAND mostly fine to medium sand, little silt, gray (10YR 5/1), moist, loose.	SM			
14	CS	90	135	SAND mostly fine to medium sand, trace silt, gray (10YR 5/1), moist, loose.	SP			
			140	SILTY SAND mostly fine to medium sand, little silt, few clay, gray (10YR 5/1), moist, loose.	SM			
			145	SAND mostly fine to coarse sand, trace to few silt, trace to few clay, dark gray (10YR 4/1), moist to wet, loose.	SW			
15	CS	100	150	SILT mostly silt, few clay, trace coarse sand to fine gravel, gray (10YR 5/1), dry to moist, dense to very dense.	ML			
			150	SHALE weathered shale bedrock, dark gray. End of boring at 150 feet below ground surface.				
			155					



WELL CONSTRUCTION LOG

WELL NO. MW-16-04

Page 1 of 3

Facility/Project Name: DTE Electric Company Belle River Power Plant		Date Drilling Started: 3/7/16	Date Drilling Completed: 3/8/16	Project Number: 231828.0003	
Drilling Firm: Stock Drilling	Drilling Method: Sonic	Surface Elev. (ft) 587.50	TOC Elevation (ft) 590.51	Total Depth (ft bgs) 130.0	Borehole Dia. (in) 6/4
Boring Location: 200 feet from W corner of road, S of bottom ash basins. N: 470893.74 E: 13625876.34		Personnel Logged By - A. Knutson Driller - A. Goldsmith		Drilling Equipment: TSi 150cc	
Civil Town/City/or Village: China Township	County: St. Clair	State: MI	Water Level Observations: While Drilling: Date/Time After Drilling: Date/Time 4/13/16 09:31		Depth (ft bgs) Depth (ft bgs) 13.91

SAMPLE	NUMBER AND TYPE	RECOVERY (%)	BLOW COUNTS	DEPTH IN FEET	LITHOLOGIC DESCRIPTION	USCS	GRAPHIC LOG	WELL DIAGRAM	COMMENTS
	1	CS	80	5	CLAY mostly clay, few coarse gravel, high plasticity, dark gray (10YR 4/1) mottled with brown (10YR 5/3), very stiff. Change to no gravel at 1.0 feet. Change to stiff at 10.5 feet. Change to dark gray (10YR 4/1), very soft at 12.0 feet.	CL			Continuous sampling with 4-inch diameter casing from ground surface to terminus of soil boring, over-drilled with 6-inch diameter casing to install monitoring well.
	2	CS	100	15					
	3	CS	100	25					
	4	CS	100	35					

SOIL BORING WELL CONSTRUCTION LOG 231828.0003.GPJ TRC CORP.GDT 7/14/16

Signature: Firm: TRC Environmental Corporation 734.971.7080
 1540 Eisenhower Place Ann Arbor, Michigan Fax 734.971.9022

Checked By: C. Scieszka



WELL CONSTRUCTION LOG

WELL NO. MW-16-04

Page 2 of 3

SAMPLE		BLOW COUNTS	DEPTH IN FEET	LITHOLOGIC DESCRIPTION	USCS	GRAPHIC LOG	WELL DIAGRAM	COMMENTS
NUMBER AND TYPE	RECOVERY (%)							
5 CS	100		45	CLAY mostly clay, high plasticity, dark gray (10YR 4/1), very soft.				
6 CS	100		55					
			60	Change to few coarse gravel at 60.0 feet.				
7 CS	100		65					
			70					
			75	SILTY CLAY mostly clay, little to some silt, trace fine sand, medium plasticity, dark gray (10YR 4/1), very stiff.	CL-ML			
8 CS	100		75	SILT mostly silt, trace to few fine sand, non plastic, dark gray (10YR 4/1), saturated, stiff.	ML			
			80	SAND mostly fine sand, few medium to coarse sand, dark gray (10YR 4/1), moist.	SP			
			80	SANDY CLAY mostly clay, some fine sand, high plasticity, dark gray (10YR 4/1), moist.	CL			
			85	SILTY CLAY mostly clay, some silt, high plasticity, dark gray (10YR 4/1), stiff.	CL-ML			
9 CS	100		85	CLAYEY SILT mostly silt, some clay, low plasticity, dark gray (10YR 4/1), stiff.	ML-CL			
			90	SILTY CLAY mostly clay, some silt, high plasticity, dark gray (10YR 4/1), stiff.				
			95		CL-ML			
10 CS	100		95					
			100	CLAY mostly clay, high plasticity, dark gray (10YR 4/1), very soft.	CL			

SOIL BORING WELL CONSTRUCTION LOG 231828 0003 0000.GPJ TRC_CORP.GDT 7/14/16



WELL CONSTRUCTION LOG

WELL NO. MW-16-04

Page 3 of 3

SAMPLE		BLOW COUNTS	DEPTH IN FEET	LITHOLOGIC DESCRIPTION	USCS	GRAPHIC LOG	WELL DIAGRAM	COMMENTS
NUMBER AND TYPE	RECOVERY (%)							
11 CS	100		105	CLAY mostly clay, high plasticity, dark gray (10YR 4/1), very soft.	CL			
12 CS	100		115	SILT mostly silt, few fine sand, nonplastic, dark gray (10YR 4/1), saturated, stiff.	ML			
13 CS	100		125	SAND mostly fine sand, dark gray (10YR 4/1), saturated.	SP			
			130	End of boring at 130.0 feet below ground surface.				
			135					
			140					
			145					
			150					
			155					

SOIL BORING WELL CONSTRUCTION LOG 231828.0003.0000.GPJ TRC_CORP.GDT 7/14/16



WELL CONSTRUCTION LOG

WELL NO. MW-16-05

Facility/Project Name: DTE Electric Company Belle River Power Plant		Date Drilling Started: 3/3/16	Date Drilling Completed: 3/4/16	Project Number: 231828.0003	
Drilling Firm: Stock Drilling	Drilling Method: Sonic	Surface Elev. (ft) 588.32	TOC Elevation (ft) 590.82	Total Depth (ft bgs) 150.0	Borehole Dia. (in) 6
Boring Location: S end of haul road, W of diversion basin. N: 470378.15 E: 13626342.79		Personnel Logged By - A. Knutson Driller - A. Goldsmith		Drilling Equipment: TSi 150cc	
Civil Town/City/or Village: China Township	County: St. Clair	State: MI	Water Level Observations: While Drilling: Date/Time After Drilling: Date/Time 4/13/16 09:55		
			Depth (ft bgs)	Depth (ft bgs) 14.37	

SAMPLE NUMBER AND TYPE	RECOVERY (%)	BLOW COUNTS	DEPTH IN FEET	LITHOLOGIC DESCRIPTION	USCS	GRAPHIC LOG	WELL DIAGRAM	COMMENTS
1 CS	80		5	<p>CLAY WITH GRAVEL mostly clay, few to some coarse gravel, high plasticity, dark grayish brown (10YR 4/2), moist, very stiff.</p> <p>CLAY mostly clay, few fine to coarse gravel, high plasticity, dark gray (10YR 4/1) mottled with brown (10YR 5/3), moist, hard.</p> <p>Change to no gravel, very stiff at 4.0 feet.</p>	CL			Continuous sampling with 4-inch diameter casing from ground surface to terminus of soil boring, over-drilled with 6-inch diameter casing to install monitoring well.
			10	Change to dark gray (10YR 4/1), very soft at 10.0 feet.				
2 CS	100		15					
			20					
			25	Change to medium stiff at 26.0 feet.				
			30	Change to very soft at 28.0 feet.				
			35					
3 CS	100		25					
			30					
			35					
4 CS	100		35					
			40					

SOIL BORING WELL CONSTRUCTION LOG 231828.0003.GPJ TRC CORP.GDT 7/14/16

Signature:

Firm: TRC Environmental Corporation 734.971.7080
1540 Eisenhower Place Ann Arbor, Michigan Fax 734.971.9022

Checked By: C. Scieszka



WELL CONSTRUCTION LOG

WELL NO. MW-16-05

Page 2 of 3

SAMPLE		BLOW COUNTS	DEPTH IN FEET	LITHOLOGIC DESCRIPTION	USCS	GRAPHIC LOG	WELL DIAGRAM	COMMENTS
NUMBER AND TYPE	RECOVERY (%)							
5 CS	100		45	CLAY mostly clay, high plasticity, dark gray (10YR 4/1), moist, very soft.	CL			
				SILTY CLAY mostly clay, little to some silt, medium plasticity, dark gray (10YR 4/1), very soft.	CL-ML			
6 ST	100		50	CLAY mostly clay, high plasticity, dark gray (10YR 4/1), moist, very soft.				
7 CS	100		55					
			60	Change to few fine to coarse gravel at 60.0 feet.	CL			
8 CS	100		65	Change to medium stiff at 65.0 feet.				
			67.5	Change to stiff at 67.5 feet.				
			70	SILTY CLAY mostly clay, some silt, few fine to coarse gravel, high plasticity, very dark gray (10YR 3/1), very stiff.				
9 CS	100		75	Change to low plasticity, black (10YR 2/1), hard at 77.0 feet.				
			80		CL-ML			
10 CS	60		85	Change to few to little fine sand at 85.5 feet.				
			90	CLAY mostly clay, few coarse gravel, high plasticity, dark gray (10YR 4/1), moist, very soft.				
			93.5	Change to medium stiff at 93.5 feet.				
11 CS	100		95	Change to soft at 97.5 feet.	CL			
			100					

SOIL BORING WELL CONSTRUCTION LOG 231828.0003.0000.GPJ TRC CORP.GDT 7/14/16



WELL CONSTRUCTION LOG

WELL NO. MW-16-05

SOIL BORING WELL CONSTRUCTION LOG 231828.0003.GPJ TRC CORP.GDT 7/14/16

SAMPLE		BLOW COUNTS	DEPTH IN FEET	LITHOLOGIC DESCRIPTION	USCS	GRAPHIC LOG	WELL DIAGRAM	COMMENTS
NUMBER AND TYPE	RECOVERY (%)							
12 CS	100		105	CLAY mostly clay, few coarse gravel, high plasticity, dark gray (10YR 4/1), moist, soft.	CL			
13 CS	100		110-115					
14 CS	100		120-125					
15 CS	100		135	CLAYEY SILT mostly silt, some clay, medium plasticity, dark gray (10YR 4/1), wet, medium stiff.	ML-CL			
16 CS	90		145	SHALE dark gray (10YR 4/1), dry.				
			150	End of boring at 150.0 feet below ground surface.				
			155					



WELL CONSTRUCTION LOG

WELL NO. MW-16-06

Page 1 of 3

Facility/Project Name: DTE Electric Company Belle River Power Plant		Date Drilling Started: 3/10/16	Date Drilling Completed: 3/11/16	Project Number: 231828.0003
Drilling Firm: Stock Drilling	Drilling Method: Sonic	Surface Elev. (ft) 589.98	TOC Elevation (ft) 593.21	Total Depth (ft bgs) 140.0
Boring Location: 123 feet S of road connecting to haul road, E of diversion basin. N: 470439.03 E: 13626796.04		Personnel Logged By - A. Knutson Driller - A. Goldsmith		Drilling Equipment: TSi 150cc
Civil Town/City/or Village: China Township	County: St. Clair	State: MI	Water Level Observations: While Drilling: Date/Time After Drilling: Date/Time 4/13/16 10:01 Depth (ft bgs) 14.45	

SAMPLE NUMBER AND TYPE	RECOVERY (%)	BLOW COUNTS	DEPTH IN FEET	LITHOLOGIC DESCRIPTION	USCS	GRAPHIC LOG	WELL DIAGRAM	COMMENTS
1 CS	50		5	GRAVEL WITH SAND mostly gravel, some fine to coarse sand, brown (10YR 5/3), moist, dense. CLAY mostly clay, high plasticity, dark gray (10YR 4/1) mottled with brown (10YR 5/3), moist, very stiff.				Continuous sampling with 4-inch diameter casing from ground surface to terminus of soil boring, over-drilled with 6-inch diameter casing to install monitoring well.
			10	Change to few coarse gravel at 10.0 feet.				
2 CS	100		15	Change to dark gray (10YR 4/1), stiff at 12.0 feet. Change to very soft at 13.0 feet.				
			20					
3 CS	100		25					
			30					
4 CS	100		35					
			40					

SOIL BORING WELL CONSTRUCTION LOG 231828.0003.GPJ TRC CORP.GDT 7/14/16

Signature: *[Handwritten Signature]* Firm: TRC Environmental Corporation 734.971.7080
 1540 Eisenhower Place Ann Arbor, Michigan Fax 734.971.9022
 Checked By: C. Scieszka



WELL CONSTRUCTION LOG

WELL NO. MW-16-06

Page 2 of 3

SAMPLE		BLOW COUNTS	DEPTH IN FEET	LITHOLOGIC DESCRIPTION	USCS	GRAPHIC LOG	WELL DIAGRAM	COMMENTS
NUMBER AND TYPE	RECOVERY (%)							
5 CS	100		45	CLAY mostly clay, few coarse gravel, high plasticity, dark gray (10YR 4/1), moist, very soft.				
6 CS	100		55		CL			
7 CS	100		65					
			70	SILTY CLAY mostly clay, some silt, medium plasticity, dark gray (10YR 4/1), moist, medium stiff.	CL-ML			
				SAND mostly fine sand, few coarse sand, dark gray (10YR 4/1), moist.	SP			
8 CS	100		75	SILTY CLAY mostly clay, some silt, medium plasticity, dark gray (10YR 4/1), moist, medium stiff.				
			80		CL-ML			
9 CS	80		85					
			90	CLAY mostly clay, high plasticity, dark gray (10YR 4/1), moist, very soft.				
10 CS	70		95		CL			
			100					

SOIL BORING WELL CONSTRUCTION LOG 231828.0003.0000.GPJ TRC CORP.GDT 7/14/16



WELL CONSTRUCTION LOG

WELL NO. MW-16-06

SOIL BORING WELL CONSTRUCTION LOG 231828.0003.0000.GPJ TRC CORP.GDT 7/14/16

SAMPLE		BLOW COUNTS	DEPTH IN FEET	LITHOLOGIC DESCRIPTION	USCS	GRAPHIC LOG	WELL DIAGRAM	COMMENTS
NUMBER AND TYPE	RECOVERY (%)							
11 CS	100		105	CLAY mostly clay, high plasticity, dark gray (10YR 4/1), moist, very soft.	CL			
12 CS	100		110-115					
13 CS	100		125	SILTY CLAY mostly clay, some silt, medium plasticity, dark gray (10YR 4/1), moist, medium stiff.	CL-ML			
14 CS	100		130-135					
			135	SILT mostly silt, dark gray (10YR 4/1), saturated, very soft.	ML			
			140	SHALE dark gray (10YR 4/1), hard, brittle.				
			140	End of boring at 140.0 feet below ground surface.				
			145					
			150					
			155					



WELL CONSTRUCTION LOG

WELL NO. MW-16-07

Page 1 of 3

Facility/Project Name: DTE Electric Company Belle River Power Plant		Date Drilling Started: 3/8/16	Date Drilling Completed: 3/9/16	Project Number: 231828.0003	
Drilling Firm: Stock Drilling	Drilling Method: Sonic	Surface Elev. (ft) 589.89	TOC Elevation (ft) 592.58	Total Depth (ft bgs) 140.0	Borehole Dia. (in) 6
Boring Location: 326 feet S of road connecting to haul road, E of diversion basin. N: 470233.47 E: 13626858.79		Personnel Logged By - A. Knutson Driller - A. Goldsmith		Drilling Equipment: TSi 150cc	
Civil Town/City/or Village: China Township	County: St. Clair	State: MI	Water Level Observations: While Drilling: Date/Time After Drilling: Date/Time 4/13/16 11:56		Depth (ft bgs) 14.13

SAMPLE	NUMBER AND TYPE	RECOVERY (%)	BLOW COUNTS	DEPTH IN FEET	LITHOLOGIC DESCRIPTION	USCS	GRAPHIC LOG	WELL DIAGRAM	COMMENTS
1	CS	60		5	CLAY mostly clay, few coarse gravel, high plasticity, brown (10YR 5/3) mottled with dark gray (10YR 4/1), very stiff.				Continuous sampling with 4-inch diameter casing from ground surface to terminus of soil boring, over-drilled with 6-inch diameter casing to install monitoring well.
				5	Change to dark gray (10YR 4/1) mottled with brown (10YR 5/3) at 5.0 feet.				
				10	Change to dark gray (10YR 4/1) at 11.0 feet.				
				13	▼ Change to moist, very soft at 13.0 feet.				
2	CS	100		15					
3	CS	100		25					
4	CS	100		35					
				40					

SOIL BORING WELL CONSTRUCTION LOG 231828.0003.0000.GPJ TRC CORP.GDT 7/14/16

Signature:  Firm: TRC Environmental Corporation 734.971.7080
1540 Eisenhower Place Ann Arbor, Michigan Fax 734.971.9022

Checked By: C. Scieszka



WELL CONSTRUCTION LOG

WELL NO. MW-16-07

Page 2 of 3

SAMPLE		BLOW COUNTS	DEPTH IN FEET	LITHOLOGIC DESCRIPTION	USCS	GRAPHIC LOG	WELL DIAGRAM	COMMENTS
NUMBER AND TYPE	RECOVERY (%)							
5 CS	100		45	CLAY mostly clay, few coarse gravel, high plasticity, dark gray (10YR 4/1), moist, very soft.	CL			
6 ST	100		50					
7 CS	100		55	SILTY CLAY mostly clay, little silt, high plasticity, dark gray (10YR 4/1), moist, soft.	CL-ML			
8 CS	100		65	CLAYEY SILT mostly silt, little to some clay, few fine to coarse sand, low plasticity, dark gray (10YR 4/1), moist.	ML-CL			
			66	SAND mostly fine to coarse sand, dark gray (10YR 4/1), moist, loose.	SW			
			67	CLAYEY SILT mostly silt, little to some clay, few fine to coarse sand, low plasticity, dark gray (10YR 4/1), moist.	ML-CL			
			70	SILTY CLAY mostly clay, little silt, high plasticity, dark gray (10YR 4/1), moist, soft. Change to few coarse gravel at 70.0 feet.				
9 CS	100		75					
10 CS	100		85		CL-ML			
11 CS	100		95					
			100					

SOIL BORING WELL CONSTRUCTION LOG 231825.0003.GPJ TRC_CORP.GDT 7/14/16



WELL CONSTRUCTION LOG

WELL NO. MW-16-07

Page 3 of 3

SAMPLE		BLOW COUNTS	DEPTH IN FEET	LITHOLOGIC DESCRIPTION	USCS	GRAPHIC LOG	WELL DIAGRAM	COMMENTS
NUMBER AND TYPE	RECOVERY (%)							
12 CS	100		105	SILTY CLAY mostly clay, little silt, high plasticity, dark gray (10YR 4/1), moist, soft.	CL-ML			
13 CS	80		110					
14 CS	100		125					
15 CS	100		135					
			130	SILT mostly silt, no plasticity, dark gray (10YR 4/1), saturated, loose.	ML			
			135	SHALE dark gray (10YR 4/1), brittle, hard.				
			140	End of boring at 140.0 feet below ground surface.				
			145					
			150					
			155					

SOIL BORING WELL CONSTRUCTION LOG 231828.0003.0000.GPJ TRC CORP.GDT 7/14/16



WELL CONSTRUCTION LOG

WELL NO. MW-16-08

Page 1 of 3

Facility/Project Name: DTE Electric Company Belle River Power Plant		Date Drilling Started: 3/9/16	Date Drilling Completed: 3/10/16	Project Number: 231828.0003	
Drilling Firm: Stock Drilling	Drilling Method: Sonic	Surface Elev. (ft) 589.31	TOC Elevation (ft) 591.88	Total Depth (ft bgs) 140.0	Borehole Dia. (in) 6
Boring Location: 566.6 feet S of road connecting to haul road, E of diversion basin. N: 470002.90 E: 13626846.85		Personnel Logged By - A. Knutson Driller - A. Goldsmith		Drilling Equipment: TSi 150cc	
Civil Town/City/or Village: China Township	County: St. Clair	State: MI	Water Level Observations: While Drilling: Date/Time After Drilling: Date/Time 4/13/16 12:00		
			Depth (ft bgs)	Depth (ft bgs) 13.19	

SAMPLE NUMBER AND TYPE	RECOVERY (%)	BLOW COUNTS	DEPTH IN FEET	LITHOLOGIC DESCRIPTION	USCS	GRAPHIC LOG	WELL DIAGRAM	COMMENTS
1 CS	50		5	CLAY WITH GRAVEL mostly clay, little coarse gravel, high plasticity, dark gray (10YR 4/1) mottled with brown (10YR 5/3), moist, very stiff.	CL			Continuous sampling with 4-inch diameter casing from ground surface to terminus of soil boring, over-drilled with 6-inch diameter casing to install monitoring well.
			10	CLAY mostly clay, high plasticity, dark gray (10YR 4/1) mottled with brown (10YR 5/3), moist, very stiff.				
			15	Change to dark gray (10YR 4/1), very soft at 10.0 feet.				
2 CS	100		15					
3 CS	100		25		CL			
4 CS	100		35					

SOIL BORING WELL CONSTRUCTION LOG 231828.0003.GPJ TRC CORP.GDT 7/14/16

Signature: Firm: TRC Environmental Corporation 734.971.7080
1540 Eisenhower Place Ann Arbor, Michigan Fax 734.971.9022

Checked By: C. Scieszka



WELL CONSTRUCTION LOG

WELL NO. MW-16-08

Page 2 of 3

SOIL BORING WELL CONSTRUCTION LOG 231828.0003.GPJ TRC CORP.GDT 7/14/16

SAMPLE		BLOW COUNTS	DEPTH IN FEET	LITHOLOGIC DESCRIPTION	USCS	GRAPHIC LOG	WELL DIAGRAM	COMMENTS
NUMBER AND TYPE	RECOVERY (%)							
5 CS	100		45	CLAY mostly clay, high plasticity, dark gray (10YR 4/1), moist, very soft.	CL			
6 CS	100		55					
7 CS	80		65					
8 CS	100		75	SILTY CLAY mostly clay, some silt, few coarse gravel, high plasticity, dark gray (10YR 4/1), moist, soft.	CL-ML			
9 CS	100		85					
10 CS	60		95					
			100					



WELL CONSTRUCTION LOG

WELL NO. MW-16-08

Page 3 of 3

SOIL BORING WELL CONSTRUCTION LOG 231828.0003.0000.GPJ TRC CORP.GDT 7/14/16

SAMPLE		BLOW COUNTS	DEPTH IN FEET	LITHOLOGIC DESCRIPTION	USCS	GRAPHIC LOG	WELL DIAGRAM	COMMENTS
NUMBER AND TYPE	RECOVERY (%)							
11 CS	100		105	SILTY CLAY mostly clay, some silt, few coarse gravel, high plasticity, dark gray (10YR 4/1), moist, soft. Change to few fine sand at 105.5 feet.	CL-ML			
12 CS	100		110	Change to no sand at 110.0 feet.				
13 CS	100		125					
14 CS	100		130	SILT mostly silt, dark gray (10YR 4/1), saturated, very soft.	ML			
			135	SHALE dark gray (10YR 4/1), brittle, hard.				
			140	End of boring at 140.0 feet below ground surface.				
			145					
			150					
			155					



WELL CONSTRUCTION LOG

WELL NO. MW-16-09

Page 1 of 3

Facility/Project Name: DTE Electric Company Belle River Power Plant		Date Drilling Started: 6/1/16	Date Drilling Completed: 6/1/16	Project Number: 231828.0003	
Drilling Firm: Stock Drilling	Drilling Method: Sonic	Surface Elev. (ft) 588.28	TOC Elevation (ft) 590.80	Total Depth (ft bgs) 150.0	Borehole Dia. (in) 6
Boring Location: E of bottom ash basins, E of haul road. N: 471284.45 E: 13626365.84		Personnel Logged By - J. Reed Driller - A. Goldsmith		Drilling Equipment: TSi 150cc	
Civil Town/City/or Village: China Township	County: St. Clair	State: MI	Water Level Observations: While Drilling: _____ Date/Time _____ After Drilling: _____ Date/Time 6/9/16 15:13		Depth (ft bgs) 14.36

SAMPLE NUMBER AND TYPE	RECOVERY (%)	BLOW COUNTS	DEPTH IN FEET	LITHOLOGIC DESCRIPTION	USCS	GRAPHIC LOG	WELL DIAGRAM	COMMENTS
1 CS	75		5	<p>TOPSOIL</p> <p>SILTY CLAY mostly clay, little to some silt, few fine to coarse sand, trace to few fine gravel, low plasticity, dark grayish brown (10YR 4/2), moist, stiff.</p>	CL-ML			Continuous sampling with 4-inch diameter casing from ground surface to terminus of soil boring, over-drilled with 6-inch diameter casing to install monitoring well.
			10	<p>CLAY mostly clay, few silt, trace to few fine to coarse sand, medium plasticity, gray (10YR 5/1), moist, soft.</p>				
2 CS	85		15					
3 CS	100		25		CL			
4 CS	100		35	Change to trace to few fine gravel at 30.0 feet.				

SOIL BORING WELL CONSTRUCTION LOG 231828.0003.GPJ TRC CORP.GDT 7/14/16

Signature: Firm: TRC Environmental Corporation 734.971.7080
1540 Eisenhower Place Ann Arbor, Michigan Fax 734.971.9022

Checked By: M. Powers



WELL CONSTRUCTION LOG

WELL NO. MW-16-09

SAMPLE		BLOW COUNTS	DEPTH IN FEET	LITHOLOGIC DESCRIPTION	USCS	GRAPHIC LOG	WELL DIAGRAM	COMMENTS
NUMBER AND TYPE	RECOVERY (%)							
5 CS	100		45	<p>CLAY mostly clay, few silt, trace to few fine to coarse sand, trace to few fine gravel, medium plasticity, gray (10YR 5/1), moist, soft.</p> <p>Change to soft to medium stiff at 50.0 feet.</p>	CL			
			50					
			55					
6 CS	100		60	<p>Change to soft at 70.0 feet.</p>	CL			
			65					
			70					
7 CS	100		75	<p>Change to medium stiff to stiff at 80.0 feet.</p> <p>Change to stiff at 85.0 feet.</p>	CL			
			80					
			85					
			90					
			95					
			100					

SOIL BORING WELL CONSTRUCTION LOG 231828.0003.0000.GPJ TRC_CORP.GDT 7/14/16



WELL CONSTRUCTION LOG

WELL NO. MW-16-09

SOIL BORING WELL CONSTRUCTION LOG 231828.0003.GPJ TRC CORP.GDT 7/14/16

SAMPLE		BLOW COUNTS	DEPTH IN FEET	LITHOLOGIC DESCRIPTION	USCS	GRAPHIC LOG	WELL DIAGRAM	COMMENTS
NUMBER AND TYPE	RECOVERY (%)							
8 CS	75		105	<p>CLAY mostly clay, few silt, trace to few fine to coarse sand, trace to few fine gravel, medium plasticity, gray (10YR 5/1), moist, stiff. Change to medium stiff at 105.0 feet.</p>				
9 CS	80		110					
			115					
			120		CL			
			125					
10 CS	100		130					
			135					
			140	<p>SAND mostly fine sand, trace silt, dark gray (10YR 4/1), moist, loose.</p>	SP			
			145	<p>SAND WITH GRAVEL mostly fine to coarse sand, little to some fine to medium gravel, trace to few silt, trace to few clay, dark gray (10YR 4/1), moist to wet, loose.</p>	SW			
11 CS	80		150	<p>SHALE weathered, gray (10YR 5/1), brittle.</p>				
			150	End of boring at 150.0 feet below ground surface.				
			155					



WELL CONSTRUCTION LOG

WELL NO. MW-16-10

Page 1 of 3

Facility/Project Name: DTE Electric Company Belle River Power Plant		Date Drilling Started: 6/2/16	Date Drilling Completed: 6/3/16	Project Number: 231828.0003	
Drilling Firm: Stock Drilling	Drilling Method: Sonic	Surface Elev. (ft) 589.25	TOC Elevation (ft) 592.26	Total Depth (ft bgs) 150.0	Borehole Dia. (in) 6
Boring Location: S end of haul road, W/NW of diversion basin. N: 470532.54 E: 13626417.00		Personnel Logged By - J. Reed Driller - A. Goldsmith		Drilling Equipment: TSi 150cc	
Civil Town/City/or Village: China Township	County: St. Clair	State: MI	Water Level Observations: While Drilling: Date/Time After Drilling: Date/Time 6/9/16 07:45		Depth (ft bgs) Depth (ft bgs) 15.30

SAMPLE NUMBER AND TYPE	RECOVERY (%)	BLOW COUNTS	DEPTH IN FEET	LITHOLOGIC DESCRIPTION	USCS	GRAPHIC LOG	WELL DIAGRAM	COMMENTS
1 CS	50		5	TOPSOIL CLAY mostly clay, few silt, trace to few fine to coarse sand, dark grayish brown (10YR 4/2), moist, medium stiff to stiff.				Continuous sampling with 4-inch diameter casing from ground surface to terminus of soil boring, over-drilled with 6-inch diameter casing to install monitoring well.
2 CS	90		15	Change to gray (10YR 5/1) at 11.0 feet. Change to soft to medium stiff at 12.0 feet.				
3 CS	95		25	Change to soft at 25.0 feet.				
4 CS	100		35	Change to few fine to coarse sand, medium stiff at 30.0 feet. Change to dark gray (10YR 4/1) at 32.0 feet. Change to soft at 35.0 feet.	CL			

SOIL BORING WELL CONSTRUCTION LOG 231828.0003.GPJ TRC CORP.GDT 7/14/16

Signature: *M. Powers* Firm: TRC Environmental Corporation 734.971.7080
1540 Eisenhower Place Ann Arbor, Michigan Fax 734.971.9022

Checked By: M. Powers



WELL CONSTRUCTION LOG

WELL NO. MW-16-10

SOIL BORING WELL CONSTRUCTION LOG 231828.0003.0000.GPJ TRC CORP.GDT 7/14/16

SAMPLE		BLOW COUNTS	DEPTH IN FEET	LITHOLOGIC DESCRIPTION	USCS	GRAPHIC LOG	WELL DIAGRAM	COMMENTS
NUMBER AND TYPE	RECOVERY (%)							
5 CS	100		45	CLAY mostly clay, few silt, trace to few fine to coarse sand, dark gray (10YR 4/1), moist, soft.				
6 CS	100		55		CL			
7 CS	100		65					
8 CS	100		75	CLAY WITH SAND mostly clay, little fine to coarse sand, few silt, trace gravel, dark gray (10YR 4/1), moist, very stiff. Change to few to little medium to coarse sand, low to medium plasticity, stiff at 75.0 feet.	CL			
9 CS	100		85	CLAYEY SAND mostly fine to coarse sand, some clay, dark grayish brown (10YR 4/2), moist, medium dense. SAND mostly fine to medium sand, dark grayish brown (10YR 4/2), moist, loose.	SC SP			
10 CS	100		95	SANDY CLAY mostly clay, little to some fine to coarse sand, few silt, medium plasticity, dark grayish brown (10YR 4/2), moist, medium stiff to stiff.	CL			
			100	CLAY WITH SAND mostly clay, little fine to coarse sand, few silt, medium plasticity, dark grayish brown (10YR 4/2), moist, medium stiff to stiff.	CL			



WELL CONSTRUCTION LOG

WELL NO. MW-16-10

SOIL BORING WELL CONSTRUCTION LOG 231828.0003.GPJ TRC CORP.GDT 7/14/16

SAMPLE		BLOW COUNTS	DEPTH IN FEET	LITHOLOGIC DESCRIPTION	USCS	GRAPHIC LOG	WELL DIAGRAM	COMMENTS
NUMBER AND TYPE	RECOVERY (%)							
11 CS	100		105	CLAY WITH SAND mostly clay, little fine to coarse sand, few silt, medium plasticity, dark grayish brown (10YR 4/2), moist, medium stiff to stiff.	CL			
			110	SANDY CLAY mostly clay, little to some fine to coarse sand, few silt, medium plasticity, dark grayish brown (10YR 4/2), moist, medium stiff.	CL			
12 CS	100		115	SAND mostly medium to coarse sand, dark gray (10YR 4/1), moist, loose.	SP			
			120	CLAY mostly clay, little sand, few to little silt, dark gray (10YR 4/1), moist, stiff.				
13 CS	95		125					
			130		CL			
14 CS	95		135					
			140					
15 CS	50		145	GRAVELLY SILT mostly silt, some fine to coarse gravel, few clay, few sand, low to medium plasticity, dark gray (10YR 4/1), moist, soft.	ML			
			150	SILTY CLAY hard, dark gray (10YR 4/1), hardpan, brittle.	CL-ML			
			150	SHALE dark gray. End of boring at 150.0 feet below ground surface.				
			155					
			160					



WELL CONSTRUCTION LOG

WELL NO. MW-16-11

Page 1 of 3

Facility/Project Name: DTE Electric Company Belle River Power Plant		Date Drilling Started: 6/3/16	Date Drilling Completed: 6/6/16	Project Number: 231828.0003	
Drilling Firm: Stock Drilling	Drilling Method: Sonic	Surface Elev. (ft) 589.03	TOC Elevation (ft) 591.54	Total Depth (ft bgs) 150.0	Borehole Dia. (in) 6
Boring Location: S of haul road, W of diversion basin. N: 470251.34 E: 13626438.92		Personnel Logged By - J. Reed Driller - A. Goldsmith		Drilling Equipment: TSi 150cc	
Civil Town/City/or Village: China Township	County: St. Clair	State: MI	Water Level Observations: While Drilling: Date/Time After Drilling: Date/Time 6/21/16 07:45		Depth (ft bgs) Depth (ft bgs) 14.47

SAMPLE NUMBER AND TYPE	RECOVERY (%)	BLOW COUNTS	DEPTH IN FEET	LITHOLOGIC DESCRIPTION	USCS	GRAPHIC LOG	WELL DIAGRAM	COMMENTS
1 CS	50		5	TOPSOIL CLAY mostly clay, few silt, trace to few sand, few gravel, low to medium plasticity, dark grayish brown (10YR 4/2), moist, stiff.				Continuous sampling with 4-inch diameter casing from ground surface to terminus of soil boring, over-drilled with 6-inch diameter casing to install monitoring well.
			10	Change to trace gravel at 8.0 feet.				
2 CS	70		15	Change to gray (10YR 5/1) at 12.0 feet. Change to no gravel at 13.0 feet.				
			20	Change to medium stiff at 21.0 feet.	CL			
3 CS	90		25					
			30					
4 CS	90		35	Change to soft to medium stiff at 34.5 feet.				
			40					

SOIL BORING WELL CONSTRUCTION LOG 231828.0003.GPJ TRC_CORP.GDT 7/14/16

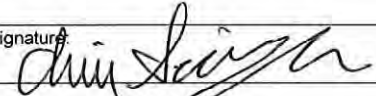
Signature:  Firm: TRC Environmental Corporation 734.971.7080
 1540 Eisenhower Place Ann Arbor, Michigan Fax 734.971.9022
 Checked By: M. Powers



WELL CONSTRUCTION LOG

WELL NO. MW-16-11

Page 2 of 3

SAMPLE		BLOW COUNTS	DEPTH IN FEET	LITHOLOGIC DESCRIPTION	USCS	GRAPHIC LOG	WELL DIAGRAM	COMMENTS
NUMBER AND TYPE	RECOVERY (%)							
5 CS	90		45	CLAY mostly clay, few silt, trace to few sand, medium plasticity, gray (10YR 5/1), moist, soft to medium stiff.	CL			
			50	Change to medium stiff at 49.0 feet.				
6 CS	100		55					
			60	Change to soft at 60.0 feet.				
7 CS	100		65					
			70	Change to trace gravel, soft to medium stiff at 70.0 feet.				
8 CS	100		75	Change to medium stiff at 75.0 feet.				
			80					
9 CS	90		85					
			90					
10 CS	90		95	Change to medium stiff to stiff at 95.0 feet.				
			100					

SOIL BORING WELL CONSTRUCTION LOG 231828.0003.0000.GPJ TRC CORP.GDT 7/14/16



WELL CONSTRUCTION LOG

WELL NO. MW-16-11

SOIL BORING WELL CONSTRUCTION LOG 231828.0003.0000.GPJ TRC CORP.GDT 7/14/16

SAMPLE		BLOW COUNTS	DEPTH IN FEET	LITHOLOGIC DESCRIPTION	USCS	GRAPHIC LOG	WELL DIAGRAM	COMMENTS
NUMBER AND TYPE	RECOVERY (%)							
11 CS	85		105	<p>CLAY mostly clay, few silt, trace to few sand, trace gravel, low to medium plasticity, gray (10YR 5/1), moist, medium stiff to stiff.</p> <p>Change to medium stiff at 110.0 feet.</p>	CL			
12 CS	80		115					
13 CS	85		125					
14 CS	90		135					
15 CS	90		145					
			140	<p>SANDY CLAY mostly clay, some fine sand, few silt, dark gray (10YR 4/1), moist.</p> <p>CLAY mostly clay, few silt, trace to few sand, trace gravel, low to medium plasticity, gray (10YR 5/1), moist, medium stiff.</p> <p>SHALE dark gray.</p>	CL			
			150	End of boring 150.0 feet below ground surface.				
			155					



WELL CONSTRUCTION LOG

WELL NO. MW-16-11A

Facility/Project Name: DTE Electric Company Belle River Power Plant		Date Drilling Started: 5/11/17	Date Drilling Completed: 5/12/17	Project Number: 231828.0003
Drilling Firm: Stock Drilling	Drilling Method: Sonic	Surface Elev. (ft) 589.5	TOC Elevation (ft) 591.66	Total Depth (ft bgs) 142.0
Boring Location: North of fuel oil tank number 2, between berm and fence.		Personnel Logged By - J. Krenz Driller - A. Goldsmith		Drilling Equipment: TSi 150cc
Civil Town/City/or Village: China Township	County: St. Clair	State: MI	Water Level Observations: While Drilling: Date/Time After Drilling: Date/Time 5/15/17 08:38	
				Depth (ft bgs) 17.79

SAMPLE NUMBER AND TYPE	RECOVERY (%)	BLOW COUNTS	DEPTH IN FEET	LITHOLOGIC DESCRIPTION	USCS	GRAPHIC LOG	WELL DIAGRAM	COMMENTS
1 CS	90			CLAY mostly clay, trace gravel, medium plasticity, dark grayish brown (10YR 4/2), mottled with dark yellowish brown (10YR 4/6), medium stiff, moist, plant roots to 0.5 feet.				Continuous sampling with 4-inch diameter casing from ground surface to terminus of soil boring, over-drilled with 6-inch diameter casing to install monitoring well.
2 CS	60		10					
			19.0	▼ Change to high plasticity, gray (10YR 5/1), soft at 19.0 feet.				
3 CS	70		20					
4 CS	70		30		CL			
5 CS	100		40					
6 CS	100		50					
7			60					

SOIL BORING WELL CONSTRUCTION LOG 231828.0003.GPJ TRC CORP.GDT 8/21/17

Signature: *Paul Krenz* Firm: TRC Environmental Fax

Checked By: C. Scieszka



WELL CONSTRUCTION LOG

WELL NO. MW-16-11A

Page 2 of 2

SOIL BORING WELL CONSTRUCTION LOG 231828.0003.0000.GPJ TRC CORP.GDT 8/21/17

SAMPLE		BLOW COUNTS	DEPTH IN FEET	LITHOLOGIC DESCRIPTION	USCS	GRAPHIC LOG	WELL DIAGRAM	COMMENTS		
NUMBER AND TYPE	RECOVERY (%)									
CS	100			CLAY mostly clay, trace fine to medium gravel, high plasticity, gray (10YR 5/1), medium stiff, moist.	CL					
			70	Change to few fine to coarse gravel at 70.0 feet.						
8 CS	100									
			80	Change to trace fine sand at 80.0 feet.						
9 CS	90									
			90							
10 CS	70									
			100							
11 CS	100									
			110							
12 CS	100									
			120							
13 CS	100			Change to trace medium to coarse gravel at 126.0 feet.						
			130							
14 CS	60			SILT mostly silt, trace clay, dark gray (10YR 4/1), dense, saturated.				ML		
			140	SILTY CLAY mostly clay, some silt, few to little fine to coarse gravel, medium to low plasticity, dark gray (10YR 4/1), moist, medium stiff, inclusions of shale bedrock.	CL-ML					
15 CS	100			BEDROCK shale, weathered, gray (10YR 4/1). End of boring at 142.0 feet below ground surface.						
			150							



SOIL BORING LOG

BORING NO. SB-16-01

Page 1 of 3

Facility/Project Name: DTE Electric Company Belle River Power Plant		Date Drilling Started: 3/1/16	Date Drilling Completed: 3/1/16	Project Number: 231828.0003
Drilling Firm: Stock Drilling	Drilling Method: Sonic	Surface Elev. (ft) 588.69	TOC Elevation (ft) ---	Total Depth (ft bgs) 150.0
Boring Location: Corner of E connecting road off haul road, E of bottom ash basins.		Personnel Logged By - A. Knutson Driller - A. Goldsmith		Drilling Equipment: TSi 150cc
Civil Town/City/or Village: China Township		County: St. Clair	State: MI	Water Level Observations: While Drilling: Date/Time After Drilling: Date/Time
				Depth (ft bgs) Depth (ft bgs)

SAMPLE NUMBER AND TYPE	RECOVERY (%)	BLOW COUNTS	DEPTH IN FEET	LITHOLOGIC DESCRIPTION	USCS	GRAPHIC LOG	COMMENTS
1 CS	50		5	<p>CLAY WITH GRAVEL mostly clay, little fine to coarse gravel, few fine sand, high plasticity, dark gray (10YR 4/1), mottled with brown (10YR 5/3), moist, very stiff.</p> <p>CLAY mostly clay, trace fine sand, high plasticity, dark gray (10YR 4/1), mottled with brown (10YR 5/3), moist, very stiff.</p>	CL		Continuous sampling with 4-inch diameter casing from ground surface to terminus of soil boring, over-drilled with 6-inch diameter casing to total depth.
			10	Change to stiff at 10.0 feet.			
2 CS	100		15	Change to no sand, dark gray (10YR 4/1), very soft at 13.0 feet.			
3 CS	100		25		CL		
4 CS	100		35				
			40				

SOIL BORING WELL CONSTRUCTION LOG 231828.0003.GPJ TRC_CORP_GDT 7/14/16

Signature: 	Firm: TRC Environmental Corporation 1540 Eisenhower Place Ann Arbor, Michigan	734.971.7080 Fax 734.971.9022
Checked By: M. Powers		



SOIL BORING LOG

BORING NO. SB-16-01

SOIL BORING WELL CONSTRUCTION LOG 231828.0003.0000.GPJ TRC_CORP.GDT 7/14/16

SAMPLE		BLOW COUNTS	DEPTH IN FEET	LITHOLOGIC DESCRIPTION	USCS	GRAPHIC LOG	COMMENTS
NUMBER AND TYPE	RECOVERY (%)						
5 CS	100		45	CLAY mostly clay, high plasticity, dark gray (10YR 4/1), moist, very soft.			
6 ST	100		50		CL		
7 CS	100		55				
			60	CLAY WITH SAND mostly clay, little fine to coarse sand, high plasticity, dark gray (10YR 4/1), moist, very soft.	CL		
				CLAY mostly clay, high plasticity, dark gray (10YR 4/1), moist, very soft.	CL		
8 CS	100		65	SANDY SILT mostly silt, little to some fine to coarse sand, few clay, low plasticity, dark gray (10YR 4/1), moist, stiff.	ML		
			70	CLAY mostly clay, few fine to coarse gravel, dark gray (10YR 4/1), moist, medium stiff.			
				Change to no gravel, soft at 72.5 feet.			
9 CS	100		75				
			80	Change to few coarse gravel at 80.0 feet.			
10 CS	100		85		CL		
			90				
11 CS	100		95				
			100				



SOIL BORING LOG

BORING NO. SB-16-01

Page 3 of 3

SAMPLE		BLOW COUNTS	DEPTH IN FEET	LITHOLOGIC DESCRIPTION	USCS	GRAPHIC LOG	COMMENTS
NUMBER AND TYPE	RECOVERY (%)						
12 CS	100		105	CLAY mostly clay, few coarse gravel, dark gray (10YR 4/1), moist, soft.	CL		
13 CS	100		110				
14 CS	100		120				
15 CS	100		125	SILT mostly silt, few fine sand, non plastic, dark gray (10YR 4/1), moist.	ML		
16 CS	100		130				
			135	SHALE dark gray (10YR 4/1), dry.			
			140				
			145	End of boring at 150.0 feet below ground surface.			
			150				
			155				

SOIL BORING WELL CONSTRUCTION LOG 231828.0003.0000.GPJ TRC CORP.GDT 7/14/16

APPENDIX E – 2020 BORING LOGS

Boring B-1

Drilling Start Date:	12/8/2020	Boring Depth (ft):	100
Drilling End Date:	12/9/2020	Boring Diameter (in.)	4.25
Drilling Company:	Cascade Drilling	Sampling Method(s):	Shelby Tube, Grab Sample
Drilling Method:	Sonic	GW During Drilling (ft bgs):	-
Drilling Equipment:	600T	GW After Drilling (ft bgs):	-
Driller Name:	Joe Lary III	Ground Surface Elev. (ft):	592.8
Logged By:	Brian Ares	Northing, Easting (MI State Plane):	471073.109 13626167.862

DEPTH (ft)	ELEVATION (ft)	RECOVERY (ft.)	SAMPLE	MATERIAL DESCRIPTION	PENETROMETER	REMARKS
0	592.8			Lean CLAY - brown, hard, dry	4.5	Gravel road at surface
		6/7'	B-1-1 (3')			
5	587.8		B-1-2 (6')	Gravelly SAND - brown, poorly graded, fine gravel, coarse sand, silt, dry		
		100%	B-1-ST-1	Lean CLAY - brown, hard, dry		
10	582.8	3/3'	B-1-3 (10')	Same as above	4.5	
		6/7'	B-1-4 (15')	Very stiff from 14 to 16 ft.	2.5	
				Lean CLAY - Gray, soft - medium stiff, moist	0.5	
20	572.8	100%	B-1-ST-2			
		6/6'	B-1-5 (22')	Same as above	0.5	
25	567.8		B-1-6 (25')			

Boring B-1

Drilling Start Date:	12/8/2020	Boring Depth (ft):	100
Drilling End Date:	12/9/2020	Boring Diameter (in.)	4.25
Drilling Company:	Cascade Drilling	Sampling Method(s):	Shelby Tube, Grab Sample
Drilling Method:	Sonic	GW During Drilling (ft bgs):	-
Drilling Equipment:	600T	GW After Drilling (ft bgs):	-
Driller Name:	Joe Lary III	Ground Surface Elev. (ft):	592.8
Logged By:	Brian Ares	Northing, Easting (MI State Plane):	471073.109 13626167.862

DEPTH (ft)	ELEVATION (ft)	RECOVERY (ft.)	SAMPLE	MATERIAL DESCRIPTION	PENETROMETER	REMARKS
30	562.8	4/9'	B-1-7 (34')	Lean CLAY - Gray, soft - medium stiff, moist	< 0.5	
35	557.8	75%	B-1-ST-3		< 0.5	
40	552.8	4/8'	B-1-8 (40')	Same as above		
45	547.8	2/4'	B-1-9 (48')	Same as above	< 0.5	

Boring B-1

Drilling Start Date:	12/8/2020	Boring Depth (ft):	100
Drilling End Date:	12/9/2020	Boring Diameter (in.)	4.25
Drilling Company:	Cascade Drilling	Sampling Method(s):	Shelby Tube, Grab Sample
Drilling Method:	Sonic	GW During Drilling (ft bgs):	-
Drilling Equipment:	600T	GW After Drilling (ft bgs):	-
Driller Name:	Joe Lary III	Ground Surface Elev. (ft):	592.8
Logged By:	Brian Ares	Northing, Easting (MI State Plane):	471073.109 13626167.862

DEPTH (ft)	ELEVATION (ft)	RECOVERY (ft.)	SAMPLE	MATERIAL DESCRIPTION	PENETROMETER	REMARKS
50	542.8	4'7'	B-1-10 (52')	Lean CLAY - Gray, soft - medium stiff, moist	< 0.5	
55	537.8		B-1-ST-4			
60	532.8	50%	B-1-11 (59')	Same as above	0.5	
		6'6'	B-1-12 (63')	Same as above	0.5	
65	527.8					
70	522.8	2'10'	B-1-13 (74')	Consistency increases to stiff	1.0	
75	517.8					
		1'5'	B-1-14 (80')	Lean CLAYwith Sand - Gray, medium stiff - stiff, moist	0.5	
						1.5

Boring B-1					
Drilling Start Date:	12/8/2020	Boring Depth (ft):	100		
Drilling End Date:	12/9/2020	Boring Diameter (in.)	4.25		
Drilling Company:	Cascade Drilling	Sampling Method(s):	Shelby Tube, Grab Sample		
Drilling Method:	Sonic	GW During Drilling (ft bgs):	-		
Drilling Equipment:	600T	GW After Drilling (ft bgs):	-		
Driller Name:	Joe Lary III	Ground Surface Elev. (ft):	592.8		
Logged By:	Brian Ares	Northing, Easting (MI State Plane):	471073.109	13626167.862	

DEPTH (ft)	ELEVATION (ft)	RECOVERY (ft.)	SAMPLE	MATERIAL DESCRIPTION	PENETROMETER	REMARKS
80	512.8	25%	B-1-ST-5	Lean CLAY with Sand - Gray, medium stiff - stiff, moist		
			B-1-15 (82')	Becomes very stiff, trace coarse-fine gravel	2.0	
85	507.8	3/6'	B-1-16 (85')			
			B-1-17 (87')	Becomes stiff, no gravel	1.5	
90	502.8	2/8'			1	
			B-1-18 (94')		1	
95	497.8	0%				Shelby tube sample attempted, near zero recovery
		100%	B-1-ST-6			Borehole grouted with grout mixture - Grout 20% solids Pumpable Bentonite
100	492.8			Boring Terminated @ 100'		

Boring B-2					
Drilling Start Date:	12/9/2020	Boring Depth (ft):	99		
Drilling End Date:	12/10/2020	Boring Diameter (in.)	4.25		
Drilling Company:	Cascade Drilling	Sampling Method(s):	Shelby Tube, Grab Sample		
Drilling Method:	Sonic	GW During Drilling (ft bgs):	-		
Drilling Equipment:	600T	GW After Drilling (ft bgs):	-		
Driller Name:	Joe Lary III	Ground Surface Elev. (ft):	592.0		
Logged By:	Brian Ares	Northing, Easting (MI State Plane)	470971.736	13625830.745	

DEPTH (ft)	ELEVATION (ft)	RECOVERY (ft.)	SAMPLE	MATERIAL DESCRIPTION	PENETROMETER	REMARKS
0	592.0	1/1'	B-2-1 (1')	Fat CLAY - brown, hard, some fine gravel and coarse sand, dry	4.5+	Gravel road at surface
		100%	B-2-ST-1			
				Becomes lean	4.5	
5	587.0	4/4'	B-2-2 (5')		4.5	
		100%	B-2-ST-2			
				Same as above		
10	582.0	3/3'	B-2-3 (10')			
			B-2-4 (12')	Lean CLAY - gray, very stiff, dry	2.0	
15	577.0	8/8'				
			B-2-5 (18')			
20	572.0			Becomes soft - medium stiff, moist	0.5	
		7/7'	B-2-6 (24')		0.5	
25	567.0				0.5	
		100%	B-2-ST-3			

Boring B-2					
Drilling Start Date:	12/9/2020	Boring Depth (ft):	99		
Drilling End Date:	12/10/2020	Boring Diameter (in.)	4.25		
Drilling Company:	Cascade Drilling	Sampling Method(s):	Shelby Tube, Grab Sample		
Drilling Method:	Sonic	GW During Drilling (ft bgs):	-		
Drilling Equipment:	600T	GW After Drilling (ft bgs):	-		
Driller Name:	Joe Lary III	Ground Surface Elev. (ft):	592.0		
Logged By:	Brian Ares	Northing, Easting (MI State Plane)	470971.736	13625830.745	

DEPTH (ft)	ELEVATION (ft)	RECOVERY (ft.)	SAMPLE	MATERIAL DESCRIPTION	PENETROMETER	REMARKS
30	562.0	8'8"	B-2-7 (32')	Lean CLAY - gray, soft, wet	< 0.5	
35	557.0				< 0.5	
40	552.0	10'10"	B-2-8 (40')	Becomes moist	< 0.5	
45	547.0				< 0.5	
			B-2-9 (46')	Becomes soft-stiff	1.0	
		100%	B-2-ST-4		< 0.5	
50	542.0	4'4"	B-2-10 (50')		1.0	
					0.5	

Boring B-2					
Drilling Start Date:	12/9/2020	Boring Depth (ft):	99		
Drilling End Date:	12/10/2020	Boring Diameter (in.)	4.25		
Drilling Company:	Cascade Drilling	Sampling Method(s):	Shelby Tube, Grab Sample		
Drilling Method:	Sonic	GW During Drilling (ft bgs):	-		
Drilling Equipment:	600T	GW After Drilling (ft bgs):	-		
Driller Name:	Joe Lary III	Ground Surface Elev. (ft):	592.0		
Logged By:	Brian Ares	Northing, Easting (MI State Plane)	470971.736	13625830.745	

DEPTH (ft)	ELEVATION (ft)	RECOVERY (ft.)	SAMPLE	MATERIAL DESCRIPTION	PENETROMETER	REMARKS
55	537.0	8'8"	B-2-11 (54')	Sandy Lean CLAY - gray, stiff, moist	1.0	
60	532.0		B-2-12 (60')	Same as above	1.0	
65	527.0	6'6"	B-2-13 (64')		1.0	
		100%	B-2-ST-5		1.5	
70	522.0	6'6"	B-2-14 (70')	Some coarse gravel (69' - 74')	1.0 1.5	
75	517.0		B-2-15 (75')	Lean CLAY with Sand - gray, stiff, moist	1.0	
80	512.0	8'8"	B-2-16 (80')		1.0	

Boring B-2					
Drilling Start Date:	12/9/2020	Boring Depth (ft):	99		
Drilling End Date:	12/10/2020	Boring Diameter (in.)	4.25		
Drilling Company:	Cascade Drilling	Sampling Method(s):	Shelby Tube, Grab Sample		
Drilling Method:	Sonic	GW During Drilling (ft bgs):	-		
Drilling Equipment:	600T	GW After Drilling (ft bgs):	-		
Driller Name:	Joe Lary III	Ground Surface Elev. (ft):	592.0		
Logged By:	Brian Ares	Northing, Easting (MI State Plane)	470971.736	13625830.745	

DEPTH (ft)	ELEVATION (ft)	RECOVERY (ft.)	SAMPLE	MATERIAL DESCRIPTION	PENETROMETER	REMARKS
85	507.0	4'4'	B-2-17 (86')	Lean CLAY with Sand - gray, stiff, moist	1.0	
		100%	B-2-ST-6		1.0	
90	502.0	5'5'	B-2-18 (91')	Becomes very stiff	2	
					2	
95	497.0	3'3'	B-2-19 (96')	Same as above	2.5	
					2.5	
99	493.0	100%	B-2-ST-7	Boring Terminated @ 99'		

Boring B-3				
Drilling Start Date:	12/10/2020	Boring Depth (ft):	99	
Drilling End Date:	12/11/2020	Boring Diameter (in.):	4.25	
Drilling Company:	Cascade Drilling	Sampling Method(s):	Shelby Tube, Grab Sample	
Drilling Method:	Sonic	GW During Drilling (ft bgs):	-	
Drilling Equipment:	600T	GW After Drilling (ft bgs):	-	
Driller Name:	Joe Lary III	Ground Surface Elev. (ft):	592.0	
Logged By:	Brian Ares	Northing, Easting (MI State Plane)	471223.201	13625788.558

DEPTH (ft)	ELEVATION (ft)	RECOVERY (ft.)	SAMPLE	MATERIAL DESCRIPTION	PENETROMETER	REMARKS
0	592.0	1/1'	B-3-1 (1')	GRAVELY SAND - tan, well graded, mostly coarse to fine gravel and coarse sand		Gravel road at surface
		100%	B-3-ST-1			
5	587.0	4/4'	B-3-2 (5')	Lean CLAY - brown, trace fine gravel, hard, dry	4.5	
		100%	B-3-ST-2			
10	582.0	7/7'	B-3-3 (10')	Becomes very stiff	2.5	
			Becomes medium stiff	2.5		
			0.5			
			0.5			
15	577.0		B-3-4 (15')	Transition to moist	0.5	
20	572.0	6/6'	B-3-5 (20')		0.5	
					0.5	
					0.5	
25	567.0	5/5'	B-3-6 (25')		0.5	

Boring B-3

Drilling Start Date:	12/10/2020	Boring Depth (ft):	99
Drilling End Date:	12/11/2020	Boring Diameter (in.):	4.25
Drilling Company:	Cascade Drilling	Sampling Method(s):	Shelby Tube, Grab Sample
Drilling Method:	Sonic	GW During Drilling (ft bgs):	-
Drilling Equipment:	600T	GW After Drilling (ft bgs):	-
Driller Name:	Joe Lary III	Ground Surface Elev. (ft):	592.0
Logged By:	Brian Ares	Northing, Easting (MI State Plane)	471223.201 13625788.558

DEPTH (ft)	ELEVATION (ft)	RECOVERY (ft.)	SAMPLE	MATERIAL DESCRIPTION	PENETROMETER	REMARKS
		100%	B-3-ST-3	Lean CLAY - gray, medium stiff, moist		
30	562.0	4 1/4'	B-3-7 (30')		0.5	
					0.5	
				Same as above	0.5	
35	557.0	8 7/8'	B-3-8 (35')		0.5	
					0.5	
40	552.0		B-3-9 (40')		0.5	
				Same as above	0.5	
		6 1/6'	B-3-10 (45')		0.5	
45	547.0				0.5	
					0.5	
		100%	B-3-ST-4			
				Same as above	0.5	
50	542.0	7 1/7'	B-3-11 (50')		0.5	
					0.5	
					0.5	
55	537.0		B-3-12 (55')		0.5	
					0.5	

Boring B-3

Drilling Start Date:	12/10/2020	Boring Depth (ft):	99
Drilling End Date:	12/11/2020	Boring Diameter (in.):	4.25
Drilling Company:	Cascade Drilling	Sampling Method(s):	Shelby Tube, Grab Sample
Drilling Method:	Sonic	GW During Drilling (ft bgs):	-
Drilling Equipment:	600T	GW After Drilling (ft bgs):	-
Driller Name:	Joe Lary III	Ground Surface Elev. (ft):	592.0
Logged By:	Brian Ares	Northing, Easting (MI State Plane)	471223.201 13625788.558

DEPTH (ft)	ELEVATION (ft)	RECOVERY (ft.)	SAMPLE	MATERIAL DESCRIPTION	PENETROMETER	REMARKS
60	532.0	8/8'	B-3-13 (60')	CLAY - gray, medium stiff, moist	0.5	
					0.5	
					0.5	
65	527.0	4/4'	B-3-14 (67')	Sandy Lean CLAY - gray, very fine - fine sand and silt, some fine gravel, moderate grading, moist		
		0%				Shelby tube sample attempted - no recovery
70	522.0	3/3'	B-3-15 (70')	Lean CLAY with Sand - gray, stiff - very stiff, moist	2.0	
					1.5	
75	517.0	4/4'	B-3-16 (75')	Same as above	1.5	
		100%	B-3-ST-5			

Boring B-3

Drilling Start Date:	12/10/2020	Boring Depth (ft):	99
Drilling End Date:	12/11/2020	Boring Diameter (in.):	4.25
Drilling Company:	Cascade Drilling	Sampling Method(s):	Shelby Tube, Grab Sample
Drilling Method:	Sonic	GW During Drilling (ft bgs):	-
Drilling Equipment:	600T	GW After Drilling (ft bgs):	-
Driller Name:	Joe Lary III	Ground Surface Elev. (ft):	592.0
Logged By:	Brian Ares	Northing, Easting (MI State Plane)	471223.201 13625788.558

DEPTH (ft)	ELEVATION (ft)	RECOVERY (ft.)	SAMPLE	MATERIAL DESCRIPTION	PENETROMETER	REMARKS
80	512.0	9'9"	B-3-17 (80')	Lean CLAY with Sand - gray, stiff - very stiff, moist	1.5	
					1.5	
					2.0	
85	507.0	5'5"	B-3-18 (85')	Same as above	1.5	
					2.0	
90	502.0	4'4"	B-3-19 (90')	Same as above	2.0	
					2.0	
95	497.0	100%	B-3-20 (95')	Boring Terminated @ 99'	2.0	
					1.5	
99	493.0		B-3-ST-6			Borehole grouted with grout mixture - Grout 20% solids Pumpable Bentonite

Boring B-4			
Drilling Start Date:	12/11/2020	Boring Depth (ft):	99
Drilling End Date:	12/14/2020	Boring Diameter (in.)	4.25
Drilling Company:	Cascade Drilling	Sampling Method(s):	Shelby Tube, Grab Sample
Drilling Method:	Sonic	GW During Drilling (ft bgs):	-
Drilling Equipment:	600T	GW After Drilling (ft bgs):	-
Driller Name:	Joe Lary III	Ground Surface Elev. (ft):	586.0
Logged By:	Brian Ares	Northing, Easting (MI State Plane)	470431.940 13626386.593

DEPTH (ft)	ELEVATION (ft)	RECOVERY (ft.)	SAMPLE	MATERIAL DESCRIPTION	PENETROMETER	REMARKS
0	586.0	0/1'		Lean CLAY - brown, very stiff, dry		
		0%				Shelby tube sample attempted from 1-3', no recovery
				Same as above	2.5	Very little recovery. This assessment comes from verbal description from drilling crew
5	581.0	0.5/4'				
		100%	B-4-ST-1			
				Becomes hard	4.5	
10	576.0		B-4-1 (10)	Lean CLAY - gray, stiff, dry	1	
		6/6'	B-4-2 (12)		1	
				Becomes medium stiff, moist	0.5	
15	571.0		B-4-3 (15)		0.5	
		6/6'			0.5	
					0.5	
20	566.0		B-4-4 (20)			
				Same as above	0.5	
		6/6'			0.5	
25	561.0		B-4-5 (25)		0.5	

Boring B-4			
Drilling Start Date:	12/11/2020	Boring Depth (ft):	99
Drilling End Date:	12/14/2020	Boring Diameter (in.)	4.25
Drilling Company:	Cascade Drilling	Sampling Method(s):	Shelby Tube, Grab Sample
Drilling Method:	Sonic	GW During Drilling (ft bgs):	-
Drilling Equipment:	600T	GW After Drilling (ft bgs):	-
Driller Name:	Joe Lary III	Ground Surface Elev. (ft):	586.0
Logged By:	Brian Ares	Northing, Easting (MI State Plane)	470431.940 13626386.593

DEPTH (ft)	ELEVATION (ft)	RECOVERY (ft.)	SAMPLE	MATERIAL DESCRIPTION	PENETROMETER	REMARKS
		100%	B-4-ST-2	Lean CLAY - gray, medium stiff, moist		
30	556.0		B-4-6 (30)	Same as above	0.5	
		6'6"	B-4-7 (34)		0.5	
					0.5	
35	551.0		B-4-8 (36)	SILTY SAND - gray, mostly very fine - fine sand and silt, some fine gravel, well graded, moist		
		6'6"	B-4-9 (40)	Lean CLAY - gray, medium stiff, moist	0.5	
40	546.0			Same as above	0.5	
		6'6"	B-4-10 (45')		0.5	
45	541.0			Same as above		
		100%	B-4-ST-3			
50	536.0		B-4-11 (50')	Same as above	0.5	
		7'7"			0.5	
55	531.0		B-4-12 (55')		0.5	

Boring B-4			
Drilling Start Date:	12/11/2020	Boring Depth (ft):	99
Drilling End Date:	12/14/2020	Boring Diameter (in.)	4.25
Drilling Company:	Cascade Drilling	Sampling Method(s):	Shelby Tube, Grab Sample
Drilling Method:	Sonic	GW During Drilling (ft bgs):	-
Drilling Equipment:	600T	GW After Drilling (ft bgs):	-
Driller Name:	Joe Lary III	Ground Surface Elev. (ft):	586.0
Logged By:	Brian Ares	Northing, Easting (MI State Plane)	470431.940 13626386.593

DEPTH (ft)	ELEVATION (ft)	RECOVERY (ft.)	SAMPLE	MATERIAL DESCRIPTION	PENETROMETER	REMARKS
				Lean CLAY - gray, medium stiff, moist	0.5	
60	526.0	6'6"	B-4-13 (60')		0.5	
				Same as above	0.5	
65	521.0	5'5"	B-4-14 (65')		0.5	
		100%	B-4-ST-4			
70	516.0		B-4-15 (70')			
		8'8"		Same as above		
75	511.0		B-4-16 (75')	Lean CLAY with Sand - gray, stiff - very stiff, moist	1.5	
					1.5	
					2.0	
80	506.0	5'5"	B-4-17 (80')		2.0	

Boring B-4			
Drilling Start Date:	12/11/2020	Boring Depth (ft):	99
Drilling End Date:	12/14/2020	Boring Diameter (in.)	4.25
Drilling Company:	Cascade Drilling	Sampling Method(s):	Shelby Tube, Grab Sample
Drilling Method:	Sonic	GW During Drilling (ft bgs):	-
Drilling Equipment:	600T	GW After Drilling (ft bgs):	-
Driller Name:	Joe Lary III	Ground Surface Elev. (ft):	586.0
Logged By:	Brian Ares	Northing, Easting (MI State Plane)	470431.940 13626386.593

DEPTH (ft)	ELEVATION (ft)	RECOVERY (ft.)	SAMPLE	MATERIAL DESCRIPTION	PENETROMETER	REMARKS
85	501.0	5'5'	B-4-18 (85')	Lean CLAY with Sand - gray, stiff - very stiff, dry	1.5	
					2.0	
		100%	B-4-ST-5		1.0	
90	496.0	5'5'	B-4-19 (90')	Same as above	1.0	
					1.5	
95	491.0	3'3'	B-4-20 (95')	Same as above	1.5	
99	487.0	100%	B-4-ST-6	Boring Terminated @ 99'		Borehole grouted with grout mixture - Grout 20% solids Pumpable Bentonite

Boring B-5					
Drilling Start Date:	12/14/2020	Boring Depth (ft):	99		
Drilling End Date:	12/14/2020	Boring Diameter (in.):	4.25		
Drilling Company:	Cascade Drilling	Sampling Method(s):	Shelby Tube, Grab Sample		
Drilling Method:	Sonic	GW During Drilling (ft bgs):	-		
Drilling Equipment:	600T	GW After Drilling (ft bgs):	-		
Driller Name:	Joe Lary III	Ground Surface Elev. (ft):	591.3		
Logged By:	Sean Karoly	Northing, Easting (MI State Plane)	470218.324	13626779.118	

DEPTH (ft)	ELEVATION (ft)	RECOVERY (ft.)	SAMPLE	MATERIAL DESCRIPTION	PENETROMETER	REMARKS
0	591.3	0.75/1'		Lean CLAY - light brown, little gravel, little sand, hard, moist	4.0	
		50%	B-5-ST-1	Lean CLAY - gray, very stiff - hard, moist	2.0	
					3.5	
5	586.3	4/4'			> 4.5	
			B-5-1 (7')		2.5	
				Fat CLAY - gray to brown, some fine gravel, medium stiff - very stiff	0.5	
10	581.3	7/7'			0.5	
					1.0	
15	576.3		B-5-2 (14')		0.5	
		7/7'		Lean CLAY - gray, medium stiff, moist	0.5	
20	571.3				0.5	
			B-5-3 (21')		0.5	
				Same as above	0.5	
25	566.3				0.5	
					0.5	
		100%	B-5-ST-2		0.5	

Boring B-5			
Drilling Start Date:	12/14/2020	Boring Depth (ft):	99
Drilling End Date:	12/14/2020	Boring Diameter (in.)	4.25
Drilling Company:	Cascade Drilling	Sampling Method(s):	Shelby Tube, Grab Sample
Drilling Method:	Sonic	GW During Drilling (ft bgs):	-
Drilling Equipment:	600T	GW After Drilling (ft bgs):	-
Driller Name:	Joe Lary III	Ground Surface Elev. (ft):	591.3
Logged By:	Sean Karoly	Northing, Easting (MI State Plane)	470218.324 13626779.118

DEPTH (ft)	ELEVATION (ft)	RECOVERY (ft.)	SAMPLE	MATERIAL DESCRIPTION	PENETROMETER	REMARKS
30	561.3		B-5-4 (29')	Lean CLAY - gray, medium stiff - stiff, moist	1.0	
		7/7'	B-5-5 (32')		1.0	
35	556.3			Same as above	1.0	
		5/5'	B-5-6 (37')		0.5	
40	551.3			Same as above	1.0	
		6/6'	B-5-7 (42')		1.0	
45	546.3		B-5-8 (46')		1.0	
		100%	B-5-ST-3		1.0	
50	541.3			color transition to darker gray	0.5	
		4/4'				1 cm sand seam observed
			B-5-9 (52')	Becomes stiff	1.5	

Boring B-5				
Drilling Start Date:	12/14/2020	Boring Depth (ft):	99	
Drilling End Date:	12/14/2020	Boring Diameter (in.):	4.25	
Drilling Company:	Cascade Drilling	Sampling Method(s):	Shelby Tube, Grab Sample	
Drilling Method:	Sonic	GW During Drilling (ft bgs):	-	
Drilling Equipment:	600T	GW After Drilling (ft bgs):	-	
Driller Name:	Joe Lary III	Ground Surface Elev. (ft):	591.3	
Logged By:	Sean Karoly	Northing, Easting (MI State Plane)	470218.324	13626779.118

DEPTH (ft)	ELEVATION (ft)	RECOVERY (ft.)	SAMPLE	MATERIAL DESCRIPTION	PENETROMETER	REMARKS
55	536.3	8'8'	B-5-10 (57')	Lean CLAY - dark gray, medium stiff - stiff, moist	1.0	Some fine black gravel observed
				0.5		
60	531.3	6'6'	B-5-11 (62')	Lean CLAY with Sand - dark gray, trace fine and coarse gravel, medium stiff - stiff, moist	1.0	
				0.5		
				1.0		
65	526.3	100%	B-5-12 (66')		1.5	
				1.5		
			B-5-ST-4		1.0	
70	521.3	9'9'	B-5-13 (72')	Same as above	1.5	
				1.0		
75	516.3		B-5-14 (77')		1.0	
					1.5	

Boring B-5				
Drilling Start Date:	12/14/2020	Boring Depth (ft):	99	
Drilling End Date:	12/14/2020	Boring Diameter (in.)	4.25	
Drilling Company:	Cascade Drilling	Sampling Method(s):	Shelby Tube, Grab Sample	
Drilling Method:	Sonic	GW During Drilling (ft bgs):	-	
Drilling Equipment:	600T	GW After Drilling (ft bgs):	-	
Driller Name:	Joe Lary III	Ground Surface Elev. (ft):	591.3	
Logged By:	Sean Karoly	Northing, Easting (MI State Plane)	470218.324	13626779.118

DEPTH (ft)	ELEVATION (ft)	RECOVERY (ft.)	SAMPLE	MATERIAL DESCRIPTION	PENETROMETER	REMARKS	
80	511.3	9/9'	B-5-15 (82')	Lean CLAY with Sand - dark gray, trace fine and coarse gravel, stiff - very stiff, moist	1.0		
					2.0		
85	506.3	100%	B-5-16 (86')		1.0		
			B-5-ST-5		1.5		
90	501.3	8/8'	B-5-17 (92')		Same as above		2.5
					2.5		
95	496.3		B-5-18 (96')	2.0			
		100%	B-5-ST-6 B-5-19 (99')	Boring Terminated @ 99'	2.0	Borehole grouted with grout mixture - Grout 20% solids Pumpable Bentonite	
99	492.3						

Boring B-6				
Drilling Start Date:	12/15/2020	Boring Depth (ft):	99	
Drilling End Date:	12/15/2020	Boring Diameter (in.):	4.25	
Drilling Company:	Cascade Drilling	Sampling Method(s):	Shelby Tube, Grab Sample	
Drilling Method:	Sonic	GW During Drilling (ft bgs):	-	
Drilling Equipment:	600T	GW After Drilling (ft bgs):	-	
Driller Name:	Joe Lary III	Ground Surface Elev. (ft):	589.3	
Logged By:	Sean Karoly	Northing, Easting (MI State Plane):	470018.376	13626852.319

DEPTH (ft)	ELEVATION (ft)	RECOVERY (ft.)	SAMPLE	MATERIAL DESCRIPTION	PENETROMETER	REMARKS
0	589.3	1'1'		GRAVEL - light gray to gray, mostly coarse and fine gravel and sand		
		50%	B-6-ST-1	Lean CLAY - gray to brown, trace gravel, very stiff - hard, moist		
5	584.3	3.5'4'	B-6-1 (5')		3.0 4.5 3.5 3.0	
		100%	B-6-ST-2	Lean CLAY - gray, very stiff, moist	3.0	
10	579.3	7'7'	B-6-2 (10')	Becomes medium stiff - stiff	3.0 1.0 0.5	
15	574.3		B-6-3 (15')	Same as above	0.5	
		4'4'			0.5	
20	569.3		B-6-4 (20')	Same as above	0.5	
		7'7'			1.0 0.5	
25	564.3		B-6-5 (25')		0.5 1.0	

Boring B-6					
Drilling Start Date:	12/15/2020	Boring Depth (ft):	99		
Drilling End Date:	12/15/2020	Boring Diameter (in.)	4.25		
Drilling Company:	Cascade Drilling	Sampling Method(s):	Shelby Tube, Grab Sample		
Drilling Method:	Sonic	GW During Drilling (ft bgs):	-		
Drilling Equipment:	600T	GW After Drilling (ft bgs):	-		
Driller Name:	Joe Lary III	Ground Surface Elev. (ft):	589.3		
Logged By:	Sean Karoly	Northing, Easting (MI State Plane):	470018.376	13626852.319	

DEPTH (ft)	ELEVATION (ft)	RECOVERY (ft.)	SAMPLE	MATERIAL DESCRIPTION	PENETROMETER	REMARKS
		100%	B-6-ST-3	Lean CLAY - gray, medium stiff - stiff, moist		
30	559.3		B-6-6 (30')	Same as above	0.5	
		9/9'			0.5	
35	554.3		B-6-7 (35')		1.0	
					0.5	
40	549.3		B-6-8 (40')	Same as above	0.5	
		9/9'			0.5	
45	544.3		B-6-9 (45')		0.5	
					1.0	
		100%	B-6-ST-4			

Boring B-6					
Drilling Start Date:	12/15/2020	Boring Depth (ft):	99		
Drilling End Date:	12/15/2020	Boring Diameter (in.):	4.25		
Drilling Company:	Cascade Drilling	Sampling Method(s):	Shelby Tube, Grab Sample		
Drilling Method:	Sonic	GW During Drilling (ft bgs):	-		
Drilling Equipment:	600T	GW After Drilling (ft bgs):	-		
Driller Name:	Joe Lary III	Ground Surface Elev. (ft):	589.3		
Logged By:	Sean Karoly	Northing, Easting (MI State Plane):	470018.376	13626852.319	

DEPTH (ft)	ELEVATION (ft)	RECOVERY (ft.)	SAMPLE	MATERIAL DESCRIPTION	PENETROMETER	REMARKS
50	539.3	9/9'	B-6-10 (50')	Lean CLAY - gray, medium stiff - stiff, moist Color transition to darker gray	1.0	
55	534.3	9/9'	B-6-11 (55')		1.0	
					Lean CLAY with Sand - gray, stiff, moist	
60	529.3	9/9'	B-6-12 (60')		1.0	
					Same as above	
65	524.3	100%	B-6-13 (65')		1.5	
			B-6-ST-5			
70	519.3	9/9'	B-6-14 (70')		1.0	
					Same as above	
75	514.3	9/9'	B-6-15 (75')		1.5	

Boring B-6					
Drilling Start Date:	12/15/2020	Boring Depth (ft):	99		
Drilling End Date:	12/15/2020	Boring Diameter (in.)	4.25		
Drilling Company:	Cascade Drilling	Sampling Method(s):	Shelby Tube, Grab Sample		
Drilling Method:	Sonic	GW During Drilling (ft bgs):	-		
Drilling Equipment:	600T	GW After Drilling (ft bgs):	-		
Driller Name:	Joe Lary III	Ground Surface Elev. (ft):	589.3		
Logged By:	Sean Karoly	Northing, Easting (MI State Plane):	470018.376	13626852.319	

DEPTH (ft)	ELEVATION (ft)	RECOVERY (ft.)	SAMPLE	MATERIAL DESCRIPTION	PENETROMETER	REMARKS	
80	509.3	9'9"	B-6-16 (80')	Lean CLAY with Sand - gray, stiff, moist	1.5		
85	504.3		B-6-17 (85')	Becomes very stiff	2.0		
		100%	B-6-ST-6				
90	499.3	8'8"	B-6-18 (90')	Becomes stiff	1.5		
95	494.3		B-6-19 (95')	Some gravel observed	1.5		
99	490.3	100%	B-6-ST-7 B-6-20 (99')	Boring Terminated @ 99'			Borehole grouted with grout mixture - Grout 20% solids Pumpable Bentonite

**APPENDIX F – 1970s LABORATORY TEST
RESULTS**

4-9-5-2

SUBSURFACE INVESTIGATION AND FOUNDATION REPORT

THE DETROIT



EDISON COMPANY

BELLE RIVER UNITS 1 & 2 JOB 10539 VOLUME 2 OF 2

GEOLOGY AND SOIL PROPERTIES

P. H. COOK

AUG 31 1978

AUGUST 1976

**BECHTEL
ANN ARBOR, MICHIGAN**



TABLE OF CONTENTS

VOLUME 2 OF 2

	<u>Page</u>
APPENDIX C GOLDBERG-ZOINO LABORATORY TEST RESULTS	
Summary of Laboratory Test Results	C-1
Unconfined Compression Tests	C-271
Laboratory Vane Shear Tests	C-343
Unconsolidated-Undrained Triaxial Compression Tests	C-355
Consolidated-Undrained Triaxial Compression Tests	C-385
Consolidated-Drained Triaxial Compression Test	C-453
Consolidation Tests	C-455
Grain Size Distribution and Plasticity Chart	C-597
Permeability Tests	C-645
Compaction - Gradation Tests	C-655
 APPENDIX D SOIL TESTING, RECLAIM HOPPER INVESTIGATION	 D-1

Appendix C

BORING SAMPLE	IDENTIFICATION		TEST NO.	PROPERTIES			STRENGTH		CONSOLIDATION		OTHER TESTS AND REMARKS
	SOIL DESCRIPTION	DEPTH (FEET)		NAT. WATER CONTENT (%)	ATTERBERG LIMITS w _L w _P	DRY UNIT WEIGHT (PCF)	TEST TYPE	€ %	MAX. SHEAR STRESS (PSF)	e ₀	
B7/28	Jar Sample Clayey SILT; dark gray, low plasticity (CL-ML)	129.5 to 131.0	64								
			H64.1								See plot
B7/30	Jar Sample Silty CLAY; sandy, dark gray, low plasticity (CL-ML)	138.88 to 140.33	65								
			S/H								
			65.1								See plot

PROJECT: BELLE RIVER PLANT UNITS I & II

FILE NO. 1255

DATE: Jan. 1974

SHEET 1 OF

SUMMARY OF LABORATORY TEST RESULTS

BORING SAMPLE	IDENTIFICATION		TEST NO.	PROPERTIES			STRENGTH		CONSOLIDATION		OTHER TESTS AND REMARKS
	SOIL DESCRIPTION	DEPTH (FEET)		NAT. WATER CONTENT (%)	ATTERBERG LIMITS w_L w_p	DRY UNIT WEIGHT (PCF)	TEST TYPE	ϵ %	MAX. SHEAR STRESS (PSF)	e_0	
B10/30	Jar Sample	141.3	66								
	Silty CLAY; sandy, dark gray, low plasticity (CL-ML)		SH 66.1								See plot

BORING SAMPLE	IDENTIFICATION		TEST NO.	PROPERTIES			STRENGTH		CONSOLIDATION		OTHER TESTS AND REMARKS
				NAT. WATER CONTENT (%)	ATTERBERG LIMITS w _L w _P	DRY UNIT WEIGHT (PCF)	TEST TYPE	ε %	MAX. SHEAR STRESS (PSF)	e ₀	
15/2	1.6' Recovery; say 3.0' to 4.6' depth	3.0-5.0	119								
		3.3-3.6	Saved								
	Silty CLAY, greyish brown, very stiff consistency, moderate to high plasticity (CL)	3.6-3.7	W119.1	25.5		97					
		3.7	TV								TV=1.00tsf
		3.7-4.1	W119.01	25.4		101		UU	8.0	2386	σ _c =475 psf
		3.7-4.1	L119.1	23.6	45	21					
		4.1-4.2	W119.2	25.3		97					
		4.2	TV								TV=1.20tsf
		4.2-4.5	Saved								

PROJECT: BELLE RIVER PLANT UNITS I & II		FILE NO. 1255										
TABLE SUMMARY OF LABORATORY TEST RESULTS		DATE July 1974										
IDENTIFICATION		SHEET OF										
BORING SAMPLE	SOIL DESCRIPTION	DEPTH (FEET)	TEST NO.	PROPERTIES			STRENGTH			CONSOLIDATION		OTHER TESTS AND REMARKS
				NAT. WATER CONTENT (%)	ATTERBERG LIMITS wL wP	DRY UNIT WEIGHT (PCF)	TEST TYPE	ε %	MAX. SHEAR STRESS (PSF)	e ₀	C _c	
15/4	1.3' Recovery: say 8.0' to 9.3' depth	8.0-10.0	120									
		8.1-8.4	saved									
	Silty CLAY, dark gray, stiff consistency, moderate to highly plastic (CL)	8.4	TV									TV=0.70 tsf
		8.4-8.6	W120.1			90						
		8.6-8.9	U120.1			93		U	6.0	1257		
		8.6-8.9	L120.1			44	19					
	Sample includes about 5% fine to coarse Sand grains (subrounded to subangular in shape)	8.9	TV									TV=0.61 tsf
		9.0-9.4	saved									

PROJECT: BELLE RIVER PLANT UNITS I & II

FILE NO. 1255

DATE July 1974

TABLE SUMMARY OF LABORATORY TEST RESULTS

SHEET OF

BORING SAMPLE	IDENTIFICATION		TEST NO.	PROPERTIES			STRENGTH		CONSOLIDATION		OTHER TESTS AND REMARKS	
	SOIL DESCRIPTION	DEPTH (FEET)		NAT. WATER CONTENT (%)	ATTERBERG LIMITS w _L w _P	DRY UNIT WEIGHT (PCF)	TEST TYPE	ε %	MAX. SHEAR STRESS (PSF)	e _o		c _c
15/6	1.2' Recovery; say 18.0' to 19.2' depth Silty CLAY, dark grey, soft to firm consistency, moderate to highly plastic (CL)	18.0-20.0	—									
		18.1-18.4	L12L.1	35.0	42	20						
		18.1-18.4	J12L.1	34.1			87	U	15.0	508		@20% strain s= 546 psf
		18.4-18.5	W12L.1	36.1			83					
		18.5	TV									TV=0.28tsf
		18.8-18.9	W12L.2	36.3			83					
		18.9	TV									TV=0.22tsf

PROJECT: BELLE RIVER PLANT UNITS I & II		FILE NO. 1255										
TABLE SUMMARY OF LABORATORY TEST RESULTS		DATE July 1974										
IDENTIFICATION		SHEET OF										
BORING SAMPLE	SOIL DESCRIPTION	DEPTH (FEET)	TEST NO.	PROPERTIES			STRENGTH		CONSOLIDATION		OTHER TESTS AND REMARKS	
				NAT. WATER CONTENT (%)	ATTERBERG LIMITS w _L w _p	DRY UNIT WEIGHT (PCF)	TEST TYPE	ε %	MAX. SHEAR STRESS (PSF)	e ₀		c _c
15/14	2.5' Recovery; say 58.0' to 60.5' depth Silty CLAY, dark grey, firm to stiff consistency, moderately plastic (CL) Sample includes about 15% fine to coarse Sand grains (subrounded to subangular in shape) Note: Void occurs along outside edge of upper 1.3' of sample	58.0 - 60.5	125									
		58.3 - 58.7	Saved									
		58.7 - 58.9	W125.1	23.4								
		58.9	TV									TV = 0.46tsf
		58.9 - 59.2	Saved									
		59.2 - 59.6	U125.1	22.5	104	U	15.2	1067				@ 20% strain s = 1260 psf
		59.2 - 59.6	L125.1	22.6	34	18						
		59.6 - 59.7	W125.2	22.4	103							
		59.7	TV									TV = 0.61tsf
		60.0 - 60.4	Saved									

PROJECT: BELLE RIVER PLANT UNITS I & II		FILE NO. 1255										
TABLE SUMMARY OF LABORATORY TEST RESULTS		DATE July 1974										
IDENTIFICATION		SHEET _____ OF _____										
BORING SAMPLE	SOIL DESCRIPTION	DEPTH (FEET)	TEST NO.	PROPERTIES			STRENGTH		CONSOLIDATION		OTHER TESTS AND REMARKS	
				NAT. WATER CONTENT (%)	ATTERBERG LIMITS w _L w _p	DRY UNIT WEIGHT (PCF)	TEST TYPE	ε %	MAX. SHEAR STRESS (PSF)	e ₀		c _c
18/3	2.4' Recovery; say 20.0' to 22.4' depth Silty CLAY, dark grey, soft to firm consistency, moderate to high plasticity (CL) Sample includes about 10% fine to coarse Sand and fine gravel size particles (sub-rounded to subangular in shape)	20.0 - 22.5	—									
		20.1 - 20.4	176									
		20.4 - 20.6	WI76.1	39.1	82							
		20.6	TV									TV=0.26tsf
		20.6 - 20.9	WI76.1	39.9	83							σ _c -2448psf
		20.6 - 20.9	L176.1	38.3	44	21						
		20.9 - 21.2	Saved									
		21.2 - 21.4	WI76.2	32.1	88							
		21.4	TV									TV=0.26tsf
		21.7 - 22.0	Saved									
		22.0 - 22.4	Saved									

PROJECT: BELLE RIVER PLANT UNITS I & II
 TABLE SUMMARY OF LABORATORY TEST RESULTS

FILE NO. 1255
 DATE April 1974
 SHEET OF

IDENTIFICATION		TEST NO.	PROPERTIES			STRENGTH		CONSOLIDATION		OTHER TESTS AND REMARKS	
BORING SAMPLE	SOIL DESCRIPTION		NAT. WATER CONTENT (%)	ATTERBERG LIMITS w _L w _P	DRY UNIT WEIGHT (PCF)	TEST TYPE	ε %	MAX. SHEAR STRESS (PSF)	e ₀		c _c
18/6	Silty CLAY; gray, firm to stiff consistency, moderately plastic (CL) Sample includes about 5% coarse sand and fine gravel size particles (subrounded to subangular in shape)	—									
		50.0 to 52.5	345								
		50.3 to 50.5	W345.1	35.8							
		50.5	TV								TV=0.38tsf
		50.5 to 50.8	345.1								
		51.2 to 51.4	W345.1	24.6	98						
		51.4	TV								TV=0.50tsf
		51.4 to 51.7	1345.0.1	31.0	92	UU	3.0	827			
		51.4 to 51.7	1345.1	29.6	39						

PROJECT: BELLE RIVER PLANT UNITS I & II

FILE NO. 1255

DATE July 1974

SUMMARY OF LABORATORY TEST RESULTS

SHEET ___ OF ___

BORING SAMPLE	IDENTIFICATION		TEST NO.	PROPERTIES			STRENGTH		CONSOLIDATION		OTHER TESTS AND REMARKS	
	SOIL DESCRIPTION	DEPTH (FEET)		NAT. WATER CONTENT (%)	ATTERBERG LIMITS w _L w _P	DRY UNIT WEIGHT (PCF)	TEST TYPE	ε %	MAX. SHEAR STRESS (PSF)	e _o		c _c
18/7	2.4' Recovery; say 60.0' to 62.4' depth Silty CLAY, Sandy, dark gray, firm to stiff consistency, moderate plasticity (CL) Sample includes about 30% fine to coarse SAND and fine gravel size particles (subrounded to subangular in shape)	60.0										
		62.5	346									
		60.6	TV									TV=0.46 tsf
		60.6-61.0	saved									
		61.0	L346.1	20.2	26	16						
		61.3										
		61.4-61.6	W346.2	19.9			109					
		61.6	TV									TV=0.65 tsf
		61.6-62.0	saved									

PROJECT: BELLE RIVER PLANT UNITS I & II

FILE NO. 1255

TABLE SUMMARY OF LABORATORY TEST RESULTS

DATE _____ SHEET _____ OF _____

BORING SAMPLE	IDENTIFICATION		DEPTH (FEET)	TEST NO.	PROPERTIES			STRENGTH		CONSOLIDATION		OTHER TESTS AND REMARKS
					NAT. WATER CONTENT (%)	ATTERBERG LIMITS w _L w _P	DRY UNIT WEIGHT (PCF)	TEST TYPE	ε %	MAX. SHEAR STRESS (PSF)	e ₀	
18/10	1.3' Recovery; say 88.0' to 89.3' depth		88.0-90.0	179								
	Silty CLAY, sandy, gray, very stiff consistency, moderate plasticity (CL)		88.4	TV								TV=1.3 tsf
	Sample includes about 25% fine to coarse SAND and fine Gravel size particles (subrounded to subangular in shape)		88.4-88.4	W179.1	22.9		99					
			88.7-88.8	W179.2	21.9		98					
			88.8	TV								TV=1.1 tsf
			88.8-90.1	L179.1	17.3	29	15					
			88.8-90.1	U179.01	17.3		110	UU	15.0	2863		σ _c =6336 psf

PROJECT: BELLE RIVER PLANT UNITS I & II

FILE NO. 1255

DATE July 1974

TABLE SUMMARY OF LABORATORY TEST RESULTS

SHEET OF

IDENTIFICATION		TEST NO.	PROPERTIES			STRENGTH		CONSOLIDATION		OTHER TESTS AND REMARKS
BORING SAMPLE	SOIL DESCRIPTION		DEPTH (FEET)	NAT. WATER CONTENT (%)	ATTERBERG LIMITS w _L w _p	DRY UNIT WEIGHT (PCF)	TEST TYPE	ε %	e _o c _c	
18/11	Jar Sample	—								
	Silty SAND, subrounded to subangular fine to coarse Sand grains with about 10% non-plastic fines (SM-SW)	103.5-105.0								
		430								
		S430.1								See plot

PROJECT: BELLE RIVER PLANT UNITS I & II												FILE NO. 1255	
TABLE SUMMARY OF LABORATORY TEST RESULTS												DATE July 1974	
IDENTIFICATION												SHEET OF	
BORING SAMPLE	SOIL DESCRIPTION	DEPTH (FEET)	TEST NO.	PROPERTIES			STRENGTH		CONSOLIDATION		OTHER TESTS AND REMARKS		
				NAT. WATER CONTENT (%)	ATTERBERG LIMITS w _L w _P	DRY UNIT WEIGHT (PCF)	TEST TYPE	ε %	MAX. SHEAR STRESS (PSF)	e _o		c _c	
18/12	1.7' Recovery; say 108.0' to 109.7' depth	108.0-110.0	181										
		108.2-108.5	1181.1	34.2	46 22								
	Silty CLAY, grey, stiff consistency, moderate to highly plastic (CL)	108.2-108.5	1181.1.1	34.5		87	CU	5.9	1952		σ _c =3744psf		
		108.5-108.6	1181.1	32.3		90					TV=0.71tsf		
		108.6	TV										
	Sample includes lenses/layers below 108.9' depth consisting of Silty Sand, subrounded to subangular fine to medium Sand grains with about 40% non-plastic fines (SM)	108.6-108.9	1181.1.2	31.0		92	CU	6.2	2601		σ _c =7488psf		
		108.6-108.9	1181.1.3	30.7		92	CU	6.8	4088		σ _c =15120psf		
		108.9-	Saved										
		109.3-109.4	1181.2	26.8		94							
	Layers/lenses comprise ±30% of total sample below 108.9' depth	109.4	TV								TV=0.51tsf		

PROJECT: BELLE RIVER PLANT UNITS I & II

TABLE SUMMARY OF LABORATORY TEST RESULTS

FILE NO. 1255

DATE July 1974

SHEET ___ OF ___

BORING SAMPLE	IDENTIFICATION		TEST NO.	PROPERTIES			STRENGTH		CONSOLIDATION		OTHER TESTS AND REMARKS	
	SOIL DESCRIPTION	DEPTH (FEET)		NAT. WATER CONTENT (%)	ATTERBERG LIMITS wL wP	DRY UNIT WEIGHT (PCF)	TEST TYPE	ε %	MAX. SHEAR STRESS (PSF)	e _o		c _c
18/16	Jar Sample	139.5 - 141.0	431									
	Silty SAND, gravelly; about 25% hard subrounded to subangular gravel size particles (3/4" max. size), subrounded to subangular fine to coarse Sand grains, about 15% non-plastic fines (SM)		S431.1								See plot	

PROJECT: BELLE RIVER PLANT UNITS I & II		FILE NO. 1255										
TABLE SUMMARY OF LABORATORY TEST RESULTS		DATE July 1974										
IDENTIFICATION		SHEET OF										
BORING SAMPLE	SOIL DESCRIPTION	DEPTH (FEET)	TEST NO.	PROPERTIES			STRENGTH		CONSOLIDATION		OTHER TESTS AND REMARKS	
				NAT. WATER CONTENT (%)	ATTERBERG LIMITS w_L w_p	DRY UNIT WEIGHT (PCF)	TEST TYPE	ϵ %	MAX. SHEAR STRESS (PSF)	e_0		C_c
19/1	Silty CLAY, dark greyish brown, very stiff consistency moderate to high plasticity (CL-CH) Sample includes about 10% fine to coarse Sand and fine gravel size particles (sub-rounded to subangular in shape)	3.0-5.0	290									
		3.4-3.6	W290.1	25.7	95							
		3.6	TV									TV=1.15tsf
		3.6-3.9	Saved									
		3.9-4.2	Saved									
		4.2-4.3	W290.2	31.4	87							
		4.3	TV									TV=1.13tsf

PROJECT: BELLE RIVER PLANT UNITS I & II

FILE NO. 1255

DATE July 1974

TABLE SUMMARY OF LABORATORY TEST RESULTS

SHEET OF

BORING SAMPLE	IDENTIFICATION		TEST NO.	PROPERTIES			STRENGTH			CONSOLIDATION		OTHER TESTS AND REMARKS	
	SOIL DESCRIPTION	DEPTH (FEET)		NAT. WATER CONTENT (%)	ATTERBERG LIMITS w _L w _P	DRY UNIT WEIGHT (PCF)	TEST TYPE	ε %	MAX. SHEAR STRESS (PSF)	e ₀	c _c		
19/3	1.8' Recovery; say 18.0' to 19.8' depth	18.0-20.0	292										
		18.1-18.5	L292.1	40.2	49	24							
	Silty CLAY, gray, soft to firm consistency moderate to high plasticity (CL-OH)	18.5-18.6	W292.1	39.1			85						
		18.6	TV									TV=0.27 tsf	
		18.6-19.0	saved										
		19.1-19.3	W292.2		35.3			83					
		19.3	St									TV=0.23 tsf	
		19.4-19.7	saved										

PROJECT: BELLE RIVER PLANT UNITS I & II
 TABLE SUMMARY OF LABORATORY TEST RESULTS

FILE NO. 1255
 DATE July 1974

SHEET OF

IDENTIFICATION		TEST NO.	PROPERTIES			STRENGTH		CONSOLIDATION		OTHER TESTS AND REMARKS		
			DEPTH (FEET)	NAT. WATER CONTENT (%)	ATTERBERG LIMITS w_L w_p	DRY UNIT WEIGHT (PCF)	TEST TYPE	ϵ %	MAX. SHEAR STRESS (PSF)		e_0	c_c
19/8	Silty CLAY, grey, stiff consistency, moderate plasticity (CL) Sample includes about 15% fine to coarse Sand and fine gravel size particles (sub-rounded to subangular in shape)	—	68.0-70.0									
		297	68.4-68.5	23.1		1.03						
		TV	68.5								TV=0.80tsf	
		Saved	68.5-68.8									
		W297.2	69.2-69.3	22.2		1.03						
		TV	69.3								TV=0.73tsf	
		Saved	69.3-69.7									

PROJECT: BELLE RIVER PLANT UNITS I & II
 TABLE SUMMARY OF LABORATORY TEST RESULTS

FILE NO. 1255
 DATE July 1974
 SHEET OF

BORING SAMPLE	IDENTIFICATION	DEPTH (FEET)	TEST NO.	PROPERTIES			STRENGTH		CONSOLIDATION		OTHER TESTS AND REMARKS
				NAT. WATER CONTENT (%)	ATTERBERG LIMITS w _L w _p	DRY UNIT WEIGHT (PCF)	TEST TYPE	ε %	MAX. SHEAR STRESS (PSF)	e _o	
19/9	1.9' Recovery; say 78.0' to 79.9' depth	78.0-80.0	298								
		78.2-78.6	saved								
	Silty CLAY, gray, stiff consistency, moderate plasticity (CL)	78.6-78.7	W298.1	21.4		106					
		78.7	TV								TV=0.63 tsf
		78.7-79.0	L298.1	24.4	33	17					
		79.0-79.5	saved								
	Sample includes about 15% fine to coarse SAND and fine gravel size particles (subrounded to subangular in shape)	79.6-79.7	W298.2	24.9		101					
		79.7	TV								TV=0.67 tsf

PROJECT: <u>BELLE RIVER PLANT UNITS I & II</u>											FILE NO. <u>1255</u>	
TABLE <u> </u> SUMMARY OF LABORATORY TEST RESULTS											DATE <u>July 1974</u>	
IDENTIFICATION											SHEET <u> </u> OF <u> </u>	
BORING SAMPLE	SOIL DESCRIPTION	DEPTH (FEET)	TEST NO.	PROPERTIES			STRENGTH		CONSOLIDATION		OTHER TESTS AND REMARKS	
				NAT. WATER CONTENT (%)	ATTERBERG LIMITS w_L w_P	DRY UNIT WEIGHT (PCF)	TEST TYPE	ϵ %	MAX. SHEAR STRESS (PSF)	e_0		C_c
19/11	1.8' Recovery; say 100.0' to 101.8' depth	100.0- 102.0	— 300									
		100.5	TV								TV-0.43tsf	
	Silty CLAY, grey, firm consistency, moderate plasticity (CL) Sample includes about 15% fine to coarse Sand and fine gravel size particles (subrounded to subangular in shape)	100.5										
		100.6	W300.1		22.7		100					
		100.6		Saved								
		101.3										
		101.4		W300.2		27.3						
		101.4		TV								TV=0.42 tsf
		101.4										
	101.7		Saved									

PROJECT: BELLE RIVER PLANT UNITS I & II

FILE NO. 1255

DATE July 1974

SUMMARY OF LABORATORY TEST RESULTS

SHEET OF

IDENTIFICATION		TEST NO.	PROPERTIES			STRENGTH		CONSOLIDATION		OTHER TESTS AND REMARKS
BORING SAMPLE	SOIL DESCRIPTION		DEPTH (FEET)	NAT WATER CONTENT (%)	ATTERBERG LIMITS w _L w _P	DRY UNIT WEIGHT (PCF)	TEST TYPE	ε %	e ₀	
19/12	1.9' Recovery; say 118.0' to 119.9' depth	—								
		30J								
		W30L1	35.1		86					
	Silty CLAY, grey, stiff consistency, moderate to high plasticity (CL)	TV								TV=0.55tsf
		Saved								
	Sample includes few thin lenses/layers of SILT, sandy (ML) comprising ±5% of total	W30L2	41.4		80					
		TV								TV=0.68tsf
		Saved								

PROJECT: BELLE RIVER PLANT UNITS I & II			FILE NO. 1255						
TABLE SUMMARY OF LABORATORY TEST RESULTS			DATE Jan. 1974						
IDENTIFICATION			SHEET		OF				
BORING SAMPLE	SOIL DESCRIPTION	DEPTH (FEET)	TEST NO.	PROPERTIES		STRENGTH	CONSOLIDATION		OTHER TESTS AND REMARKS
				NAT WATER CONTENT (%)	ATTERBERG LIMITS w _L w _P		DRY UNIT WEIGHT (PCF)	e ₀	
B22/29	Jar Sample Clayey SILT; dark gray, slight to low plasticity (CL-ML)	13.5 to 15.5	67 S/H 67.1						See plot

PROJECT: BELLE RIVER PLANT UNITS I & II		FILE NO. 1255									
TABLE SUMMARY OF LABORATORY TEST RESULTS		DATE April 1974									
IDENTIFICATION		SHEET ___ OF ___									
BORING SAMPLE	SOIL DESCRIPTION	DEPTH (FEET)	TEST NO.	PROPERTIES		STRENGTH		CONSOLIDATION		OTHER TESTS AND REMARKS	
				NAT. WATER CONTENT (%)	ATTERBERG LIMITS w _L w _P	DRY UNIT WEIGHT (PCF)	TEST TYPE	ε %	e ₀		c _c
25/1	Silly CLAY, grayish brown, very stiff consistency, highly plastic (CH) Sample includes about 5% hard subrounded gravel size particles Note: upper 1.0' of sample disturbed (Wash?)	3.0 to 5.0	266								
		4.0	TV								TV=0.4tsf
		4.0 to 4.3	save								
		4.3 to 4.5	266.1								
		4.5 to 4.8	W266.1		24.1	100					
		4.5 to 4.8	U266.1		22.4	108	U	5.0	3456		
		4.5 to 4.8	I266.1		24.5	59	23				
		4.8	TV								TV=1.8tsf

PROJECT: BELLE RIVER PLANT UNITS I & II

FILE NO. 1255

DATE July 1974

SHEET 0F

SUMMARY OF LABORATORY TEST RESULTS

BORING SAMPLE	IDENTIFICATION		DEPTH (FEET)	TEST NO.	PROPERTIES			STRENGTH		CONSOLIDATION		OTHER TESTS AND REMARKS		
					NAT. WATER CONTENT (%)	ATTERBERG LIMITS w _L w _P	DRY UNIT WEIGHT (PCF)	TEST TYPE	ε %	MAX. SHEAR STRESS (PSF)	e ₀		C _c	
25/3	1. 9' Recovery; say 18.0' to 19.9' depth, upper 0.8' disturbed (WASH??) Silty CLAY, grey, firm consistency, moderate to high plasticity (CL-CH)		18.0-20.0	268										
			18.8-19.2	Saved										
			19.2-											
			19.3	W268.1	39.1			80						
			19.3	TV										TV=0.30tsf
			19.3-19.6	Saved										
			19.6-19.7	W268.2	38.1			81						
			19.7	TV										TV=0.27tsf

PROJECT: BELLE RIVER PLANT UNITS I & II		FILE NO. 1255									
TABLE SUMMARY OF LABORATORY TEST RESULTS		DATE July 1974									
IDENTIFICATION		SHEET 1 OF 1									
BORING SAMPLE	SOIL DESCRIPTION	DEPTH (FEET)	TEST NO.	PROPERTIES		STRENGTH		CONSOLIDATION		OTHER TESTS AND REMARKS	
				NAT. WATER CONTENT (%)	ATTERBERG LIMITS w _L w _P	DRY UNIT WEIGHT (PCF)	TEST TYPE	ε %	MAX. SHEAR STRESS (PSF)		e _o
25/4	Silty CLAY, Sandy, dark grey, soft to firm consistency, moderately plastic (CL) Sample includes about 30% fine to coarse SAND and fine Gravel size particles (sub-rounded to subangular in shape) few thin lenses/layers of Silty CLAY (CL-CH) throughout comprising ±10% of total Note: Entire sample slightly disturbed	28.0-30.0	—								
		28.1-28.5	269								
		28.5-28.7	W269.1		18.1		111				
		28.7	TV								TV=0.27tsf
		28.7-29.1	Saved								
		29.1-29.3	W269.2		22.6		102				
		29.3	TV								TV=0.25 tsf
		29.3-29.7	W269.1		31.0	25	16				

PROJECT: BELLE RIVER PLANT UNITS I & II		FILE NO. 1255									
TABLE SUMMARY OF LABORATORY TEST RESULTS		DATE July 1974									
IDENTIFICATION		SHEET OF									
BORING SAMPLE	SOIL DESCRIPTION	DEPTH (FEET)	TEST NO.	PROPERTIES		STRENGTH		CONSOLIDATION		OTHER TESTS AND REMARKS	
				NAT. WATER CONTENT (%)	ATTERBERG LIMITS w_L w_P	DRY UNIT WEIGHT (PCF)	TEST TYPE	ϵ	MAX. SHEAR STRESS (PSF)		e_0
25/6	Silty CLAY, dark gray, firm consistency, moderately plastic (CL) Sample includes about 15% fine to coarse SAND and fine gravel size particles (subrounded to subangular in shape)	48.0-50.0	271								
		48.3-48.7	saved								
		48.7-48.8	W271.1	80							
		48.8	TV								TV=0.37 tsf
		48.8-49.2	saved								
		49.2-49.4	W271.2	82							
		49.4	TV								TV=0.30 tsf
		49.4-49.8	L271.1		38.0	39	19				

PROJECT: BELLE RIVER PLANT UNITS I & II

FILE NO. 1255

DATE July 1974

SHEET ___ OF ___

TABLE SUMMARY OF LABORATORY TEST RESULTS

IDENTIFICATION		TEST NO.	PROPERTIES			STRENGTH		CONSOLIDATION		OTHER TESTS AND REMARKS
BORING SAMPLE	SOIL DESCRIPTION		NAT. WATER CONTENT (%)	ATTERBERG LIMITS w _L w _p	DRY UNIT WEIGHT (PCF)	TEST TYPE	ε %	MAX. SHEAR STRESS (PSF)	e _o	
25/7	Silty CLAY, grey, firm to stiff consistency, moderate plasticity (CL) Sample includes about 15% fine to coarse Sand and fine gravel size particles (subrounded to subangular in shape)	58.0-								
		60.0	272							
		58.4-								
		58.5	W272.1	24.1	98					
		58.5	TV							TV=0.45 tsf
		58.5-								
		58.8	Saved							
		59.2-								
		59.3	W272.1	24.4	99					
		59.3	TV							TV=0.58tsf
	59.3-									
	59.6	Saved								

PROJECT: BELLE RIVER PLANT UNITS I & II		FILE NO. 1255									
TABLE SUMMARY OF LABORATORY TEST RESULTS		DATE April 1974									
IDENTIFICATION		SHEET OF									
BORING SAMPLE	SOIL DESCRIPTION	DEPTH (FEET)	TEST NO.	PROPERTIES			STRENGTH		CONSOLIDATION		OTHER TESTS AND REMARKS
				NAT. WATER CONTENT (%)	ATTERBERG LIMITS w _L w _P	DRY UNIT WEIGHT (PCF)	TEST TYPE	ε %	MAX. SHEAR STRESS (PSF)	e ₀	
25/10	1.8' Recovery; Say 88.0' to 89.8' depth	88.0 to 90.0	275								
		88.1 to 88.4	save 275.1								
		88.4 to 88.6	WZ75.1	19.7		106					
	Silty CLAY, dark gray, stiff consistency, moderately plastic (CL)	88.6	TV								TV=0.74tsf
		88.6 to 88.9	save 275.2								
	Sample includes about 20% coarse to fine sand and fine gravel sized particles (subrounded to subangular in shape)	88.9 to 89.2	TZ75.0	22.5		104	UU	11.0	2213		
		88.9 to 89.2	IZ75.1	21.4	36	19					
		89.2 to 89.4	WZ75.2	22.3		103					
		89.4	TV								TV=0.80tsf

PROJECT: BELLE RIVER PLANT UNITS I & II

FILE NO. 1255

DATE July 1974

SUMMARY OF LABORATORY TEST RESULTS

SHEET OF

BORING SAMPLE	IDENTIFICATION		TEST NO.	PROPERTIES			STRENGTH		CONSOLIDATION		OTHER TESTS AND REMARKS	
	SOIL DESCRIPTION	DEPTH (FEET)		NAT. WATER CONTENT (%)	ATTERBERG LIMITS w _L w _P	DRY UNIT WEIGHT (PCF)	TEST TYPE	ε %	MAX. SHEAR STRESS (PSF)	e ₀		c _c
25/12	2.4' Recovery; say 118.0' to 120.4' depth Silty CLAY, grey, stiff consistency, moderate to high plasticity (CL-CH) Sample includes about 5% fine to medium Sand grains (subrounded to subangular in shape)	118.0-120.5	277									
		118.6-118.7	W277.1	77								
		118.7	TV									TV=0.70tsf
		118.7-119.0	Saved									
		119.0-119.4	Saved									
		119.4-119.5	W277.2	82	36.4							
		119.8	TV									TV=0.68tsf

FILE NO. 1255
DATE Jan. 1974

PROJECT: BELLE RIVER PLANT UNITS I & II
TABLE SUMMARY OF LABORATORY TEST RESULTS SHEET OF

IDENTIFICATION		TEST NO.	PROPERTIES			STRENGTH		CONSOLIDATION		OTHER TESTS AND REMARKS	
BORING SAMPLE	SOIL DESCRIPTION		DEPTH (FEET)	NAT. WATER CONTENT (%)	ATTERBERG LIMITS w _L w _P	DRY UNIT WEIGHT (PCF)	TEST TYPE	ε %	MAX. SHEAR STRESS (PSF)		e ₀
B26/2	Recovery 1.6', say 3.5' to 5.1' depth	1									
		TV	25.4								TV=0.88 tsf
	Silty CLAY, grayish brown, moderate to high plasticity, very stiff consistency (CL-CH) Includes about 15% subangular to subrounded fine gravel and coarse sand particles	WL.1	25.4								
		save									
		1.1									
		TV		23.9							
		WL.2		23.9							
		T1.1.1		23.0		104	CU	15.0	1100		
		4.0 to 4.3									
		4.0 to 4.3		23.0	53	24					
		4.3	TV								
		4.3 to 4.7	T1.1.2	23.9		103	CU	15.0	1725		
	4.7	TV	21.9								
	4.7	WL.3	21.9								
	4.7 to 5.0	T1.1.3	22.3		108	CU	15.0	2400			
											TV=1.13 tsf
											TV=1.3 tsf

PROJECT: BELLE RIVER PLANT UNITS I & II		FILE NO. 1255										
TABLE SUMMARY OF LABORATORY TEST RESULTS		DATE Jan. 1974										
IDENTIFICATION		SHEET OF										
BORING SAMPLE	SOIL DESCRIPTION	DEPTH (FEET)	TEST NO.	PROPERTIES		STRENGTH		CONSOLIDATION		OTHER TESTS AND REMARKS		
				NAT. WATER CONTENT (%)	ATTERBERG LIMITS ω_L ω_P	DRY UNIT WEIGHT (PCF)	TEST TYPE	ϵ %	MAX. SHEAR STRESS (PSF)		e_0	c_c
B26/3	1.5' Recovery; say 8.0' to 9.5' depth	8.0 to 10.0	2									
		8.2	TV	31.5							TV=0.9 tsf	
	Silty CLAY; dark gray, moderately to highly plastic, firm consistency (CL-CH). Includes about 10% subangular to subrounded fine gravel size particles and $\pm 5\%$ fine to coarse sand size particles.	8.2	W2.1	31.5								
		8.3 to 8.7	save 2.1									
		8.7	TV	33.0								TV=0.6 tsf
		8.7	W2.2	33.0								
		8.8 to 8.9	L2.1	32.0	50	22						
		8.9 to 9.2	save 2.2									
		9.2	TV	32.7								TV=0.4 tsf
		9.2	W2.3	32.7								

PROJECT: BELLE RIVER PLANT UNITS I & II FILE NO. 1255
 TABLE SUMMARY OF LABORATORY TEST RESULTS DATE Jan. 1974
 SHEET _____ OF _____

BORING SAMPLE	IDENTIFICATION	DEPTH (FEET)	TEST NO.	PROPERTIES			STRENGTH		CONSOLIDATION		OTHER TESTS AND REMARKS	
				NAT WATER CONTENT (%)	ATTERBERG LIMITS w_L w_P	DRY UNIT WEIGHT (PCF)	TEST TYPE	ϵ %	MAX SHEAR STRESS (PSF)	e_0		c_c
B26/5	1.2' Recovery; say 18.0' to 19.2' depth	18.0 to 20.0	3									
		18.0 to 18.3	T3.L3	35.7		86	CU	15.2	2175			
	Silty CLAY, gray, soft consistency, highly plastic (CL-CH)	18.3	TV	35.9							TV=0.17 tsf	
	Includes about 15% subangular to subrounded fine Gravel and coarse Sand particles	18.3	W3.1	35.9								
		18.3 to 18.7	T3.L2	35.3		86	CU	10.7	839			
		18.7 to 19.0	T3.L1	35.4		89	CU	15.1	676			
		19.0	TV	35.6							TV=0.24 tsf	
		19.0	W3.2	35.6								

PROJECT: BELLE RIVER PLANT UNITS I & II		FILE NO. 1255									
TABLE SUMMARY OF LABORATORY TEST RESULTS		DATE Jan. 1974									
IDENTIFICATION		SHEET OF									
BORING SAMPLE	SOIL DESCRIPTION	DEPTH (FEET)	TEST NO.	PROPERTIES		STRENGTH		CONSOLIDATION		OTHER TESTS AND REMARKS	
				NAT. WATER CONTENT (%)	ATTERBERG LIMITS w _L w _p	DRY UNIT WEIGHT (PCF)	TEST TYPE	ε %	MAX. SHEAR STRESS (PSF)		e _o
B26/9	1.9' Recovery; say 38.0' to 39.9' depth	38.0 to 40.0	5								
		38.4	TV	40.6							TV=0.20 tsf
	Silty CLAY; gray, soft to firm consistency, highly plastic (CL)	38.4 to 38.5	W5.1	40.6							
		38.5 to 38.8	save 5.1								
		38.8	TV	39.5							TV=0.23 tsf
		38.8 to 38.9	W5.2	39.5							
		38.9 to 39.3	save 5.2								
		39.3	TV	36.0							TV=0.34 tsf
		39.3 to 39.4	W5.3	36.0							
		39.4 to 39.8	U5.1	36.6							
		39.4 to 39.8	L.5.1	36.6	38	20	86	U	1.6	443	

PROJECT: BELLE RIVER PLANT UNITS I & II

FILE NO. 1255

DATE Jan. 1974

SHEET OF

SUMMARY OF LABORATORY TEST RESULTS

IDENTIFICATION		TEST NO.	PROPERTIES			STRENGTH		CONSOLIDATION		OTHER TESTS AND REMARKS	
BORING SAMPLE	SOIL DESCRIPTION		NAT WATER CONTENT (%)	ATTERBERG LIMITS w_L w_P	DRY UNIT WEIGHT (PCF)	TEST TYPE	ϵ %	MAX SHEAR STRESS (PSF)	e_o		c_c
B26/11	Silty CLAY: dark gray, firm consistency, highly plastic (CL) Sample includes about 20% coarse to fine sand grains (subangular to subrounded in shape)	48.0 to 50.0									
		48.0 to 48.3	save 6.1								
		48.3	TV	31.0							TV=0.28 tsf
		48.3 to 48.4	W6.1	31.0							
		48.4 to 48.7	save 6.2								
		48.7	TV								TV=0.32 tsf
		48.7 to 49.0	T6.1.3	30.0		93	4.6	2206			
		49.0	TV	36.3							TV=0.29 tsf
		49.0 to 49.1	W6.2	36.3							
		49.1 to 49.4	T6.1.2	36.5		86	3.9	1222			
		49.4	TV	34.5							TV=0.33 tsf
		49.4 to 49.5	W6.3	34.5							
	49.5 to 49.8	T6.1.1	36.1		88	3.8	896				
	49.5 to 49.8	L6.1	36.1	41	21						

PROJECT: BELLE RIVER PLANT UNITS I & II		FILE NO. 1255									
TABLE SUMMARY OF LABORATORY TEST RESULTS		DATE Jan. 1974									
IDENTIFICATION		SHEET OF									
BORING SAMPLE	SOIL DESCRIPTION	DEPTH (FEET)	TEST NO.	PROPERTIES			STRENGTH		CONSOLIDATION		OTHER TESTS AND REMARKS
				NAT. WATER CONTENT (%)	ATTERBERG LIMITS w _L w _P	DRY UNIT WEIGHT (PCF)	TEST TYPE	ε %	MAX. SHEAR STRESS (PSF)	e _o	
B26/17	1.0' Recovery; say 78.0' to 79.0' depth	78.0 to 80.0	9								
	Silty CLAY, dark gray, firm to stiff consistency, highly plastic (CL) Includes about 35% subangular to subrounded fine Gravel and coarse Sand particles	78.2	TV	25.1							TV=0.46
		78.2	W9.1	25.1							
		78.2 to 78.5	U9.1	24.8		101	12.0	580			
		78.2 to 78.5	L9.1	24.8	36	20					
		78.5	TV	25.8							TV=0.52 tsf
		78.5 to 78.6	W9.2	25.8							
		78.6 to 78.9	save 9.1								
		78.9	TV	25.0							TV=0.38 tsf
		78.9 to 79.0	W9.3	25.0							

PROJECT: BELLE RIVER PLANT UNITS I & II
 TABLE SUMMARY OF LABORATORY TEST RESULTS

FILE NO. 1255
 DATE July 1974
 SHEET OF

BORING SAMPLE	IDENTIFICATION	TEST NO.	PROPERTIES			STRENGTH		CONSOLIDATION		OTHER TESTS AND REMARKS	
			NAT. WATER CONTENT (%)	ATTERBERG LIMITS w _L w _P	DRY UNIT WEIGHT (PCF)	TEST TYPE	ε %	MAX. SHEAR STRESS (PSF)	e ₀		c _c
26/28	Recovery 2.4'; say 128.0' to 130.4' depth Silty CLAY, dark grey firm to stiff consistency, moderate to highly plastic (CL) Bottom third of sample includes 30 to 40% fine Sand and non-plastic Silt particles occurring in thin layers (1/16" to 1/4" thick)										
		128.0-									
		131.0	13								
		128.0-									
		128.3	TI3.1.3	34.0		90	CU	3.4	4652		$\bar{\sigma}_c=16,704$ psf
		128.4-									
		128.8	TI3.1.2	35.6		86	CU	4.5	2442		$\bar{\sigma}_c=8352$ psf
		128.4-									
		128.8	LI3.1	35.4	39	21					
		128.8-									
		128.9	WI3.2	32.1							
		128.8-									
		128.9	TV	32.1							TV=0.60tsf
	129.7	TV	27.5							TV=0.50tsf	
	129.7-										
	129.8	WI3.3	27.5								
	129.8-										
	130.2	TI3.1.1	22.9		96	CU	15.0	4500		$\bar{\sigma}_c=4176$ psf	

PROJECT: BELLE RIVER PLANT UNITS I & II

FILE NO. 1255

DATE July 1974

TABLE SUMMARY OF LABORATORY TEST RESULTS

SHEET OF

BORING SAMPLE	IDENTIFICATION		TEST NO.	PROPERTIES			STRENGTH		CONSOLIDATION		OTHER TESTS AND REMARKS	
	SOIL DESCRIPTION	DEPTH (FEET)		NAT. WATER CONTENT (%)	ATTERBERG LIMITS w _L w _P	DRY UNIT WEIGHT (PCF)	TEST TYPE	ε %	MAX. SHEAR STRESS (PSF)	e _o		c _c
27/2	1. 4' Recovery; say 3.5' to 4.9' depth Silty CLAY; greyish brown, stiff consistency, moderate to high plasticity (CL-CH) Sample includes about 5% coarse sand and fine gravel sized particles (subrounded to subangular in shape)	3.5-5.5										
		3.6-4.0										
		4.0-4.2	W302.1	24.2		99						
		4.2	TV									TV=0.87 tsf
		4.2-4.5										
		4.5-4.8	T302.2	24.9		103	UU	8.0	2099			
		4.5-4.8	L302.1	23.1	48	24						

PROJECT: BELLE RIVER PLANT UNITS I & II
 TABLE SUMMARY OF LABORATORY TEST RESULTS

FILE NO. 1255
 DATE April 1974
 SHEET 1 OF 1

BORING SAMPLE	IDENTIFICATION	DEPTH (FEET)	TEST NO.	PROPERTIES			STRENGTH		CONSOLIDATION		OTHER TESTS AND REMARKS	
				NAT. WATER CONTENT (%)	ATTERBERG LIMITS WL WP	DRY UNIT WEIGHT (PCF)	TEST TYPE	MAX. SHEAR STRESS (PSF)	e ₀	c _c		
27/4	1.7' Recovery; Say 8.0' to 9.7' depth Silty CLAY, grayish brown, firm to stiff consistency, highly plastic (CL-CH) Sample includes about 10% coarse sand and fine gravel size particles (subrounded to subangular in shape)	8.0 to 10.0	—									
		8.1 to 8.4	303									
		8.4 to 8.6	save 303.1									
			W303.1	88								
			TV									TV=0.66tsf
			8.6 to 8.9	U303.1	30.6			20.0	1772			@15.0% strain s=1722psf
			8.6 to 8.9	L303.1	30.4	51	23					
			8.9 to 9.2	save 303.2								
			9.2 to 9.4	W303.2	33.5		87					
			9.4	TV								TV=0.47tsf

BORING SAMPLE	IDENTIFICATION		TEST NO.	PROPERTIES			STRENGTH		CONSOLIDATION		OTHER TESTS AND REMARKS
	SOIL DESCRIPTION	DEPTH (FEET)		NAT. WATER CONTENT (%)	ATTERBERG LIMITS w/L w/P	DRY UNIT WEIGHT (PCF)	TEST TYPE	ε %	MAX. SHEAR STRESS (PSF)	e _o	
27/10	2.4' Recovery; Say 33.0' to 35.4' depth	33.0 to 35.5	306								
		33.1 to 33.4	save 306.1								
		33.4 to 33.6	W306.1	37.9	84						
	Silty CLAY, gray, firm consistency, moderately plastic (CL)	33.6	st								TV=0.3ltsf TVR=0.09tsf
		34.0 to 34.3	C306.1	38.6					1.016	.44	
		34.0 to 34.3	L306.1	37.4	41	22					
		34.0 to 34.3	SC306.1								specific gravity=2.73
		34.3 to 34.6	save 306.2								
		34.6 to 34.8	W306.2	36.3	86						
		34.8 to 35.2	save 306.3								

IDENTIFICATION		TEST NO.	PROPERTIES			STRENGTH		CONSOLIDATION		OTHER TESTS AND REMARKS	
BORING SAMPLE	SOIL DESCRIPTION		DEPTH (FEET)	NAT. WATER CONTENT (%)	ATTERBERG LIMITS wL wP	DRY UNIT WEIGHT (PCF)	TEST TYPE	ε %	e ₀		c _c
27/14	1.9' Recovery; say 53.0' to 54.9' depth	308									
	Silty CLAY, Sandy, very dark gray, stiff consistency, low to moderate plasticity (CL) Sample includes about 40% fine to coarse SAND and fine gravel size particles (subrounded to subangular in shape) At 53.9' change to Silty CLAY, gray, firm consistency, moderate plasticity (CL) Sample includes about 15% fine to coarse SAND grains (subrounded to subangular in shape)	53.1-53.5 saved									
		53.6-53.7 W308.1	13.0	120							
		53.7 TV									TV=0.78 tsf
		54.0-54.4 saved									
		54.4-54.5 W308.2	25.9	98							
		54.5-54.7 I308.1	24.2	17							
		54.7 TV									TV=0.34 tsf

PROJECT: BELLE RIVER PLANT UNITS I & II FILE NO. 1255

TABLE SUMMARY OF LABORATORY TEST RESULTS DATE July 1974

IDENTIFICATION SHEET OF

BORING SAMPLE	IDENTIFICATION		TEST NO.	PROPERTIES			STRENGTH		CONSOLIDATION		OTHER TESTS AND REMARKS
	SOIL DESCRIPTION	DEPTH (FEET)		NAT. WATER CONTENT (%)	ATTERBERG LIMITS w_L w_P	DRY UNIT WEIGHT (PCF)	TEST TYPE	ϵ %	MAX. SHEAR STRESS (PSF)	e_0	
27/17	Jar Sample	68.5-70.0	432								
	Clayey SILT, Sandy, dark gray, low plasticity (CL-ML)		S/H 432.1								See plot
	Sample includes about 45% fine to coarse Sand and fine Gravel size particles (subrounded to subangular in shape)										

PROJECT: BELLE RIVER PLANT UNITS I & II

FILE NO. 1255

DATE April 1974
SHEET OF

TABLE SUMMARY OF LABORATORY TEST RESULTS

IDENTIFICATION		TEST NO.	PROPERTIES			STRENGTH		CONSOLIDATION		OTHER TESTS AND REMARKS
BORING SAMPLE	SOIL DESCRIPTION		NAT. WATER CONTENT (%)	ATTERBERG LIMITS w _L w _P	DRY UNIT WEIGHT (PCF)	TEST TYPE	ε %	MAX. SHEAR STRESS (PSF)	e ₀	
27/24	Silty CLAY, sandy; gray, stiff consistency, moderately plastic (CL)	103.0 to 105.5 313								
		103.2 to save 103.5 313.1								
		103.5 TV								TV=0.61tsf
	Sample includes about 25% coarse to fine sand grains and fine gravel sized particles (subrounded to subangular in shape)	103.5 to 103.7 W313.1	27.4		98					
		103.7 to save 104.1 313.2								
		104.2 to 104.5 C313.1	33.9						0.90	.30
		104.2 to 104.5 L313.1	31.1	43 25						
		104.2 to 104.5 SC313.1								

PROJECT: BELLE RIVER PLANT UNITS I & II

FILE NO. 1255

DATE July 1974

TABLE SUMMARY OF LABORATORY TEST RESULTS

SHEET OF

IDENTIFICATION		TEST NO.	PROPERTIES		STRENGTH		CONSOLIDATION		OTHER TESTS AND REMARKS	
BORING SAMPLE	SOIL DESCRIPTION		DEPTH (FEET)	NAT. WATER CONTENT (%)	ATTERBERG LIMITS w_L w_p	DRY UNIT WEIGHT (PCF)	TEST TYPE	ϵ %		e_o c_c
27/26	1.5' Recovery; say 113.0' to 114.5' depth Silty CLAY, gray, soft consistency, moderate plasticity (CL) Sample includes few thin lenses/layers of Silty SAND (\pm 1/8" thick) comprising \pm 10% of total At 113.6' change to - Silty fine SAND, uniform fine Sand grains with about 10% non-plastic fines (SM-SP)	113.0-115.0								
		314								
		113.1	TV							TV=0.16 tsf
		113.1-113.5	W314.1	34.6		89				
		113.6-114.4	S314.1	21.4						See plot

PROJECT: BELLE RIVER PLANT UNITS I & II

FILE NO. 1255

TABLE SUMMARY OF LABORATORY TEST RESULTS

DATE July 1974

SHEET OF

BORING SAMPLE	IDENTIFICATION		DEPTH (FEET)	TEST NO.	PROPERTIES			STRENGTH		CONSOLIDATION		OTHER TESTS AND REMARKS	
					NAT. WATER CONTENT (%)	ATTERBERG LIMITS w _L w _P	DRY UNIT WEIGHT (PCF)	TEST TYPE	ε %	MAX. SHEAR STRESS (PSF)	e ₀		c _c
27/30	2.4' Recovery; say 129.0' to 131.4' depth; upper 0.8' possibly disturbed		129.0-	---									
			131.5										315
			129.1-										Saved
			129.4										
	Silty CLAY, grey, stiff consistency, moderate plasticity (CL)		129.5-	W315.1		34.0	84					Clay portion	
			129.6										
			129.9-										
			130.1										L315.1
	Sample includes Silty fine Sand lenses/layers throughout comprising about 10% of total sample		130.2	TV								TV=0.75tsf	
			130.2-										
			130.6										Saved
			130.6-										
			131.1	Saved								Silty Sand and Clay portion	
			131.1										
			131.1-										
			131.3										W315.2

PROJECT: BELLE RIVER PLANT UNITS I & II

FILE NO. 1255

DATE _____ SHEET _____ OF _____

SUMMARY OF LABORATORY TEST RESULTS

BORING SAMPLE	IDENTIFICATION		TEST NO.	PROPERTIES			STRENGTH		CONSOLIDATION		OTHER TESTS AND REMARKS	
	SOIL DESCRIPTION	DEPTH (FEET)		NAT. WATER CONTENT (%)	ATTERBERG LIMITS wL wP	DRY UNIT WEIGHT (PCF)	TEST TYPE	ε %	MAX. SHEAR STRESS (PSF)	e ₀		C _c
28/3	1.2' Recovery; say 5.0' to 6.2' depth	5.0-7.0	183									
	Silty CLAY, dark gray, very stiff consistency, moderate to high plasticity (CL)	5.0-5.3	saved									
		5.3-5.5	WI83.1	33.3		95						
		5.5	TV								TV=1.30 tsf	
		5.5-5.8	saved									
		5.8-6.1	UI83.1	25.3		100	U	4.0	1981			
		5.8-6.1	LI83.1	25.5	47	23						

PROJECT: BELLE RIVER PLANT UNITS I & II

FILE NO. 1255

DATE July 1974

TABLE SUMMARY OF LABORATORY TEST RESULTS

SHEET OF

IDENTIFICATION		TEST NO.	PROPERTIES			STRENGTH		CONSOLIDATION		OTHER TESTS AND REMARKS
BORING SAMPLE	SOIL DESCRIPTION		NAT. WATER CONTENT (%)	ATTERBERG LIMITS w _L w _P	DRY UNIT WEIGHT (PCF)	TEST TYPE	ε %	MAX. SHEAR STRESS (PSF)	e ₀	
28/9	Silly CLAY, dark gray, soft consistency, moderate to highly plastic (CL)	28.0-30.0								
		186								
		28.1-28.4								
		saved								
		28.4-28.5			80					
		WI86.1	40.0							
		28.5								TV=0.20 tsf
		TV								
		28.5-28.8								
		saved								
		28.8-29.1			84		U	7.0	425	
		UI86.1	38.0							
		28.8-29.1								
		LI86.1	39.2	42	20					
	29.1-29.3			78						
	WI86.2	41.4								
	29.3								TV=0.20 tsf	
	TV									
	29.3-29.6									
	saved									

FILE NO. 1255
DATE July 1974
SHEET ___ OF ___

PROJECT: BELLE RIVER PLANT UNITS I & II
TABLE SUMMARY OF LABORATORY TEST RESULTS

BORING SAMPLE	IDENTIFICATION	TEST NO.	PROPERTIES			STRENGTH		CONSOLIDATION		OTHER TESTS AND REMARKS	
			NAT WATER CONTENT (%)	ATTERBERG LIMITS WL WP	DRY UNIT WEIGHT (PCF)	TEST TYPE	ε %	MAX. SHEAR STRESS (PSF)	e _o		c _c
28/15	2.1' Recovery: say 58.0' to 60.1' depth Silty CLAY, dark gray, firm consistency, moderate plasticity (CL) Sample includes about 15% fine to coarse SAND grains (subrounded to subangular in shape)	—									
		58.0-60.0	189								
		58.2-58.5	saved								
		58.5-58.6	WI89.1	25.5		98					TV=0.38 tsf
		58.6	TV								
		59.0-59.3	saved								
		59.3-59.4	WI89.2	25.1		99					
		59.4-59.7	saved								
		59.7	TV								TV=0.43 tsf

PROJECT: BELLE RIVER PLANT UNITS I & II

FILE NO. 1255

DATE July 1974

SUMMARY OF LABORATORY TEST RESULTS

SHEET 0F

BORING SAMPLE	IDENTIFICATION		TEST NO.	PROPERTIES			STRENGTH		CONSOLIDATION		OTHER TESTS AND REMARKS	
	SOIL DESCRIPTION	DEPTH (FEET)		NAT WATER CONTENT (%)	ATTERBERG LIMITS w _L w _p	DRY UNIT WEIGHT (PCF)	TEST TYPE	ε %	MAX SHEAR STRESS (PSF)	e ₀		c _c
28/23	2.1' Recovery, say 98.0' to 100.1' depth Silty CLAY, gray, stiff consistency, moderate to high plasticity (CL) Sample includes about 15% fine to coarse SAND grains (subrounded to subangular in shape)	98.0-100.0	193									
		98.1-98.4	saved									
		98.4-98.5	W193.1		23.0	104						
		98.5	TV									TV=0.71 tsf
		98.5-98.9	saved									
		99.2-99.3	W193.2		23.8	98						
		99.3	TV									TV=0.93 tsf
		99.3-99.6	saved									

PROJECT: BELLE RIVER PLANT UNITS I & II
 TABLE SUMMARY OF LABORATORY TEST RESULTS

FILE NO. 1255
 DATE July 1974
 SHEET OF

IDENTIFICATION		TEST NO.	PROPERTIES			STRENGTH		CONSOLIDATION		OTHER TESTS AND REMARKS	
BORING SAMPLE	SOIL DESCRIPTION		DEPTH (FEET)	NAT. WATER CONTENT (%)	ATTERBERG LIMITS (wL, wP)	DRY UNIT WEIGHT (PCF)	TEST TYPE	ε %	MAX. SHEAR STRESS (PSF)		e ₀
30/3	Jar Sample	433									
	Silty CLAY, dark grayish brown, high plasticity (CH)	L433.1	22.4*	55 25							

*Note: Water content taken from unsealed jar sample

PROJECT: BELLE RIVER PLANT UNITS I & II

TABLE SUMMARY OF LABORATORY TEST RESULTS

FILE NO. 1255
DATE July 1972
SHEET OF

BORING SAMPLE	IDENTIFICATION		TEST NO.	PROPERTIES			STRENGTH		CONSOLIDATION		OTHER TESTS AND REMARKS		
	SOIL DESCRIPTION	DEPTH (FEET)		NAT.* WATER CONTENT (%)	ATTERBERG LIMITS		DRY UNIT WEIGHT (PCF)	TEST TYPE	ε %	MAX. SHEAR STRESS (PSF)		e _o	C _c
					w _L	w _p							
30/6	Jar Sample	18.5 - 20.0	—										
	Silty CLAY, dark grayish brown, moderate to highly plastic (CL-CH)		434										
			W434.1	37.7*									

*Note: Water content taken from unsealed jar sample

PROJECT: BELLE RIVER PLANT UNITS I & II

FILE NO. 1255

DATE July 1974

SHEET

OF

SUMMARY OF LABORATORY TEST RESULTS

BORING SAMPLE	IDENTIFICATION		TEST NO.	PROPERTIES			STRENGTH		CONSOLIDATION		OTHER TESTS AND REMARKS	
	SOIL DESCRIPTION	DEPTH (FEET)		NAT. WATER CONTENT (%)	ATTERBERG LIMITS w _L w _P	DRY UNIT WEIGHT (PCF)	TEST TYPE	ε %	MAX. SHEAR STRESS (PSF)	e _o		c _c
30/12	Jar Sample	53.5-55.0	435									
	Silty CLAY, grey, moderate plasticity (CL) Sample includes about 20% fine to coarse Sand grains (subangular to subrounded in shape) *Note: Water content taken from unsealed jar sample		W435.1	*								

FILE NO. 1255
DATE July 1974

PROJECT: BELLE RIVER PLANT UNITS I & II
TABLE SUMMARY OF LABORATORY TEST RESULTS

SHEET 1 OF 1

BORING SAMPLE	IDENTIFICATION	DEPTH (FEET)	TEST NO.	PROPERTIES			STRENGTH		CONSOLIDATION		OTHER TESTS AND REMARKS
				NAT. WATER CONTENT (%)	ATTERBERG LIMITS w _L w _P	DRY UNIT WEIGHT (PCF)	TEST TYPE	ε %	MAX. SHEAR STRESS (PSF)	e ₀	
30/15	Jar Sample	68.5-70.0	436								
	Silty CLAY, Sandy, gray moderate plasticity (CL)		S/H								See plot
	Sample includes about 25% fine to coarse Sand and fine Gravel size particles (sub-rounded to subangular in shape)		436.1								

FILE NO. 1255
DATE July 1974

PROJECT: BELLE RIVER PLANT UNITS I & II
TABLE SUMMARY OF LABORATORY TEST RESULTS SHEET OF

BORING SAMPLE	IDENTIFICATION		TEST NO.	PROPERTIES			STRENGTH		CONSOLI- DATION		OTHER TESTS AND REMARKS	
	SOIL DESCRIPTION	DEPTH (FEET)		NAT. WATER CONTENT (%)	ATTERBERG LIMITS w _L w _P	DRY UNIT WEIGHT (PCF)	TEST TYPE	ε %	MAX. SHEAR STRESS (PSF)	e ₀		C _c
30/21	Jar Sample	98.5 - 100.0	—									
	Silty fine SAND, uniform fine Sand grains with about 15% non plastic fines (SM)		437									
				S437.1								See plot

PROJECT: <u>BELLE RIVER PLANT UNITS I & II</u> FILE NO. <u>1255</u>												
TABLE <u> </u> SUMMARY OF LABORATORY TEST RESULTS DATE <u>July 1974</u>												
SHEET <u> </u> OF <u> </u>												
BORING SAMPLE	IDENTIFICATION	DEPTH (FEET)	TEST NO.	PROPERTIES				STRENGTH		CONSOLIDATION		OTHER TESTS AND REMARKS
				NAT. WATER CONTENT (%)	ATTERBERG LIMITS w _L w _p	DRY UNIT WEIGHT (PCF)	TEST TYPE	ε %	MAX. SHEAR STRESS (PSF)	e _o	c _c	
30/25	Jar Sample	118.5- 120.0	438									
	Silty SAND, subrounded to subangular fine to medium Sand grains, about 15% non-plastic fines (SM)		S438.1									See plot

PROJECT: BELLE RIVER PLANT UNITS I & II

FILE NO. 1255

DATE July 1974

TABLE SUMMARY OF LABORATORY TEST RESULTS SHEET OF

BORING SAMPLE	IDENTIFICATION		TEST NO.	PROPERTIES			STRENGTH		CONSOLIDATION		OTHER TESTS AND REMARKS
	SOIL DESCRIPTION	DEPTH (FEET)		NAT. WATER CONTENT (%)	ATTERBERG LIMITS WL WP	DRY UNIT WEIGHT (PCF)	TEST TYPE	ε %	MAX SHEAR STRESS (PSF)	e ₀	
32/3	Jar Sample	6.0-7.5	439								
	Silty CLAY, dark grayish brown, moderate to highly plastic (CL-CH)		W499.1	20.3*							

*Note: Water content taken from unsealed jar sample

PROJECT: BELLE RIVER PLANT UNITS I & II		FILE NO. 1255								
TABLE SUMMARY OF LABORATORY TEST RESULTS		DATE July 1974								
IDENTIFICATION		SHEET OF								
BORING SAMPLE	SOIL DESCRIPTION	DEPTH (FEET)	TEST NO.	PROPERTIES		STRENGTH		CONSOLIDATION		OTHER TESTS AND REMARKS
				NAT. WATER CONTENT (%)	ATTERBERG LIMITS w _L w _P	DRY UNIT WEIGHT (PCF)	TEST TYPE	ε %	MAX. SHEAR STRESS (PSF)	
32/7	Jar Sample	23.5-25.0	440							
	Silty CLAY, dark grayish brown, moderate to high plasticity (CL-GH)		W440.1	37.9*						
	*Note: Water content taken from unsealed jar sample									

PROJECT: BELLE RIVER PLANT UNITS I & II

TABLE SUMMARY OF LABORATORY TEST RESULTS

FILE NO. 1255

DATE July 1974

SHEET OF

BORING SAMPLE	IDENTIFICATION		DEPTH (FEET)	TEST NO.	PROPERTIES			STRENGTH		CONSOLIDATION		OTHER TESTS AND REMARKS		
					NAT. WATER CONTENT (%)	ATTERBERG LIMITS		DRY UNIT WEIGHT (PCF)	TEST TYPE	ε %	MAX. SHEAR STRESS (PSF)		e ₀	C _c
						w _L	w _P							
32/10	Jar Sample		38.5-40.0	441										
	Silty CLAY, gray, moderate to high plasticity (CL)		L41.1		44	19								

IDENTIFICATION		TEST NO.	PROPERTIES			STRENGTH		CONSOLIDATION		OTHER TESTS AND REMARKS	
BORING SAMPLE	SOIL DESCRIPTION		DEPTH (FEET)	NAT. WATER CONTENT (%)	ATTERBERG LIMITS w _L w _P	DRY UNIT WEIGHT (PCF)	TEST TYPE	ε %	MAX. SHEAR STRESS (PSF)		e ₀
32/20	Jar Sample	—									
	Silty CLAY, gray, moderate plasticity (CL) Sample includes about 10% fine to coarse Sand grains (subrounded to subangular in shape)	88.5-									
		90.0	442								
			L4421		36	17					

PROJECT: BELLE RIVER PLANT UNITS I & II

FILE NO. 1255

DATE July 1974

TABLE SUMMARY OF LABORATORY TEST RESULTS

SHEET 1 OF 1

BORING SAMPLE	IDENTIFICATION		TEST NO.	PROPERTIES			STRENGTH		CONSOLIDATION		OTHER TESTS AND REMARKS
	SOIL DESCRIPTION	DEPTH (FEET)		NAT. WATER CONTENT (%)	ATTERBERG LIMITS w _L w _P	DRY UNIT WEIGHT (PCF)	TEST TYPE	ε %	MAX. SHEAR STRESS (PSF)	e _o	
33/3*	1.4' Recovery; say 8.0' to 9.4' depth	8.0-10.5	280								
	Silty CLAY, dark grey, firm to stiff consistency, moderate to high plasticity (CL-CH) Sample includes about 5% fine to medium Sand grains (sub-rounded to subangular in shape) *Note: This sample labeled B33/2, 8'-10'6"	8.1-8.4	Saved								
		8.4-8.5	W280.1	30.6		92					
		8.5	TV								TV = 0.78tsf
		8.5-8.8	Saved								
		8.8	TV								TV = 0.68tsf
		8.8-9.2	L280.1				31.6	48	25		
		9.2-9.3	W280.2				33.3		89		

PROJECT: BELLE RIVER PLANT UNITS I & II												FILE NO. 1255			
TABLE SUMMARY OF LABORATORY TEST RESULTS												DATE			
IDENTIFICATION												SHEET		OF	
BORING SAMPLE	SOIL DESCRIPTION	DEPTH (FEET)	TEST NO.	PROPERTIES			STRENGTH		CONSOLIDATION		OTHER TESTS AND REMARKS				
				NAT. WATER CONTENT (%)	ATTERBERG LIMITS w _L w _p	DRY UNIT WEIGHT (PCF)	TEST TYPE	ε %	MAX. SHEAR STRESS (PSF)	e ₀		c _c			
33/5	Silly CLAY, gray, firm consistency, moderate to high plasticity (CL) Sample includes about 5% fine to coarse Sand grains (sub-rounded to subangular in shape) Note: This sample and 33/9 labeled B33/5, 38-40'6"	18.0-18.5	—												
		18.2-18.5	282												
		18.5-18.6	Saved												
			W282.1	34.7	86										
			18.6	TV							TV=0.29 tsf				
			18.6-19.0	L282.1	37.6	43	23								
			19.7-19.8	W282.1	36.2	84									
			19.8	TV							TV=0.32 tsf				
			19.8-20.3	Saved											

PROJECT: BELLE RIVER PLANT UNITS I & II

TABLE SUMMARY OF LABORATORY TEST RESULTS

FILE NO. 1255

DATE July 1974

SHEET OF

BORING SAMPLE	IDENTIFICATION		DEPTH (FEET)	TEST NO.	PROPERTIES			STRENGTH		CONSOLIDATION		OTHER TESTS AND REMARKS
					NAT. WATER CONTENT (%)	ATTERBERG LIMITS w _L w _P	DRY UNIT WEIGHT (PCF)	TEST TYPE	MAX. SHEAR STRESS (PSF)	e ₀	c _c	
33/7*	2.1' Recovery, say 28.0' to 30.1' depth		28.0-30.5	281								
	Silty CLAY, gray, soft to firm consistency, moderate to high plasticity (CL)		28.1-28.4	save								
			28.4-28.6	W281.1	40.3	81						
			28.6	TV								TV=0.20 tsf
			28.6-28.9	T281.11	39.0	82		CU	13.4	739		$\bar{\sigma}_c=1440$ psf
			28.9-29.3	T281.12	39.7	82		CU	4.6	966		$\bar{\sigma}_c=2880$ psf
	Sample includes about 5% fine to medium Sand grains (subrounded to subangular in shape)		29.3-29.4	W281.1	37.7	83						
			29.4	TV								TV=0.26 tsf
			29.4-29.7	T281.13	38.3	84		CU	6.3	1521		$\bar{\sigma}_c=5760$ psf
	* Note: This sample labeled B33/4, 28'-30'6"		29.4-29.7	L281.1	38.7	46	22					

PROJECT: BELLE RIVER PLANT UNITS I & II		FILE NO. 1255									
TABLE SUMMARY OF LABORATORY TEST RESULTS		DATE July 1974									
IDENTIFICATION		SHEET OF									
BORING SAMPLE	SOIL DESCRIPTION	DEPTH (FEET)	TEST NO.	PROPERTIES			STRENGTH		CONSOLIDATION		OTHER TESTS AND REMARKS
				NAT. WATER CONTENT (%)	ATTERBERG LIMITS w _L w _P	DRY UNIT WEIGHT (PCF)	TEST TYPE	ε %	MAX. SHEAR STRESS (PSF)	e ₀	
33/9*	2.1' Recovery; say 38.0' to 40.1' depth	38.0-40.5	283								
		38.3-38.6	Saved								
	Silty CLAY, grey, soft to firm consistency, moderate to high plasticity (CL)	38.6-38.7	W283.1	36.8		85					
		38.7	TV								TV = 0.27tsf
		38.7-									
		39.1	T283.1.1	37.4		83	CU	6.9	798		$\bar{\sigma}_c = 1728 \text{psf}$
		38.7-									
		39.1	T283.1.2	37.1		85	CU	5.5	1081		$\bar{\sigma}_c = 3456 \text{psf}$
		39.1-									
	* Note: This sample labeled B33/5, 38'-40'6"	39.5	T283.1.3	36.2		86	CU	5.2	1662		$\bar{\sigma}_c = 6912 \text{psf}$
		39.1-									
		39.5	L283.1	37.2	43	23					
		39.5-									
		39.6	W283.2	37.3		85					
		39.6	TV								TV = 0.28tsf
		39.6-									
		39.9	Saved								
		39.9	St								TV = 0.35tsf TV _r = 0.09tsf

PROJECT: BELLE RIVER PLANT UNITS I & II													FILE NO. 1255	
TABLE SUMMARY OF LABORATORY TEST RESULTS													DATE July 1974	
													SHEET OF	
IDENTIFICATION			TEST NO.		PROPERTIES			STRENGTH		CONSOLIDATION		OTHER TESTS AND REMARKS		
BORING SAMPLE	SOIL DESCRIPTION	DEPTH (FEET)			NAT. WATER CONTENT (%)	ATTERBERG LIMITS w _L w _P	DRY UNIT WEIGHT (PCF)	TEST TYPE	ε %	MAX. SHEAR STRESS (PSF)	e _o	c _c		
33/11*	1.9' Recovery; say 48.0' to 49.9' depth	48.0-50.5	284											
		48.1-48.4	saved											
	Silty CLAY, dark gray, firm to stiff consistency, moderate to high plasticity (CL-CH)	48.4-48.5	W284.1		45.1		76							
		48.5	TV										TV = 0.30 tsf	
		48.5-48.8	saved											
	Sample contains about 10% fine to coarse SAND grains (subrounded to subangular in shape)	48.8-49.0	L284.1		41.8	48 25								
		49.0-49.3	saved											
		49.3-49.4	W284.2		34.5		81							
	* Note: This sample labeled B33/6 48'-50'6"													

PROJECT: BELLE RIVER PLANT UNITS I & II
 TABLE SUMMARY OF LABORATORY TEST RESULTS

FILE NO. 1255
 DATE Jan. 1974
 SHEET OF

IDENTIFICATION		TEST NO.	PROPERTIES			STRENGTH		CONSOLIDATION		OTHER TESTS AND REMARKS		
BORING SAMPLE	SOIL DESCRIPTION		DEPTH (FEET)	NAT. WATER CONTENT (%)	ATTERBERG LIMITS w _L w _P	DRY UNIT WEIGHT (PCF)	TEST TYPE	ε %	MAX. SHEAR STRESS (PSF)		e ₀	C _c
B38/3	Silty CLAY; dark grayish brown mottled with blue gray, highly plastic; hard consistency with a blocky structure. Soil includes 5 to 10% coarse Sand and fine Gravel size particles (subrounded to sub-angular in shape) (CL-GH)	8.0 to 10.0										
		17										
		W17.1	8.5	25.3								
		TV	8.5	25.3								TV=2.4 tsf
		L17.1	8.6 to 8.9	24.9	49	24						
		U17.1	8.6 to 8.9	24.3			102	U	3.0	212.3		
		UR17.1	8.6 to 8.9	24.2			103	UR	7.0	761		
		H17.1	8.6 to 8.9									see plot
		W17.2	9.0	26.3								
		ST	9.0	26.3								TV=2.1 tsf
		save	9.1 to 9.5									TV=1.1
		W17.3	9.6	27.3								
	TV	9.9	27.3								TV-2.1 tsf	

PROJECT: BELLE RIVER PLANT UNITS I & II												FILE NO. 1255			
TABLE SUMMARY OF LABORATORY TEST RESULTS												DATE Jan. 1974			
IDENTIFICATION												SHEET		OF	
BORING SAMPLE	SOIL DESCRIPTION	DEPTH (FEET)	TEST NO.	PROPERTIES			STRENGTH		CONSOLIDATION		OTHER TESTS AND REMARKS				
				NAT. WATER CONTENT (%)	ATTERBERG LIMITS w _L w _P	DRY UNIT WEIGHT (PCF)	TEST TYPE	ε %	MAX. SHEAR STRESS (PSF)	e ₀		c _c			
B38/4	1.8' Recovery; say 13.5' to 15.3' depth; upper 0.2' disturbed	13.5 to 15.5	18												
		13.8 to 14.2	save 18.1												
		14.2	W18.1	28.6											
	Silty CLAY; dark grayish brown, highly plastic, stiff to very stiff consistency.	14.2	TV	28.6							TV=1.1 tsf				
		14.3 to 14.6	UI8.1	28.5		96	U	4.0	1506						
	Soil includes 5 to 10% coarse Sand and fine Gravel size particles (subrounded to subangular in shape)	14.3 to 14.6	L18.1	28.5	46	22									
	(CL-CH)	14.6	H18.1								see plot				
		14.6	C18.1	29.0						.770	specific gravity=2.71				
		14.6	SG18.1												
		14.7	W18.2	28.8											
		14.7	TV	28.8							TV=0.9 t sf				
		14.8 to 15.2	save 18.2												

BORING SAMPLE	IDENTIFICATION	DEPTH (FEET)	TEST NO.	PROPERTIES			STRENGTH		CONSOLIDATION		OTHER TESTS AND REMARKS	
				NAT. WATER CONTENT (%)	ATTERBERG LIMITS WL WP	DRY UNIT WEIGHT (PCF)	TEST TYPE	MAX. SHEAR STRESS (PSF)	e_0	c_c		
B38/6	Recovery 0.7'; say 23.5' to 24.2' depth	23.5 to 25.5 23.7 to 24.1	— 19 19.1	37.6	48 19							
	Silty CLAY, dark gray, highly plastic (CL-CH) Note: Entire sample greatly disturbed	24.1	W19.1	37.6	—							

PROJECT: BELLE RIVER PLANT UNITS I & II

FILE NO. 1255

DATE Jan. 1974

TABLE SUMMARY OF LABORATORY TEST RESULTS

SHEET

OF

BORING SAMPLE	IDENTIFICATION		TEST NO.	PROPERTIES				STRENGTH		CONSOLIDATION		OTHER TESTS AND REMARKS	
	SOIL DESCRIPTION	DEPTH (FEET)		NAT. WATER CONTENT (%)	ATTERBERG LIMITS wL wP	DRY UNIT WEIGHT (PCF)	TEST TYPE	ε %	MAX. SHEAR STRESS (PSF)	e ₀	c _c		
B38/8	0.8' Recovery; say 33.5' to 34.3' depth	33.5 to 35.5	20										
		34.1	W20.1	35.7									
	Silty CLAY, dark gray, highly plastic (CL-CH)	34.1 to 34.3	L20.1	36.3	48	20							
	Note: Entire sample greatly disturbed												

PROJECT: BELLE RIVER PLANT UNITS I & II
 TABLE SUMMARY OF LABORATORY TEST RESULTS

FILE NO. 1255
 DATE Jan. 1974
 SHEET OF

IDENTIFICATION		TEST NO.	PROPERTIES			STRENGTH		CONSOLIDATION		OTHER TESTS AND REMARKS
BORING SAMPLE	SOIL DESCRIPTION		DEPTH (FEET)	NAT. WATER CONTENT (%)	ATTERBERG LIMITS w _L w _p	DRY UNIT WEIGHT (PCF)	TEST TYPE	€ %	MAX. SHEAR STRESS (PSF)	
B38/12	1.8' Recovery; say 53.5' to 55.3'	22								
		W22.1	33.7							
		TV	33.7							IV=0.36 tsf
		save								
		22.1								
		W22.2	33.1							
		TV	33.1							IV=0.41 tsf
		U22.1	33.4		90	U	5.0	985		
			32.9	44	21					
		H22.1								See plot
		W22.3	33.5							
		TV	33.5							
		save								
		22.2								IV=0.44 tsf

PROJECT: BELLE RIVER PLANT UNITS I & II		FILE NO. 1255											
TABLE SUMMARY OF LABORATORY TEST RESULTS		DATE Jan. 1974											
IDENTIFICATION		SHEET ___ OF ___											
BORING SAMPLE	SOIL DESCRIPTION	DEPTH (FEET)	TEST NO.	PROPERTIES			STRENGTH		CONSOLIDATION		OTHER TESTS AND REMARKS		
				NAT. WATER CONTENT (%)	ATTERBERG LIMITS w _L w _P	DRY UNIT WEIGHT (PCF)	TEST TYPE	ε %	MAX. SHEAR STRESS (PSF)	e _o		c _c	
B38/16	0.6' Recovery; say 73.5' to 74.1' depth	73.5 to 75.5	24										
		73.6	TV	43.5								TV=0.27 tsf	
	Silty CLAY, dark gray, highly plastic, soft to firm consistency (CH)	73.6	W24.1	43.5									
		73.7 to 74.0	U24.1	41.3	79	U	4.8	704					
		73.7 to 74.0	L24.1	41.3	55	24							
		73.7 to 74.0	H24.1									See plot	
		74.0 to 74.1	C24.1	36.0					.935	.33		specific gravity=2.72	
		74.0 to 74.1	SC24.1										
		74.0 to 74.1	W24.2	40.7									

FILE NO. 1255

DATE Jan. 1974

SHEET OF

PROJECT: BELLE RIVER PLANT UNITS I & II

SUMMARY OF LABORATORY TEST RESULTS

TABLE

IDENTIFICATION

TEST NO.

PROPERTIES

ATTERBERG LIMITS

W_L W_P

STRENGTH

TEST TYPE

MAX. SHEAR STRESS (PSF)

CONSOLIDATION

e₀

OTHER TESTS AND REMARKS

BORING SAMPLE	SOIL DESCRIPTION	DEPTH (FEET)	TEST NO.	NAT. WATER CONTENT (%)	ATTERBERG LIMITS		DRY UNIT WEIGHT (PCF)	TEST TYPE	MAX. SHEAR STRESS (PSF)	CONSOLIDATION	OTHER TESTS AND REMARKS
					W _L	W _P					
B38/18	1.5' Recovery; say 83.5' to 85.0' depth Silty CLAY; gravelly dark gray, moderate plasticity, stiff consistency (CL) Includes ±10 % medium to coarse Sand and ±15% sub-angular to subrounded Gravel size particles (1/4" to 1" size)	83.5 to 85.5	25								
		83.7	TV	14.4							TV=0.78 tsf
		83.7	W25.1	14.4							
		83.7 to 84.1	save								
		84.1	25.1								
		84.1	TV	17.8							TV=0.82 tsf
		84.1	W25.2	17.8							
		84.2 to 84.6	save								
		84.6	25.2								
		84.6	St	22.8							
		84.6	W25.3	22.8							
		84.6 to 85.0	U25.1	22.2			104	U	14.0	603	
	84.6 to 85.0	U25.1	22.2			105	Ur	17.4	548		
	84.6 to 85.0	L25.1	22.2	33	19						
	84.6 to 85.0	H25.1								See plot	

PROJECT: BELLE RIVER PLANT UNITS I & II

FILE NO. 1255

DATE Jan. 1974

SUMMARY OF LABORATORY TEST RESULTS

SHEET ___ OF ___

IDENTIFICATION		DEPTH (FEET)	TEST NO.	PROPERTIES			STRENGTH		CONSOLIDATION		OTHER TESTS AND REMARKS	
BORING SAMPLE	SOIL DESCRIPTION			NAT. WATER CONTENT (%)	ATTERBERG LIMITS w _L w _P	DRY UNIT WEIGHT (PCF)	TEST TYPE	ε %	MAX. SHEAR STRESS (PSF)	e ₀		C _c
B38/24	1.9' Recovery; say 113.0' to 114.9' depth Silty CLAY; gray, moderately to highly plastic, soft to firm consistency (CL-CH) Includes about 5% fine Sand size particles	113.0 to 115.0	26									
		113.3	TV		34.5							TV=0.32 tsf
		113.3	W26.1		34.5							
		113.3 to 113.7	save 26.1									
		113.7	TV		32.2							TV=0.48 tsf
		113.7	W26.2		32.2							
		113.7 to 114.1	save 26.2									
		114.1	TV		33.1							TV=0.44 tsf
		114.1	W26.3		33.1							
		114.1 to 114.6	U26.1		31.9	92	U	6.0	500			
		114.1 to 114.6	L26.1		31.9	45	25					
		114.1 to 114.6	H26.1									See plot
		114.6	TV									TV=0.52 tsf

FILE NO. 1255
DATE Jan. 1974

PROJECT: BELLE RIVER PLANT UNITS I & II
TABLE SUMMARY OF LABORATORY TEST RESULTS

SHEET OF

IDENTIFICATION		TEST NO.	PROPERTIES			STRENGTH		CONSOLIDATION		OTHER TESTS AND REMARKS
BORING SAMPLE	SOIL DESCRIPTION		NAT. WATER CONTENT (%)	ATTERBERG LIMITS <u>w_L</u> <u>w_p</u>	DRY UNIT WEIGHT (PCF)	TEST TYPE	ϵ %	e_0	c_c	
B38/30	Jar Sample Silty SAND; subrounded to subangular fine to coarse Sand grains, about 30% non-plastic fines (SM)	—								See plot

PROJECT: BELLE RIVER PLANT UNITS I & II		FILE NO. 1255									
TABLE SUMMARY OF LABORATORY TEST RESULTS		DATE Jan. 1974									
IDENTIFICATION		SHEET 1 OF 1									
BORING SAMPLE	SOIL DESCRIPTION	DEPTH (FEET)	TEST NO.	PROPERTIES			STRENGTH		CONSOLIDATION		OTHER TESTS AND REMARKS
				NAT. WATER CONTENT (%)	ATTERBERG LIMITS w _L w _P	DRY UNIT WEIGHT (PCF)	TEST TYPE	ε %	MAX. SHEAR STRESS (PSF)	e ₀	
B41/2	1.1' Recovery; say 4.0' to 5.1' depth	4.0 to 6.0	28								
		4.1	W28.1	33.6							
	Silty CLAY; olive gray mottled with yellowish brown, highly plastic, very stiff consistency throughout	4.1	TV	33.6							TV=1.0 tsf
		4.1 to 4.4	save 28.1								
		4.4	W28.2	31.1							
	Soil includes 2 to 5% coarse Sand and fine Gravel size particles (subrounded to sub-angular in shape)	4.4	TV	31.1							TV=1.1 tsf
		4.5 to 4.8	U28.1	29.4		94	U	5.0	1024		
		4.5 to 4.8	Up28.1	29.4		95	Up	9.0	974		
	(CH)	4.5 to 4.8	L28.1	29.4	63	28					
		4.5 to 4.8	H28.1								See plot
		4.8	W28.3	39.5							
		4.8	ST	39.5							TV=1.4 tsf TV _R =1.0 tsf
		4.9 to 5.1	save 28.2								

PROJECT: BELLE RIVER PLANT UNITS I & II		FILE NO. 1255									
TABLE SUMMARY OF LABORATORY TEST RESULTS		DATE Jan. 1974									
IDENTIFICATION		SHEET OF									
BORING SAMPLE	SOIL DESCRIPTION	DEPTH (FEET)	TEST NO.	PROPERTIES			STRENGTH		CONSOLIDATION		OTHER TESTS AND REMARKS
				NAT. WATER CONTENT (%)	ATTERBERG LIMITS w _L w _P	DRY UNIT WEIGHT (PCF)	TEST TYPE	ε %	MAX. SHEAR STRESS (PSF)	e ₀	
B41/5	1.2' Recovery: say 10.0' to 11.2' depth	10.0 to 12.0	29								
		10.3	TV	29.0							TV=1.25 tsf
	Silty CLAY, grayish brown, very stiff consistency, highly plastic (CL-CH)	10.3	W29.1	29.0							
		10.3 to 10.7	save 29.1								
	Includes about 15% subangular to subrounded fine Gravel and coarse Sand particles	10.7	TV	27.5							TV=1.43 tsf
		10.7 to 10.8	W29.2	27.5							
		10.8 to 11.0	C29.1	29.5						.799	.23
		10.8 to 11.0	I29.1	29.5	46	23					
		11.1 to 11.2	W29.3	28.9							

PROJECT: BELLE RIVER PLANT UNITS I & II		FILE NO. 1255										
TABLE SUMMARY OF LABORATORY TEST RESULTS		DATE Jan. 1974										
IDENTIFICATION		SHEET OF										
BORING SAMPLE	SOIL DESCRIPTION	DEPTH (FEET)	TEST NO.	PROPERTIES			STRENGTH		CONSOLIDATION		OTHER TESTS AND REMARKS	
				NAT. WATER CONTENT (%)	ATTERBERG LIMITS w _L w _P	DRY UNIT WEIGHT (PCF)	TEST TYPE	ε %	MAX. SHEAR STRESS (PSF)	e ₀		c _c
B 41/7	Silty CLAY, dark gray, highly plastic; soft to firm consistency throughout (CL-CH)	20.0 to 22.0	30									
		20.5	W30.1	39.7								
		20.5	TV	39.7								TV=0.28 tsf
		20.6 to 20.9	U30.1	39.2			83	3.0	338			
		20.6 to 20.9	L30.1	39.2	47	24						
		20.6 to 20.9	H30.1									See plot
		21.0 to 21.1	C30.1	38.1						1.055	.34	Specific gravity=2.70
		21.0 to 21.1	SG30.1									
		21.1	W30.2	39.4								TV=0.30 tsf
		21.1	TV	39.4								
		21.1 to 21.5	save 30.1									
		21.5	W30.3	38.2								
		21.5	TV	38.2								TV=0.30 tsf

PROJECT: BELLE RIVER PLANT UNITS I & II
 TABLE SUMMARY OF LABORATORY TEST RESULTS

FILE NO. 1255
 DATE Jan. 1974
 SHEET OF

IDENTIFICATION		DEPTH (FEET)	TEST NO.	PROPERTIES			STRENGTH		CONSOLIDATION		OTHER TESTS AND REMARKS
BORING SAMPLE	SOIL DESCRIPTION			NAT. WATER CONTENT (%)	ATTERBERG LIMITS w _L w _P	DRY UNIT WEIGHT (PCF)	TEST TYPE	ε %	MAX. SHEAR STRESS (PSF)	e ₀	
B41/9	1.7' Recovery; say 30.0' to 31.7' depth	30.0 to 32.0	31								
		30.4	TV	36.6							TV=0.30 tsf
		30.4 to 30.5	W31.1	36.6							
	Silty CLAY, gray, firm consistency, highly plastic (CL-CH)	30.5 to save									
		30.8	31.1								
		30.8	TV	35.6							TV=0.28 tsf
		30.8 to 30.9	W31.2	35.6							
	Includes about 5% subangular to subrounded coarse Sand particles	30.9 to 31.2	U31.1	36.9	86	U	15.0	696			
		30.9 to 31.2	I31.1	36.9	45	21					
	Note: Upper 0.4' of sample disturbed	31.2	TV	36.1							TV=0.32 tsf
		31.2 to 31.3	W31.3	36.1							
		31.3 to save									
		31.6	31.2								

PROJECT: BELLE RIVER PLANT UNITS I & II
 TABLE SUMMARY OF LABORATORY TEST RESULTS

FILE NO. 1255
 DATE Jan. 1974
 SHEET ___ OF ___

BORING SAMPLE	IDENTIFICATION		DEPTH (FEET)	TEST NO.	PROPERTIES			STRENGTH		CONSOLIDATION		OTHER TESTS AND REMARKS
					NAT. WATER CONTENT (%)	ATTERBERG LIMITS WL WP	DRY UNIT WEIGHT (PCF)	TEST TYPE	MAX. SHEAR STRESS (PSF)	e _o	c _c	
B41/11	1.1' Recovery; say 40.0' to 41.1' depth		40.0 to 42.0	32								
			40.2	TV	16.8							TV=0.30 tsf
	Silty CLAY, sandy, very dark gray, about 35% fine to coarse Sand, ±10% sub-angular to subrounded fine Gravel size particles, fines of low plasticity		40.2	W32.1	16.8							
			40.2 to 40.6	save 32.1								
			40.6	ST	16.5							TV=0.34 tsf TV=0.28 tsf
	(CL-SC)		40.6	W32.2	16.5							
			40.6 to 41.0	U32.1	16.0				U 20.0	884		@15.0% strain s = 648 psf
			40.6 to 41.0	L32.1	16.0	20	12					
			40.6 to 41.0	S/H 32.1								See plot

FILE NO. 1255

DATE Jan. 1974

PROJECT: BELLE RIVER PLANT UNITS I & II

SHEET OF

TABLE SUMMARY OF LABORATORY TEST RESULTS

BORING SAMPLE	IDENTIFICATION		DEPTH (FEET)	TEST NO.	PROPERTIES			STRENGTH		CONSOLIDATION		OTHER TESTS AND REMARKS	
	SOIL DESCRIPTION	NAT. WATER CONTENT (%)			ATTERBERG LIMITS w_L w_P	DRY UNIT WEIGHT (PCF)	TEST TYPE	ϵ %	MAX. SHEAR STRESS (PSF)	e_0	C_c		
B41/13	1.5' Recovery; say 52.0' to 53.5' depth; upper 0.3' disturbed Silty CLAY, gray, soft to firm consistency, highly plastic (CL-CH)		52.0 to 54.0	33									
			52.3	IV		47.5							TV=0.21 tsf
			52.3 to 52.4	W33.1		47.5							
			52.4 to 52.7	save 33.1				76					
			52.7	IV		45.5							TV=0.23 tsf
			52.7 to 52.8	W33.2		45.5							
			53.0 to 53.2	C33.1		46.5					1.235	.35	
			53.0 to 53.2	L33.1		46.5	52	25					
			53.2	ST		44.1							
			53.2 to 53.3	W33.3		44.1							

PROJECT: BELLE RIVER PLANT UNITS I & II

FILE NO. 1255

DATE March 10, 1974

SUMMARY OF LABORATORY TEST RESULTS

SHEET

OF

BORING SAMPLE	IDENTIFICATION	DEPTH (FEET)	TEST NO.	PROPERTIES			STRENGTH		CONSOLIDATION		OTHER TESTS AND REMARKS	
				NAT. WATER CONTENT (%)	ATTERBERG LIMITS WL WP	DRY UNIT WEIGHT (PCF)	TEST TYPE	MAX. SHEAR STRESS (PSF)	e _o	c _c		
B41/17	1.0' Recovery; say 72.5' to 73.5' depth; upper 0.1' is 'wash' disturbed sample (?) Silty CLAY, sandy, dark gray, soft to firm consistency; sand occurs primarily as pockets of Silty fine Sand (±30% of sample) (CL-SC) Also 5% to 10% Gravel size particles throughout	72.5 to 74.5	—									
		35										
		72.8	W35.1	17.1								
		72.8	TV								TV=0.15 tsf	
		72.9 to 73.2	T35.0	19.6			105	UU	14.0	454		
		72.9 to 73.2	L35.1	19.6	25	15						
		72.9 to 73.2	S/H									See plot
		73.2	35.1									
		73.3	C35.1	26.7						697	21	Specific Gravity=2.68
		73.3	SG35.1									

PROJECT: BELLE RIVER PLANT UNITS I & II FILE NO. 1255
 TABLE SUMMARY OF LABORATORY TEST RESULTS DATE Jan. 1974
 SHEET OF

IDENTIFICATION		TEST NO.	PROPERTIES			STRENGTH		CONSOLIDATION		OTHER TESTS AND REMARKS		
BORING SAMPLE	SOIL DESCRIPTION		DEPTH (FEET)	NAT. WATER CONTENT (%)	ATTERBERG LIMITS w _L w _P	DRY UNIT WEIGHT (PCF)	TEST TYPE	ε %	MAX. SHEAR STRESS (PSF)		e ₀	c _c
B41/23	Silty CLAY, dark gray, moderate plasticity, firm consistency (CL); includes 10% to 15% fine to coarse Sand and fine Gravel size particles	101.0 to 103.0										
		101.3	TV	23.2								TV=0.46 tsf
		101.3	W37.1	23.2								
		101.3 to 101.8	save 37.1									
		101.8	TV	25.4								TV=0.62 tsf
		101.8	W37.2	25.4								
		101.9 to 102.3	U37.1	26.4		99	U	10.0	534			
		101.9 to 102.3	L37.1	26.4	34	20						
		101.9 to 102.3	HB7.1									See plot

PROJECT: BELLE RIVER PLANT UNITS I & II		FILE NO. 1255									
TABLE SUMMARY OF LABORATORY TEST RESULTS		DATE Jan. 1974									
IDENTIFICATION		SHEET OF									
BORING SAMPLE	SOIL DESCRIPTION	DEPTH (FEET)	TEST NO.	PROPERTIES			STRENGTH		CONSOLIDATION		OTHER TESTS AND REMARKS
				NAT. WATER CONTENT (%)	ATTERBERG LIMITS w_L w_P	DRY UNIT WEIGHT (PCF)	TEST TYPE	ϵ %	MAX. SHEAR STRESS (PSF)	e_o	
B41/25	1.7 Recovery; say 112.0' to 113.7' depth	112.0 to 114.0	38								
		112.3	TV	20.9							TV=0.65 tsf
	Silty CLAY, dark gray, stiff consistency, moderately plastic (CL)	112.3 to 112.4	W38.1	20.9							
		112.4 to 112.7	save 38.1								
		112.7	TV	24.0							TV=0.60 tsf
	Includes about 35% subrounded to subangular fine Gravel and coarse Sand particles	112.7 to 112.8	W38.2	24.0							
		113.0 to 113.2	C38.1	24.2					.642	.18	
		113.0 to 113.2	L38.1	24.2	29	19	104				
		113.2	TV	19.4							TV=1.0 tsf
		113.2 to 113.3	W38.3	19.4							
		113.3 to 113.7	save 38.2								

PROJECT: BELLE RIVER PLANT UNITS I & II
 TABLE SUMMARY OF LABORATORY TEST RESULTS

FILE NO. 1255
 DATE Jan. 1974
 SHEET OF

BORING SAMPLE	IDENTIFICATION		TEST NO.	PROPERTIES			STRENGTH		CONSOLIDATION		OTHER TESTS AND REMARKS
	SOIL DESCRIPTION	DEPTH (FEET)		NAT. WATER CONTENT (%)	ATTERBERG LIMITS w _L w _P	DRY UNIT WEIGHT (PCF)	TEST TYPE	ε %	MAX. SHEAR STRESS (PSF)	e ₀	
B41/29	1.1' Recovery; say 130.0' to 131.1' depth	130.0 to 132.0	40								
		130.2	TV	14.7							TV=0.50 tsf
	Clayey SAND, gravelly, dark gray; about 35% fine to coarse Sand particles and ±10% sub-rounded Gravel size particles; fines of low plasticity (GC-SC)	130.2	W40.1	14.7							
		130.2 to 130.6	save								
		130.6	40.1								
		130.6	W40.2		10.9						
		130.6 to 130.9	U40.1		13.8		124	8.0	1749		
		130.6 to 130.9	L40.1		13.8	25	17				
		130.6 to 130.9	S/H								
		130.9 to 131.1	40.1								
		130.9 to 131.1	C40.1		11.3					.370	.09
		130.9 to 131.1	SC40.1								
											See plot
											Specific Gravity = 2.69

PROJECT: BELLE RIVER PLANT UNITS I & II			FILE NO. 1255		DATE Jan. 1974		SHEET ____ OF ____			
TABLE SUMMARY OF LABORATORY TEST RESULTS				STRENGTH		CONSOLIDATION		OTHER TESTS AND REMARKS		
IDENTIFICATION		TEST NO.	PROPERTIES		TEST TYPE	€ %	MAX. SHEAR STRESS (PSF)	e ₀	Cc	
BORING SAMPLE	SOIL DESCRIPTION		DEPTH (FEET)	ATTERBERG LIMITS						
		NAT. WATER CONTENT (%)		w _L	w _P	DRY UNIT WEIGHT (PCF)				
B48/2	0.9' Recovery; say 3.0' to 3.9' depth	198								
		TV	32.4						TV=0.68 tsf	
	Silty CLAY, dark grayish brown mottled light gray, stiff to very stiff consistency, highly plastic (CH) Sample includes 5-10% medium to coarse Sand grains (subrounded to sub-angular in shape)	W198.1	32.4							
		L198.1	27.3	63	24					
		U198.1	27.3			97	3.2	1466		
			TV							TV=1.18 tsf
			save							
			198.1							

IDENTIFICATION		TEST NO.	PROPERTIES			STRENGTH		CONSOLIDATION		OTHER TESTS AND REMARKS		
BORING SAMPLE	SOIL DESCRIPTION		DEPTH (FEET)	NAT. WATER CONTENT (%)	ATTERBERG LIMITS ω_L ω_P	DRY UNIT WEIGHT (PCF)	TEST TYPE	ϵ %	MAX SHEAR STRESS (PSF)		e_0	C_c
B48/4	Silty CLAY; dark grayish brown, very stiff consistency, moderately to highly plastic (CL-CH) Sample includes about 5% coarse Sand grains (sub-rounded to subangular in shape)	8.0 to 10.0										
		8.5 to 8.7										See plot
		8.7	TV	27.5								TV=1.23 tsf
		8.7 to 8.8	W199.1	27.5								
		8.8 to 9.1	save 199.1			97						
		9.1	TV	28.9								TV=1.23 tsf
		9.1 to 9.2	W199.2	28.9								
		9.2 to 9.5	save 199.2									
		9.5	TV									TV=1.43 tsf
		9.5 to 9.9	save 199.3									

PROJECT: BELLE RIVER PLANT UNITS I & II

FILE NO. 1255

DATE Jan. 1974

SUMMARY OF LABORATORY TEST RESULTS

SHEET OF

IDENTIFICATION		TEST NO.	PROPERTIES		STRENGTH		CONSOLIDATION		OTHER TESTS AND REMARKS	
BORING SAMPLE	SOIL DESCRIPTION		NAT. WATER CONTENT (%)	ATTERBERG LIMITS w _L w _p	DRY UNIT WEIGHT (PCF)	TEST TYPE	ε %	MAX. SHEAR STRESS (PSF)		e _o
B48/6	Recovery 2.3'; say 18.0' to 20.3' depth; upper 0.4' disturbed	—								
		200	18.0 to 20.0							
		TV	18.3	34.4						TV=0.26 tsf
		W200.1	18.3 to 18.4	34.4						
		save	18.4 to 18.7							
		200.1								
		TV	18.7							TV=0.49 tsf
		TV	18.7 to 19.1							
		T200.1.1	19.1	32.8		90	CU	6.5	928	
		L200.1	18.7 to 19.1	34.3	47	25				
		TV	19.1	32.7						
		TV	19.1 to 19.2							
		W200.2	19.2	32.7						
		T200.1.2	19.2 to 19.5	34.2		89	CU	4.5	1304	
		TV	19.5	34.1						TV=0.38 tsf
		TV	19.5 to 19.6							
		W200.3	19.6	34.1						
		T200.1.3	19.6 to 19.9	35.6		88	CU	10.6	1579	

PROJECT: BELLE RIVER PLANT UNITS I & II

FILE NO. 1255

TABLE SUMMARY OF LABORATORY TEST RESULTS

DATE _____

SHEET _____

OF _____

BORING SAMPLE	IDENTIFICATION		TEST NO.	PROPERTIES			STRENGTH		CONSOLIDATION		OTHER TESTS AND REMARKS
	SOIL DESCRIPTION	DEPTH (FEET)		NAT. WATER CONTENT (%)	ATTERBERG LIMITS wL wP	DRY UNIT WEIGHT (PCF)	TEST TYPE	ε %	MAX. SHEAR STRESS (PSF)	e ₀	
B48/10	1.5' Recovery; say 38.0' to 39.5' depth; Upper 1.0' disturbed	38.0 to 40.0	202								
		38.4	TV	40.4							TV = 0.10 tsf
		38.4 to 38.5	W202.1	40.4							
	Silty CLAY, dark gray to very dark gray, soft consistency, highly plastic (CL-CH)	39.0	TV								TV = 0.15 tsf
		39.0 to 39.2	save								
		39.2 to 39.4	C202.1	38.8					1.027	.33	
		39.2 to 39.4	L202.1	38.8	47	24					
		39.2 to 39.4	SC202.1								
		39.2 to 39.4	Y202.1	38.8			82				Specific Gravity=2.73
		39.4	TV	40.0							TV = 0.25 tsf
		39.4 to 39.5	W202.2	40.0							

PROJECT: BELLE RIVER PLANT UNITS I & II

FILE NO. 1255

TABLE SUMMARY OF LABORATORY TEST RESULTS

DATE _____

SHEET _____ OF _____

IDENTIFICATION		TEST NO.	PROPERTIES			STRENGTH		CONSOLIDATION		OTHER TESTS AND REMARKS
BORING SAMPLE	SOIL DESCRIPTION		NAT. WATER CONTENT (%)	ATTERBERG LIMITS w _L w _P	DRY UNIT WEIGHT (PCF)	TEST TYPE	ε %	MAX. SHEAR STRESS (PSF)	e ₀	
B48/14	2.0' Recovery; say 60.0' to 62.6' depth. Upper 0.4' depth disturbed	204								
		TV	26.0							TV = 0.34 tsf
	Silty CLAY, Sandy, dark gray, firm consistency, moderately plastic (CL)	W204.1	26.0							
		L204.1	26.3	34	16					
		UU								
	Sample includes ±35% coarse Sand and fine Gravel size particles (subrounded to sub-angular in shape)	204.1	26.3		99	UU	15.0	746		TV = 0.42 tsf
		TV	25.8							
		W204.2	25.8							
		U204.1	25.2		100	U	15.0	745		
		TV	25.3							TV = 0.38 tsf
		W204.3	25.3							
		save								
		204.2								

PROJECT: BELLE RIVER PLANT UNITS I & II		FILE NO. 1255									
TABLE SUMMARY OF LABORATORY TEST RESULTS		DATE Jan. 1971									
IDENTIFICATION		SHEET OF									
BORING SAMPLE	SOIL DESCRIPTION	DEPTH (FEET)	TEST NO.	PROPERTIES			STRENGTH		CONSOLIDATION		OTHER TESTS AND REMARKS
				NAT. WATER CONTENT (%)	ATTERBERG LIMITS w_L w_p	DRY UNIT WEIGHT (PCF)	TEST TYPE	ϵ %	MAX. SHEAR STRESS (PSF)	e_o	
B48/18	1.5' Recovery: say 78.0' to 79.5' depth	78.0 to 80.0	206								
		78.1	TV	25.6							TV=0.56 tsf
	Silty CLAY; dark gray, stiff consistency, moderately to highly plastic (CL) Sample includes about 15% coarse Sand and fine Gravel size particles (subrounded to subangular in shape)	78.1 to 78.2	W206.1	25.6							
		78.2 to 78.5	save 206.1								
		78.5 to 78.6	L206.1		25.6	36	18				
		78.6	TV		25.6						TV=0.70 tsf
		78.6 to 78.7	W206.2		25.6						
		78.7 to 79.0	save 206.2				100				
		79.0	TV		26.0						TV=0.73 tsf
		79.0 to 79.1	W206.3		26.0						
		79.1 to 79.4	save 206.3								
		79.4	TV								TV=0.63 tsf

PROJECT: BELLE RIVER PLANT UNITS I & II		FILE NO. 1255								
TABLE SUMMARY OF LABORATORY TEST RESULTS		DATE Jan. 1974								
IDENTIFICATION		SHEET OF								
BORING SAMPLE	SOIL DESCRIPTION	DEPTH (FEET)	TEST NO.	PROPERTIES		STRENGTH		CONSOLIDATION		OTHER TESTS AND REMARKS
				NAT. WATER CONTENT (%)	ATTERBERG LIMITS w _L w _P	DRY UNIT WEIGHT (PCF)	TEST TYPE	ε %	MAX. SHEAR STRESS (PSF)	
B48/20	1. 3' Recovery; say 88.0' to 89.3' depth	88.0 to 90.0	207							
		88.2 to 88.3	W207.1	44.51						
	Silty CLAY, dark gray, very soft consistency, highly plastic (CL-CH)	88.9 to 89.0	W207.2	30.2						
		89.0 to 89.2	L207.1	28.2	41	25				
	Sample includes ±10% coarse Sand or fine Gravel size particles (subrounded to subangular)									
	Note: Entire sample much disturbed									

PROJECT: BELLE RIVER PLANT UNITS I & II		FILE NO. 1255									
TABLE SUMMARY OF LABORATORY TEST RESULTS		DATE Jan. 1974									
IDENTIFICATION		SHEET OF									
BORING SAMPLE	SOIL DESCRIPTION	DEPTH (FEET)	TEST NO.	PROPERTIES			STRENGTH		CONSOLIDATION		OTHER TESTS AND REMARKS
				NAT WATER CONTENT (%)	ATTERBERG LIMITS WL WP	DRY UNIT WEIGHT (PCF)	TEST TYPE	MAX. SHEAR STRESS (PSF)	e _o	c _c	
B48/22	2.0' Recovery; say 98.0' to 100.0' depth, upper 0.4' disturbed	98.0 to 100.0	208								
		98.4	TV	27.5							TV=0.45 tsf
		98.4 to 98.5	W208.1	27.5							
	Silty CLAY; dark gray, firm to stiff consistency, moderately to highly plastic (CL)	98.5 to 98.9	T208.1	27.6		97	CU	11.4	4410		TV=0.54 tsf
		98.9	TV								
		98.9 to 99.2	T208.1	26.8		99	CU	11.5	2017		
	Sample includes 15-20% coarse Sand and fine Gravel size particles (subrounded to subangular in shape)	98.9 to 99.2	L208.1	26.8	36	19					
		99.2	TV	26.1							
		99.2 to 99.3	W208.2	26.1							
		99.3 to 99.6	T208.1	26.0		96	CU	11.8	2880		TV=0.52 tsf
		99.6	TV	24.0							
		99.6 to 99.7	W208.3	24.0							
		99.7 to 100.0	save 208.1								

PROJECT: BELLE RIVER PLANT UNITS I & II		FILE NO. 1255									
TABLE SUMMARY OF LABORATORY TEST RESULTS		DATE Jan. 1974									
IDENTIFICATION		SHEET ___ OF ___									
BORING SAMPLE	SOIL DESCRIPTION	DEPTH (FEET)	TEST NO.	PROPERTIES		STRENGTH		CONSOLIDATION		OTHER TESTS AND REMARKS	
				NAT. WATER CONTENT (%)	ATTERBERG LIMITS w _L w _p	DRY UNIT WEIGHT (PCF)	TEST TYPE	ε %	MAX. SHEAR STRESS (PSF)		e _o
48/24	<p>Silty CLAY; dark gray, soft to medium consistency, moderately plastic (CL)</p> <p>Sample contains ±20% coarse to fine Sand and fine Gravel particles (subrounded to sub-angular in shape)</p> <p>Note: Entire sample thoroughly disturbed</p>	108.0 to 110.0	209								
		108.6	TV								TV=0.26 tsf
		108.6 to 108.7	W209.1		25.6						
		108.7 to 109.1	save 209.1		25.6						
		109.1	TV								
		109.1 to 109.2	W209.2		23.0						
		109.6 to 110.0	save 209.2		23.0						

PROJECT: BELLE RIVER PLANT UNITS I & II
 TABLE SUMMARY OF LABORATORY TEST RESULTS

FILE NO. 1255
 DATE _____ OF _____
 SHEET _____ OF _____

IDENTIFICATION		TEST NO.	PROPERTIES			STRENGTH		CONSOLIDATION		OTHER TESTS AND REMARKS
BORING SAMPLE	SOIL DESCRIPTION		NAT. WATER CONTENT (%)	ATTERBERG LIMITS w _L w _P	DRY UNIT WEIGHT (PCF)	TEST TYPE	ε %	MAX. SHEAR STRESS (PSF)	e ₀	
B48/26	2.1' Recovery; say 118.0' to 120.1' depth	210								
		TV	33.2							TV = 0.43 tsf
	Silty CLAY, gray, medium to stiff consistency, moderate to highly plastic (CL)	W210.1	33.2							
		save 210.1								
	Sample includes about 5% fine to coarse Sand sized particles (subrounded to subangular in shape)	save 210.2								
		TV	32.8							TV = 0.51 tsf
		W210.2	32.8							
		W210.1	32.9		91					
		S/H 210.1								See Plot
		TV	33.0							TV = 0.60 tsf
		W210.3	33.0							
		save 210.3								

PROJECT: BELLE RIVER PLANT UNITS I & II
 TABLE SUMMARY OF LABORATORY TEST RESULTS

FILE NO. 1255
 DATE March 1974
 SHEET OF

IDENTIFICATION		TEST NO.	PROPERTIES			STRENGTH		CONSOLIDATION		OTHER TESTS AND REMARKS	
BORING SAMPLE	SOIL DESCRIPTION		DEPTH (FEET)	NAT. WATER CONTENT (%)	ATTERBERG LIMITS w _L w _P	DRY UNIT WEIGHT (PCF)	TEST TYPE	ε %	MAX. SHEAR STRESS (PSF)		e ₀
B49/2	2.1' Recovery; say 6.0' to 8.1' depth	132									
		TV	29.3								TV=1.6 tsf
		W132.1	29.3								
		TV	28.8								TV=1.4 tsf
		W132.2	28.8								
		Y132.1	28.0		95						
		TV									TV=1.85 tsf
		L132.1	26.2	50	17						
		M132.1	28.1								γ _{dry} Max=116 W _{opt} =16.5

PROJECT: BELLE RIVER PLANT UNITS I & II		FILE NO. 1255										
TABLE SUMMARY OF LABORATORY TEST RESULTS		DATE Jan. 1974										
IDENTIFICATION		SHEET OF										
BORING SAMPLE	SOIL DESCRIPTION	DEPTH (FEET)	TEST NO.	PROPERTIES			STRENGTH		CONSOLIDATION		OTHER TESTS AND REMARKS	
				NAT. WATER CONTENT (%)	ATTERBERG LIMITS w _L w _P	DRY UNIT WEIGHT (PCF)	TEST TYPE	ε %	MAX. SHEAR STRESS (PSF)	e ₀		C _c
B49/3	Silty CLAY; dark grayish brown, firm to stiff consistency, highly plastic (CL-CH)	13.0 to 15.0	133									
		13.2	IV		29.0							TV=0.73tsf
		13.2 to 13.3	MB3.1		29.0							
		13.3 to 13.7	save 133.1				92					
		13.7	IV									TV=0.53tsf
		13.7 to 14.0	CB3.1		33.3					0.823	0.26	
		13.7 to 14.0	MB3.1		31.8	47 23						
		13.7 to 14.0	save 133.1									
		14.0	IV		31.3							TV=0.42tsf
		14.0 to 14.1	MB3.2		31.3							
		14.1 to 14.4	save 133.2									
		14.4	IV		30.4							TV=0.45tsf
		14.4 to 14.5	MB3.3		30.4							
		14.5 to 14.9	save 133.3									

PROJECT: BELLE RIVER PLANT UNITS I & II		FILE NO. 1255									
TABLE SUMMARY OF LABORATORY TEST RESULTS		DATE Jan. 1974									
IDENTIFICATION		SHEET OF									
BORING SAMPLE	SOIL DESCRIPTION	DEPTH (FEET)	TEST NO.	PROPERTIES			STRENGTH		CONSOLIDATION		OTHER TESTS AND REMARKS
				NAT. WATER CONTENT (%)	ATTERBERG LIMITS w _L w _P	DRY UNIT WEIGHT (PCF)	TEST TYPE	ε %	MAX. SHEAR STRESS (PSF)	e ₀	
B49/4	1.9' Recovery; say 23.0 to 24.9' depth	23.0 to 25.0	134								
		23.1	TV	32.2							TV=0.34 tsf
		23.1 to 23.2	W134.1	32.2							
	Silty CLAY; grayish brown, firm consistency, moderately to highly plastic (CL)	23.2 to 23.5	save 134.1								
		23.5	TV								TV=0.37 tsf
		23.5 to 23.9	save 134.2								
		23.9	TV	34.0							TV=0.41 tsf
		23.9 to 24.0	W134.2	34.0							
		24.0 to 24.3	U134.1	34.0	90		U	6.0	1028		
		24.0 to 24.3	L134.1	32.8	42	22					
		24.4	TV								TV=0.42 tsf
		24.4 to 24.8	save 134.3								
		24.8	TV	34.0							TV=0.37 tsf
		24.8 to 24.9	W134.3	34.0							

PROJECT: BELLE RIVER PLANT UNITS I & II		FILE NO. 1255								
TABLE SUMMARY OF LABORATORY TEST RESULTS		DATE July 1974								
IDENTIFICATION		SHEET OF								
BORING SAMPLE	SOIL DESCRIPTION	DEPTH (FEET)	TEST NO.	PROPERTIES		STRENGTH		CONSOLIDATION		OTHER TESTS AND REMARKS
				NAT. WATER CONTENT (%)	ATTERBERG LIMITS w _L w _P	DRY UNIT WEIGHT (pcf)	TEST TYPE	ε %	MAX. SHEAR STRESS (PSF)	
49/6	1.9' Recovery; say 43.0' to 44.9' depth	43.0-45.0	136							
	Silty CLAY; dark greyish brown, firm consistency, highly plastic (CH-CL)	43.1-43.2	WI36.1	39.9						
		43.5	TV							TV=0.42tsf
		43.8-43.9	WI36.2	35.2						
	Sample includes ±5% coarse Sand grains (subrounded to subangular in shape)	43.9-44.2	TI36.12	46.3		75	CU	2.9	1356	$\bar{\sigma}_c=3744psf$
		43.9-44.2	LI36.1	45.5	53	22				
	Lower portions of sample appear to be "sensitive", i.e. became soft and sticky on remolding	44.2-44.3	TV	45.7						TV=0.37tsf
		44.2-44.3	WI36.3	45.7						
		44.3-44.7	TI36.11	43.5		78	CU	5.8	921	$\bar{\sigma}_c=1872psf$
		44.3-44.7	TI36.13	44.9		77	CU	4.7	1928	$\bar{\sigma}_c=7488psf$

PROJECT: BELLE RIVER PLANT UNITS I & II

FILE NO. 1255
DATE _____ OF _____

SUMMARY OF LABORATORY TEST RESULTS

BORING SAMPLE	IDENTIFICATION		TEST NO.	PROPERTIES		STRENGTH		CONSOLIDATION		OTHER TESTS AND REMARKS	
	SOIL DESCRIPTION	DEPTH (FEET)		NAT. WATER CONTENT (%)	ATTERBERG LIMITS w _L w _p	DRY UNIT WEIGHT (pcf)	TEST TYPE	ε %	MAX. SHEAR STRESS (psf)		e ₀ c _c
B49/7	1.9' Recovery; say 53.0' to 54.6' depth Silty CLAY, dark gray, medium to stiff consistency, moderately plastic (CL) Sample includes about 15% fine to coarse Sand particles (subrounded to subangular in shape)	53.0 to 55.0	137								
		53.2	TV		25.9						TV = 0.34 tsf
		53.2 to 53.3	W		25.7						
		53.3 to 53.7	save								
		53.7 to 54.1	137.1	97							
		54.1 to 54.4	S/H		25.0						See Plot
		54.4	137.1								TV = 0.65 tsf
		54.4	TV		25.9						
		54.4 to 54.6	W		25.9						
		54.6 to 54.9	137.2								
			save								
		137.1									

PROJECT: BELLE RIVER PLANT UNITS I & II FILE NO. 1255 DATE Jan. 1974 SHEET ___ OF ___												
TABLE SUMMARY OF LABORATORY TEST RESULTS												
BORING SAMPLE	IDENTIFICATION	DEPTH (FEET)	TEST NO.	PROPERTIES			STRENGTH		CONSOLIDATION		OTHER TESTS AND REMARKS	
				NAT. WATER CONTENT (%)	ATTERBERG LIMITS w _L w _P	DRY UNIT WEIGHT (PCF)	TEST TYPE	MAX. SHEAR STRESS (PSF)	e ₀	c _c		
B49/9	1.5' Recovery; say 73.0' to 74.5' depth Silty CLAY, sandy; dark gray, stiff consistency, moderately plastic (CL) Sample includes ±30% coarse Sand and fine Gravel size particles (subrounded to subangular in shape)	73.0 to 75.0	139									
		73.1	TV	25.7								TV=0.68 tsf
		73.1 to 73.2	W139.1	25.7								
		73.2 to save				99						
		73.5	L39.1									
		73.5	TV	24.1								TV=0.75 tsf
		73.5 to 73.6	W139.2	24.1								
		73.6 to save										
		73.9	L39.2									
		73.9	TV									TV=0.80 tsf
		73.9 to 74.3	U139.1	25.6		100		U	20.0	2513		@ 15% strain s=2254 psf
		73.9 to 74.3	L139.1	18.2	33	22						TV=0.76 tsf
		74.3	TV	22.8								
		74.3 to 74.4	W139.3	22.8								

PROJECT: BELLE RIVER PLANT UNITS I & II		FILE NO. 1255									
TABLE SUMMARY OF LABORATORY TEST RESULTS		DATE SHEET OF									
IDENTIFICATION		TEST NO.		PROPERTIES		STRENGTH		CONSOLIDATION		OTHER TESTS AND REMARKS	
BORING SAMPLE	SOIL DESCRIPTION	DEPTH (FEET)	NAT. WATER CONTENT (%)	ATTERBERG LIMITS w _L w _P	DRY UNIT WEIGHT (PCF)	TEST TYPE	ε %	MAX. SHEAR STRESS (PSF)	e ₀	c _c	
B49/111	1.5' Recovery; say 93.0' to 94.5' depth	93.0 to 95.0									TV = 0.62 tsf
		93.1	26.6								
	Silty CLAY; dark gray, stiff consistency, moderately plastic (CL)	93.1 to 93.2	26.6								
		93.2 to 93.5			98						
		93.5	26.2								TV = 0.70 tsf
	Sample includes ±20% coarse Sand and fine Gravel size particles (subangular to subrounded in shape)	93.5 to 93.6	26.2								
		93.6 to 93.8	28.6						0.701	0.20	
		94.0	24.3	37	22						Specific Gravity=2.68
		93.8 to 94.0									TV = 0.68 tsf
		94.0	27.0								
		94.0 to 94.1	27.0								
		94.1 to 94.5									

PROJECT: BELLE RIVER PLANT UNITS I & II FILE NO. 1255
 TABLE SUMMARY OF LABORATORY TEST RESULTS DATE Jan. 1974
 SHEET OF

BORING SAMPLE	IDENTIFICATION	DEPTH (FEET)	TEST NO.	PROPERTIES		STRENGTH		CONSOLIDATION		OTHER TESTS AND REMARKS	
				NAT. WATER CONTENT (%)	ATTERBERG LIMITS w_L w_P	DRY UNIT WEIGHT (PCF)	TEST TYPE	ϵ %	MAX. SHEAR STRESS (PSF)		e_0
B49/13	1.6' Recovery; say 113.0' to 114.6' depth Silty CLAY: sandy, dark gray, stiff consistency, moderately plastic (CL) Sample includes about 25% coarse Sand and fine Gravel size particles (subrounded to subangular in shape)	113.0 to 115.0	—								
		113.1 TV									
		113.1 to 113.2									
		113.2 to 113.5									
		113.5 TV			93		CU 11.1	4132			TV=0.55 tsf
		113.5 to 113.8									
		113.8 TV									TV=0.62 tsf
		113.8 to 113.9									
		113.9 to 114.2									
		113.9 to 114.2									
		114.2 TV									TV=0.64 tsf
		114.2 to 114.3									
	114.3 to 114.6										

PROJECT: BELLE RIVER PLANT UNITS I & II

FILE NO. 1255

DATE _____ SHEET _____ OF _____

TABLE SUMMARY OF LABORATORY TEST RESULTS

BORING SAMPLE	IDENTIFICATION		TEST NO.	PROPERTIES			STRENGTH		CONSOLIDATION		OTHER TESTS AND REMARKS
				NAT. WATER CONTENT (%)	ATTERBERG LIMITS w_L w_P	DRY UNIT WEIGHT (PCF)	TEST TYPE	ϵ %	MAX. SHEAR STRESS (PSF)	e_0	
50/4	SOIL DESCRIPTION	DEPTH (FEET)	—								
	1.5' Recovery; say 18.0' to 19.5' depth - disturbed	18.0 to 20.0	84								
	_____	18.7 to 19.0	saved								
	Silty CLAY, gray, moderate to high plasticity (CL)	19.0 to 19.1	W84.1	34.6		84					
	Note: Entire sample disturbed	19.1	TV								TV = 0.13tsf
		19.1 to 19.4	L84.1	34.6	45	20					

PROJECT: BELLE RIVER PLANT UNITS I & II		FILE NO. 1255									
TABLE SUMMARY OF LABORATORY TEST RESULTS		DATE July 1974									
IDENTIFICATION		SHEET OF									
BORING SAMPLE	SOIL DESCRIPTION	DEPTH (FEET)	TEST NO.	PROPERTIES			STRENGTH		CONSOLIDATION		OTHER TESTS AND REMARKS
				NAT. WATER CONTENT (%)	ATTERBERG LIMITS WL WP	DRY UNIT WEIGHT (PCF)	TEST TYPE	ε %	MAX. SHEAR STRESS (PSF)	e _o	
50/5	Jar Sample	23.5-25.0	453								
	Silty CLAY, gray, high plasticity (CH-CL)		L453.1	* 39.8	52 22						
	*Note: Water content taken from unsealed jar sample										

PROJECT: GREENWOOD ENERGY CENTER UNITS 2 & 3

TABLE _____ SUMMARY OF LABORATORY TEST RESULTS

BORING SAMPLE	IDENTIFICATION		DEPTH (FEET)	TEST NO.	PROPERTIES			STRENGTH		CONSOLIDATION		OTHER TESTS AND REMARKS
					NAT. WATER CONTENT (%)	ATTERBERG LIMITS w _L w _P	DRY UNIT WEIGHT (PCF)	TEST TYPE	ε %	MAX. SHEAR STRESS (PSF)	e ₀	
50/6	1.9' Recovery; say 28.0' to 29.9' depth		28.0 to 30.0	85								
			28.1 to 28.3	V85.1	35.2			VS	443			St = 2.1
	Silty CLAY, gray, firm consistency, moderate plasticity (CL)		28.3 to 28.5	k85.1	37.2		84			1.002		hydrometer - see plot
			28.5 to 28.6	W85.1	35.2							
			28.6 to 28.9	T85.1	33.0		88	CU	13.1	842		σ _c = 1440 psf
			28.6 to 28.9	T85.12	33.1		90	CU	14.5	1050		σ _c = 2880 psf
			29.0	W85.2	34.3							TV = 0.28 tsf
			29.1 to 29.4	L85.2	34.3	39	18					
	Note: Below 29.4' depth sample becomes softer, more sensitive on remolding		29.1 to 29.4	T85.13	34.3		86	CU	14.0	1718		σ _c = 5760 psf
			29.4 to 29.7	U85.1	45.8		75	U	2.4	197		
			29.4 to 29.7	L85.1	45.7	51	18					

PROJECT: BELLE RIVER PLANT UNITS I & II		FILE NO. 1255											
TABLE SUMMARY OF LABORATORY TEST RESULTS		DATE											
IDENTIFICATION		SHEET OF											
BDRING SAMPLE	SOIL DESCRIPTION	DEPTH (FEET)	TEST NO.	PROPERTIES			STRENGTH			CONSOLIDATION		OTHER TESTS AND REMARKS	
				NAT. WATER CONTENT (%)	ATTERBERG LIMITS w_L w_P	DRY UNIT WEIGHT (PCF)	TEST TYPE	ϵ %	MAX. SHEAR STRESS (PSF)	e_0	c_c		
50/8	2.0' Recovery	38.0 to 40.0	86										
	Silty CLAY, gray, firm consistency, highly plastic (CH)	38.1 to 38.4	T86.01	46.2		74	UU	4.0	643			$\sigma_c = 3456$ psf	
		38.4 to 38.5	W86.1	47.6		71							
		38.5	TV									TV = 0.39 tsf	
		38.5 to 38.9	C86.1	51.6						1.383	0.55		
		38.5 to 38.9	SC86.1									Specific Gravity = 2.75	
		38.9 to 39.2	U86.1	51.3			70	U	2.0	550			
		38.9 to 39.2	L86.1	51.2	55	23							
		39.2 to 39.3	W86.2	48.6			71						
		39.3 to 39.6	saved										

PROJECT: BELLE RIVER PLANT UNITS I & II

TABLE SUMMARY OF LABORATORY TEST RESULTS

FILE NO. 1255
DATE July 1974
SHEET 1 OF 1

BORING SAMPLE	IDENTIFICATION		DEPTH (FEET)	TEST NO.	PROPERTIES			STRENGTH		CONSOLIDATION		OTHER TESTS AND REMARKS
					NAT. WATER CONTENT (%)	ATTERBERG LIMITS w_L w_P	DRY UNIT WEIGHT (PCF)	TEST TYPE	ϵ %	MAX SHEAR STRESS (PSF)	e_o	
50/10	1.8' Recovery; say 48.0' to 49.8' depth		48.0 to 50.0 48.1 to 48.4	87								
	Silty CLAY, sandy, gray, firm consistency, moderately plastic (CL)		48.5 to 48.8	W87.1 k87.1	25.9		96		VS FVS	518 484		St = 1.1
	Sample includes 20 to 25% fine to coarse Sand particles and 10 to 15% subrounded to subangular Gravel size particles to 1/2 inch maximum		48.8 to 48.9	W87.2	26.9		97				.730	sieve/hydrrometer see plot
			48.9 to 48.9	TV	24.2		97					TV = 0.41 tsf
			49.0 to 49.3	U87.1	23.6		99		U	15.0	527	
			49.0 to 49.3	L87.1	23.4	36	16					
			49.3 to 49.6	T87.0.1	23.2		100		UU	15.0	721	$\sigma_c = 4320$

PROJECT: BELLE RIVER PLANT UNITS I & II		FILE NO. 1255									
TABLE SUMMARY OF LABORATORY TEST RESULTS		DATE									
IDENTIFICATION		SHEET OF									
BORING SAMPLE	SOIL DESCRIPTION	DEPTH (FEET)	TEST NO.	PROPERTIES			STRENGTH		CONSOLIDATION		OTHER TESTS AND REMARKS
				NAT. WATER CONTENT (%)	ATTERBERG LIMITS w_L w_P	DRY UNIT WEIGHT (PCF)	TEST TYPE	ϵ %	MAX. SHEAR STRESS (PSF)	e_0	
50/12	1.9' Recovery; say 58.0' to 59.9' depth	58.0 to 60.0 58.1 to 58.5	88 saved								
	Silty CLAY, sandy, gray, firm to stiff consistency, moderately plastic (CL)	58.5	W88.1	23.8		99					
		58.5	TV	23.8							TV = 0.53 tsf
		58.6 to 58.9	U88.1	25.8		99	U	9.0	1008		
	Sample includes about 20% fine to coarse Sand particles and about 10% subrounded to subangular Gravel particles to 1/2 inch maximum size	58.6 to 58.9	L88.1	24.2	39	18					
		59.0	W88.2	24.8		97					
		59.0	TV	24.8							TV = 0.54 tsf
		59.1 to 59.4	T88.0.1	24.3		101	UU	10.0	1132		$\sigma_c = 4608$ psf
		59.4 to 59.8	saved								

PROJECT: BELLE RIVER PLANT UNITS I & II

FILE NO. 1255

DATE _____ SHEET _____ OF _____

TABLE _____ SUMMARY OF LABORATORY TEST RESULTS

BORING SAMPLE	IDENTIFICATION		TEST NO.	PROPERTIES			STRENGTH		CONSOLIDATION		OTHER TESTS AND REMARKS	
	SOIL DESCRIPTION	DEPTH (FEET)		NAT. WATER CONTENT (%)	ATTERBERG LIMITS w _L w _P	DRY UNIT WEIGHT (PCF)	TEST TYPE	ε %	MAX. SHEAR STRESS (PSF)	e ₀		c _c
50/14	1. 9' Recovery; say 68.0' to 69.9' depth Silty CLAY, sandy; gray, firm to stiff consistency, moderately plastic (CL) Sample includes 20 to 25% fine to coarse Sand particles and subrounded to subangular Gravel size particles	68.0 to 70.0	89									
		68.0 to 68.4	saved									
		68.4	W89.1	27.3	93							
		68.4	TV	27.3								IV = 0.48 tsf
		68.5 to 68.9	saved									
		69.0 to 69.2	L89.1	27.9	43	18						
		69.2	W89.2	29.5	94							
		69.2	TV	29.5								IV = 0.54 tsf
		69.3 to 69.7	saved									

FILE NO. 1255

DATE _____

SHEET _____ OF _____

PROJECT: BELLE RIVER PLANT UNITS I & II

TABLE _____ SUMMARY OF LABORATORY TEST RESULTS

BORING SAMPLE	IDENTIFICATION		DEPTH (FEET)	TEST NO.	PROPERTIES			STRENGTH		CONSOLIDATION		OTHER TESTS AND REMARKS
					NAT. WATER CONTENT (%)	ATTERBERG LIMITS w_L w_p	DRY UNIT WEIGHT (PCF)	TEST TYPE	ϵ %	MAX. SHEAR STRESS (PSF)	e_0	
50/16	1.9' Recovery; say 78.0' to 79.9' depth		78.0 to 80.0	90								
			78.2 to 78.5	saved								
	Silty CLAY, gray, firm to stiff consistency, moderate plasticity (CL)		78.5	W90.1	27.7		95					
			78.5	IV	27.7							TV = 0.56 tsf
	Sample includes 10 to 15% fine to coarse Sand particles and subrounded to subangular Gravel particles to 1/2 inch maximum size		78.6 to 78.9	U90.1	27.9		95	U	10.0	1271		
			78.6 to 78.9	L90.1	27.9	39	20					
			79.0	W90.2	27.8		92					
			79.0	IV	27.8							TV = 0.63 tsf
			79.1 to 79.7	saved								

PROJECT: BELLE RIVER PLANT UNITS I & II		FILE NO. 1255									
TABLE SUMMARY OF LABORATORY TEST RESULTS		DATE _____ SHEET _____ OF _____									
BORING SAMPLE	IDENTIFICATION	DEPTH (FEET)	TEST NO.	PROPERTIES			STRENGTH		CONSOLIDATION		OTHER TESTS AND REMARKS
				NAT. WATER CONTENT (%)	ATTERBERG LIMITS w _L w _P	DRY UNIT WEIGHT (PCF)	TEST TYPE	MAX. SHEAR STRESS (PSF)	e ₀	c _c	
50/18	1.9' Recovery, say 88.0' to 89.9' depth; upper 0.3' disturbed	88.0 to 90.0	91								
		88.3 to 88.6	T9L1.1	28.0		97	CU	14.6	1923		σ _c = 3456 psf
		88.6	W9L1.1	27.6		95					
		88.6	TV	27.6							TV = 0.59 tsf
	Silty CLAY, sandy, gray, firm to stiff consistency, moderate plasticity (CL)	88.7 to 89.0	T9L1.2	27.6		97	CU	11.7	2590		σ _c = 6912 psf
		88.7 to 89.0	L9L1.1	29.5	39	23					
	Sample includes 20 to 25% fine to coarse Sand size particles and about 10% subrounded to subangular Gravel size particles	89.0	W9L1.2	27.0		95					
		89.0	TV	27.0							TV = 0.69 tsf
		89.1 to 89.4	T9L1.3	27.6		96	CU	11.8	3989		σ _c = 13,824 psf
		89.5 to 89.8	saved								

PROJECT: BELLE RIVER PLANT UNITS I & II		FILE NO. 1255									
TABLE: SUMMARY OF LABORATORY TEST RESULTS		DATE: _____									
IDENTIFICATION		SHEET _____ OF _____									
BORING SAMPLE	SOIL DESCRIPTION	DEPTH (FEET)	TEST NO.	PROPERTIES			STRENGTH		CONSOLIDATION		OTHER TESTS AND REMARKS
				NAT. WATER CONTENT (%)	ATTERBERG LIMITS w _L w _p	DRY UNIT WEIGHT (PCF)	TEST TYPE	ε %	MAX. SHEAR STRESS (PSF)	e _o	
52/3	Recovery; say 20.0' to 22.3' depth	20.0 to 22.3'	108								
		20.1 to 20.5	saved								
	Silty CLAY; gray, very stiff consistency, moderate to high plasticity (CL - CH)	20.5	W108.1	31.1		92					TV = 1.2 tsf
		20.5	TV								
		20.5 to 20.9	U108.1	30.3		92		4.0	2737		
		20.5 to 20.9	L108.1	30.9	49	20					
		20.9 to 21.0	W108.2	30.4		92					
		21.2 to 21.5	T			92					
		21.5 to 21.6	108.01	31.1		92		8.0	1591		σ _c = 2016 psf
		21.6	W108.3	31.4		91					
		21.6	TV								TV = 0.7 tsf
		21.6 to 21.9	saved								

BORING SAMPLE	IDENTIFICATION		TEST NO.	PROPERTIES			STRENGTH		CONSOLIDATION		OTHER TESTS AND REMARKS
	SOIL DESCRIPTION	DEPTH (FEET)		NAT. WATER CONTENT (%)	ATTERBERG LIMITS w_L w_P	DRY UNIT WEIGHT (pcf)	TEST TYPE	ϵ %	MAX. SHEAR STRESS (PSF)	e_o	
52/4	2.5' Recovery; say 28.0' to 30.5' depth	28.0 to 30.5	109								
		28.2 to 28.5	saved								
	Silty CLAY, gray, firm consistency, of moderate plasticity (CL)	28.5	W109.1	32.5	89						
		28.6 to 28.9	U109.1	31.8	94	U	9.0	489			
		28.6 to 28.9	L109.1	29.4	35	18					
	Sample includes lenses or layers of non-plastic sandy Silt (about 15% of total sample)	28.9 to 29.2	V109.1	30.5				568			St = 2.1
		29.2	W109.2	30.5	89			277			
	Note change in physical properties of soil below 29.5' depth - is Silty CLAY (CL-CH)	29.3	W109.2	30.5	89						
		29.4 to 29.7	saved								
		29.8	W109.3	41.3	79						
		29.9 to 30.2	C109.1	40.5					1.013	0.45	
		29.9 to 30.2	SG109.1								Specific Gravity = 2.70
		29.9 to 30.2	L109.2	40.5	49	20					

PROJECT: BELLE RIVER PLANT UNITS I & II
 TABLE SUMMARY OF LABORATORY TEST RESULTS

BORING SAMPLE	IDENTIFICATION		DEPTH (FEET)	TEST NO.	PROPERTIES			STRENGTH		CONSOLIDATION		OTHER TESTS AND REMARKS
					NAT. WATER CONTENT (%)	ATTERBERG LIMITS WL WP	DRY UNIT WEIGHT (PCF)	TEST TYPE	MAX. SHEAR STRESS (PSF)	e_0	C_c	
52/6	2.4' Recovery; say 48.0' to 50.4' depth		48.0 to 50.5	III								
			48.1 to 48.4	THI.11	22.1		101	CU	10.2	15159		$\bar{\sigma}_c = 2160$ psf
	SILT, dark gray, firm consistency, non-plastic to slightly plastic (ML)		48.4	WIII.1	22.9		99					
			48.4	TV	22.9							TV = 0.27 tsf
			48.5 to 48.8	THI.12	22.7		99	CU	15.0	17508		$\bar{\sigma}_c = 4320$ psf
			48.8 to 49.1	THI.13	22.1		104	CU	13.3	27777		$\bar{\sigma}_c = 8640$ psf
	Becomes more plastic with depth,		49.1	WIII.2	21.5		103					
	At $\pm 49.5'$ depth-change to Silty CLAY, sandy; dark gray, stiff consistency; moderately plastic (CL)		49.1	TV	21.5							TV = 0.35 tsf
			49.2 to 49.5	UIII.1	25.2		100	U	2.5	317		
			49.2 to 49.5	LIII.1	25.2	22	18					
	Includes 15 to 20% fine to coarse Sand size particles with less than 5% fine Gravel size pieces to 1/4 inch maximum size		49.5	WIII.3	23.6		101					
			49.5	TV	23.6							TV = 0.73 tsf
			49.6 to 49.8	VIII.1	23.6			VS		2160		
								FVS		1950		St = 1.1

SUMMARY OF LABORATORY TEST RESULTS

BORING SAMPLE	IDENTIFICATION	TEST NO.	PROPERTIES			STRENGTH		CONSOLIDATION		OTHER TESTS AND REMARKS
			NAT. WATER CONTENT (%)	ATTERBERG LIMITS w _L / w _P	DRY UNIT WEIGHT (PCF)	TEST TYPE	ε %	MAX. SHEAR STRESS (PSF)	e ₀	
52/7	2.4' Recovery; say 58.0' to 60.4' depth	112								
		saved								
	Silty CLAY; sandy, very dark gray, very stiff consistency, moderate plasticity (CL)	W1121	16.0		112					
		TV								TV = 1.10 tsf
		U12.1	15.1					0.411		sieve/hydro-meter see plot
		U1121	13.0		116	U	6.0	1799		
		L1121	12.9	23	14					
		saved								
		W1122	14.6		115					
		TV								TV = 1.20 tsf

BDRG SAMPLE	IDENTIFICATION		TEST NO.	PROPERTIES			STRENGTH		CONSOLIDATION		OTHER TESTS AND REMARKS	
	SOIL DESCRIPTION	DEPTH (FEET)		NAT WATER CONTENT (%)	ATTERBERG LIMITS w_L w_P	DRY UNIT WEIGHT (PCF)	TEST TYPE	ϵ %	MAX SHEAR STRESS (PSF)	e_o		c_c
52/8	1.5' Recovery; say 68.0' to 69.5' depth Silty CLAY, sandy, very dark gray, stiff to very stiff consistency, moderate plasticity (CL) Includes about 30% fine to coarse rounded to subrounded Sand grains, and about $\pm 10\%$ subrounded to subangular Gravel pieces (3/4" max. size)	68.0 to 69.5'										
		68.2	W113.1	14.5		111						
		68.2	TV									TV = 1.0 tsf
		68.2 to 68.5	U113.1	14.2		115	U	13.0	1677			
		68.2 to 68.5	L113.1	13.8	24	14						
		68.6	W113.2	14.3								
		68.6	TV									TV = 1.2 tsf
		69.0 to 69.4	T									
		69.4	U13.0.1	16.2		111	UU	15.0	1891			$\sigma_c = 5184$ psf
		69.4	W113.3	19.4								
		69.4	TV									TV = 0.8 tsf

PROJECT: BELLE RIVER PLANT UNITS I & II

FILE NO. 1255

TABLE SUMMARY OF LABORATORY TEST RESULTS

DATE _____ SHEET _____ OF _____

BORING SAMPLE	IDENTIFICATION		DEPTH (FEET)	TEST NO.	PROPERTIES			STRENGTH		CONSOLIDATION		OTHER TESTS AND REMARKS
					NAT. WATER CONTENT (%)	ATTERBERG LIMITS w _L w _P	DRY UNIT WEIGHT (PCF)	TEST TYPE	ε %	MAX. SHEAR STRESS (PSF)	e ₀	
52/9	2.5' Recovery; say 78.0' to 80.5' depth		78.0 to 80.5'	114								
	Silty CLAY; gray, stiff consistency, moderately plastic (CL)		78.2 to 78.5'	saved								
			78.5 to 78.6'	W114.1	23.3		105					
			78.6 to 78.6'	TV								TV = 0.5 tsf
			78.6 to 78.9'	T								
	Sample includes about 20% fine to coarse Sand and fine Gravel particles (subangular to subrounded)		78.9 to 79.0'	W14.0.1	21.8		105	UU	14.0	1157		σ _c = 5760 psf
			78.9 to 79.0'	L114.1	23.5	35	18					
			79.0 to 79.0'	W114.2	22.1		106					
			79.0 to 79.0'	TV								TV = 0.8 tsf
			79.0 to 79.3'	saved								
			79.3 to 79.7'	saved								
			79.7 to 79.8'	W114.3	21.9		103					
			79.8 to 79.8'	TV								TV = 0.95 tsf

FILE NO. 1255

DATE _____
SHEET _____ OF _____

PROJECT: BELLE RIVER PLANT UNITS I & II

TABLE: SUMMARY OF LABORATORY TEST RESULTS

BORING SAMPLE	IDENTIFICATION		DEPTH (FEET)	TEST NO.	PROPERTIES			STRENGTH		CONSOLIDATION		OTHER TESTS AND REMARKS
					NAT. WATER CONTENT (%)	ATTERBERG LIMITS w _L w _p	DRY UNIT WEIGHT (PCF)	TEST TYPE	ε %	MAX. SHEAR STRESS (PSF)	e ₀	
52/10	2.5' Recovery; say 88.0' to 90.5' depth		88.0 to 90.5	115								
			88.2 to 88.5	saved								
	Silty CLAY; sandy, gray, stiff consistency, moderate plasticity (CL)		88.5	W115.1	26.7		97					
			88.6 to 88.9	U115.1	27.2		97	U	8.0	2435		
			88.6 to 88.9	L115.1	26.4	39	18					
	Sample includes 25 to 30% fine to coarse Sand size particles and subrounded to subangular Gravel particles		89.0	W115.2	26.4		96					
			89.1 to 89.4	V115.1	26.4			VS		1662		
			89.5 to 89.8	saved				rVS		1529		St = 1.1
			89.8	W115.3	27.0		95					
			89.9 to 90.3	saved								

PROJECT: BELLE RIVER PLANT UNITS I & II		FILE NO. 1255									
TABLE: SUMMARY OF LABORATORY TEST RESULTS		DATE: _____									
IDENTIFICATION		SHEET _____ OF _____									
BORING SAMPLE	SOIL DESCRIPTION	DEPTH (FEET)	TEST NO.	PROPERTIES			STRENGTH		CONSOLIDATION		OTHER TESTS AND REMARKS
				NAT. WATER CONTENT (%)	ATTERBERG LIMITS w_L w_p	DRY UNIT WEIGHT (PCF)	TEST TYPE	ϵ %	MAX. SHEAR STRESS (PSF)	e_0	
52/12	2.5' Recovery; say 108.0' to 110.5' depth	108.0 - 110.5	117								
		108.1 - 108.5	saved								
	Silty CLAY; gray, medium to stiff consistency, moderate to high plasticity (CL)	108.5	W117.1	29.7		83					TV = 0.55 tsf
		108.5	TV								
		108.5 - 108.8	saved								
	Sample includes about 10% fine to coarse subrounded to rounded Sand grains	108.8 - 109.1	saved								
		109.1	W117.2	35.1							
		109.1	TV								TV = 0.35 tsf
		109.3 - 109.6'	T 117.0.1	35.8		87		UU	3.0	1596	$\sigma_c = 7632$ psf
		109.3 - 109.6	L117.1	36.2	46	22					
		109.6 - 109.9	saved								
		110.0	W117.3	35.5		87					
		110.0	TV								TV = 0.51 tsf

FILE NO. 1255
DATE July 1974
SHEET ___ OF ___

PROJECT: BELLE RIVER PLANT UNITS I & II
TABLE SUMMARY OF LABORATORY TEST RESULTS

IDENTIFICATION		TEST NO.	PROPERTIES			STRENGTH		CONSOLIDATION		OTHER TESTS AND REMARKS
			NAT. WATER CONTENT (%)	ATTERBERG LIMITS w _L w _p	DRY UNIT WEIGHT (PCF)	TEST TYPE	ε %	MAX. SHEAR STRESS (PSF)	e ₀	
BORING SAMPLE	SOIL DESCRIPTION	DEPTH (FEET)								
52/12	Jar Sample	115.5								
	Silty CLAY, grey, moderate plasticity (CL)		34	18						
	Sample includes about 20% fine to coarse Sand grains (subrounded to subangular in shape)									

PROJECT: BELLE RIVER PLANT UNITS I & II

FILE NO. 1255

TABLE SUMMARY OF LABORATORY TEST RESULTS

DATE SHEET OF

IDENTIFICATION		TEST NO.	PROPERTIES			STRENGTH		CONSOLIDATION		OTHER TESTS AND REMARKS		
BORING SAMPLE	SOIL DESCRIPTION		DEPTH (FEET)	NAT. WATER CONTENT (%)	ATTERBERG LIMITS w _L w _P	DRY UNIT WEIGHT (PCF)	TEST TYPE	ε %	MAX. SHEAR STRESS (PSF)		e _o	c _c
53/3	1.7' Recovery; say 19.0' to 20.7' depth Silty CLAY, gray, stiff consistency, moderate to high plasticity (CL-CH)	—										
		19.0 to 21.0	96									
		19.2 to 19.5	saved									
		19.5	W96.1	32.0		87						
		19.5	TV									
		19.6 to 19.9	U96.1	31.8		88	U	5.0	1156			
		19.6 to 19.9	L96.1	31.7	49	20						
		20.0	W96.2	32.1		87						
		20.0	TV									
		20.1 to 20.4	T96.0.1	32.2		91	UU	8.9	1425			

PROJECT: BELLE RIVER PLANT UNITS I & II

TABLE SUMMARY OF LABORATORY TEST RESULTS

FILE NO. 1255

DATE _____ OF _____

SHEET _____ OF _____

IDENTIFICATION		TEST NO.	PROPERTIES			STRENGTH		CONSOLIDATION		OTHER TESTS AND REMARKS
BORING SAMPLE	SOIL DESCRIPTION		NAT. WATER CONTENT (%)	ATTERBERG LIMITS wL wP	DRY UNIT WEIGHT (PCF)	TEST TYPE	MAX. SHEAR STRESS (PSF)	e _o	c _c	
53/4	1.8' Recovery; say 29.0' to 30.8' depth	—								
		97								
		saved								
		W97.1	42.5		77					
		TV	42.5							
		U97.1	40.7		80	U	5.0	1006		TV = 0.53 tsf
		L97.1	41.1	49	22					
		W97.2	38.8		91					
		TV	38.8							TV = 0.47 tsf
		I97.0.1	34.2		88	UU	2.4	973		σ _c = 3024 psf
		saved								

PROJECT: BELLE RIVER PLANT UNITS I & II		FILE NO. 1255										
TABLE SUMMARY OF LABORATORY TEST RESULTS		DATE _____										
IDENTIFICATION		SHEET _____ OF _____										
BORING SAMPLE	SOIL DESCRIPTION	DEPTH (FEET)	TEST NO.	PROPERTIES			STRENGTH		CONSOLIDATION		OTHER TESTS AND REMARKS	
				NAT. WATER CONTENT (%)	ATTERBERG LIMITS w _L w _P	DRY UNIT WEIGHT (PCF)	TEST TYPE	ε %	MAX. SHEAR STRESS (PSF)	e ₀		c _c
53/5	1.7' Recovery; say 39.0' to 40.7' depth Silty CLAY, sandy, gray, firm to stiff consistency, moderately plastic (CL) Sample includes 20 to 30% coarse to fine Sand and fine Gravel size particles (subrounded to subangular in shape)	39.0 to 41.0	98									
		39.1 to 39.4	saved									
		39.4 to 39.5	W98.1	97	26.3							
		39.5	TV		26.3							TV = 0.49 tsf
		39.5 to 39.8	C98.1		30.9							
		39.5 to 39.8	CG98.1							0.872	0.35	Specific Gravity = 2.72
		39.5 to 39.8	L98.1		30.5	39	20					
		39.5 to 39.8	k98.1		30.2						0.732	Sieve Hydro-meter seepbt
		39.8 to 40.1	saved									
		40.1 to 40.2	W98.2		29.6		92					
		40.2	TV		29.6							TV = 0.34 tsf
		40.2 to 40.6	saved									

PROJECT: BELLE RIVER PLANT UNITS I & II

FILE NO. 1255

DATE July 1974

TABLE SUMMARY OF LABORATORY TEST RESULTS

SHEET OF

BORING SAMPLE	IDENTIFICATION	DEPTH (FEET)	TEST NO.	PROPERTIES			STRENGTH			CONSOLIDATION		OTHER TESTS AND REMARKS	
				NAT. WATER CONTENT (%)	ATTERBERG LIMITS w _L w _P	DRY UNIT WEIGHT (PCF)	TEST TYPE	ε %	MAX. SHEAR STRESS (PSF)	e ₀	C _c		
53/6	1.5' Recovery; say 49.0' to 50.5' depth	49.0-51.0	99										
	Silty CLAY, grey, soft to firm consistency, moderately plastic (CL) Sample includes 15 to 20% fine to coarse Sand size particles and subrounded to subangular gravel size pieces Sample slightly disturbed throughout	49.1	W99.1	36.2		89							
		49.2-49.5	U99.1	27.9		94	14.9	561					
		49.2-49.5	L99.1	27.8	43	18							
		49.6	W99.2	27.3		94							
		49.7-50.0	V99.1	27.3					VS	540			
		50.0-50.3	Saved						FVS	340			

PROJECT: BELLE RIVER PLANT UNITS I & II
 TABLE: SUMMARY OF LABORATORY TEST RESULTS

FILE NO. 1255
 DATE _____
 SHEET _____ OF _____

IDENTIFICATION

BORING SAMPLE	SOIL DESCRIPTION	DEPTH (FEET)	TEST NO.	PROPERTIES		STRENGTH		CONSOLIDATION		OTHER TESTS AND REMARKS	
				NAT. WATER CONTENT (%)	ATTERBERG LIMITS w_L w_p	DRY UNIT WEIGHT (PCF)	TEST TYPE	ϵ %	MAX. SHEAR STRESS (PSF)		e_0
53/9	2.5' Recovery; say 79.0' to 81.5' depth	79.0 to 81.5	101								
	Silty CLAY; mottled gray, firm to stiff consistency, moderately plastic (CL) Sample includes about 15% fine to coarse Sand and fine Gravel size particles	79.4	W10L1	27.6							
		79.5 to 79.8	V10L1	27.9		VS	1371				
		80.1 to 80.4	U01.1	27.9		rVS	1025			St = 1.3	
		80.1 to 80.4	L10L1	28.0	39	21	U	6.0	1275		
		80.5 to 80.8	saved								
		80.9 to 81.2	saved								

PROJECT		BELLE RIVER PLANT UNITS I & II		FILE NO. 1255				
TABLE		SUMMARY OF LABORATORY TEST RESULTS		DATE				
IDENTIFICATION		TEST NO.		SHEET				
SOIL DESCRIPTION		PROPERTIES		STRENGTH				
BORING SAMPLE	DEPTH (FEET)	NAT. WATER CONTENT (%)	ATTERBERG LIMITS		TEST TYPE	MAX. SHEAR STRESS (PSF)	CONSOLIDATION	OTHER TESTS AND REMARKS
			w _L	w _p				
53/12	2.5' Recovery; say 109.0' to 111.5' depth							
		109.0 -						
		111.5'	104					
		109.2 -						
		109.5	saved					
		109.5 -						
		109.7	W1041	20.0	108			
		109.7	TV					TV = 0.68 tsf
		109.7 -						
		110.0	11041	20.5	29	15		
		110.0 -						
		110.4	saved					
	110.4 -							
	110.5	W1042	20.1		107			
	110.5	TV					TV = 0.85 tsf	
	110.5'							
	110.8	saved						

PROJECT: BELLE RIVER PLANT UNITS I & II

FILE NO. 1255

TABLE SUMMARY OF LABORATORY TEST RESULTS

DATE July 1974

SHEET OF

IDENTIFICATION		TEST NO.	PROPERTIES			STRENGTH		CONSOLIDATION		OTHER TESTS AND REMARKS
			NAT. WATER CONTENT (%)	ATTERBERG LIMITS ω_L ω_P	DRY UNIT WEIGHT (PCF)	TEST TYPE	ϵ %	MAX. SHEAR STRESS (PSF)	e_o	
BORING SAMPLE	SOIL DESCRIPTION	DEPTH (FEET)								
53/12	Jar Sample	116.0								
	Silty CLAY, grey, moderate plasticity (CL)			36 19						
	Sample includes about 15% fine to coarse SAND and fine Gravel size particles (subrounded to subangular in shape)									

PROJECT: BELLE RIVER PLANT UNITS I & II

FILE NO. 1255

DATE _____

SHEET _____

OF _____

SUMMARY OF LABORATORY TEST RESULTS

IDENTIFICATION		TEST NO.	PROPERTIES			STRENGTH		CONSOLIDATION		OTHER TESTS AND REMARKS
BORING SAMPLE	SOIL DESCRIPTION		NAT. WATER CONTENT (%)	ATTERBERG LIMITS w_L w_p	DRY UNIT WEIGHT (PCF)	TEST TYPE	ϵ %	MAX. SHEAR STRESS (PSF)	e_0	
54/4	1.8' Recovery, say 53.0' to 54.8' depth	397								
		T397.1.1	23.6		102	CU	10.7	488		$\bar{\sigma}_c = 2160$ psf
	Clayey SILT, dark gray, firm consistency, slightly plastic to non-plastic (CL - ML)	T397.0.1	24.4		99	UU	15.0	533		$\bar{\sigma}_c = 4320$ psf
		L397.1	22.8	21	17					
		W397.1	25.7							
	@± 53.5' depth, change to Silty CLAY sandy very dark gray, firm to stiff consistency, moderately plastic (CL)	TV								TV=0.36 tsf
		T397.1.4	22.6		101	CU	14.9	1430		$\bar{\sigma}_e = 2160$ psf
	Sample includes few lenses/ layers of clayey SILT; also about 15% fine to coarse sand size particles and subrounded to subangular gravel size pieces	T397.1.2	23.2		102	CU	14.8	2022		$\bar{\sigma}_c = 4320$ psf
		T397.1.3	23.2		102	CU	13.8	3867		$\bar{\sigma}_c = 8640$ psf
		W397.2	23.3							
		T397.1.5	24.0		100	CU	10.6	2805		$\bar{\sigma}_c = 6480$ psf
		L397.2	24.0	31	18					
		TV								TV = 0.47 tsf

IDENTIFICATION		TEST NO.	PROPERTIES			STRENGTH			CONSOLIDATION		OTHER TESTS AND REMARKS
BORING SAMPLE	SOIL DESCRIPTION		DEPTH (FEET)	NAT. WATER CONTENT (%)	ATTERBERG LIMITS w _L w _P	DRY UNIT WEIGHT (PCF)	TEST TYPE	ε %	MAX. SHEAR STRESS (PSF)	e ₀	
54/5	2.0' Recovery	—									
		398	58.5 to 60.5								
		saved	58.6 to 58.9								
	Silty CLAY, sandy, gray, firm to stiff consistency, moderately plastic (CL)	W398.1	58.9	25.2		93					
		TV	58.9	25.2							TV = 0.44 tsf
		T398.0.I	59.0 to 59.3	25.4		99	UU	15.0	768		σ _c = 4464 psf
		U398.1	59.3 to 59.6	25.8		99	U	11.0	557		
		L398.1	59.3 to 59.6	26.2	38	17					
		W398.2	59.6	27.5		92					
		TV	59.6	27.5							
		V398.I	59.7 to 60.0	27.5		92	VS		1100		TV = 0.55 tsf
		saved	60.0 to 60.3								

PROJECT: BELLE RIVER PLANT UNITS I & II		FILE NO. 1255										
TABLE SUMMARY OF LABORATORY TEST RESULTS		DATE July 1974										
IDENTIFICATION		SHEET OF										
BORING SAMPLE	SOIL DESCRIPTION	DEPTH (FEET)	TEST NO.	PROPERTIES			STRENGTH		CONSOLIDATION		OTHER TESTS AND REMARKS	
				NAT. WATER CONTENT (%)	ATTERBERG LIMITS WL WP	DRY UNIT WEIGHT (PCF)	TEST TYPE	ε %	MAX. SHEAR STRESS (PSF)	e ₀		c _c
54/6	2.0' Recovery	63.0 to 65.0	399									
	Silty CLAY, sandy, gray, firm to stiff consistency, moderately plastic (CL) Sample includes about 25% fine to coarse Sand and fine Gravel size particles (subrounded to subangular in shape)	63.1 to 63.4	I399.0.1	26.1		98	UU	13.0	796		$\bar{\sigma}_c = 5040$ psf	
		63.4 to 63.5	W399.1	24.3		92						
		63.5	TV	24.3							TV = 0.46 tsf	
		63.5 to 63.8	C399.1	26.0						0.696	0.24	
		63.5 to 63.8	SG399.1									Specific Gravity = 2.71 Sieve/hydrometer See plot
		63.5 to 63.8	k399.1	27.2		98				.724		
		63.5 to 63.8	L399.1	26.0	36	18						
		63.8 to 64.1	T399.1.1	26.4		98	CU	12.0	1362			$\bar{\sigma}_c = 2448$ psf
		64.1 to 64.2	W399.2	25.0		98						TV = 0.52 tsf
		64.2	TV	25.0								$\bar{\sigma}_c = 4896$ psf
		64.2 to 64.5	T399.1.2	25.2		98	CU	12.1	2008			$\bar{\sigma}_c = 2792$ psf
		64.5 to 64.8	T399.1.3	25.8		98	CU	11.6	2929			TV = 0.48 tsf
	64.8	TV										

PROJECT: BELLE RIVER PLANT UNITS I & II

FILE NO. 1255

TABLE SUMMARY OF LABORATORY TEST RESULTS

DATE _____ SHEET _____ OF _____

IDENTIFICATION		TEST NO.	PROPERTIES			STRENGTH		CONSOLIDATION		OTHER TESTS AND REMARKS		
BORING SAMPLE	SOIL DESCRIPTION		DEPTH (FEET)	NAT. WATER CONTENT (%)	ATTERBERG LIMITS w_L w_p	DRY UNIT WEIGHT (PCF)	TEST TYPE	ϵ %	MAX SHEAR STRESS (PSF)		e_0	c_c
54/7	2.0' Recovery	400	68.0 to 70.0									
	Silty CLAY, sandy, gray, stiff consistency, moderately plastic (CL) Sample includes 30 to 40% fine to coarse Sand and fine Gravel size particles (sub-rounded to subangular in shape)	V400.1	68.1 to 68.4	26.3		VS		1300			St = 1.5	
		W400.1	68.4 to 68.5	26.3		96						
		TV	68.5	26.3							TV = 0.58 tsf	
		U400.1	68.5 to 68.8	25.9		98	U	8.9	788			
		L400.1	68.5 to 68.8	26.2	37							
		P400.0.1	68.8 to 69.1	25.9		98	UU	12.0	1148		$\sigma_c = 5112$ psf	
		W400.2	69.1 to 69.2	22.5		102						
		TV	69.2	22.5							TV = 0.54 tsf	
			saved	69.2 to 69.8								
			TV	69.8							TV = 0.56 tsf	

FILE NO. 1255
 DATE July 1974
 SHEET OF

PROJECT: BELLE RIVER PLANT UNITS I & II
 TABLE SUMMARY OF LABORATORY TEST RESULTS

BORING SAMPLE	IDENTIFICATION		DEPTH (FEET)	TEST NO.	PROPERTIES			STRENGTH		CONSOLIDATION		OTHER TESTS AND REMARKS
					NAT. WATER CONTENT (%)	ATTERBERG LIMITS WL WP	DRY UNIT WEIGHT (PCF)	TEST TYPE	MAX. SHEAR STRESS (PSF)	e ₀	c _c	
54/8	2.0' Recovery		73.0 to 75.0	401								
	Silty CLAY, gray, stiff consistency, moderately plastic (CL)		73.0 to 73.3	saved								
			73.3 to 73.4	W40L1	38.9	81						
			73.4	TV	38.9							TV = 0.54 tsf
			73.4 to 73.7	saved								
			73.7 to 74.0	C40L1	38.3				0.982	0.41		
			73.7 to 74.0	SC40L1								Specific Gravity=2.73
			73.7 to 74.0	L40L1	31.6	45	21					
			73.7 to 74.0	K40L1	31.6					0.851		see plot
			74.0 to 74.1	W40L2	30.0							
			74.1	TV	30.0							TV = 0.50 tsf
			74.1 to 74.7	saved								

PROJECT: BELLE RIVER PLANT UNITS I & II		FILE NO. 1255									
TABLE SUMMARY OF LABORATORY TEST RESULTS		DATE July 1974									
IDENTIFICATION		SHEET 0F									
BORING SAMPLE	SOIL DESCRIPTION	DEPTH (FEET)	TEST NO.	PROPERTIES			STRENGTH		CONSOLIDATION		OTHER TESTS AND REMARKS
				NAT. WATER CONTENT (%)	ATTERBERG LIMITS w _L w _P	DRY UNIT WEIGHT (PCF)	TEST TYPE	ε %	MAX. SHEAR STRESS (PSF)	e _o	
58/2	Jar Sample Silty CLAY, dark greyish brown, moderate to high plasticity (CL)	6.0'	562								
			L562.1	42	19						

PROJECT: BELLE RIVER PLANT UNITS I & II												FILE NO. 1255	
TABLE SUMMARY OF LABORATORY TEST RESULTS												DATE July 1974	
IDENTIFICATION												SHEET OF	
BORING SAMPLE	SOIL DESCRIPTION	DEPTH (FEET)	TEST NO.	PROPERTIES			STRENGTH		CONSOLIDATION		OTHER TESTS AND REMARKS		
				NAT. WATER CONTENT (%)	ATTERBERG LIMITS wL wP	DRY UNIT WEIGHT (PCF)	TEST TYPE	ε %	MAX SHEAR STRESS (PSF)	e ₀		c _c	
58/6	Jar Sample	25.0'	563										
	Silty CLAY, grey, moderate to high plasticity (CL-CH)		L563.1	48	20								

PROJECT: BELLE RIVER PLANT UNITS I & II		FILE NO. 1255		DATE July 1974		SHEET OF		
TABLE SUMMARY OF LABORATORY TEST RESULTS		STRENGTH		CONSOLIDATION		OTHER TESTS AND REMARKS		
BORING SAMPLE	IDENTIFICATION	TEST NO.	PROPERTIES		TEST TYPE	MAX SHEAR STRESS (PSF)	CONSOLIDATION	
			NAT. WATER CONTENT (%)	ATTERBERG LIMITS w _L w _P			DRY UNIT WEIGHT (PCF)	e _o
	SOIL DESCRIPTION	DEPTH (FEET)						
58/10	Jar Sample	45.0'						
	Silty CLAY, Sandy, low to moderate plasticity (CL) Sample includes about 35% fine Sand grains		27	19				

PROJECT: BELLE RIVER PLANT UNITS I & II FILE NO. 1255
 TABLE: _____ DATE July 1974 SHEET _____ OF _____
SUMMARY OF LABORATORY TEST RESULTS

BORING SAMPLE	IDENTIFICATION	TEST NO.	PROPERTIES		STRENGTH		CONSOLIDATION		OTHER TESTS AND REMARKS
			NAT. WATER CONTENT (%)	ATTERBERG LIMITS w_L w_P	DRY UNIT WEIGHT (PCF)	TEST TYPE	ϵ %	MAX. SHEAR STRESS (PSF)	
58/13	Jar Sample	565							
	Silty CLAY, Sandy, gray, moderately plastic (CL) Sample includes about 45% fine to coarse Sand grains (Subrounded to subangular in shape)	L565.1		34 17					

PROJECT: BELLE RIVER PLANT UNITS I & II		FILE NO. 1255									
TABLE SUMMARY OF LABORATORY TEST RESULTS		DATE July 1974									
IDENTIFICATION		SHEET OF									
BORING SAMPLE	SOIL DESCRIPTION	DEPTH (FEET)	TEST NO.	PROPERTIES			STRENGTH		CONSOLIDATION		OTHER TESTS AND REMARKS
				NAT. WATER CONTENT (%)	ATTERBERG LIMITS w _L w _P	DRY UNIT WEIGHT (PCF)	TEST TYPE	ε %	MAX. SHEAR STRESS (PSF)	e _o	
58/17	Jar Sample Silty CLAY, dark gray, moderate to high plasticity (CL)	80.0'	566		43 20						

IDENTIFICATION		TEST NO.	PROPERTIES			STRENGTH		CONSOLIDATION		OTHER TESTS AND REMARKS	
BORING SAMPLE	SOIL DESCRIPTION		DEPTH (FEET)	NAT. WATER CONTENT (%)	ATTERBERG LIMITS w _L w _P	DRY UNIT WEIGHT (PCF)	TEST TYPE	ε %	MAX. SHEAR STRESS (PSF)		e ₀
B59/3	1.8' Recovery; say 18.0' to 19.8' depth	76									
		saved									
		W76.1	32.1		83						
		TV	32.1								TV = 0.58 tsf
		V76.1	32.8			VS		1260			
		U76.1	32.8		90	U	6.9	1056			
		L76.1	32.7	48	20						
		W76.1	31.6		90						
		TV	31.6								TV = 0.56 tsf
		saved									

PROJECT: BELLE RIVER PLANT UNITS I & II		FILE NO. 1255									
TABLE _____		DATE _____									
SUMMARY OF LABORATORY TEST RESULTS		SHEET _____ OF _____									
BORING SAMPLE	IDENTIFICATION	DEPTH (FEET)	TEST NO.	PROPERTIES			STRENGTH		CONSOLIDATION		OTHER TESTS AND REMARKS
				NAT. WATER CONTENT (%)	ATTERBERG LIMITS w _L w _P	DRY UNIT WEIGHT (PCF)	TEST TYPE	ε %	MAX. SHEAR STRESS (PSF)	e ₀	
59/5	1.9' Recovery; say 38.0' to 39.9' depth; upper 0.5' disturbed	38.0 to 40.0	78								
		38.6 to 38.7	W78.1	26.7		94					
		38.7	TV	26.7							TV = 0.46 tsf
		38.7 to 39.0	U78.1	26.2		99		U 14.9	626		
		38.7 to 39.0	L78.1	26.2	38	18					
		39.0 to 39.3	saved								
		39.3 to 39.4	W78.2	25.6		96					
		39.4	TV	25.6							TV = 0.47 tsf
		39.4 to 39.7	V78.1	25.6				VS	637		

PROJECT: BELLE RIVER PLANT UNITS I & II		FILE NO. 1255									
TABLE SUMMARY OF LABORATORY TEST RESULTS		DATE									
IDENTIFICATION		SHEET OF									
BORING SAMPLE	SOIL DESCRIPTION	DEPTH (FEET)	TEST NO.	PROPERTIES			STRENGTH		CONSOLIDATION		OTHER TESTS AND REMARKS
				NAT. WATER CONTENT (%)	ATTERBERG LIMITS wL wP	DRY UNIT WEIGHT (PCF)	TEST TYPE	MAX. SHEAR STRESS (PSF)	e ₀	c _c	
59/7	1.5' Recovery; say 58.0' to 59.5' depth	58.0 to 60.0	80								
		58.1 to 58.4	saved								
		58.4 to 58.6	W80.1	25.0		100					
	Silty CLAY, sandy, dark gray, firm to stiff consistency, moderately plastic (CL)	58.6	TV	25.0							TV = 0.49 tsf
		58.6 to 58.9	U80.1	26.3		98		U 8.0	835		
	Sample includes 20 to 25% coarse to fine Sand and fine Gravel size particles	58.6 to 58.9	L80.1	24.5	36	18					
	(subrounded to subangular in shape)	58.9 to 59.0	W80.2	24.1		102					
		59.0	TV	24.1							TV = 0.51 tsf
		59.0 to 59.3	V80.1	24.1				VS	734		
								rVS	(969)		

PROJECT: BELLE RIVER PLANT UNITS I & II		FILE NO. 1255									
TABLE SUMMARY OF LABORATORY TEST RESULTS		DATE July 1974									
IDENTIFICATION		SHEET _____ OF _____									
BORING SAMPLE	SOIL DESCRIPTION	DEPTH (FEET)	TEST NO.	PROPERTIES		STRENGTH		CONSOLIDATION		OTHER TESTS AND REMARKS	
				NAT. WATER CONTENT (%)	ATTERBERG LIMITS w _L w _P	DRY UNIT WEIGHT (PCF)	TEST TYPE	€ %	MAX. SHEAR STRESS (PSF)		e ₀
59/9	Jar Sample	75.0	569								
	Clayey SAND, subrounded to subangular fine to coarse Sand and fine Gravel size particles with 35 to 40% low to moderately plastic fines (SC)		L569.1	22	14						

PROJECT: BELLE RIVER PLANT UNITS I & II

FILE NO. 1255

DATE July 1974

SUMMARY OF LABORATORY TEST RESULTS

SHEET OF

BORING SAMPLE	IDENTIFICATION		DEPTH (FEET)	TEST NO.	PROPERTIES			STRENGTH		CONSOLIDATION		OTHER TESTS AND REMARKS
	SOIL DESCRIPTION				NAT. WATER CONTENT (%)	ATTERBERG LIMITS w _L w _P	DRY UNIT WEIGHT (PCF)	TEST TYPE	ε %	MAX. SHEAR STRESS (PSF)	e ₀	
59/11	Jar Sample		95.0	570								
	Silly CLAY, grey, moderate plasticity (CL)			L570.1	37	19						
	Sample includes about 10% fine to coarse Sand size particles (subrounded to sub-angular in shape)											

PROJECT: BELLE RIVER PLANT UNITS I & II		FILE NO. 1255								
TABLE SUMMARY OF LABORATORY TEST RESULTS		DATE Jan. 1974								
IDENTIFICATION		SHEET ___ OF ___								
BORING SAMPLE	SOIL DESCRIPTION	DEPTH (FEET)	TEST NO.	PROPERTIES		STRENGTH		CONSOLIDATION		OTHER TESTS AND REMARKS
				NAT. WATER CONTENT (%)	ATTERBERG LIMITS w _L w _P	DRY UNIT WEIGHT (PCF)	TEST TYPE	ε %	MAX. SHEAR STRESS (PSF)	
B60/1	Jar Sample Silty CLAY; dark gray, highly plastic (CL-CH)	5.0 to 6.5	70							
			L70.1	27.3	50 20					
			H70.1							See plot
B60/2	Jar Sample Silty CLAY; dark gray, moderately to highly plastic (CL)	10.0 to 12.5	71							
			L71.1	28.0	44 19					
			H71.1							See plot
B60/3	Jar Sample Silty CLAY; dark gray, moderately to highly plastic (CL)	19.0 to 20.5	72							
			L72.1	30.3	43 19					
			H72.1							See plot
B60/5	Jar Sample Silty CLAY; dark gray, highly plastic (CL-CH)	27.0 to 28.5	73							
			L73.1	34.3	48 20					
			H73.1							See plot

PROJECT: BELLE RIVER PLANT UNITS I & II

FILE NO. 1255
DATE Jan. 1974
SHEET OF

TABLE SUMMARY OF LABORATORY TEST RESULTS

BORING SAMPLE	IDENTIFICATION		DEPTH (FEET)	TEST NO.	PROPERTIES			STRENGTH		CONSOLIDATION		OTHER TESTS AND REMARKS
					NAT. WATER CONTENT (%)	ATTERBERG LIMITS wL wP	DRY UNIT WEIGHT (PCF)	TEST TYPE	ε %	MAX. SHEAR STRESS (PSF)	e ₀	
B60/2	Silty CLAY; grayish brown, stiff to very stiff consistency, highly plastic (CL-CH)		8.0 to 10.0	42								
			8.0 to 8.3	save 42.1								
			8.3	TV	28.3							TV=1.1tsf
			8.3 to 8.4	W42.1	28.3							
			8.4 to 8.7	save 42.2								
			8.7 to 9.0	T42.1.3	28.9		96	CU	5.3	1336		
			8.7 to 9.0	T42.1.3	28.9		98	CU _p	11.6	1751		Remolded sample
			9.0	TV	29.0							TV=0.88tsf
			9.0 to 9.1	W42.2	29.0							
			9.1 to 9.4	T42.1.2	29.3		95	CU	5.2	882		
			9.1 to 9.4	T42.1.2	29.3		99	CU _p	10.8	1244		Remolded sample
			9.4 to 9.7	T42.1.1	29.8		94	CU	3.6	530		
			9.4 to 9.7	T42.1.1	29.8		96	CU _p	15.0	875		Remolded sample
			9.7	TV	29.7							TV=1.1tsf
			9.7 to 9.8	W42.3	29.7							
			9.8 to 10.0	C42.1	30.0							Specific Gravity=2.71
			9.8 to 10.0	L42.1	29.7	53	26					

PROJECT: BELLE RIVER PLANT UNITS I & II

FILE NO. 1255

DATE March 1974

TABLE SUMMARY OF LABORATORY TEST RESULTS

SHEET OF

BORING SAMPLE	IDENTIFICATION		TEST NO.	PROPERTIES			STRENGTH		CONSOLIDATION		OTHER TESTS AND REMARKS
	SOIL DESCRIPTION	DEPTH (FEET)		NAT. WATER CONTENT (%)	ATTERBERG LIMITS w _L w _P	DRY UNIT WEIGHT (PCF)	TEST TYPE	ε %	MAX. SHEAR STRESS (PSF)	e ₀	
B60/3	2.0 Recovery; say 17.0' to 19.0' depth. Upper 0.5' disturbed	17.0 to 19.0	43								
		17.5	TV	29.9							TV=0.27 tsf
		17.5 to 17.6	W43.1	29.9							
	Silty CLAY, dark gray, medium to stiff consistency, moderately plastic (CL)	17.6 to 18.0	U43.1	24.3		105	U	20.0	1143		@15.0% strain s=1029 psf
		17.6 to 18.0	Ur43.1	24.3		103	Ur	20.0	1053		@15.0% strain s=879 psf
	Sample includes about 10% fine to coarse Sand grains (sub-rounded to subangular in shape)	17.6 to 18.0	L43.1	24.3	39	21					
		18.0	TV	19.2							TV=0.87 tsf
		18.0 to 18.1	W43.2	19.2							
		18.1 to 18.3	L43.1	26.1							
		18.1 to 18.3	H43.1								See plot
		18.6	TV	19.5							TV=0.46 tsf
		18.6 to 18.7	W43.3	19.5							
		18.7 to 19.0	save 43.1								

PROJECT: BELLE RIVER PLANT UNITS I & II

FILE NO. 1255

TABLE SUMMARY OF LABORATORY TEST RESULTS

DATE Jan. 1974
SHEET OF

BORING SAMPLE	IDENTIFICATION	DEPTH (FEET)	TEST NO.	PROPERTIES			STRENGTH			CONSOLIDATION		OTHER TESTS AND REMARKS	
				NAT. WATER CONTENT (%)	ATTERBERG LIMITS w _L w _P	DRY UNIT WEIGHT (PCF)	TEST TYPE	ε %	MAX. SHEAR STRESS (PSF)	e ₀	c _c		
B60/4	1.8' Recovery; say 21.0' to 22.8' depth Silty CLAY, grayish brown, stiff consistency, highly plastic (CL-CH) Includes about 5% coarse Sand and fine Gravel particles	21.0 to 23.0	44										
		21.1	TV	31.8									TV=0.52 tsf
		21.1 to 21.2	W44.1	31.8									
		21.2 to 21.5	T44.1.3	31.0	94	CU	3.8	2658					
		21.8	TV	30.9									TV=0.71 tsf
		21.8 to 21.9	W44.2	30.9									
		21.9 to 22.3	T44.1.1	30.4	94	CU	6.7	1389					
		21.9 to 22.3	I44.1	30.4	43	17							
		22.3	TV	29.9									TV=0.68 tsf
		22.3 to 22.4	W44.3	29.9									
		22.4 to 22.8	T44.1.4	30.6	95	CU	7.6	1588					

PROJECT: BELLE RIVER PLANT UNITS I & II		FILE NO. 1255										
TABLE SUMMARY OF LABORATORY TEST RESULTS		DATE Jan. 1974										
IDENTIFICATION		SHEET OF										
BORING SAMPLE	SOIL DESCRIPTION	DEPTH (FEET)	TEST NO.	PROPERTIES			STRENGTH		CONSOLIDATION		OTHER TESTS AND REMARKS	
				NAT. WATER CONTENT (%)	ATTERBERG LIMITS w_L w_P	DRY UNIT WEIGHT (PCF)	TEST TYPE	ϵ %	MAX. SHEAR STRESS (PSF)	e_o		c_c
B60/5	1.9' Recovery; say 25.0' to 26.9' depth	25.0 to 27.0	45									
		25.1	TV	34.8							TV=0.53 tsf	
	Silty CLAY; gray, moderate to high plasticity, firm to stiff consistency (CH-CL)	25.1	W45.1	34.8								
		25.2 to 25.6	save 45.1									
		25.6	TV	35.5								TV=0.55 tsf
		25.6	W45.2	35.5								
		25.7 to 26.1	U45.1	86				U	4.0	1002		
		25.7 to 26.1	save 45.1									
		26.1	TV	36.3								
		26.2	W45.3	36.3								
		26.2 to 26.5	save 45.2									
		26.5	TV									TV=0.50 tsf

PROJECT: BELLE RIVER PLANT UNITS I & II

FILE NO. 1255

DATE July 1974

TABLE SUMMARY OF LABORATORY TEST RESULTS

SHEET OF

IDENTIFICATION		DEPTH (FEET)	TEST NO.	PROPERTIES				STRENGTH			CONSOLIDATION		OTHER TESTS AND REMARKS
BORING SAMPLE	SOIL DESCRIPTION			NAT. WATER CONTENT (%)	ATTERBERG LIMITS w _L w _P	DRY UNIT WEIGHT (PCF)	TEST TYPE	ε %	MAX. SHEAR STRESS (PSF)	e ₀	c _c		
60/6	Silty CLAY, gray, firm to stiff consistency, high plasticity (CL-CH)	30.0-	—										
		32.0	46										
		30.1-	Saved										
		30.4	W46.1	40.4	81								
		30.4	TV										TV=0.47tsf
		30.5-	U46.1	35.0	88		U	3.7	1577				
		30.5-	L46.1	34.7	48	25							
		31.0	V46.1	34.0			VS		1000				
		31.3	TV				rVS		550				TV=0.40tsf

PROJECT: BELLE RIVER PLANT UNITS I & II

FILE NO. 1255

DATE Jan. 1974

SHEET _____ OF _____

SUMMARY OF LABORATORY TEST RESULTS

BORING SAMPLE	IDENTIFICATION		TEST NO.	PROPERTIES			STRENGTH		CONSOLIDATION		OTHER TESTS AND REMARKS	
	SOIL DESCRIPTION	DEPTH (FEET)		NAT. WATER CONTENT (%)	ATTERBERG LIMITS w_L w_p	DRY UNIT WEIGHT (PCF)	TEST TYPE	ϵ %	MAX SHEAR STRESS (PSF)	e_o		c_c
B60/8	1.7' Recovery; say 40.0' to 41.7' depth Silty CLAY; dark gray, moderate to high plasticity, firm consistency (CL-GH) Includes about 10% Silty fine Sand occurring as pockets or lenses 1/8" to 3/8" long	40.0 to 42.0										
		40.1	TV	23.6								TV=0.46 tsf
		40.1 to 40.2	W48.1	23.6								
		40.2 to 40.6	save 48.1									
		40.6	TV	33.7								TV=0.40 tsf
		40.6	W48.2	33.7								
		40.7 to 41.1	U48.1	39.7		83	U	3.0	338			
		40.7 to 41.1	L48.1	39.7	47	25						
		41.1	TV	41.4								TV=0.40 tsf
		41.1	W48.3	41.4								
		41.1 to 41.5	save 48.2									
		41.5	TV									TV=0.33 tsf

BORING SAMPLE	IDENTIFICATION	DEPTH (FEET)	TEST NO.	PROPERTIES			STRENGTH		CONSOLIDATION		OTHER TESTS AND REMARKS
				NAT. WATER CONTENT (%)	ATTERBERG LIMITS w _L w _p	DRY UNIT WEIGHT (PCF)	TEST TYPE	ε %	MAX. SHEAR STRESS (PSF)	e ₀	
B60/9	1.9' Recovery; say 45.0' to 46.9' depth	45.0 to 47.0	49								
		45.1	TV	25.9							TV=0.45tsf
	Silty CLAY, sandy, dark gray, firm to stiff consistency, highly plastic (CL) includes about 30% subangular to subrounded fine Gravel to coarse Sand size particles	45.1 to 45.2	W49.1	25.9							
		45.2 to 45.5	T49.1.3	26.0	102	CU	8.5	2510			
		45.5 to 45.8	T49.1.2	27.0	98	CU	8.2	1499			TV=0.50tsf
		45.8	TV	25.4							
		45.8 to 45.9	W49.2	25.4							
		45.9 to 46.3	T49.1.1	26.6	99	CU	12.9	1267			
		45.9 to 46.3	L49.1	24.8	38	16					
		46.3	TV	25.3							TV=0.52tsf
	46.3 to 46.4	W49.3	25.3								
	46.4 to 46.7	save 49.1									

PROJECT: BELLE RIVER PLANT UNITS I & II

FILE NO. 1255

DATE July 1974

TABLE SUMMARY OF LABORATORY TEST RESULTS

SHEET OF

BORING SAMPLE	IDENTIFICATION		TEST NO.	PROPERTIES			STRENGTH		CONSOLIDATION		OTHER TESTS AND REMARKS	
	SOIL DESCRIPTION	DEPTH (FEET)		NAT WATER CONTENT (%)	ATTERBERG LIMITS w _L w _P	DRY UNIT WEIGHT (PCF)	TEST TYPE	ε %	MAX. SHEAR STRESS (PSF)	e ₀		c _c
60/10	1.7' Recovery; say 50.0' to 51.7' depth; upper 0.5' disturbed Silty CLAY, dark gray, firm consistency, moderate plasticity (CL) Sample includes about 10% fine to coarse SAND and fine gravel size particles (subrounded to subangular in shape) Few thin (± 1/16" thick) lenses/layers of SILT, grey, non-plastic (ML) appear throughout comprising 5% of total sample	50.0-52.0										
		50.3-50.4	29.3									
		50.5-50.9										
		50.9										
		50.9-51.2		25.5		100	U	15.2	1255			TV=0.36 tsf @20% strain s=1367 psf
		50.9-51.2		25.7	34	16						
		51.2-51.3		25.9		97						
		51.3										TV=0.42 tsf
		51.3-51.6								VS rVS	1950 1050	

PROJECT: BELLE RIVER PLANT UNITS I & II		FILE NO. 1255										
TABLE SUMMARY OF LABORATORY TEST RESULTS		DATE March 1974										
IDENTIFICATION		SHEET OF										
BORING SAMPLE	SOIL DESCRIPTION	DEPTH (FEET)	TEST NO.	PROPERTIES			STRENGTH		CONSOLIDATION		OTHER TESTS AND REMARKS	
				NAT. WATER CONTENT (%)	ATTERBERG LIMITS w _L w _P	DRY UNIT WEIGHT (PCF)	TEST TYPE	ε %	MAX. SHEAR STRESS (PSF)	e ₀		cc [*]
B60/11	1.8' Recovery; say 55.0' to 56.8' depth	55.0 to 57.0	51									
		55.1	TV	25.9							TV=0.33 tsf	
	Silty CLAY, dark gray, moderate plasticity, firm to stiff consistency (CL) Includes about 20% medium to coarse SAND and #10% sub-angular to subrounded gravel size particles (1/4" to 1" size)	55.1 to 55.2	W51.1	25.9								
		55.2 to 55.5	save 51.1									
		55.5	TV	24.8								TV=0.63 tsf
		55.5 to 55.9	U51.1	24.8			103	U	24.0	1407		@15.0% strain s=1299 psf
		55.5 to 55.9	J _r 51.1	24.8			103	U _r	20.0	1002		@15.0% strain s=817 psf
		55.5 to 55.9	L51.1	24.8	33	18						
		56.0	TV	25.9							TV=0.50 tsf	
		56.0	W51.2	25.9								
		56.1 to 56.4	K51.1	25.5								
		56.1 to 56.4	S/H 51.1								See plot	
		56.4	TV	25.9							TV=0.46 tsf	
		56.4	W51.3	25.9								
		56.4 to 56.7	save 51.3									

PROJECT: BELLE RIVER PLANT UNITS I & II
 TABLE SUMMARY OF LABORATORY TEST RESULTS

FILE NO. 1255
 DATE Jan. 1974

SHEET 06 OF 06

IDENTIFICATION		TEST NO.	PROPERTIES			STRENGTH			CONSOLIDATION		OTHER TESTS AND REMARKS
			NAT. WATER CONTENT (%)	ATTERBERG LIMITS w _L w _P	DRY UNIT WEIGHT (PCF)	TEST TYPE	ε %	MAX. SHEAR STRESS (PSF)	e _o	c _c	
BORING SAMPLE	SOIL DESCRIPTION	DEPTH (FEET)									
B60/12	0.5' Recovery; say 60.0' to 60.5' depth Silty CLAY, dark gray, moderate plasticity (CL) Entire sample disturbed	60.0 to 62.0									
		60.0 to 60.2	W52.2	28.9							
		60.2	W52.1	27.9							
		60.2 to 60.4	L52.1	27.9	36	18					

PROJECT: BELLE RIVER PLANT UNITS I & II		FILE NO. 1255									
TABLE SUMMARY OF LABORATORY TEST RESULTS		DATE Jan. 1974									
IDENTIFICATION		SHEET 1 OF 1									
BORING SAMPLE	SOIL DESCRIPTION	DEPTH (FEET)	TEST NO.	PROPERTIES			STRENGTH		CONSOLIDATION		OTHER TESTS AND REMARKS
				NAT. WATER CONTENT (%)	ATTERBERG LIMITS w_L w_P	DRY UNIT WEIGHT (PCF)	TEST TYPE	ϵ %	MAX. SHEAR STRESS (PSF)	e_0	
B60/13	1.9' Recovery; say 67.0' to 68.9' depth	67.0 to 69.0	53								
		67.1	TV	24.7							TV=0.63 tsf
	Silty CLAY; dark gray, stiff consistency, moderately to highly plastic (CL)	67.1 to 67.2	W53.1	24.7							
	Sample includes zones of Silty CLAY, gravelly, stiff to very stiff consistency, moderately plastic (CL) and Clayey GRAVEL, sandy, slightly plastic (GC)	67.2 to 67.5	T53.1.4	15.5		114	CU	12.9	4613		
		67.2 to 67.5	T53.1.5	21.0		104	CU	11.9	3178		TV=0.95 tsf
		67.5	TV	16.4							
		67.5 to 67.6	W53.2	16.4							
		67.6 to 67.9	T53.1.3	19.7		104	CU	15.0	4060		
		67.9	TV								TV=0.48tsf
		67.9 to 68.3	L53.1	29.4	40	19					
		68.3 to 68.6	T53.1.1	23.6		104	CU	15.0	1945		
		68.3 to 68.6	T53.1.2	31.9		91	CU	6.2	1723		
		68.6	TV								TV=0.50 tsf
		68.6 to 68.7	W53.3	33.2							

PROJECT: BELLE RIVER PLANT UNITS I & II		FILE NO. 1255										
TABLE SUMMARY OF LABORATORY TEST RESULTS		DATE Jan. 1974										
IDENTIFICATION		SHEET ___ OF ___										
BORING SAMPLE	SOIL DESCRIPTION	DEPTH (FEET)	TEST NO.	PROPERTIES			STRENGTH		CONSOLIDATION		OTHER TESTS AND REMARKS	
				NAT. WATER CONTENT (%)	ATTERBERG LIMITS w_L w_p	DRY UNIT WEIGHT (PCF)	TEST TYPE	ϵ %	MAX. SHEAR STRESS (PSF)	e_o		c_c
B60/14	2.2' Recovery; say 74.0' to 76.2' depth	74.0 to 76.5	54									
		74.4	TV	25.9							TV=0.54tsf	
	Silty CLAY, dark gray, moderately to highly plastic, medium consistency (CL) Includes ±15% coarse Sand and subrounded to subangular Gravel size particles	74.4	W54.1	25.9								
		74.5 to 75.0	save 54.1									
		75.0	TV	26.8								TV=0.70tsf
		75.0	W54.2	26.8								
		75.1 to 75.6	U54.1	26.9	97			U	5.0	652		
		75.1 to 75.6	L54.1	26.9	40	20						
		75.6	TV	26.0								TV=0.70tsf
		75.6	W54.3	26.0								
		75.6 to 76.0	save 54.2									
		76.0	TV									TV=0.63tsf

PROJECT: BELLE RIVER PLANT UNITS I & II

FILE NO. 1255

DATE March 1974

SUMMARY OF LABORATORY TEST RESULTS

SHEET 1 OF 1

BORING SAMPLE	IDENTIFICATION	DEPTH (FEET)	TEST NO.	PROPERTIES			STRENGTH		CONSOLIDATION		OTHER TESTS AND REMARKS
				NAT. WATER CONTENT (%)	ATTERBERG LIMITS w _L w _P	DRY UNIT WEIGHT (PCF)	TEST TYPE	ε %	MAX. SHEAR STRESS (PSF)	e ₀	
B60/16	2.4' Recovery; say 84.0' to 86.4' depth	84.0 to 86.5	56.0								
	Silty CLAY, dark gray, moderate to high plasticity, firm consistency (CL) Includes about 20% fine to coarse sand particles and ±15% subangular to subrounded Gravel particles	84.2	TV	27.4							TV=0.62 tsf
		84.2	W56.1	27.4							
		84.2 to 84.6	save 56.1								
		84.6	TV	26.7							TV=0.73 tsf
		84.6	W56.2	26.7							
		84.7 to 85.1	save 56.2								
		85.2 to 85.4	C56.1	27.9					.744	.27	
		85.2 to 85.4	L56.1	26.9	40	19					
		85.2 to 85.4	SC56.1								Specific Gravity=2.73
		85.6	TV	26.1							TV=0.65 tsf
	85.6	W56.3	26.1								
	85.6 to 86.1	k56.1	29.1								
	85.6 to 86.1	S/H 56.1								See plot	
	86.1	TV								TV=0.65 tsf	

IDENTIFICATION		TEST NO.	PROPERTIES			STRENGTH		CONSOLIDATION		OTHER TESTS AND REMARKS
BORING SAMPLE	SOIL DESCRIPTION		DEPTH (FEET)	NAT. WATER CONTENT (%)	ATTERBERG LIMITS w _L w _P	DRY UNIT WEIGHT (PCF)	TEST TYPE	ε %	e ₀	
B60/19	2.5' Recovery; say 99.0' to 101.5' depth	99.0 to 101.5								
		99.5	27.6							TV=0.61 tsf
	Silty CLAY; dark gray, highly plastic, firm to stiff consistency (CL)	99.5	27.6							
	Includes ±15% coarse Sand and subrounded to subangular Gravel size particles	99.5 to 99.9								
		99.9	26.9							TV=0.80 tsf
		99.9	26.9							
		100.0 to 100.4	27.1			101	U	7.0		1132
		100.0 to 100.4	27.1		38 20					
		100.4	26.8							TV=0.80 tsf
		100.4	26.8							
		100.5 to 100.9								
		100.9	59.2							
		100.9	59.2							TV=0.66 tsf
	100.9 to 101.4	59.3								

FILE NO. 1255

DATE Jan. 1974

SHEET OF

PROJECT: BELLE RIVER PLANT UNITS I & II

TABLE SUMMARY OF LABORATORY TEST RESULTS

BORING SAMPLE	SOIL DESCRIPTION	DEPTH (FEET)	TEST NO.	PROPERTIES				STRENGTH		CONSOLIDATION		OTHER TESTS AND REMARKS
				NAT. WATER CONTENT (%)	ATTERBERG LIMITS		DRY UNIT WEIGHT (PCF)	TEST TYPE	MAX. SHEAR STRESS (PSF)	e ₀	Cc	
					w _L	w _p						
B60/23	2.3' Recovery; say 119.0' to 121.3' depth	119.0 to 121.5	63									
		119.6	TV	32.9								TV=0.35 tsf
	Silty CLAY, gray mottled reddish brown, low plasticity, soft consistency; includes about 40% fine to coarse Sand grains (subrounded to subangular) (CL-ML) At 120.0' change to Clayey SAND about 10% hard, subrounded to subangular Gravel particles, about 15% plastic and non-plastic fines (SC)	119.6 to	W63.1	32.9								
		120.0	U63.1	15.4	115	U	6.0	335				
		119.6 to	L63.1	15.4	17	11						
		120.0	TV	12.9								
		120.0	W63.2	12.9								
		120.1 to save										
		120.5	63.1									
		120.5	TV	17.2								TV=0.21 tsf
		120.5	W63.3	17.2								
		120.5 to save										
		121.0	63.2									

PROJECT: BELLE RIVER PLANT UNITS I & II		FILE NO. 1255										
TABLE SUMMARY OF LABORATORY TEST RESULTS		DATE April 1974										
IDENTIFICATION		SHEET 0F										
BORING SAMPLE	SOIL DESCRIPTION	DEPTH (FEET)	TEST NO.	PROPERTIES			STRENGTH		CONSOLIDATION		OTHER TESTS AND REMARKS	
				NAT. WATER CONTENT (%)	ATTERBERG LIMITS w _L w _P	DRY UNIT WEIGHT (PCF)	TEST TYPE	ε %	MAX. SHEAR STRESS (PSF)	e ₀		c _c
101/2	Silty CLAY, olive brown very stiff consistency, moderately to highly plastic (CL-CH) Sample includes about 5% hard, subrounded to rounded gravel size particles	8.0 to 10.0	349									
		8.1 to 8.7	save 349.1									sample used for T466.1, 2, 3
		8.7 to 8.9	W349.1	27.7	94							
		8.9 to 9.2	U349.1	27.8	96			U	2.4	1828		
		8.9 to 9.2	L349.1	27.8	50	22						
		9.2	TV									
		9.2 to 10.0	save 349.2									TV=1.8tsf sample used for T466.1, 2, 3

PROJECT: BELLE RIVER PLANT UNITS I & II

FILE NO. 1255

DATE April 1974

TABLE SUMMARY OF LABORATORY TEST RESULTS

SHEET OF

IDENTIFICATION		DEPTH (FEET)	TEST NO.	PROPERTIES			STRENGTH		CONSOLIDATION		OTHER TESTS AND REMARKS
BORING SAMPLE	SOIL DESCRIPTION			NAT. WATER CONTENT (%)	ATTERBERG LIMITS w _L w _P	DRY UNIT WEIGHT (PCF)	TEST TYPE	ε %	MAX. SHEAR STRESS (PSF)	e ₀	
101/4	2.3' Recovery; Say 19.0' to 21.3' depth Silty CLAY, gray, firm consistency, highly plastic (CL-CH)	19.0 to 21.5	—								
		19.0 to 19.3	save 351.1								
		19.3 to 19.5	W351.1	33.3		89					
		19.5	TV								TV=0.48tsf
		19.5 to 19.9	save 351.2								
		19.9 to 20.2	U351.1	35.8		86	U	6.0	1014		
		19.9 to 20.2	L351.1	35.8	49	24					
		20.2 to 20.4	W351.2	35.0		88					
		20.4	TV								TV=0.38tsf
		20.4 to 20.8	save 351.3								

PROJECT: BELLE RIVER PLANT UNITS I & II
 TABLE SUMMARY OF LABORATORY TEST RESULTS

FILE NO. 1255
 DATE April 1974

SHEET _____ OF _____

BORING SAMPLE	IDENTIFICATION		TEST NO.	PROPERTIES			STRENGTH		CONSOLIDATION		OTHER TESTS AND REMARKS
	SOIL DESCRIPTION	DEPTH (FEET)		NAT. WATER CONTENT (%)	ATTERBERG LIMITS WL Wp	DRY UNIT WEIGHT (PCF)	TEST TYPE	ε %	MAX. SHEAR STRESS (PSF)	e _o	
101/7	2.1' Recovery; Say 34.0' to 36.1' depth Silty CLAY, gray, firm consistency, moderately to highly plastic (CL-CH)	34.0 to 36.5	—								
		34.1 to save	354								
		34.4	354.1								
		34.4 to 34.6	W354.1		39.9	81					
		34.6	TV								TV=0.27tsf
		34.6 to 34.9	save 354.2								
		34.9 to 35.2	U354.1		40.0	81		U	2.4	796	
		34.9 to 35.2	L354.1		37.8	46	24				
		35.2 to 35.4	W354.2		38.6	83					
		35.4	TV								TV=0.34tsf
		35.4 to 35.7	save 354.3								

PROJECT: BELLE RIVER PLANT UNITS I & II		FILE NO. 1255									
TABLE SUMMARY OF LABORATORY TEST RESULTS		DATE April 1974									
IDENTIFICATION		SHEET ___ OF ___									
BORING SAMPLE	SOIL DESCRIPTION	DEPTH (FEET)	TEST NO.	PROPERTIES			STRENGTH		CONSOLIDATION		OTHER TESTS AND REMARKS
				NAT. WATER CONTENT (%)	ATTERBERG LIMITS w _L w _P	DRY UNIT WEIGHT (PCF)	TEST TYPE	ε %	MAX. SHEAR STRESS (PSF)	e ₀	
101/10	2.4' Recovery; Say 49.0' to 51.4' depth	49.0 to 51.6	357								
		49.1 to 49.4	save 357.1								
		49.4 to 49.6	W357.1	33.0		88					
	Silty CLAY; dark gray, firm consistency, moderately plastic (CL)	49.6	TV								TV=0.32tsf
		46.6 to 49.9	save 357.2								
	Sample includes about 20% coarse to fine sand grains (subrounded to subangular in shape)	50.1 to 50.4	U357.1	32.8		90			5.0	722	
		50.1 to 50.4	L357.1	31.0	40	22					
		50.4	TV								TV=0.44tsf
		50.6 to 50.8	W357.2	28.8		93					
		50.8	TV								TV=0.30tsf
		50.8 to 51.2	save 357.3								

PROJECT: BELLE RIVER PLANT UNITS I & II

TABLE SUMMARY OF LABORATORY TEST RESULTS

FILE NO. 1255
DATE April 1974
SHEET OF

BORING SAMPLE	IDENTIFICATION		TEST NO.	PROPERTIES			STRENGTH		CONSOLIDATION		OTHER TESTS AND REMARKS
	SOIL DESCRIPTION	DEPTH (FEET)		NAT. WATER CONTENT (%)	ATTERBERG LIMITS w _L w _P	DRY UNIT WEIGHT (PCF)	TEST TYPE	ε %	MAX. SHEAR STRESS (PSF)	e ₀	
101/13	2.4' Recovery; say 64.0' to 66.4' depth	64.0 to 66.5	360								
		64.6 to save									
		64.9	360.1								
	Silty CLAY; sandy, gray, stiff consistency, moderately plastic (CL)	64.9	TV								TV=0.49tsf
		64.9 to 65.1	W360.1	26.3	97						
		65.2 to 65.6	UB60.1	26.6	97						@15.0% strain s=1337 psf
	Sample includes about 30% fine to coarse sand and fine gravel size particles (sub-rounded to subangular in shape)	65.2 to 65.6	360.1	26.6	39 19			U	20.0	1430	
		65.6 to 65.8	W360.2	26.2	96						
		65.8	TV								TV=0.52tsf
		65.8 to 66.1	save								
		66.1	360.2								

FILE NO. 1255
DATE April 1974
SHEET ___ OF ___

PROJECT: BELLE RIVER PLANT UNITS I & II
TABLE SUMMARY OF LABORATORY TEST RESULTS

BORING SAMPLE	IDENTIFICATION		TEST NO.	PROPERTIES			STRENGTH		CONSOLIDATION		OTHER TESTS AND REMARKS
	SOIL DESCRIPTION	DEPTH (FEET)		NAT. WATER CONTENT (%)	ATTERBERG LIMITS wL wP	DRY UNIT WEIGHT (PCF)	TEST TYPE	ε %	MAX. SHEAR STRESS (PSF)	e ₀	
101/15	1.0' Recovery; Say 74.0' to 75.0' depth	74.0 to 76.5	362								
		74.1 to 74.4	save 362.1								
		74.4 to 74.6	W362.1	24.5		99					
	Silty CLAY; sandy, dark gray, stiff consistency, moderately plastic (CL)	74.6	TV								TV=0.69tsf
		74.6 to 74.9	T362.01	22.8		105	UU	17.0	1098		@15.0% strain s=1054 psf
	Sample includes about 30% coarse sand and fine gravel size particles (subrounded to subangular in shape)	74.6 to 74.9	L362.1	22.8	36	21					

PROJECT: BELLE RIVER PLANT UNITS I & II		FILE NO. 1255									
TABLE SUMMARY OF LABORATORY TEST RESULTS		DATE April 1974									
IDENTIFICATION		SHEET _____ OF _____									
BORING SAMPLE	SOIL DESCRIPTION	DEPTH (FEET)	TEST NO.	PROPERTIES			STRENGTH		CONSOLIDATION		OTHER TESTS AND REMARKS
				NAT. WATER CONTENT (%)	ATTERBERG LIMITS w _L w _P	DRY UNIT WEIGHT (PCF)	TEST TYPE	ε %	MAX. SHEAR STRESS (PSF)	e ₀	
101/17	2.3' Recovery; Say 84.0' to 86.3' depth	84.0 to 86.5	364								
		84.1 to save									
		84.4 to 364.1									
		84.4 to W364.1									
		84.6	W364.1	23.9		98					
	Silty CLAY; sandy, dark gray, stiff consistency. moderately plastic (CL)	84.6	TV								TV=0.60tsf
		84.6 to save									
		84.9	364.2								
	Sample includes about 30% coarse to fine sand and fine gravel size particles (subrounded to subangular in shape)	85.2 to 85.5	UB364.1	25.2		97	U	20.0	2072		@15.0% strain s=1923 psf
		85.2 to 85.5	UB364.1	25.2	37	19					
		85.5 to 85.7	W364.2	26.2		99					
		85.7	TV								TV=0.57tsf
		85.7 to save									
		86.1	364.3								

PROJECT: BELLE RIVER PLANT UNITS I & II
TABLE SUMMARY OF LABORATORY TEST RESULTS SHEET OF

BORING SAMPLE	IDENTIFICATION		DEPTH (FEET)	TEST NO.	PROPERTIES			STRENGTH		CONSOLIDATION		OTHER TESTS AND REMARKS
					NAT. WATER CONTENT (%)	ATTERBERG LIMITS w _L w _p	DRY UNIT WEIGHT (PCF)	TEST TYPE	ε %	MAX. SHEAR STRESS (PSF)	e ₀	
101/19	1.3' Recovery; say 94.0' to 95.3' depth; upper 0.9' disturbed (Wash?)		94.0 to 96.5	366								
	_____		94.9	TV								TV=0.36tsf @15.0%strain s=548 psf
	_____		94.9 to 95.3	366.0.1		24.5	100	UU	20.0	572		
	Silty CLAY, dark gray, firm consistency, moderately plastic (CL)		94.9 to 95.3	1366.1		24.5	36 20					
	Sample includes about 15% coarse sand and fine gravel size particles (subrounded to subangular in shape)											

PROJECT: BELLE RIVER PLANT UNITS I & II

TABLE SUMMARY OF LABORATORY TEST RESULTS

FILE NO. 1255

DATE April 1974

SHEET OF

IDENTIFICATION		TEST NO.	PROPERTIES			STRENGTH		CONSOLIDATION		OTHER TESTS AND REMARKS	
BORING SAMPLE	SOIL DESCRIPTION		DEPTH (FEET)	NAT. WATER CONTENT (%)	ATTERBERG LIMITS w _L w _P	DRY UNIT WEIGHT (PCF)	TEST TYPE	ε %	e ₀ c _c		
101/23	<p>Silty CLAY; gray, firm to stiff consistency, moderately plastic (CL)</p> <p>Sample includes about 10% coarse to fine sand and fine gravel size particles (subrounded to subangular in shape)</p>	119.0 to 121.5									
		119.1 to 119.4	370.1								
		119.4 to 119.5	W370.1	31.8		91					
		119.5	TV								TV=0.42 tsf
		119.5 to 119.8	save 370.2								
		119.8 to 120.2	U370.0.1	37.2		85	UU	8.0	721		
		120.2 to 120.4	L370.1	37.2	44 22						
		120.2 to 120.4	W370.2	32.6		88					
		120.4	TV								TV=0.55tsf
		120.4 to 120.7	save 370.3								
		120.7 to 121.1	save 370.4								

PROJECT: BELLE RIVER PLANT UNITS I & II
 TABLE SUMMARY OF LABORATORY TEST RESULTS

FILE NO. 1255
 DATE April 1974

SHEET OF

IDENTIFICATION		TEST NO.	PROPERTIES		STRENGTH		CONSOLIDATION		OTHER TESTS AND REMARKS		
BORING SAMPLE	SOIL DESCRIPTION		NAT. WATER CONTENT (%)	ATTERBERG LIMITS w _L w _P	DRY UNIT WEIGHT (PCF)	TEST TYPE	ε %	MAX. SHEAR STRESS (PSF)		e ₀	C _c
105/1	Silty CLAY; olive brown and grayish brown, very stiff to hard consistency, highly plastic (CH) Sample includes about 5% hard, rounded gravel sized particles	4.0 to 6.0									
		373									
		4.2 to 4.5	save 373.1								
		4.5 to 4.7	W373.1	23.4	100						
		4.7 to 5.0	save 373.2								
		5.0	TV								TV=2.00tsf
		5.1 to 5.4	C373.1	23.6					.642	.10	
		5.1 to 5.4	L373.1	23.6	53 24						
		5.1 to 5.4	SC373.1								specific gravity=2.72
		5.4 to 5.6	W373.2	24.2	101						
		5.6 to 5.9	save 373.3								

PROJECT: BELLE RIVER PLANT UNITS I & II		FILE NO. 1255										
TABLE SUMMARY OF LABORATORY TEST RESULTS		DATE July 1974										
IDENTIFICATION		SHEET OF										
BORING SAMPLE	SOIL DESCRIPTION	DEPTH (FEET)	TEST NO.	PROPERTIES			STRENGTH		CONSOLIDATION		OTHER TESTS AND REMARKS	
				NAT. WATER CONTENT (%)	ATTERBERG LIMITS w_L w_P	DRY UNIT WEIGHT (PCF)	TEST TYPE	ϵ %	MAX. SHEAR STRESS (PSF)	e_0		c_c
105/2	<p>Silty CLAY, olive brown and greyish brown, very stiff consistency, moderate to highly plastic (CL)</p> <p>Sample includes about 5% hard subrounded gravel particles to 3/4" max. size</p> <p>Note: Saved material used as part of MC466.1 and T466.1.1, 2, 3 test series</p>	9.0-11.0	—									
		9.1-9.4	T374.14	27.7		98	CU	5.8	1189			$\bar{\sigma}_c = 864 \text{ psf}$
		9.4-9.7	L374.1	27.6	46	24						
		9.7-9.9	W374.1	26.1		100						
		9.9-10.2	T374.1.1	26.3		97	CU	3.0	1273			$\bar{\sigma}_c = 576 \text{ psf}$
		10.2	TV									TV-1.1tsf
		10.2-10.6	T374.1.2	26.4		99	CU	4.4	1227			$\bar{\sigma}_c = 1152 \text{ psf}$
		10.6-10.9	T374.1.3	26.9		96	CU	10.5	2191			$\bar{\sigma}_c = 2304 \text{ psf}$

PROJECT: BELLE RIVER PLANT UNITS I & II
 TABLE SUMMARY OF LABORATORY TEST RESULTS

FILE NO. 1255
 DATE July, 1974
 SHEET OF

IDENTIFICATION		TEST NO.	PROPERTIES			STRENGTH		CONSOLIDATION		OTHER TESTS AND REMARKS	
BORING SAMPLE	SOIL DESCRIPTION		DEPTH (FEET)	NAT. WATER CONTENT (%)	ATTERBERG LIMITS w _L w _p	DRY UNIT WEIGHT (PCF)	TEST TYPE	ε %	MAX. SHEAR STRESS (PSF)		e ₀
105/3	Silty CLAY, grey, medium consistency, moderately plastic (CL) Sample includes about 5% fine to coarse Sand grain (subrounded to subangular in shape)	20.0-									
		22.0	375								
		20.1-									
		20.4	Saved								
		20.4-									
		20.6	W375.1	36.0		85					
		20.6	TV								TV=0.39tsf
		20.6-									
		20.9	Saved								
		20.9-									
		21.2	L375.1	33.4	42	20					
		21.2-									
		21.4	W375.2	33.3		86					TV=0.41tsf
		21.4	TV								
		21.4-									
	21.7	Saved									

PROJECT: BELLE RIVER PLANT UNITS I & II

FILE NO. 1255
DATE July 1971

SUMMARY OF LABORATORY TEST RESULTS

SHEET ___ OF ___

BORING SAMPLE	IDENTIFICATION		DEPTH (FEET)	TEST NO.	PROPERTIES			STRENGTH		CONSOLIDATION		OTHER TESTS AND REMARKS
					NAT. WATER CONTENT (%)	ATTERBERG LIMITS w _L w _P	DRY UNIT WEIGHT (PCF)	TEST TYPE	ε %	MAX. SHEAR STRESS (PSF)	e ₀	
105/4	SOIL DESCRIPTION		30.0- 32.0	—								
	1.1' Recovery; say 30.0' to 31.1' depth		30.7- 31.0	376								
	Silty CLAY, grey, moderately plastic (CL)			Saved								
	Note: Entire Sample much disturbed.											

PROJECT: BELLE RIVER PLANT UNITS I & II		FILE NO. 1255									
TABLE SUMMARY OF LABORATORY TEST RESULTS		DATE									
IDENTIFICATION		SHEET OF									
BORING SAMPLE	SOIL DESCRIPTION	DEPTH (FEET)	TEST NO.	PROPERTIES			STRENGTH		CONSOLIDATION		OTHER TESTS AND REMARKS
				NAT. WATER CONTENT (%)	ATTERBERG LIMITS w _L w _P	DRY UNIT WEIGHT (PCF)	TEST TYPE	€ %	MAX. SHEAR STRESS (PSF)	e ₀	
105/5	2.2' Recovery; say 40.0' to 42.2' depth	40.0-42.5	377								
		40.1-40.4	T377.1A	39.2		84	CU	7.6	1902		$\bar{\sigma}_c = 7200$ psf
		40.4	TV								TV=0.35 tsf
		40.4-									
		40.6	W377.1	35.7							
		40.6-41.0	T377.1I	35.9		84	CU	5.9	1068		$\bar{\sigma}_c = 1800$ psf
		40.6-									
		41.0	L377.1	35.9	44	21					
		41.0-41.3	T377.1J	35.9		85	CU	3.1	1376		$\bar{\sigma}_c = 3600$ psf
		41.3-									
		41.5	W377.2	34.9		86					
		41.5	TV								TV=0.37 tsf
		41.5-41.8	T377.1K	35.1		85	CU	3.8	1830		$\bar{\sigma}_c = 7200$ psf

PROJECT: BELLE RIVER PLANT UNITS I & II

FILE NO 1255

TABLE SUMMARY OF LABORATORY TEST RESULTS

DATE July 1974

SHEET OF

IDENTIFICATION		TEST NO.	PROPERTIES			STRENGTH		CONSOLIDATION		OTHER TESTS AND REMARKS
BDRING SAMPLE	SOIL DESCRIPTION		NAT. WATER CONTENT (%)	ATTERBERG LIMITS w _L w _P	DRY UNIT WEIGHT (PCF)	TEST TYPE	ε %	e ₀	c _c	
105/6	1.7' Recovery; say 50.0' to 51.7' depth	378								
	Silty CLAY, grey, medium consistency, highly plastic (CH)	Saved								
		W378.1	42.8		76					
		TV								TV=0.35tsf
		Saved								
		L378.2	46.2	57	25					
		W378.2	41.2		78					
		TV								TV=0.33tsf

PROJECT: BELLE RIVER PLANT UNITS I & II
 TABLE SUMMARY OF LABORATORY TEST RESULTS

FILE NO. 1255
 DATE July 1974
 SHEET OF

BORING SAMPLE	IDENTIFICATION		DEPTH (FEET)	TEST NO.	PROPERTIES			STRENGTH		CONSOLIDATION		OTHER TESTS AND REMARKS
					NAT. WATER CONTENT (%)	ATTERBERG LIMITS w _L w _P	DRY UNIT WEIGHT (PCF)	TEST TYPE	ε %	MAX SHEAR STRESS (PSF)	e _o	
105/8	2.3' Recovery; say 70.0' to 72.3' depth		70.0-72.5	380								
			70.1-70.4	Saved								
	Silty CLAY, dark grey, stiff consistency, moderate plasticity (CL)		70.4-70.6	W380.1	23.9	100						
			70.6	TV								TV=0.65tsf
			70.6-70.9	Saved								
	Sample includes about 20% fine to coarse Sand and fine gravel size particles (sub-rounded to subangular in shape)		70.9-71.2	C380.1	23.7					0.625	.21	
			70.9-71.2	L380.1	23.8	37	19					Specific Gravity-2.70
			70.9-71.2	SG 380.1								
			71.3-71.5	W380.2	23.5	100						
			71.5	TV								TV=0.70tsf
			71.5-71.8	Saved								
			71.8-72.2	Saved								

PROJECT: BELLE RIVER PLANT UNITS I & II		FILE NO. 1255									
TABLE SUMMARY OF LABORATORY TEST RESULTS		DATE July 1974									
IDENTIFICATION		SHEET ___ OF ___									
BORING SAMPLE	SOIL DESCRIPTION	DEPTH (FEET)	TEST NO.	PROPERTIES			STRENGTH		CONSOLIDATION		OTHER TESTS AND REMARKS
				NAT. WATER CONTENT (%)	ATTERBERG LIMITS w_L w_p	DRY UNIT WEIGHT (PCF)	TEST TYPE	ϵ %	e_o	c_c	
105/10	1.6' Recovery; say 90.0' to 91.6' depth	90.0-92.0	382								
		90.5-90.6	W382.1	31.0		84					
		90.6	TV								TV=0.17tsf
		90.6-90.9	L382.1	29.4	34	19					
		90.9-91.2	Saved								
		91.2-91.3	W382.2	30.3		88					
		91.3	TV								TV=0.18tsf

PROJECT: BELLE RIVER PLANT UNITS I & II		FILE NO. 1255									
TABLE SUMMARY OF LABORATORY TEST RESULTS		DATE July 1974									
IDENTIFICATION		SHEET OF									
BORING SAMPLE	SOIL DESCRIPTION	DEPTH (FEET)	TEST NO.	PROPERTIES			STRENGTH		CONSOLIDATION		OTHER TESTS AND REMARKS
				NAT. WATER CONTENT (%)	ATTERBERG LIMITS w_L w_p	DRY UNIT WEIGHT (PCF)	TEST TYPE	ϵ %	MAX. SHEAR STRESS (PSF)	e_0	
105/11	1.7' Recovery; say 110.0' to 111.7' depth; upper 0.7' disturbed, WASH? ?	110.0- 111.5	383								
		110.7- 110.9	W383.1	31.7		86					
	Silly CLAY, grey, soft consistency, moderately plastic (CL)	110.9	TV								TV-0.25tsf
	Sample includes about 15% fine to coarse Sand grains (subrounded to subangular in shape)	110.9- 111.3	Saved								
	Note: Entire Sample disturbed.										

PROJECT: BELLE RIVER PLANT UNITS I & II

FILE NO. 1255

TABLE SUMMARY OF LABORATORY TEST RESULTS

DATE July 1974

BORING SAMPLE	IDENTIFICATION		TEST NO.	PROPERTIES			STRENGTH		CONSOLIDATION		OTHER TESTS AND REMARKS	
				NAT. WATER CONTENT (%)	ATTERBERG LIMITS	DRY UNIT WEIGHT (PCF)	TEST TYPE	ε %	MAX. SHEAR STRESS (PSF)	e _o		Cc
105/12	SOIL DESCRIPTION	DEPTH (FEET)	—									
	0.7' Recovery; say 120.0' to 120.7' depth	120.0-122.5	384									
	-----	120.2-120.3	W384.1	22.1		102						
	Silty CLAY, Sandy, dark gray, medium consistency, moderate plasticity (CL)	120.3-120.6	saved									
	Sample includes about 35% fine to coarse SAND grains (subrounded to subangular in shape)	120.6-120.7	I384.1	20.4	29	17						
	Note: Entire sample slightly disturbed											

PROJECT: BELLE RIVER PLANT UNITS I & II

FILE NO. 1255

TABLE SUMMARY OF LABORATORY TEST RESULTS

DATE July 1974

SHEET OF

BORING SAMPLE	IDENTIFICATION		DEPTH (FEET)	TEST NO.	PROPERTIES			STRENGTH		CONSOLIDATION		OTHER TESTS AND REMARKS
					NAT. WATER CONTENT (%)	ATTERBERG LIMITS w _L w _P	DRY UNIT WEIGHT (PCF)	TEST TYPE	ε %	MAX. SHEAR STRESS (PSF)	e ₀	
118/1	2.1' Recovery; say 3.0' to 5.1' depth; upper 1.0' disturbed (WASH??)		3.0-5.0	252								
	Silty CLAY, greyish brown, hard consistency, moderate to highly plastic (CL-CH)		4.0-4.3	L252.1	21.4	49 26						
			4.4-4.5	W252.1	22.3		101					
			4.5	TV								TV > 2.5tsf
			4.6-5.0	Saved								

PROJECT: BELLE RIVER PLANT UNITS I & II		FILE NO. 1255									
TABLE SUMMARY OF LABORATORY TEST RESULTS		DATE									
IDENTIFICATION		SHEET ___ OF ___									
BORING SAMPLE	SOIL DESCRIPTION	DEPTH (FEET)	TEST NO.	PROPERTIES		STRENGTH		CONSOLIDATION		OTHER TESTS AND REMARKS	
				NAT. WATER CONTENT (%)	ATTERBERG LIMITS w _L w _P	DRY UNIT WEIGHT (PCF)	TEST TYPE	ε %	MAX. SHEAR STRESS (PSF)		e ₀
118/2	1.5' Recovery; say 8.0' to 9.5' depth	8.0 - 10.0'	253								
		8.1'	W253.1	23.8							
	Silty CLAY, dark grayish brown, very stiff to hard consistency, highly plastic (CL - CH)	8.2 -									
		8.5'	T253.2	23.0	107	CD	4.3	754		$\bar{\sigma}_c = 576$ psf	
		8.2 -									
		8.5'	L253.1	23.3	49	23					
	Sample includes ±5% coarse Sand and fine Gravel size particles	8.5'	W253.2	21.5							
		8.6 -									
		8.9'	T253.2	23.3		105	CD	3.6	1248		$\bar{\sigma}_c = 1152$ psf
		8.9 -									
		9.2'	T253.3	24.2		103	CD	2.2	2156		$\bar{\sigma}_c = 2304$ psf
		9.2 -									
		9.5'	Saved								

PROJECT: BELLE RIVER PLANT UNITS I & II
 TABLE: SUMMARY OF LABORATORY TEST RESULTS

FILE NO. 1255
 DATE July 1974
 SHEET OF

BORING SAMPLE	IDENTIFICATION		TEST NO.	PROPERTIES			STRENGTH		CONSOLIDATION		OTHER TESTS AND REMARKS
				NAT. WATER CONTENT (%)	ATTERBERG LIMITS WL WP	DRY UNIT WEIGHT (PCF)	TEST TYPE	ε %	MAX. SHEAR STRESS (PSF)	e ₀	
118/3	2.1' Recovery; say 18.0' to 20.1' depth; upper 0.5' disturbed	Silty CLAY, grey, firm consistency, moderate to high plasticity (CL)	18.0 - 20.0								
			18.7 - 18.9	W254.1	35.5	84					
			18.9								TV=0.37tsf
			18.9 - 19.3								
			19.3 - 19.5								
			19.5								
			19.5 - 19.9								
											TV=0.40tsf

BORING SAMPLE	IDENTIFICATION		TEST NO.	PROPERTIES			STRENGTH		CONSOLIDATION		OTHER TESTS AND REMARKS	
	SOIL DESCRIPTION	DEPTH (FEET)		NAT. WATER CONTENT (%)	ATTERBERG LIMITS w _L w _P	DRY UNIT WEIGHT (PCF)	TEST TYPE	ε %	MAX. SHEAR STRESS (PSF)	e _o		c _c
118/4	21.4' Recovery; say 28.0' to 30.1' depth Silty CLAY, gray, mottled very dark gray, firm to stiff consistency, moderate plasticity (CL) Sample includes about 15% fine to coarse SAND grains (subrounded to subangular in shape) Note: Upper 1.3' of sample slightly disturbed	28.0-30.0	255									
		28.5-28.6	W255.1	94								
		28.6	TV									TV= 0.28 tsf
		28.6-28.9	saved									
		28.9-29.3	saved									
		29.3-29.4	W255.2	103								
		29.4	TV									TV=0.64 tsf
		29.4-29.8	saved									

PROJECT: BELLE RIVER PLANT UNITS I & II

FILE NO. 1255

DATE July 1974

SUMMARY OF LABORATORY TEST RESULTS

SHEET OF

BORING SAMPLE	IDENTIFICATION		DEPTH (FEET)	TEST NO.	PROPERTIES			STRENGTH		CONSOLIDATION		OTHER TESTS AND REMARKS	
					NAT WATER CONTENT (%)	ATTERBERG LIMITS WL WP	DRY UNIT WEIGHT (PCF)	TEST TYPE	ε %	MAX SHEAR STRESS (PSF)	e ₀		C _c
118/5	Silty CLAY, greyish brown, firm consistency, moderately plastic (CL)		38.0-40.0	—									
			38.1-38.4	Saved									
			38.4	TV									TV=0.34tsf
			38.4-										
			38.6	W256.1	36.9			85					
			38.6-										
			38.9	Saved									
			38.9-										
			39.3	C256.1	36.9							0.969	0.39
			38.9-39.3	I256.1	36.9	41	22						
			39.3	SG									Specific Gravity-2.70
			39.3	256.1									TV-0.35tsf
			39.3	TV									
			39.3-										
	39.5	W256.2	36.6			86							
	39.5-												
	39.8	Saved											

PROJECT: BELLE RIVER PLANT UNITS I & II

FILE NO. 1255

TABLE SUMMARY OF LABORATORY TEST RESULTS

DATE July 1974

SHEET OF

BORING SAMPLE	IDENTIFICATION	DEPTH (FEET)	TEST NO.	PROPERTIES		STRENGTH		CONSOLIDATION		OTHER TESTS AND REMARKS	
				NAT. WATER CONTENT (%)	ATTERBERG LIMITS w _L w _P	DRY UNIT WEIGHT (PCF)	TEST TYPE	ε %	e ₀		c _c
118/6	2.1' Recovery; say 48.0' to 50.1' depth	48.0-50.0	257								
	Silty CLAY, grey, firm consistency, moderate to high plasticity (CL-CH) Sample includes few thin lenses/layers of SILT, Sandy (ML) comprising ±5% of total	48.4-48.5	W257.1	42.6	76						
		48.5	TV							TV=0.30tsf	
		48.5-48.8	Saved								
		48.8-49.2	Saved								
		49.2-49.3	W257.2	43.9	76						
		49.3	TV							TV=0.43tsf	

FILE NO. 1255
DATE July 1974
SHEET ___ OF ___

PROJECT: BELLE RIVER PLANT UNITS I & II
TABLE: SUMMARY OF LABORATORY TEST RESULTS

BORING SAMPLE	IDENTIFICATION		DEPTH (FEET)	TEST NO.	PROPERTIES			STRENGTH		CONSOLIDATION		OTHER TESTS AND REMARKS
					NAT WATER CONTENT (%)	ATTERBERG LIMITS w _L w _p	DRY UNIT WEIGHT (PCF)	TEST TYPE	ε %	MAX. SHEAR STRESS (PSF)	e ₀	
118/9	1. 9' Recovery; say 78.0' to 79.9' depth; upper 0.3' disturbed		78.0- 80.0	260								
			78.1- 78.4	Saved								
	Silty CLAY; dark grey, stiff consistency, moderately plastic (CL)		78.4- 78.7	W260.1	22.1	103						
			78.7	TV								TV=0.68tsf
			78.7-									
	Sample includes about 20% fine to coarse Sand and fine Gravel size particles (sub-rounded to subangular in shape)		79.0	C260.1	27.8					0.741	.24	
			78.7-									
			79.0	L260.1	25.3	42	23					
			78.7-	SG								Specific Gravity -2.70
			79.0	260.1								
	Note: Proportions of Sand and fine Gravel increase with depth approaching 40% near bottom of sample.		79.0- 79.4	Saved								
			79.4-									
			79.7	W260.2	13.1		123					

PROJECT: BELLE RIVER PLANT UNITS I & II FILE NO. 1255
 TABLE SUMMARY OF LABORATORY TEST RESULTS DATE Jan. 1974 SHEET OF

BORING SAMPLE	IDENTIFICATION	TEST NO.	PROPERTIES		STRENGTH		CONSOLIDATION		OTHER TESTS AND REMARKS
			NAT. WATER CONTENT (%)	ATTERBERG LIMITS w_L w_p	DRY UNIT WEIGHT (PCF)	TEST TYPE	e_0	c_c	
B119/1	SOIL DESCRIPTION	DEPTH (FEET)							
	0.8' Recovery; say 3.0' to 3.8' depth	3.0 to 5.0							
		3.1	32.4						TV=1.0 tsf
	Silty CLAY; dark grayish brown mottled light olive brown, stiff to very stiff consistency, moderately to highly plastic (CL)	3.1	32.4						
		3.1 to 3.4							
		3.4							TV=1.34 tsf
		3.4 to 3.8			98				

PROJECT: BELLE RIVER PLANT UNITS I & II		FILE NO. 1255											
TABLE SUMMARY OF LABORATORY TEST RESULTS		DATE Jan. 1974											
IDENTIFICATION		SHEET OF											
BORING SAMPLE	SOIL DESCRIPTION	DEPTH (FEET)	TEST NO.	PROPERTIES			STRENGTH		CONSOLIDATION		OTHER TESTS AND REMARKS		
				NAT. WATER CONTENT (%)	ATTERBERG LIMITS w _L w _p	DRY UNIT WEIGHT (PCF)	TEST TYPE	ε %	MAX. SHEAR STRESS (PSF)	e ₀		c _c	
B119/2	Recovery 2.2'; say 8.0' to 10.2' depth	8.0 to 10.0	332										
	Silty CLAY, dark, grayish brown, very stiff consistency, moderately to highly plastic (CL) Sample includes about 10% coarse Sand and fine Gravel size particles (subrounded to subangular in shape)	8.2	TV									TV=1.25 tsf	
		8.2 to 8.3	W332.1		28.4								
		8.3 to 8.6	T332.1.3		27.9	98		CU	2.2	2012			
		8.6	TV										TV=1.43 tsf
		8.6 to 9.0	T332.1.4		29.2	94		CU	1.5	1240			
		9.0	TV										TV=1.43 tsf
		9.0 to 9.1	W332.2		27.5								
		9.1 to 9.4	T332.1.1		28.3	95		CU	2.2	887			
		9.4	TV										TV=1.50 tsf
		9.4 to 9.5	W332.3		29.2								
	9.5 to 9.7	L332.1		30.8	53	26							
	9.7 to 10.1	save 332.1											

PROJECT: BELLE RIVER PLANT UNITS I & II

FILE NO. 1255

DATE Jan. 1974

SUMMARY OF LABORATORY TEST RESULTS

SHEET ___ OF ___

IDENTIFICATION		TEST NO.	PROPERTIES		STRENGTH		CONSOLIDATION		OTHER TESTS AND REMARKS	
BORING SAMPLE	SOIL DESCRIPTION		NAT. WATER CONTENT (%)	ATTERBERG LIMITS w _L w _p	DRY UNIT WEIGHT (PCF)	TEST TYPE	ε %	MAX. SHEAR STRESS (PSF)		e _o
B119/3	1.9' Recovery; say 20.0' to 21.9' depth; upper 0.3' disturbed	—								
		333								
		St	37.3							
	Silty CLAY: dark gray, firm consistency, highly plastic (CL-CH)	W333.1	37.3							
		20.4 to save								TV=0.31 tsf
		20.7 333.1								IV _R =0.17 tsf
		20.7 TV								
		20.7 to save								
		21.1 333.2								TV=0.32 tsf
		21.1 TV	37.2							
		21.1 to								
		21.2 W333.2	37.2							
		21.2 to save								
		21.5 333.3								
		21.5 TV								
		21.5 to								
		21.9 W333.1	36.3		83					TV=0.29 tsf

FILE NO. 1255
DATE Jan. 1974
SHEET OF

PROJECT: BELLE RIVER PLANT UNITS I & II
TABLE SUMMARY OF LABORATORY TEST RESULTS

BORING SAMPLE	IDENTIFICATION		TEST NO.	PROPERTIES			STRENGTH		CONSOLIDATION		OTHER TESTS AND REMARKS	
	SOIL DESCRIPTION	DEPTH (FEET)		NAT. WATER CONTENT (%)	ATTERBERG LIMITS wL wP	DRY UNIT WEIGHT (PCF)	TEST TYPE	ε %	MAX. SHEAR STRESS (PSF)	e ₀		Cc
B119/4	Silty CLAY: very dark grayish brown, soft to firm consistency, highly plastic (CL) Sample includes ±5% coarse Sand and fine Gravel size particles (subrounded to sub-angular in shape)	30.0 to 32.0										
		30.1	35.4									TV=0.24 tsf
		30.1 to 30.2	35.4									
		30.2 to 30.5										
		30.5										TV=0.26 tsf
		30.5 to 30.8	35.3			87	CU	5.6	1655			TV=0.29 tsf TV=0.11 tsf
		30.8	37.8									
		30.8 to 30.9	37.8									
		30.9 to 31.2	38.5			85	CU	1.5	1229			
		31.2										TV=0.30 tsf
		31.2 to 31.6	36.9			86	CU	1.5	985			
		31.2 to 31.6	36.4	41	22							
	31.6 to 31.9											

PROJECT: BELLE RIVER PLANT UNITS I & II

FILE NO. 1255

DATE Jan. 1974

TABLE SUMMARY OF LABORATORY TEST RESULTS

SHEET 0F

BORING SAMPLE	IDENTIFICATION		DEPTH (FEET)	TEST NO.	PROPERTIES			STRENGTH		CONSOLIDATION		OTHER TESTS AND REMARKS
					NAT. WATER CONTENT (%)	ATTERBERG LIMITS w_L w_P	DRY UNIT WEIGHT (PCF)	TEST TYPE	ϵ %	MAX. SHEAR STRESS (PSF)	e_0	
B119/5	Silty CLAY: dark grayish brown, soft to firm consistency, highly plastic (CL-CH)		40.0 to 42.5	335								
			40.2 to 40.5	TV	35.4		88					TV=0.26 tsf
			40.5 to 40.6	TV	35.6							TV=0.27 tsf
			40.6 to 40.9	W335.1 save 335.1	35.6							
			40.9 to 41.3	TV								TV=0.29 tsf
			41.3 to 41.4	save 335.2								TV=0.27 tsf
			41.4 to 41.7	St	36.0							TV _R =0.14 tsf
			41.7 to 42.1	W335.2 save 335.3	36.0							
			42.1 to 42.1	TV								TV=0.31 tsf
												TV=0.30 tsf

PROJECT: BELLE RIVER PLANT UNITS I & II		FILE NO. 1255									
TABLE SUMMARY OF LABORATORY TEST RESULTS		DATE _____									
IDENTIFICATION		SHEET _____ OF _____									
BORING SAMPLE	SOIL DESCRIPTION	DEPTH (FEET)	TEST NO.	PROPERTIES			STRENGTH		CONSOLIDATION		OTHER TESTS AND REMARKS
				NAT. WATER CONTENT (%)	ATTERBERG LIMITS w/L w/P	DRY UNIT WEIGHT (PCF)	TEST TYPE	ε %	MAX SHEAR STRESS (PSF)	e _o	
B119/9	2.1' Recovery; say 80.0' to 82.1' depth	80.0 to 82.5	339								
		80.1	TV	22.4							TV = 0.90 tsf
		80.1 to 80.2	W339.1	22.4							
		80.2 to 80.5	save 339.1								
		80.5 to 80.8	W339.1	21.6		107					
		80.5 to 80.8	save 339.2								
		80.8	TV	21.0							TV = 1.0 tsf
		80.8 to 80.9	W339.2	21.0							
		80.9 to 81.2	save 339.3								
		81.2 to 81.5	save 339.4								
		81.5	TV	22.1							TV = 0.73 tsf
		81.5 to 81.6	W339.1	22.1							
		81.6 to 81.9	U339.1	20.7		107					@15% Strain s = 3072 psf
		81.6 to 81.9	L339.1	20.7	33	20					

PROJECT: BELLE RIVER PLANT UNITS I & II
 TABLE SUMMARY OF LABORATORY TEST RESULTS

FILE NO. 1255
 DATE April 1974
 SHEET OF

IDENTIFICATION		TEST NO.	PROPERTIES			STRENGTH		CONSOLIDATION		OTHER TESTS AND REMARKS		
BORING SAMPLE	SOIL DESCRIPTION		DEPTH (FEET)	NAT. WATER CONTENT (%)	ATTERBERG LIMITS w _L w _P	DRY UNIT WEIGHT (PCF)	TEST TYPE	ε %	MAX. SHEAR STRESS (PSF)		e ₀	c _c
126/3	Silty CLAY, olive brown, very stiff consistency, moderately to highly plastic (CL-CH) Sample includes about 5% hard subrounded to subangular gravel particles	8.0 to 10.0										
		8.2 to 8.6	26.2	99	U	2.4	1735					
		8.2 to 8.6	26.6	47	24							
		8.6 to 8.8	27.1	97								
		9.1	TV								TV=1.12tsf	
		9.4 to 9.6	27.0	96								
		9.6 to 9.9	save 241.2									

PROJECT: BELLE RIVER PLANT UNITS I & II
 TABLE SUMMARY OF LABORATORY TEST RESULTS

FILE NO. 1255
 DATE April 1974
 SHEET OF

BORING SAMPLE	IDENTIFICATION	DEPTH (FEET)	TEST NO.	PROPERTIES			STRENGTH		CONSOLIDATION		OTHER TESTS AND REMARKS
				NAT. WATER CONTENT (%)	ATTERBERG LIMITS wL wP	DRY UNIT WEIGHT (PCF)	TEST TYPE	€ %	MAX. SHEAR STRESS (PSF)	e ₀	
126/5	1.9' Recovery: Say 18.0' to 19.9' depth	18.0 to 20.0	242								
		18.4 to 18.5	W242.1	49.3							
		19.2 to 19.3	W242.2	34.7							
		19.6 to 19.8	L242.1	35.6	47	23					

Note: Entire sample disturbed

PROJECT: BELLE RIVER PLANT UNITS I & II

FILE NO. 1255

DATE April 1974

TABLE SUMMARY OF LABORATORY TEST RESULTS

IDENTIFICATION		TEST NO.	PROPERTIES				STRENGTH		CONSOLIDATION		OTHER TESTS AND REMARKS
BORING SAMPLE	SOIL DESCRIPTION		NAT. WATER CONTENT (%)	ATTERBERG LIMITS w _L w _P	DRY UNIT WEIGHT (PCF)	TEST TYPE	ε %	MAX SHEAR STRESS (PSF)	e _o	c _c	
126/7	Silty CLAY, dark grayish brown, soft consistency, moderately to highly plastic (CL-CH) Sample includes about 5% coarse to fine sand grains (subrounded to subangular in shape) Note: Entire sample disturbed	28.0 to 30.0									
		28.5									
		28.5 to 28.7	35.4		86						TV=0.18tsf
		29.0 to 29.3									
		29.3 to 29.5	34.9		86						
		29.5									TV=0.19tsf
		29.5 to 29.9									

PROJECT: BELLE RIVER PLANT UNITS I & II		FILE NO. 1255									
TABLE SUMMARY OF LABORATORY TEST RESULTS		DATE April 1974									
IDENTIFICATION		SHEET OF									
BORING SAMPLE	SOIL DESCRIPTION	DEPTH (FEET)	TEST NO.	PROPERTIES		STRENGTH		CONSOLIDATION		OTHER TESTS AND REMARKS	
				NAT. WATER CONTENT (%)	ATTERBERG LIMITS w _L w _P	DRY UNIT WEIGHT (PCF)	TEST TYPE	ε %	MAX. SHEAR STRESS (PSF)		e ₀
126/11	2.3' Recovery; Say 48.0' to 50.3' depth	48.0 to 50.5	245								
		48.2 to 48.5	save 245.1								
		48.5 to 48.7	W245.1	46.3		76					
	Silty CLAY, gray, firm consistency, highly plastic (CH)	48.7	TV								TV=0.35tsf
		48.7 to 49.1	save 245.2								
		49.1 to 49.4	T245.01	41.1		81	UU	4.0	498		
	Sample includes about 10% fine gravel and coarse sand size particles (subrounded to subangular in shape)	49.1 to 49.4	L245.1	41.2	59	25					
		49.4 to 49.6	W245.2	41.4		80					TV=0.40tsf
		49.6	TV								
		49.6 to 49.9	save 245.3								

PROJECT: BELLE RIVER PLANT UNITS I & II

FILE NO. 1255

DATE July 1974

TABLE SUMMARY OF LABORATORY TEST RESULTS

SHEET OF

BORING SAMPLE	IDENTIFICATION		TEST NO.	PROPERTIES			STRENGTH		CONSOLIDATION		OTHER TESTS AND REMARKS	
	SOIL DESCRIPTION	DEPTH (FEET)		NAT. WATER CONTENT (%)	ATTERBERG LIMITS w _L w _p	DRY UNIT WEIGHT (PCF)	TEST TYPE	ε %	MAX. SHEAR STRESS (PSF)	e _o		c _c
126/13	Silty CLAY, dark grey, firm consistency, moderately plastic (CL) Sample includes about 10% fine to coarse Sand grains (subrounded to subangular in shape) few layers/lenses ±1" thick of Silty CLAY, Sandy, very stiff consistency, low to moderate plasticity (CL) Sample includes about 40% fine to medium Sand grains (subrounded to subangular in shape)	58.0-60.5										
		58.2-58.5	246									
		58.5-58.7	W246.1	38.8		79						Silty Clay Portion
		58.7	TV									TV=0.32tsf
		59.0-59.3	L246.1	32.9	40	23						
		59.9-60.0	W246.2	22.1		104						Silty clay, Sandy layer
		60.0	TV									TV=0.46tsf
		60.0-60.3	Saved									

PROJECT: BELLE RIVER PLANT UNITS I & II

FILE NO. 1255

TABLE SUMMARY OF LABORATORY TEST RESULTS

DATE July 1974

IDENTIFICATION

SHEET 0F

BORING SAMPLE	SOIL DESCRIPTION	DEPTH (FEET)	TEST NO.	PROPERTIES			STRENGTH		CONSOLIDATION		OTHER TESTS AND REMARKS	
				NAT. WATER CONTENT (%)	ATTERBERG LIMITS wL wP	DRY UNIT WEIGHT (PCF)	TEST TYPE	ε %	MAX. SHEAR STRESS (PSF)	e ₀		c _c
126/15	2.4' Recovery; say 68.0' to 70.4' depth Silty CLAY, dark grey, firm to stiff consistency, moderately plastic (CL) Sample includes about 15% fine to coarse Sand and fine Gravel sized particles (sub-rounded to subangular in shape)	68.0-70.5	—									
		68.3-68.7	247									
		68.7-68.8	W247.1	99								
		68.8	TV									TV=0.50tsf
		68.8-69.3	L247.1		34	18						
		69.6-69.9	Saved									
		70.1-70.2	W247.2	100								
		70.2	TV									TV=0.47tsf

PROJECT: BELLE RIVER PLANT UNITS I & II
 TABLE SUMMARY OF LABORATORY TEST RESULTS

FILE NO. 1255
 DATE April 1974
 SHEET OF

BORING SAMPLE	IDENTIFICATION		DEPTH (FEET)	TEST NO.	PROPERTIES			STRENGTH		CONSOLIDATION		OTHER TESTS AND REMARKS
					NAT WATER CONTENT (%)	ATTERBERG LIMITS w _L w _P	DRY UNIT WEIGHT (PCF)	TEST TYPE	ε %	MAX SHEAR STRESS (PSF)	e _o	
126/23	Silty CLAY; dark gray, firm to stiff consistency, moderately plastic (CL)		108.0 to 110.0	251								
			108.1 to 108.4	save 251.1								
			108.4 to 108.6	W251.1	25.1		97					
			108.6	TV								TV=0.48tsf
	Sample includes about 20% coarse to fine sand and fine gravel sized particles (subrounded to subangular in shape)		108.6 to 108.9	1251.0.1	25.3		96		UU	20.0	1369	@15.0%strain s=1539 psf
			108.6 to 108.9	1251.1	23.6			36	20			
			109.2 to 109.4	W251.2	24.2		97					
			109.4	TV								TV=0.48 tsf
			109.4 to 109.8	save 251.3								

PROJECT: BELLE RIVER PLANT UNITS I & II

FILE NO. 1255
DATE April 1974

TABLE SUMMARY OF LABORATORY TEST RESULTS

SHEET OF

BORING SAMPLE	IDENTIFICATION		TEST NO.	PROPERTIES			STRENGTH		CONSOLI- DATION		OTHER TESTS AND REMARKS		
				NAT. WATER CONTENT (%)	ATTEBERG LIMITS		DRY UNIT WEIGHT (PCF)	TEST TYPE	ε %	MAX. SHEAR STRESS (PSF)		e _o	c _c
					w _L	w _p							
127/2	SOIL DESCRIPTION	DEPTH (FEET)	—										
	1.4' Recovery; Say 3.5' to	3.5 to											
	4.9' depth	5.5	302										
		3.6 to	save										
		4.0	302.1										
	Silty CLAY; grayish brown,	4.0 to	W302.1	24.2		99							
	stiff consistency, moderately	4.2	TV								TV=0.87tsf		
	to highly plastic	4.2	save										
	(CL-CH)	4.2 to	302.2										
		4.5											
	Sample includes about 5%	4.5 to	I302.0.1	24.9		103	UU	8.0	2099				
	coarse sand and fine gravel	4.8											
	size particles (subrounded	4.5 to	I302.1	23.1	48	24							
	to subangular in shape)	4.8											

PROJECT: BELLE RIVER PLANT UNITS I & II
 TABLE SUMMARY OF LABORATORY TEST RESULTS

FILE NO. 1255
 DATE July 1974
 SHEET OF

BORING SAMPLE	IDENTIFICATION		TEST NO.	PROPERTIES			STRENGTH		CONSOLIDATION		OTHER TESTS AND REMARKS	
	SOIL DESCRIPTION	DEPTH (FEET)		NAT. WATER CONTENT (%)	ATTERBERG LIMITS wL wP	DRY UNIT WEIGHT (PCF)	TEST TYPE	ε %	MAX. SHEAR STRESS (PSF)	e ₀		c _c
127/3	Silty CLAY, greyish brown, very stiff consistency, moderate to high plasticity (CL-CH) @ 5.2' change to - Clayey SAND, dark grey, fine to coarse Sand grains with about 40% moderately plastic fines (SC) roots and fibers evident @5.6' change to - Silty CLAY, olive grey, firm to stiff consistency, moderate to high plasticity (CL-CH) Sample includes about 15% fine to coarse Sand grains (subrounded to subangular in shape)	5.0-7.0										
		5.1	TV									TV=1.20tsf
		5.4-5.5	W416.1	29.3		77						
		5.0-5.2	MC									See plot
		5.6-7.0	416.1									TV=0.68tsf
		5.9	TV									
		6.2-6.3	W416.2	27.0		94						
		6.6	TV									TV=1.1tsf
		6.6-7.0	L416.1	25.8	49	22						
		6.6-7.0	416.1	13.5		113	rU	3.2	9403			Test at 95% of MC 416.1

FILE NO. 1255

DATE April 1974

SHEET ___ OF ___

PROJECT: BELLE RIVER PLANT UNITS I & II

TABLE SUMMARY OF LABORATORY TEST RESULTS

BORING SAMPLE	IDENTIFICATION		DEPTH (FEET)	TEST NO.	PROPERTIES			STRENGTH		CONSOLIDATION		OTHER TESTS AND REMARKS
	SOIL DESCRIPTION				NAT. WATER CONTENT (%)	ATTERBERG LIMITS w_L w_P	DRY UNIT WEIGHT (PCF)	TEST TYPE	ϵ %	MAX. SHEAR STRESS (PSF)	e_0	
127/4	1.6' Recovery; Say 8.0' to 9.6' depth		8.0 to 10.0	417								sample used for T466.1, 2, 3
			8.1 to 8.7	save 417.1								
			8.7 to 8.9	W417.1	21.9		107					sample used for T466.1, 2, 3
	Silty CLAY, olive brown mottled grayish brown, very stiff to hard consistency, moderately to highly plastic (CL-CH)		8.9 to 9.6	save 417.2								TV=2.0 tsf
			9.1	TV								
	Sample includes about 20% coarse to fine sand and fine gravel size particles (sub-rounded to subangular in shape)											

PROJECT: BELLE RIVER PLANT UNITS I & II

FILE NO. 1255

DATE July 1974

SUMMARY OF LABORATORY TEST RESULTS

SHEET OF

BORING SAMPLE	IDENTIFICATION		TEST NO.	PROPERTIES			STRENGTH		CONSOLIDATION		OTHER TESTS AND REMARKS	
	SOIL DESCRIPTION	DEPTH (FEET)		NAT. WATER CONTENT (%)	ATTERBERG LIMITS w_L w_p	DRY UNIT WEIGHT (PCF)	TEST TYPE	ϵ %	MAX. SHEAR STRESS (PSF)	e_0		C_c
127/8	2.1' Recovery; say 16.0' to 18.1' depth Silty CLAY, grey, firm consistency, moderate to high plasticity (CL-CH) Sample includes lenses/layers which contain about 20% fine to coarse Sand grains (sub-rounded to subangular in shape)	16.0-18.0										
		16.2-16.5	421									
		16.6-16.7	W421.1	28.0		91						
		16.7	TV									TV=0.77tsf
		16.7-17.0	Saved									
		17.0-17.3	Saved									
		17.3-17.4	W421.2	30.7		93						
		17.4	TV									TV=0.40tsf
		17.4-17.7	Saved									

PROJECT: BELLE RIVER PLANT UNITS I & II FILE NO. 1255
 TABLE 1 SUMMARY OF LABORATORY TEST RESULTS DATE July 1974 SHEET 1 OF 1

BORING SAMPLE	IDENTIFICATION		TEST NO.	PROPERTIES			STRENGTH		CONSOLIDATION		OTHER TESTS AND REMARKS
	SOIL DESCRIPTION	DEPTH (FEET)		NAT* WATER CONTENT (%)	ATTERBERG LIMITS wL wP	DRY UNIT WEIGHT (PCF)	TEST TYPE	ε %	MAX SHEAR STRESS (PSF)	e _o	
127/11	Jar Sample	28.5 - 30.0	456								
	Silty CLAY, grey, moderate plasticity (CL)		W456.1	22.8	*						
	Sample includes about 10% fine to coarse Sand grains (subrounded to subangular in shape)										
	*Note: Water content taken from unsealed jar sample										

PROJECT: BELLE RIVER PLANT UNITS I & II		FILE NO. 1255									
TABLE SUMMARY OF LABORATORY TEST RESULTS		DATE July 1974									
IDENTIFICATION		SHEET ____ OF ____									
BORING SAMPLE	SOIL DESCRIPTION	DEPTH (FEET)	TEST NO.	PROPERTIES			STRENGTH		CONSOLIDATION		OTHER TESTS AND REMARKS
				NAT. WATER CONTENT (%)	ATTERBERG LIMITS w _L w _p	DRY UNIT WEIGHT (PCF)	TEST TYPE	ε %	MAX. SHEAR STRESS (PSF)	e _o	
127/13	Jar Sample	38.0-40.0	457								
	Silty CLAY, grey, moderate plasticity (CL)		W457.1	21.4							
	Sample includes about 5% fine to coarse Sand grains (subrounded to subangular in shape)										
	*Note: Water content taken from unsealed jar sample										

BORING SAMPLE	IDENTIFICATION		DEPTH (FEET)	TEST NO.	PROPERTIES			STRENGTH		CONSOLIDATION		OTHER TESTS AND REMARKS
					NAT. WATER CONTENT (%)	ATTERBERG LIMITS w _L w _P	DRY UNIT WEIGHT (PCF)	TEST TYPE	ε %	MAX. SHEAR STRESS (PSF)	e _o	
127/14	Jar Sample	43.5-45.0	458									
	Silty CLAY, dark grey, moderate plasticity (CL)		L458.1		32	18						
	Sample includes < 5% fine to coarse Sand grains (subrounded to subangular in shape)											

PROJECT: BELLE RIVER PLANT UNITS I & II

FILE NO. 1255

DATE July 1974

TABLE SUMMARY OF LABORATORY TEST RESULTS

SHEET

OF

IDENTIFICATION		TEST NO.	PROPERTIES			STRENGTH		CONSOLIDATION		OTHER TESTS AND REMARKS		
BORING SAMPLE	SOIL DESCRIPTION		DEPTH (FEET)	NAT. WATER CONTENT (%)	ATTERBERG LIMITS w_L w_p	DRY UNIT WEIGHT (PCF)	TEST TYPE	ϵ %	MAX. SHEAR STRESS (PSF)		e_0	C_c
127/15	Jar Sample	—										
	Silty CLAY, dark grey, moderate plasticity (CL) Sample includes 10 to 15% fine to coarse Sand grains (subrounded to subangular in shape) *Note: Water content taken from unsealed jar sample	48.5-50.0										
			459									
			W459.1	20.6*								

PROJECT: BELLE RIVER PLANT UNITS I & II											FILE NO. 1255	
TABLE SUMMARY OF LABORATORY TEST RESULTS											DATE July 1974	
IDENTIFICATION											SHEET OF	
BORING SAMPLE	SOIL DESCRIPTION		DEPTH (FEET)	TEST NO.	PROPERTIES			STRENGTH		CONSOLIDATION		OTHER TESTS AND REMARKS
					NAT. WATER CONTENT (%)	ATTERBERG LIMITS w _L w _p	DRY UNIT WEIGHT (PCF)	TEST TYPE	MAX. SHEAR STRESS (PSF)	ε %	e ₀	
127/18	Jar Sample		63.5- 65.0	— 460								
	Silty CLAY, grey, moderate plasticity (CL)			W460.1	20.3							
	Sample includes about 10 to 15% fine to coarse sand and fine gravel size particles (sub-rounded to subangular in shape)											
	*Note: Water content taken from unsealed jar sample											

PROJECT: BELLE RIVER PLANT UNITS I & II
 TABLE SUMMARY OF LABORATORY TEST RESULTS

FILE NO. 1255
 DATE July 1974
 SHEET OF

IDENTIFICATION		TEST NO.	PROPERTIES			STRENGTH		CONSOLIDATION		OTHER TESTS AND REMARKS	
BORING SAMPLE	SOIL DESCRIPTION		DEPTH (FEET)	NAT. WATER CONTENT (%)	ATTERBERG LIMITS wL wp	DRY UNIT WEIGHT (pcf)	TEST TYPE	ε %	MAX. SHEAR STRESS (PSF)		e _o
127/19	Jar Sample	—									
	Silty CLAY, grey, moderate plasticity (CL) Sample includes about 10% fine to coarse Sand grains (subrounded to subangular in shape)	68.5-									
		70.0	461								
			L461.1		33	16					

PROJECT: BELLE RIVER PLANT UNITS I & II
 TABLE SUMMARY OF LABORATORY TEST RESULTS

BORING SAMPLE	IDENTIFICATION		TEST NO.	PROPERTIES			STRENGTH			CONSOLIDATION		OTHER TESTS AND REMARKS
	SOIL DESCRIPTION	DEPTH (FEET)		NAT. WATER CONTENT (%)	ATTERBERG LIMITS w _L w _P	DRY UNIT WEIGHT (PCF)	TEST TYPE	ε %	MAX. SHEAR STRESS (PSF)	e ₀	C _c	
127/24	Jar Sample	93.5 - 95.0	462									
	SILT, grey, non-plastic (ML)		W462.1	24.9*								
	Sample includes about 25% fine Sand grains											

*Note: Water content taken from unsealed jar sample

PROJECT: BELLE RIVER PLANT UNITS I & II

FILE NO. 1255

DATE July 1974

TABLE SUMMARY OF LABORATORY TEST RESULTS

SHEET OF

IDENTIFICATION		TEST NO.	PROPERTIES				STRENGTH		CONSOLIDATION		OTHER TESTS AND REMARKS
BORING SAMPLE	SOIL DESCRIPTION		NAT. WATER CONTENT (%)	ATTERBERG LIMITS w _L w _P	DRY UNIT WEIGHT (PCF)	TEST TYPE	ε %	MAX. SHEAR STRESS (PSF)	e ₀	c _c	
127/29	Jar Sample	—									
		463									
	Silty CLAY, dark gray, moderate plasticity (CL)	L463.1		41	21						
	Sample includes 5 to 10% fine to coarse Sand and fine Gravel size particles (subrounded to subangular in shape)										

PROJECT: BELLE RIVER PLANT UNITS I & II
 TABLE SUMMARY OF LABORATORY TEST RESULTS

FILE NO. 1255
 DATE July 1974
 SHEET OF

BORING SAMPLE	IDENTIFICATION		TEST NO.	PROPERTIES			STRENGTH		CONSOLIDATION		OTHER TESTS AND REMARKS
	SOIL DESCRIPTION	DEPTH (FEET)		NAT. WATER CONTENT (%)	ATTERBERG LIMITS w _L w _P	DRY UNIT WEIGHT (PCF)	TEST TYPE	ε %	MAX. SHEAR STRESS (PSF)	e ₀	
127/32	Jar Sample	128.5-130.0	464								
	Silty CLAY, dark gray, moderate plasticity (CL)		W464.1	30.9*							

*Note: Water content taken from unsealed jar sample.

PROJECT: BELLE RIVER PLANT UNITS I & II										FILE NO. 1255	
TABLE SUMMARY OF LABORATORY TEST RESULTS										DATE April 1974	
										SHEET ___ OF ___	
IDENTIFICATION			TEST NO.	PROPERTIES			STRENGTH		CONSOLIDATION		OTHER TESTS AND REMARKS
BORING SAMPLE	SOIL DESCRIPTION	DEPTH (FEET)		NAT. WATER CONTENT (%)	ATTERBERG LIMITS WL WP	DRY UNIT WEIGHT (PCF)	TEST TYPE	ε %	MAX. SHEAR STRESS (PSF)	e _o	
129/3	1.1' Recovery; Say 8.0' to 9.1' depth; upper 0.3' disturbed (Wash?)	8.0 to 10.5	386								
		8.3 to 8.6	save 386.1								
		8.6	TV								TV = 1.5tsf
	Silty CLAY, olive brown, very stiff consistency, moderately to highly plastic (CL-CH)	8.6 to 8.7	W386.1	22.9	108						
		8.7 to 9.0	T386.0	22.3	108	UU	6.0	3381			
		8.7 to 9.0	L386.1	22.9	48 23						

PROJECT: BELLE RIVER PLANT UNITS 1 & 2		FILE NO. 1255									
TABLE: SUMMARY OF LABORATORY TEST RESULTS		DATE: July 1974									
IDENTIFICATION		SHEET: OF									
BORING SAMPLE	SOIL DESCRIPTION	DEPTH (FEET)	TEST NO.	PROPERTIES			STRENGTH		CONSOLIDATION		OTHER TESTS AND REMARKS
				NAT. WATER CONTENT (%)	ATTERBERG LIMITS w_L w_P	DRY UNIT WEIGHT (PCF)	TEST TYPE	ϵ %	MAX. SHEAR STRESS (PSF)	e_o	
129/5	2.1' Recovery; say 18.0' to 20.1' depth	18.0-21.0	387								
		18.1-18.4	Saved								
	Silty CLAY, greyish brown, stiff consistency, moderate to highly plastic (CL-CH)	18.4-18.7	T387.1.1	33.5		90	CU	6.8	1102		$\bar{\sigma}_c=1152$ psf
		18.7-18.8	T387.1.1	30.8	48	21					
		18.7-18.8	W387.1	31.7							
		18.8	TV								TV=0.63tsf
		18.8-19.1	T387.1.4	33.1		90	CU	9.7	1276		$\bar{\sigma}_c=2304$ psf
		19.1-19.4	T387.1.3	31.9		90	CU	3.6	2087		$\bar{\sigma}_c=4608$ psf
		19.4-19.6	W387.2	33.1		89					
		19.6	TV								TV=0.53tsf
	19.6-20.0	Saved									

PROJECT: BELLE RIVER PLANT UNITS I & II
 TABLE _____ SUMMARY OF LABORATORY TEST RESULTS

FILE NO. 1255
 DATE April 1974
 SHEET _____ OF _____

BORING SAMPLE	IDENTIFICATION		TEST NO.	PROPERTIES			STRENGTH		CONSOLIDATION		OTHER TESTS AND REMARKS
				NAT. WATER CONTENT (%)	ATTERBERG LIMITS w _L w _p	DRY UNIT WEIGHT (PCF)	TEST TYPE	ε %	MAX. SHEAR STRESS (PSF)	e ₀	
129/7	SOIL DESCRIPTION	DEPTH (FEET)									
	2.0' Recovery; Say 28.0' to 30.0' depth	28.0 to 30.5	388								
		28.3 to 28.4	W388.1	35.8		88					
		28.4 to 28.6	L388.1	35.6	45	20					
	Silty CLAY, gray, moderately to highly plastic (CL-CH)										
	Note: Entire sample highly disturbed										

PROJECT: BELLE RIVER PLANT UNITS I & II
 TABLE SUMMARY OF LABORATORY TEST RESULTS

FILE NO. 1255
 DATE April 1974
 SHEET OF

BORING SAMPLE	IDENTIFICATION	DEPTH (FEET)	TEST NO.	PROPERTIES			STRENGTH		CONSOLIDATION		OTHER TESTS AND REMARKS
				NAT. WATER CONTENT (%)	ATTERBERG LIMITS w _L w _P	DRY UNIT WEIGHT (PCF)	TEST TYPE	ε %	MAX. SHEAR STRESS (PSF)	e ₀	
129/9	Silty CLAY, gray, firm consistency, moderately to highly plastic (CL)	38.0 to 40.5	389								
		38.1 to 38.4	save 389.1								
		38.4 to 38.6	W389.1	87							
		38.6	TV								TV=0.29tsf
		38.6 to 38.9	save 389.2								
		39.1 to 39.3	L389.1		41	22					
		39.1 to 39.3	C389.1						1.083	.39	
		39.1 to 39.3	SC389.1								specific gravity=2.73
		39.3 to 39.6	save 389.3								
		39.6	TV								TV=0.31tsf
		39.6 to 39.8	W389.2	88							
		39.8 to 40.0	save 389.4								

PROJECT: BELLE RIVER PLANT UNITS I & II

FILE NO. 1255

DATE July 1974

SHEET

OF

SUMMARY OF LABORATORY TEST RESULTS

BORING SAMPLE	IDENTIFICATION		TEST NO.	PROPERTIES			STRENGTH		CONSOLIDATION		OTHER TESTS AND REMARKS	
	SOIL DESCRIPTION	DEPTH (FEET)		NAT WATER CONTENT (%)	ATTERBERG LIMITS WL WP	DRY UNIT WEIGHT (PCF)	TEST TYPE	ε %	MAX. SHEAR STRESS (PSF)	e _o		c _c
129/11	1.8' Recovery; say 48.0' to 49.81' depth	48.0-50.5	390									
	Silty CLAY, grey, soft consistency, moderate to highly plastic (CL)	48.2-48.5	Saved									
		48.5	TV									
	Note: Sample much disturbed below 48.8' depth	48.5-48.6	W390.1	45.2		77					TV=0.28tsf	

PROJECT: BELLE RIVER PLANT UNITS I & II

FILE NO. 1255
DATE July 1974
SHEET OF

TABLE SUMMARY OF LABORATORY TEST RESULTS

BORING SAMPLE	IDENTIFICATION	DEPTH (FEET)	TEST NO.	PROPERTIES			STRENGTH		CONSOLIDATION		OTHER TESTS AND REMARKS	
				NAT WATER CONTENT (%)	ATTERBERG LIMITS w _L w _p	DRY UNIT WEIGHT (PCF)	TEST TYPE	ε %	MAX SHEAR STRESS (PSF)	e _o		c _c
129/13	0.6' Recovery; say 58.5' to 59.1' depth Silty CLAY, grey, soft consistency, moderate plasticity (CL) Sample includes about 15% fine to coarse Sand grains (subrounded to subangular in shape) Note: Entire sample slightly disturbed	58.5-60.5	391									
		58.6-58.7	W391.1		25.7	97						
		58.7-58.9	L391.1		31.7	35	18					
		58.9-59.1	Saved									

PROJECT: BELLE RIVER PLANT UNITS I & II		FILE NO. 1255										
TABLE SUMMARY OF LABORATORY TEST RESULTS		DATE April 1974										
IDENTIFICATION		SHEET OF										
BORING SAMPLE	SOIL DESCRIPTION	DEPTH (FEET)	TEST NO.	PROPERTIES			STRENGTH		CONSOLIDATION		OTHER TESTS AND REMARKS	
				NAT. WATER CONTENT (%)	ATTERBERG LIMITS wL wP	DRY UNIT WEIGHT (PCF)	TEST TYPE	ε %	MAX. SHEAR STRESS (PSF)	e ₀		c _c
129/15	Silty CLAY; dark gray, stiff consistency, moderately plastic (CL) Sample includes about 15% fine to coarse sand and fine gravel sized particles (subrounded to subangular in shape) Note: Upper 0.8' of sample disturbed (Wash?)	73.0 to 75.5	392									
		73.8 to 74.0	W392.1	24.6	99							
		74.0 to 74.3	L392.1	22.8	36	21						
		74.0 to 74.3	T392.01	24.8		101	UU	7.0	954			
		74.3 to 74.7	save 392.1									
		74.7 to 74.9	W392.2	23.2		102						TV=0.68tsf
		74.9	TV									
		74.9 to 75.2	save 392.2									

FILE NO. 1255
 DATE July 1 1974
 SHEET OF

PROJECT: BELLE RIVER PLANT UNITS I & II
 TABLE SUMMARY OF LABORATORY TEST RESULTS

BORING SAMPLE	IDENTIFICATION	DEPTH (FEET)	TEST NO.	PROPERTIES			STRENGTH		CONSOLIDATION		OTHER TESTS AND REMARKS
				NAT. WATER CONTENT (%)	ATTERBERG LIMITS w_L w_P	DRY UNIT WEIGHT (PCF)	TEST TYPE	ϵ %	MAX. SHEAR STRESS (PSF)	e_0	
129/19	1.8' Recovery; say 93.0' to 94.8' depth	93.0-95.5	394								
		93.1-93.4	T394.1.1	23.7		99	CU	15.0	1518		$\bar{\sigma}_c = 3240$ psf
		93.1-93.4	L394.1	23.7	41	21					
	Silty CLAY, grey, firm to stiff consistency, moderate to high plasticity (CL)	93.4	TV								TV=0.50tsf
		93.4-93.5	W394.1	25.8							
	Sample includes about 10% fine to coarse Sand and fine gravel size particles (sub-rounded to subangular in shape)	93.5-93.8	T394.1.2	25.9		99	CU	15.0	3047		$\bar{\sigma}_c = 6480$ psf
		93.8-94.1	I394.1.3	27.0		99	CU	13.2	4450		$\bar{\sigma}_c = 12960$ psf
		94.1-94.3	W394.2	26.8		98					TV=0.44tsf
		94.3	TV								
		94.3-94.6	Saved								

PROJECT: BELLE RIVER PLANT UNITS I & II

FILE NO. 1255
DATE April 1974

TABLE SUMMARY OF LABORATORY TEST RESULTS

SHEET 1 OF 1

BORING SAMPLE	IDENTIFICATION		TEST NO.	PROPERTIES			STRENGTH		CONSOLIDATION		OTHER TESTS AND REMARKS
	SOIL DESCRIPTION	DEPTH (FEET)		NAT. WATER CONTENT (%)	ATTERBERG LIMITS w _L w _P	DRY UNIT WEIGHT (PCF)	TEST TYPE	ε %	MAX. SHEAR STRESS (PSF)	e ₀	
129/21	2.2' Recovery; Say 103.0' to 105.2' depth	103.0 to 105.5	395								
		103.2 to save									
		103.5 to 395.1									
		103.5 to									
		103.7 W395.1		27.3	97						
	Silty CLAY, sandy; gray, stiff consistency, moderately plastic (CL)	103.7 TV									TV=0.68tsf
		103.7 to									
		104.0 C395.1		28.0					.703	.23	
	Sample includes about 30% fine to coarse sand and fine gravel size particles (sub-rounded to subangular in shape)	103.7 to 104.0 SC395.1									specific gravity=2.71
		103.7 to 104.0 L395.1		26.1	39 21						
		104.1 to save 395.2									
		104.4									
		104.4 to									
		104.6 W395.2		25.1	102						
		104.6 TV									TV=0.51tsf
		104.6 to save									
		104.9 395.3									

PROJECT: BELLE RIVER PLANT UNITS I & II
 TABLE SUMMARY OF LABORATORY TEST RESULTS

FILE NO. 1255
 DATE July 1974
 SHEET OF

BORING SAMPLE	IDENTIFICATION		DEPTH (FEET)	TEST NO.	PROPERTIES			STRENGTH		CONSOLIDATION		OTHER TESTS AND REMARKS
					NAT. WATER CONTENT (%)	ATTERBERG LIMITS WL WP	DRY UNIT WEIGHT (PCF)	TEST TYPE	ε %	MAX. SHEAR STRESS (PSF)	e ₀	
129/22	Jar Sample	108.5-110.0	465									
	Silty CLAY, grey, moderate plasticity (CL)		W465.1	*	26.6							
	Sample includes about 10% fine to coarse Sand grains (sub-angular to subrounded in shape)		L465.1		39	19						
	*Note: Water content taken from unsealed jar sample											

IDENTIFICATION		TEST NO.	PROPERTIES			STRENGTH		CONSOLIDATION		OTHER TESTS AND REMARKS
			NAT. WATER CONTENT (%)	ATTERBERG LIMITS w _L w _p	DRY UNIT WEIGHT (PCF)	TEST TYPE	ε %	MAX. SHEAR STRESS (PSF)	e ₀	
129/24	1.8' Recovery; Say 123.0' to 124.8' depth; upper 0.5' disturbed (Wash?)	—								
		123.0 to 125.5								
		123.5 TV								IV=0, 36tsf
		123.5 to 123.9								
	Silty CLAY, gray, stiff consistency, moderately to highly plastic (CL-CH)	123.9 to 124.1	32.4		90					
		124.1 to 124.4	30.6		95		UU	8.0	679	
		124.1 to 124.4	30.2	46	22					
	Sample includes about 10% hard subrounded gravel size particles	124.4 TV								IV=0, 34tsf

FILE NO. 1255

DATE _____

SHEET _____ OF _____

PROJECT: BELLE RIVER PLANT UNITS I & II

TABLE SUMMARY OF LABORATORY TEST RESULTS

BORING SAMPLE	IDENTIFICATION		DEPTH (FEET)	TEST NO.	PROPERTIES			STRENGTH		CONSOLIDATION		OTHER TESTS AND REMARKS
	SOIL DESCRIPTION				NAT. WATER CONTENT (%)	ATTERBERG LIMITS wL	DRY UNIT WEIGHT (PCF)	TEST TYPE	ε %	MAX. SHEAR STRESS (PSF)	e ₀	
130/SS3	Jar Sample Silty CLAY, grayish brown, highly plastic (CL-CH)		7.5'	571								
				L571.1	24.9*	49	21					
130/SS6	Jar Sample Silty CLAY, grayish brown, moderate to high plasticity (CL)		20.0'	572								
				L572.1	30.1*	44	22					
130/SS10	Jar Sample Silty CLAY, grayish brown, moderate to high plasticity (CL)		40.0'	573								
				L573.1	30.7*	44	23					
130/SS13	Jar Sample Silty CLAY, grayish brown, moderate to high plasticity (CL)		55.0'	574								
				L574.1	34.3*	46	23					

*Not: Water content taken from unsealed jar sample

PROJECT: BELLE RIVER PLANT UNITS I & II

FILE NO. 1255

DATE 12/74

SUMMARY OF LABORATORY TEST RESULTS

SHEET OF

IDENTIFICATION		TEST NO.	PROPERTIES		STRENGTH		CONSOLIDATION		OTHER TESTS AND REMARKS
BORING SAMPLE	SOIL DESCRIPTION		DEPTH (FEET)	NAT. WATER CONTENT (%)	ATTERBERG LIMITS w _L w _P	DRY UNIT WEIGHT (PCF)	TEST TYPE	ε %	
130/SS14	Jar Sample Silty CLAY, dark gray, low plasticity (CL)	60							
		575							
		1575.1	13.5	26	17				
	Sample includes ±25% fine to medium Sand size particles								
130/SS16	Jar Sample Silty CLAY, dark gray, low to moderate plasticity (CL)	70							
		576							
		1576.1	20.8	34	21				
	Sample includes about 15% fine to medium Sand size particles								

*Note: Water content taken from unsealed jar sample

FILE NO. 1255

PROJECT: BELLE RIVER PLANT UNITS I & II

DATE _____ SHEET _____ OF _____

TABLE _____ SUMMARY OF LABORATORY TEST RESULTS

IDENTIFICATION		TEST NO.	PROPERTIES			STRENGTH		CONSOLIDATION		OTHER TESTS AND REMARKS
BORING SAMPLE	SOIL DESCRIPTION		NAT. WATER CONTENT (%)	ATTERBERG LIMITS WL WP	DRY UNIT WEIGHT (PCF)	TEST TYPE	ε %	MAX. SHEAR STRESS (PSF)	e ₀	
134/SS4	Jar Sample Silty CLAY, grayish brown, highly plastic (CL-CH)	578		24						
		L578.1	24.2*	49						
134/SS9	Jar Sample Silty CLAY, grayish brown, moderate to high plasticity (CL)	579								
		L579.1	34.5*	45	22					
134/SS14	Jar Sample Silty CLAY, dark gray, highly plastic (CH) Sample includes ±5% fine Sand	580								
		L580.1	44.1*	52	33					

*Note: Water content taken from unsealed jar sample

IDENTIFICATION		TEST NO.	PROPERTIES			STRENGTH		CONSOLIDATION		OTHER TESTS AND REMARKS		
BORING SAMPLE	SOIL DESCRIPTION		DEPTH (FEET)	NAT. WATER CONTENT (%)	ATTERBERG LIMITS w_L w_p	DRY UNIT WEIGHT (PCF)	TEST TYPE	ϵ %	MAX. SHEAR STRESS (PSF)		e_o	c_c
B136/2	1.9' Recovery; say 3.0' to 4.9' depth	525										
		MC										
	Silty CLAY, mottled gray-brown and yellow-brown, very stiff consistency, high plasticity (CH) Includes about $\pm 5\%$ fine to coarse subangular to subrounded Sand grains	W525.1	36.2									
		TV										
		MC										
		W525.2	29.8			92						
		TV										
		MC										
		I525.1	62	25								

PROJECT: BELLE RIVER PLANT UNITS I & II
 TABLE SUMMARY OF LABORATORY TEST RESULTS

FILE NO. 1255
 DATE Nov. 1974
 SHEET OF

BORING SAMPLE	IDENTIFICATION		DEPTH (FEET)	TEST NO.	PROPERTIES			STRENGTH		CONSOLIDATION		OTHER TESTS AND REMARKS
					NAT. WATER CONTENT (%)	ATTERBERG LIMITS w_L w_p	DRY UNIT WEIGHT (PCF)	TEST TYPE	ϵ %	MAX. SHEAR STRESS (PSF)	e_0	
B136/4	1.8' Recovery; say 8.0' to 9.8' depth		8.0'-10.0'	526								
	Silty CLAY, mottled gray, gray-brown and yellow brown, hard consistency, moderate to high plasticity (CL-CH)		8.5'-8.8'	saved								
			8.8'-9.2'	U526.1	24.3	102	U	3.0	5446			
			8.8'-9.2'	L526.1	25.1	48	22					
			9.2'-9.3'	W526.2	25.7	98						
	Upper 0.5' of sample includes about ±15% fine to coarse Sand size particles (subrounded to subangular in shape)		9.3'	TV								TV > 2.5 tsf
			9.3'-9.6'	saved								

PROJECT: BELLE RIVER PLANT UNITS I & II

FILE NO. 1255

TABLE SUMMARY OF LABORATORY TEST RESULTS

DATE _____ SHEET _____ OF _____

IDENTIFICATION		TEST NO.	PROPERTIES			STRENGTH		CONSOLIDATION		OTHER TESTS AND REMARKS
BORING SAMPLE	SOIL DESCRIPTION		NAT. WATER CONTENT (%)	ATTERBERG LIMITS w _L w _P	DRY UNIT WEIGHT (PCF)	TEST TYPE	ε %	e _s	cc	
136/6	1.6' Recovery; say 13.0' to 14.6' depth	527 rC /rU								
	Silty CLAY, grayish-brown, stiff consistency, moderately plastic (CL)	W527.1	31.5		90					used for compacted C/U
		TV								TV = 0.62 tsf used for compacted C/U
		rC /rU								
	Sample includes 10-20% fine to coarse Sand particles	TV								TV = 0.67 tsf used for compacted C/U
		rC /rU								
		43	22							
		1527.1								
		C527.1	17.3		101			0.675	.15	
		U1527.1	17.5		100	rU	2.0			2763
		SC527.1								Specific Gravity=2.74

FILE NO. 1255

PROJECT: BELLE RIVER PLANT UNITS I & II
 TABLE SUMMARY OF LABORATORY TEST RESULTS

DATE _____ OF _____
 SHEET _____ OF _____

BORING SAMPLE	IDENTIFICATION	DEPTH (FEET)	TEST NO.	PROPERTIES			STRENGTH		CONSOLIDATION		OTHER TESTS AND REMARKS
				NAT. WATER CONTENT (%)	ATTERBERG LIMITS w _L w _P	DRY UNIT WEIGHT (PCF)	TEST TYPE	ε %	MAX SHEAR STRESS (PSF)	e ₀	
136/SS9	Jar Sample Silty CLAY, gray-brown, moderate to high plasticity. Sample includes ±10% fine to coarse Sand size particles (CL)	23.5 - 25.0'	581								
			W5811	31.1*		93*					
136/SS11	Jar Sample Silty CLAY, grayish brown, moderate to high plasticity (CL)	33.5 - 35.0'	582								
			L5821	31.9* 43	19						
136/SS15	Jar Sample Silty CLAY, gray-brown, moderate plasticity (CL)	53.5 - 55.0'	583								
			W5831	38.5*		85*					
136/SS19	Jar Sample Silty CLAY dark gray, of low to moderate plasticity. Sample includes about 25% fine to coarse Sand size particles (CL)	73.5 - 75.0'	584								
			L5841	17.0* 34	21						

* Water content taken from unsealed jar samples

PROJECT: BELLE RIVER PLANT UNITS I & II		FILE NO. 1255									
TABLE: SUMMARY OF LABORATORY TEST RESULTS		DATE: _____									
IDENTIFICATION		SHEET: _____ OF _____									
BORING SAMPLE	SOIL DESCRIPTION	DEPTH (FEET)	TEST NO.	PROPERTIES			STRENGTH		CONSOLIDATION		OTHER TESTS AND REMARKS
				NAT. WATER CONTENT (%)	ATTERBERG LIMITS w _L w _p	DRY UNIT WEIGHT (PCF)	TEST TYPE	ε %	MAX. SHEAR STRESS (PSF)	e _o	
136/SS24	Jar Sample Silty CLAY, grayish-brown, moderately plastic (CL) Sample includes ±15% fine to coarse Sand size particles	98.5- 100.0'	585		40 21						

*Note: Water content taken from unsealed jar sample

IDENTIFICATION		TEST NO.	PROPERTIES			STRENGTH		CONSOLIDATION		OTHER TESTS AND REMARKS
			NAT. WATER CONTENT (%)	ATTERBERG LIMITS w _L w _P	DRY UNIT WEIGHT (PCF)	TEST TYPE	ε %	MAX. SHEAR STRESS (PSF)	e ₀	
137/SS1	Jar Sample Silty CLAY, yellow-brown, moderately to highly plastic (CL-CH)	586								
	Sample includes ±15% fine to coarse Sand size particles	S/H								See plot
137/SS3	Jar Sample Silty CLAY, yellow-brown, highly plastic (CH)	587								
		1587.1	24.8*	53	24					

Note: Water content taken from unsealed jar sample

TABLE SUMMARY OF LABORATORY TEST RESULTS

IDENTIFICATION		TEST NO.	PROPERTIES			STRENGTH		CONSOLIDATION		OTHER TESTS AND REMARKS
BORING SAMPLE	SOIL DESCRIPTION		DEPTH (FEET)	NAT. WATER CONTENT (%)	ATTERBERG LIMITS WL WP	DRY UNIT WEIGHT (PCF)	TEST TYPE	MAX. SHEAR STRESS (PSF)	e _o	
138/SS4	Jar Sample Silty CLAY, dark gray, moderate to high plasticity. Sample includes about 10% fine to coarse Sand size particles occurring as pockets (CL-CH)	588								
138/SS9	Jar Sample Silty CLAY, light gray-brown, moderate to high plasticity (CL)	589								
		W589.1	32.0*		90					
138/SS14	Jar Sample Silty CLAY, dark gray-brown, high plasticity (CL-CH)	590								
		W590.1	31.9*							
138/SS23	Jar Sample Silty CLAY, dark gray, high plasticity (CL-CH)	591								
		W591.1	26.7*	49	25					

* Water content taken from unsealed jar sample

PROJECT: BELLE RIVER PLANT UNITS I & II										FILE NO. 1255	
TABLE SUMMARY OF LABORATORY TEST RESULTS										DATE _____ OF _____	
IDENTIFICATION		TEST NO.		PROPERTIES			STRENGTH		CONSOLIDATION		OTHER TESTS AND REMARKS
BORING SAMPLE	SOIL DESCRIPTION	DEPTH (FEET)		NAT. WATER CONTENT (%)	ATTERBERG LIMITS w _L w _p	DRY UNIT WEIGHT (PCF)	TEST TYPE	ε %	MAX. SHEAR STRESS (PSF)	e ₀	C _c
139/SS3	Jar Sample Silty CLAY, grayish brown, highly plastic (CH-CL) Sample includes ±5% fine to medium Sand size particles	6.5- 8.0'	593	23.5*	50 24						
139/SS8	Jar Sample Silty CLAY, grayish brown, moderately plastic (CL)	29.5- 31.0'	594 1594.1	25.2*	42 22						
139/SS12	Jar Sample Silty CLAY, grayish brown, moderately plastic (CL)	49.5- 51.0'	595 1595.1	31.4*	43 20						
139/SS22	Jar Sample GRAVEL, subangular to sub-rounded Gravel particles, 1/2" to 1-1/2" in size with about 15% fine to coarse Sand, less than 10% non-plastic fines (GP)	99.5- 101.0'	596 596.1								See plot

*Note: Water content taken from unsealed jar sample

FILE NO. 1255

PROJECT: BELLE RIVER PLANT UNITS I & II

DATE _____ OF _____

SHEET _____ OF _____

SUMMARY OF LABORATORY TEST RESULTS

BORING SAMPLE	IDENTIFICATION	TEST NO.	PROPERTIES			STRENGTH		CONSOLIDATION		OTHER TESTS AND REMARKS	
			NAT. WATER CONTENT (%)	ATTERBERG LIMITS WL WP	DRY UNIT WEIGHT (PCF)	TEST TYPE	MAX. SHEAR STRESS (PSF)	ε %	e ₀		C _c
B141/1	SOIL DESCRIPTION 1.9' Recovery; say 3.0' to 4.9' depth Silty CLAY, mottled gray and brown, very stiff consistency, high plasticity (CH) Includes ±5% Gravel size pieces (subrounded to sub-angular in shape) Breaks vertical and laterally in a blocky manner	—									
		3.0-5.0'	528								
		3.1-3.4'	MC								
		3.4-3.5'	W528.1	28.9		90					
		3.5'	TV								Used for processor. See plot
		3.5-4.1'	MC								
		4.1-4.2'	W528.2	25.7		88					TV=1.50 tsf Used for processor. See plot
		4.2-4.5'	MC								
		4.5'	TV								Used for processor. See plot
		4.5-4.9'	MC								
		3.0-4.9'	W528.1	56	23						TV -1.00 tsf Used for processor. See plot

FILE NO. 1255

PROJECT: BELLE RIVER PLANT UNITS I & II

TABLE SUMMARY OF LABORATORY TEST RESULTS SHEET OF

BORING SAMPLE	IDENTIFICATION		DEPTH (FEET)	TEST NO.	PROPERTIES			STRENGTH		CONSOLIDATION		OTHER TESTS AND REMARKS	
					WATER CONTENT (%)	ATTERBERG LIMITS w _L w _p	DRY UNIT WEIGHT (PCF)	TEST TYPE	ε %	MAX. SHEAR STRESS (PSF)	e ₀		c _c
141/2	Silty CLAY, mottled gray and brown, very stiff consistency, high plasticity (CH-CL) Sample includes ±20% fine to coarse Sand size particles		8.0-10.0'	529									
			8.1-8.7'	rU									Used for compacted U
			8.7'	W529.1	26.3	95							
			8.7'	TV									TV = 1.77 tsf Used for compacted U
			8.8-9.2'	rU									
			9.2'	W529.2	25.0	95							
			9.2'	TV									TV = 1.02 tsf Used for compacted U
			9.3-10.0'	rU									
			8.0-10.0'	U529.1			49	23					
			8.0-10.0'	U529.1	17.5	103			rU	2.0	5558		

SUMMARY OF LABORATORY TEST RESULTS

BORING SAMPLE	IDENTIFICATION		DEPTH (FEET)	TEST NO.	PROPERTIES			STRENGTH		CONSOLIDATION		OTHER TESTS AND REMARKS
	SOIL DESCRIPTION	NAT. WATER CONTENT (%)			ATTERBERG LIMITS w_L w_P	DRY UNIT WEIGHT (PCF)	TEST TYPE	ϵ %	MAX SHEAR STRESS (PSF)	e_0	c_c	
B141/4	1.9' Recovery, say 18.0 to 19.9' depth Silty CLAY, gray, medium consistency, moderate to high plasticity (CL) Sample includes $\pm 5\%$ fine to coarse Sand grains and fine subangular to subrounded Gravel pieces (1/4" max. size)		18.1-20.1	531								
			18.0-18.3	Saved								
			18.3-18.4	W531.1		35.3		86				
			18.4	TV								TV=0.37 tsf.
			18.4-									
			18.7	T531.1		35.5		87	CU	3.2	1393	$\bar{\sigma}_c = 2304$ psf
			18.4-18.7	L531.1		35.2	45	21				
			18.7-19.1	T531.1		36.3		86	CU	3.0	1040	$\bar{\sigma}_c = 1152$ psf
			19.1-19.2	W531.2		36.6		85				
			19.2	TV								TV=0.32 tsf
			19.2-19.5	T531.1	b	37.3		84	CU	9.6	1626	$\bar{\sigma}_c = 46.37$ psf
			19.5-19.9	T531.1	a	35.1		85	CU	4.2	1625	$\bar{\sigma}_c = 46.08$ psf

FILE NO. 1255

PROJECT: BELLE RIVER PLANT UNITS I & II

DATE _____ OF _____

SHEET _____ OF _____

TABLE _____ SUMMARY OF LABORATORY TEST RESULTS

BORING SAMPLE	IDENTIFICATION		DEPTH (FEET)	TEST NO.	PROPERTIES			STRENGTH		CONSOLIDATION		OTHER TESTS AND REMARKS
					NAT. WATER CONTENT (%)	ATTERBERG LIMITS w _L w _P	DRY UNIT WEIGHT (PCF)	TEST TYPE	ε %	MAX. SHEAR STRESS (PSF)	e ₀	
141/SS4	Jar Sample Silty CLAY, brown, moderate to high plasticity (CL)		29.5- 31.0'	597								
				L597.1	33.8*	47	21					
141/SS10	Jar Sample Silty CLAY, grayish brown, moderately plastic (CL)		59.5- 61.0'	598								
				L598.1	30.2*	41	19					
141/SS21	Jar Sample Sandy GRAVEL, hard sub-angular to subrounded Gravel size particles to 3/4" maximum about 30% fine to coarse Sand and 20% non-plastic fines (GM)		114.5- 116.0'	599								
				S599.1								See plot
141/SS27	Jar Sample Sandy CLAY, gray, low plasticity; about 45% fine to coarse Sand and fine Gravel size particles to 1/4" max. size (SM-SC)		144.5- 146.0'	600								
				S600.1								See plot

*Note: Water content taken from unsealed jar sample

SUMMARY OF LABORATORY TEST RESULTS

BORING SAMPLE	IDENTIFICATION		TEST NO.	PROPERTIES			STRENGTH		CONSOLIDATION		OTHER TESTS AND REMARKS
	SOIL DESCRIPTION	DEPTH (FEET)		NAT. WATER CONTENT (%)	ATTERBERG LIMITS w_L w_P	DRY UNIT WEIGHT (PCF)	TEST TYPE	ϵ %	MAX. SHEAR STRESS (PSF)	e_0	
B142/1	0.9' Recovery; say 3.0' to 3.9' depth	3.0-5.5'	532								
		3.0-3.4'	MC								
	Silty CLAY, mottled brown and gray, very stiff consistency high plasticity (CH)	3.4-3.5'	W532.1	28.9		98					
		3.5'	TV								Used for processor. See plot
		3.5-3.7'	MC								
		3.7-3.8'	W532.2	25.1		97					TV=1.53 tsf Used for processor. See plot
		3.8'	TV								
		3.8-3.9'	MC								TV=1.58 tsf Used for processor. See plot
		3.0-3.9'	L532.1		54	23					

PROJECT: BELLE RIVER PLANT UNITS I & II		FILE NO. 1255									
TABLE SUMMARY OF LABORATORY TEST RESULTS		DATE Nov. 1974									
IDENTIFICATION		SHEET _____ OF _____									
BORING SAMPLE	SOIL DESCRIPTION	DEPTH (FEET)	TEST NO.	PROPERTIES			STRENGTH		CONSOLIDATION		OTHER TESTS AND REMARKS
				NAT. WATER CONTENT (%)	ATTERBERG LIMITS WL WP	DRY UNIT WEIGHT (PCF)	TEST TYPE	ε %	MAX. SHEAR STRESS (PSF)	e ₀	
B142/4	0.7' Recovery; say 8.0' to 8.6' depth	8.0'-10.5'	533	22.8		106					
		8.0'-8.3'	L533.2	21.4	42	22					
		8.3'-8.4'	W533.1	24.8							
	Silty CLAY, olive brown to dark brown with layers of Sandy CLAY; very stiff consistency, moderate to high plasticity (CL)	8.4'	TV								
	at 8.3'	8.4'-8.6'	L533.1	24.5	49	22					
	<u>CHANGE TO:</u>										
	Olive-gray/brown Silty CLAY, very stiff consistency, highly plastic (CL-CH)										
	Sample includes ±10% fine to coarse Sand and Gravel size particles (subrounded to sub-angular in shape; 1/2 inch maximum size)										

PROJECT: BELLE RIVER PLANT UNITS I & II

FILE NO. 1255

DATE _____

SHEET _____ OF _____

SUMMARY OF LABORATORY TEST RESULTS

IDENTIFICATION		DEPTH (FEET)	TEST NO.	PROPERTIES			STRENGTH		CONSOLIDATION		OTHER TESTS AND REMARKS
BORING SAMPLE	SOIL DESCRIPTION			NAT. WATER CONTENT (%)	ATTERBERG LIMITS	DRY UNIT WEIGHT (PCF)	TEST TYPE	ε %	MAX. SHEAR STRESS (PSF)	e ₀	
142/5	2.1' Recovery: say 14.0' to 16.1' depth	14.0 - 16.5'	534								
		14.1 - 14.4	I CU								
		14.4'	W534.1	36.5		82					Used for compacted CU
		14.4'	TV								
		14.5' - 15.1'	I CU								TV = 0.35 tsf Used for compacted CU
		15.1'	W534.2	34.0		86					
		15.1'	TV								TV = 0.40 tsf Used for compacted CU
		15.2 - 15.6'	I CU								
		15.6'	W534.3	35.1		88					
		15.6'	TV								
		15.7 - 16.1'	I CU								TV = 0.41 tsf Used for compacted CU
		14.0 - 16.1'	L534.1		47 22						
		14.0 - 16.1'	T534.1.2	15.3		105	CU 15.0	1475			$\bar{\sigma}_c = 1872$ psf
		14.0 - 16.1'	T534.1.3	15.1		105	CU 15.0	2625			$\bar{\sigma}_c = 3600$ psf

PROJECT: BELLE RIVER PLANT UNITS I & II		FILE NO. 1255									
TABLE SUMMARY OF LABORATORY TEST RESULTS		DATE Nov. 1974									
IDENTIFICATION		SHEET OF									
BORING SAMPLE	SOIL DESCRIPTION	DEPTH (FEET)	TEST NO.	PROPERTIES			STRENGTH		CONSOLIDATION		OTHER TESTS AND REMARKS
				NAT. WATER CONTENT (%)	ATTERBERG LIMITS WL WP	DRY UNIT WEIGHT (PCF)	TEST TYPE	ε %	MAX. SHEAR STRESS (PSF)	e _o	
B142/6	2.3' Recovery; say 19.0' to 21.4' depth	19.0'- 21.5'	535								
		19.2'	TV								TV = 0.30 tsf
		19.2'- 19.5'	saved								
	Silty CLAY, gray-brown, medium consistency, moderate to high plasticity (CL)	19.5'- 19.6'	W535.1	38.5							
		19.6	TV								TV = 0.32 tsf
	Sample includes ±15% fine to coarse Sand and fine Gravel size pieces (1/2 inch maximum size)	19.6'- 19.9'	saved								
		20.1'- 20.5	C535.1	38.2					1.019	.41	Specific gravity = 2.69
		20.1'- 20.5'	SC535.1								
		20.1'- 20.5'	L535.1	37.9	45	22					
		20.5'- 20.6'	W535.2	37.7			83				
		20.6'	TV								TV = 0.36 tsf
		20.6'- 20.9'	saved								

PROJECT: BELLE RIVER PLANT UNITS I & II

FILE NO. 1255

TABLE SUMMARY OF LABORATORY TEST RESULTS

DATE _____ OF _____
SHEET _____ OF _____

IDENTIFICATION		TEST NO.	PROPERTIES			STRENGTH		CONSOLIDATION		OTHER TESTS AND REMARKS
BORING SAMPLE	SOIL DESCRIPTION		NAT. WATER CONTENT (%)	ATTERBERG LIMITS wL wP	DRY UNIT WEIGHT (PCF)	TEST TYPE	ε %	MAX. SHEAR STRESS (PSF)	ε _c %	
142SS14	Jar Sample Silty CLAY, grayish-brown, moderately plastic (CL)	601		44 20						
		1601.1	34.3*							
142SS24	Jar Sample Silty CLAY, sandy, gray, of low plasticity (CL-ML) Sample includes 25-30% fine to medium Sand size particles	602								
		1602.1	22.0*	23 16						

*Note: Water content taken from unsealed jar sample

TABLE SUMMARY OF LABORATORY TEST RESULTS

IDENTIFICATION		DEPTH (FEET)	TEST NO.	PROPERTIES			STRENGTH		CONSOLIDATION		OTHER TESTS AND REMARKS
BORING SAMPLE	SOIL DESCRIPTION			NAT. WATER CONTENT (%)	ATTERBERG LIMITS w _L w _P	DRY UNIT WEIGHT (PCF)	TEST TYPE	ε %	MAX. SHEAR STRESS (PSF)	e ₀	
143/SS2	Jar Sample Silty CLAY, yellow-brown, of moderate to high plasticity (CL)	6.0'	603	23.1*	45 20						
143/SS4	Jar Sample Silty CLAY, gray, moderately plastic (CL)	16.0'	604	26.7*	43 22						
143/SS8	Jar Sample Silty CLAY, grayish-brown, moderately plastic (CL)	36.0'	605	36.1*	46 23						
143/SS11	Jar Sample Silty CLAY, grayish-brown, of moderate plasticity (CL)	51.0'	606	31.6	43 22						

*Note: Water content taken from unsealed jar sample

PROJECT: BELLE RIVER PLANT UNITS I & II		FILE NO. 1255									
TABLE: SUMMARY OF LABORATORY TEST RESULTS		DATE _____									
IDENTIFICATION		SHEET _____ OF _____									
BORING SAMPLE	SOIL DESCRIPTION	DEPTH (FEET)	TEST NO.	PROPERTIES			STRENGTH		CONSOLIDATION		OTHER TESTS AND REMARKS
				NAT.* WATER CONTENT (%)	ATTERBERG LIMITS WL WP	DRY UNIT WEIGHT (PCF)	TEST TYPE	ε %	MAX. SHEAR STRESS (PSF)	e _o	
143/SS15	Jar Sample Silty CLAY, grayish-brown, highly plastic (CL-CH)	71.0'	607								
			L607.1	29.9*	48	21					
143/SS20	Jar Sample Silty CLAY, gray, moderately plastic (CL) Sample includes 20-25% fine to coarse Sand size particles	96.0'	608								
			L608.1	19.3*	38	20					
143/SS27	Jar Sample Sandy CLAY, gray, of low plasticity (SC) Sample includes ±35% fine to coarse Sand and ±5% fine Gravel size particles to 1/4" maximum	131.0'	609								
			L609.1	14.7*	27	17					

*Note: Water content taken from unsealed jar sample

PROJECT: BELLE RIVER PLANT UNITS I & II

FILE NO. 1255

DATE Nov. 1974

SUMMARY OF LABORATORY TEST RESULTS

SHEET 1 OF 1

IDENTIFICATION		DEPTH (FEET)	TEST NO.	PROPERTIES			STRENGTH		CONSOLIDATION		OTHER TESTS AND REMARKS
BORING SAMPLE	SOIL DESCRIPTION			NAT. WATER CONTENT (%)	ATTERBERG LIMITS w_L w_p	DRY UNIT WEIGHT (PCF)	TEST TYPE	ϵ %	MAX. SHEAR STRESS (PSF)	e_0	
B144/4	2' Recovery; say 8.0' to 10.0'	8.0-10.0'	537								
		8.2'	TV								TV = 1.80 tsf
		8.2-8.5'	saved								
	Silty CLAY, brown, hard consistency, highly plastic (CL-CH)	8.5-8.8'	U537.1	26.3		97	U	1.7	861		
		8.5-8.8'	U537.1	24.1		99	U	15.0	1482		
	Includes about 20 - 25% fine to coarse Sand and fine Gravel size pieces (sub-rounded to subangular in shape; 1/2 inch max. size)	8.5-8.8'	L537.1	27.3	48 21						
		8.8-8.9'	W537.1	28.1							
		8.9'	TV								TV = 1.70 tsf
	Entire sample slightly disturbed?	8.9-9.2'	U537.2	24.1		100	U	3.0	1002		
		9.2-9.3'	W537.2	27.1							

PROJECT: BELLE RIVER PLANT UNITS I & II

FILE NO. 1255

TABLE SUMMARY OF LABORATORY TEST RESULTS

DATE _____
SHEET _____ OF _____

IDENTIFICATION		DEPTH (FEET)	TEST NO.	PROPERTIES			STRENGTH		CONSOLIDATION		OTHER TESTS AND REMARKS
BORING SAMPLE	SOIL DESCRIPTION			NAT. WATER CONTENT (%)	ATTERBERG LIMITS w _L w _P	DRY UNIT WEIGHT (PCF)	TEST TYPE	ε %	MAX. SHEAR STRESS (PSF)	e ₀	
B144/6	1.7' Recovery; say 13.0' to 14.7' depth Silty CLAY, brown and gray- ish brown, very stiff consistency, moderate to high plasticity (CL) Sample includes 15 to 20% fine to coarse Sand size particles	13.0-	—								
		15.0'	538	25.7	99						
		13.3-	saved								
		13.7'									
		13.7-									
		13.8'	W538.1	25.7							
		13.8'	TV								TV = 1.53 tsf
		13.8-									sieve/hydro-
		14.1'	S/H538.1								meter. See plot
		14.1-									
		14.2'	W538.2	25.7							
		14.2'	TV								TV = 1.88 tsf
		14.2-									
		14.5'	saved								

PROJECT: BELLE RIVER PLANT UNITS I & II

FILE NO. 1255

DATE _____

SHEET _____ OF _____

SUMMARY OF LABORATORY TEST RESULTS

BORING SAMPLE	IDENTIFICATION		DEPTH (FEET)	TEST NO.	PROPERTIES			STRENGTH		CONSOLIDATION		OTHER TESTS AND REMARKS
					NAT. WATER CONTENT (%)	ATTERBERG LIMITS WL WP	DRY UNIT WEIGHT (PCF)	TEST TYPE	ε %	MAX. SHEAR STRESS (PSF)	e _o	
144/SS10	Jar Sample Silty CLAY, gray-brown, moderate to high plasticity. Sample includes ±5% fine to coarse sand size particles (CL)	28.5 to 30	610									
			W610.1		35.5							
144/SS16	Jar Sample Silty CLAY, gray-brown, moderate to high plasticity (CL)	58.5 to 60	611									
			W611.1		32.4							
144/SS23	Jar Sample Silty CLAY, gray, moderate plasticity (CL) Sample includes 15% fine to coarse sand size particles	93.5 to 95	612									
			I612.1		19.8	35	18					

PROJECT: BELLE RIVER PLANT UNITS I & II		FILE NO. 1255									
TABLE SUMMARY OF LABORATORY TEST RESULTS		DATE _____ SHEET _____ OF _____									
IDENTIFICATION		TEST NO.		PROPERTIES		STRENGTH		CONSOLIDATION		OTHER TESTS AND REMARKS	
BORING SAMPLE	SOIL DESCRIPTION	DEPTH (FEET)	NAT. WATER CONTENT (%)	ATTERBERG LIMITS w _L w _P	DRY UNIT WEIGHT (PCF)	TEST TYPE	ε %	MAX. SHEAR STRESS (PSF)	e ₀	c _c	
B146/3	1.8' Recovery: say 6.0' to 7.8' depth	6.0 - 8.0'									
	Silty CLAY, brown & gray mottled, very stiff to hard consistency, moderate plasticity (CL) Sample includes ±5% fine to medium Sand size particles (subangular to subrounded in shape)	6.1 - 6.4'				r CU					Used for compacted CU
		6.4 - 6.5'	36.2		84	W540.1					
		6.5'				TV					TV = 2.03 tsf
		6.5' - 6.9'				r CU					Used for compacted CU
		6.9' - 7.0'	37.8		83	W540.2					
		7.0'				TV					TV = 2.03 tsf
		7.0' - 7.3'				r CU					Used for compacted CU
		7.4' - 7.5'	37.2	44	21	W540.1					
		7.5' - 7.8'				r CU					Used for compacted CU
		6.0' - 7.8'	14.4			T540.1.2	CU	15.0	2163		
	6.0' - 7.8'	14.2			T540.1.3	CU	10.9	3173			$\bar{\sigma}_c = 3888$ psf

PROJECT: BELLE RIVER PLANT UNITS I & II

FILE NO. 1255

DATE _____

SHEET _____ OF _____

SUMMARY OF LABORATORY TEST RESULTS

BORING SAMPLE	IDENTIFICATION	DEPTH (FEET)	TEST NO.	PROPERTIES		STRENGTH		CONSOLIDATION		OTHER TESTS AND REMARKS
				NAT. WATER CONTENT (%)	ATTERBERG LIMITS ω_L ω_P	DRY UNIT WEIGHT (PCF)	TEST TYPE	ϵ %	MAX. SHEAR STRESS (PSF)	
B146/5	1.6' Recovery; say 10.0' to 11.6' depth	10.0-12.0'	541							
		10.1-10.4'	MC							Used for proc-tor. See plot
	Silty CLAY, mottled brown and gray, firm consistency, moderate plasticity (CL) includes $\pm 10\%$ fine to coarse Sand size particles	10.4'	W541.1	33.9		90				
		10.4'	TV							TV = 0.67 tsf
		10.5-11.0'	MC							Used for proc-tor. See plot
		11.0'	W541.1	27.5		92				
	@ $\pm 11.1'$ depth changes to Silty CLAY, Sandy, firm consistency, moderately plastic (CL) Includes $\pm 40\%$ fine to coarse Sand and Gravel size pieces	11.0'	TV							TV = 0.73 tsf
		11.1-11.6'	MC							Used for proc-tor. See plot
		10.0-11.6'	L541.1		38 19					

PROJECT: BELLE RIVER PLANT UNITS I & II

FILE NO. 1255

DATE _____

SHEET _____ OF _____

TABLE _____ SUMMARY OF LABORATORY TEST RESULTS

BORING SAMPLE	IDENTIFICATION		TEST NO.	PROPERTIES			STRENGTH		CONSOLIDATION		OTHER TESTS AND REMARKS	
	SOIL DESCRIPTION	DEPTH (FEET)		WATER CONTENT (%)	ATTERBERG LIMITS w _L / w _P	DRY UNIT WEIGHT (PCF)	TEST TYPE	ε %	MAX. SHEAR STRESS (PSF)	e ₀		C _c
146/7	2.1' Recovery; say 14.0' to 16.1' depth Silty CLAY, brown, firm to stiff consistency, moderate to high plasticity (CL) Sample includes ±5% fine to coarse Sand size particles	14.0-16.0'	542									
		14.1'-14.5'	rC / rU									used for compacted C/U
		14.5'	W542.1		32.2		88					
		14.5'	TV									TV = 0.48 tsf used for compacted C/U
		14.6'-15.1'	rC / rU									
		15.1'	W542.2		33.3		90					
		15.1'	TV									TV = 0.50 tsf used for compacted C/U
		15.2'-15.6'	rC / rU									
		15.6'	W542.3		34.0		85					
		15.6'	TV									TV = 0.49 tsf used for compacted C/U
		15.7'-16.1'	rC / rU									
		14.0'-16.1'	L542.1		46	22						
		14.0'-16.1'	C542.1		15.9		103			(.679)	.15	
		14.0'-16.1'	U542.1		16.6		104	rU	2.0	3282		
		14.0'-16.1'	S0542.1									Specific Gravity = 2.75

IDENTIFICATION		TEST NO.	PROPERTIES			STRENGTH		CONSOLIDATION		OTHER TESTS AND REMARKS		
			DEPTH (FEET)	NAT. WATER CONTENT (%)	ATTERBERG LIMITS w_L w_P	DRY UNIT WEIGHT (PCF)	TEST TYPE	ϵ %	MAX. SHEAR STRESS (PSF)		e_o	Cc
BORING SAMPLE	SOIL DESCRIPTION											
146/SS16	Jar Sample Silty CLAY, grayish-brown, moderately to highly plastic (CL)	614	53.5- 55.0'	28.7*	43 20							

*Note: Water content taken from unsealed jar sample

SUMMARY OF LABORATORY TEST RESULTS

SHEET _____ OF _____

IDENTIFICATION		TEST NO.	PROPERTIES				STRENGTH		CONSOLIDATION		OTHER TESTS AND REMARKS
BORING SAMPLE	SOIL DESCRIPTION		DEPTH (FEET)	NAT* WATER CONTENT (%)	ATTERBERG LIMITS WL WP	DRY UNIT WEIGHT (PCF)	TEST TYPE	ε %	MAX. SHEAR STRESS (PSF)	e _o	
147/SS3	Jar Sample Silty CLAY, yellow-brown, highly plastic (CH) Sample includes ±10% fine to coarse Sand size particles	624		58 24							
147/SS7	Jar Sample Silty CLAY, gray, of moderate to high plasticity (CL) Sample includes ±5% fine to coarse Sand size particles	616		46 23							

*Note: Water content taken from unsealed jar sample

PROJECT: BELLE RIVER PLANT UNITS I & II

FILE NO. 1255
DATE Nov. 1974
SHEET _____ OF _____

TABLE _____ SUMMARY OF LABORATORY TEST RESULTS

IDENTIFICATION		TEST NO.	PROPERTIES			STRENGTH		CONSOLIDATION		OTHER TESTS AND REMARKS
BORING SAMPLE	SOIL DESCRIPTION		NAT. WATER CONTENT (%)	ATTERBERG LIMITS WL WP	DRY UNIT WEIGHT (PCF)	TEST TYPE	MAX. SHEAR STRESS (PSF)	e ₀	C _c	
B151A/2	1.2' Recovery; say 7.5' to 8.7' depth	544								See plot
		544 S/H								
	Silty CLAY, mottled yellow-brown and gray, very stiff consistency, moderate to high plasticity	W544.1	25.0		94					TV = 1.40 tsf
		TV								
		saved								
	Sample includes 5-15% fine to coarse Sand and fine Gravel size particles (subrounded to subangular in shape- to 1/2 inch maximum size)	W544.2	24.8		98					TV = 1.40 tsf
		TV								

PROJECT: BELLE RIVER PLANT UNITS I & II

FILE NO. 1255

TABLE SUMMARY OF LABORATORY TEST RESULTS

DATE Nov. 1974

SHEET OF

IDENTIFICATION		TEST NO.	PROPERTIES			STRENGTH		CONSOLIDATION		OTHER TESTS AND REMARKS	
BORING SAMPLE	SOIL DESCRIPTION		DEPTH (FEET)	NAT. WATER CONTENT (%)	ATTERBERG LIMITS w _L w _P	DRY UNIT WEIGHT (PCF)	TEST TYPE	ε %	MAX. SHEAR STRESS (PSF)		e ₀
B151A/3	1.2' Recovery; say 12.5' to 13.7' depth	—									
		545									
		saved									
	Silty CLAY, gray, very stiff consistency, highly plastic (CL-CH)	W345.1	27.5		94						
		TV									TV = 1.13 tsf
		T									
	Sample includes 10-15% fine to coarse Sand and fine Gravel	545.0.1	28.3		95	UU	10.0	2325			σ _c - 1555 psf
	size particles (subrounded to subangular in shape-to 1/4 inch maximum size)	L545.1	27.7	48 20							
		saved									
		W345.2	31.5		93						TV = 0.55 tsf
		TV									

PROJECT: BELLE RIVER PLANT UNITS I & II

FILE NO. 1255

TABLE SUMMARY OF LABORATORY TEST RESULTS

DATE _____ OF _____

IDENTIFICATION		DEPTH (FEET)	TEST NO.	PROPERTIES			STRENGTH		CONSOLIDATION		OTHER TESTS AND REMARKS
BORING SAMPLE	SOIL DESCRIPTION			NAT* WATER CONTENT (%)	ATTERBERG LIMITS w _L w _P	DRY UNIT WEIGHT (PCF)	TEST TYPE	ε %	MAX. SHEAR STRESS (PSF)	e ₀	
154/SS3	Jar Sample Silty CLAY, yellow brown, highly plastic (CH-CL) Sample includes ±10% fine to coarse Sand size particles	6.0'- 7.5'	617								
			L617.1	23.2*	51	23					
			W617.1				100				
154/SS8	Jar Sample Silty CLAY, grayish-brown, moderately plastic (CL) Sample includes ±10% fine to coarse Sand size particles	28.5'- 30.0'	618								
			L618.1	33.3*	44	21					
154/SS13	Jar Sample Silty CLAY, grayish-brown, moderately plastic (CL) Sample includes ±5% fine to coarse Sand size particles	53.5'- 55.0'	619								
			L619.1	33.4*	40	19					
154/SS17	Jar Sample Silty CLAY, gray, highly plastic (CH)	73.5'- 75.0'	620								
			L620.1	33.1*	54	25					

Note: Water content taken from unsealed jar sample

IDENTIFICATION		TEST NO.	PROPERTIES			STRENGTH		CONSOLIDATION		OTHER TESTS AND REMARKS	
BORING SAMPLE	SOIL DESCRIPTION		DEPTH (FEET)	NAT. WATER CONTENT (%)	ATTERBERG LIMITS w _L w _P	DRY UNIT WEIGHT (PCF)	TEST TYPE	ε %	MAX. SHEAR STRESS (PSF)		e _o
154/SS19	Jar Sample Silty CLAY, Sandy, dark gray, of low to moderate plasticity (CL) Sample includes ±25% fine to coarse Sand size particles	—									
		83.5-85.0'									
154/SS22	Jar Sample Clayey SILT, gray, of low plasticity (CL-ML) Sample includes ±15% fine to medium Sand size particles	—									
		98.5-100.0'									
154/SS25	Jar Sample Silty CLAY, gray, of low plasticity, (CL) Sample includes ±10% fine Sand size particles	—									
		113.5-115.0'									

Note: Water content taken from unsealed jar sample

FILE NO. 1255

PROJECT: BELLE RIVER PLANT UNITS I & II

DATE _____ OF _____

SHEET _____ OF _____

TABLE _____ SUMMARY OF LABORATORY TEST RESULTS

BORING SAMPLE	IDENTIFICATION	DEPTH (FEET)	TEST NO.	PROPERTIES			STRENGTH		CONSOLIDATION		OTHER TESTS AND REMARKS	
				NAT. WATER CONTENT (%)	ATTERBERG LIMITS w_L w_P	DRY UNIT WEIGHT (PCF)	TEST TYPE	ϵ %	MAX. SHEAR STRESS (PSF)	e_0		C_c
158/2	2.2' Recovery; say 7.5' to 9.7' depth; upper 1.5' disturbed Silty CLAY, mottled gray-brown and grayish brown, stiff to very stiff consistency, moderately to highly plastic (CL-CH) Sample includes fine to medium Sand size particles; 30% or more near top of sample, ±10% near bottom	7.5-10.0'	548									
		7.6-8.1'	rU									used for compacted U
		8.1'	W548.1		29.0		94					
		8.2-8.5'	rU									used for compacted U
		8.5'	W548.2		28.2		95					used for compacted U
		8.6-8.9'	rU									used for compacted U
		9.0'	W548.3		24.3							
		9.0'	TV									
		9.1-9.4'	rU									used for compacted U
		9.4'	W548.4		21.6		101					
	9.4'	TV										
	9.5-9.7'	rU									used for compacted U	
	7.5-9.7'	L548.1		50	21							
	7.5-9.7'	Ur548.1		16.8		104	rU	2.0	347			

PROJECT: BELLE RIVER PLANT UNITS I & II

FILE NO. 1255

TABLE SUMMARY OF LABORATORY TEST RESULTS

DATE 11/74

SHEET OF

IDENTIFICATION		TEST NO.	PROPERTIES			STRENGTH		CONSOLIDATION		OTHER TESTS AND REMARKS	
BORING SAMPLE	SOIL DESCRIPTION		DEPTH (FEET)	NAT. WATER CONTENT (%)	ATTERBERG LIMITS w _L w _p	DRY UNIT WEIGHT (PCF)	TEST TYPE	ε %	e ₀		c _c
B158/4	Silty CLAY, gray, firm consistency, moderate to high plasticity (CL) Sample includes 5-10% fine to coarse Sand size particles	17.5-20.0'									
		17.5-17.8'	saved								
		17.9'	W550.1	36.2		84					
		17.9'	TV								TV = 0.34 tsf
		18.0-18.5'	saved								
		18.5'	W550.2	37.8		83					
		18.5'	TV								TV = 0.37 tsf
		18.6-18.9'	W550.1.1	37.5		83	CU	3.2	885		σ _c = 1080 psf
		18.6-18.9'	W550.1		46 19						
		19.0-19.3'	W550.1.2	33.5		87	CU	5.1	971		σ _c = 2160 psf
		19.3-19.6'	W550.1.3	37.1		83	CU	5.7	1297		σ _c = 4320 psf
		19.8	W550.3	37.2							

PROJECT: BELLE RIVER PLANT UNITS I & II												FILE NO. 1255					
TABLE SUMMARY OF LABORATORY TEST RESULTS												DATE		SHEET		OF	
IDENTIFICATION		TEST NO.	PROPERTIES		STRENGTH		CONSOLIDATION		OTHER TESTS AND REMARKS								
BORING SAMPLE	SOIL DESCRIPTION	DEPTH (FEET)	NAT. WATER CONTENT (%)	ATTERBERG LIMITS w _L w _P	DRY UNIT WEIGHT (PCF)	TEST TYPE	ε %	MAX. SHEAR STRESS (PSF)	e ₀	c _c							
163/SS2	Jar Sample Silty CLAY, yellow-brown, highly plastic (CH-CL) Sample includes ±5% fine to coarse Sand size particles	3.5-5.0' L615.1		51 24													
163/SS4	Jar Sample Silty CLAY, grayish-brown, moderately to highly plastic (CL)	8.5-10.0' L625.1	28.4*	47 23													
163/SS8	Jar Sample Silty CLAY, grayish-brown, moderately plastic (CL)	28.5-30.0' L626.1	23.9*	42 20													
163/SS11	Jar Sample Silty CLAY, grayish-brown, moderately plastic (CL) Sample includes ±5% fine to medium Sand size particles	43.5-45.0' L627.1	33.5	45 21													

*Note: Water content taken from unsealed jar sample

FILE NO. 1255

PROJECT: BELLE RIVER PLANT UNITS I & II

DATE _____ SHEET _____ OF _____

SUMMARY OF LABORATORY TEST RESULTS

BORING SAMPLE	IDENTIFICATION	DEPTH (FEET)	TEST NO.	PROPERTIES			STRENGTH		CONSOLIDATION		OTHER TESTS AND REMARKS
				NAT.* WATER CONTENT (%)	ATTERBERG LIMITS wL wp	DRY UNIT WEIGHT (PCF)	TEST TYPE	ε %	MAX. SHEAR STRESS (PSF)	e _o	
163/SS16	<p>Jar Sample Silty CLAY, grayish-brown, highly plastic (CH)</p>	68.5- 70.0'	— 628								
			L628.1	36.9*	52 24						
163/SS21	<p>Jar Sample Silty CLAY, gray, moderately plastic (CL)</p> <p>Sample includes ±10% fine to coarse Sand size particles</p>	93.5- 95.0'	629								
			L629.1	22.3*	39 20						

*Note: Water content taken from unsealed jar sample

PROJECT: BELLE RIVER PLANT UNITS I & II		FILE NO. 1255										
TABLE SUMMARY OF LABORATORY TEST RESULTS		DATE Nov. 1974										
IDENTIFICATION		SHEET OF										
BORING SAMPLE	SOIL DESCRIPTION	DEPTH (FEET)	TEST NO.	PROPERTIES			STRENGTH			CONSOLIDATION		OTHER TESTS AND REMARKS
				NAT. WATER CONTENT (%)	ATTERBERG LIMITS WL WP	DRY UNIT WEIGHT (PCF)	TEST TYPE	ε %	MAX. SHEAR STRESS (PSF)	e ₀	c _c	
B185/3	2.7' Recovery; say 6.0' to 8.7' depth	6.0' 9.0'	552									
		6.5'- 6.8'	saved									
		6.8'	W552.1	25.2		99						
		6.9'- 7.2'	saved									
		7.5'- 7.8'	U552.1	23.9		104	4.0	2948				
		7.5'- 7.8'	I552.1	24.7	50	23						
		7.8'	W552.2	26.9		99						
		7.8'	TV									TV = 1.75 tsf
		7.9'- 8.1'	C552.1	29.1						.757	0.18	
		7.9'- 8.1'	SG552.1									Specific Gravity = 2.72
		8.2'- 8.5'	saved									

PROJECT: BELLE RIVER PLANT UNITS I & II

FILE NO. 1255

TABLE SUMMARY OF LABORATORY TEST RESULTS

DATE _____ OF _____
SHEET _____ OF _____

IDENTIFICATION		TEST NO.	PROPERTIES			STRENGTH		CONSOLIDATION		OTHER TESTS AND REMARKS	
			NAT. WATER CONTENT (%)	ATTERBERG LIMITS w _L w _P	DRY UNIT WEIGHT (PCF)	TEST TYPE	ε %	e _o	cc		
BORING SAMPLE	SOIL DESCRIPTION	DEPTH (FEET)									
B185/7	2.7' Recovery; say 18.0' to 20.7' depth Silty CLAY, gray, medium consistency, highly plastic (CL-CH) Sample includes less than 5% fine Sand size particles	18.0-21.0'									
		18.2-18.5'	554								
		18.5-18.8'	saved								
		18.8-18.5'	U554.1	39.3		81	U	2.4	416		
		18.8'	L554.1	39.0	49 22						
		18.9'	W554.1	38.8		81					TV = 0.35 tsf
		18.9'	TV								
		19.2-19.8'	saved								
		19.9'	W554.2	35.4		82					
		19.9'	TV								TV = 0.32 tsf

FILE NO. 1255

DATE _____ OF _____

SHEET _____ OF _____

PROJECT: BELLE RIVER PLANT UNITS I & II
 TABLE _____ SUMMARY OF LABORATORY TEST RESULTS

IDENTIFICATION

BORING SAMPLE	SOIL DESCRIPTION	DEPTH (FEET)	TEST NO.	PROPERTIES			STRENGTH		CONSOLIDATION		OTHER TESTS AND REMARKS	
				NAT. WATER CONTENT (%)	ATTERBERG LIMITS WL PL	DRY UNIT WEIGHT (PCF)	TEST TYPE	MAX. SHEAR STRESS (PSF)	e_o	c_c		
B185/13	2.8' Recovery; say 48.0' to 50.8' depth Silty CLAY, gray, medium consistency, moderate to high plasticity (CL) Sample includes varying amounts of fine to medium Sand, $\pm 10\%$ at top of sample to $\pm 40\%$ near bottom; less than 5% subangular to subrounded Gravel particles to 1/4" size occur throughout	48.0-51.0'	556									
		48.2-48.5'	saved									
		48.5'	W556.1	85								TV = 0.44 tsf
		48.5'	TV									
		48.6-48.9'	L556.1		37.1	47	22					
		49.4'	W556.2	87	31.5							
		49.5-49.9'	L556.2		25.9	28	17					

PROJECT: BELLE RIVER PLANT UNITS I & II

TABLE: SUMMARY OF LABORATORY TEST RESULTS

FILE NO. 1255

DATE July 1974

SHEET OF

BORING SAMPLE	IDENTIFICATION		TEST NO.	PROPERTIES			STRENGTH		CONSOLIDATION		OTHER TESTS AND REMARKS
	SOIL DESCRIPTION	DEPTH (FEET)		NAT. WATER CONTENT (%)	ATTERBERG LIMITS w _L w _P	DRY UNIT WEIGHT (PCF)	TEST TYPE	ε %	MAX SHEAR STRESS (PSF)	e ₀	
186/3	Jar Sample Silty CLAY, dark greyish brown, high plasticity (CH-CL)	6.0 7.5	443								
			L443.1	52	18						
			W443.1	21.5*		99					

*Note: Water content taken from unsealed jar sample

PROJECT: BELLE RIVER PLANT UNITS I & II		FILE NO. 1255											
TABLE: SUMMARY OF LABORATORY TEST RESULTS		DATE July 1974											
		SHEET _____ OF _____											
IDENTIFICATION		TEST NO.		PROPERTIES		STRENGTH		CONSOLIDATION		OTHER TESTS AND REMARKS			
BORING SAMPLE	SOIL DESCRIPTION	DEPTH (FEET)	NAT. WATER CONTENT (%)	ATTERBERG LIMITS wL	WP	DRY UNIT WEIGHT (PCF)	TEST TYPE	ε %	MAX. SHEAR STRESS (PSF)	e _o	cc _o		
186/7	0.8' Recovery; say 23.0' to 23.8' depth	23.0 - 25.0											
	Silty CLAY, grey, soft consistency, moderate to high plasticity (CL) Note: Entire sample much disturbed	23.0 - 23.3	40.5	42	21								
		23.3 - 23.5	39.0		80								
		23.5 - 23.8											

PROJECT: BELLE RIVER PLANT UNITS I & II

FILE NO. 1255

DATE July 1974

SUMMARY OF LABORATORY TEST RESULTS

SHEET OF

BORING SAMPLE	IDENTIFICATION		TEST NO.	PROPERTIES			STRENGTH		CONSOLIDATION		OTHER TESTS AND REMARKS	
	SOIL DESCRIPTION	DEPTH (FEET)		NAT. WATER CONTENT (%)	ATTERBERG LIMITS WL Wp	DRY UNIT WEIGHT (PCF)	TEST TYPE	ε %	MAX. SHEAR STRESS (PSF)	e _o		C _c
186/13	1.5' Recovery; say 53.0' to 54.5' depth Silty CLAY, grey, soft to firm consistency, moderate plasticity (CL) below 53.8' depth, sample includes about 20% fine to coarse Sand and fine gravel size particles (subrounded to subangular in shape)	53.0-55.0	426									
		53.2-53.5	Saved									
		53.5-53.6	W426.1	80								
		53.6	TV									TV = 0.28tsf
		53.6-54.0	Saved									
		54.0-54.3	L426.1	17								
		54.3-54.4	W426.2	92								
		54.4	TV									TV = 0.21tsf

PROJECT: BELLE RIVER PLANT UNITS I & II										FILE NO. 1255	
TABLE SUMMARY OF LABORATORY TEST RESULTS										DATE July 1974	
IDENTIFICATION										SHEET OF	
BORING SAMPLE	SOIL DESCRIPTION	DEPTH (FEET)	TEST NO.	PROPERTIES			STRENGTH		CONSOLIDATION		OTHER TESTS AND REMARKS
				NAT. WATER CONTENT (%)	ATTERBERG LIMITS	DRY UNIT WEIGHT (PCF)	TEST TYPE	ε %	MAX. SHEAR STRESS (PSF)	e ₀	
				ω _L	ω _P						
186/20	Jar Sample	88.5-90.0	444								
	Silty CLAY, grey, moderate plasticity (CL)		W444.1	20.2*		107					
			L444.1		32	17					
	Sample includes about 20% fine to coarse Sand grains (subrounded to subangular in shape)										
	*Note: Water content taken from unsealed jar sample										

PROJECT: BELLE RIVER PLANT UNITS I & II

FILE NO. 1255

TABLE SUMMARY OF LABORATORY TEST RESULTS

DATE July 1974
SHEET OF

BORING SAMPLE	IDENTIFICATION	DEPTH (FEET)	TEST NO.	PROPERTIES			STRENGTH		CONSOLIDATION		OTHER TESTS AND REMARKS
				NAT. WATER CONTENT (%)	ATTENBERG LIMITS w_L w_P	DRY UNIT WEIGHT (PCF)	TEST TYPE	ϵ %	MAX. SHEAR STRESS (PSF)	e_0	
186/23	Jar Sample	103.5 105.0	— 445								
	SILT, grey, non-plastic (ML)		W445.1	12.0*							
	Sample includes about 20% fine Sand grains		L445.1		18	18					

*Note: Water content taken from unsealed jar sample

IDENTIFICATION		DEPTH (FEET)	TEST NO.	PROPERTIES			STRENGTH		CONSOLIDATION		OTHER TESTS AND REMARKS
				NAT. WATER CONTENT (%)	ATTERBERG LIMITS w_L w_P	DRY UNIT WEIGHT (PCF)	TEST TYPE	ϵ %	MAX. SHEAR STRESS (PSF)	e_0	
BORING SAMPLE	SOIL DESCRIPTION										
187/6	Jar Sample Silty CLAY, dark grayish brown, moderate to high plasticity (CL-CH) *Note: Water content taken from unsealed jar sample	18.5- 20.0	446								
			W446.1	35.9*							

PROJECT: BELLE RIVER PLANT UNITS I & II
 TABLE: SUMMARY OF LABORATORY TEST RESULTS
 FILE NO. 1255
 DATE July 1974
 SHEET ___ OF ___

BORING SAMPLE	IDENTIFICATION		DEPTH (FEET)	TEST NO.	PROPERTIES			STRENGTH		CONSOLIDATION		OTHER TESTS AND REMARKS
					NAT. WATER CONTENT (%)	ATTERBERG LIMITS ω_L ω_P	DRY UNIT WEIGHT (PCF)	TEST TYPE	ϵ %	MAX. SHEAR STRESS (PSF)	e_0	
187/7	Jar Sample	23.5 - 25.0	447									
	Silty CLAY, gray, moderate to high plasticity (CL-CH)		L447.1		37.9*	47	20					
	*Note: Water content taken from unsealed jar sample											

PROJECT: BELLE RIVER PLANT UNITS I & II

FILE NO. 1255

DATE July 1974

TABLE SUMMARY OF LABORATORY TEST RESULTS

SHEET OF

IDENTIFICATION		DEPTH (FEET)	TEST NO.	PROPERTIES			STRENGTH		CONSOLIDATION		OTHER TESTS AND REMARKS
BORING SAMPLE	SOIL DESCRIPTION			NAT. WATER CONTENT (%)	ATTERBERG LIMITS WL WP	DRY UNIT WEIGHT (PCF)	TEST TYPE	ε %	MAX. SHEAR STRESS (PSF)	e _o	
187/13	Jar Sample	53.5 - 55.0	448								
	Silty CLAY, grey, moderate to high plasticity (CL)		W448.1	39.5*							
	*Note: Water content taken from unsealed jar sample										

PROJECT: BELLE RIVER PLANT UNITS I & II

FILE NO. 1255

DATE July 1974

SUMMARY OF LABORATORY TEST RESULTS

SHEET _____ OF _____

IDENTIFICATION		TEST NO.	PROPERTIES				STRENGTH		CONSOLIDATION		OTHER TESTS AND REMARKS
BORING SAMPLE	SOIL DESCRIPTION		DEPTH (FEET)	NAT. WATER CONTENT (%)	ATTERBERG LIMITS w _L w _p	DRY UNIT WEIGHT (PCF)	TEST TYPE	ε %	MAX. SHEAR STRESS (PSF)	e ₀	
187/14	Jar Sample	—									
	Clayey SILT, Sandy, gray, low to moderate plasticity (CL-ML) Sample includes about 45% fine to coarse Sand and fine Gravel size particles (subrounded to subangular in shape)	58.5-									
		60.0	449								
			S/H 449.1								See plot

PROJECT: BELLE RIVER PLANT UNITS I & II
 TABLE SUMMARY OF LABORATORY TEST RESULTS

FILE NO. 1255
 DATE July 1974
 SHEET OF

BORING SAMPLE	IDENTIFICATION	DEPTH (FEET)	TEST NO.	PROPERTIES			STRENGTH		CONSOLIDATION		OTHER TESTS AND REMARKS
				NAT* WATER CONTENT (%)	ATTERBERG LIMITS WL WP	DRY UNIT WEIGHT (PCF)	TEST TYPE	ε %	MAX SHEAR STRESS (PSF)	e _o	
187/17	Jar Sample	73.5-75.0	450								
	Silty CLAY, dark grey, moderate plasticity (CL)		W450.1	25.6							
	Sample includes about 10% fine to coarse Sand grains (subrounded to subangular in shape)										
	*Note: Water content taken from unsealed jar sample										

IDENTIFICATION		TEST NO.	PROPERTIES		STRENGTH		CONSOLIDATION		OTHER TESTS AND REMARKS	
BORING SAMPLE	SOIL DESCRIPTION		DEPTH (FEET)	NAT. WATER CONTENT (%)	ATTERBERG LIMITS wL wP	DRY UNIT WEIGHT (PCF)	TEST TYPE	€ %		MAX. SHEAR STRESS (PSF)
187/22	Jar Sample	98.5 - 100.0	24.1							
	Silty CLAY, dark grey, moderate plasticity (CL)									
	Sample includes about 10% fine to coarse Sand grains (subrounded to subangular in shape)									
	*Note: Water content taken from unsealed jar sample									

PROJECT: BELLE RIVER PLANT UNITS I & II
 TABLE SUMMARY OF LABORATORY TEST RESULTS

FILE NO. 1255
 DATE July 1974
 SHEET OF

BORING SAMPLE	IDENTIFICATION		DEPTH (FEET)	TEST NO.	PROPERTIES				STRENGTH		CONSOLIDATION		OTHER TESTS AND REMARKS
					NAT* WATER CONTENT (%)	ATTERBERG LIMITS w_L	ATTERBERG LIMITS w_p	DRY UNIT WEIGHT (PCF)	TEST TYPE	ϵ %	MAX. SHEAR STRESS (PSF)	e_o	
187/23	Jar Sample		103.5	—									
	Silty CLAY, gray, moderate plasticity (CL) Sample includes about 10% fine to coarse Sand grains (subrounded to subangular in shape)		105.0	1452.1	28.8	34	19						

*Note: Water content taken from unsealed jar sample

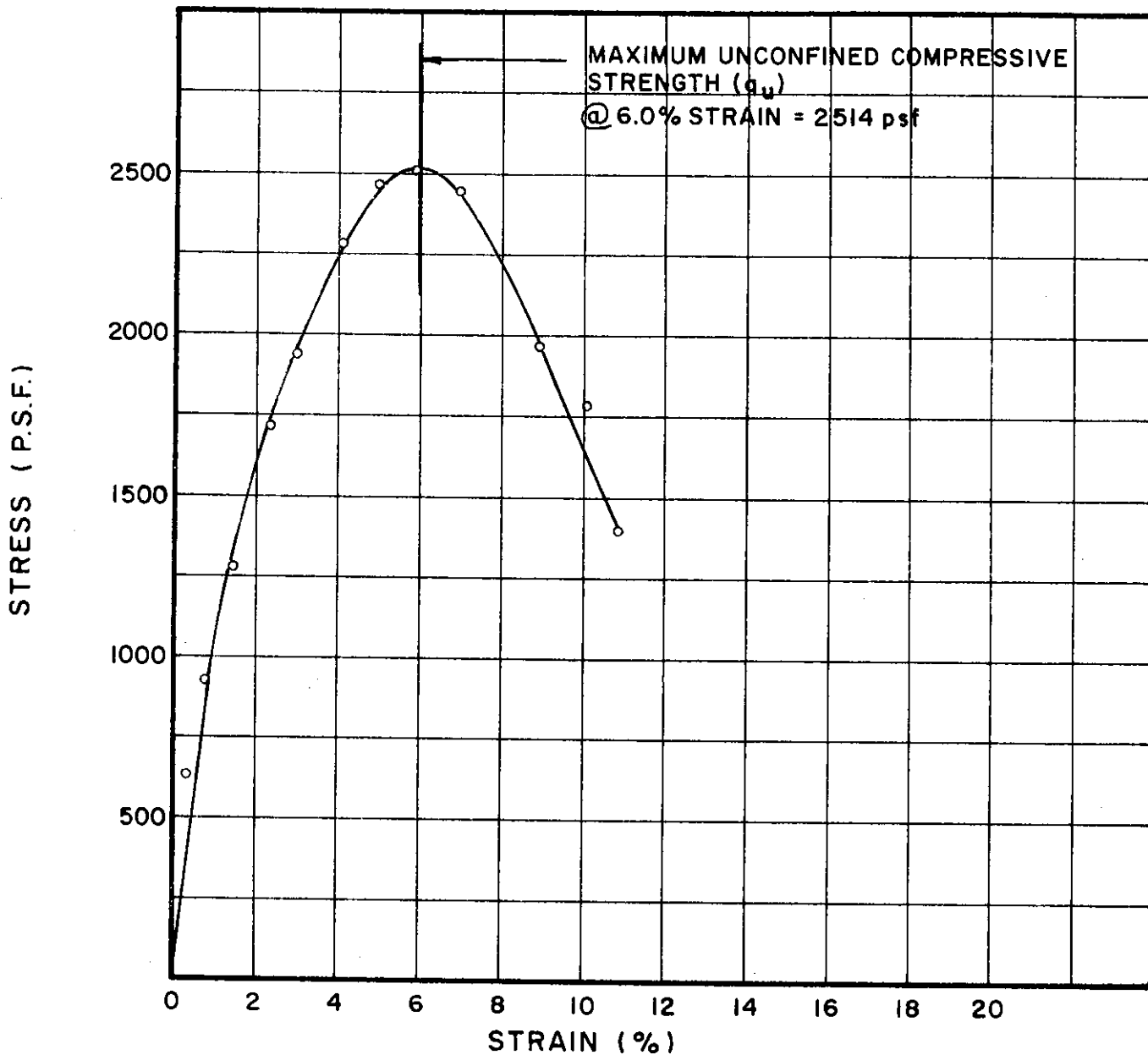

TEST NO.	TEST DATA			SOIL PROPERTIES				
	DIAMETER (INCHES)	HEIGHT (INCHES)	STRAIN RATE (%/MIN)	WATER CONTENT (%)	DRY UNIT WEIGHT (pcf)	ATTERBERG LL (%)	LIMITS PL (%)	SOIL DESCRIPTION
UI20.2	1.40	3.50	0.26	31.6	93	44	19	SILTY CLAY (CL)

BORING NO. 15
 SAMPLE NO. 4
 DEPTH 8.6' TO 8.9'

UNCONFINED COMPRESSION TESTS

THE DETROIT EDISON COMPANY
 BELLE RIVER PLANT UNITS I & II

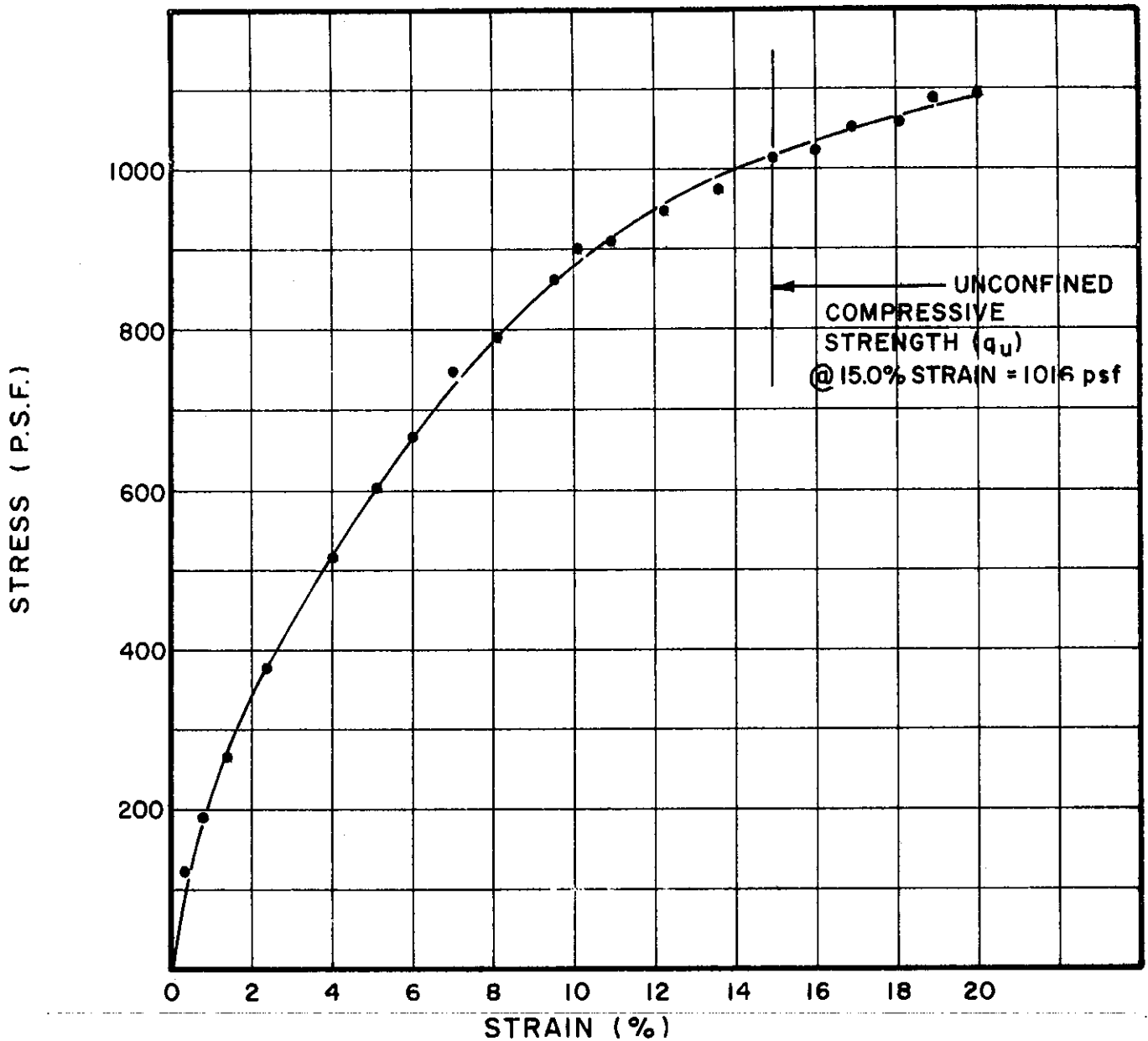

TEST NO.	TEST DATA			WATER CONTENT (%)	DRY UNIT WEIGHT (pcf)	SOIL PROPERTIES		SOIL DESCRIPTION
	DIAMETER (INCHES)	HEIGHT (INCHES)	STRAIN RATE (%/MIN)			ATTERBERG LL (%)	LIMITS PL (%)	
UI21.1	1.40	3.50	0.26	34.1	87	42	20	SILTY CLAY (CL)

BORING NO. 15
 SAMPLE NO. 6
 DEPTH 18.1' TO 18.4'

UNCONFINED COMPRESSION TESTS

THE DETROIT EDISON COMPANY
 BELLE RIVER PLANT UNITS I & II

FILE 1255

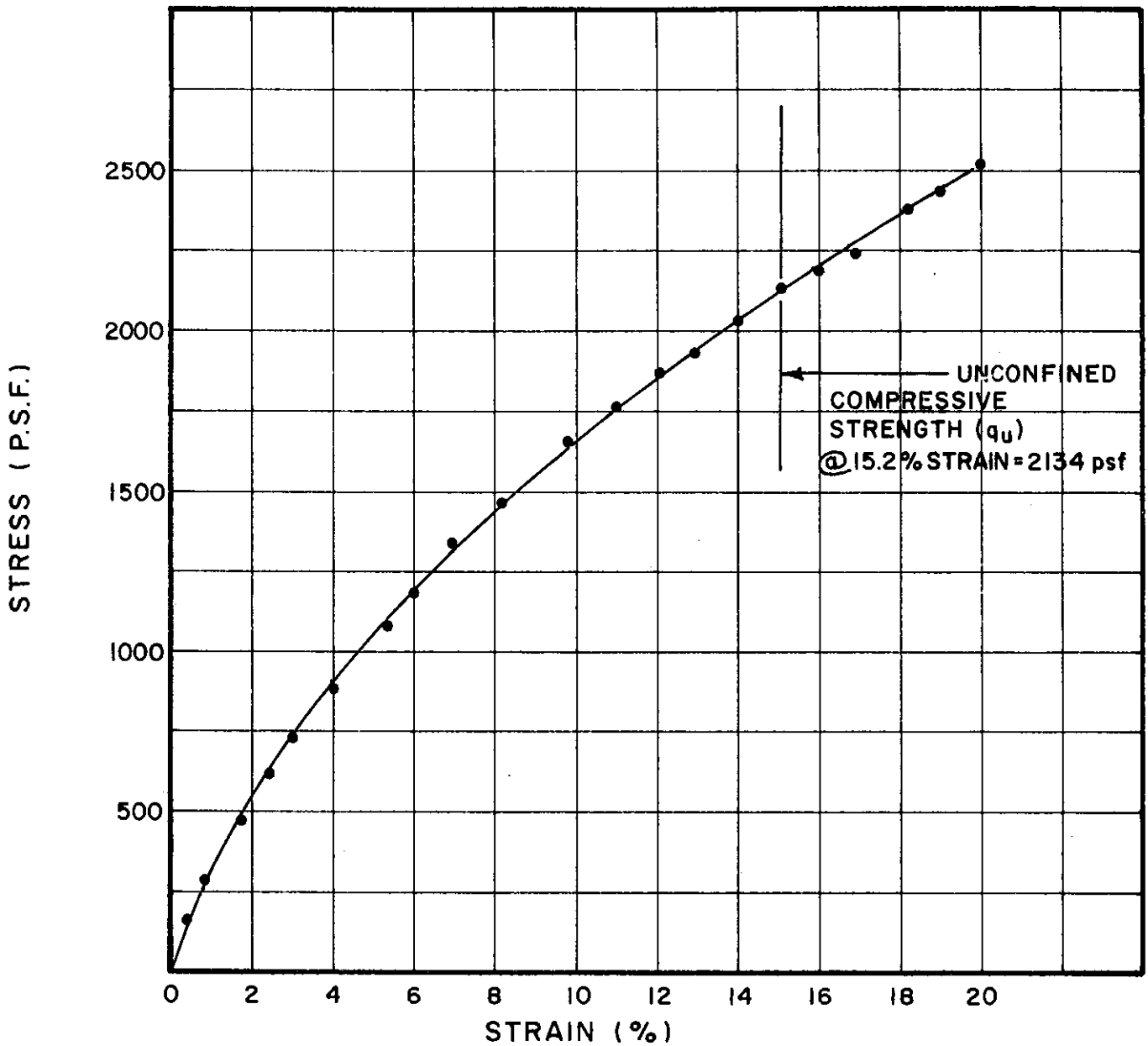

TEST NO.	TEST DATA			WATER CONTENT (%)	DRY UNIT WEIGHT (pcf)	SOIL PROPERTIES		SOIL DESCRIPTION
	DIAMETER (INCHES)	HEIGHT (INCHES)	STRAIN RATE (%/MIN)			ATTERBERG LL (%)	LIMITS PL (%)	
UI25.1	1.40	3.50	0.26	22.5	104	34	18	SILTY CLAY (CL)

BORING NO. 15
 SAMPLE NO. 14
 DEPTH 59.2' TO 59.6'

UNCONFINED COMPRESSION TESTS

THE DETROIT EDISON COMPANY
 BELLE RIVER PLANT UNITS I & II

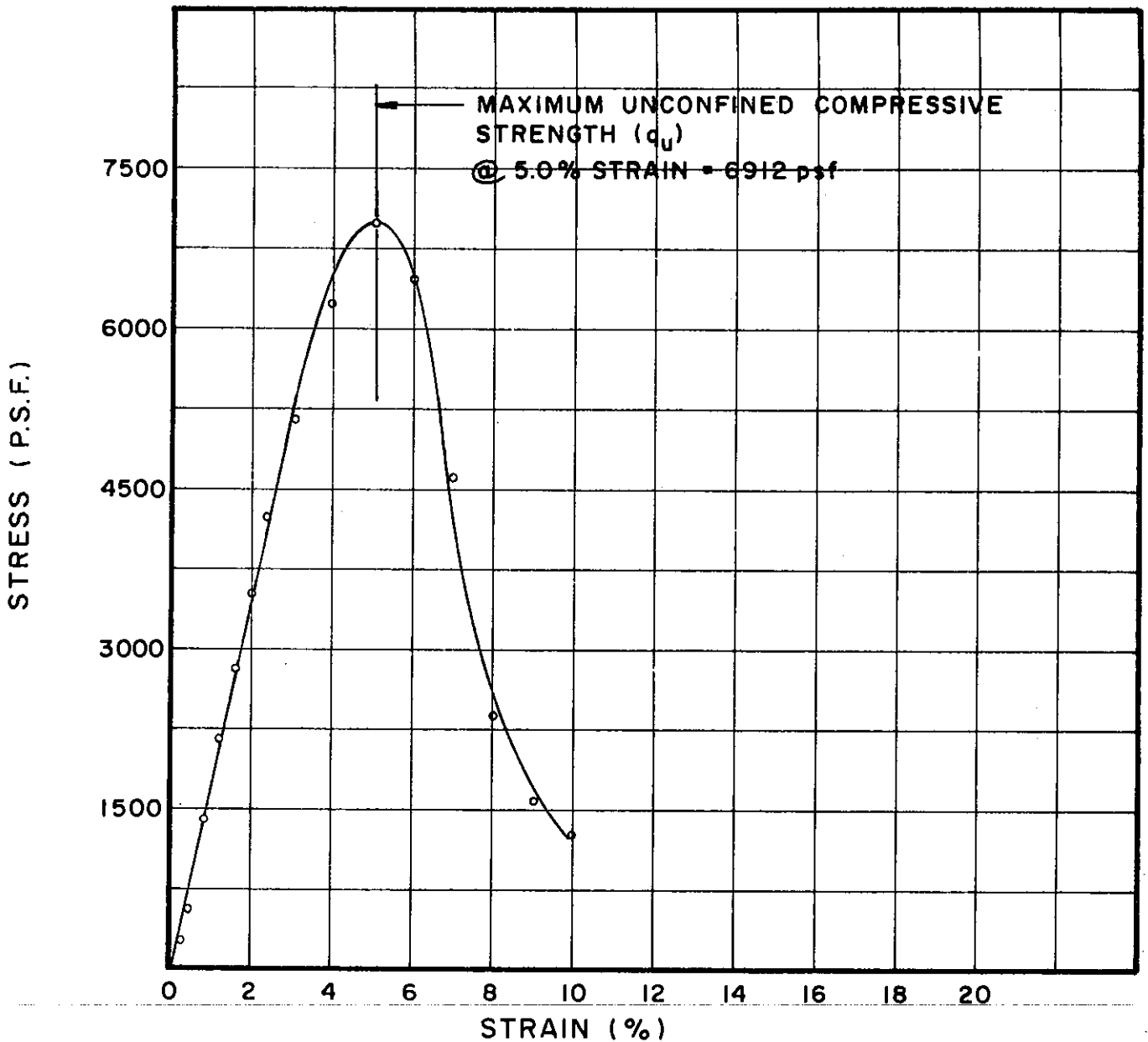

TEST NO.	TEST DATA			SOIL PROPERTIES				
	DIAMETER (INCHES)	HEIGHT (INCHES)	STRAIN RATE (%/MIN)	WATER CONTENT (%)	UNIT WEIGHT (pcf)	ATTERBERG LL (%)	LIMITS PL (%)	SOIL DESCRIPTION
U266.1	1.44	3.46	.260	22.4	108	59	23	SILTY CLAY (CH)

BORING NO. 25

SAMPLE NO. 1

DEPTH 4.5' TO 4.8'

UNCONFINED COMPRESSION TESTS

THE DETROIT EDISON COMPANY
BELLE RIVER PLANT UNITS I & II

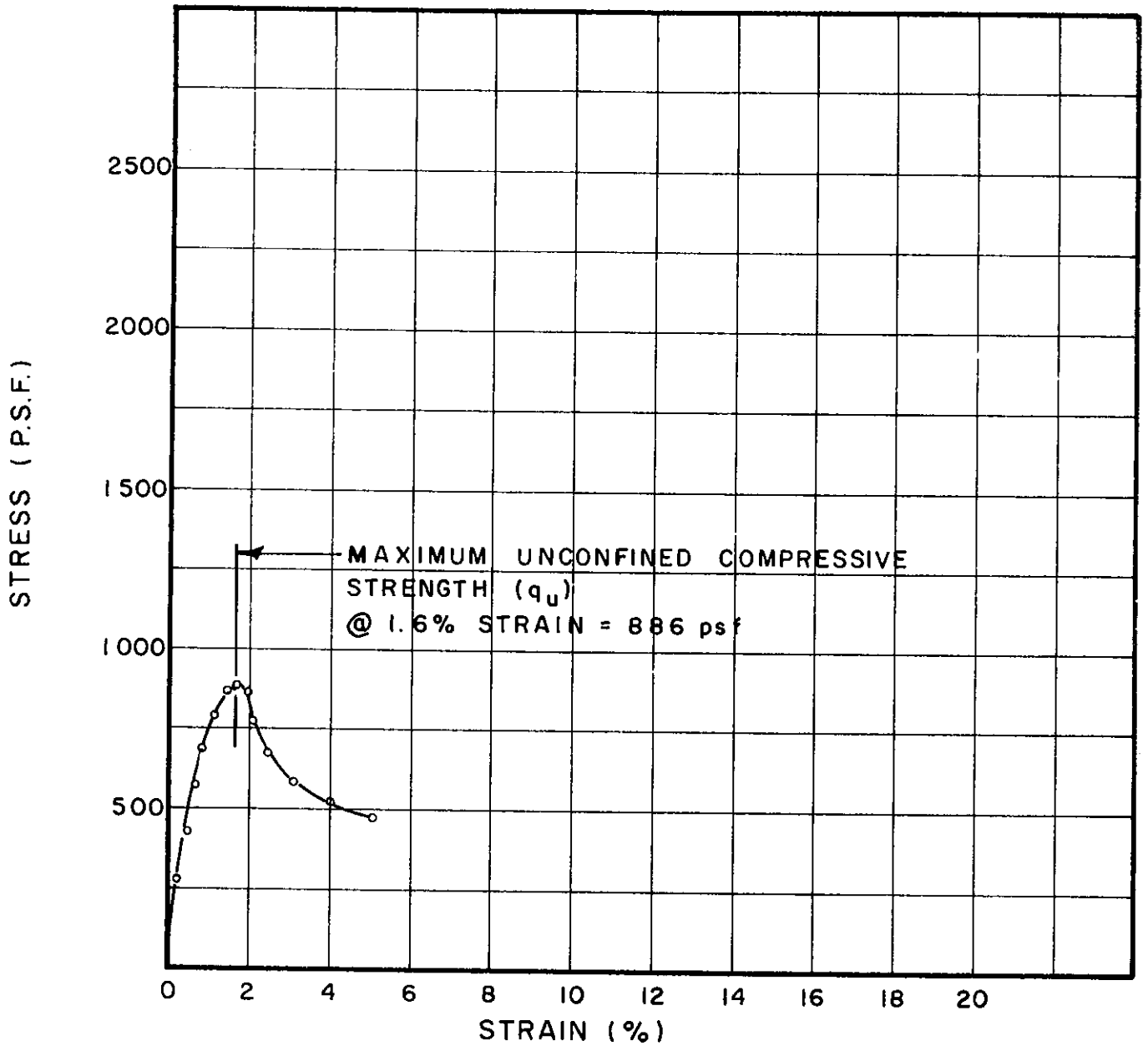

TEST NO.	TEST DATA			SOIL PROPERTIES				
	DIAMETER (INCHES)	HEIGHT (INCHES)	STRAIN RATE (%/MIN)	WATER CONTENT (%)	UNIT WEIGHT (pcf)	ATTERBERG LL (%)	LIMITS PL (%)	SOIL DESCRIPTION
U5.1	1.41	3.50	.257	36.6	86	38	20	SILTY CLAY (CL)

BORING NO. 26
 SAMPLE NO. 9
 DEPTH 39.4' TO 39.7'

UNCONFINED COMPRESSION TESTS

THE DETROIT EDISON COMPANY
 BELLE RIVER PLANT UNITS I & II

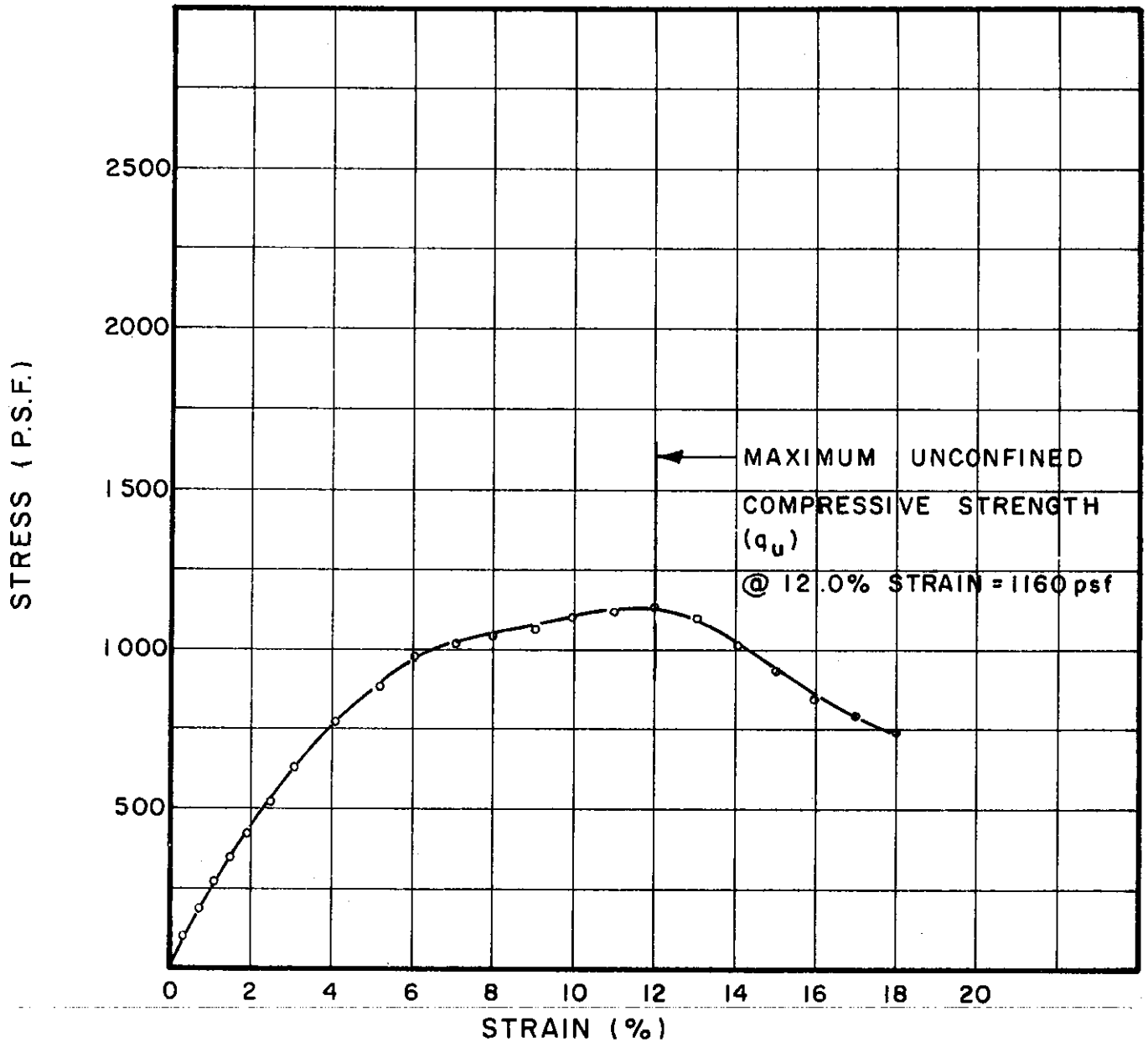

TEST NO.	TEST DATA			SOIL PROPERTIES				
	DIAMETER (INCHES)	HEIGHT (INCHES)	STRAIN RATE (%/MIN)	WATER CONTENT (%)	UNIT WEIGHT (pcf)	ATTERBERG LL (%)	LIMITS PL (%)	SOIL DESCRIPTION
U9.1	1.41	3.45	.261	24.8	101	36	20	SILTY CLAY, SANDY (CL)

BORING NO. 26

SAMPLE NO. 17

DEPTH 78.2' TO 78.5'

UNCONFINED COMPRESSION TESTS

THE DETROIT EDISON COMPANY
BELLE RIVER PLANT UNITS I & II

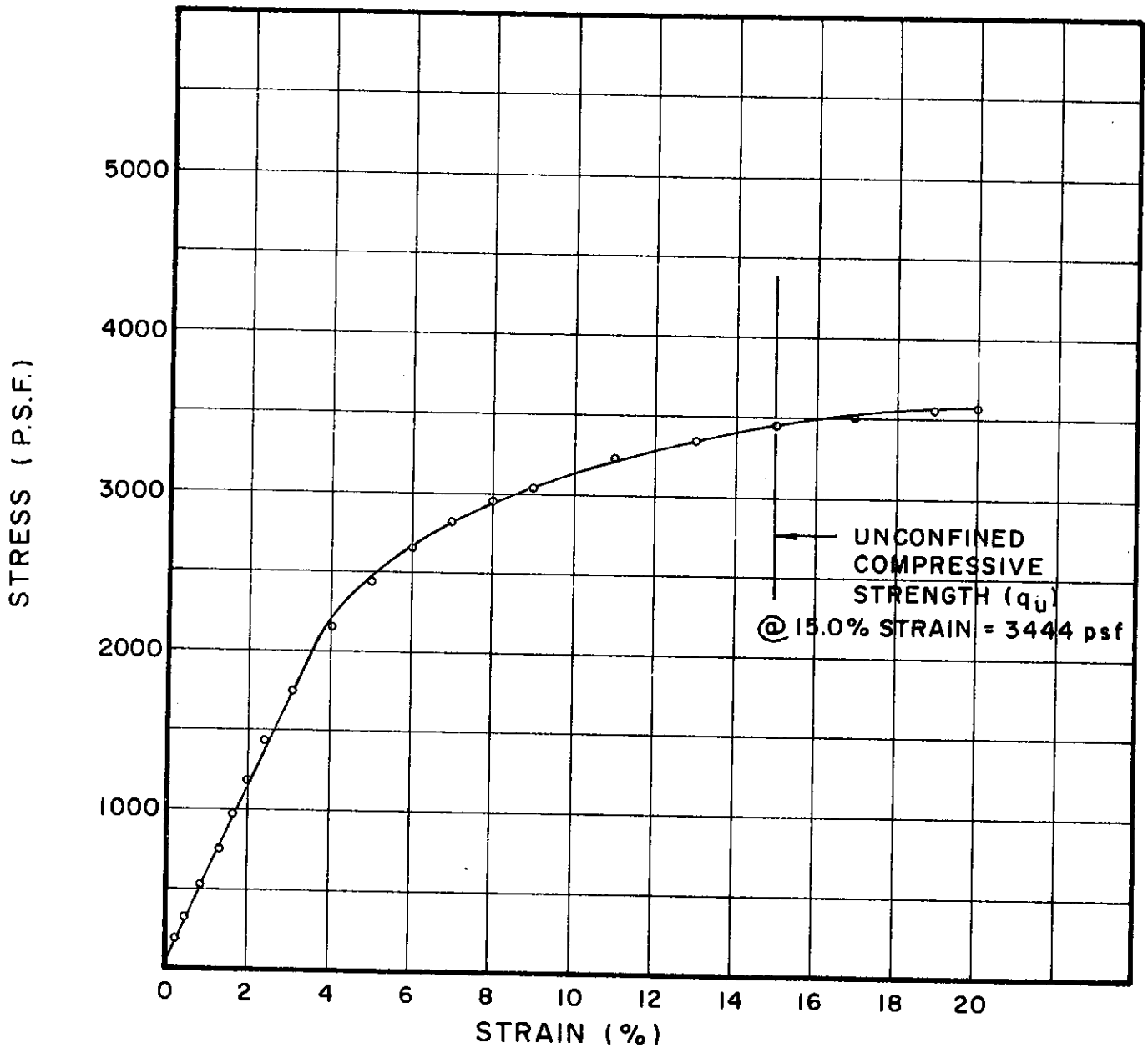

TEST NO.	TEST DATA			SOIL PROPERTIES				
	DIAMETER (INCHES)	HEIGHT (INCHES)	STRAIN RATE (%/MIN)	WATER CONTENT (%)	UNIT WEIGHT (pcf)	ATTERBERG LL (%)	LIMITS PL (%)	SOIL DESCRIPTION
U303.1	1.41	3.45	.261	30.6	94	51	23	SILTY CLAY (CL-CH)

BORING NO. 27
 SAMPLE NO. 4
 DEPTH 8.6' TO 8.9'

UNCONFINED COMPRESSION TESTS

THE DETROIT EDISON COMPANY
 BELLE RIVER PLANT UNITS I & II

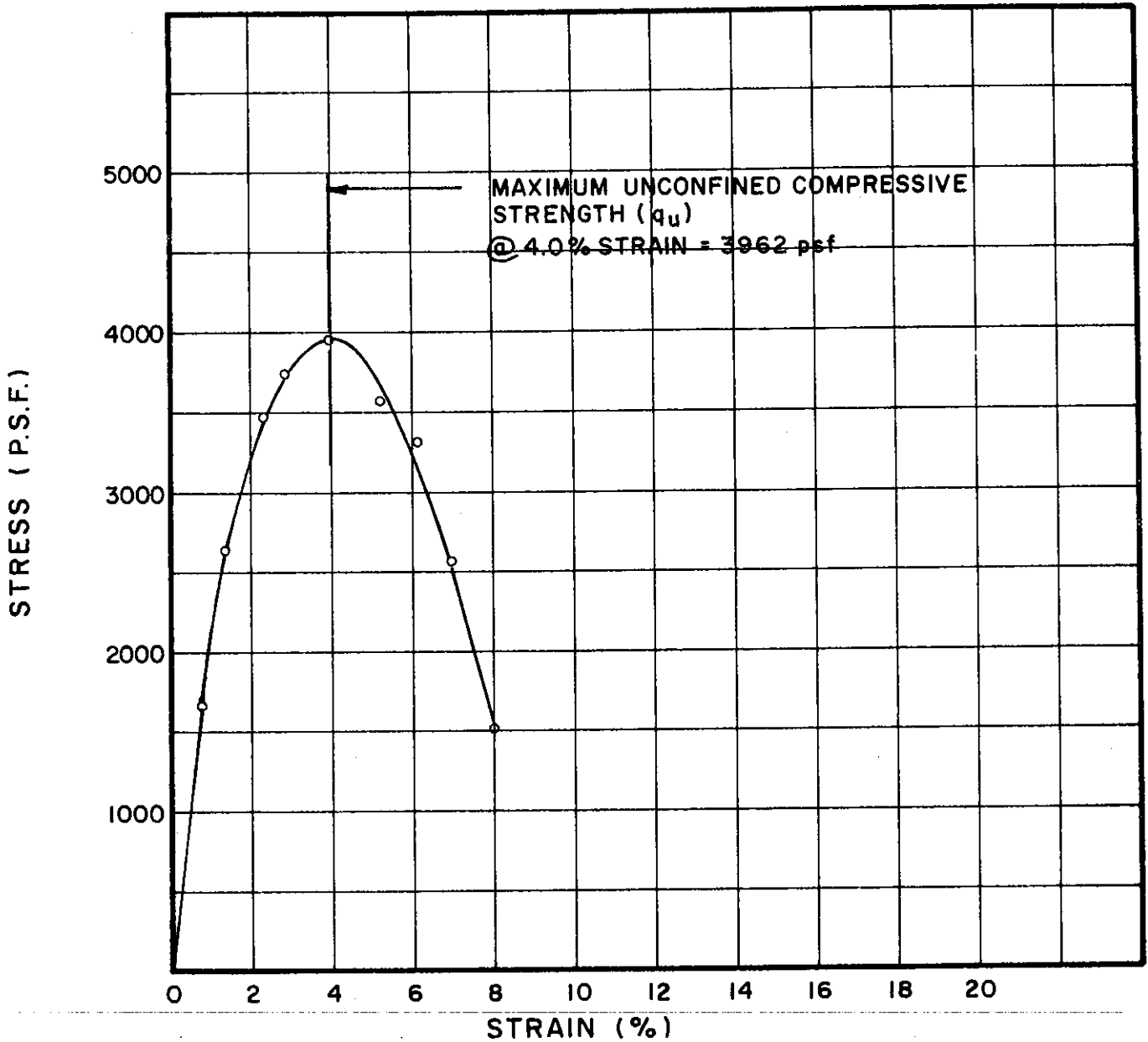

TEST NO.	TEST DATA			WATER CONTENT (%)	DRY UNIT WEIGHT (pcf)	SOIL PROPERTIES		SOIL DESCRIPTION
	DIAMETER (INCHES)	HEIGHT (INCHES)	STRAIN RATE (%/MIN)			ATTERBERG LL (%)	LIMITS PL (%)	
U183.1	1.39	3.49	0.26	25.3	100	47	23	SILTY CLAY (CL)

BORING NO. 28

SAMPLE NO. 3

DEPTH 5.8' TO 6.1'

UNCONFINED COMPRESSION TESTS

THE DETROIT EDISON COMPANY
BELLE RIVER PLANT UNITS I & II

FILE 1255

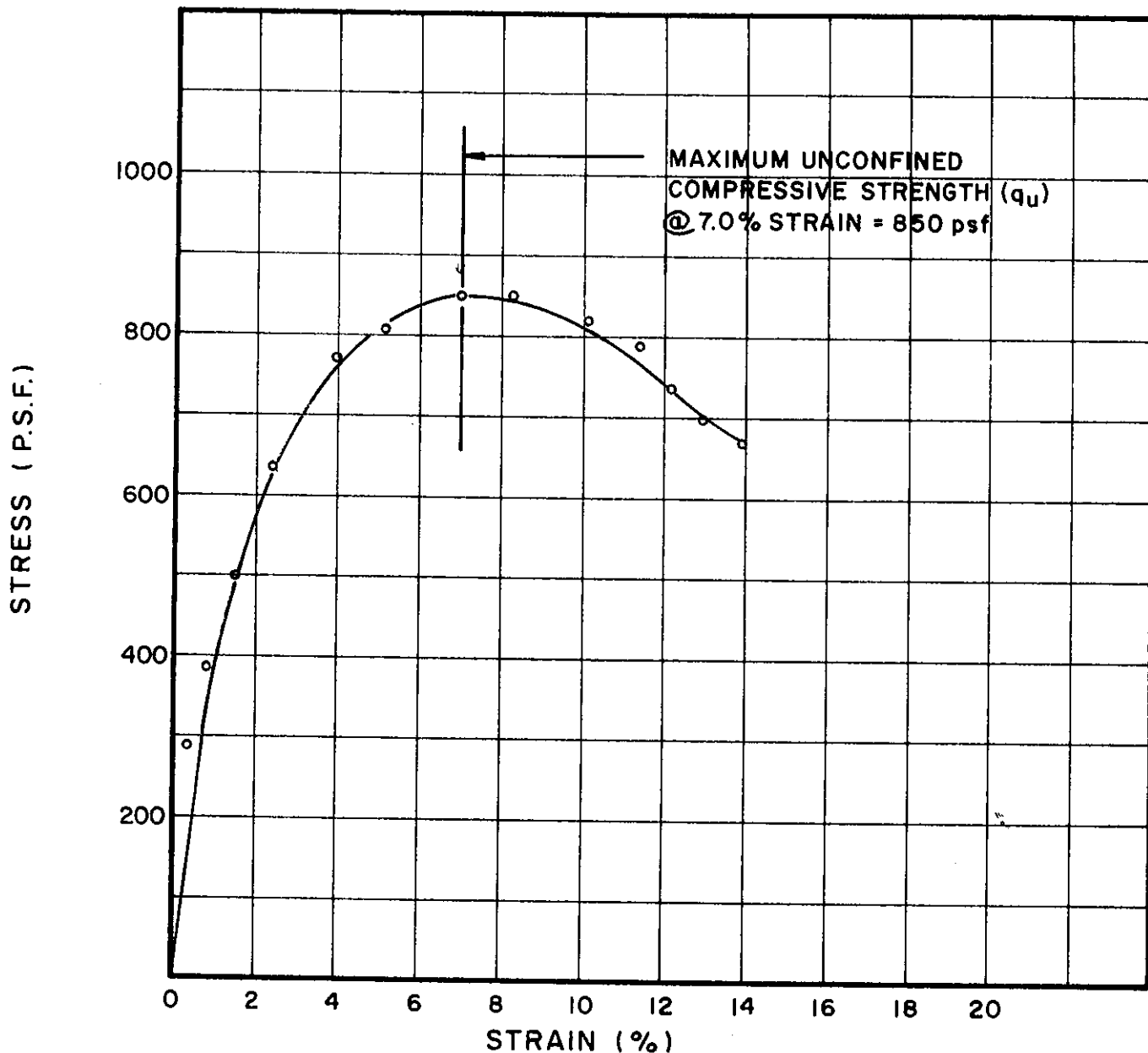

TEST NO.	TEST DATA			SOIL PROPERTIES				SOIL DESCRIPTION
	DIAMETER (INCHES)	HEIGHT (INCHES)	STRAIN RATE (%/MIN)	WATER CONTENT (%)	DRY UNIT WEIGHT (pcf)	ATTERBERG LL (%)	LIMITS PL (%)	
UI86.2	1.40	3.50	0.26	38.0	84	42	20	SILTY CLAY (CL)

BORING NO. 28

SAMPLE NO. 9

DEPTH 28.8' TO 29.1'

UNCONFINED COMPRESSION TESTS

THE DETROIT EDISON COMPANY
BELLE RIVER PLANT UNITS I & II

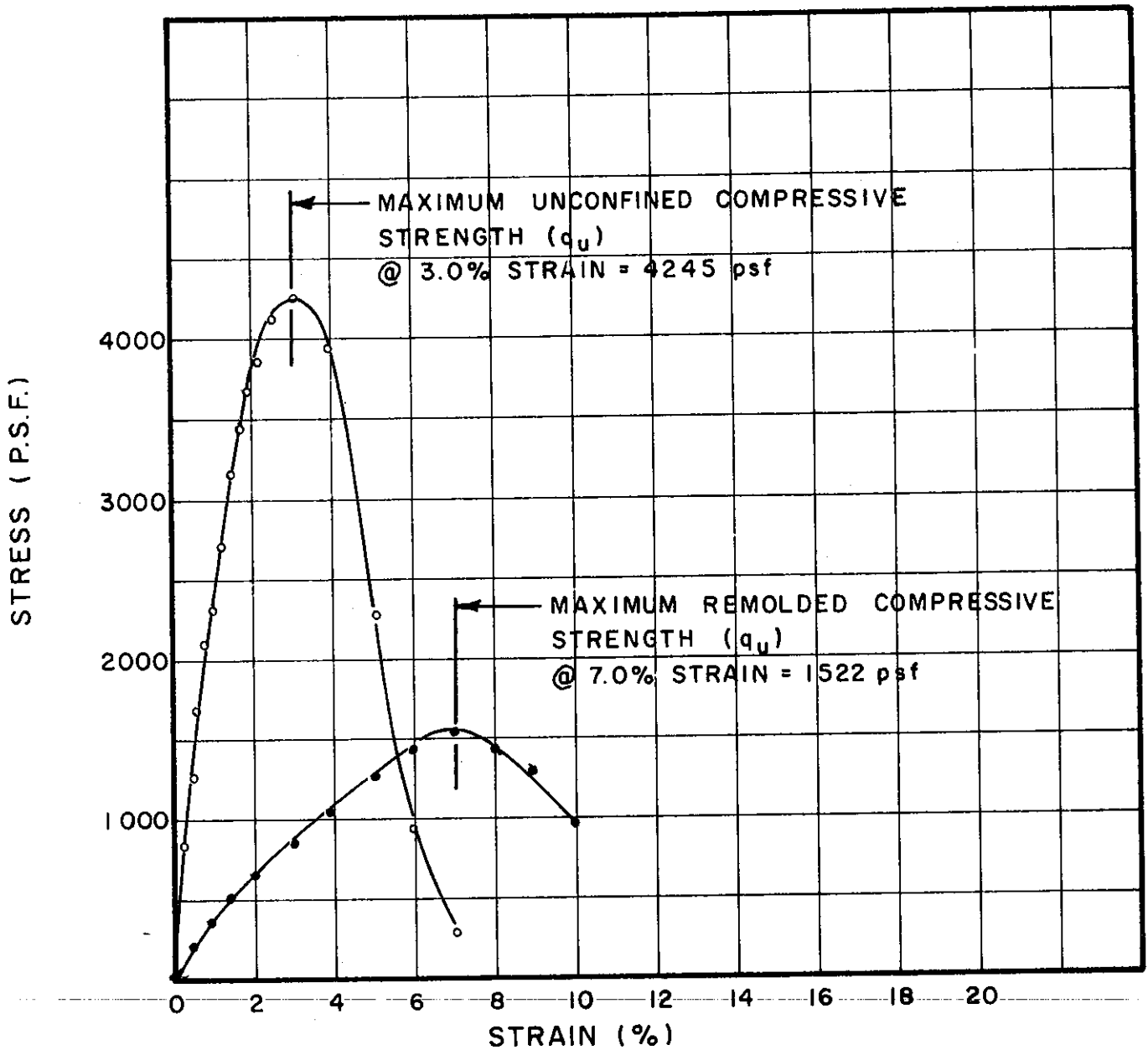

TEST NO.	TEST DATA			SOIL PROPERTIES				
	DIAMETER (INCHES)	HEIGHT (INCHES)	STRAIN RATE (%/MIN)	WATER CONTENT (%)	UNIT WEIGHT (pcf)	ATTERBERG LL (%)	LIMITS PL (%)	SOIL DESCRIPTION
UI7.1	1.44	3.54	.254	24.3	102	49	24	SILTY CLAY (CL-CH)
UI7.1	1.40	3.50	.257	24.3	103	49	24	SILTY CLAY (CL-CH)

BORING NO. 38
 SAMPLE NO. 3
 DEPTH 8.7' TO 9.0'

UNCONFINED COMPRESSION TESTS

THE DETROIT EDISON COMPANY
 BELLE RIVER PLANT UNITS I & II

FILE 1255

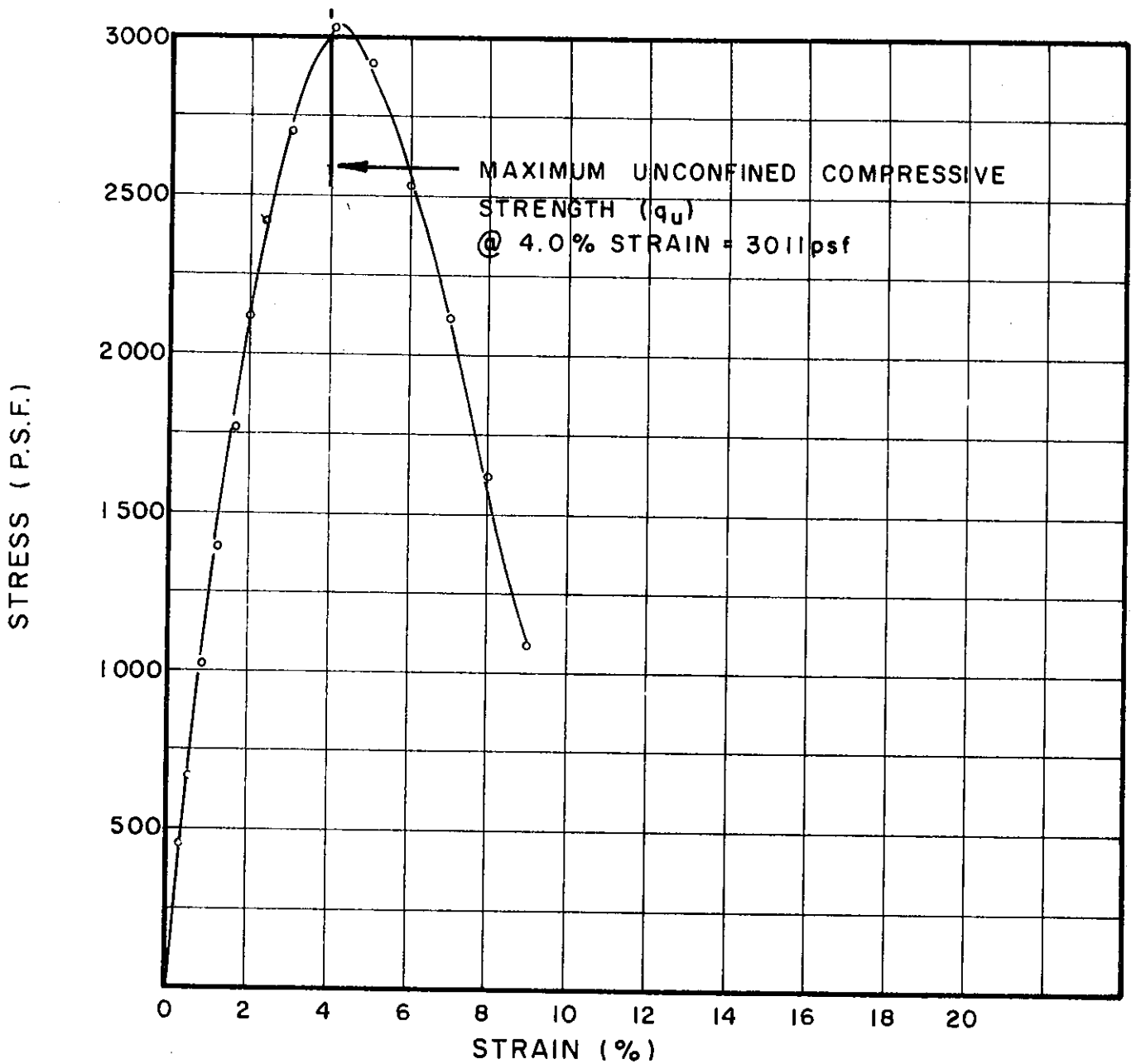

TEST NO.	TEST DATA			SOIL PROPERTIES				
	DIAMETER (INCHES)	HEIGHT (INCHES)	STRAIN RATE (%/MIN)	WATER CONTENT (%)	UNIT WEIGHT (pcf)	ATTERBERG LL (%)	LIMITS PL (%)	SOIL DESCRIPTION
UI8.1	1.42	3.50	.257	28.5	96	46	22	SILTY CLAY (CL-CH)

BORING NO. 38
 SAMPLE NO. 4
 DEPTH 14.3' TO 14.6'

UNCONFINED COMPRESSION TESTS

THE DETROIT EDISON COMPANY
 BELLE RIVER PLANT UNITS I & II

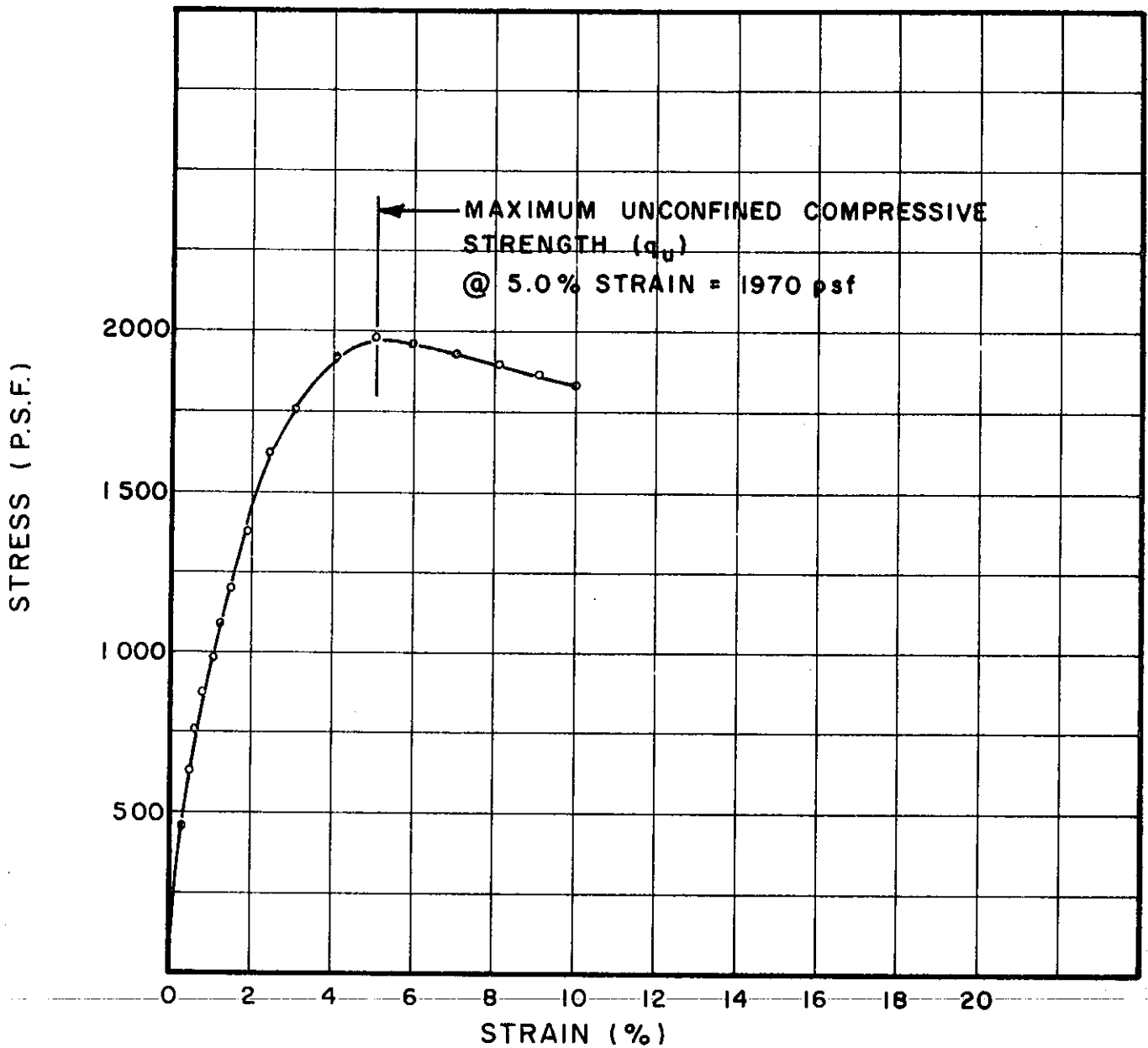

TEST NO.	TEST DATA			SOIL PROPERTIES				
	DIAMETER (INCHES)	HEIGHT (INCHES)	STRAIN RATE (%/MIN)	WATER CONTENT (%)	UNIT WEIGHT (pcf)	ATTERBERG LL (%)	LIMITS PL (%)	SOIL DESCRIPTION
U22.1	1.41	3.50	.257	33.4	90	44	21	SILTY CLAY (CL-CH)

BORING NO. 38

SAMPLE NO. 12

DEPTH 54.2' TO 54.5'

UNCONFINED COMPRESSION TESTS

THE DETROIT EDISON COMPANY
BELLE RIVER PLANT UNITS I & II

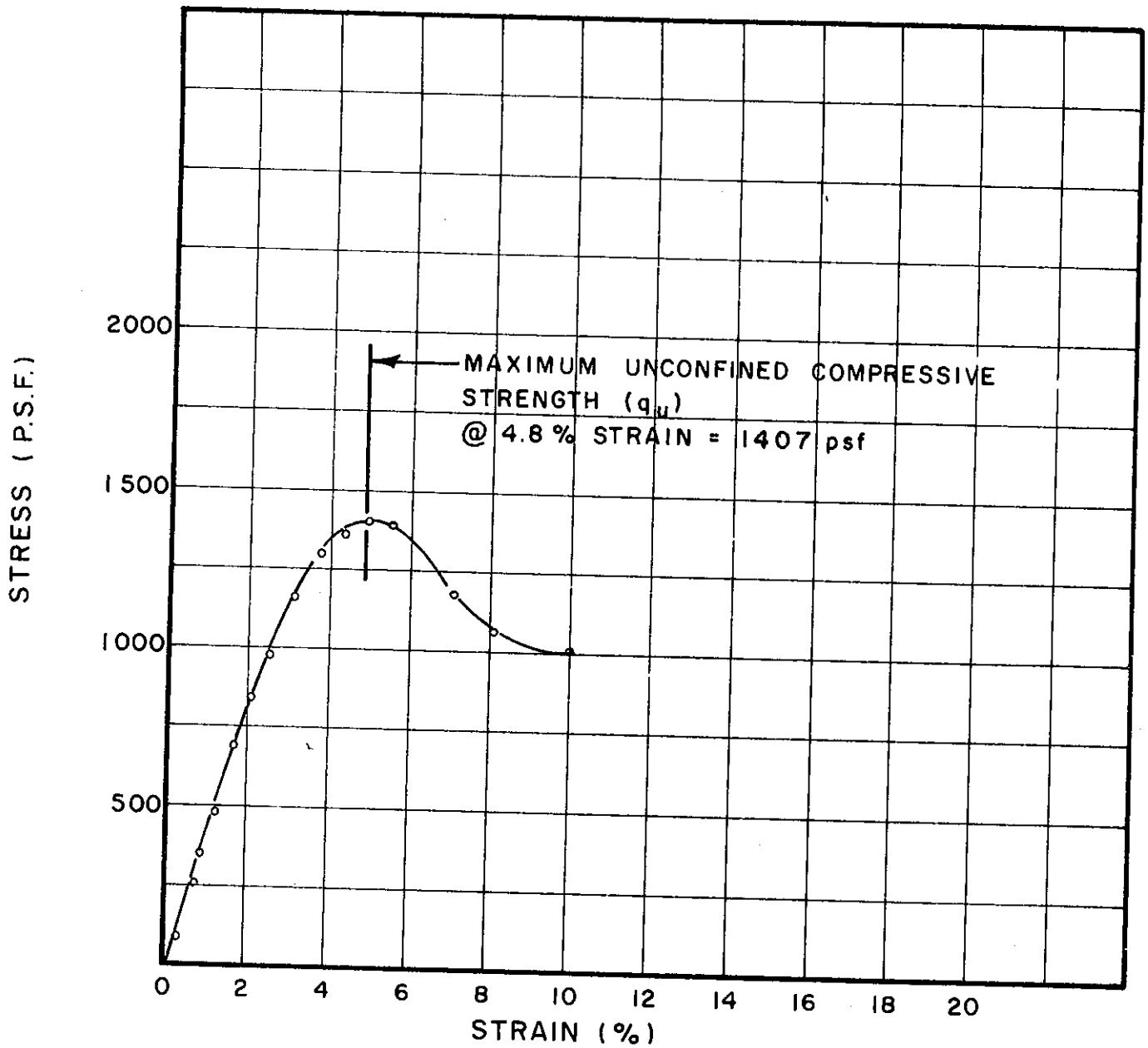

TEST NO.	TEST DATA			SOIL PROPERTIES				
	DIAMETER (INCHES)	HEIGHT (INCHES)	STRAIN RATE (%/MIN)	WATER CONTENT (%)	UNIT WEIGHT (pcf)	ATTERBERG LL (%)	LIMITS PL (%)	SOIL DESCRIPTION
U24.1	1.40	3.50	.257	41.3	79	55	24	SILTY CLAY (CL-CH)

BORING NO. 38

SAMPLE NO. 16

DEPTH 73.7' TO 74.0'

UNCONFINED COMPRESSION TESTS

THE DETROIT EDISON COMPANY
BELLE RIVER PLANT UNITS I & II

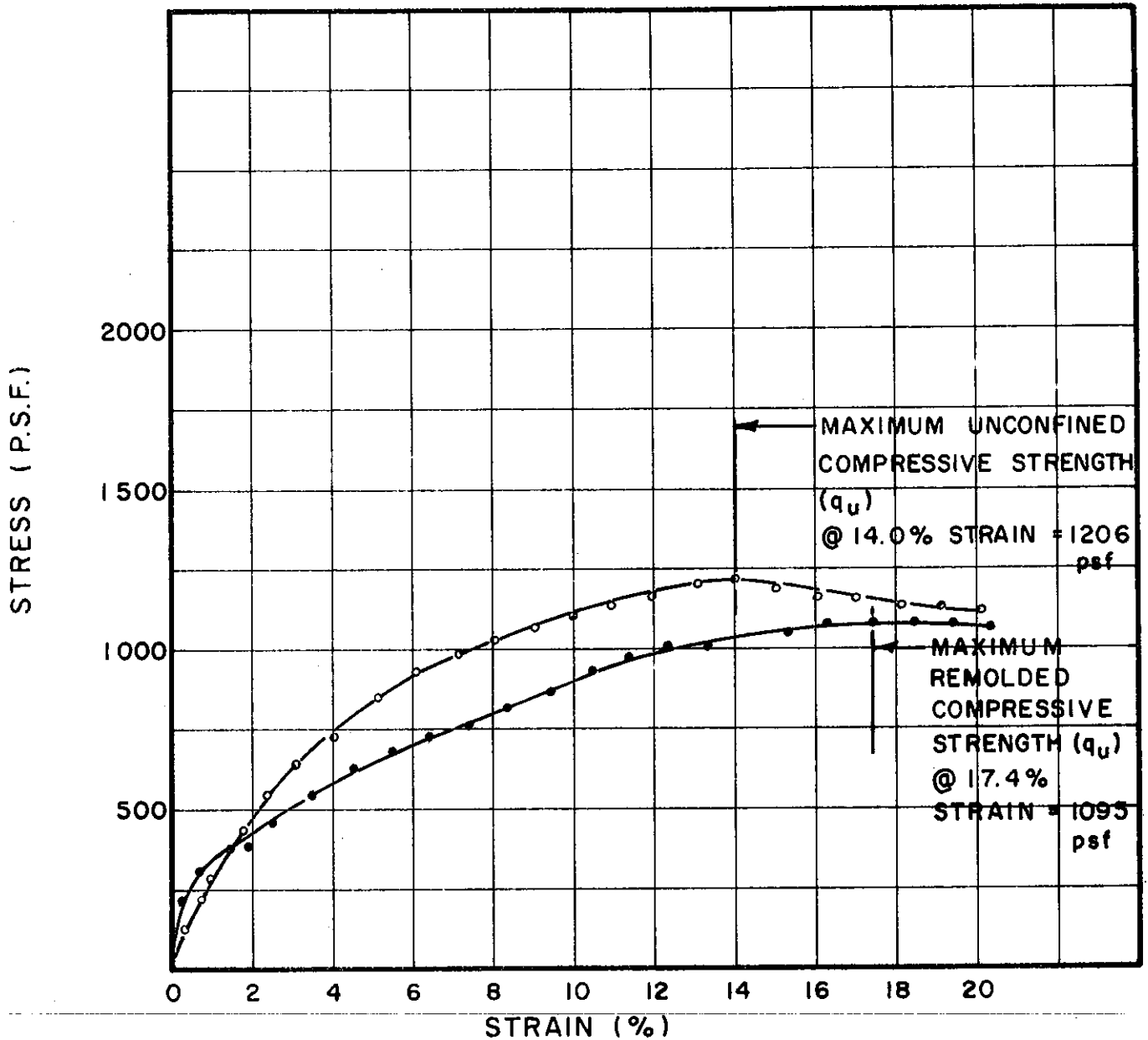

TEST NO.	TEST DATA			SOIL PROPERTIES				
	DIAMETER (INCHES)	HEIGHT (INCHES)	STRAIN RATE (%/MIN)	WATER CONTENT (%)	UNIT WEIGHT (pcf)	ATTERBERG LL (%)	LIMITS PL (%)	SOIL DESCRIPTION
U25.1	1.41	3.50	.257	22.2	104	33	19	SILTY CLAY GRAVELLY (CL)
U _r 25.1	1.40	3.52	.256	22.2	105	33	19	SILTY CLAY GRAVELLY (CL)

BORING NO. 38

SAMPLE NO. 18

DEPTH 84.6' TO 84.9'

UNCONFINED COMPRESSION TESTS

THE DETROIT EDISON COMPANY
BELLE RIVER PLANT UNITS I & II

FILE 1255

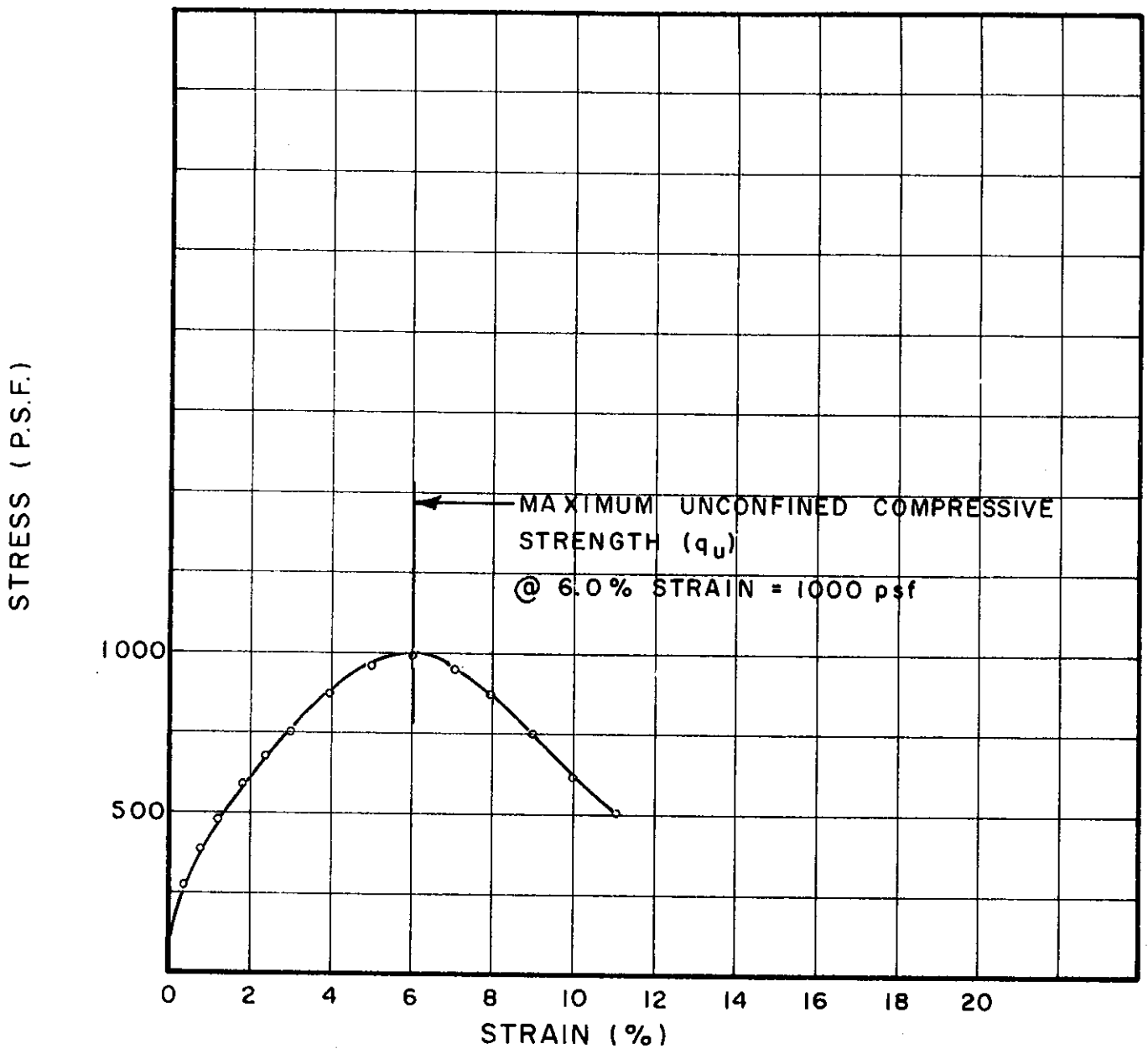

TEST NO.	TEST DATA			SOIL PROPERTIES				
	DIAMETER (INCHES)	HEIGHT (INCHES)	STRAIN RATE (%/MIN)	WATER CONTENT (%)	UNIT WEIGHT (pcf)	ATTERBERG LL (%)	LIMITS PL (%)	SOIL DESCRIPTION
U26.1	1.42	3.50	.257	31.9	92	45	25	SILTY CLAY (CL)

BORING NO. 38
 SAMPLE NO. 24
 DEPTH 114.2' TO 114.5'

UNCONFINED COMPRESSION TESTS

THE DETROIT EDISON COMPANY
 BELLE RIVER PLANT UNITS I & II

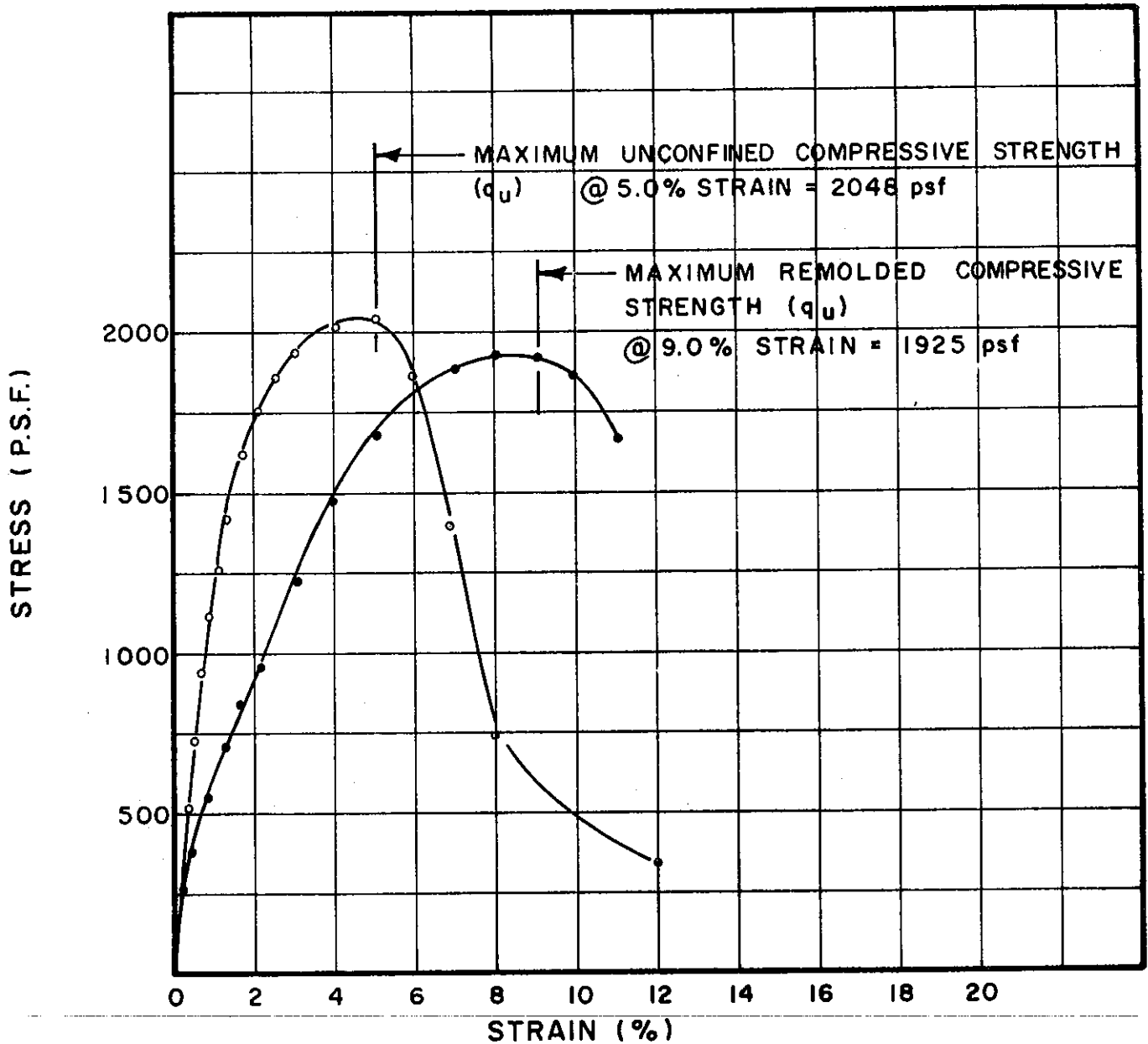

TEST NO.	TEST DATA			SOIL PROPERTIES				
	DIAMETER (INCHES)	HEIGHT (INCHES)	STRAIN RATE (%/MIN)	WATER CONTENT (%)	UNIT WEIGHT (pcf)	ATTERBERG LL (%)	LIMITS PL (%)	SOIL DESCRIPTION
U28.1	1.43	3.50	.257	29.4	94	63	28	SILTY CLAY (CH)
U _r 28.1	1.40	3.38	.266	29.4	95	63	28	SILTY CLAY (CH)

BORING NO. 41
 SAMPLE NO. 2
 DEPTH 4.5' TO 4.8'

UNCONFINED COMPRESSION TESTS

THE DETROIT EDISON COMPANY
 BELLE RIVER PLANT UNITS I & II

FILE 1255

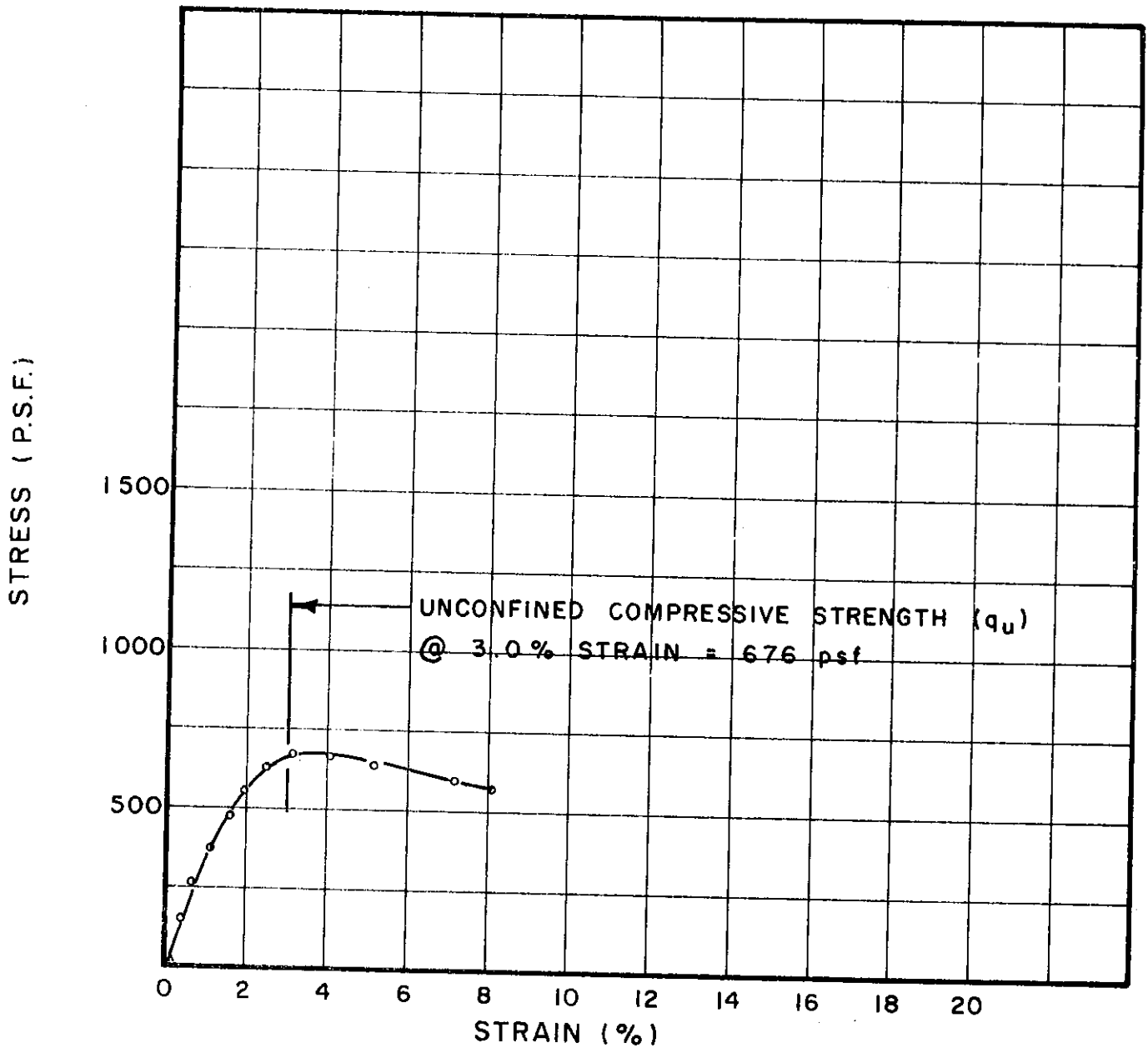

TEST NO.	TEST DATA			SOIL PROPERTIES				
	DIAMETER (INCHES)	HEIGHT (INCHES)	STRAIN RATE (%/MIN)	WATER CONTENT (%)	UNIT WEIGHT (pcf)	ATTERBERG LL (%)	LIMITS PL (%)	SOIL DESCRIPTION
U30.1	1.42	3.50	.257	39.2	83	47	24	SILTY CLAY (CL-CH)

BORING NO. 41
 SAMPLE NO. 7
 DEPTH 20.6' TO 20.9'

UNCONFINED COMPRESSION TESTS

THE DETROIT EDISON COMPANY
 BELLE RIVER PLANT UNITS I & II

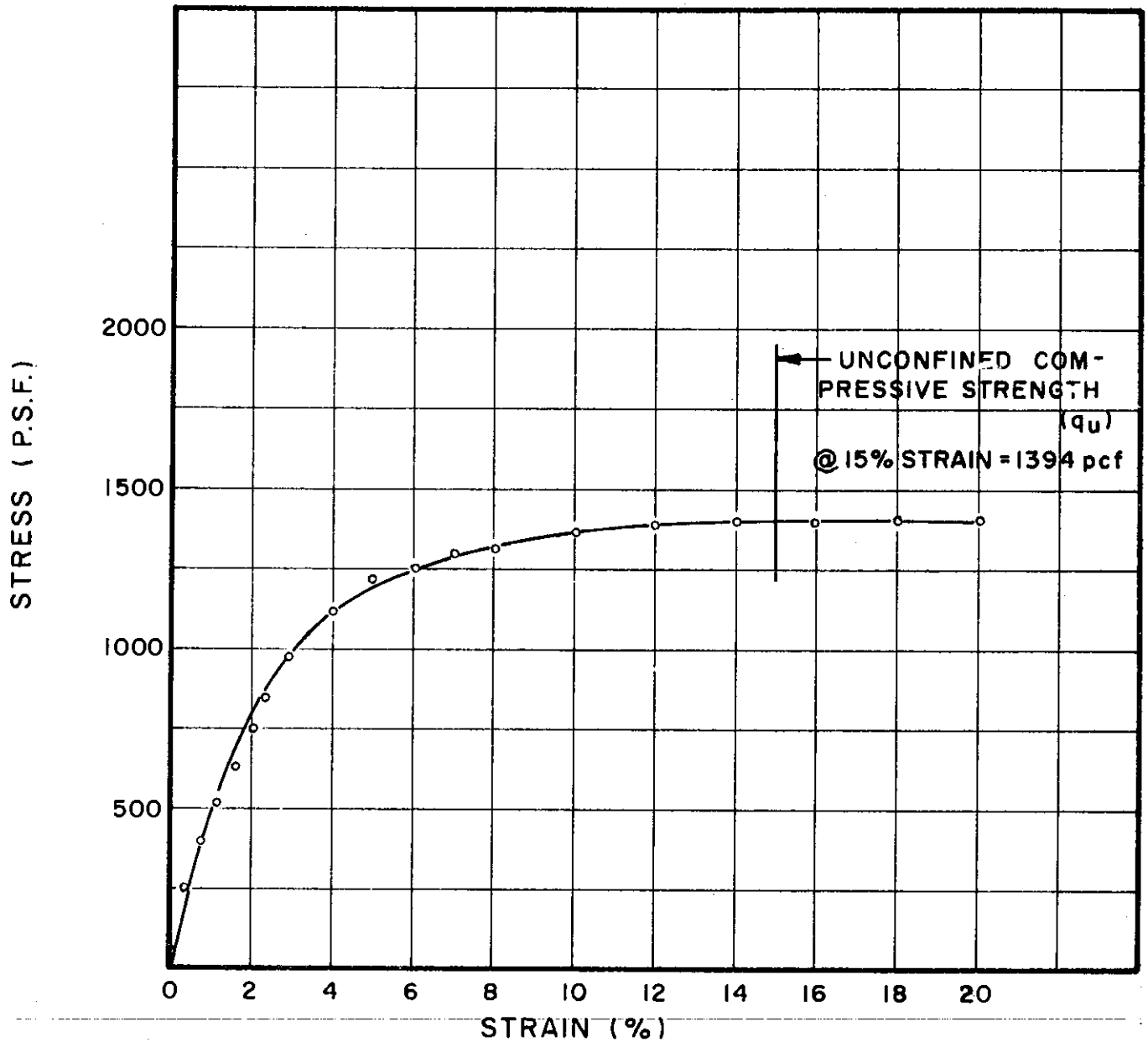

TEST NO.	TEST DATA			SOIL PROPERTIES				
	DIAMETER (INCHES)	HEIGHT (INCHES)	STRAIN RATE (%/MIN)	WATER CONTENT (%)	UNIT WEIGHT (pcf)	ATTERBERG LL (%)	LIMITS PL (%)	SOIL DESCRIPTION
U31.1	1.40	3.50	.257	36.9	86	45	21	SILTY CLAY, (CL-CH)

BORING NO. 41
 SAMPLE NO. 9
 DEPTH 30.9' TO 31.2'

UNCONFINED COMPRESSION TESTS

THE DETROIT EDISON COMPANY
 BELLE RIVER PLANT UNITS I & II

FILE 1255

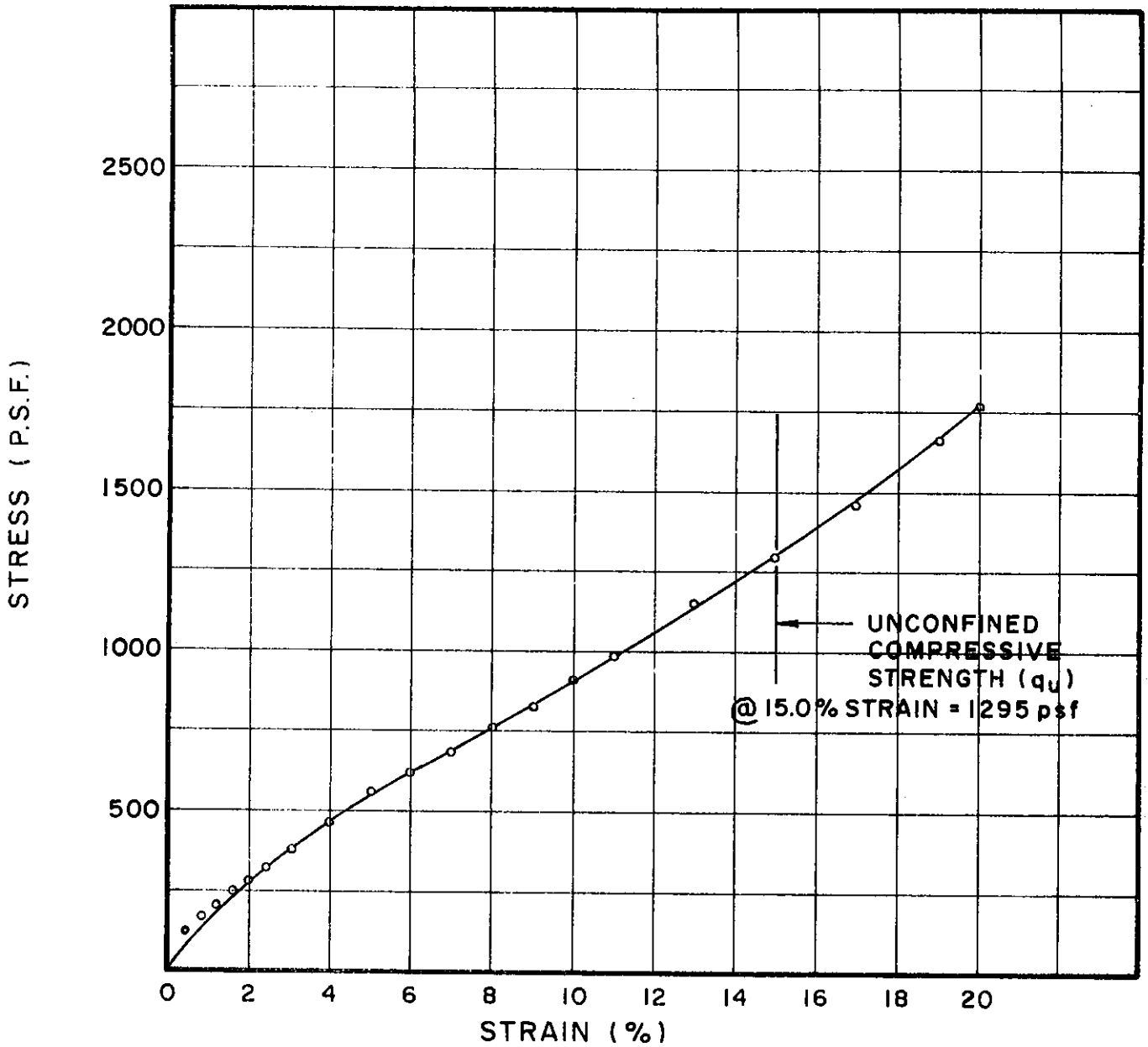

TEST NO.	TEST DATA			SOIL PROPERTIES				SOIL DESCRIPTION
	DIAMETER (INCHES)	HEIGHT (INCHES)	STRAIN RATE (%/MIN)	WATER CONTENT (%)	UNIT WEIGHT (pcf)	ATTERBERG LL (%)	LIMITS PL (%)	
U32.1	1.37	3.45	.260	16.0	118	20	12	SILTY CLAY, SANDY (CL-SC)
								(SAMPLE SLIGHTLY DISTURBED)

BORING NO. 41
 SAMPLE NO. 11
 DEPTH 40.6' TO 41.0'

UNCONFINED COMPRESSION TESTS

THE DETROIT EDISON COMPANY
 BELLE RIVER PLANT UNITS I & II

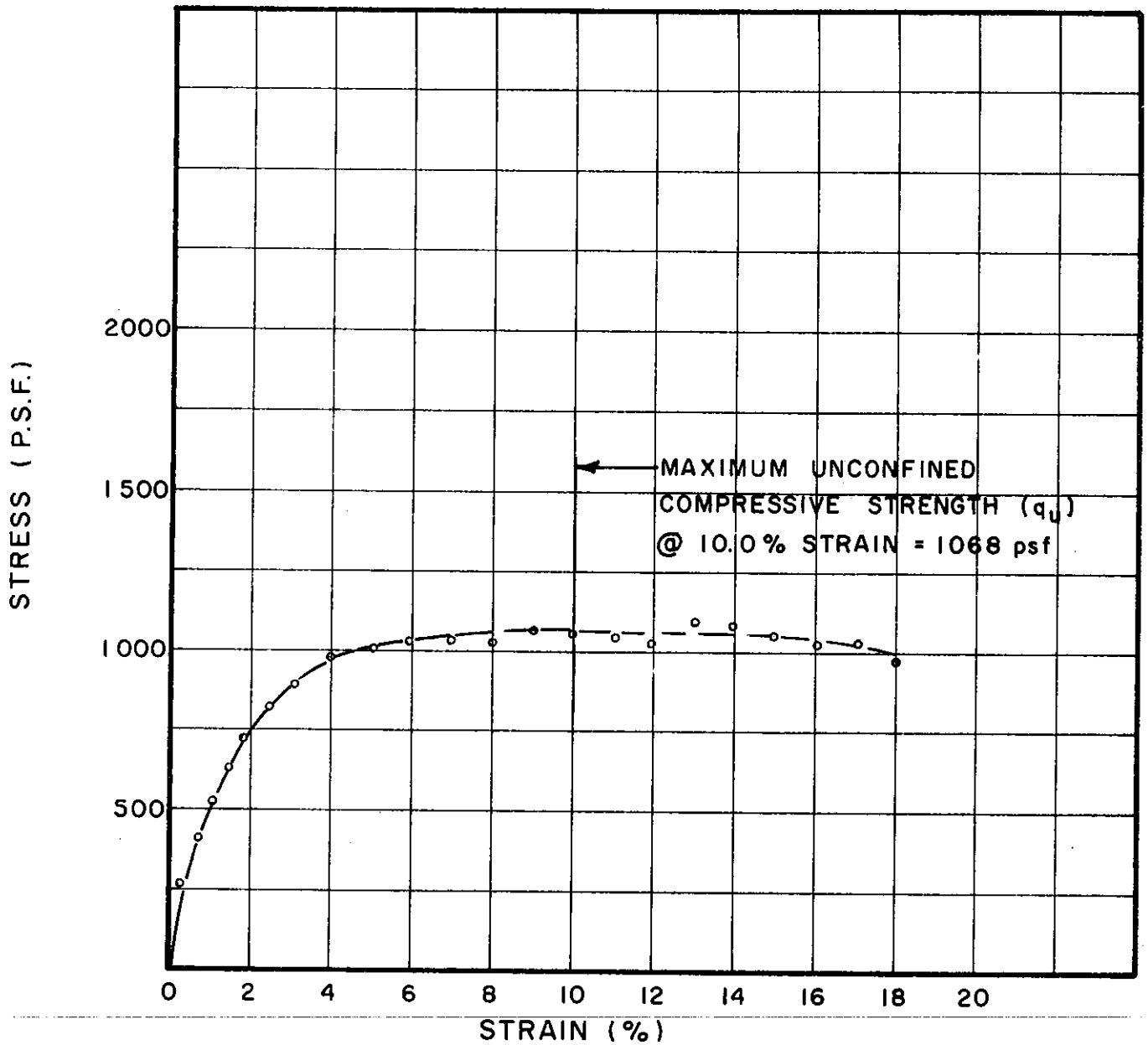

TEST NO.	TEST DATA			SOIL PROPERTIES				
	DIAMETER (INCHES)	HEIGHT (INCHES)	STRAIN RATE (%/MIN)	WATER CONTENT (%)	UNIT WEIGHT (pcf)	ATTERBERG LL (%)	LIMITS PL (%)	SOIL DESCRIPTION
U37.1	1.41	3.47	.259	26.4	99	34	20	SILTY CLAY, SANDY (CL)

BORING NO. 41
 SAMPLE NO. 23
 DEPTH 101.8' TO 102.1'

UNCONFINED COMPRESSION TESTS

THE DETROIT EDISON COMPANY
 BELLE RIVER PLANT UNITS I & II

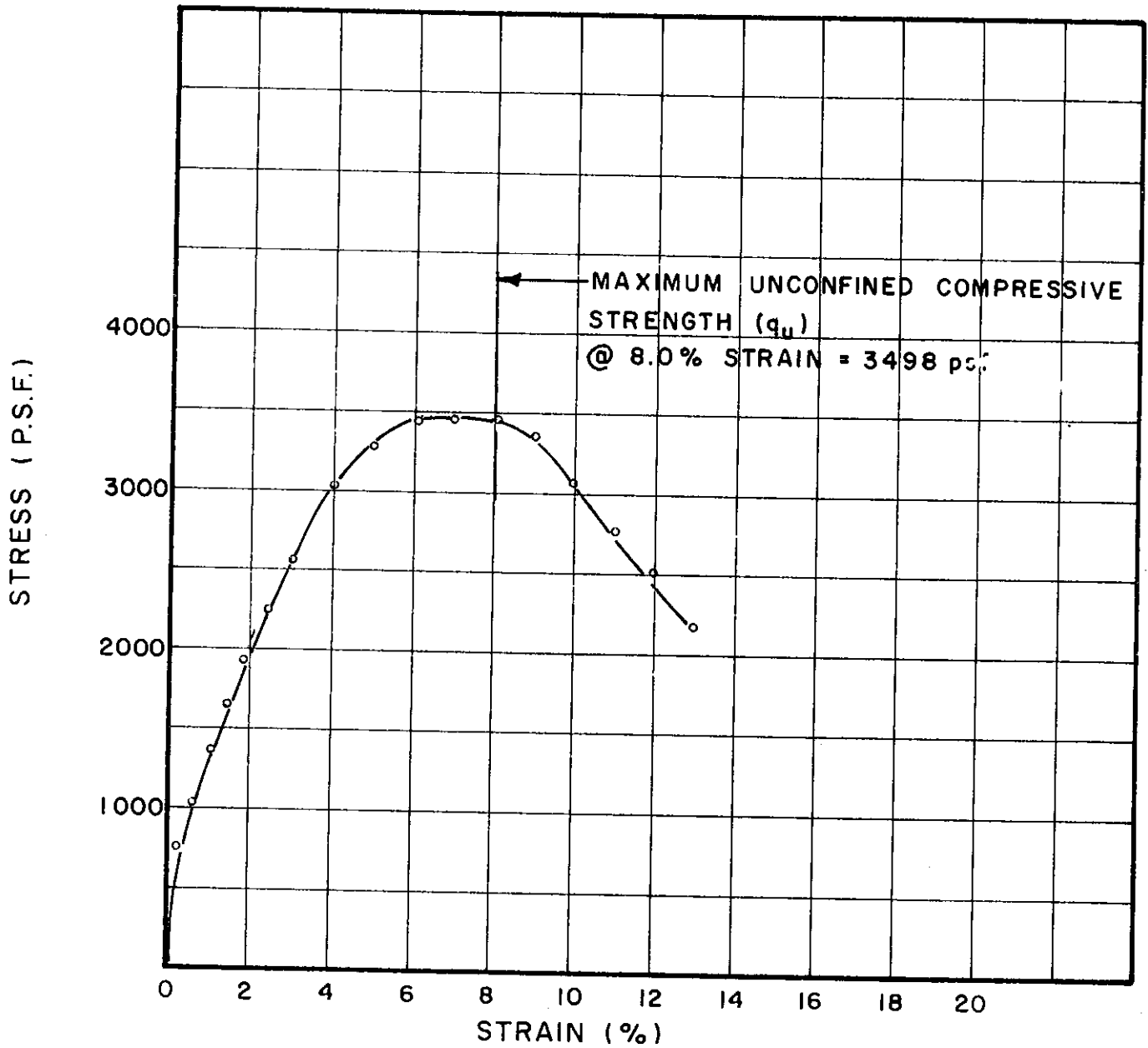

TEST NO.	TEST DATA			SOIL PROPERTIES				
	DIAMETER (INCHES)	HEIGHT (INCHES)	STRAIN RATE (%/MIN)	WATER CONTENT (%)	UNIT WEIGHT (pcf)	ATTERBERG LL (%)	LIMITS PL (%)	SOIL DESCRIPTION
U40.1	1.44	3.13	.29	13.8	124	25	17	CLAYEY SAND (GC-SC)

BORING NO. 41
 SAMPLE NO. 29
 DEPTH 130.7' TO 131.0'

UNCONFINED COMPRESSION TESTS

THE DETROIT EDISON COMPANY
 BELLE RIVER PLANT UNITS I & II

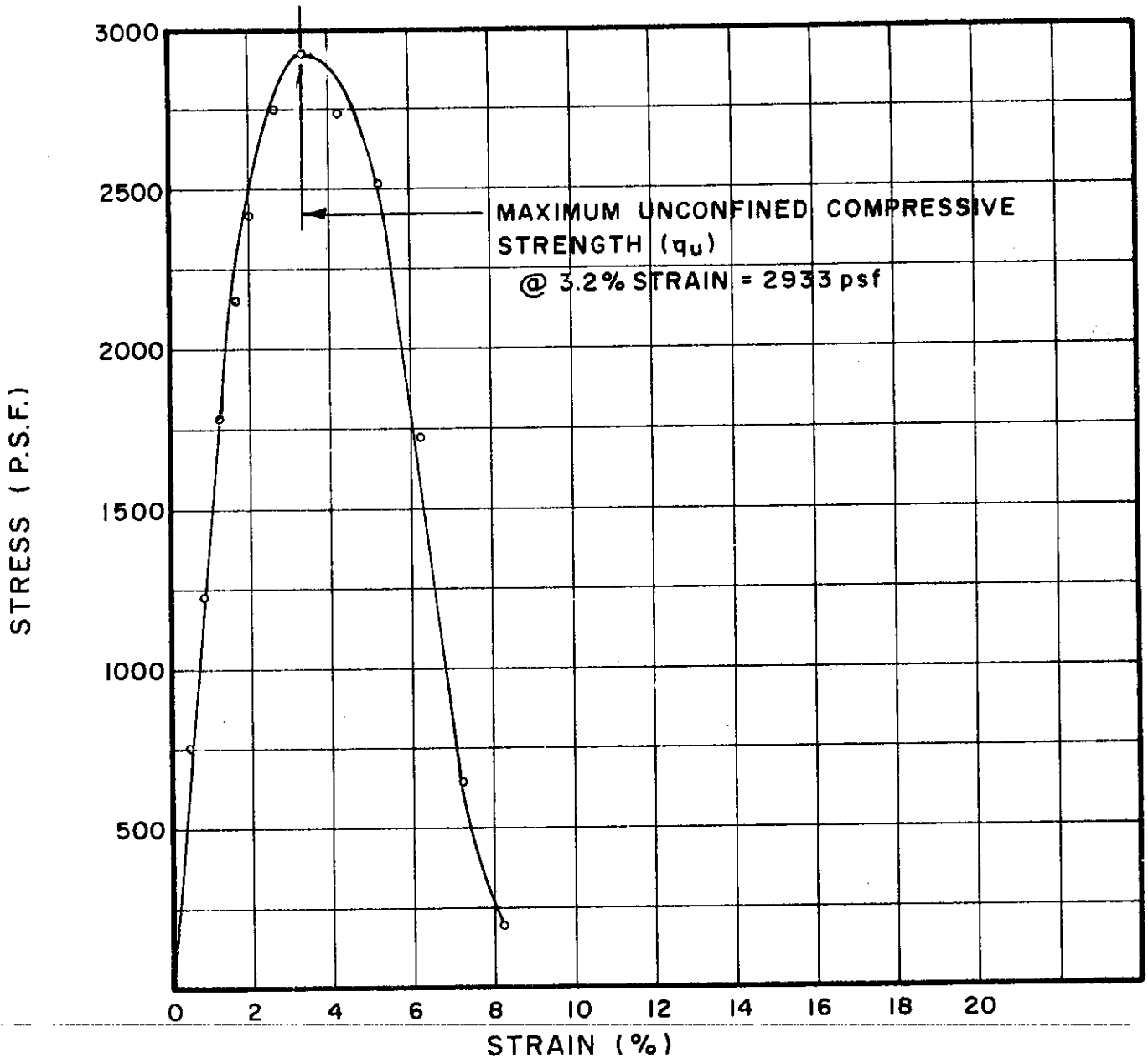

TEST NO.	TEST DATA			SOIL PROPERTIES				
	DIAMETER (INCHES)	HEIGHT (INCHES)	STRAIN RATE (%/MIN)	WATER CONTENT (%)	UNIT WEIGHT (pcf)	ATTERBERG LL (%)	LIMITS PL (%)	SOIL DESCRIPTION
UI98.1	1.43	3.50	.257	27.3	97	63	24	SILTY CLAY (CH)

BORING NO. 48

SAMPLE NO. 2

DEPTH 3.2' TO 3.5'

UNCONFINED COMPRESSION TESTS

THE DETROIT EDISON COMPANY
BELLE RIVER PLANT UNITS I & II

FILE 1255

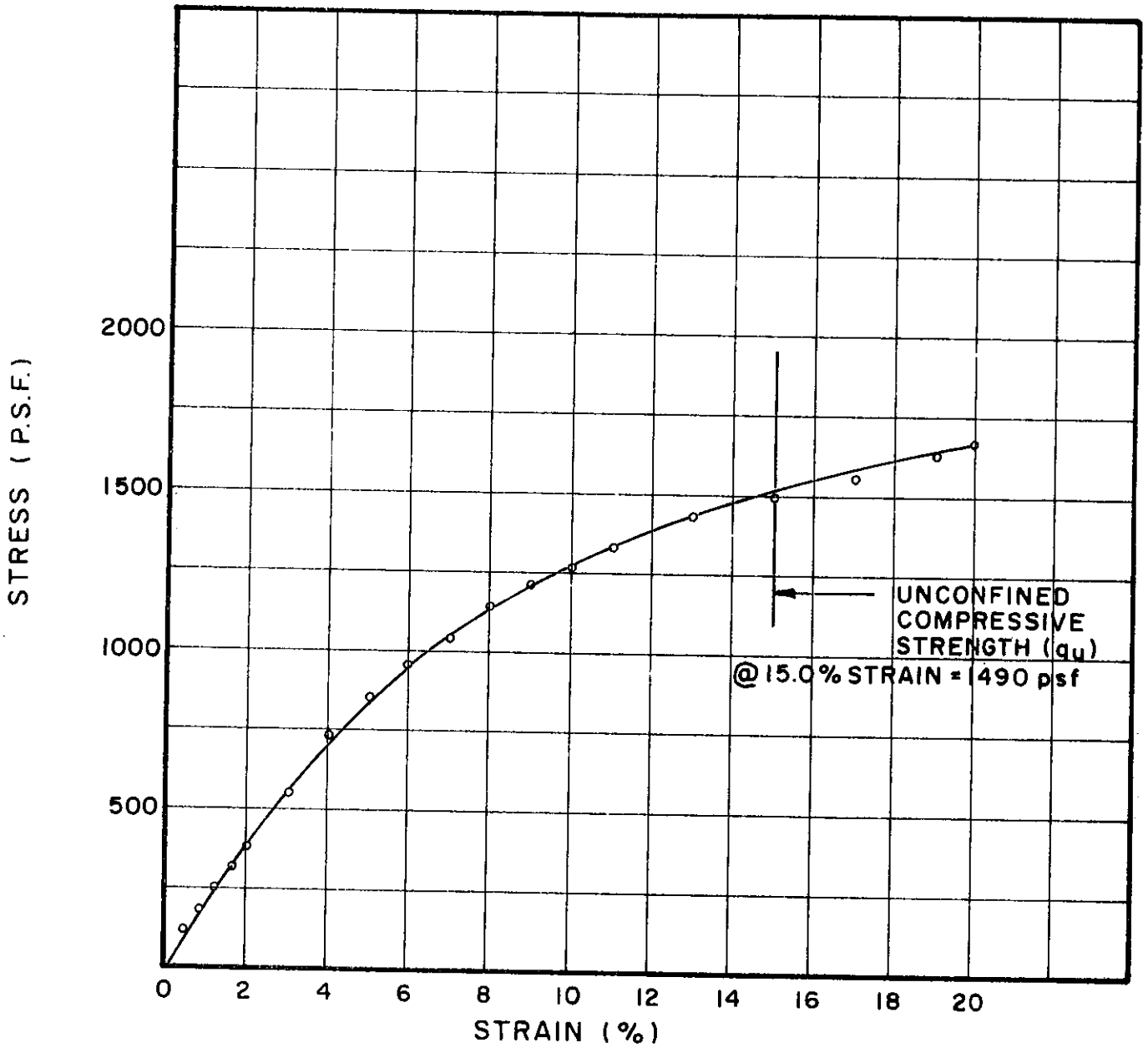

TEST NO.	TEST DATA			SOIL PROPERTIES				SOIL DESCRIPTION
	DIAMETER (INCHES)	HEIGHT (INCHES)	STRAIN RATE (%/MIN)	WATER CONTENT (%)	UNIT WEIGHT (pcf)	ATTERBERG LL (%)	LIMITS PL (%)	
U204.1	1.41	3.41	.264	25.2	100	34	16	SILTY CLAY, SANDY (CL)

BORING NO. 48
 SAMPLE NO. 14
 DEPTH 61.2' TO 61.5'

UNCONFINED COMPRESSION TESTS

THE DETROIT EDISON COMPANY
 BELLE RIVER PLANT UNITS I & II

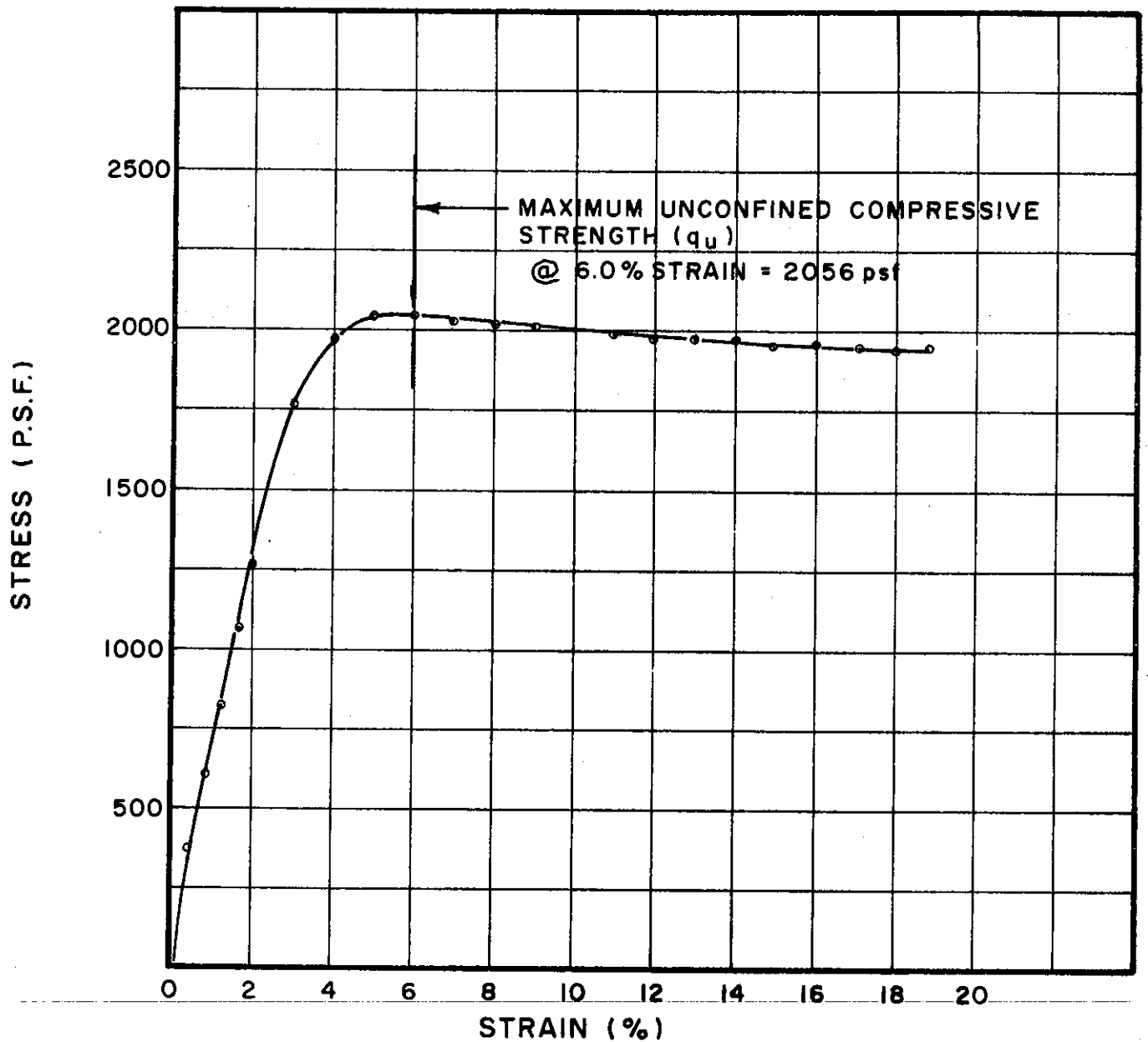

TEST NO.	TEST DATA			SOIL PROPERTIES				
	DIAMETER (INCHES)	HEIGHT (INCHES)	STRAIN RATE (%/MIN)	WATER CONTENT (%)	UNIT WEIGHT (pcf)	ATTERBERG LL (%)	LIMITS PL (%)	SOIL DESCRIPTION
U134.1	1.41	3.51	.256	34.0	90	42	22	SILTY CLAY (CL)

BORING NO. 49

SAMPLE NO. 4

DEPTH 24.0' TO 24.3'

UNCONFINED COMPRESSION TESTS

THE DETROIT EDISON COMPANY
BELLE RIVER PLANT UNITS I & II

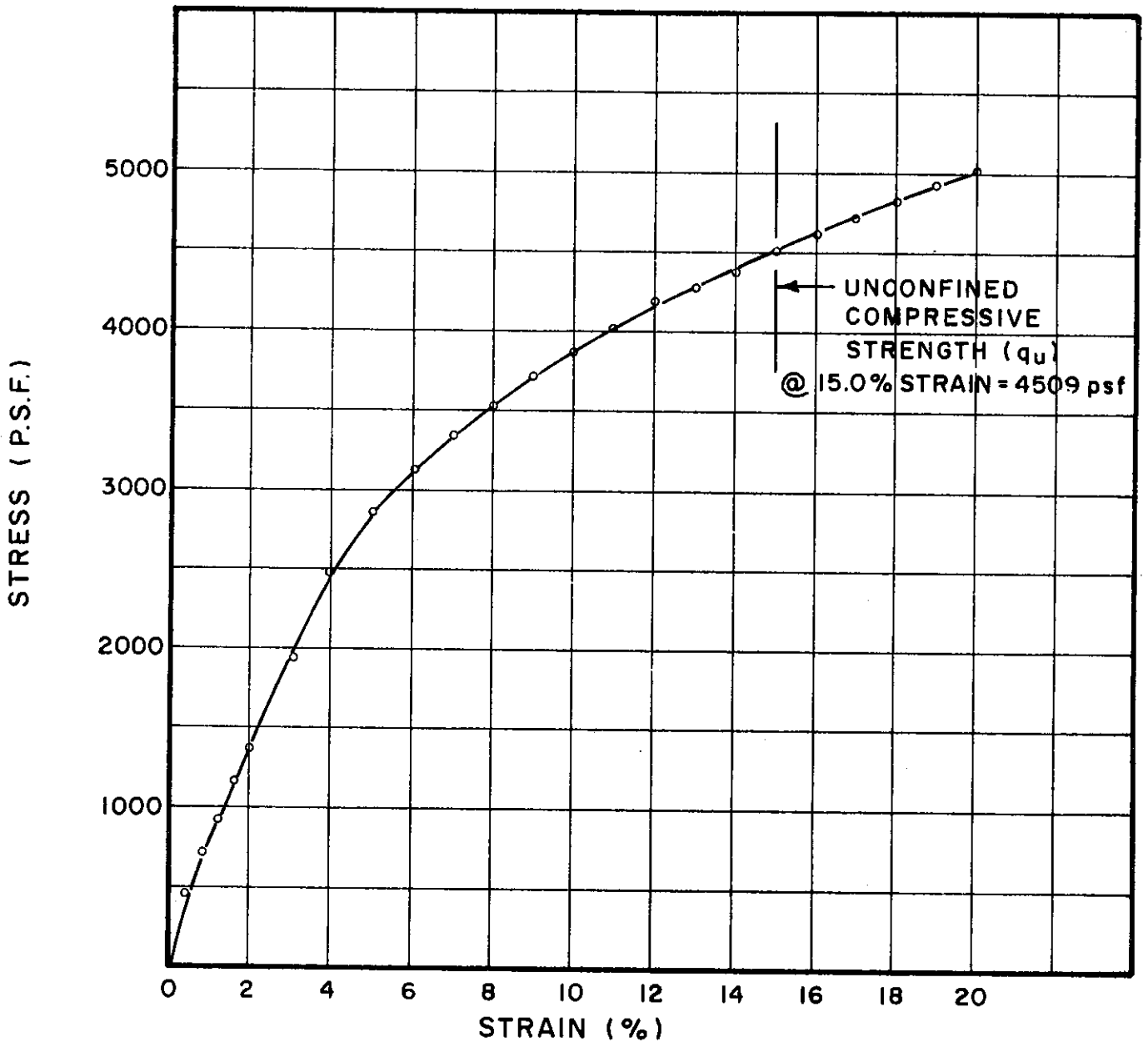

TEST NO.	TEST DATA			SOIL PROPERTIES				
	DIAMETER (INCHES)	HEIGHT (INCHES)	STRAIN RATE (%/MIN)	WATER CONTENT (%)	UNIT WEIGHT (pcf)	ATTERBERG LL (%)	LIMITS PL (%)	SOIL DESCRIPTION
UI39.1	1.41	3.36	.268	25.6	100	33	22	SILTY CLAY; SANDY
								(CL)

BORING NO. 49

SAMPLE NO. 9

DEPTH 73.9' TO 74.3'

UNCONFINED COMPRESSION TESTS

THE DETROIT EDISON COMPANY
BELLE RIVER PLANT UNITS I & II

STRESS (PSF)

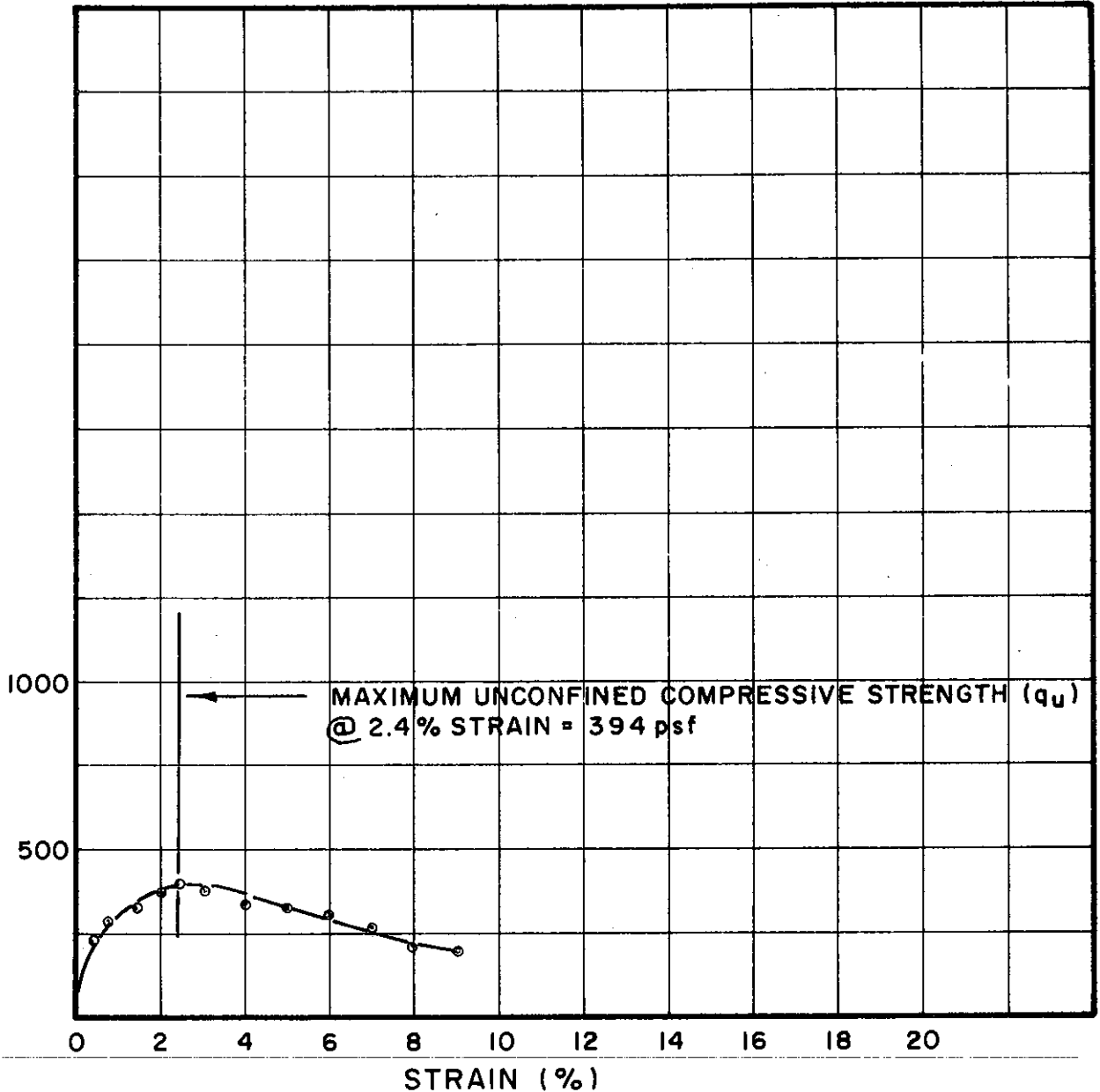

TEST NO.	TEST DATA			SOIL PROPERTIES				
	DIAMETER (INCHES)	HEIGHT (INCHES)	STRAIN RATE (%/MIN)	WATER CONTENT (%)	DRY UNIT WEIGHT (pcf)	ATTERBERG LL (%)	LIMITS PL (%)	SOIL DESCRIPTION
UB5.1	1.39	3.21	.25	45.8	75	51	18	SILTY CLAY (CH-CL)

BORING NO. 50

SAMPLE NO. 6

DEPTH 29.3' TO 29.7'

UNCONFINED COMPRESSION TESTS

THE DETROIT EDISON COMPANY
BELLE RIVER PLANT UNITS I & II

FILE 1255

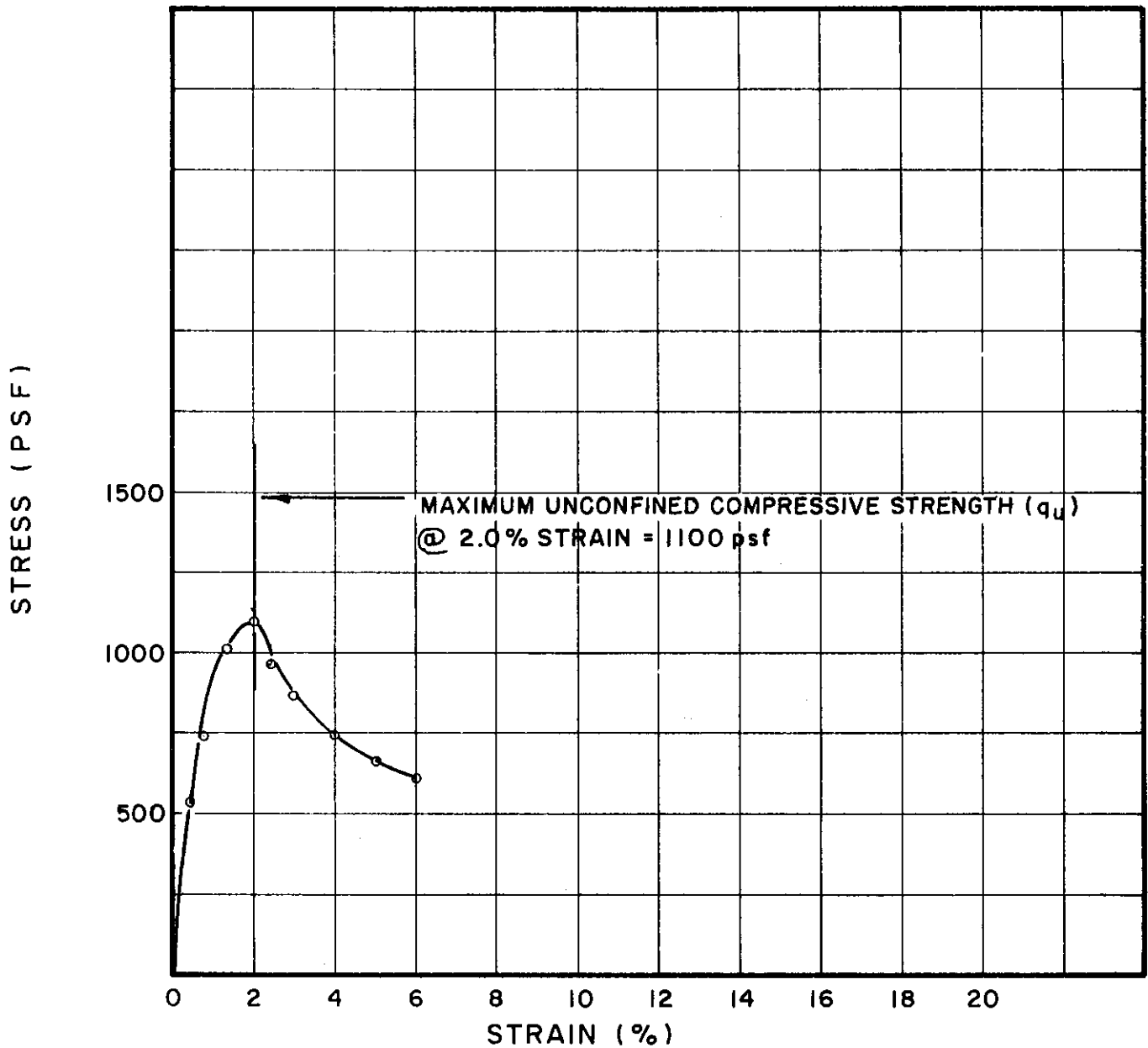

TEST NO.	TEST DATA			WATER CONTENT (%)	DRY UNIT WEIGHT (pcf)	SOIL PROPERTIES		SOIL DESCRIPTION
	DIAMETER (INCHES)	HEIGHT (INCHES)	STRAIN RATE (%/MIN)			ATTERBERG LL (%)	LIMITS PL (%)	
U86.1	1.40	3.27	0.25	51.3	70	55	23	SILTY CLAY (CH)

BORING NO. 50
 SAMPLE NO. 8
 DEPTH 38.9' TO 39.2'

UNCONFINED COMPRESSION TESTS

THE DETROIT EDISON COMPANY
 BELLE RIVER PLANT UNITS I & II

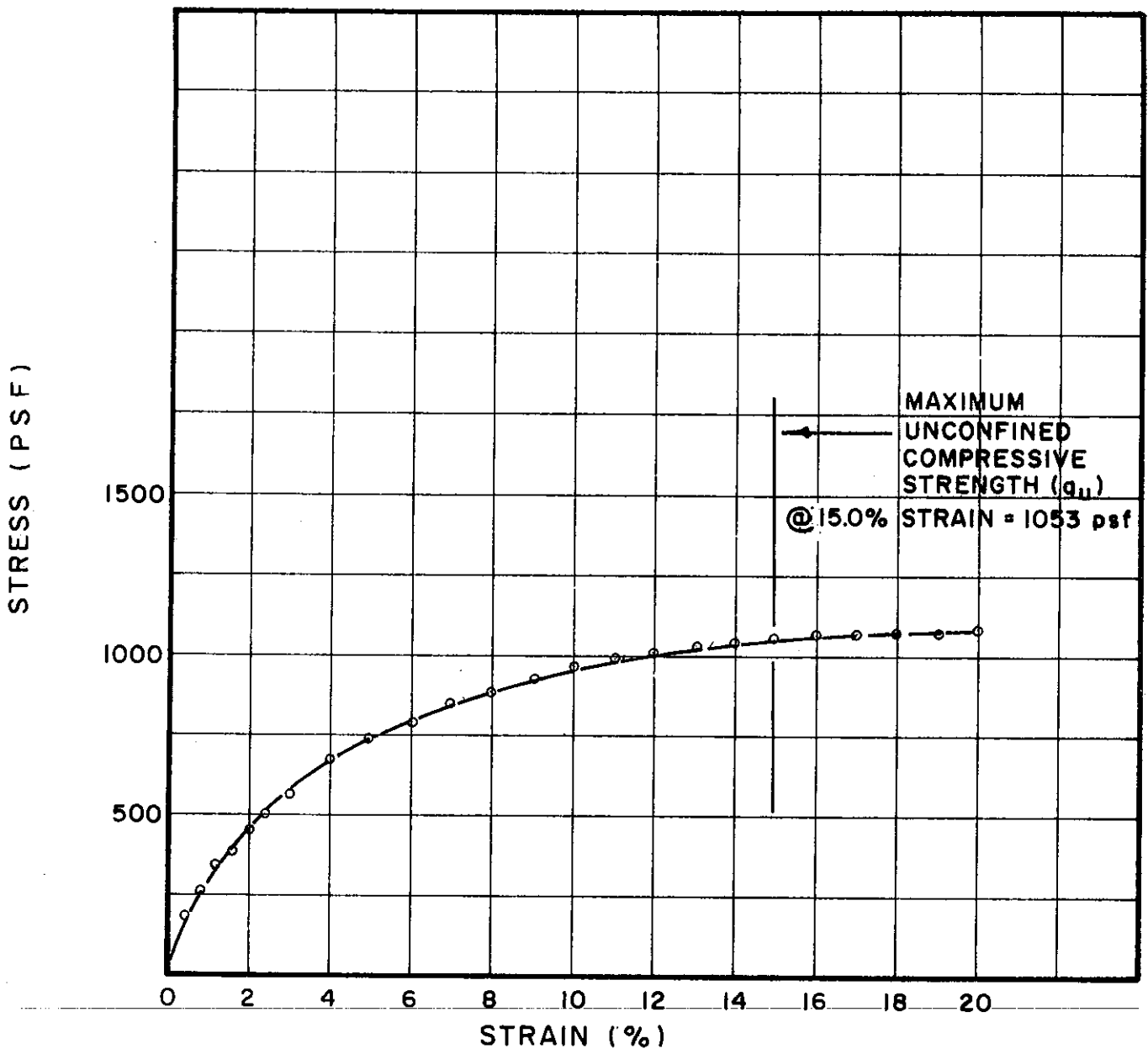

TEST NO.	TEST DATA			WATER CONTENT (%)	DRY UNIT WEIGHT (pcf)	SOIL PROPERTIES		SOIL DESCRIPTION
	DIAMETER (INCHES)	HEIGHT (INCHES)	STRAIN RATE (%/MIN)			ATTERBERG LL (%)	LIMITS PL (%)	
U87.1	1.40	3.25	.25	23.6	99	36	16	SILTY CLAY, SANDY (CL)

BORING NO. 50

SAMPLE NO. 10

DEPTH 49.0' TO 49.3'

UNCONFINED COMPRESSION TESTS

THE DETROIT EDISON COMPANY
BELLE RIVER PLANT UNITS I & II

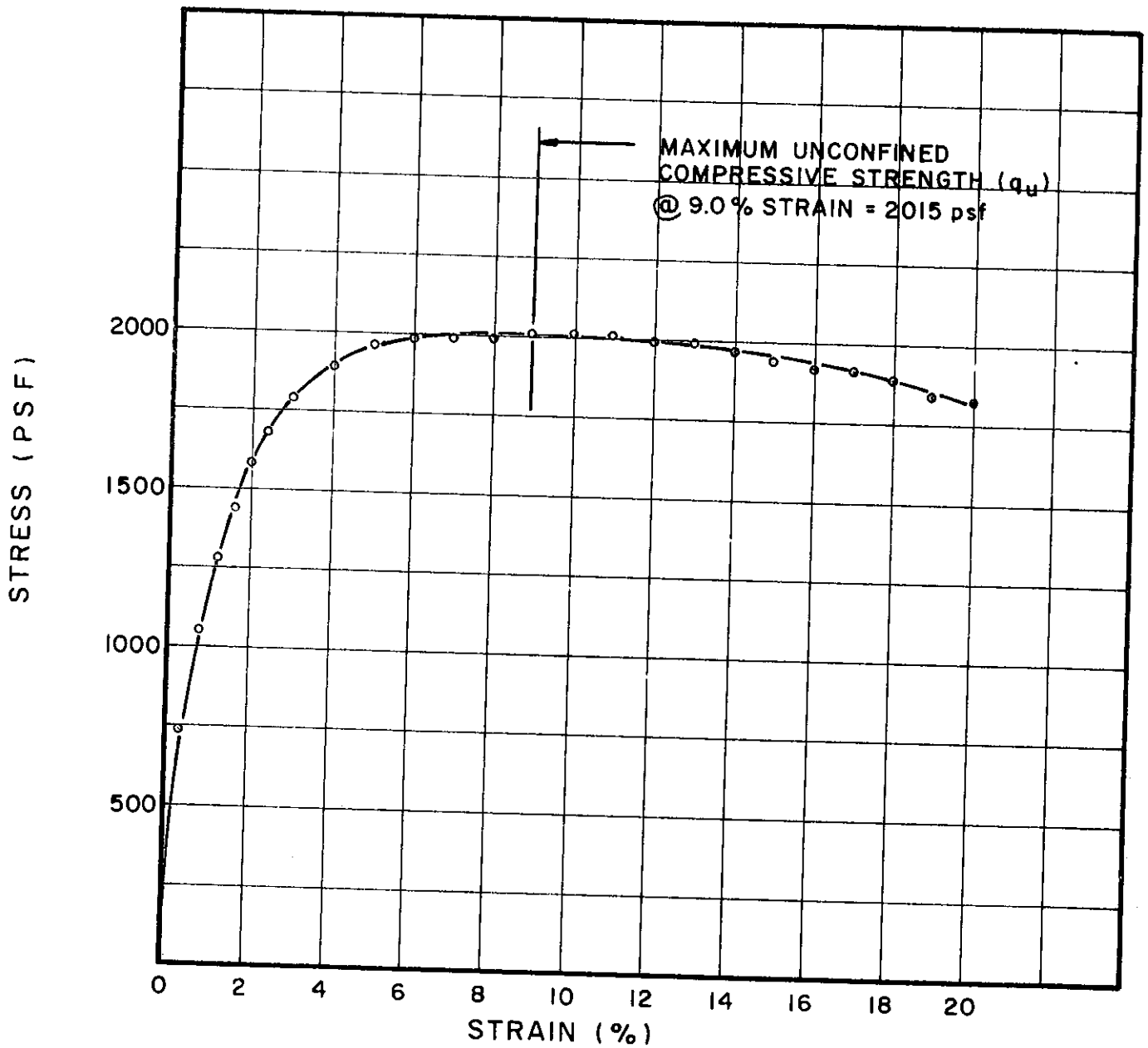

TEST NO.	TEST DATA			SOIL PROPERTIES				
	DIAMETER (INCHES)	HEIGHT (INCHES)	STRAIN RATE (%/MIN)	WATER CONTENT (%)	DRY UNIT WEIGHT (pcf)	ATTERBERG LL (%)	LIMITS PL (%)	SOIL DESCRIPTION
U88.1	1.38	3.20	.25	25.8	99	39	18	SILTY CLAY (CL)

BORING NO. 50

SAMPLE NO. 12

DEPTH 58.6' - 58.9'

UNCONFINED COMPRESSION TESTS

THE DETROIT EDISON COMPANY
BELLE RIVER PLANT UNITS I & II

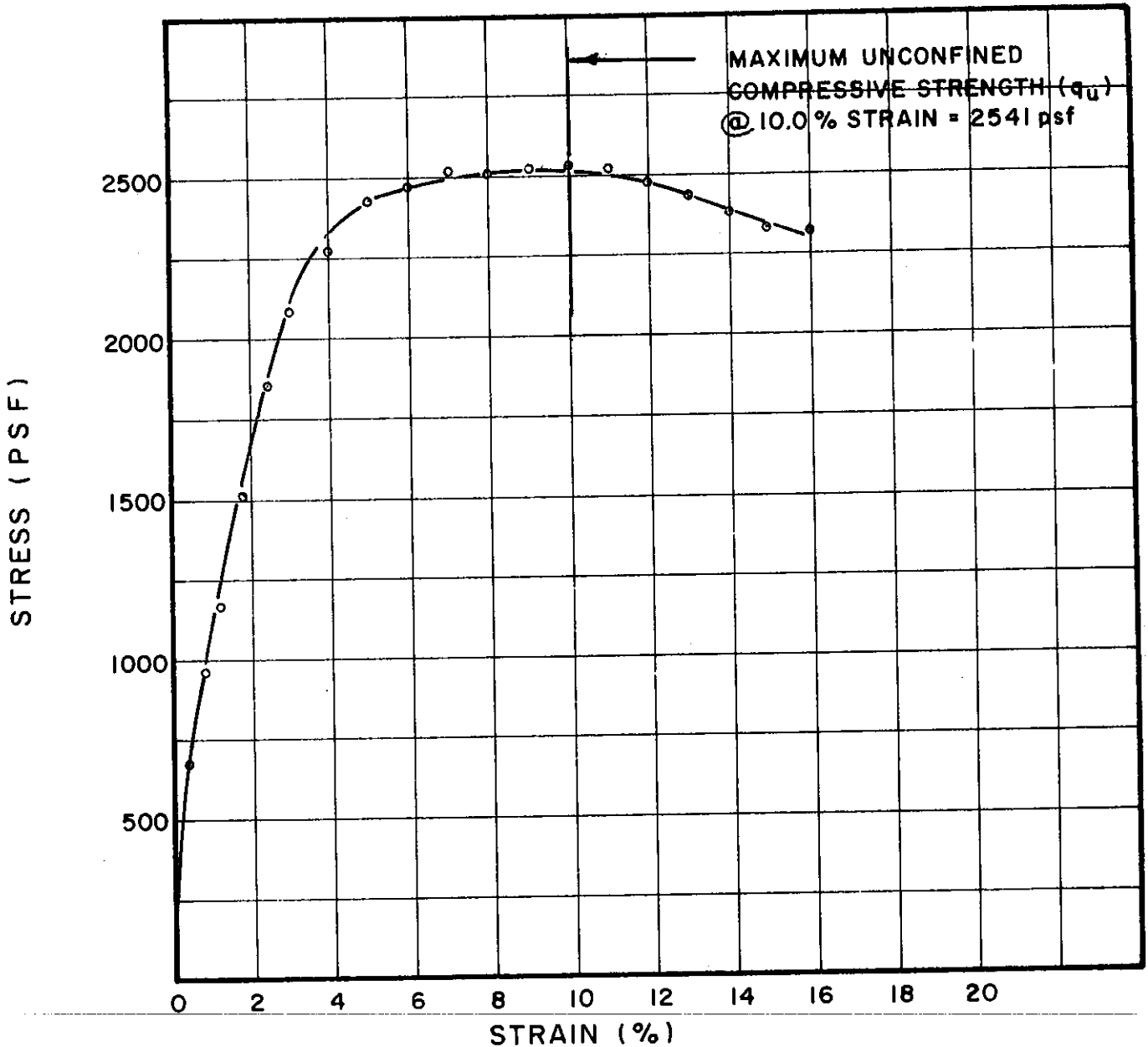

TEST NO.	TEST DATA			SOIL PROPERTIES				
	DIAMETER (INCHES)	HEIGHT (INCHES)	STRAIN RATE (%/MIN)	WATER CONTENT (%)	DRY UNIT WEIGHT (pcf)	ATTERBERG LL (%)	LIMITS PL (%)	SOIL DESCRIPTION
U90.1	1.39	3.20	.25	27.9	95	39	20	SILTY CLAY (CL)

BORING NO. 50

SAMPLE NO. 16

DEPTH 78.6' - 78.9'

UNCONFINED COMPRESSION TESTS

THE DETROIT EDISON COMPANY
BELLE RIVER PLANT UNITS I & II

FILE 1255

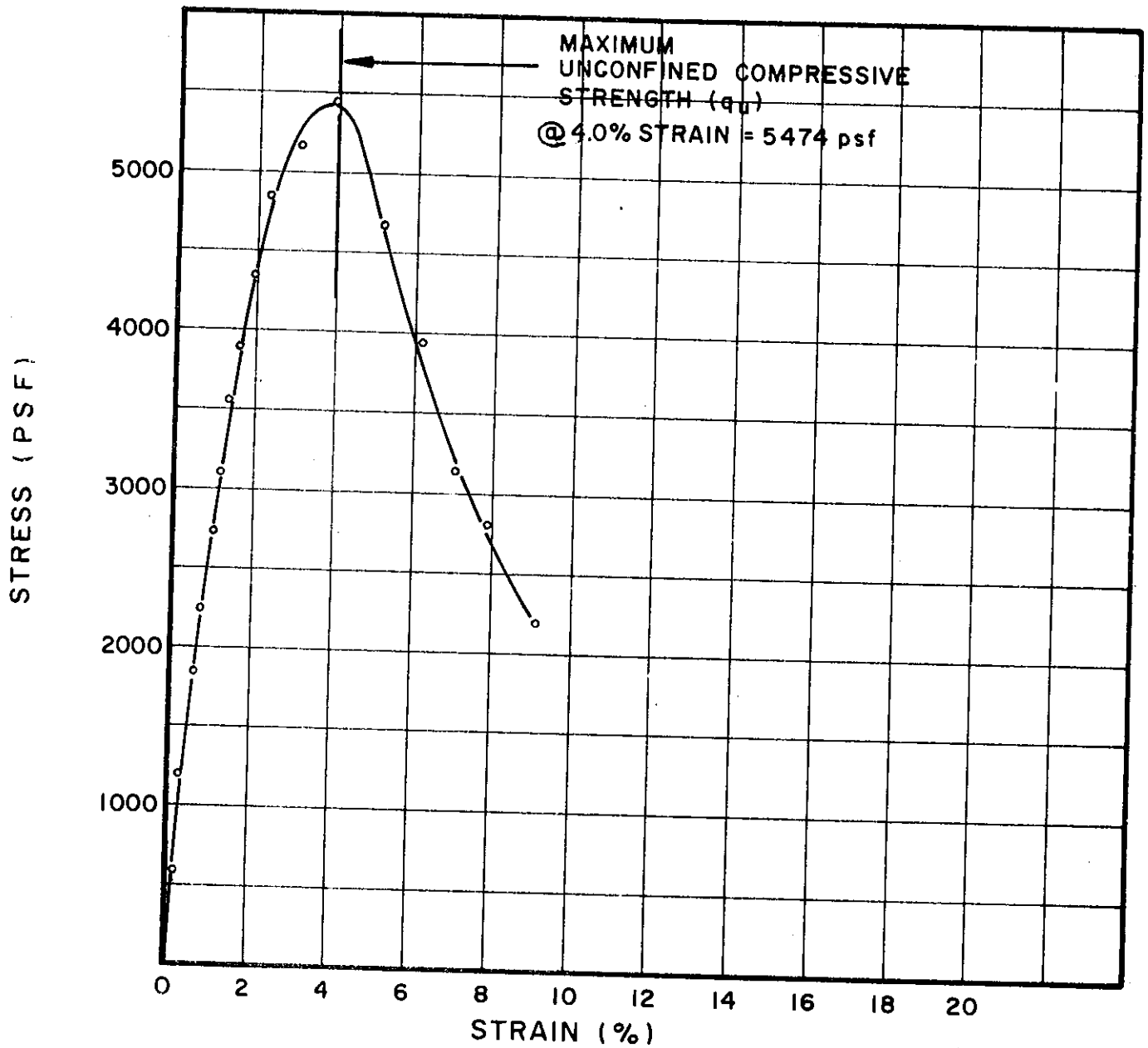

TEST NO.	TEST DATA			SOIL PROPERTIES				
	DIAMETER (INCHES)	HEIGHT (INCHES)	STRAIN RATE (%/MIN)	WATER CONTENT (%)	DRY UNIT WEIGHT (pcf)	ATTERBERG LL (%)	LIMITS PL (%)	SOIL DESCRIPTION
UI08.1	1.37	3.48	.25	30.3	92	49	20	SILTY CLAY (CL-CH)

BORING NO. 52

SAMPLE NO. 3

DEPTH 20.5' - 20.9'

UNCONFINED COMPRESSION TESTS

THE DETROIT EDISON COMPANY
BELLE RIVER PLANT UNITS I & II

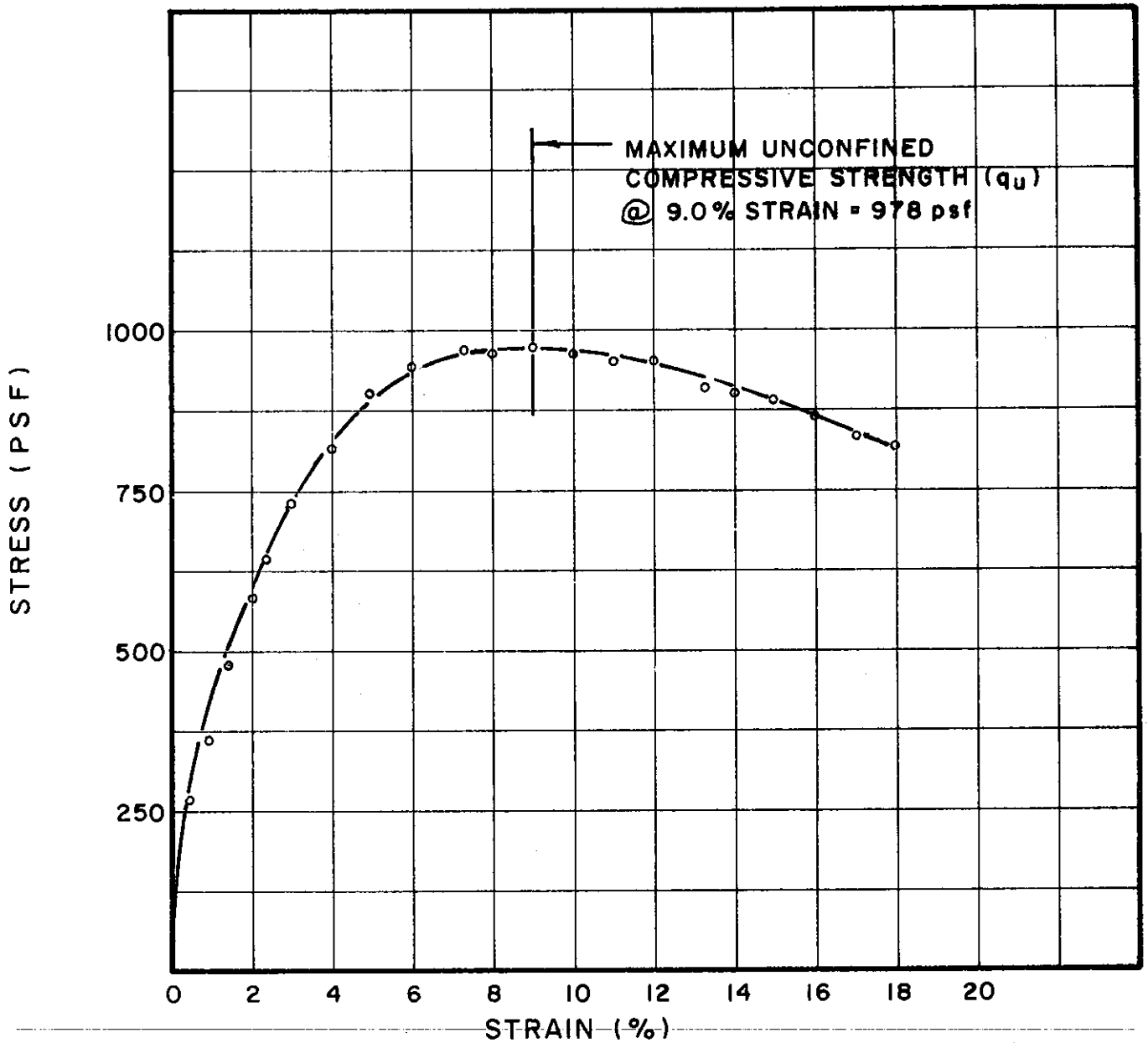

TEST NO.	TEST DATA			SOIL PROPERTIES				
	DIAMETER (INCHES)	HEIGHT (INCHES)	STRAIN RATE (%/MIN)	WATER CONTENT (%)	DRY UNIT WEIGHT (pcf)	ATTERBERG LL (%)	LIMITS PL (%)	SOIL DESCRIPTION
UI09.1	1.37	3.25	.25	31.8	94	35	18	SILTY CLAY (CL)

BORING NO. 52
 SAMPLE NO. 4
 DEPTH 28.6' TO 28.9'

UNCONFINED COMPRESSION TESTS

THE DETROIT EDISON COMPANY
 BELLE RIVER PLANT UNITS I & II

FILE 1255

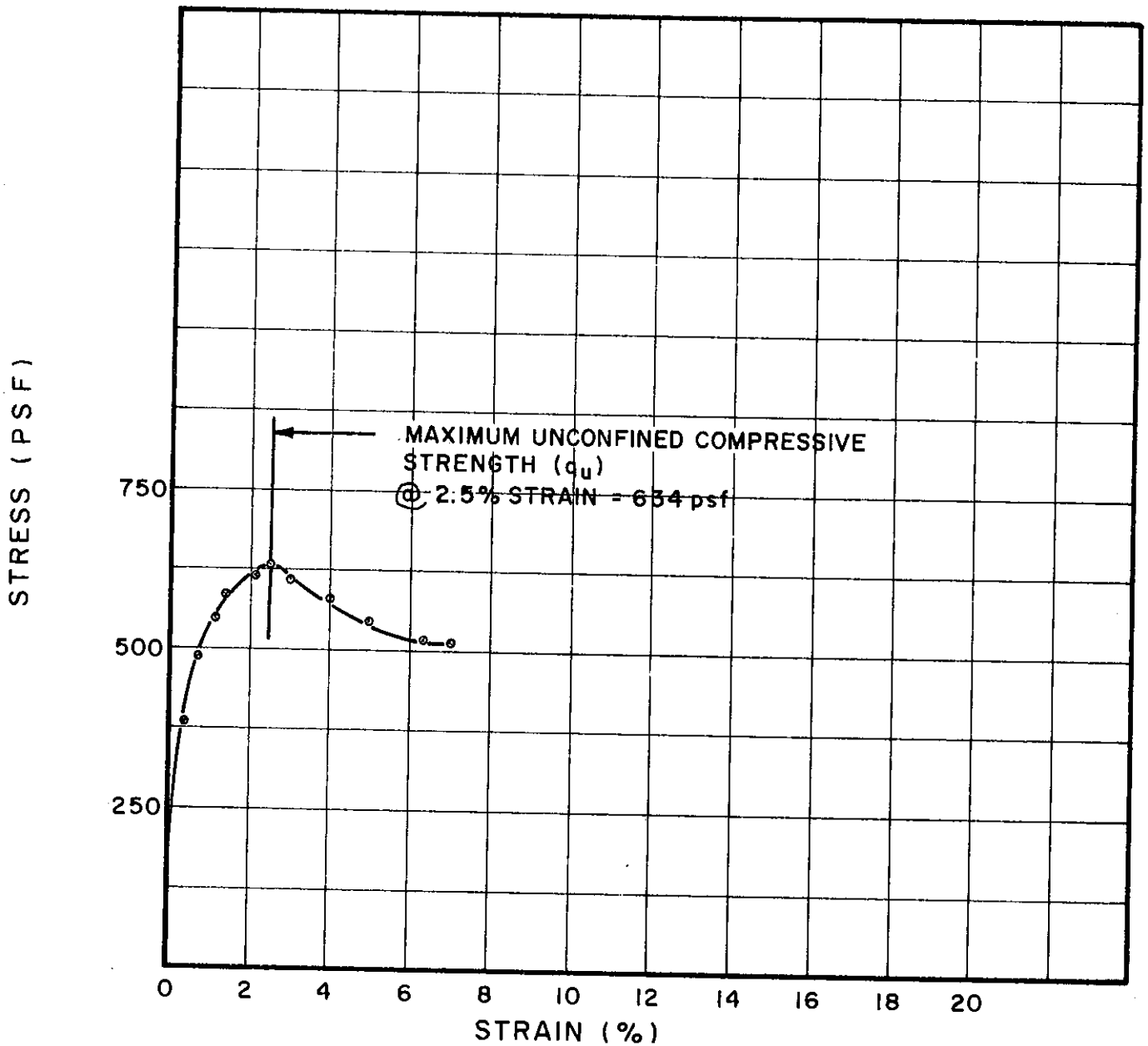

TEST NO.	TEST DATA			SOIL PROPERTIES				
	DIAMETER (INCHES)	HEIGHT (INCHES)	STRAIN RATE (%/MIN)	WATER CONTENT (%)	DRY UNIT WEIGHT (pcf)	ATTERBERG LL (%)	LIMITS PL (%)	SOIL DESCRIPTION
U111.1	1.38	3.02	.29	25.2	100	22	18	SILTY CLAY (CL-ML)

BORING NO. 52

SAMPLE NO. 6

DEPTH 49.2' - 49.5'

UNCONFINED COMPRESSION TESTS

THE DETROIT EDISON COMPANY
BELLE RIVER PLANT UNITS I & II

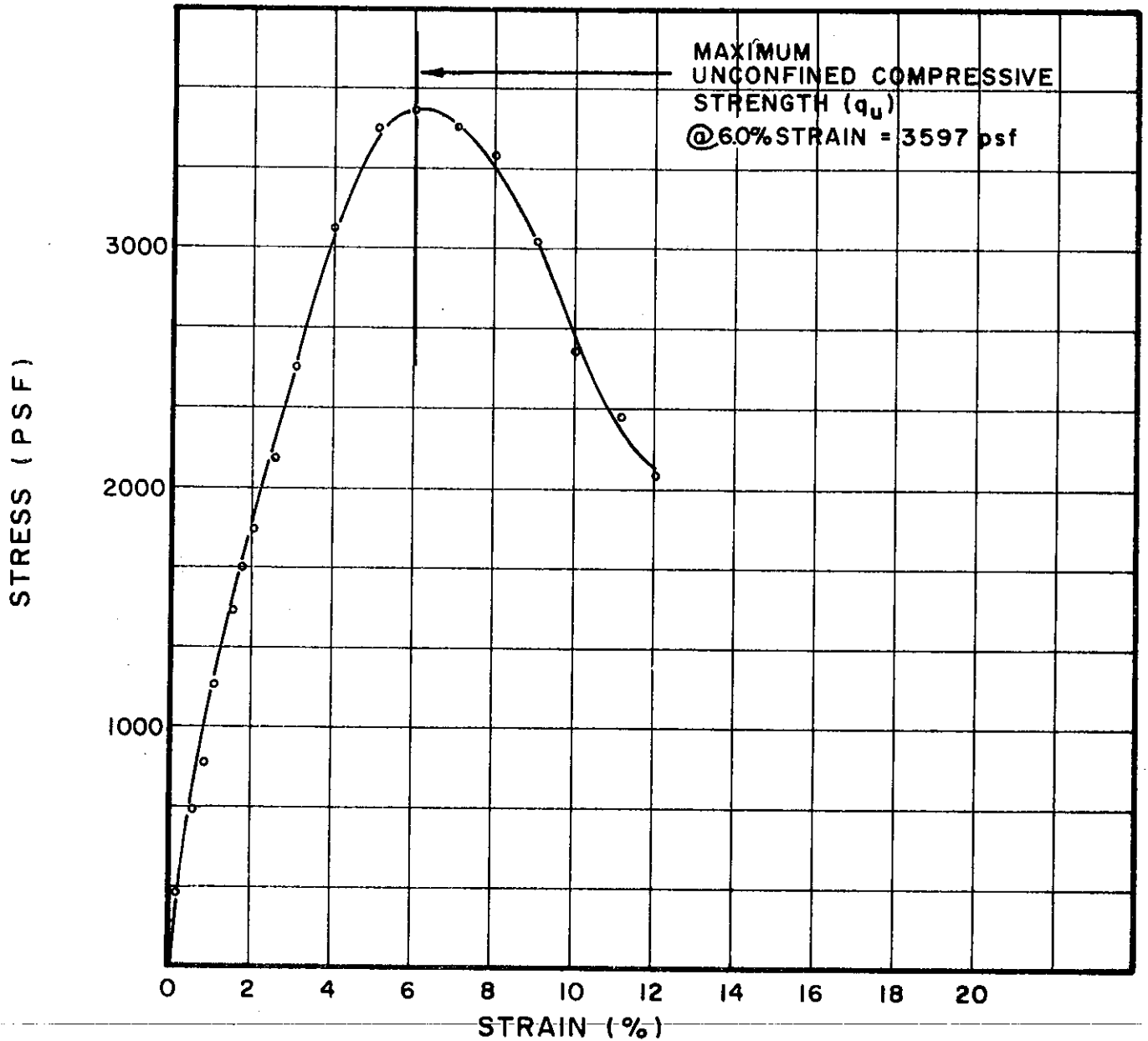

TEST NO.	TEST DATA			WATER CONTENT (%)	DRY UNIT WEIGHT (pcf)	SOIL PROPERTIES		SOIL DESCRIPTION
	DIAMETER (INCHES)	HEIGHT (INCHES)	STRAIN RATE (%/MIN)			ATTERBERG LL (%)	LIMITS PL (%)	
U112.1	1.36	3.37	.25	13.0	116	23	14	SILTY CLAY, SANDY
								(CL)

BORING NO. 52

SAMPLE NO. 7

DEPTH 59.0' - 59.3'

UNCONFINED COMPRESSION TESTS

THE DETROIT EDISON COMPANY
BELLE RIVER PLANT UNITS I & II

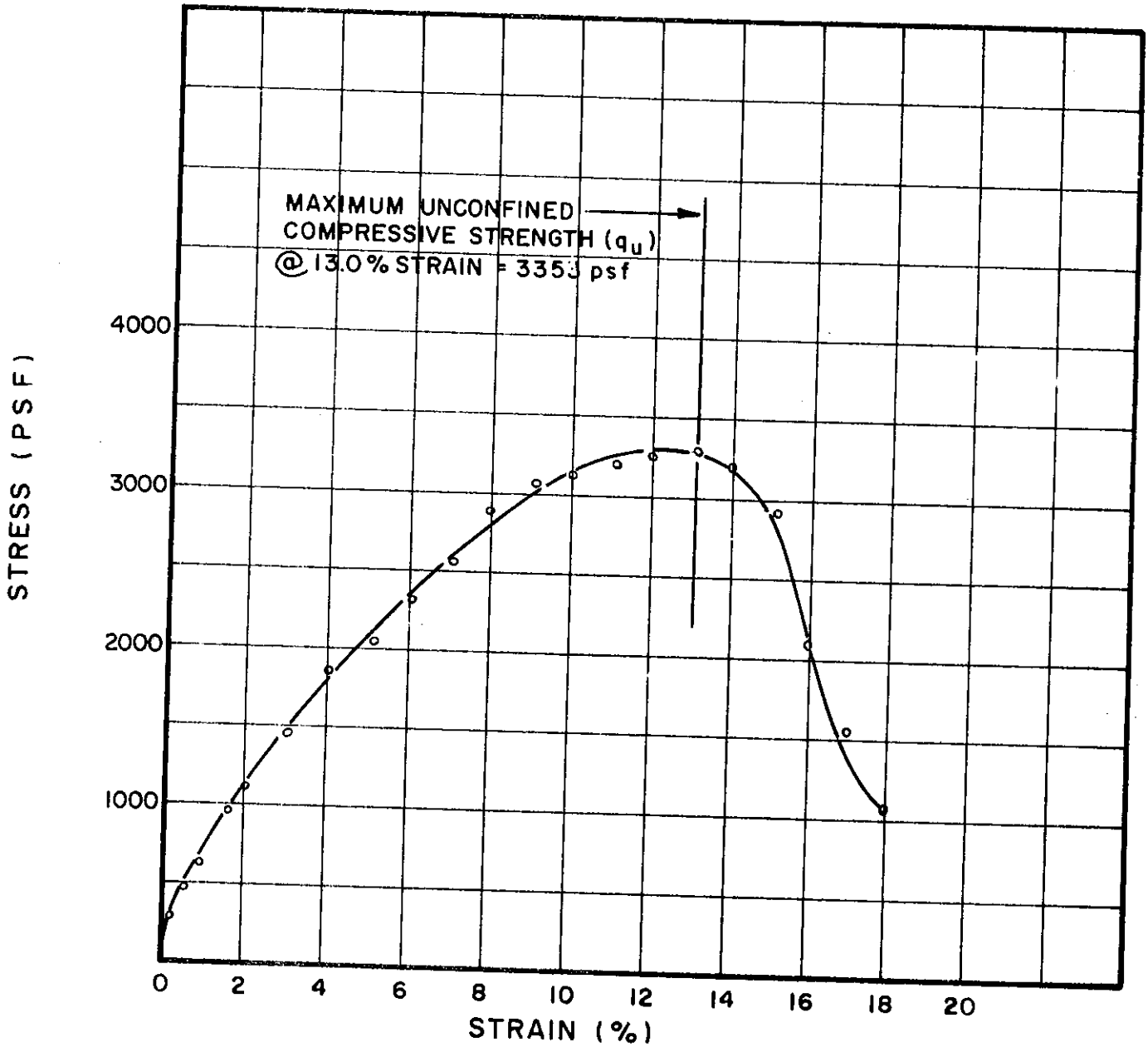

TEST NO.	TEST DATA			SOIL PROPERTIES				SOIL DESCRIPTION
	DIAMETER (INCHES)	HEIGHT (INCHES)	STRAIN RATE (%/MIN)	WATER CONTENT (%)	UNIT WEIGHT (pcf)	ATTERBERG LL (%)	LIMITS PL (%)	
U113.1	1.34	3.50	.25	14.2	115	24	14	SILTY CLAY, SANDY (CL)

BORING NO. 52
 SAMPLE NO. 8
 DEPTH 68.2' TO 68.5'

UNCONFINED COMPRESSION TESTS

THE DETROIT EDISON COMPANY
 BELLE RIVER PLANT UNITS I & II

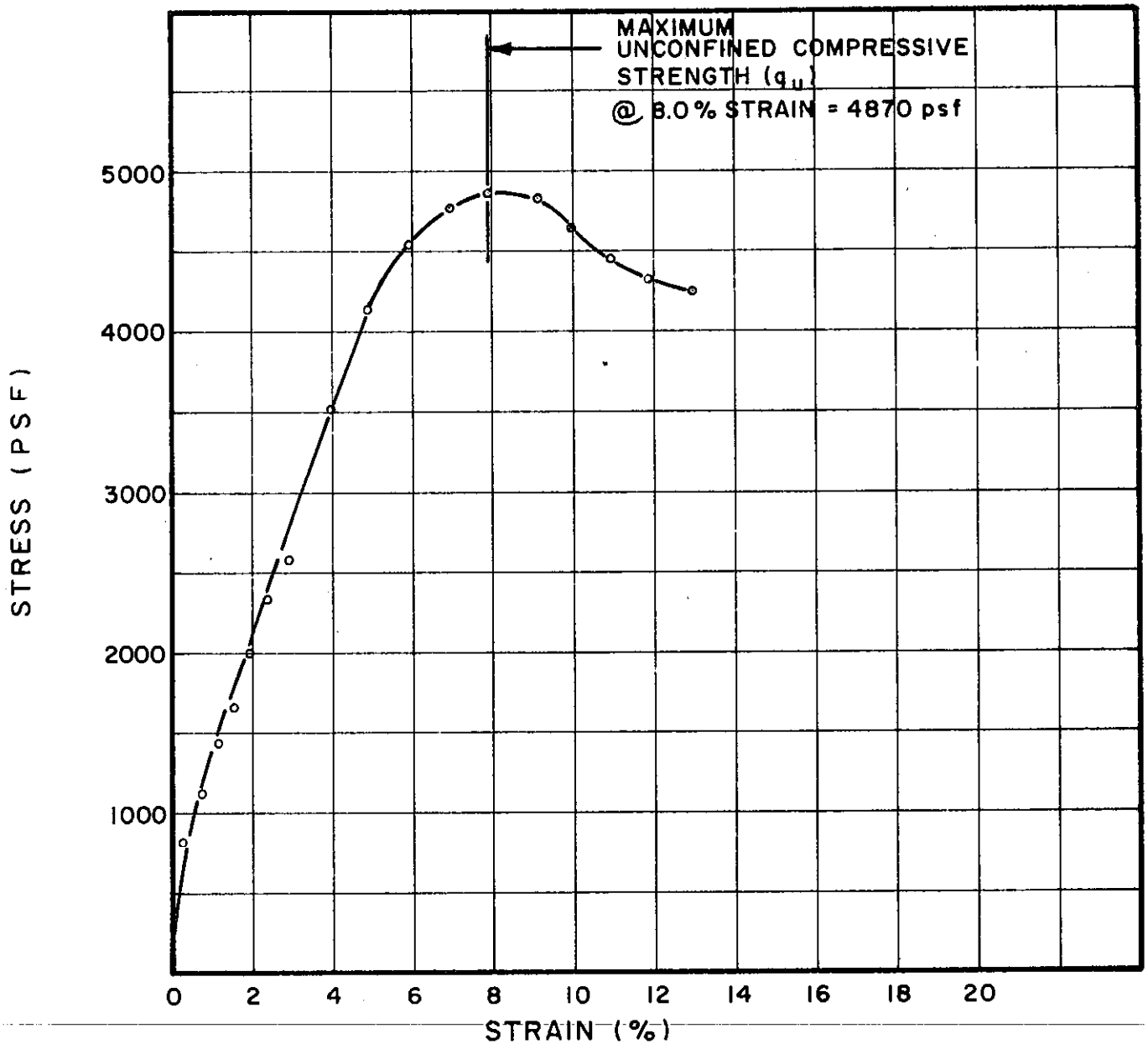

TEST NO.	TEST DATA			WATER CONTENT (%)	DRY UNIT WEIGHT (pcf)	SOIL PROPERTIES		SOIL DESCRIPTION
	DIAMETER (INCHES)	HEIGHT (INCHES)	STRAIN RATE (%/MIN)			ATTERBERG LL (%)	LIMITS PL (%)	
U115.1	1.39	3.27	.28	27.2	97	39	18	SILTY CLAY, SANDY (CL)

BORING NO. 52
 SAMPLE NO. 10
 DEPTH 88.6' - 88.9'

UNCONFINED COMPRESSION TESTS

THE DETROIT EDISON COMPANY
 BELLE RIVER PLANT UNITS I & II

FILE 1255

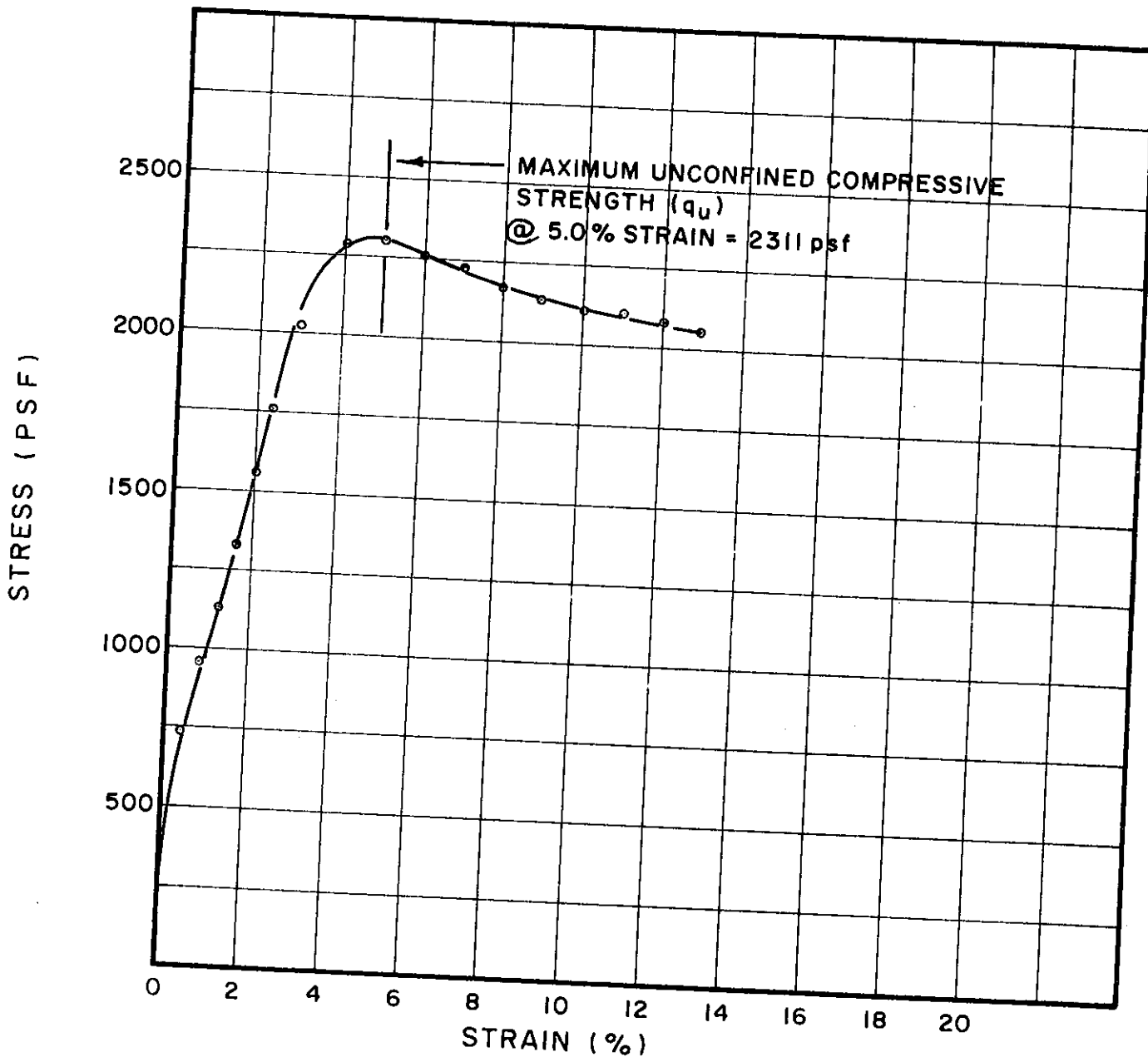

TEST NO.	TEST DATA			SOIL PROPERTIES				SOIL DESCRIPTION
	DIAMETER (INCHES)	HEIGHT (INCHES)	STRAIN RATE (%/MIN)	WATER CONTENT (%)	DRY UNIT WEIGHT (pcf)	ATTERBERG LL (%)	LIMITS PL (%)	
U96.1	1.40	3.20	.25	31.8	88	49	20	SILTY CLAY (CL-CH)

BORING NO. 53
 SAMPLE NO. 3
 DEPTH 19.6' TO 19.9'

UNCONFINED COMPRESSION TESTS

THE DETROIT EDISON COMPANY
 BELLE RIVER PLANT UNITS I & II

GOLDBERG-ZOINO & ASSOCIATES, INC.
 SOIL AND FOUNDATION ENGINEERS

FILE 1255

C-307

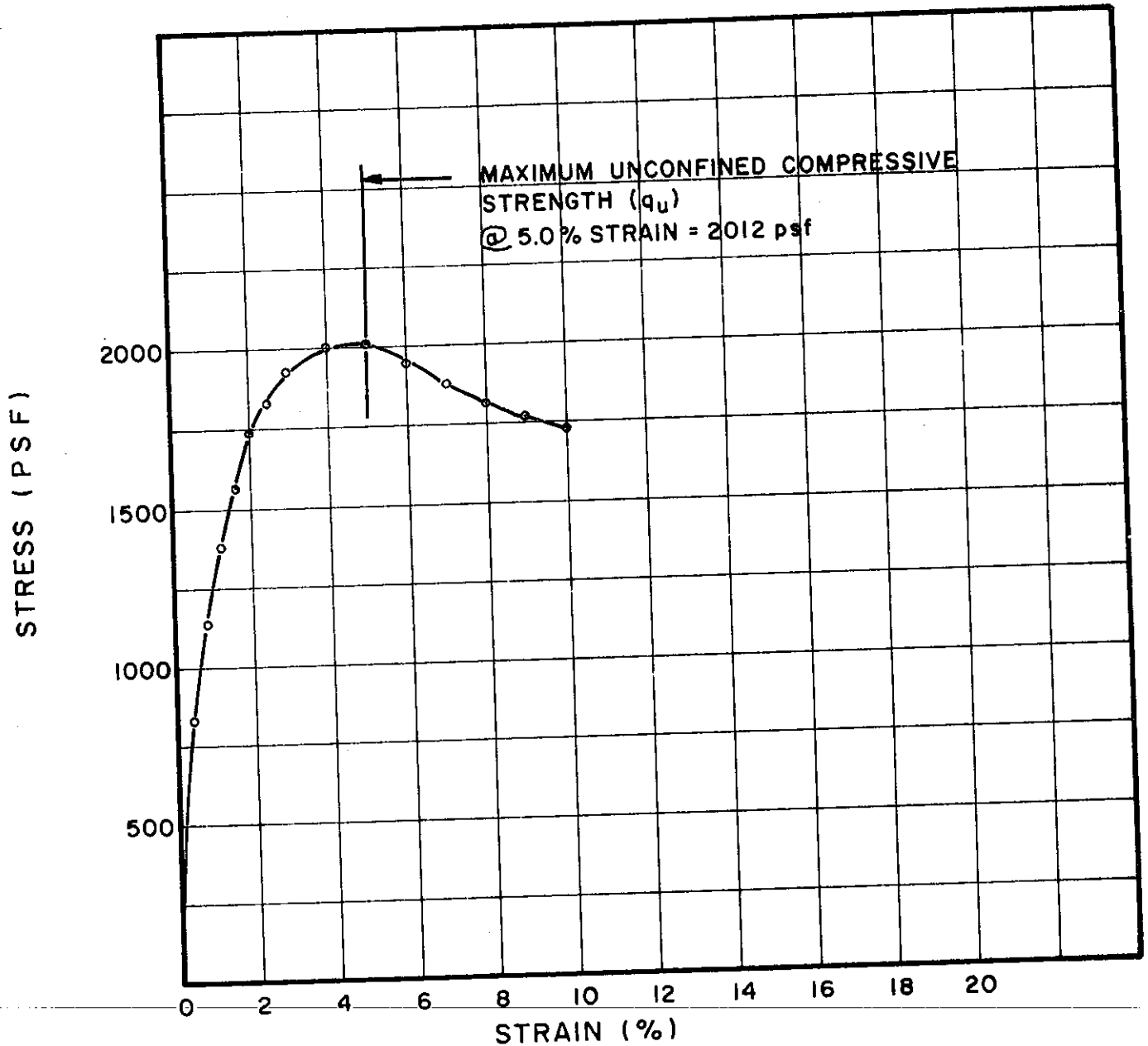

TEST NO.	TEST DATA			SOIL PROPERTIES				
	DIAMETER (INCHES)	HEIGHT (INCHES)	STRAIN RATE (%/MIN)	WATER CONTENT (%)	DRY UNIT WEIGHT (pcf)	ATTERBERG LL (%)	LIMITS PL (%)	SOIL DESCRIPTION
U97.1	1.38	3.24	.25	40.7	80	49	22	SILTY CLAY (CL-CH)

BORING NO. 53

SAMPLE NO. 4

DEPTH 29.6' - 29.9'

UNCONFINED COMPRESSION TESTS

THE DETROIT EDISON COMPANY
BELLE RIVER PLANT UNITS I & II

FILE 1255

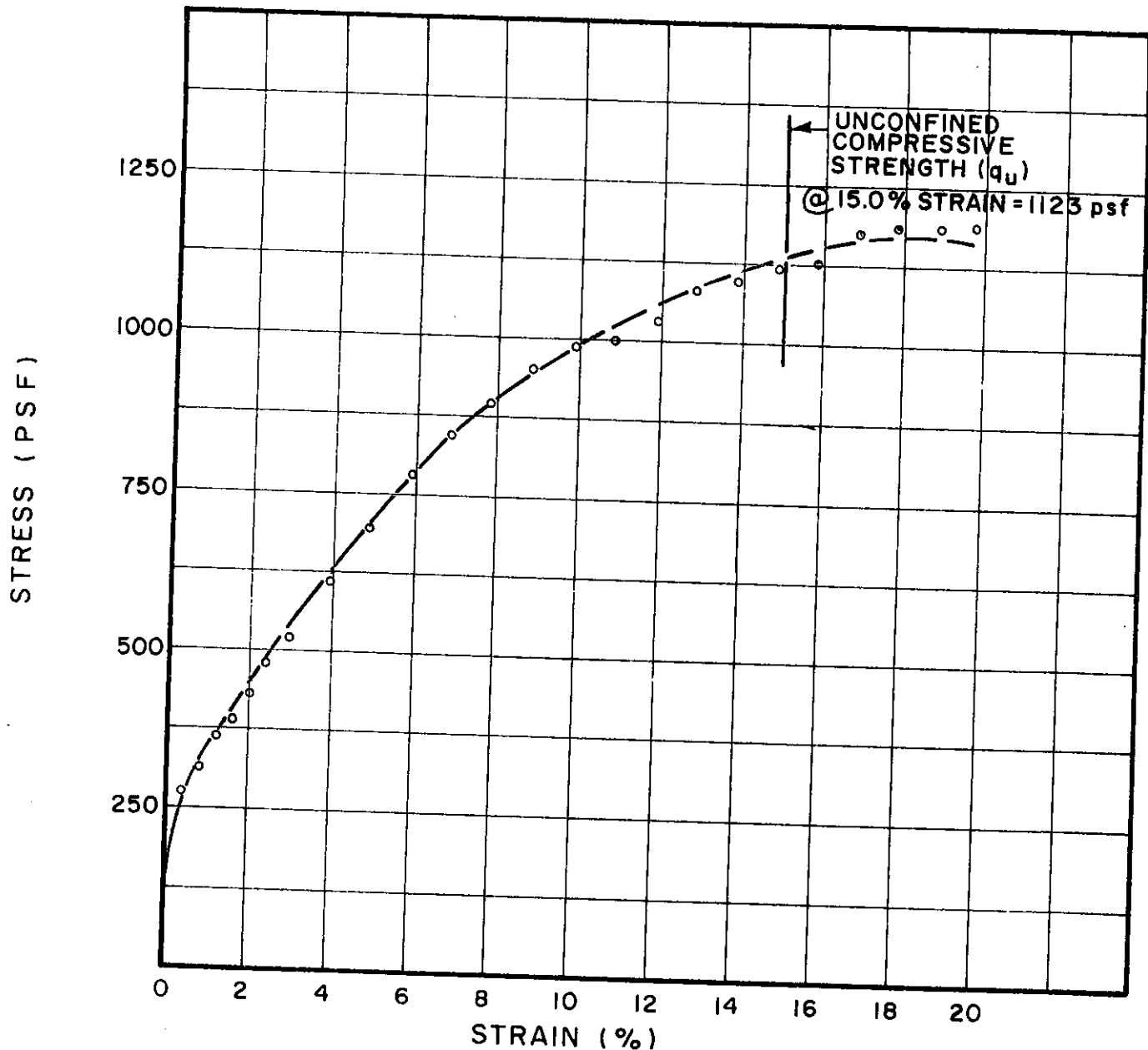

TEST NO.	TEST DATA			SOIL PROPERTIES				
	DIAMETER (INCHES)	HEIGHT (INCHES)	STRAIN RATE (%/MIN)	WATER CONTENT (%)	DRY UNIT WEIGHT (pcf)	ATTERBERG LL (%)	LIMITS PL (%)	SOIL DESCRIPTION
U99.1	1.37	3.17	.25	27.9	94	43	18	SILTY CLAY (CL)

BORING NO. 53

SAMPLE NO. 6

DEPTH 49.2' TO 49.5'

UNCONFINED COMPRESSION TESTS

THE DETROIT EDISON COMPANY
BELLE RIVER PLANT UNITS I & II

FILE 1255

C-309

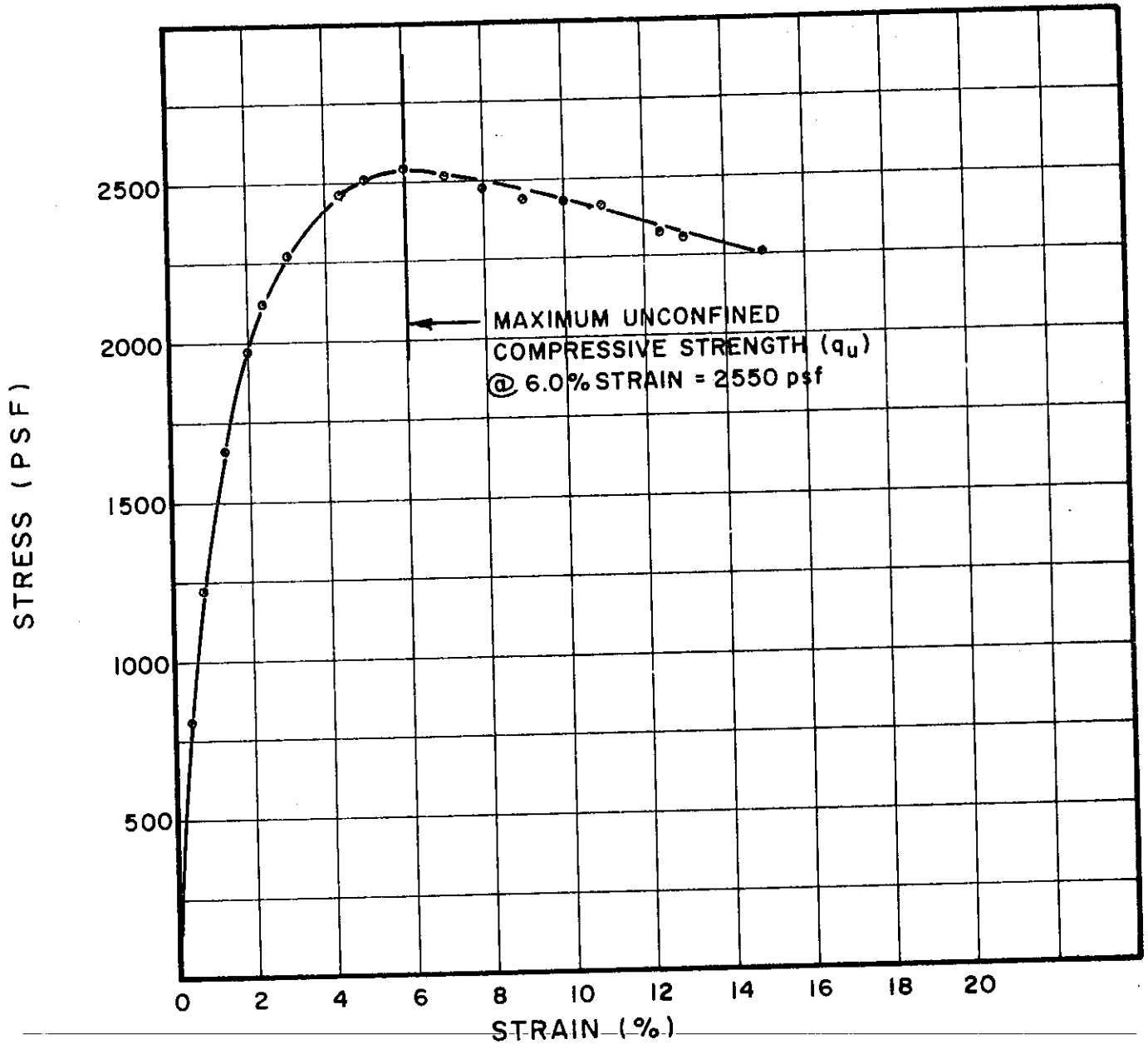

TEST NO.	TEST DATA			SOIL PROPERTIES				SOIL DESCRIPTION
	DIAMETER (INCHES)	HEIGHT (INCHES)	STRAIN RATE (%/MIN)	WATER CONTENT (%)	DRY UNIT WEIGHT (pcf)	ATTERBERG LL (%)	LIMITS PL (%)	
U101.1	1.40	3.20	.25	27.9	95	39	21	SILTY CLAY (CL)

BORING NO. 53
 SAMPLE NO. 9
 DEPTH 80.1' - 80.4'

UNCONFINED COMPRESSION TESTS

THE DETROIT EDISON COMPANY
 BELLE RIVER PLANT UNITS I & II

FILE 1255

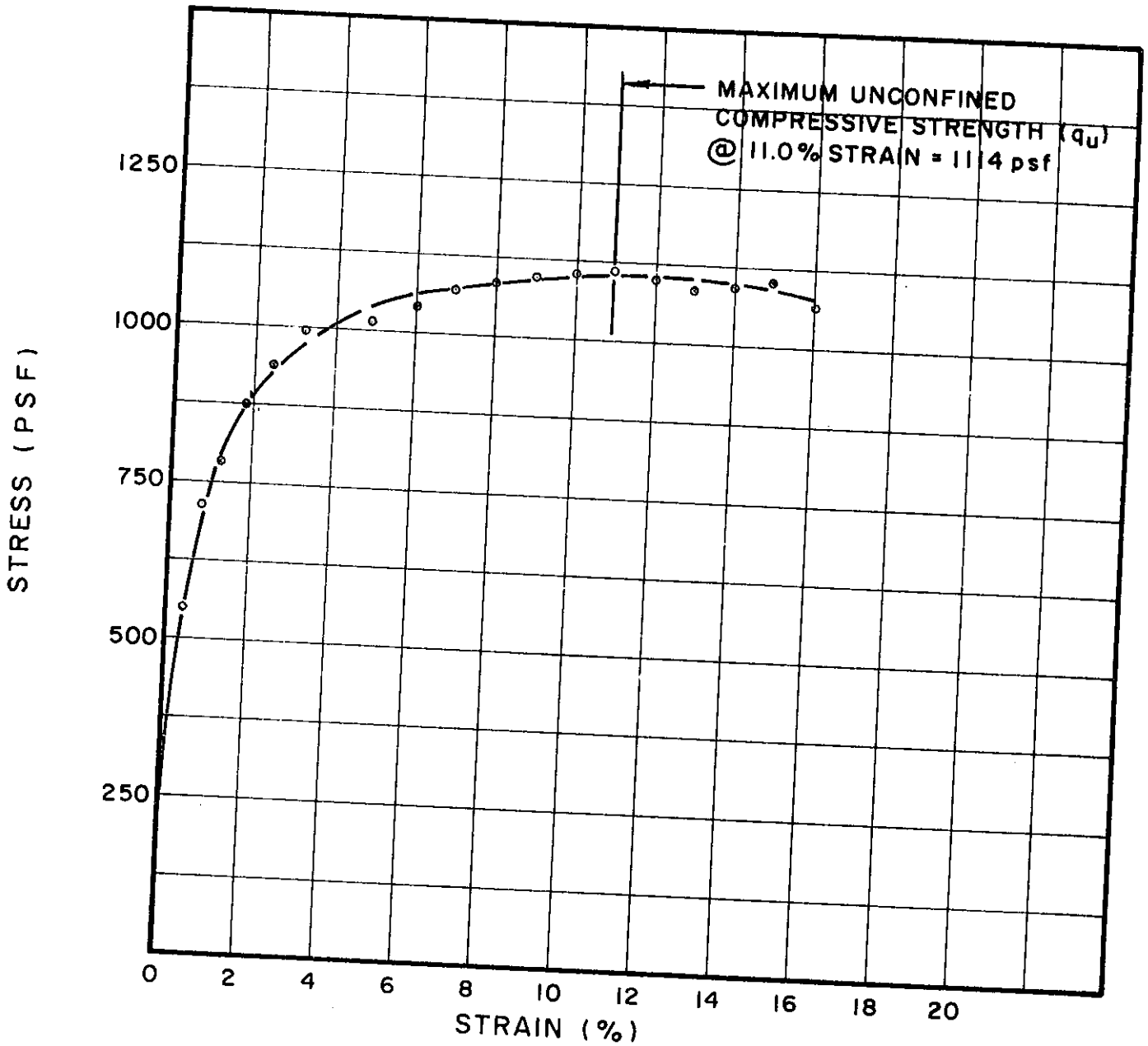

TEST NO.	TEST DATA			WATER CONTENT (%)	DRY UNIT WEIGHT (pcf)	SOIL PROPERTIES		SOIL DESCRIPTION
	DIAMETER (INCHES)	HEIGHT (INCHES)	STRAIN RATE (%/MIN)			ATTERBERG LL (%)	LIMITS PL (%)	
U398.1	1.38	3.25	.25	25.8	99	38	17	SILTY CLAY, SANDY (CL)

BORING NO. 54
 SAMPLE NO. 5
 DEPTH 59.3' TO 59.6'

UNCONFINED COMPRESSION TESTS

THE DETROIT EDISON COMPANY
 BELLE RIVER PLANT UNITS I & II

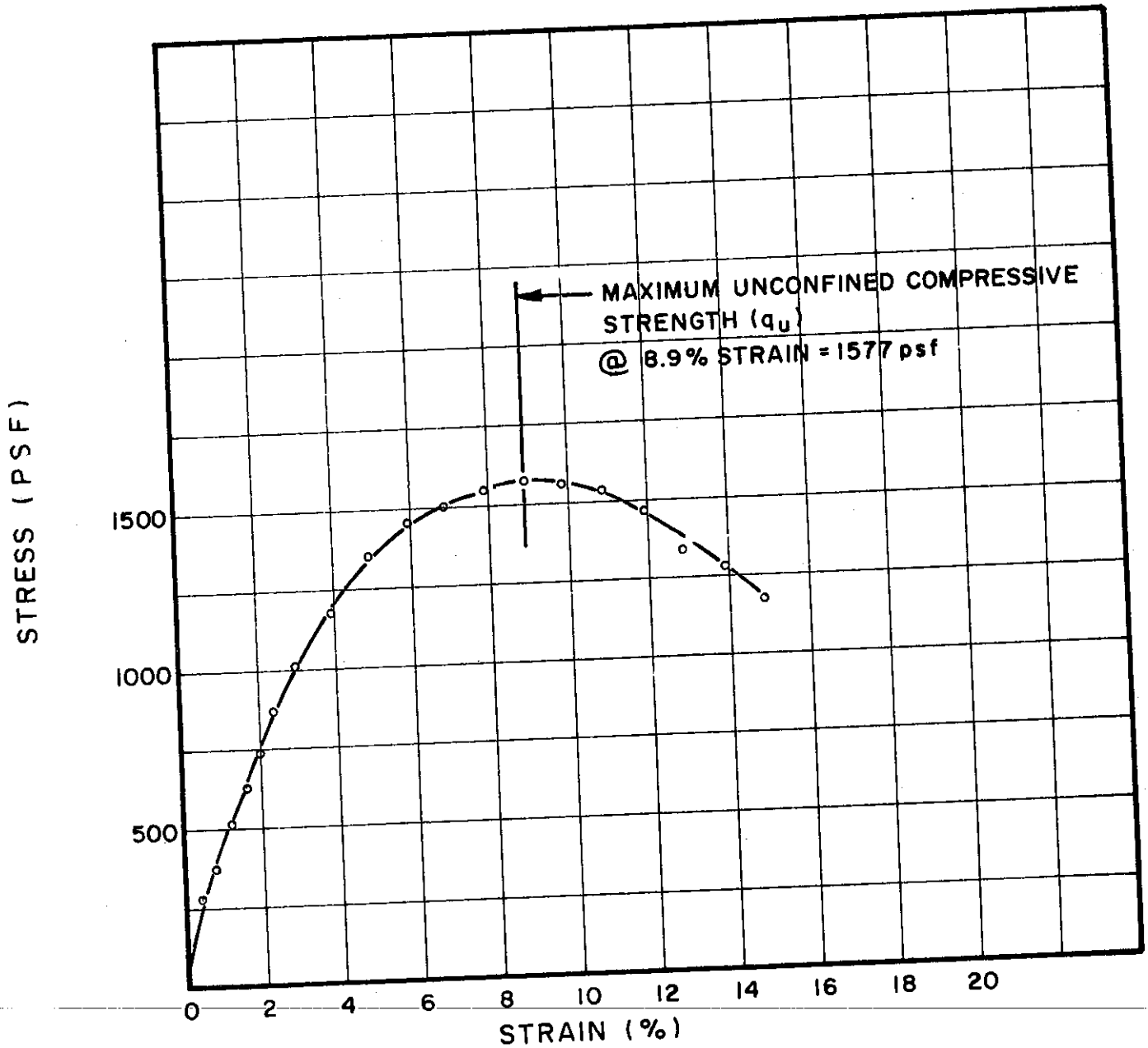

TEST NO.	TEST DATA			WATER CONTENT (%)	DRY UNIT WEIGHT (pcf)	SOIL PROPERTIES		SOIL DESCRIPTION
	DIAMETER (INCHES)	HEIGHT (INCHES)	STRAIN RATE (%/MIN)			ATTERBERG LL (%)	LIMITS PL (%)	
U400.1	1.39	3.17	.25	25.9	98	37	18	SILTY CLAY, SANDY (CL)

BORING NO. 54
 SAMPLE NO. 7
 DEPTH 68.5' TO 68.8'

UNCONFINED COMPRESSION TESTS

THE DETROIT EDISON COMPANY
 BELLE RIVER PLANT UNITS I & II

FILE 1255

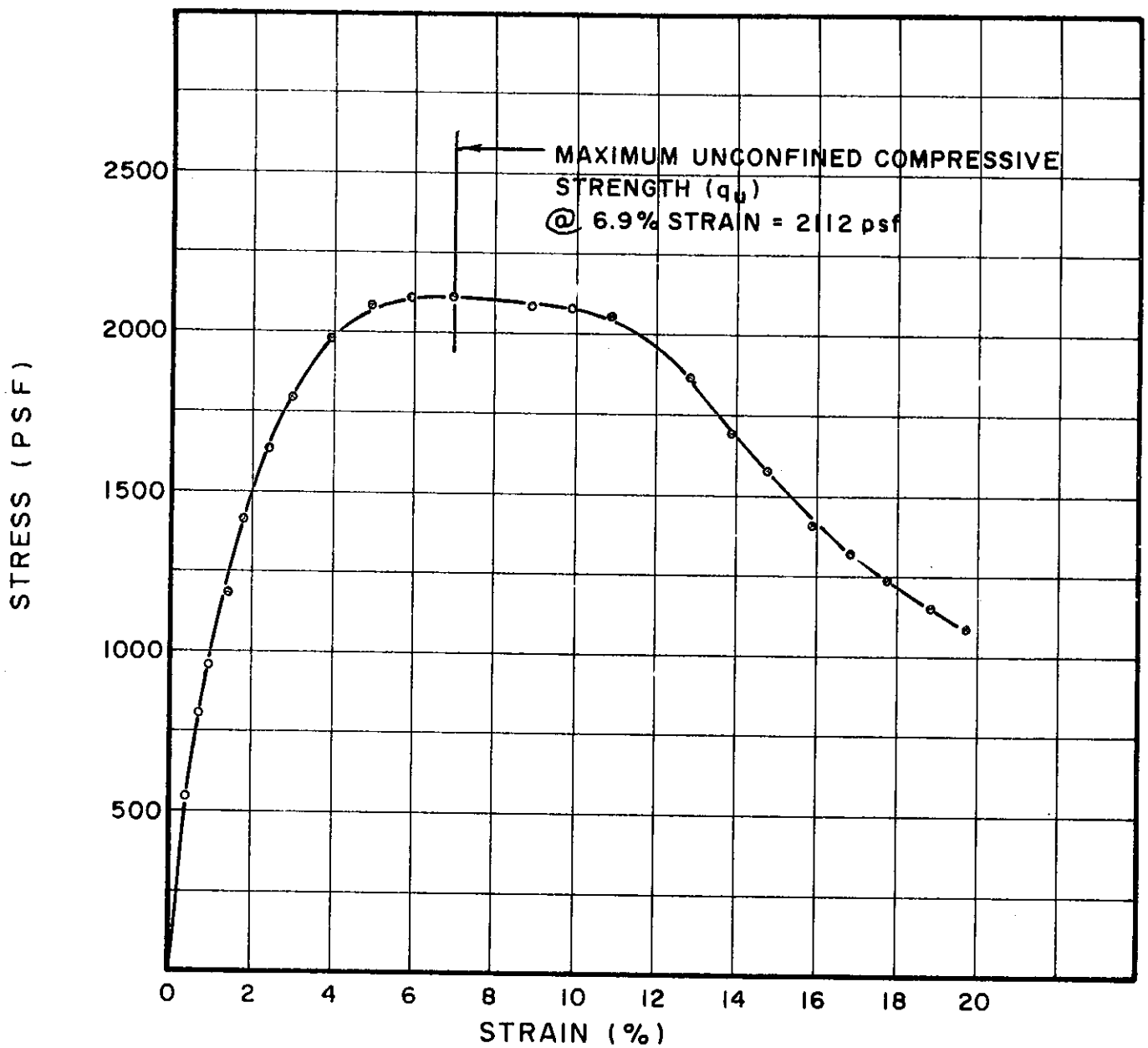

TEST NO.	TEST DATA			WATER CONTENT (%)	DRY UNIT WEIGHT (pcf)	SOIL PROPERTIES		SOIL DESCRIPTION
	DIAMETER (INCHES)	HEIGHT (INCHES)	STRAIN RATE (%/MIN)			ATTERBERG LL (%)	LIMITS PL (%)	
U76.1	1.38	3.22	.25	32.8	90	48	20	SILTY CLAY (CL-CH)

BORING NO. 59
 SAMPLE NO. 3
 DEPTH 18.8' TO 19.1'

UNCONFINED COMPRESSION TESTS

THE DETROIT EDISON COMPANY
 BELLE RIVER PLANT UNITS I & II

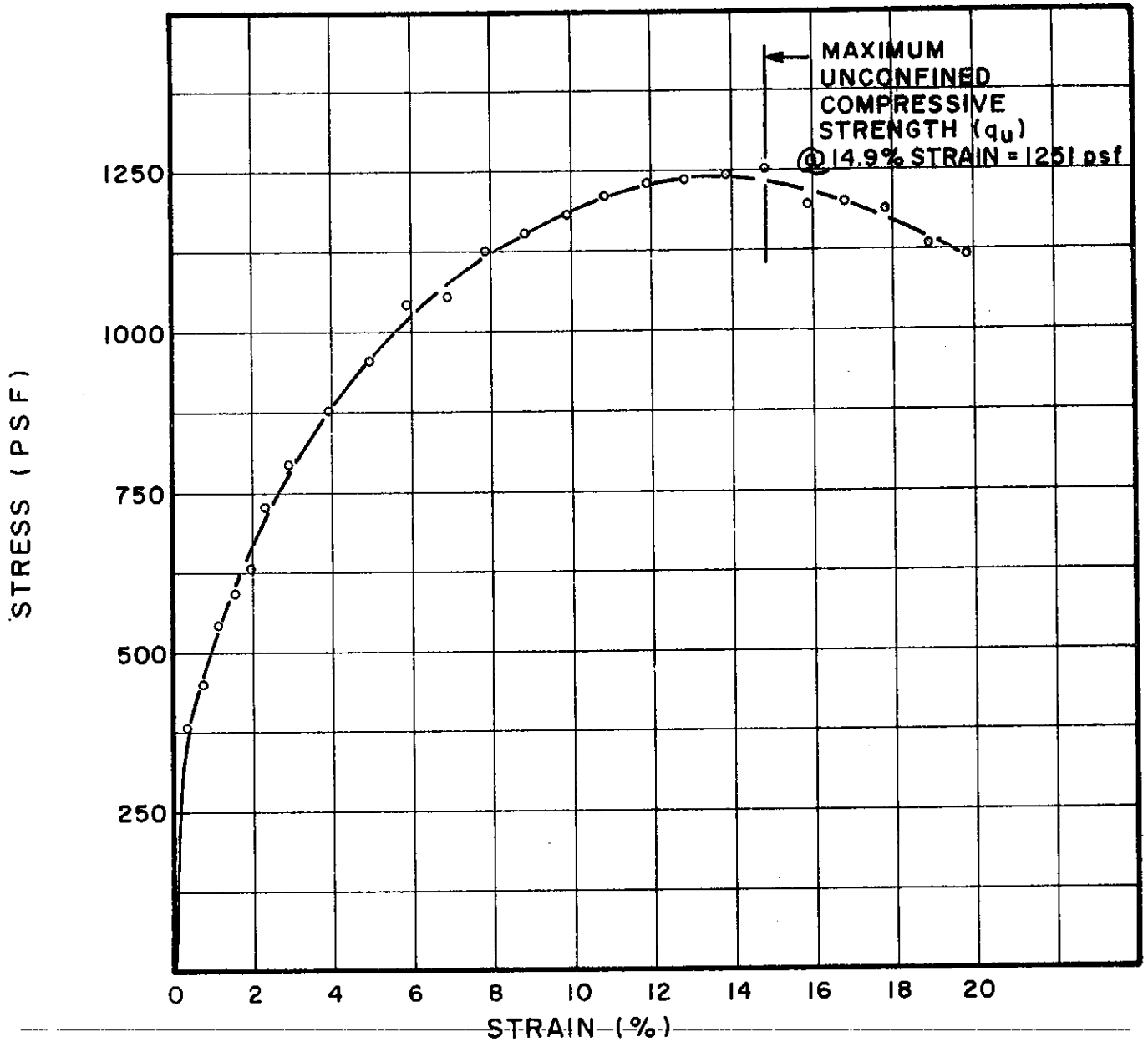

TEST NO.	TEST DATA			SOIL PROPERTIES				
	DIAMETER (INCHES)	HEIGHT (INCHES)	STRAIN RATE (%/MIN)	WATER CONTENT (%)	DRY UNIT WEIGHT (pcf)	ATTERBERG LL (%)	LIMITS PL (%)	SOIL DESCRIPTION
U78.1	1.38	3.27	.25	26.2	99	38	18	SILTY CLAY, SANDY (CL)

BORING NO. 59

SAMPLE NO. 5

DEPTH 38.7' TO 39.0'

UNCONFINED COMPRESSION TESTS

THE DETROIT EDISON COMPANY
BELLE RIVER PLANT UNITS I & II

FILE 1255

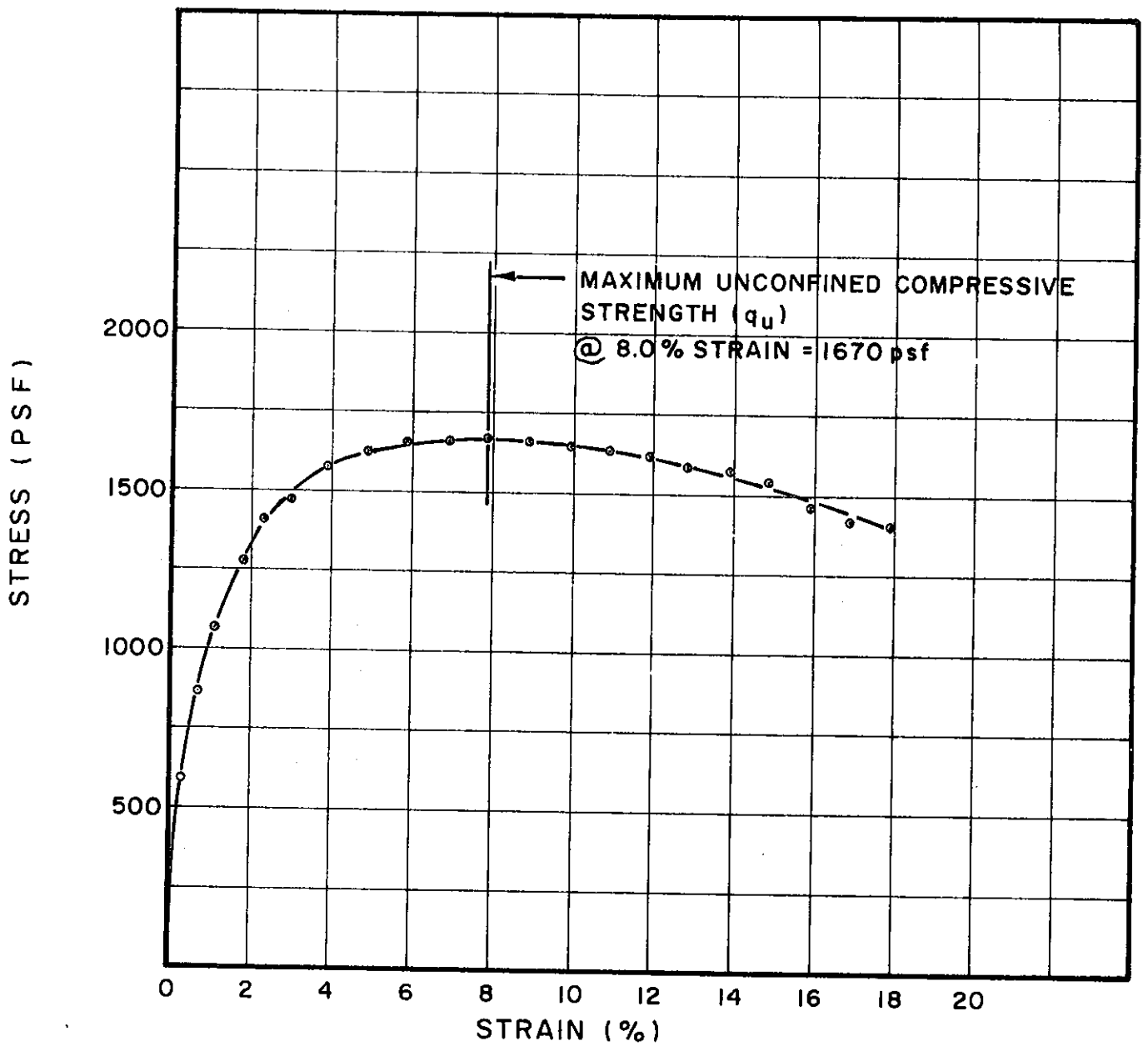

TEST NO.	TEST DATA			SOIL PROPERTIES				
	DIAMETER (INCHES)	HEIGHT (INCHES)	STRAIN RATE (%/MIN)	WATER CONTENT (%)	DRY UNIT WEIGHT (pcf)	ATTERBERG LL (%)	LIMITS PL (%)	SOIL DESCRIPTION
U80.1	1.38	3.26	.25	26.3	98	36	18	SILTY CLAY, SANDY (CL)

BORING NO. 59

SAMPLE NO. 7

DEPTH 58.6' TO 58.9'

UNCONFINED COMPRESSION TESTS

THE DETROIT EDISON COMPANY
BELLE RIVER PLANT UNITS I & II

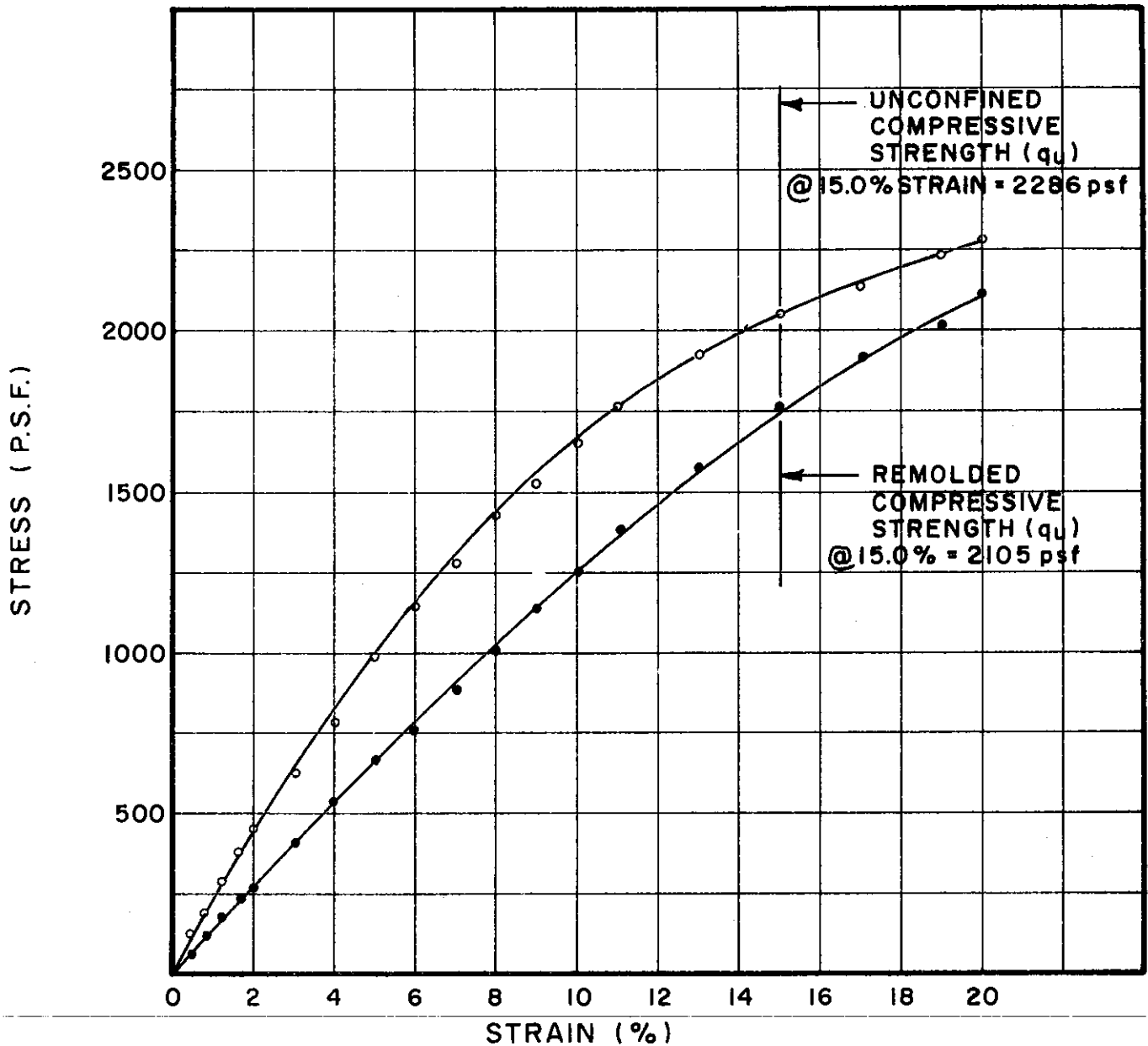

TEST NO.	TEST DATA			SOIL PROPERTIES				
	DIAMETER (INCHES)	HEIGHT (INCHES)	STRAIN RATE (%/MIN)	WATER CONTENT (%)	UNIT WEIGHT (pcf)	ATTERBERG LL (%)	LIMITS PL (%)	SOIL DESCRIPTION
U43.1	1.40	2.85	.316	24.3	105	39	21	SILTY CLAY (CL)
U _R 43.1	1.44	2.70	.333	24.3	103	39	21	SILTY CLAY (CL)

BORING NO. 60

SAMPLE NO. 3

DEPTH 17.6' TO 18.0'

UNCONFINED COMPRESSION TESTS

THE DETROIT EDISON COMPANY
BELLE RIVER PLANT UNITS I & II

FILE 1255

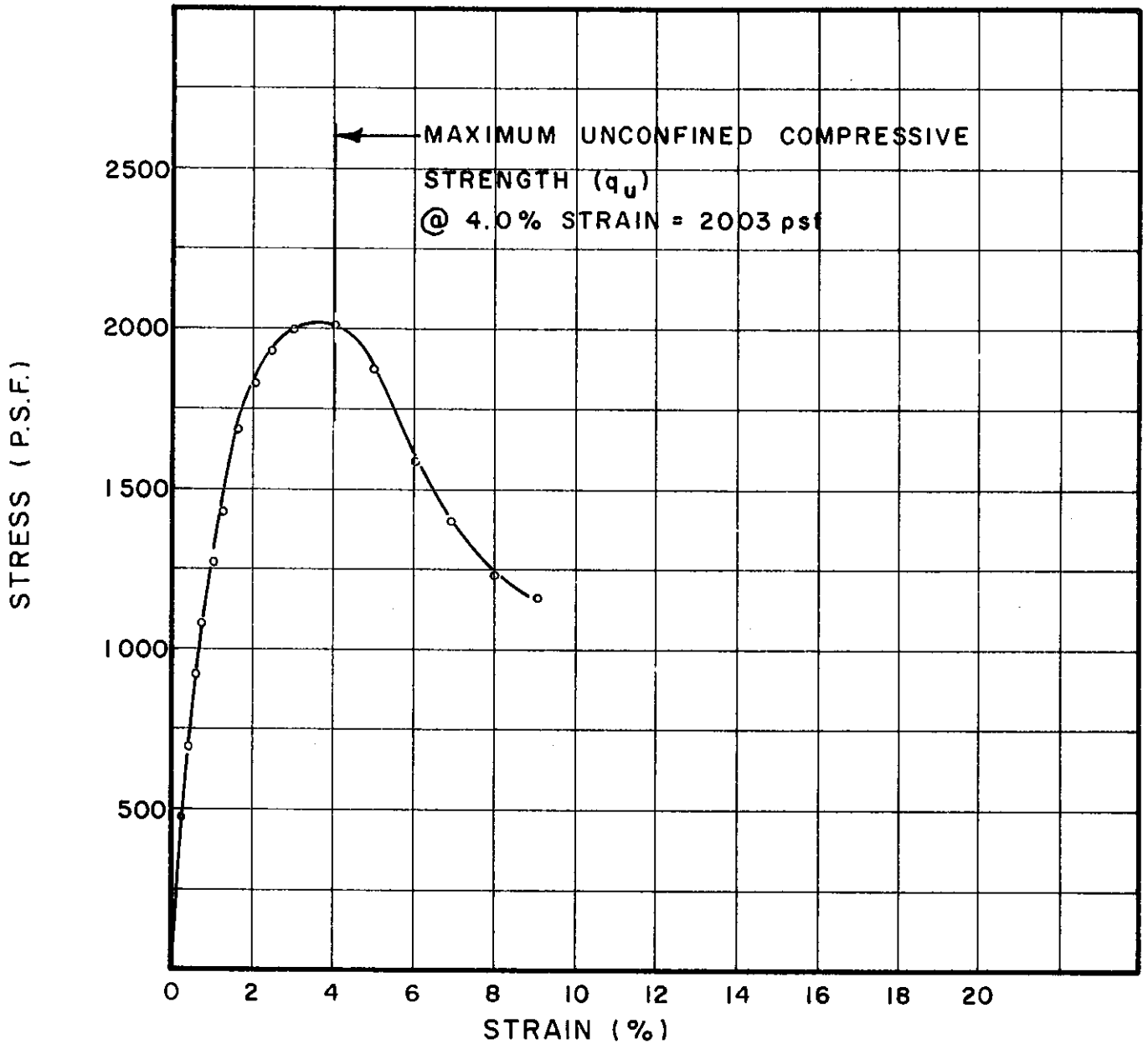

TEST NO.	TEST DATA			SOIL PROPERTIES				
	DIAMETER (INCHES)	HEIGHT (INCHES)	STRAIN RATE (%/MIN)	WATER CONTENT (%)	UNIT WEIGHT (pcf)	ATTERBERG LL (%)	LIMITS PL (%)	SOIL DESCRIPTION
U45.1	1.43	3.50	.257	36.8	86	51	22	SILTY CLAY (CH)

BORING NO. 60

SAMPLE NO. 5

DEPTH 25.6' TO 25.9'

UNCONFINED COMPRESSION TESTS

THE DETROIT EDISON COMPANY
BELLE RIVER PLANT UNITS I & II

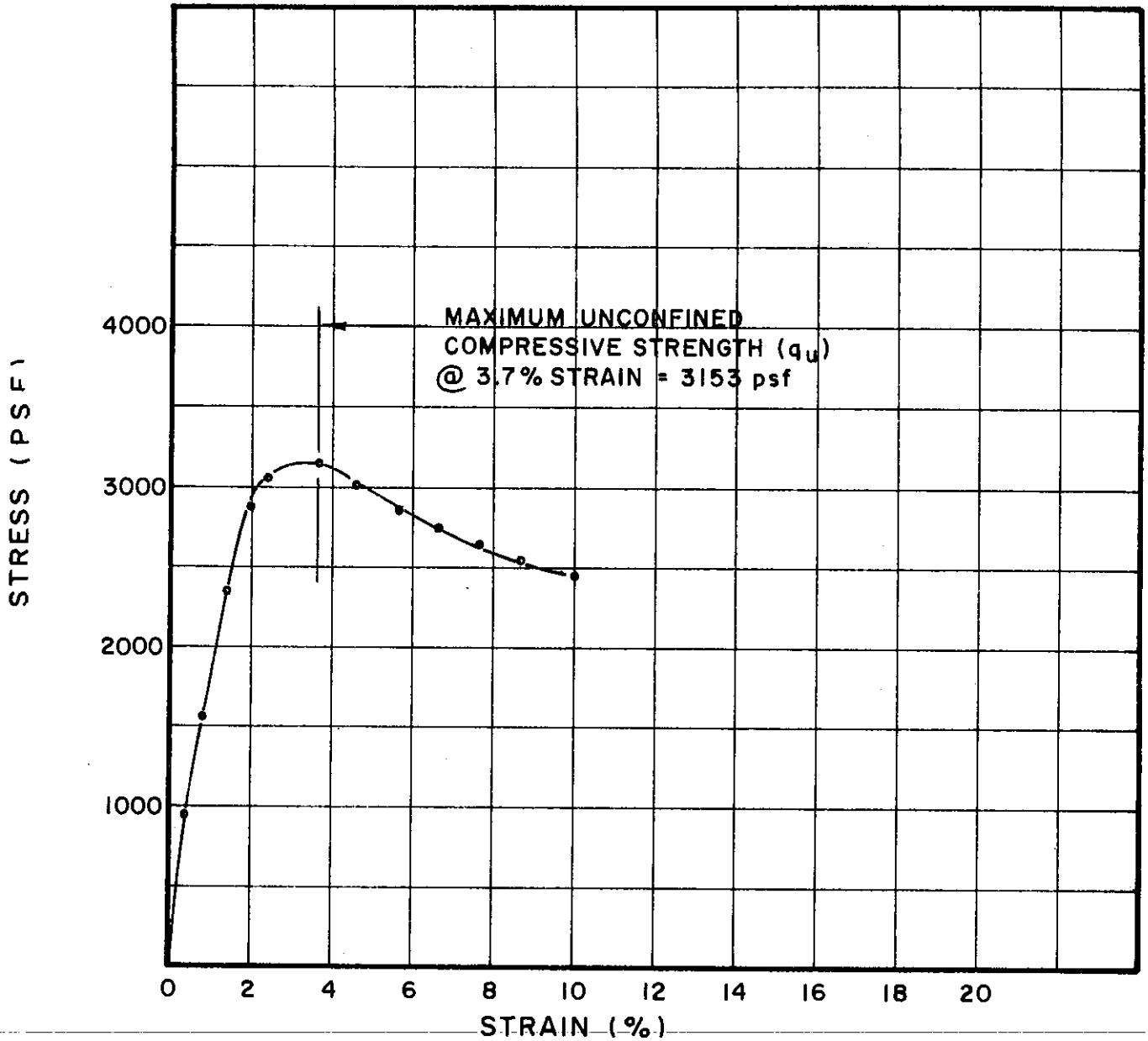

TEST NO.	TEST DATA			SOIL PROPERTIES				
	DIAMETER (INCHES)	HEIGHT (INCHES)	STRAIN RATE (%/MIN)	WATER CONTENT (%)	UNIT WEIGHT (pcf)	ATTERBERG LL (%)	LIMITS PL (%)	SOIL DESCRIPTION
U46.1	1.41	3.06	.26	35.0	88	48	25	SILTY CLAY (CL-CH)

BORING NO. 60
 SAMPLE NO. 6
 DEPTH 30.5' TO 30.8'

UNCONFINED COMPRESSION TESTS

THE DETROIT EDISON COMPANY
 BELLE RIVER PLANT UNITS I & II

FILE 1255

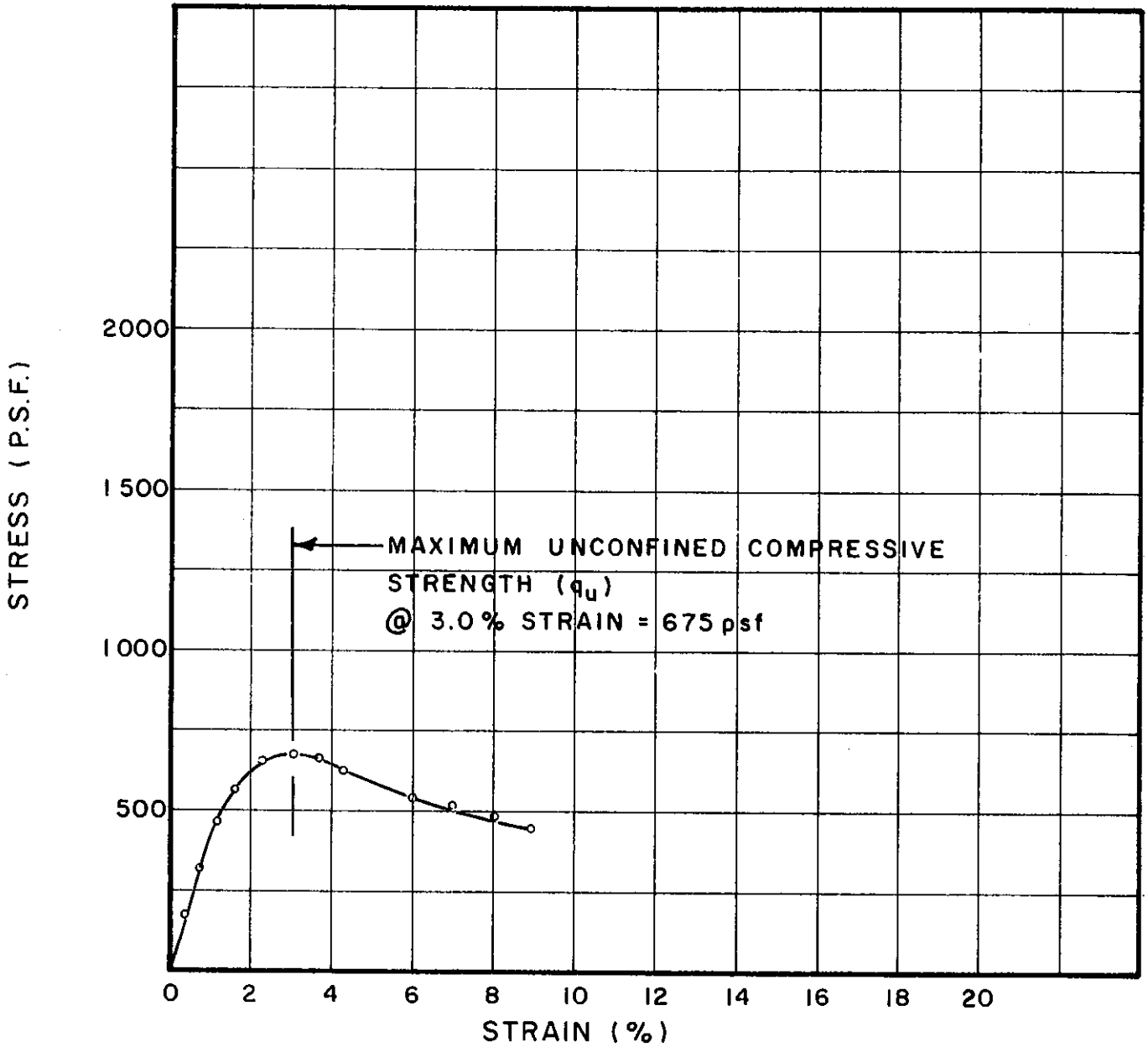

TEST NO.	TEST DATA			SOIL PROPERTIES				
	DIAMETER (INCHES)	HEIGHT (INCHES)	STRAIN RATE (%/MIN)	WATER CONTENT (%)	UNIT WEIGHT (pcf)	ATTERBERG LL (%)	LIMITS PL (%)	SOIL DESCRIPTION
U48.1	1.41	3.50	.257	39.7	83	47	25	SILTY CLAY (CL)

BORING NO. 60
 SAMPLE NO. 8
 DEPTH 40.6' TO 41.0'

UNCONFINED COMPRESSION TESTS

THE DETROIT EDISON COMPANY
 BELLE RIVER PLANT UNITS I & II

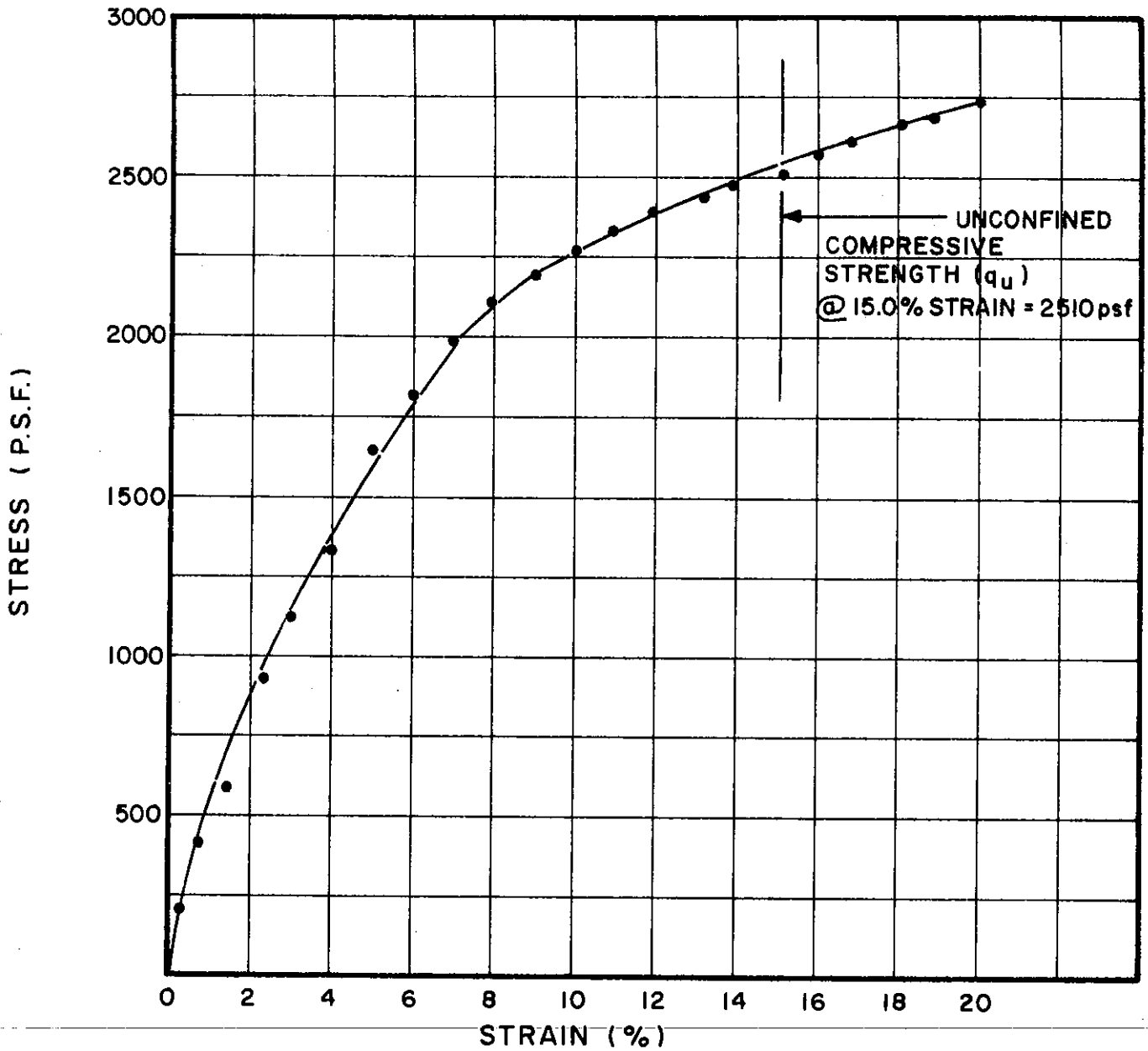

TEST NO.	TEST DATA			WATER CONTENT (%)	DRY UNIT WEIGHT (pcf)	SOIL PROPERTIES		SOIL DESCRIPTION
	DIAMETER (INCHES)	HEIGHT (INCHES)	STRAIN RATE (%/MIN)			ATTERBERG LL (%)	LIMITS PL (%)	
U50.1	1.40	3.50	0.26	25.5	100	34	16	SILTY CLAY (CL)

BORING NO. 60
 SAMPLE NO. 10
 DEPTH 50.9' TO 51.2'

UNCONFINED COMPRESSION TESTS

THE DETROIT EDISON COMPANY
 BELLE RIVER PLANT UNITS I & II

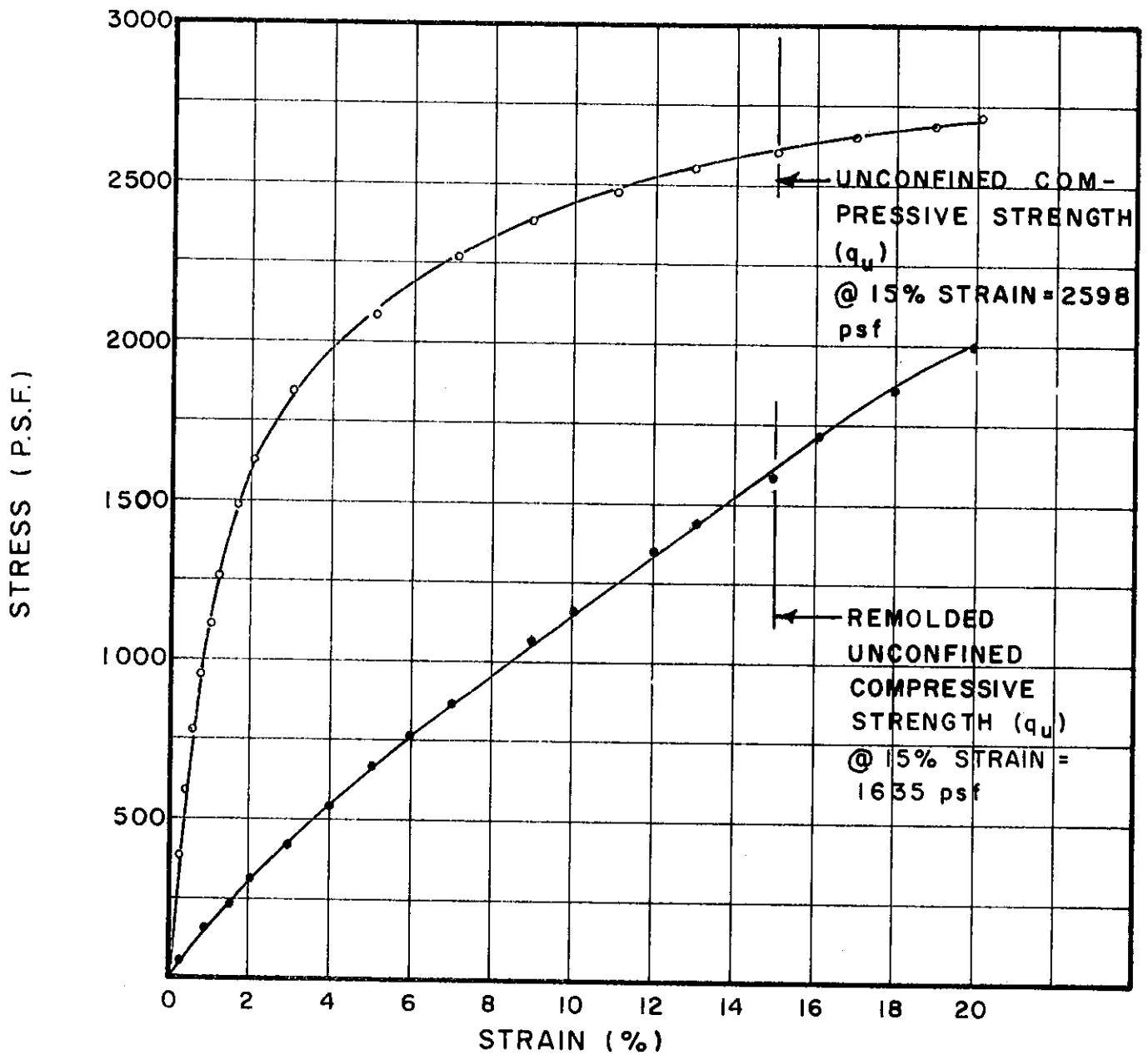

TEST NO.	TEST DATA			SOIL PROPERTIES				
	DIAMETER (INCHES)	HEIGHT (INCHES)	STRAIN RATE (%/MIN)	WATER CONTENT (%)	UNIT WEIGHT (pcf)	ATTERBERG LL (%)	LIMITS PL (%)	SOIL DESCRIPTION
U51.1	1.41	3.49	.258	24.8	103	33	18	SILTY CLAY, SANDY (CL)
U51.1	1.41	3.30	.273	24.8	103	33	18	SILTY CLAY, SANDY (CL)

BORING NO. 60
 SAMPLE NO. 11
 DEPTH 55.6' TO 56.0'

UNCONFINED COMPRESSION TESTS

THE DETROIT EDISON COMPANY
 BELLE RIVER PLANT UNITS I & II

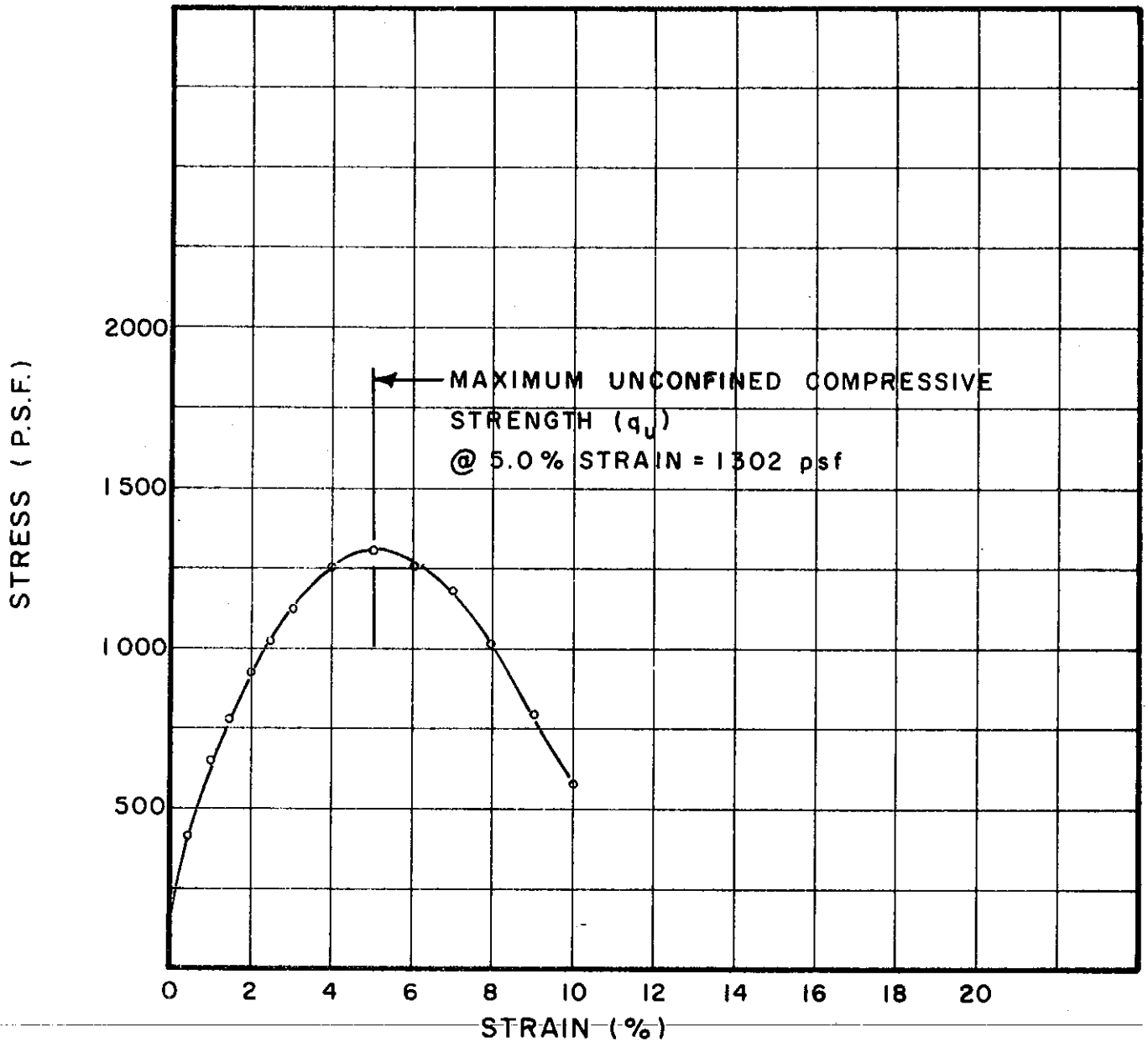

TEST NO.	TEST DATA			SOIL PROPERTIES				
	DIAMETER (INCHES)	HEIGHT (INCHES)	STRAIN RATE (%/MIN)	WATER CONTENT (%)	UNIT WEIGHT (pcf)	ATTERBERG LIMITS LL (%)	PL (%)	SOIL DESCRIPTION
U54.1	1.42	3.50	.257	26.9	97	40	20	SILTY CLAY (CL)

BORING NO. 60

SAMPLE NO. 14

DEPTH 75.1' TO 75.4'

UNCONFINED COMPRESSION TESTS

THE DETROIT EDISON COMPANY
BELLE RIVER PLANT UNITS I & II

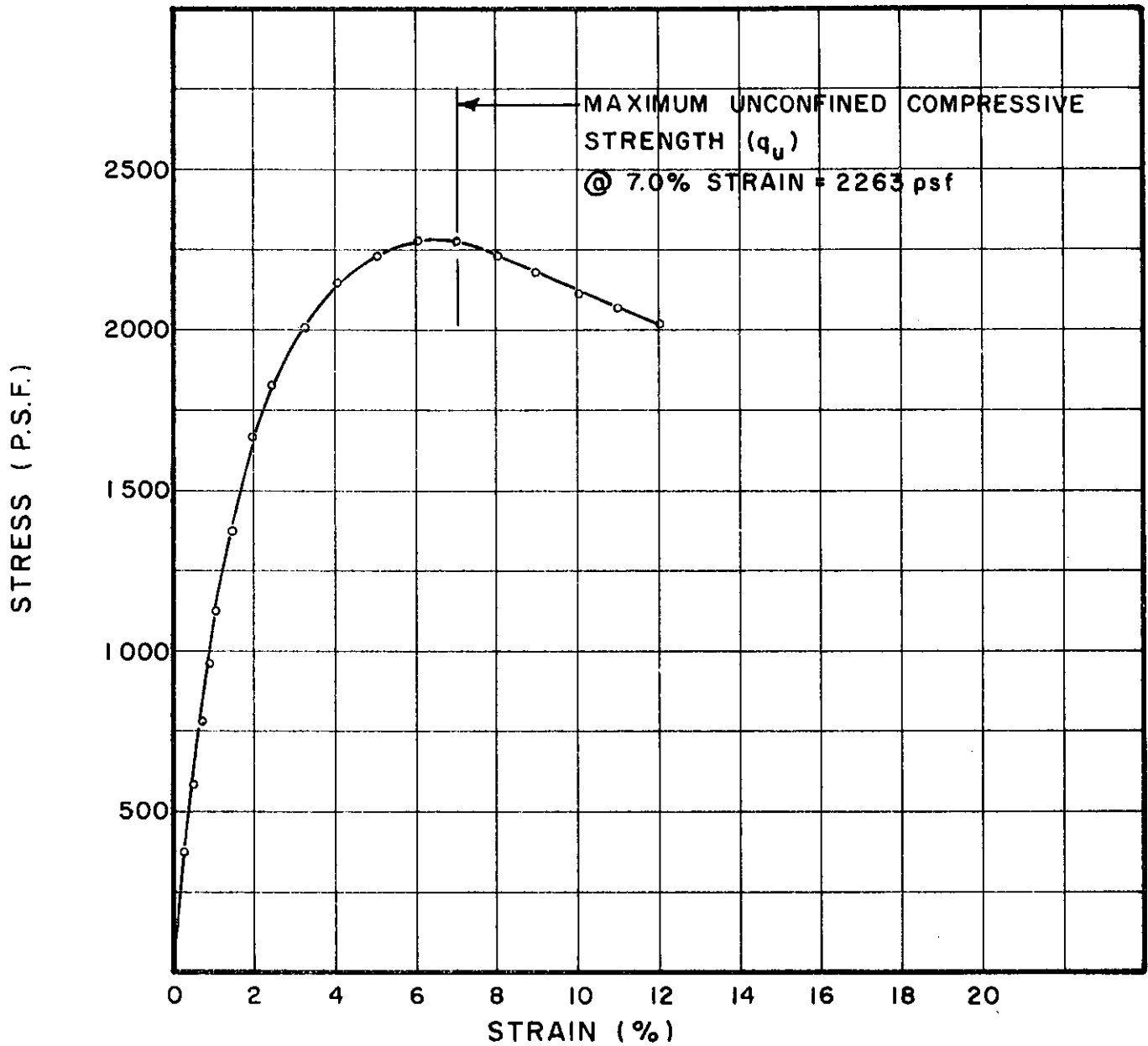

TEST NO.	TEST DATA			SOIL PROPERTIES				
	DIAMETER (INCHES)	HEIGHT (INCHES)	STRAIN RATE (%/MIN)	WATER CONTENT (%)	UNIT WEIGHT (pcf)	ATTERBERG LL (%)	LIMITS PL (%)	SOIL DESCRIPTION
U59.1	1.41	3.50	.257	27.1	101	38	20	SILTY CLAY SANDY (CL)

BORING NO. 60

SAMPLE NO. 19

DEPTH 100.1' TO 100.4'

UNCONFINED COMPRESSION TESTS

THE DETROIT EDISON COMPANY
BELLE RIVER PLANT UNITS I & II

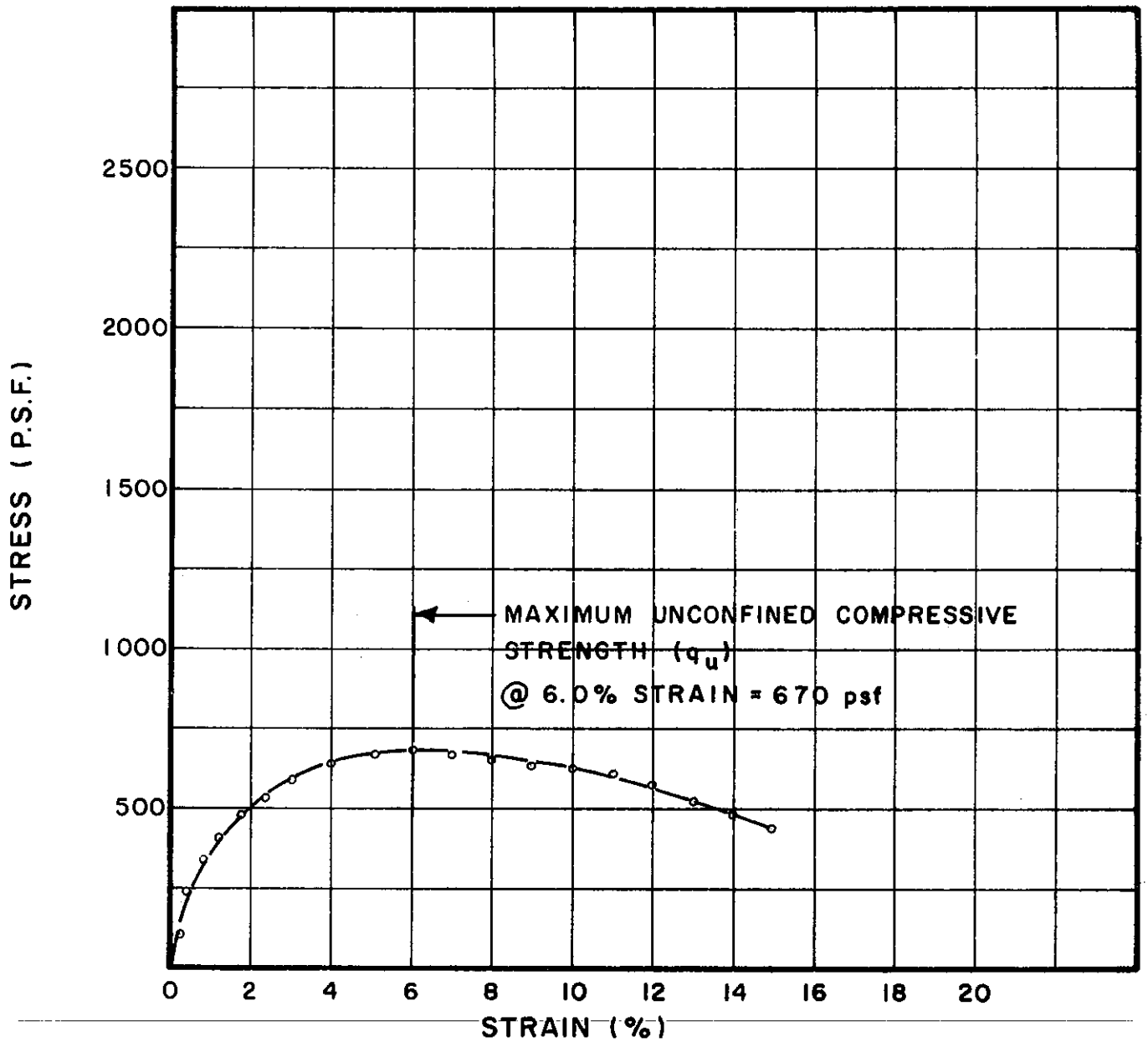

TEST NO.	TEST DATA			SOIL PROPERTIES				
	DIAMETER (INCHES)	HEIGHT (INCHES)	STRAIN RATE (%/MIN)	WATER CONTENT (%)	UNIT WEIGHT (pcf)	ATTERBERG LL (%)	LIMITS PL (%)	SOIL DESCRIPTION
U63.1	1.44	3.50	.257	15.4	115	17	11	SILTY CLAY, SANDY (CL - ML)

BORING NO. 60
 SAMPLE NO. 23
 DEPTH 119.6' TO 120.0

UNCONFINED COMPRESSION TESTS

THE DETROIT EDISON COMPANY
 BELLE RIVER PLANT UNITS I & II

FILE 1255

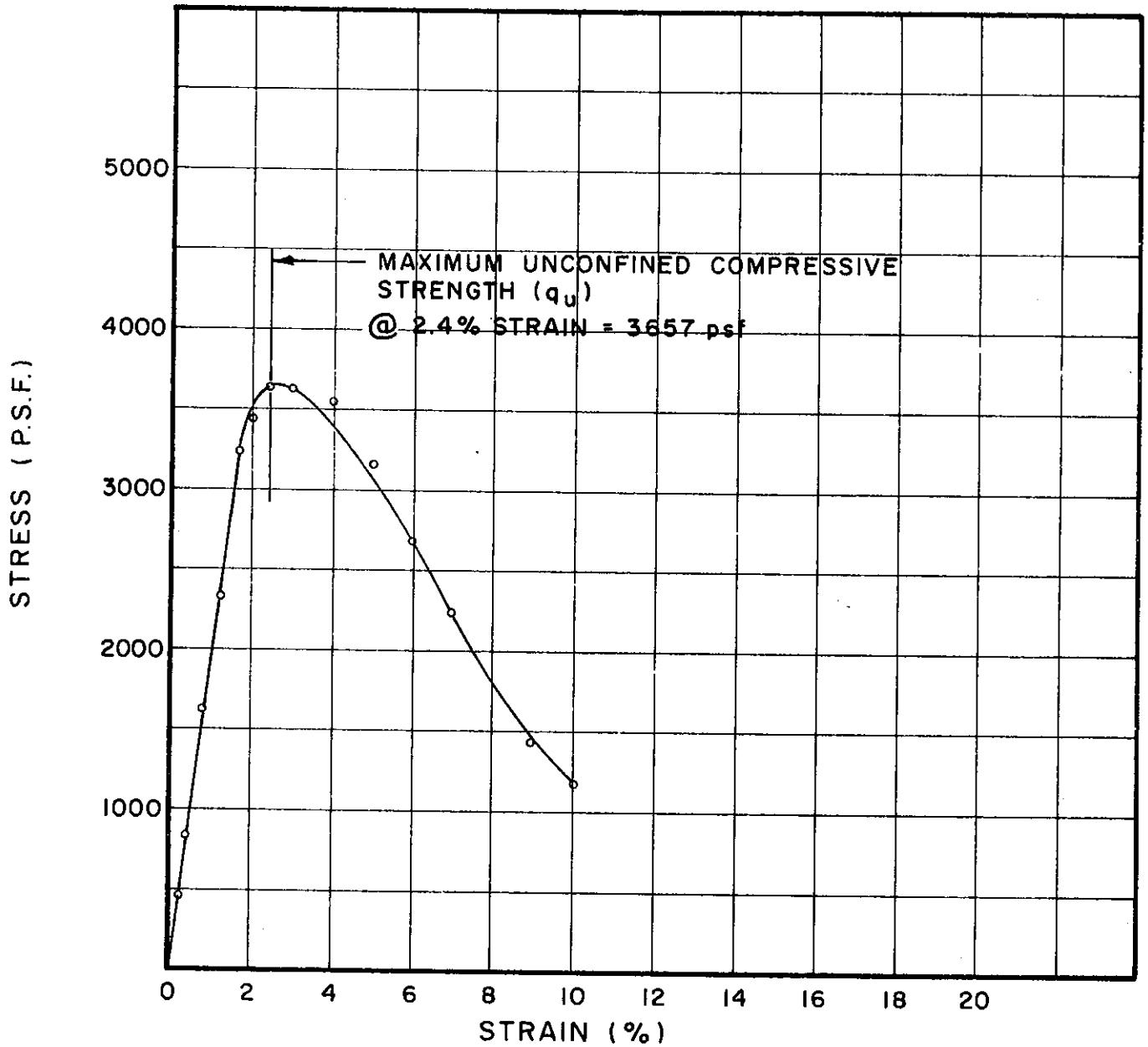

TEST NO.	TEST DATA			SOIL PROPERTIES				
	DIAMETER (INCHES)	HEIGHT (INCHES)	STRAIN RATE (%/MIN)	WATER CONTENT (%)	UNIT WEIGHT (pcf)	ATTERBERG LIMITS LL (%)	PL (%)	SOIL DESCRIPTION
U349.1	1.44	3.15	.286	27.8	96	50	22	SILTY CLAY (CL-CH)

BORING NO. 101
 SAMPLE NO. 2
 DEPTH 8.9' TO 9.2'

UNCONFINED COMPRESSION TESTS

THE DETROIT EDISON COMPANY
 BELLE RIVER PLANT UNITS I & II

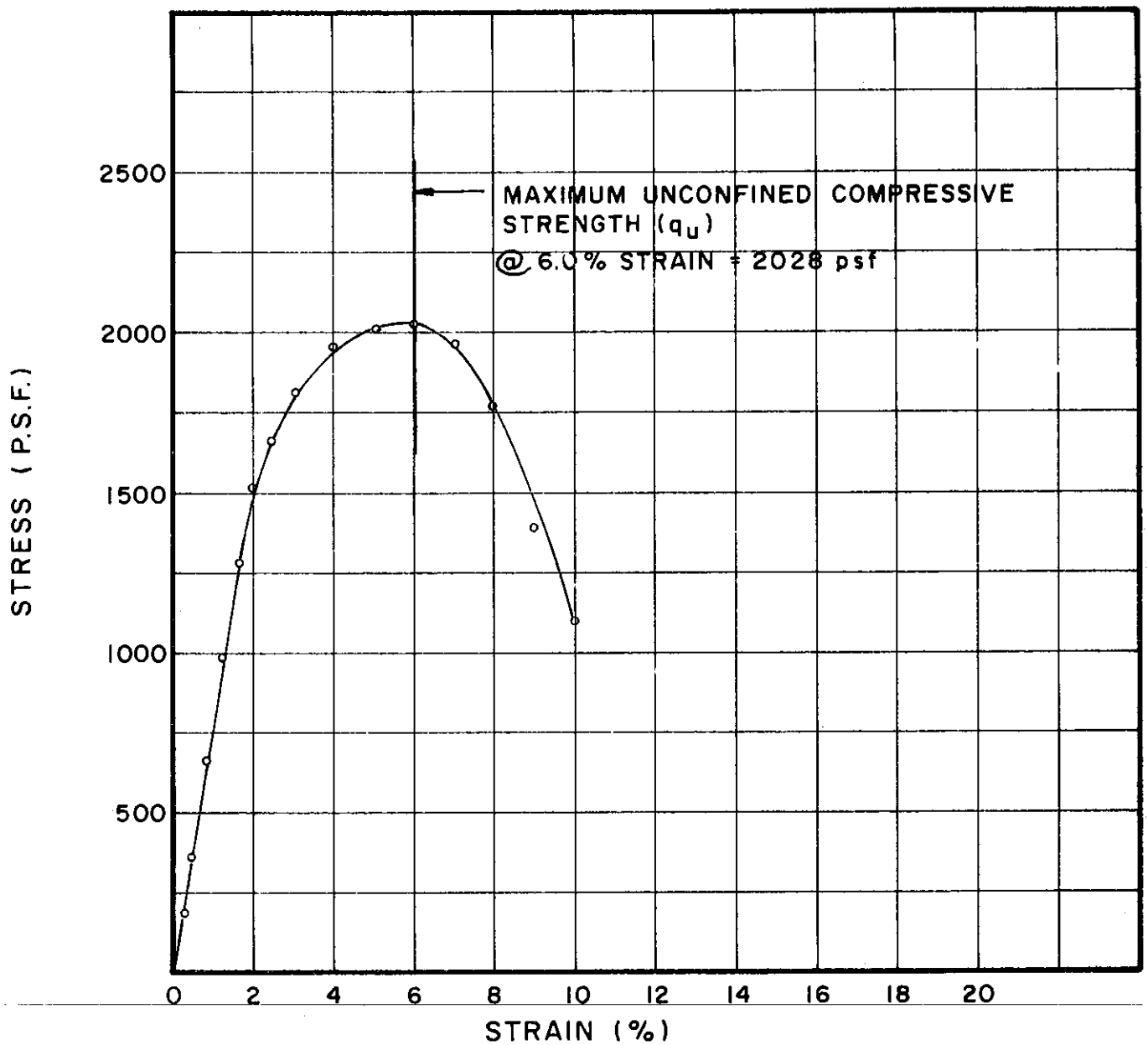

TEST NO.	TEST DATA			SOIL PROPERTIES				
	DIAMETER (INCHES)	HEIGHT (INCHES)	STRAIN RATE (%/MIN)	WATER CONTENT (%)	UNIT WEIGHT (pcf)	ATTERBERG LL (%)	LIMITS PL (%)	SOIL DESCRIPTION
U351.1	1.41	3.29	.274	35.8	86	49	24	SILTY CLAY (CL-CH)

BORING NO. 101

SAMPLE NO. 4

DEPTH 19.9' TO 20.2'

UNCONFINED COMPRESSION TESTS

THE DETROIT EDISON COMPANY
BELLE RIVER PLANT UNITS I & II

FILE 1255

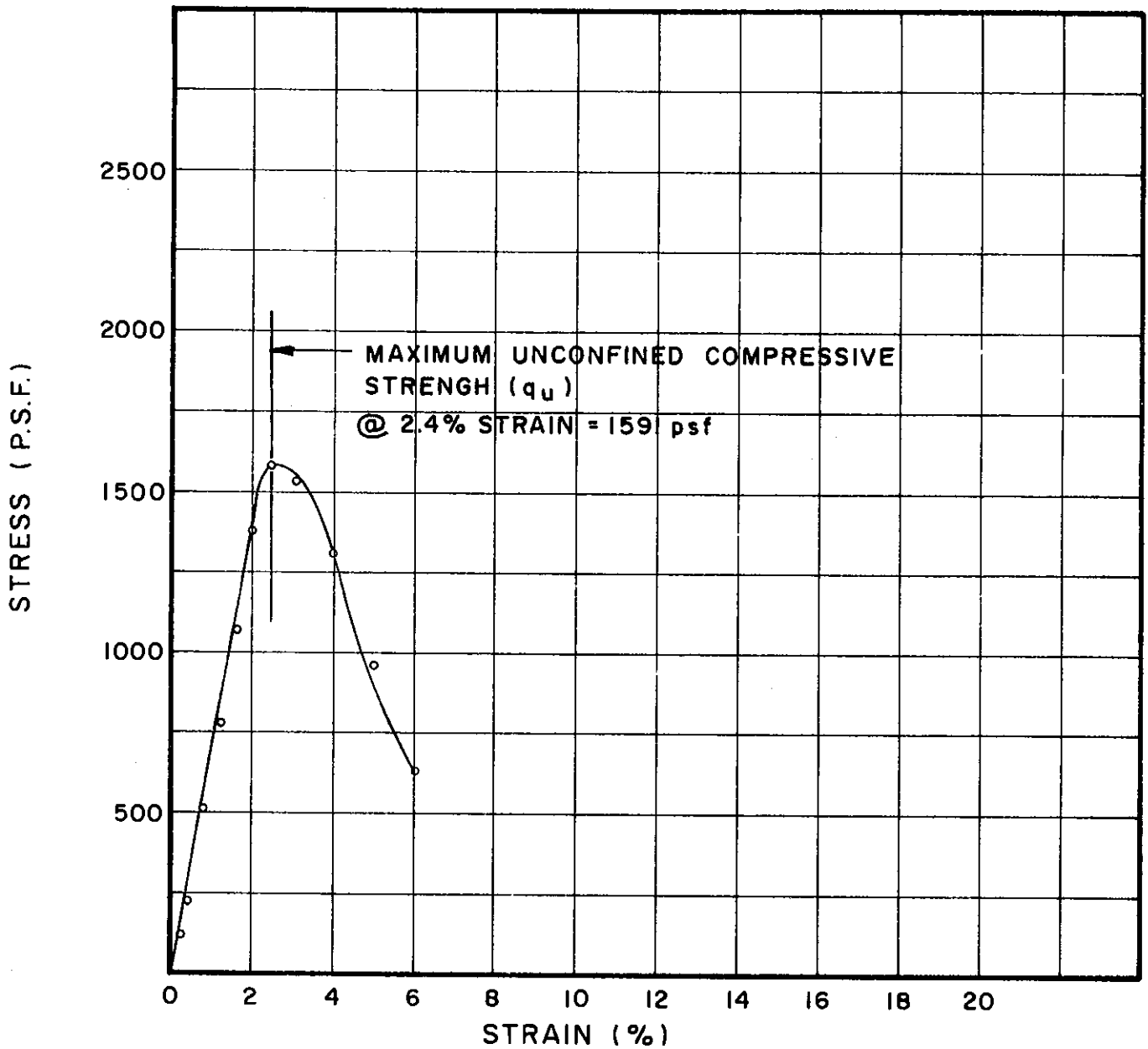

TEST NO.	TEST DATA			SOIL PROPERTIES				
	DIAMETER (INCHES)	HEIGHT (INCHES)	STRAIN RATE (%/MIN)	WATER CONTENT (%)	UNIT WEIGHT (pcf)	ATTERBERG LL (%)	LIMITS PL (%)	SOIL DESCRIPTION
U354.1	1.41	3.37	.267	40.0	81	46	24	SILTY CLAY (CL-CH)

BORING NO. 101
 SAMPLE NO. 7
 DEPTH 34.9' TO 35.2'

UNCONFINED COMPRESSION TESTS

THE DETROIT EDISON COMPANY
 BELLE RIVER PLANT UNITS I & II

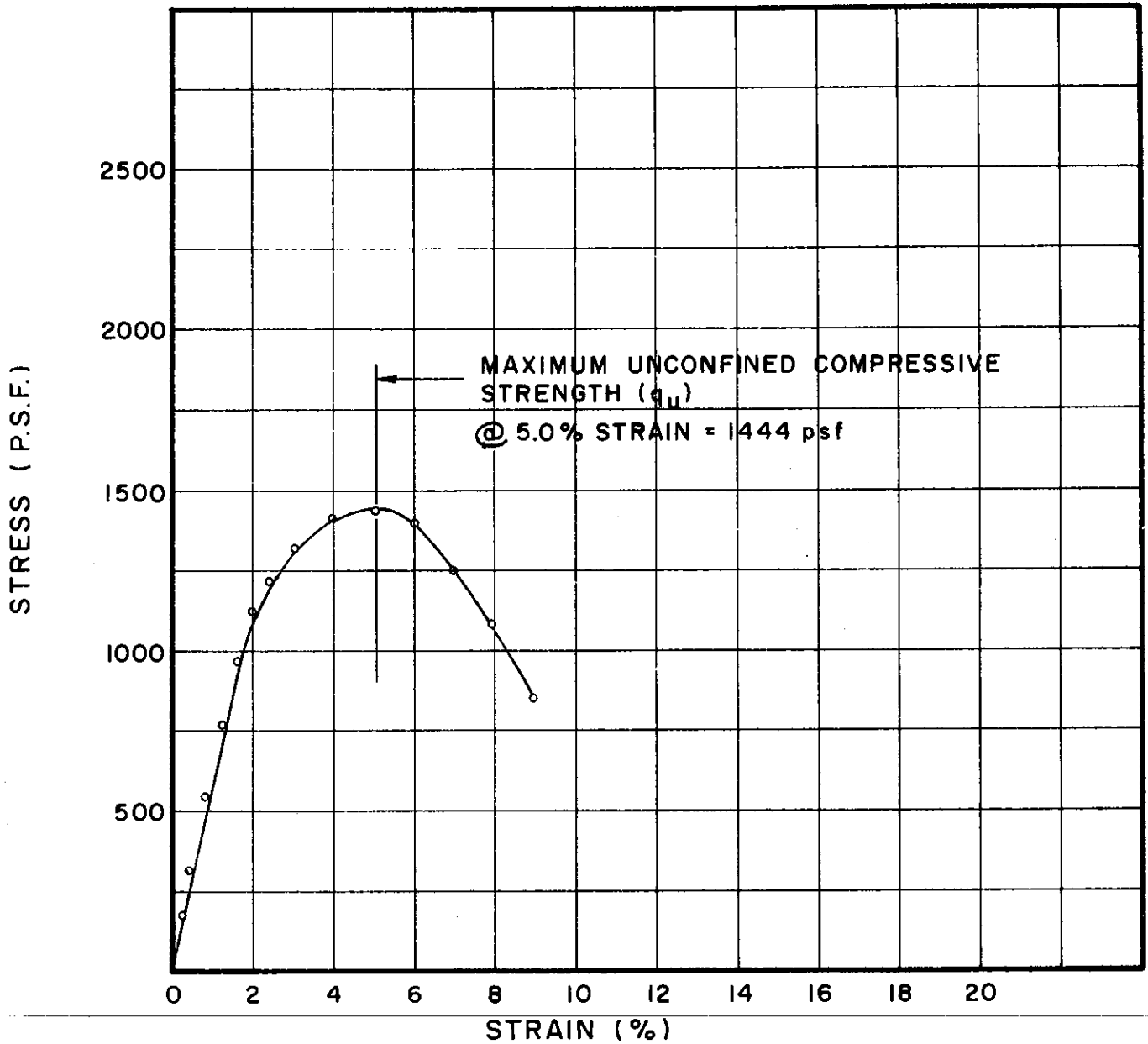

TEST NO.	TEST DATA			SOIL PROPERTIES				
	DIAMETER (INCHES)	HEIGHT (INCHES)	STRAIN RATE (%/MIN)	WATER CONTENT (%)	UNIT WEIGHT (pcf)	ATTERBERG LL (%)	LIMITS PL (%)	SOIL DESCRIPTION
U357.1	1.40	3.30	.273	32.8	90	40	22	SILTY CLAY (CL-CH)

BORING NO. 101

SAMPLE NO. 10

DEPTH 50.1' TO 50.4'

UNCONFINED COMPRESSION TESTS

THE DETROIT EDISON COMPANY
BELLE RIVER PLANT UNITS I & II

FILE 1255

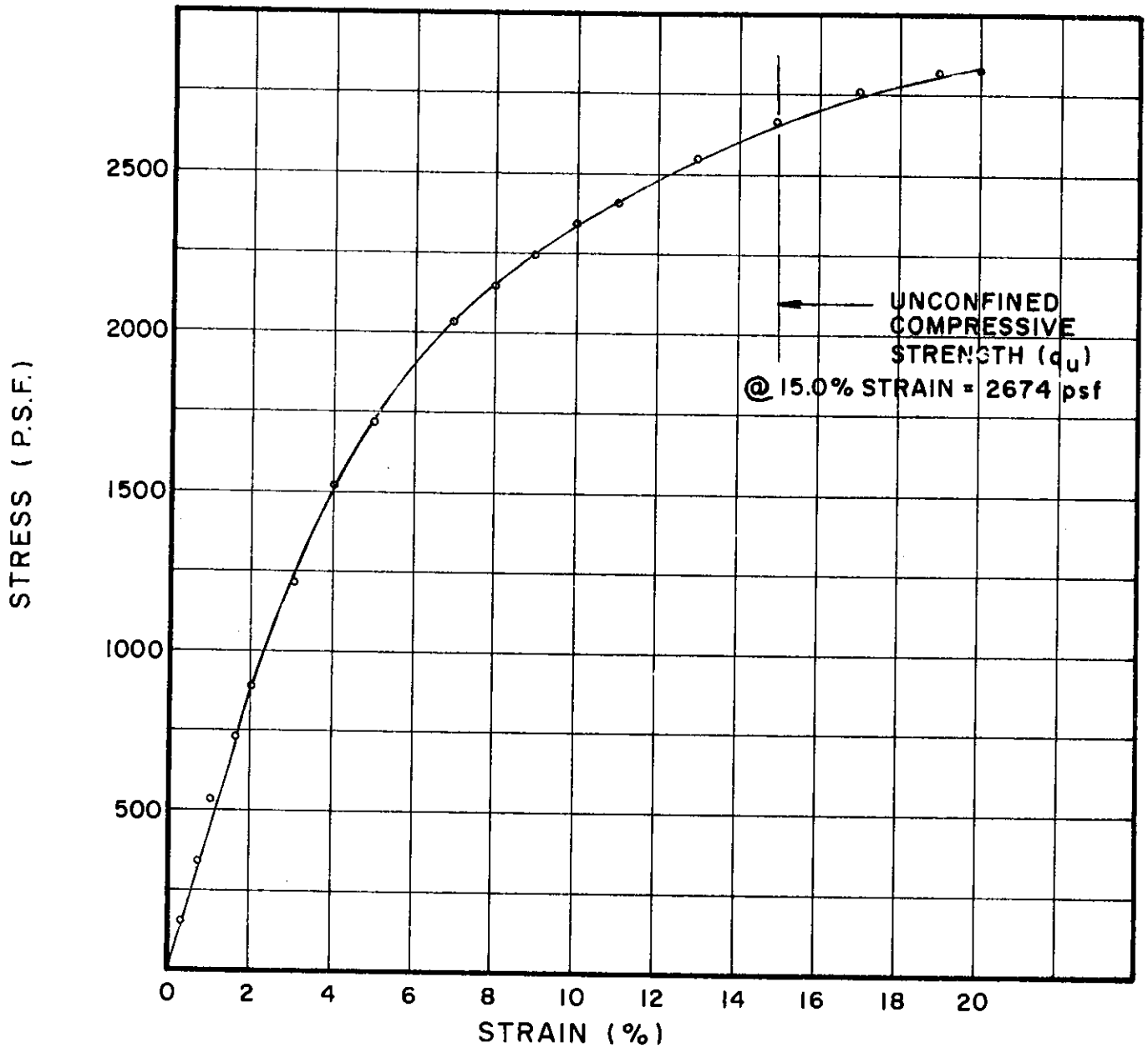

TEST NO.	TEST DATA			SOIL PROPERTIES				
	DIAMETER (INCHES)	HEIGHT (INCHES)	STRAIN RATE (%/MIN)	WATER CONTENT (%)	UNIT WEIGHT (pcf)	ATTERBERG LL (%)	LIMITS PL (%)	SOIL DESCRIPTION
U360.1	1.39	3.28	.274	26.6	97	36	19	SILTY CLAY, SANDY (CL)

BORING NO. 101
 SAMPLE NO. 13
 DEPTH 65.2' TO 65.6'

UNCONFINED COMPRESSION TESTS

THE DETROIT EDISON COMPANY
 BELLE RIVER PLANT UNITS I & II

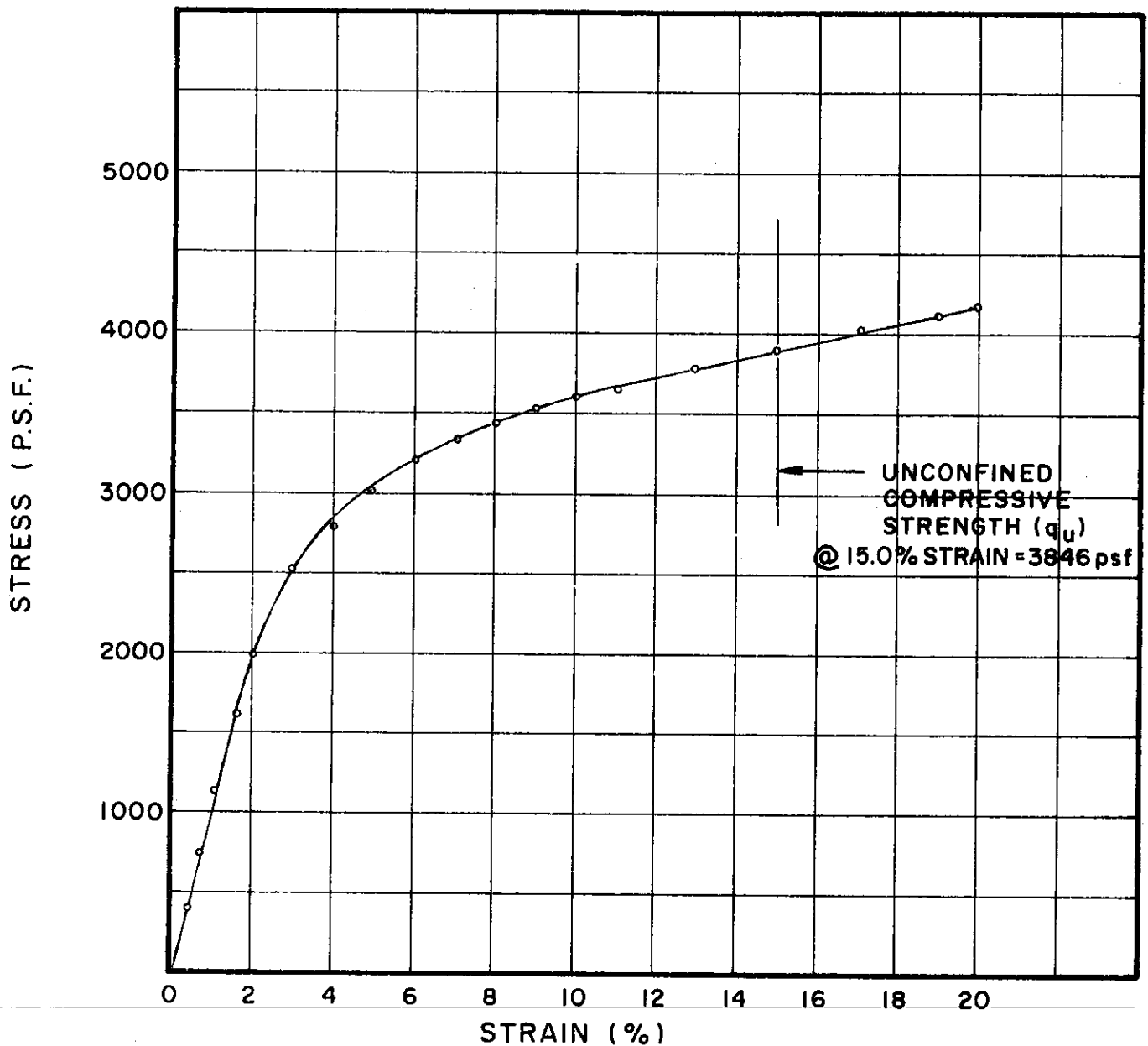

TEST NO.	TEST DATA			SOIL PROPERTIES				
	DIAMETER (INCHES)	HEIGHT (INCHES)	STRAIN RATE (%/MIN)	WATER CONTENT (%)	UNIT WEIGHT (pcf)	ATTERBERG LL (%)	LIMITS PL (%)	SOIL DESCRIPTION
U364.1	1.41	3.35	.269	25.2	97	37	19	SILTY CLAY, SANDY (CL)

BORING NO. 101

SAMPLE NO. 17

DEPTH 85.2' TO 85.5'

UNCONFINED COMPRESSION TESTS

THE DETROIT EDISON COMPANY
BELLE RIVER PLANT UNITS I & II

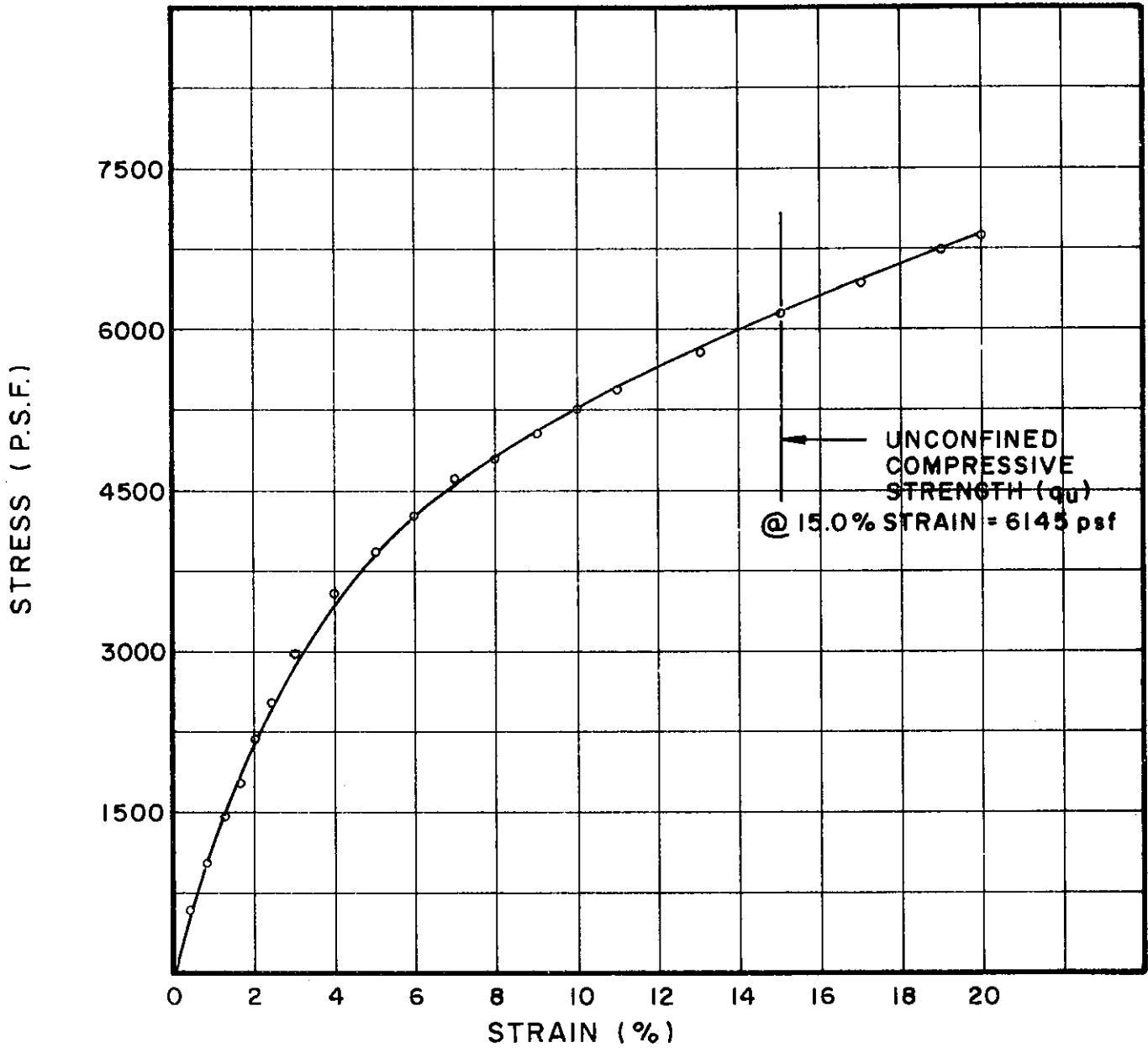

TEST NO.	TEST DATA			SOIL PROPERTIES				
	DIAMETER (INCHES)	HEIGHT (INCHES)	STRAIN RATE (%/MIN)	WATER CONTENT (%)	UNIT WEIGHT (pcf)	ATTERBERG LL (%)	LIMITS PL (%)	SOIL DESCRIPTION
U339.1	1.41	3.35	.268	20.7	107	33	20	SILTY CLAY, SANDY (CL)

BORING NO. 119

SAMPLE NO. 9

DEPTH 81.6' TO 81.9'

UNCONFINED COMPRESSION TESTS

THE DETROIT EDISON COMPANY
BELLE RIVER PLANT UNITS I & II

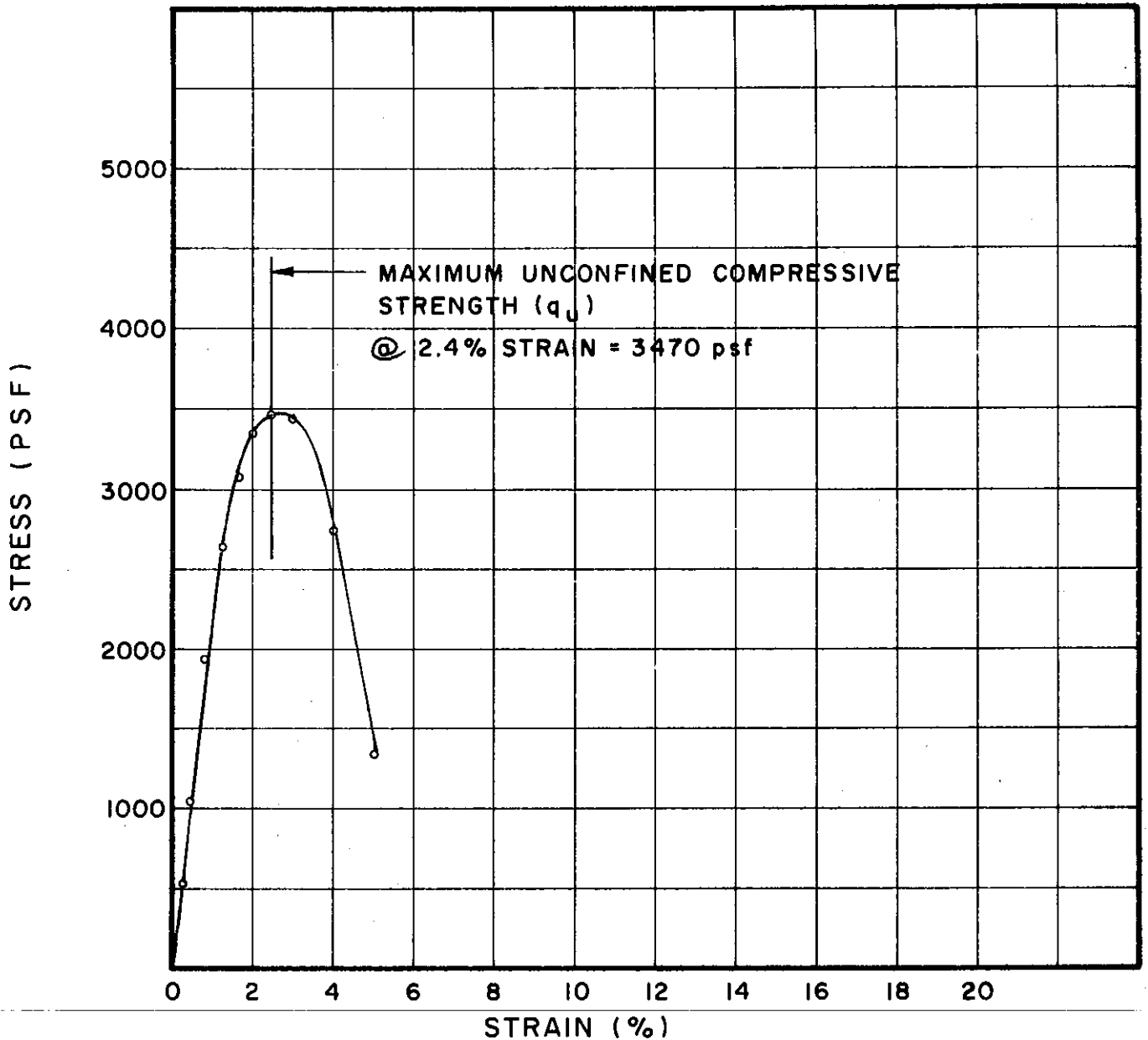

TEST NO.	TEST DATA			SOIL PROPERTIES				
	DIAMETER (INCHES)	HEIGHT (INCHES)	STRAIN RATE (%/MIN)	WATER CONTENT (%)	DRY UNIT WEIGHT (pcf)	ATTERBERG LL (%)	LIMITS PL (%)	SOIL DESCRIPTION
U241.1	1.46	3.50	.257	26.2	99	47	24	SILTY CLAY (CL-CH)

BORING NO. 126

SAMPLE NO. 3

DEPTH 8.2' TO 8.6'

UNCONFINED COMPRESSION TESTS

THE DETROIT EDISON COMPANY
BELLE RIVER PLANT UNITS I & II

FILE 1255

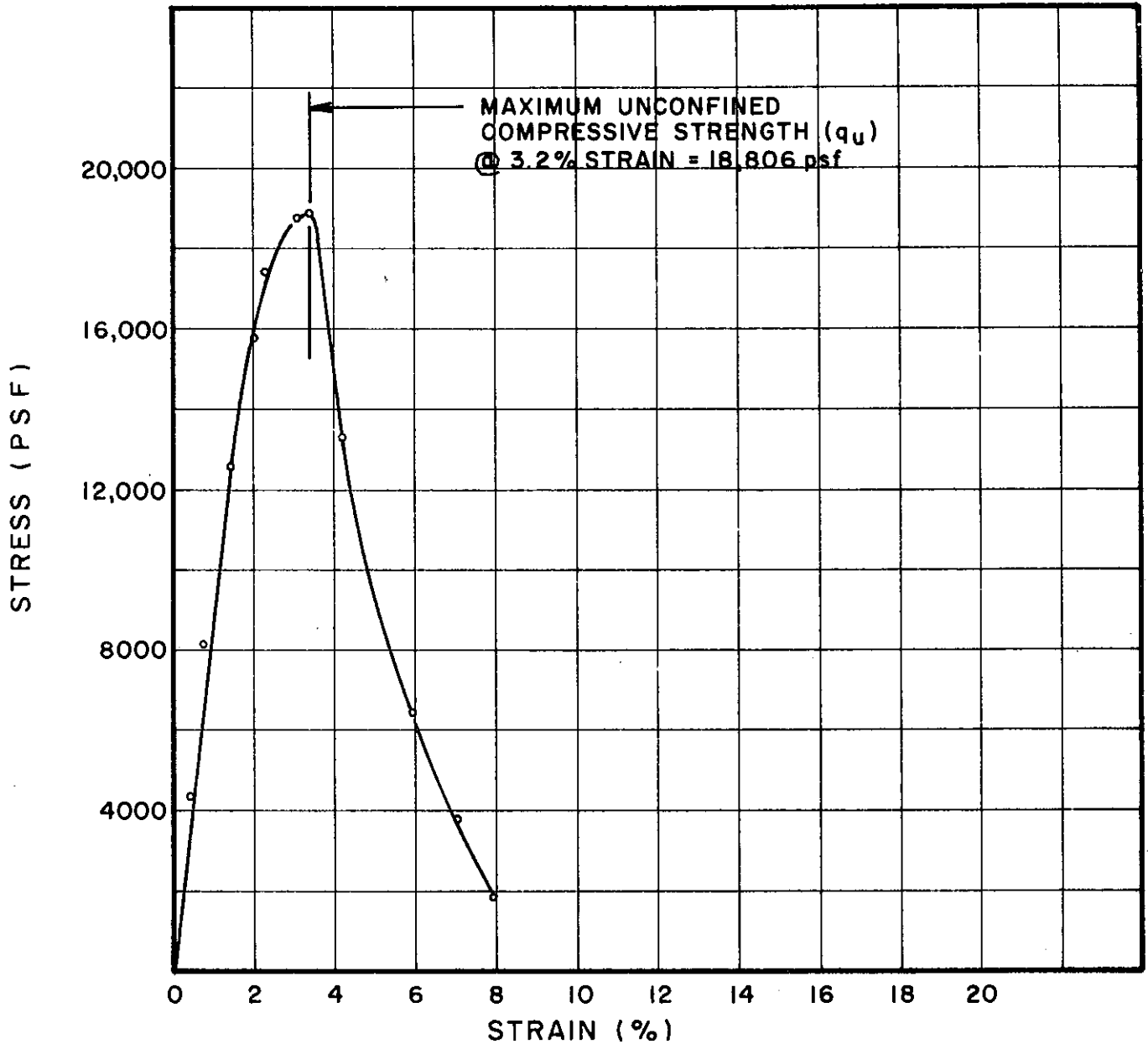

TEST NO.	TEST DATA			WATER CONTENT (%)	DRY UNIT WEIGHT (pcf)	SOIL PROPERTIES		SOIL DESCRIPTION
	DIAMETER (INCHES)	HEIGHT (INCHES)	STRAIN RATE (%/MIN)			ATTERBERG LL (%)	LIMITS PL (%)	
U416.2	1.42	3.55	0.26	13.5	113	49	22	SILTY CLAY (CL-CH)
								"COMPACTED SAMPLE"

BORING NO. 127
 SAMPLE NO. 3
 DEPTH 5.6' TO 7.0'

UNCONFINED COMPRESSION TESTS

THE DETROIT EDISON COMPANY
 BELLE RIVER PLANT UNITS I & II

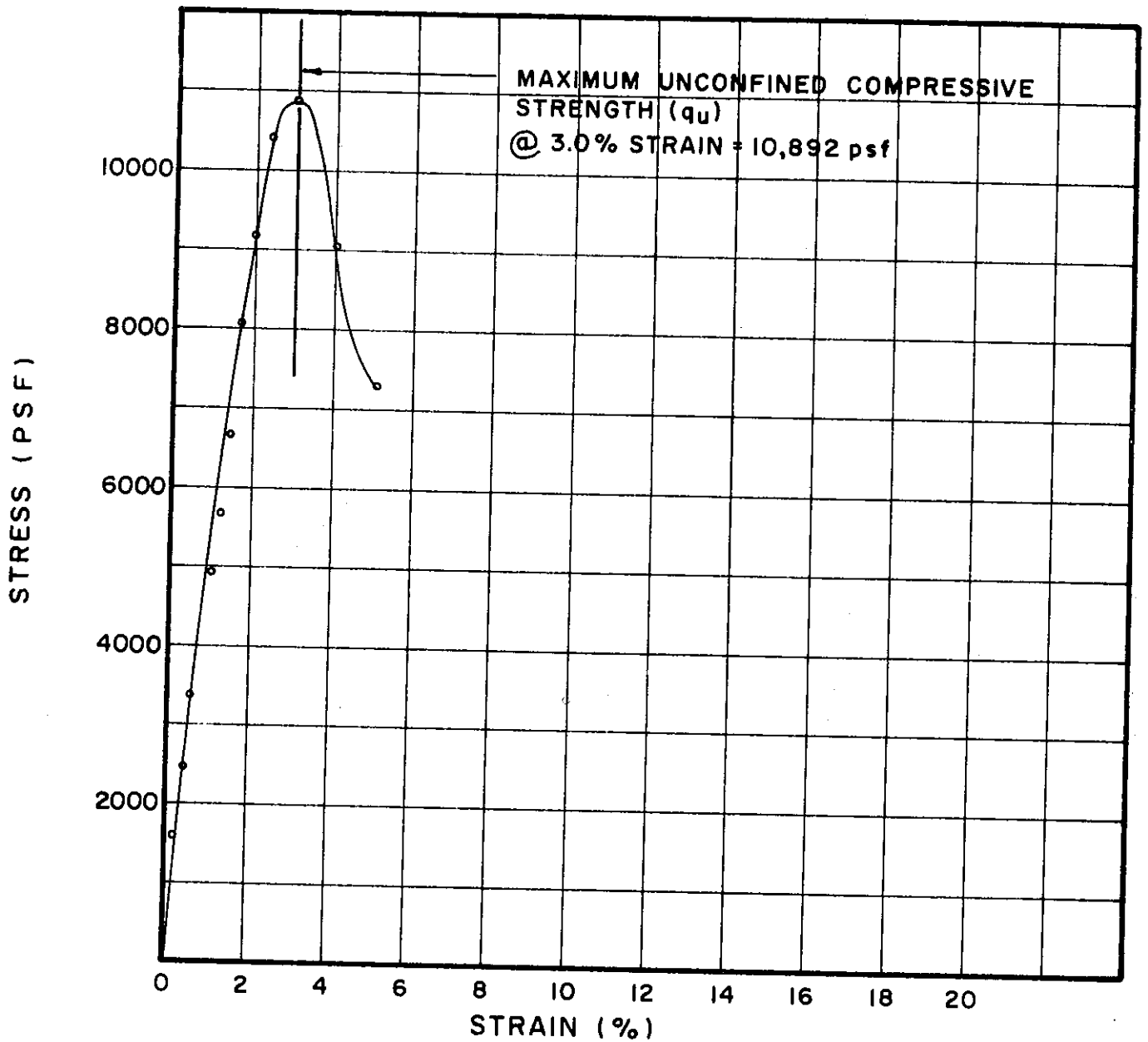

TEST NO.	TEST DATA			SOIL PROPERTIES				
	DIAMETER (INCHES)	HEIGHT (INCHES)	STRAIN RATE (%/MIN)	WATER CONTENT (%)	UNIT WEIGHT (pcf)	ATTERBERG LL (%)	LIMITS PL (%)	SOIL DESCRIPTION
U526.1	1.42	3.46	0.25	24.3	102	48	22	SILTY CLAY (CL-CH)

BORING NO. 136

SAMPLE NO. 4

DEPTH 8.8' TO 9.2'

UNCONFINED COMPRESSION TESTS

THE DETROIT EDISON COMPANY
BELLE RIVER PLANT UNITS I & II

FILE 1255

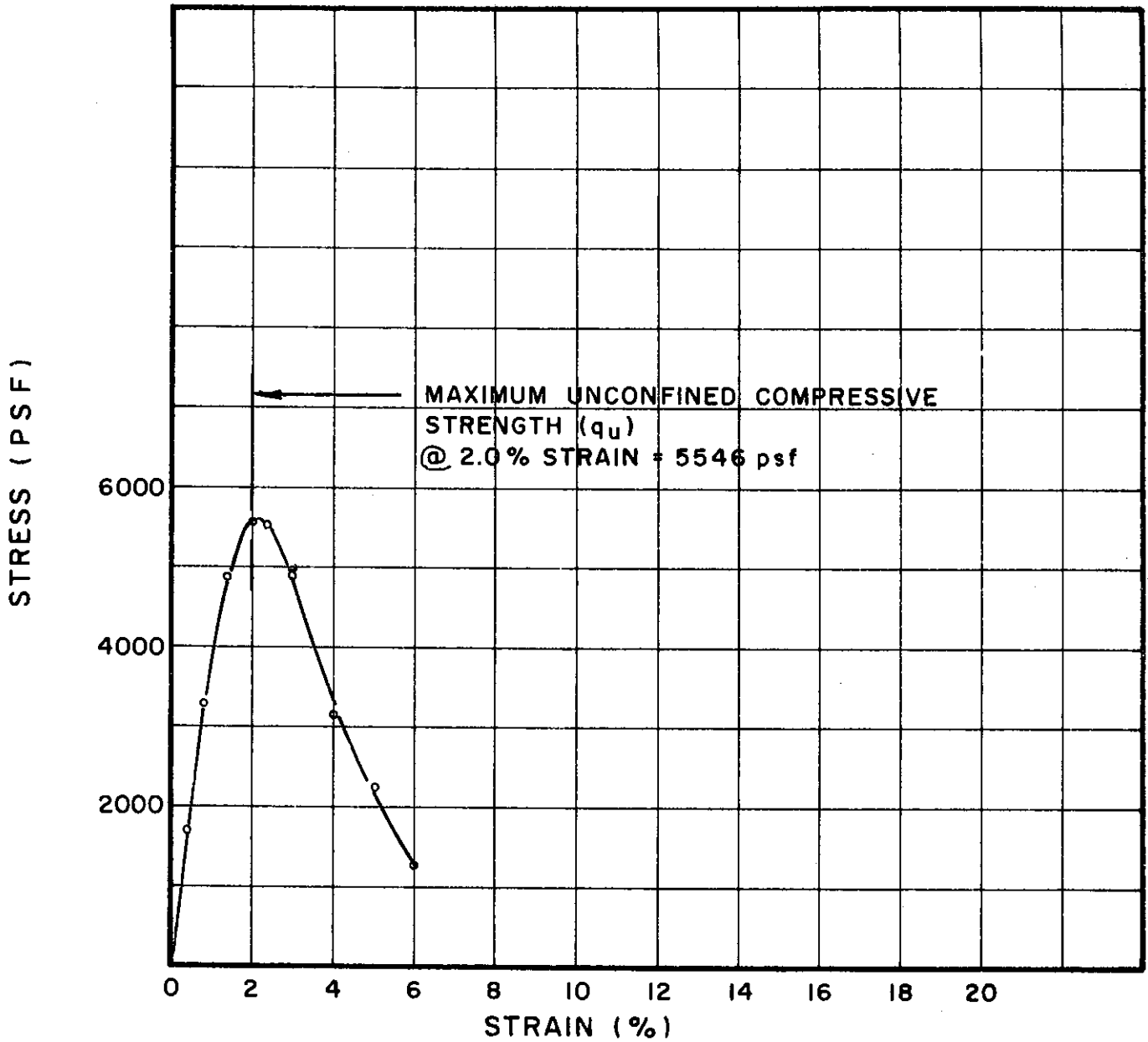

TEST NO.	TEST DATA			WATER CONTENT (%)	DRY UNIT WEIGHT (pcf)	SOIL PROPERTIES		SOIL DESCRIPTION
	DIAMETER (INCHES)	HEIGHT (INCHES)	STRAIN RATE (%/MIN)			ATTERBERG LL (%)	LIMITS PL (%)	
U _p 527.1	1.40	3.28	.274	17.5	100	43	22	SILTY CLAY (CL)
								COMPACTED SAMPLE

BORING NO. 136
 SAMPLE NO. ST 6
 DEPTH 13.0' TO 14.6'

UNCONFINED COMPRESSION TESTS

THE DETROIT EDISON COMPANY
 BELLE RIVER PLANT UNITS I & II

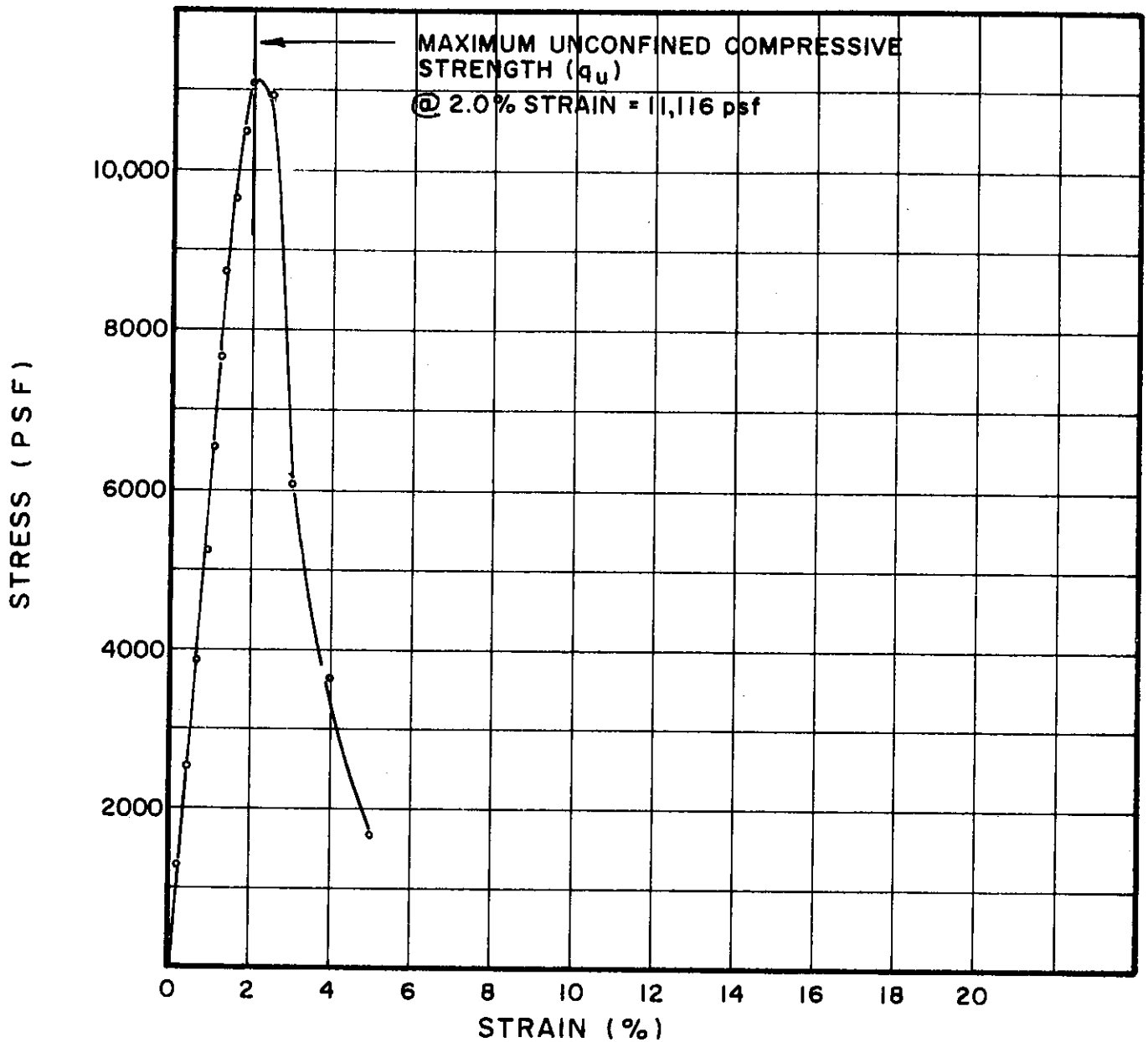

TEST NO.	TEST DATA			SOIL PROPERTIES				
	DIAMETER (INCHES)	HEIGHT (INCHES)	STRAIN RATE (%/MIN)	WATER CONTENT (%)	UNIT WEIGHT (pcf)	ATTERBERG LL (%)	LIMITS PL (%)	SOIL DESCRIPTION
U529.1	1.41	3.05	.28	17.5	103	49	23	SILTY CLAY (CL-CH)

BORING NO. 141

SAMPLE NO. 2

DEPTH 8.0' TO 10.0'

UNCONFINED COMPRESSION TESTS

THE DETROIT EDISON COMPANY
BELLE RIVER PLANT UNITS I & II

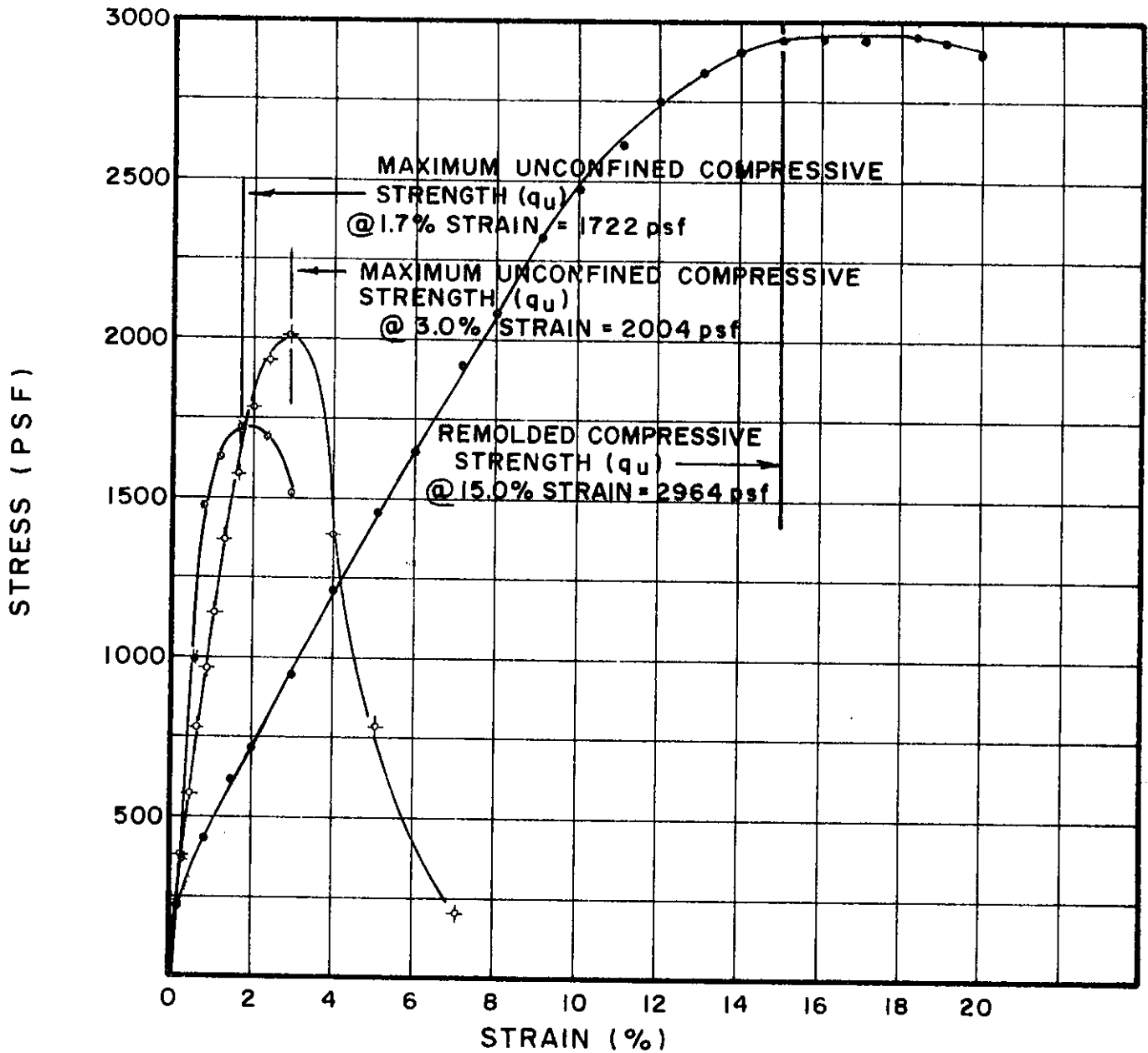

TEST NO.	TEST DATA			SOIL PROPERTIES			SOIL DESCRIPTION
	DIAMETER (INCHES)	HEIGHT (INCHES)	STRAIN RATE (%/MIN)	WATER CONTENT (%)	DRY UNIT WEIGHT (pcf)	ATTERBERG LIMITS LL(%) PL(%)	
U537.1	1.41	3.24	.28	26.3	97	48 21	SILTY CLAY (CL-CH)
U537.2	1.39	3.23	.28	24.1	99		
rU537.1	1.42	3.15	.28	24.1	100		

BORING NO. 144
 SAMPLE NO. 4
 DEPTH 8.0' TO 10.0'

UNCONFINED COMPRESSION TESTS

THE DETROIT EDISON COMPANY
 BELLE RIVER PLANT UNITS I & II

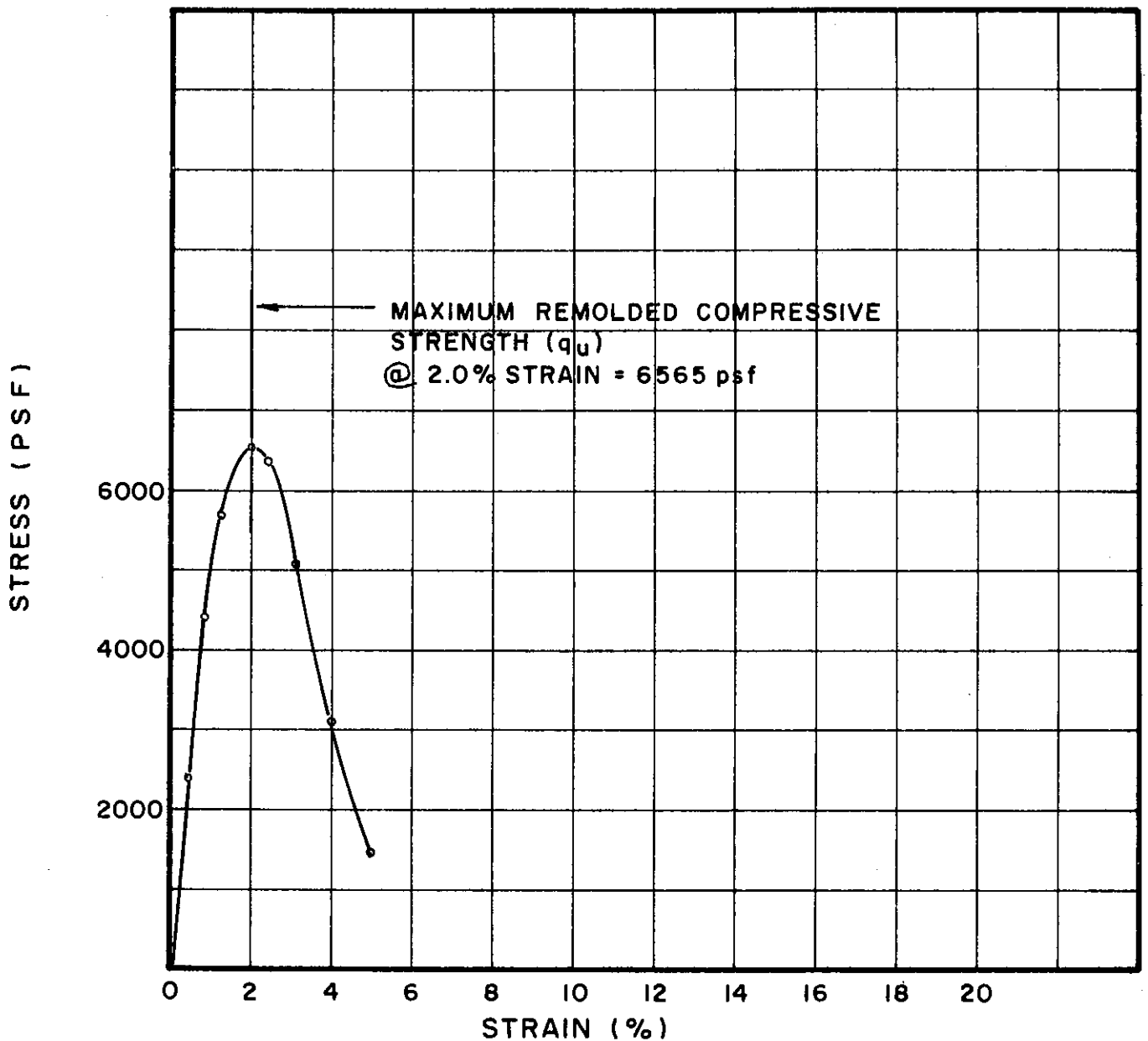

TEST NO.	TEST DATA			SOIL PROPERTIES				
	DIAMETER (INCHES)	HEIGHT (INCHES)	STRAIN RATE (%/MIN)	WATER CONTENT (%)	DRY UNIT WEIGHT (pcf)	ATTERBERG LL (%)	LIMITS PL (%)	SOIL DESCRIPTION
U _r 542.1	1.40	3.18	.283	16.6	104	46	22	SILTY CLAY (CL)
								COMPACTED SAMPLE

BORING NO. 146

SAMPLE NO. ST 7

DEPTH 14.0' TO 16.1'

UNCONFINED COMPRESSION TESTS

THE DETROIT EDISON COMPANY
BELLE RIVER PLANT UNITS I & II

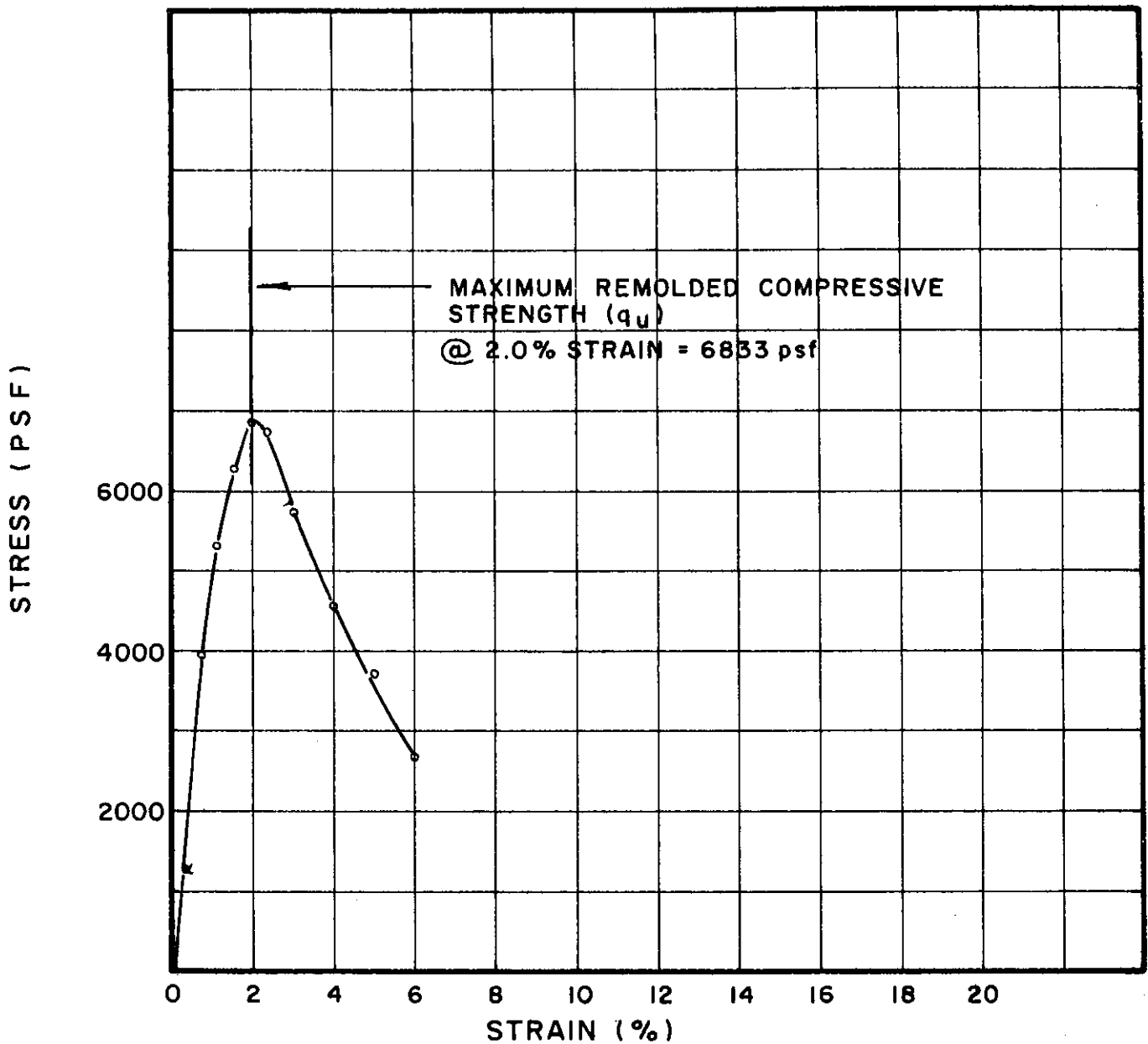

TEST NO.	TEST DATA			WATER CONTENT (%)	DRY UNIT WEIGHT (pcf)	SOIL PROPERTIES		SOIL DESCRIPTION
	DIAMETER (INCHES)	HEIGHT (INCHES)	STRAIN RATE (%/MIN)			ATTERBERG LL (%)	LIMITS PL (%)	
U _r 548.1	1.37	3.20	.281	16.8	104	50	21	SILTY CLAY (CL-CH)
								COMPACTED SAMPLE

BORING NO. 158
 SAMPLE NO. ST 2
 DEPTH 7.5' TO 9.7'

UNCONFINED COMPRESSION TESTS

THE DETROIT EDISON COMPANY
 BELLE RIVER PLANT UNITS I & II

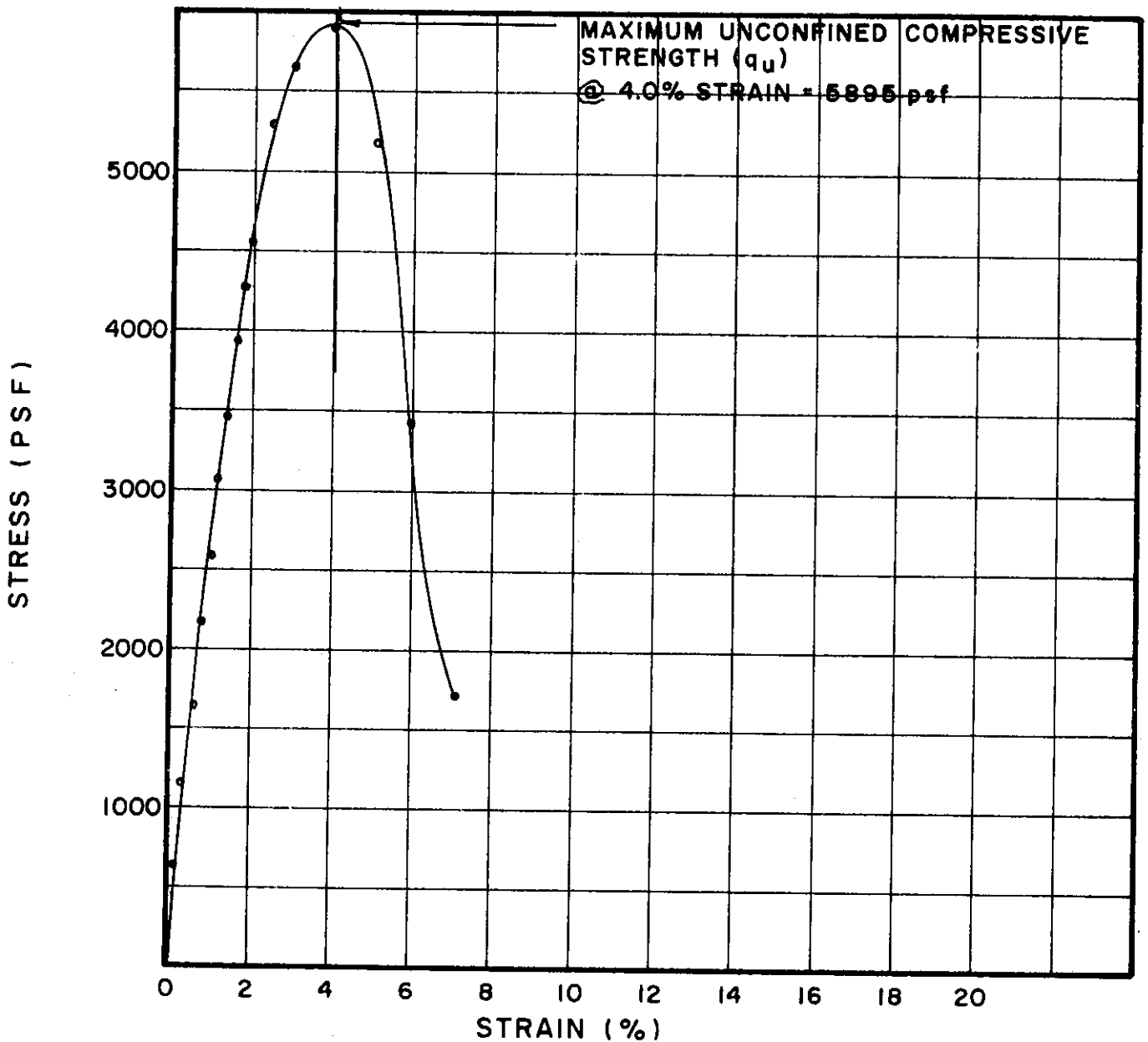

TEST NO.	TEST DATA			SOIL PROPERTIES				
	DIAMETER (INCHES)	HEIGHT (INCHES)	STRAIN RATE (%/MIN)	WATER CONTENT (%)	UNIT WEIGHT (pcf)	ATTERBERG LL (%)	LIMITS PL (%)	SOIL DESCRIPTION
U552.1	1.40	3.43	0.25	23.9	104	50	23	SILTY CLAY (CL-CH)

BORING NO. 185

SAMPLE NO. 3

DEPTH 7.5' TO 7.8'

UNCONFINED COMPRESSION TESTS

THE DETROIT EDISON COMPANY
BELLE RIVER PLANT UNITS I & II

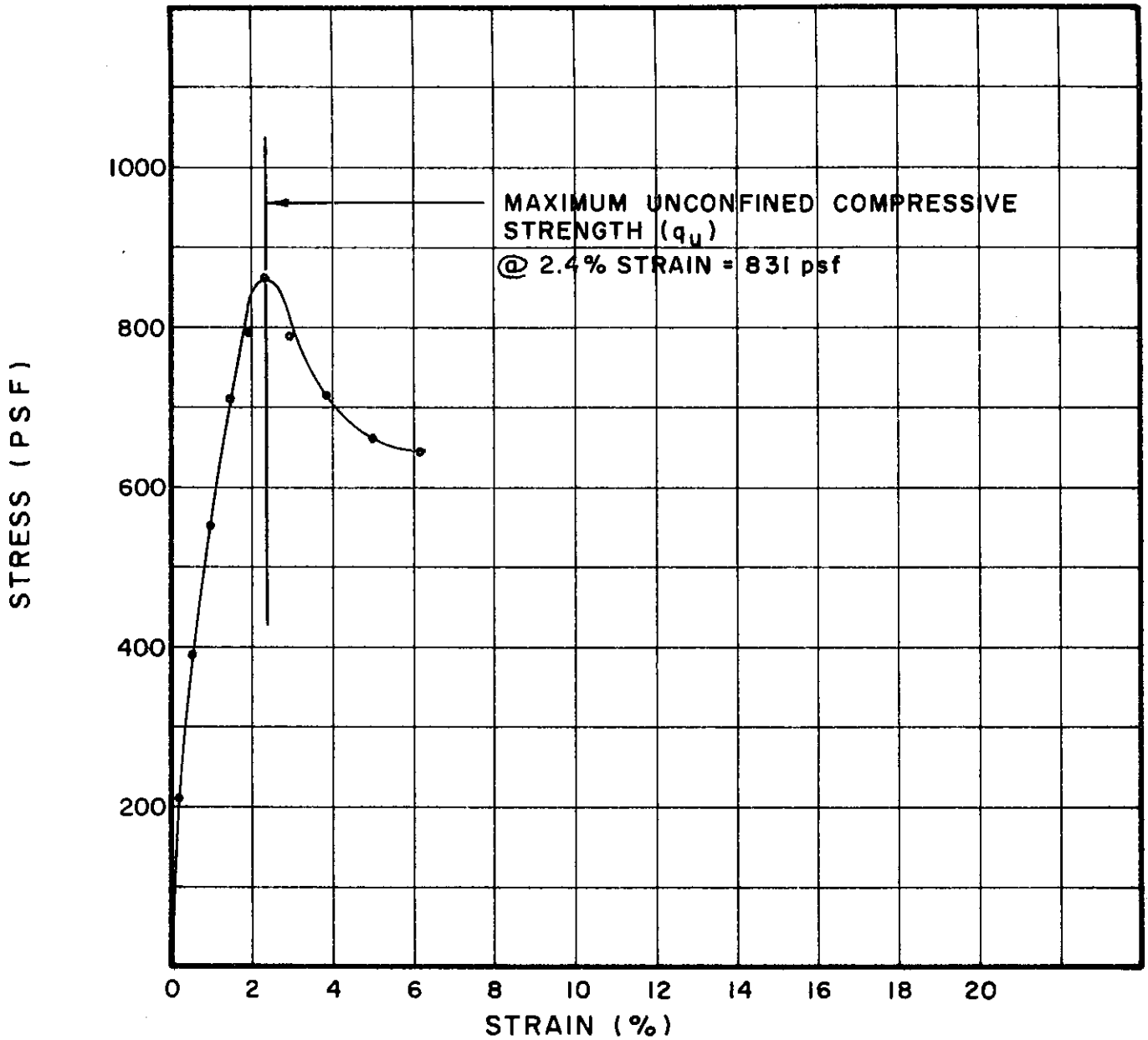

TEST NO.	TEST DATA			SOIL PROPERTIES				
	DIAMETER (INCHES)	HEIGHT (INCHES)	STRAIN RATE (%/MIN)	WATER CONTENT (%)	DRY UNIT WEIGHT (pcf)	ATTERBERG LL (%)	LIMITS PL (%)	SOIL DESCRIPTION
U554.1	1.41	3.33	0.25	39.3	81	49	22	SILTY CLAY (CL-CH)

BORING NO. 185
 SAMPLE NO. 7
 DEPTH 18.5' TO 18.8'

UNCONFINED COMPRESSION TESTS

THE DETROIT EDISON COMPANY
 BELLE RIVER PLANT UNITS I & II

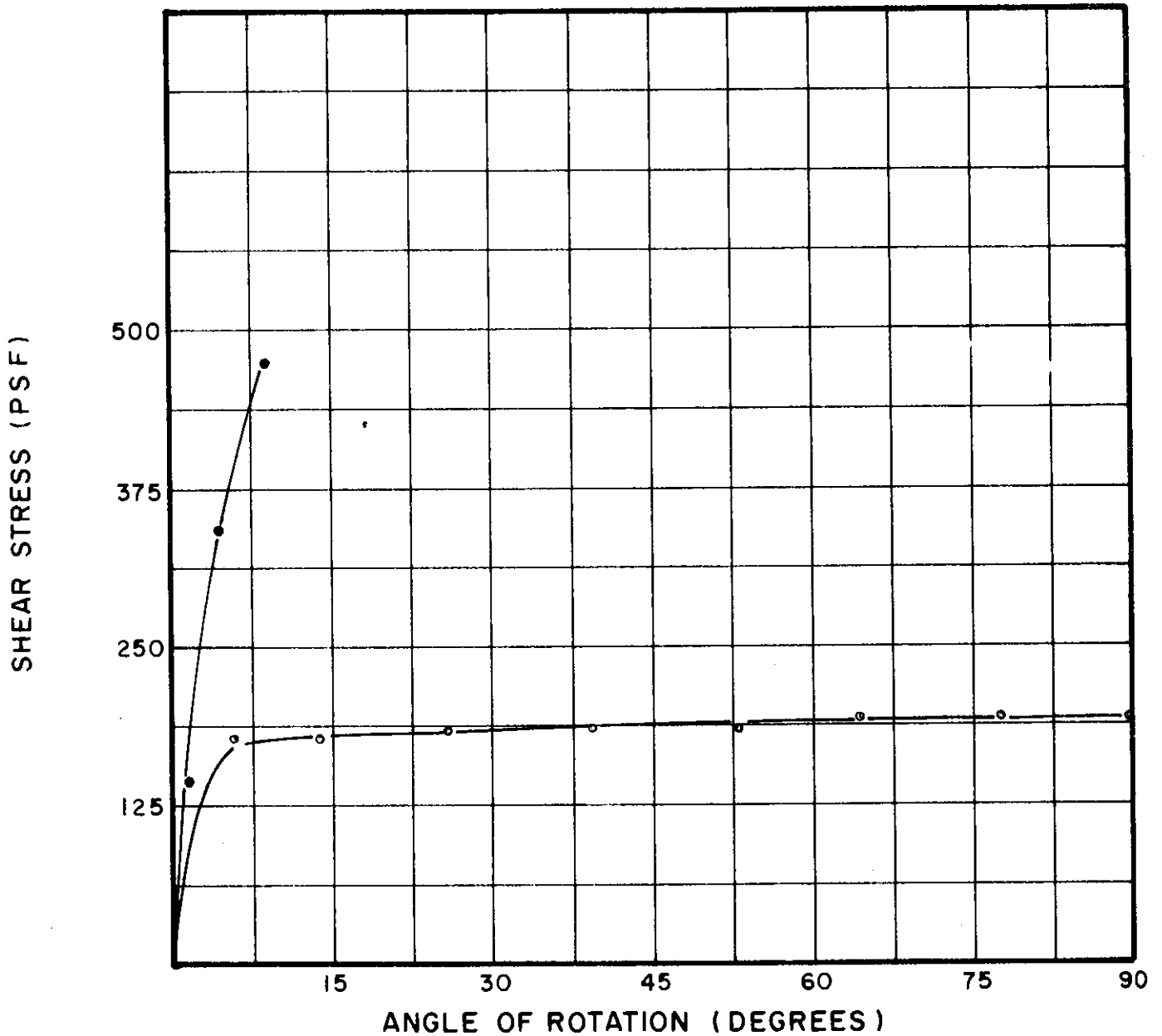

TEST NO.	TEST DATA			SOIL PROPERTIES				
	DIAMETER OF VANE (INCHES)	HEIGHT OF VANE (INCHES)	RATE OF ROTATION (°/MIN)	WATER CONTENT (%)	UNIT WEIGHT (pcf)	ATTERBERG LL (%)	LIMITS PL (%)	SOIL DESCRIPTION
VS85.1	.50	.25	6.0	35.2	82	39	18	SILTY CLAY (CL)
VS85.1	.50	.25	6.0	35.2	82	39	18	SILTY CLAY (CL)

BORING NO. 50

SAMPLE NO. 6

DEPTH 28.1' - 28.3'

LABORATORY VANE SHEAR TESTS

THE DETROIT EDISON COMPANY
BELLE RIVER PLANT UNITS I & II

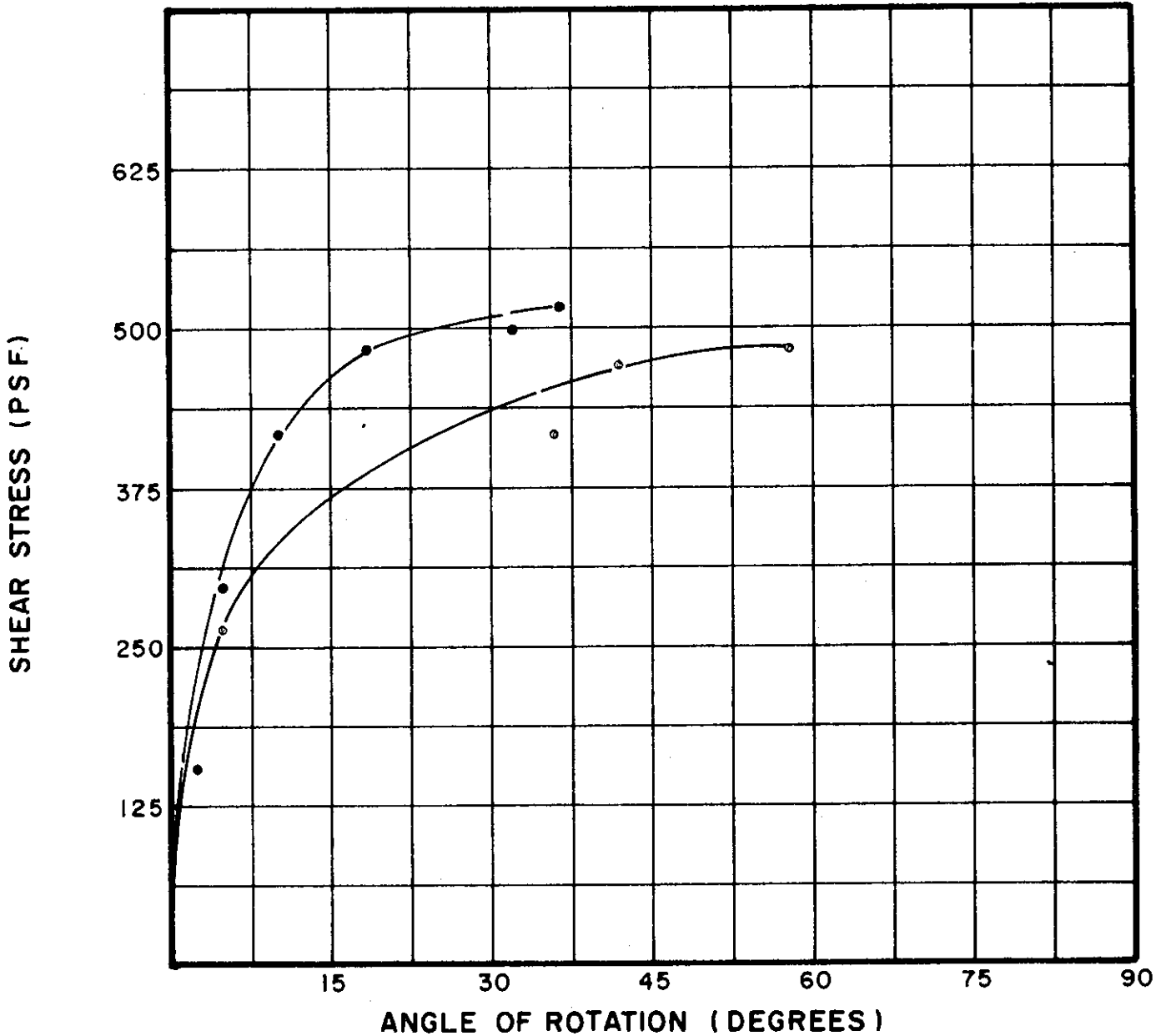

TEST NO.	TEST DATA			SOIL PROPERTIES				
	DIAMETER OF VANE (INCHES)	HEIGHT OF VANE (INCHES)	RATE OF ROTATION (°/MIN)	WATER CONTENT (%)	UNIT WEIGHT (pcf)	ATTERBERG LL (%)	LIMITS PL (%)	SOIL DESCRIPTION
VS87.1	.50	.25	6.0	25.9	96	36	16	SILTY CLAY, SANDY (CL)
VS87.1	.50	.25	6.0	25.9	96	36	16	SILTY CLAY, SANDY (CL)

BORING NO. 50
 SAMPLE NO. 10
 DEPTH 48.1' - 48.4'

LABORATORY VANE SHEAR TESTS
 THE DETROIT EDISON COMPANY
 BELLE RIVER PLANT UNITS I & II

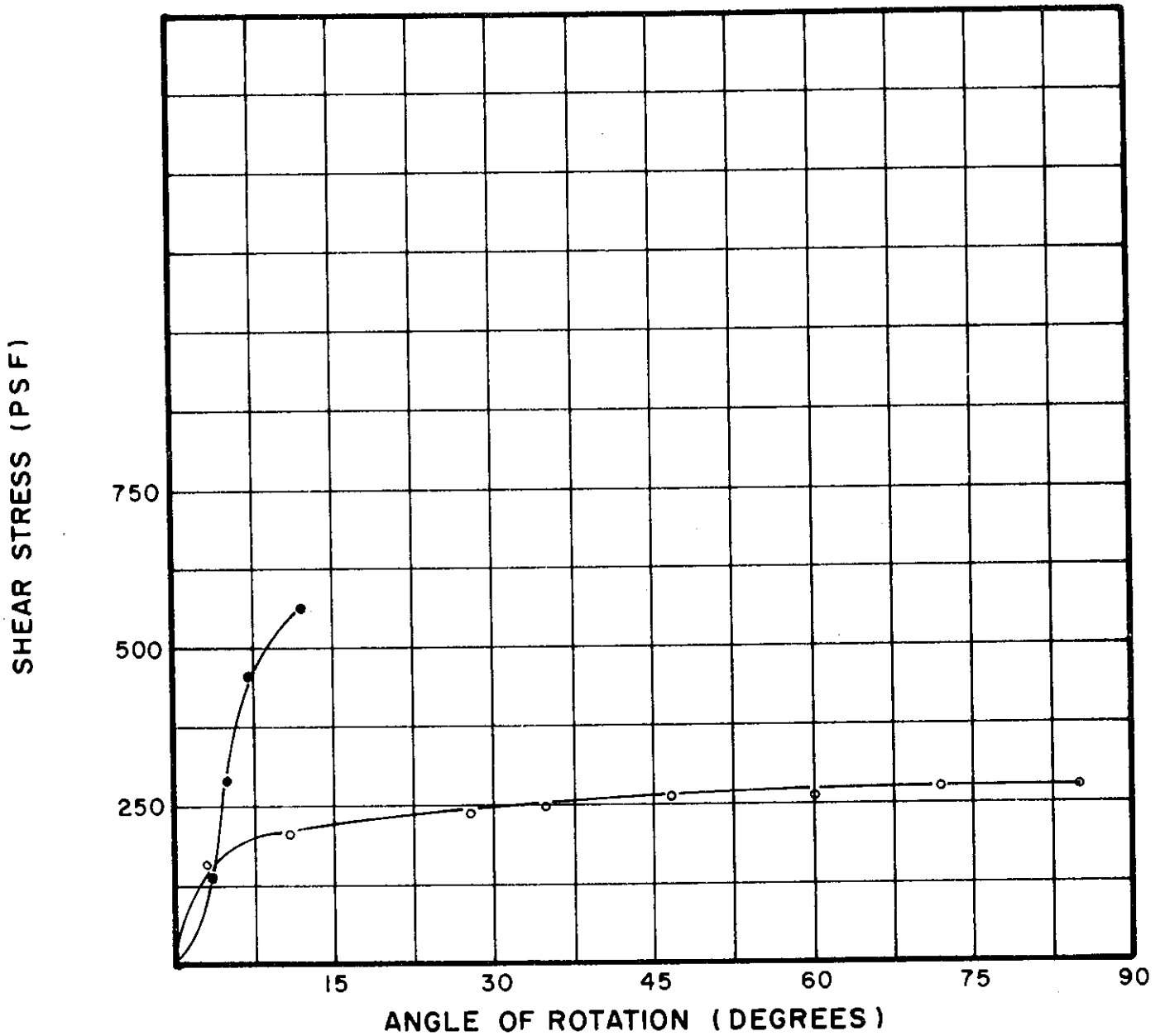

TEST NO.	TEST DATA			SOIL PROPERTIES				
	DIAMETER OF VANE (INCHES)	HEIGHT OF VANE (INCHES)	RATE OF ROTATION (°/MIN)	WATER CONTENT (%)	UNIT WEIGHT (pcf)	ATTERBERG LL (%)	LIMITS PL (%)	SOIL DESCRIPTION
VSI09.1 ●	.50	.25	6.0	30.5	89	35	18	SILTY CLAY (CL)
rVSI09.1 ○	.50	.25	6.0	30.5	89	35	18	SILTY CLAY (CL)

BORING NO. 52
 SAMPLE NO. 4
 DEPTH 28.9' - 29.2'

LABORATORY VANE SHEAR TESTS

THE DETROIT EDISON COMPANY
 BELLE RIVER PLANT UNITS I & II

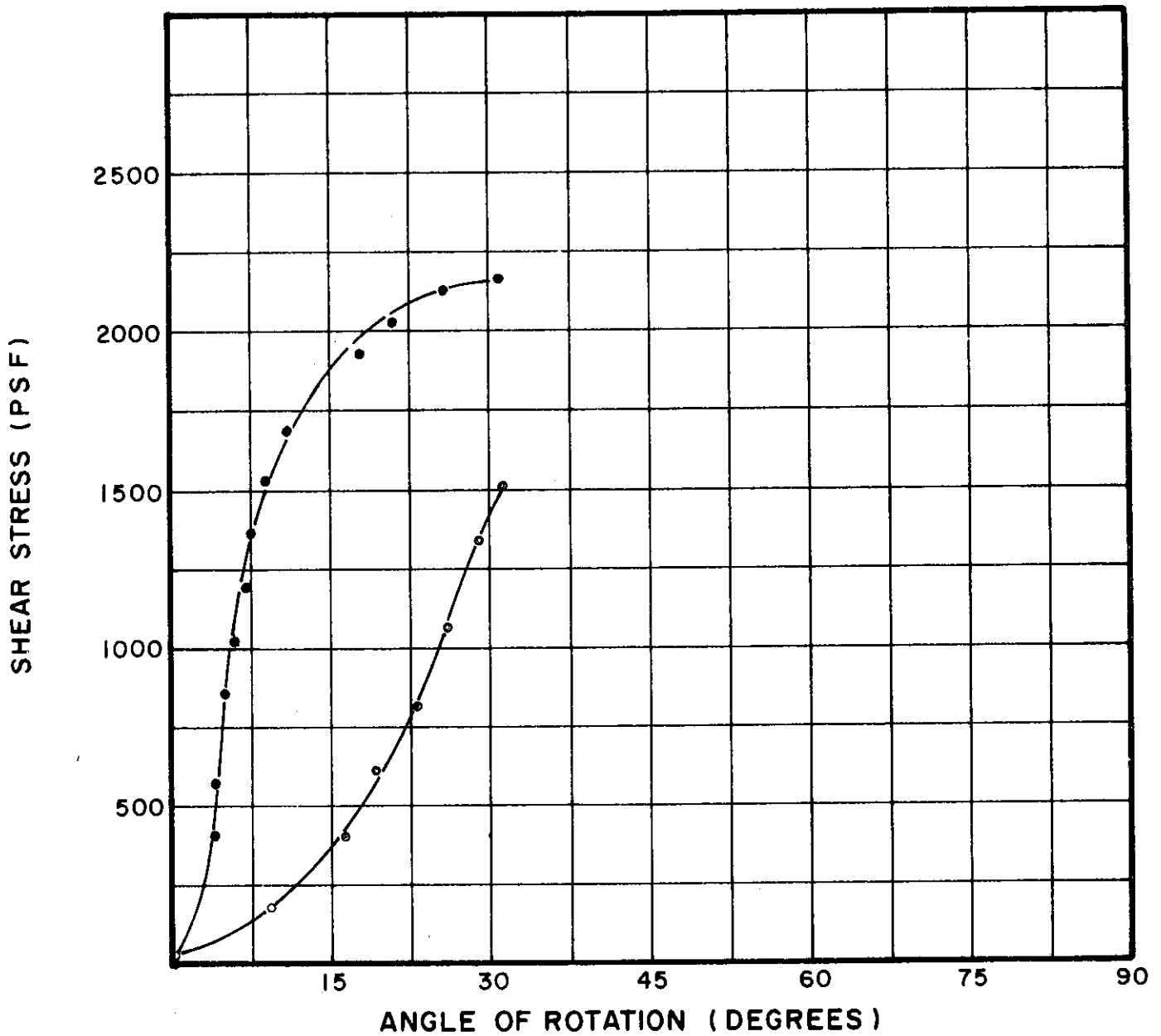

TEST NO.	TEST DATA			SOIL PROPERTIES			SOIL DESCRIPTION
	DIAMETER OF VANE (INCHES)	HEIGHT OF VANE (INCHES)	RATE OF ROTATION (°/MIN)	WATER CONTENT (%)	UNIT WEIGHT (pcf)	ATTERBERG LIMITS LL (%) PL (%)	
VS111.1 ●	.50	.25	6.0	23.6	101		SILTY CLAY, SANDY (CL)
VS111.1 ○	.50	.25	6.0	23.6	101		SILTY CLAY, SANDY (CL)

BORING NO. 52

SAMPLE NO. 6

DEPTH 49.6' - 49.8'

LABORATORY VANE SHEAR TESTS

THE DETROIT EDISON COMPANY
BELLE RIVER PLANT UNITS I & II

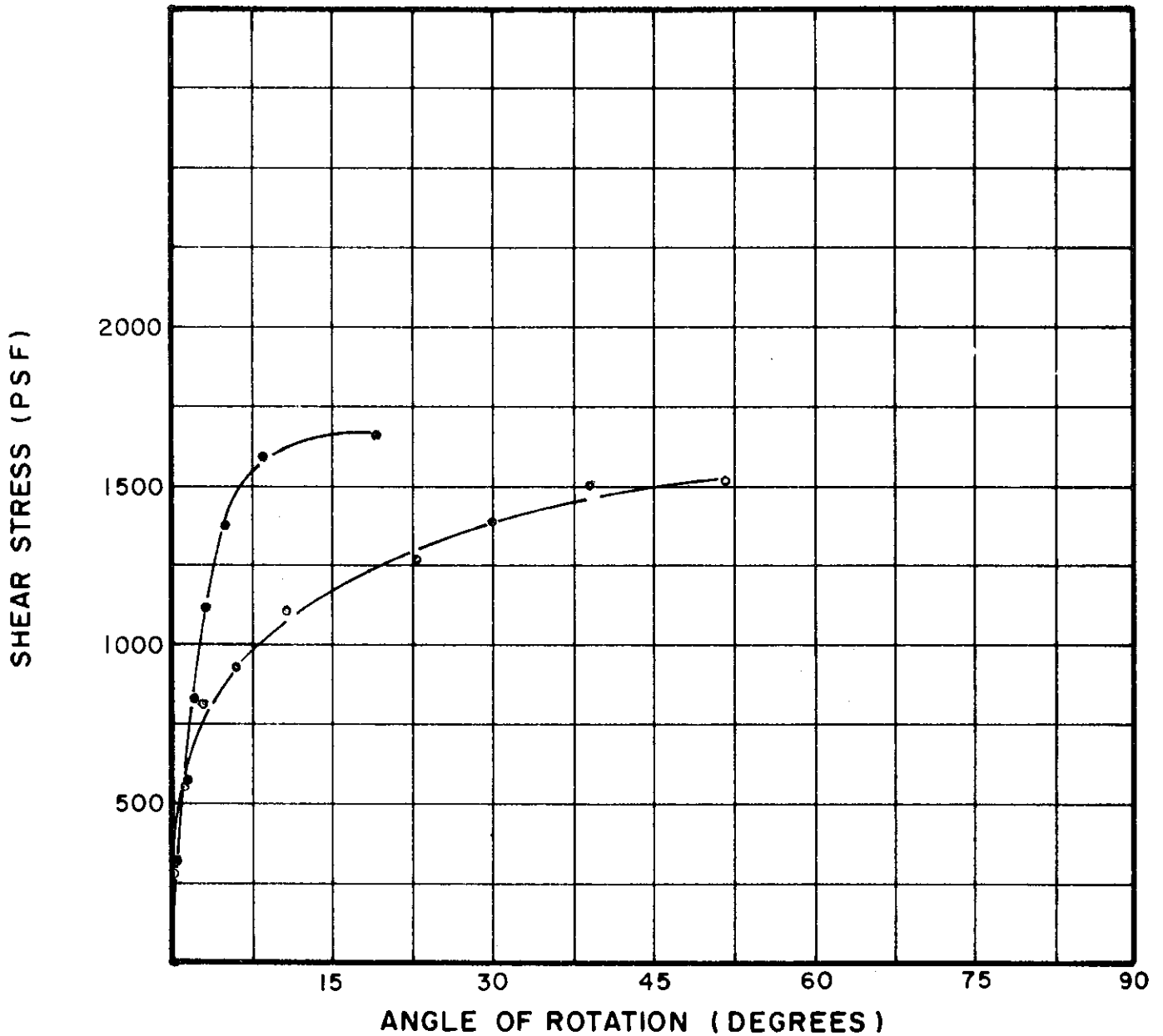

TEST NO.	TEST DATA			SOIL PROPERTIES				
	DIAMETER OF VANE (INCHES)	HEIGHT OF VANE (INCHES)	RATE OF ROTATION (°/MIN)	WATER CONTENT (%)	UNIT WEIGHT (pcf)	ATTERBERG LL (%)	LIMITS PL (%)	SOIL DESCRIPTION
VS115.1	.50	.25	6.0	26.4	96	39	18	SILTY CLAY, SANDY (CL)
VS115.1	.50	.25	6.0	26.4	96	39	18	SILTY CLAY, SANDY (CL)

BORING NO. 52
 SAMPLE NO. 10
 DEPTH 89.1' - 89.4'

LABORATORY VANE SHEAR TESTS

THE DETROIT EDISON COMPANY
 BELLE RIVER PLANT UNITS I & II

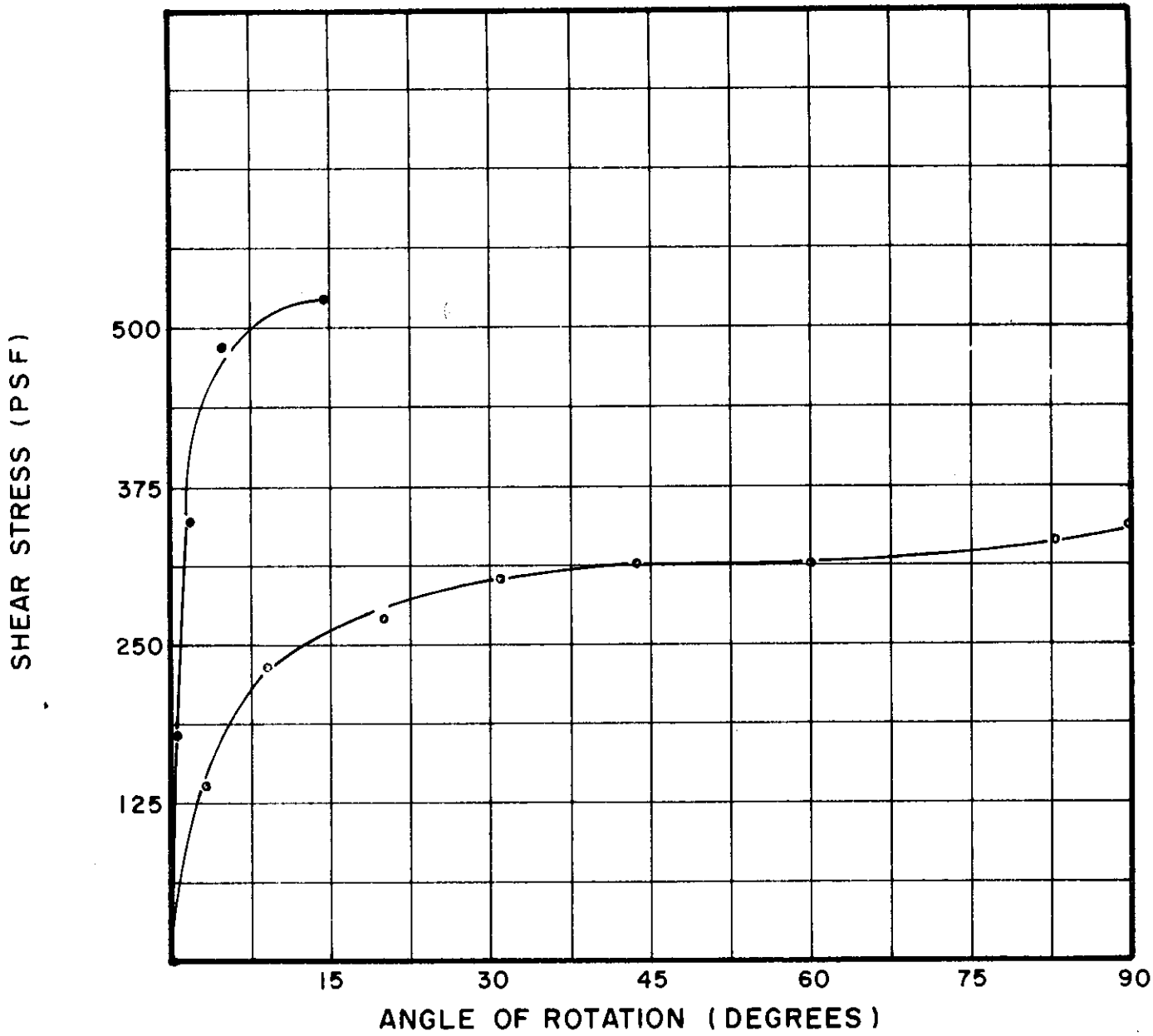

TEST NO.	TEST DATA			SOIL PROPERTIES				
	DIAMETER OF VANE (INCHES)	HEIGHT OF VANE (INCHES)	RATE OF ROTATION (°/MIN)	WATER CONTENT (%)	UNIT WEIGHT (pcf)	ATTERBERG LL (%)	LIMITS PL (%)	SOIL DESCRIPTION
VS99.2 ●	.50	.25	6.0	27.3	94	43	18	SILTY CLAY (CL)
rVS99.2 ○	.50	.25	6.0	27.3	94	43	18	SILTY CLAY (CL)

BORING NO. 53
 SAMPLE NO. 6
 DEPTH 49.7' - 50.0'

LABORATORY VANE SHEAR TESTS
 THE DETROIT EDISON COMPANY
 BELLE RIVER PLANT UNITS I & II

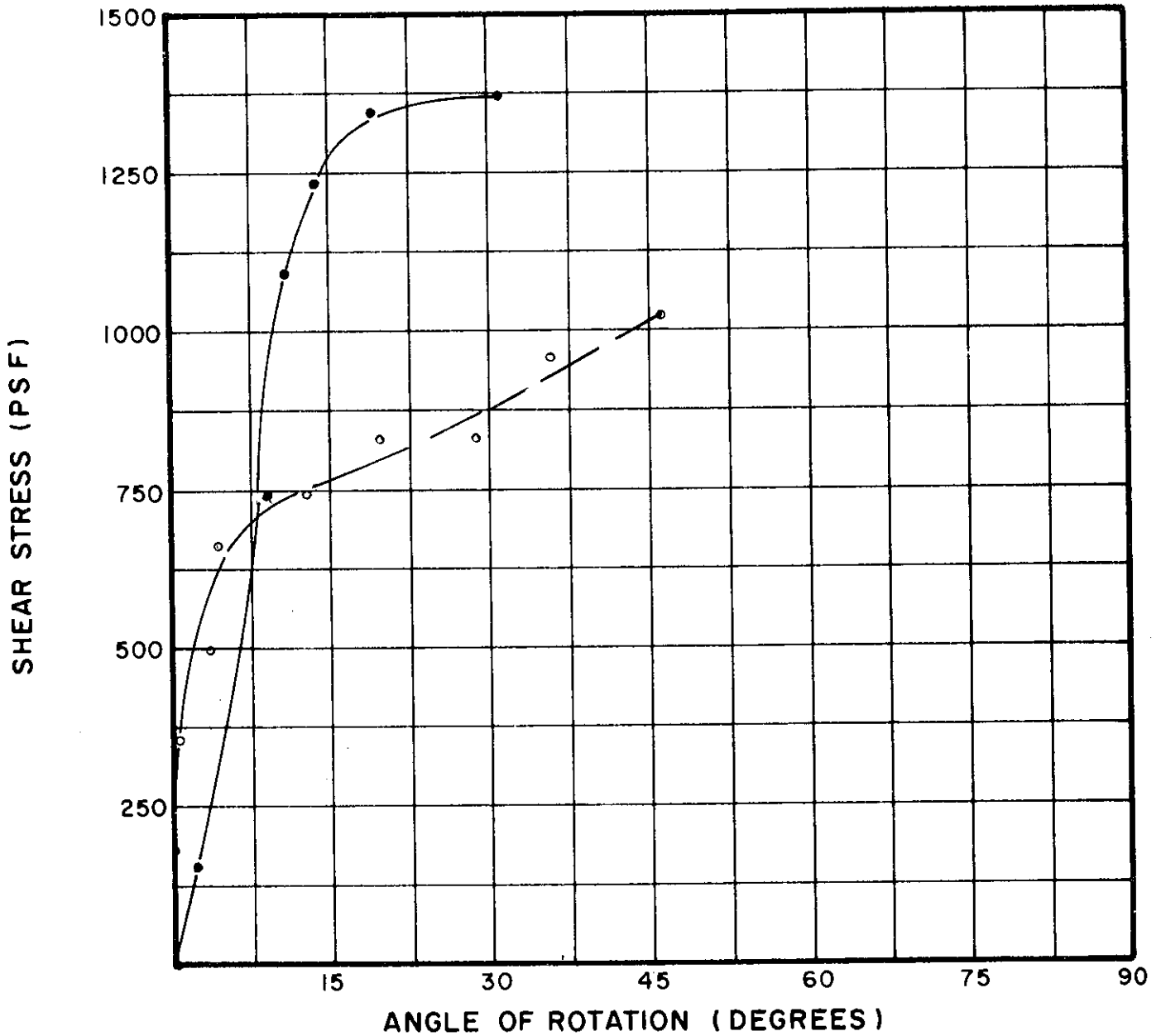

TEST NO.	TEST DATA			SOIL PROPERTIES				
	DIAMETER OF VANE (INCHES)	HEIGHT OF VANE (INCHES)	RATE OF ROTATION (°/MIN)	WATER CONTENT (%)	UNIT WEIGHT (pcf)	ATTERBERG LL (%)	LIMITS PL (%)	SOIL DESCRIPTION
VS101.1	.50	.25	6.0	27.9	95	39	21	SILTY CLAY (CL)
rVS101.1	.50	.25	6.0	27.9	95	39	21	SILTY CLAY (CL)

BORING NO. 53
 SAMPLE NO. 9
 DEPTH 79.5' - 79.8'

LABORATORY VANE SHEAR TESTS

THE DETROIT EDISON COMPANY
 BELLE RIVER PLANT UNITS I & II

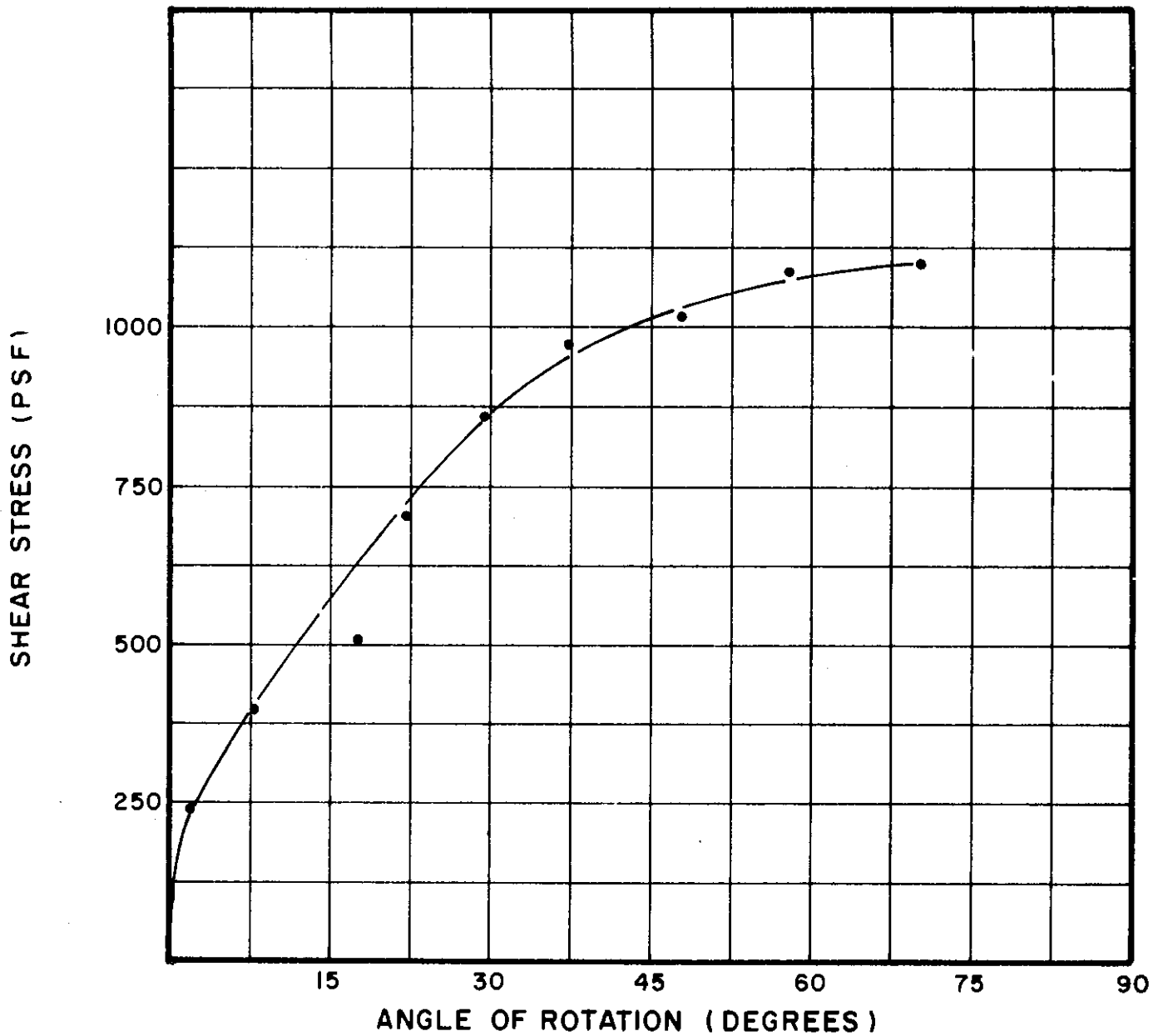

TEST NO.	TEST DATA			SOIL PROPERTIES				
	DIAMETER OF VANE (INCHES)	HEIGHT OF VANE (INCHES)	RATE OF ROTATION (°/MIN)	WATER CONTENT (%)	UNIT WEIGHT (pcf)	ATTERBERG LL (%)	LIMITS PL (%)	SOIL DESCRIPTION
VS398.1	.50	.25	6.0	27.5	92	38	17	SILTY CLAY, SANDY (CL)

BORING NO. 54

SAMPLE NO. 5

DEPTH 59.7' - 60.0'

LABORATORY VANE SHEAR TESTS

THE DETROIT EDISON COMPANY
BELLE RIVER PLANT UNITS I & II

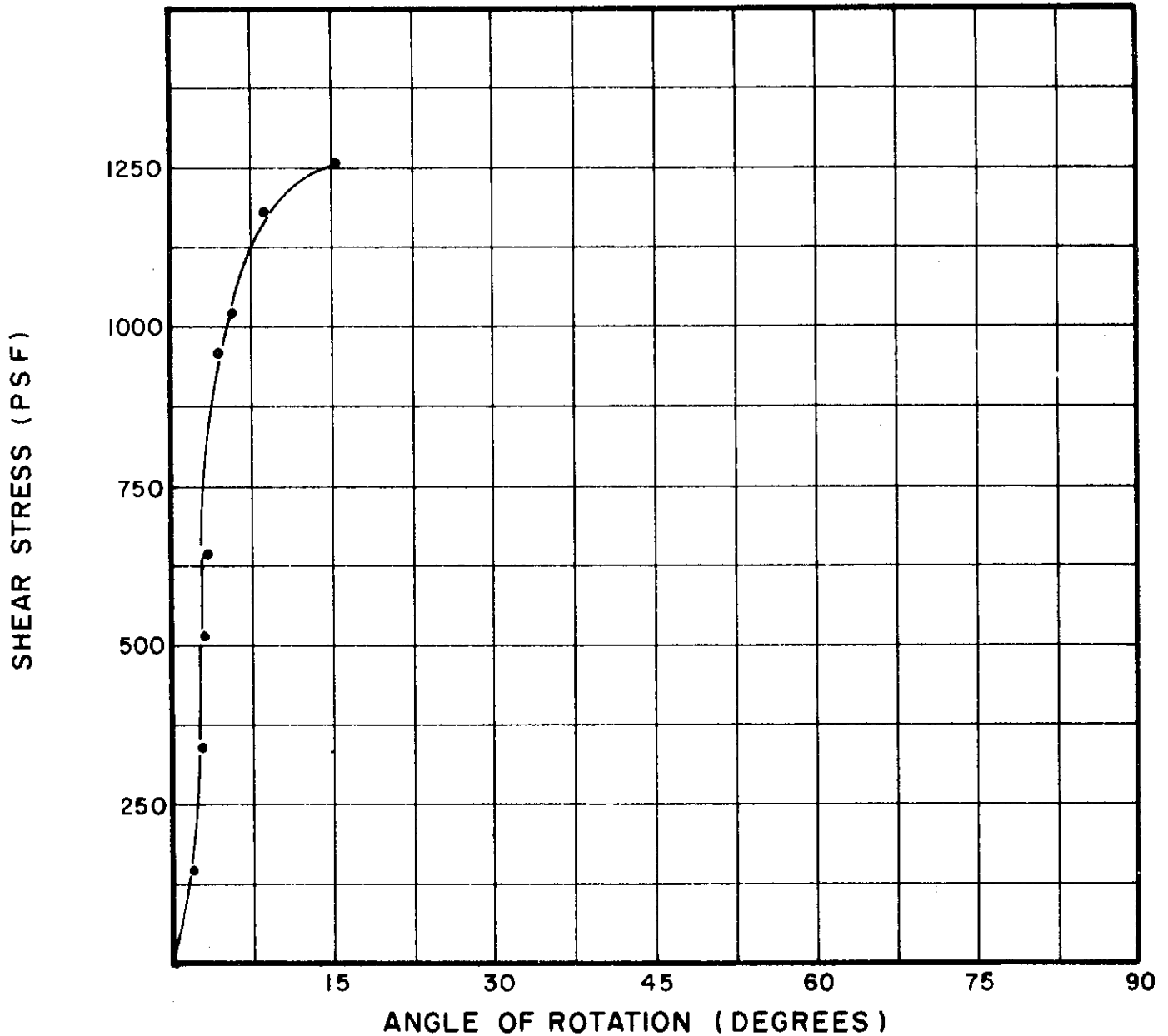

TEST NO.	TEST DATA			SOIL PROPERTIES				
	DIAMETER OF VANE (INCHES)	HEIGHT OF VANE (INCHES)	RATE OF ROTATION (°/MIN)	WATER CONTENT (%)	UNIT WEIGHT (pcf)	ATTERBERG LL (%)	LIMITS PL (%)	SOIL DESCRIPTION
VS76.1	.50	.25	6.0	32.8	90	48	20	SILTY CLAY (CL-CH)

BORING NO. 59
 SAMPLE NO. 3
 DEPTH 18.5' - 18.8'

LABORATORY VANE SHEAR TESTS

THE DETROIT EDISON COMPANY
 BELLE RIVER PLANT UNITS I & II

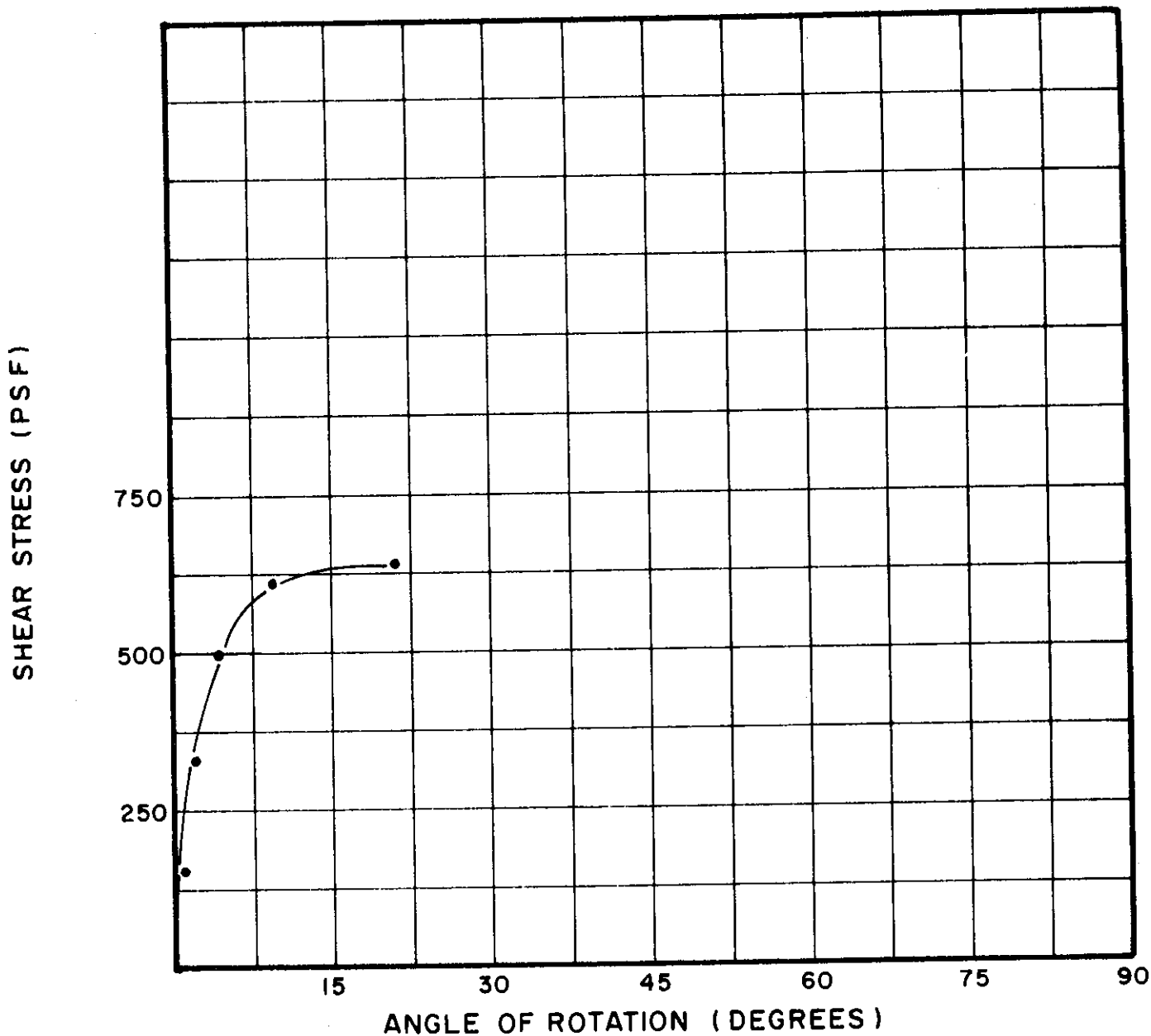

TEST NO.	TEST DATA			SOIL PROPERTIES				
	DIAMETER OF VANE (INCHES)	HEIGHT OF VANE (INCHES)	RATE OF ROTATION (°/MIN)	WATER CONTENT (%)	UNIT WEIGHT (pcf)	ATTERBERG LL (%)	LIMITS PL (%)	SOIL DESCRIPTION
VS78.1	.50	.25	6.0	25.6	96	38	18	SILTY CLAY, SANDY (CL)

BORING NO. 59
 SAMPLE NO. 5
 DEPTH 39.4' - 39.7'

LABORATORY VANE SHEAR TESTS

THE DETROIT EDISON COMPANY
 BELLE RIVER PLANT UNITS I & II

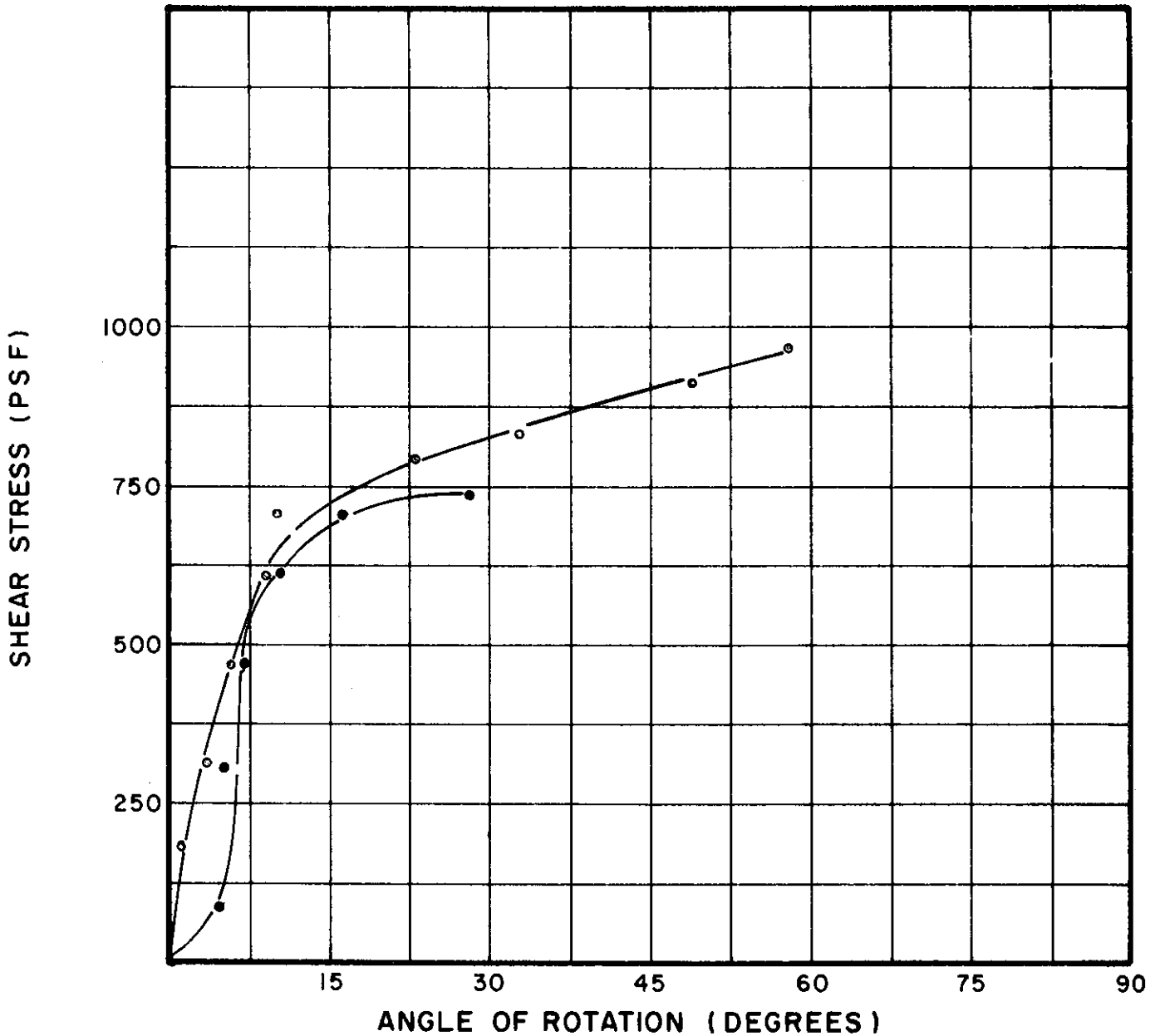

TEST NO.	TEST DATA			SOIL PROPERTIES				
	DIAMETER OF VANE (INCHES)	HEIGHT OF VANE (INCHES)	RATE OF ROTATION (%/MIN)	WATER CONTENT (%)	UNIT WEIGHT (pcf)	ATTERBERG LL (%)	LIMITS PL (%)	SOIL DESCRIPTION
VS80.1	.50	.25	6.0	24.1	102	36	18	SILTY CLAY, SANDY (CL)
rVS80.1	.50	.25	6.0	24.1	102	36	18	SILTY CLAY, SANDY (CL)

BORING NO. 59
 SAMPLE NO. 7
 DEPTH 59.0' - 59.3'

LABORATORY VANE SHEAR TESTS

THE DETROIT EDISON COMPANY
 BELLE RIVER PLANT UNITS I & II

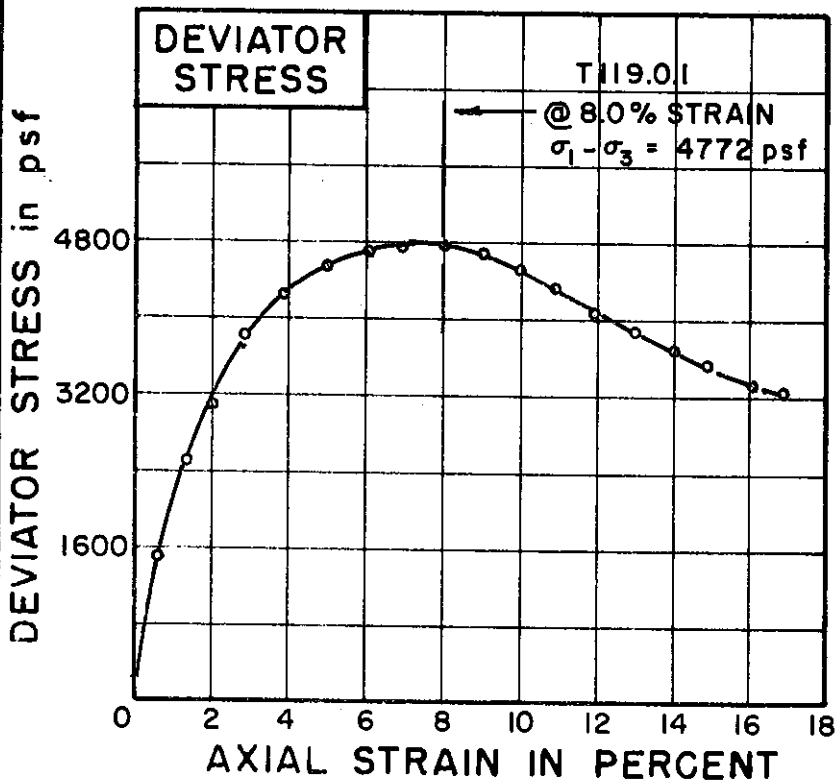
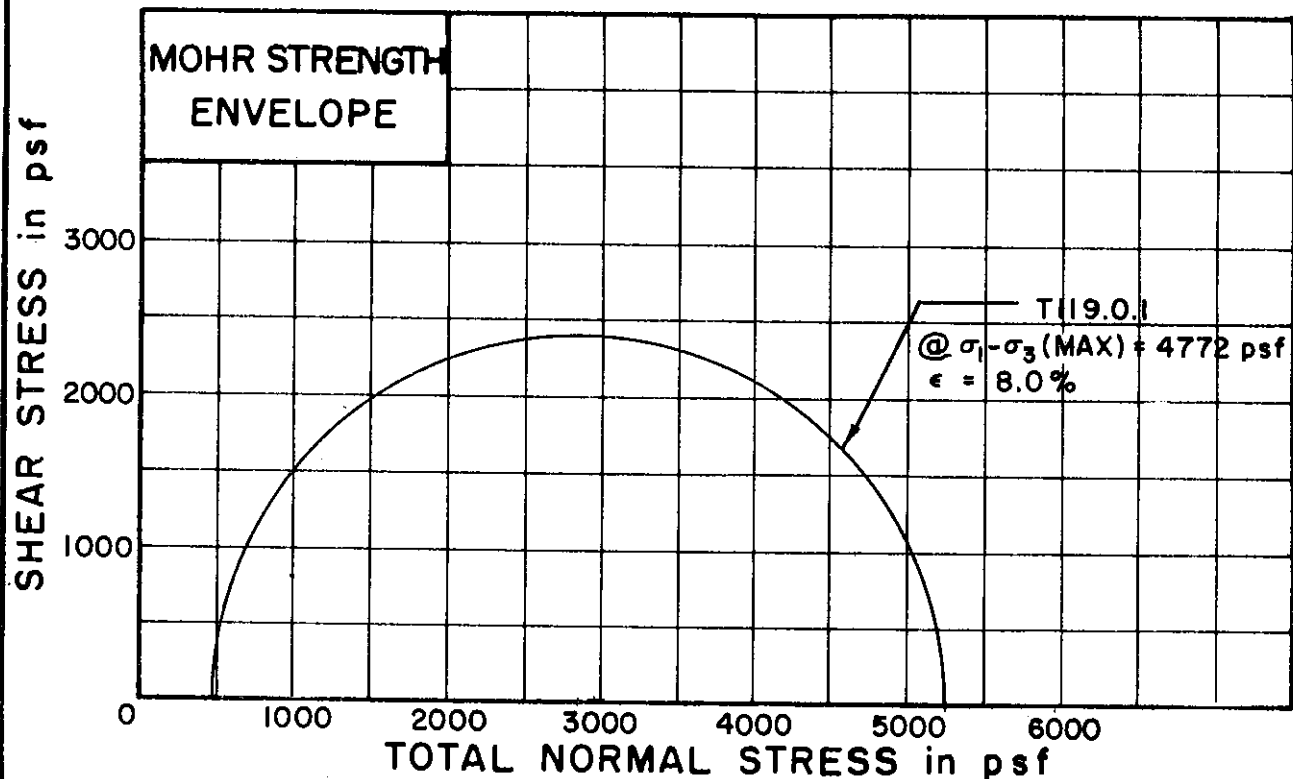

TEST NO./SYMBOL	T119.0.1		
-----------------	----------	--	--

INITIAL WATER CONTENT	w_0	25.4%	
DRY DENSITY pcf	γ_d	101	
SAMPLE DIAMETER in.	D_0	1.40	
SAMPLE HEIGHT in.	H_0	3.41	

CONFINING PRESSURE psf	σ_3	475	
RATE OF STRAIN PERCENT/MINUTE		0.26	

FINAL WATER CONTENT	w_f	25.1%	
SKETCH OF SAMPLE AT END OF TEST			

BORING NO. 15

SAMPLE NO. 2

DEPTH 3.7' TO 4.1'

SOIL DESCRIPTION: SILTY CLAY (CL)

LIQUID LIMIT 45 PLASTIC LIMIT 21

**UNCONSOLIDATED UNDRAINED
TRIAxIAL COMPRESSION
TESTS**

THE DETROIT EDISON COMPANY
BELLE RIVER PLANT UNITS I & II

SHEAR STRESS in psf

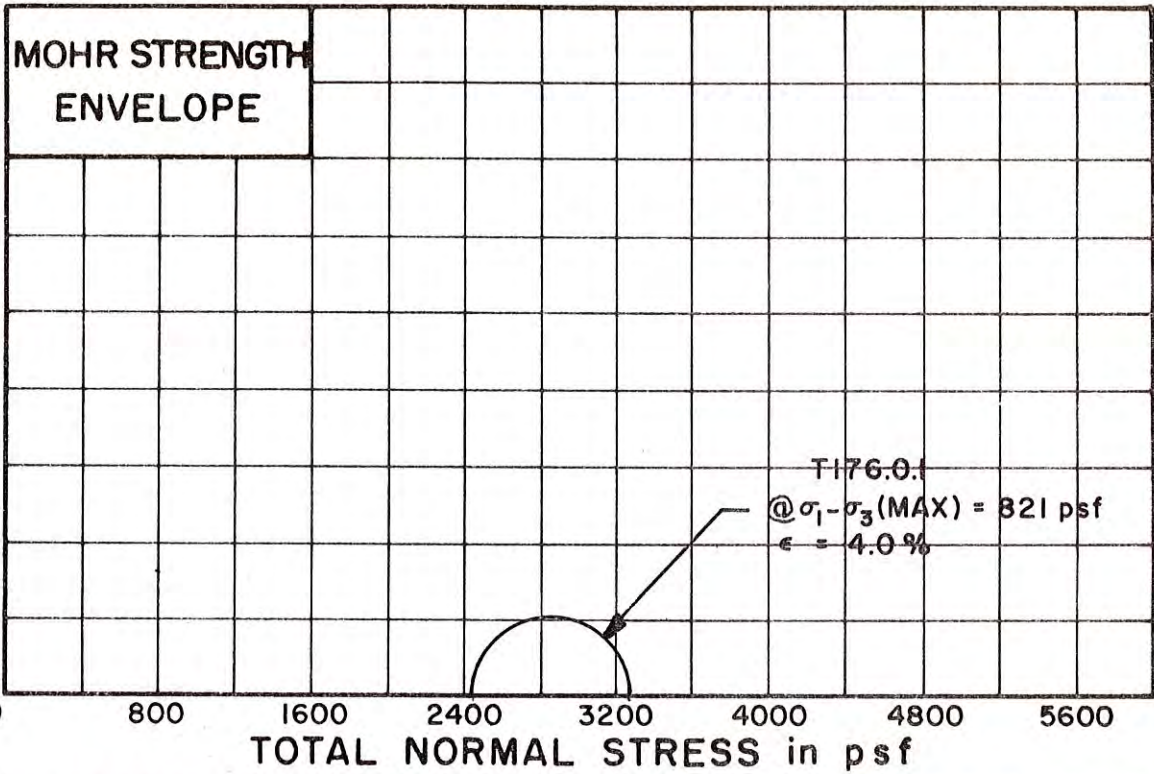

DEVIATOR STRESS in psf

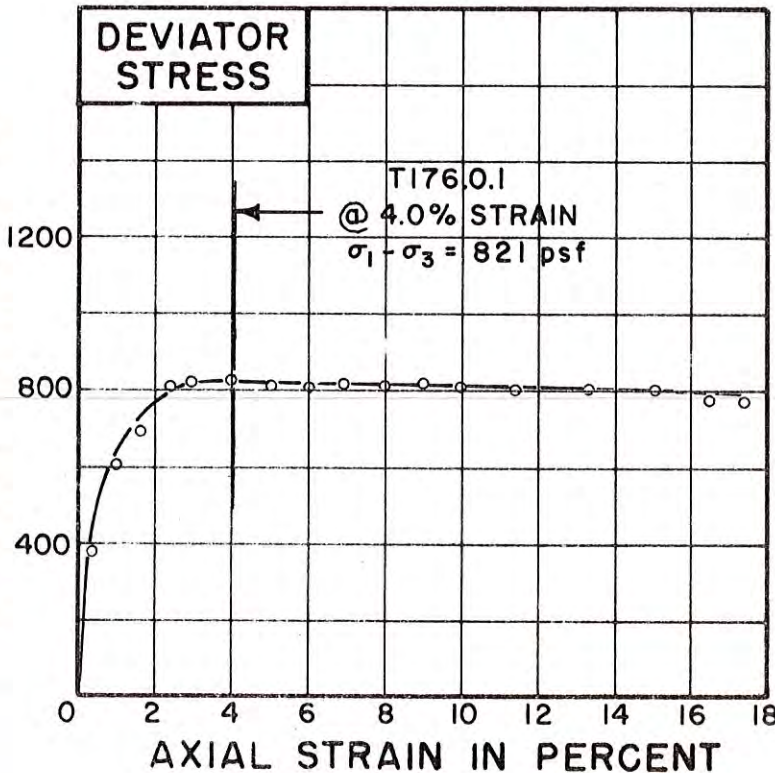

TEST NO./SYMBOL T176.0.1

INITIAL WATER CONTENT w_o 39.9%

DRY DENSITY ρ_{cf} γ_d 83

SAMPLE DIAMETER, in. D_o 1.37

SAMPLE HEIGHT in. H_o 3.29

CONFINING PRESSURE σ_3 2448

RATE OF STRAIN PERCENT/MINUTE 0.26

FINAL WATER CONTENT w_f 39.8%

SKETCH OF SAMPLE AT END OF TEST

BORING NO. 18

SAMPLE NO. 3

DEPTH 20.6' TO 20.9'

SOIL DESCRIPTION: SILTY CLAY (CL)

LIQUID LIMIT 44 PLASTIC LIMIT 21

UNCONSOLIDATED UNDRAINED TRIAXIAL COMPRESSION TESTS

THE DETROIT EDISON COMPANY
 BELLE RIVER PLANT UNITS I & II

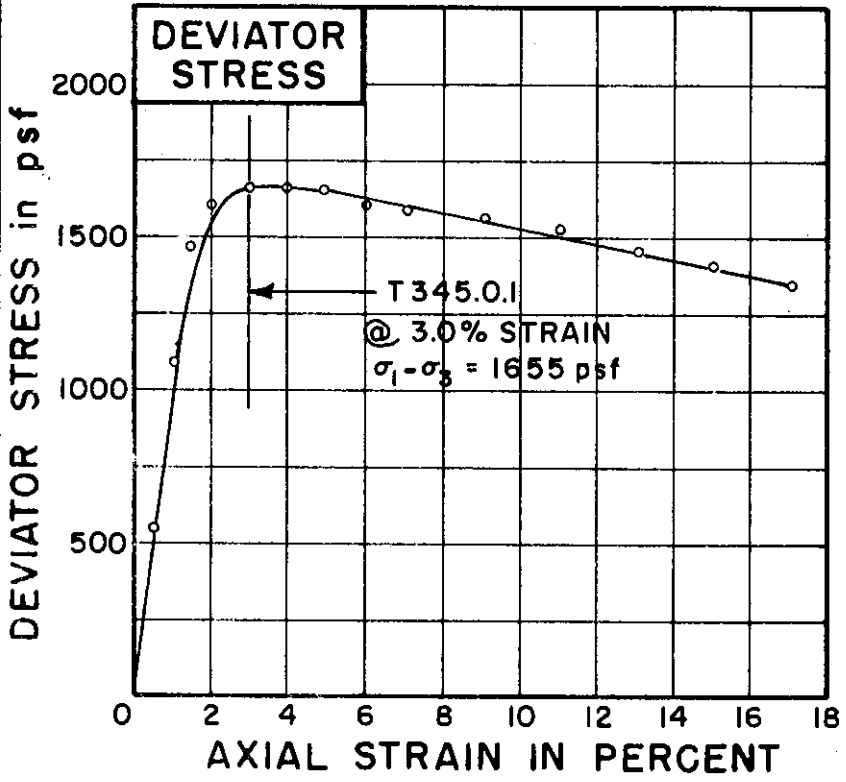
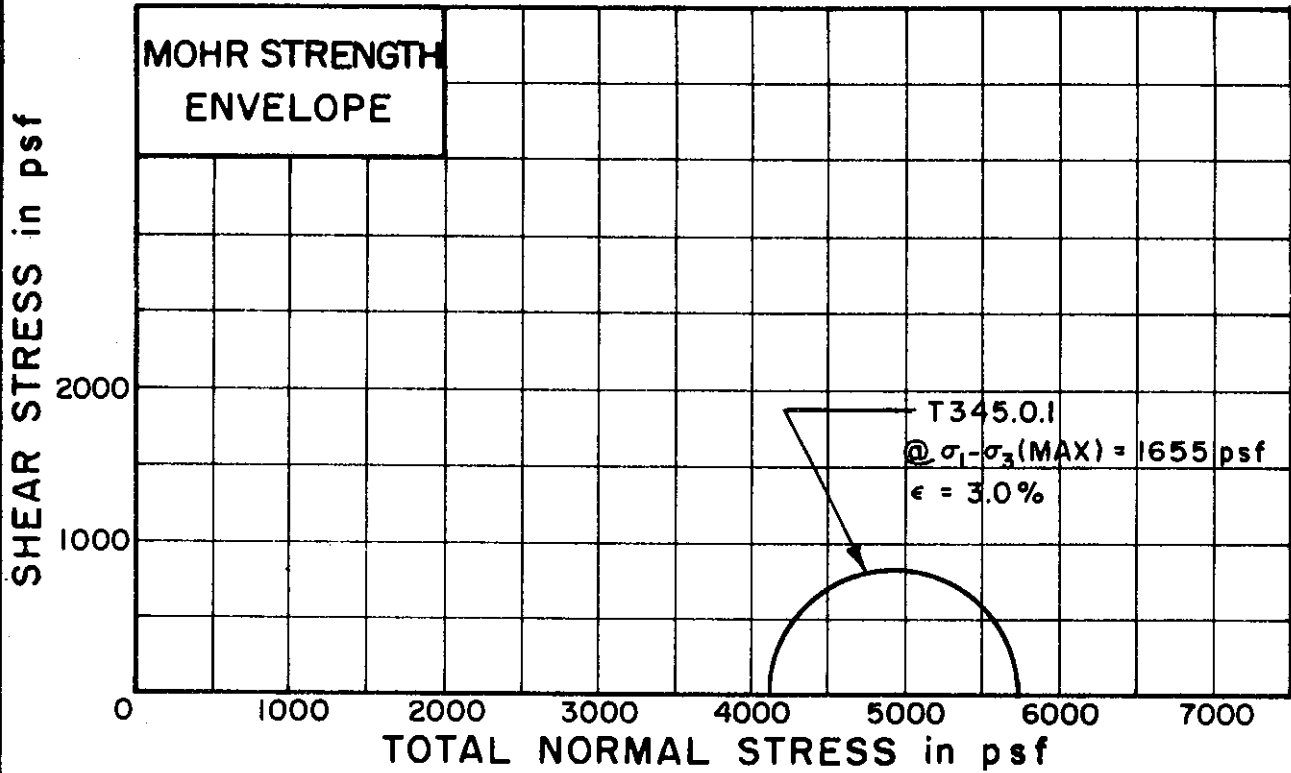

TEST NO./SYMBOL	T345.0.1		
-----------------	----------	--	--

INITIAL WATER CONTENT	w_0	31.0%		
DRY DENSITY pcf	γ_d	92		
SAMPLE DIAMETER in.	D_0	1.41		
SAMPLE HEIGHT in.	H_0	3.34		

CONFINING PRESSURE psf	σ_3	4104		
RATE OF STRAIN PERCENT/MINUTE		0.27		

FINAL WATER CONTENT	w_f	30.8%		
SKETCH OF SAMPLE AT END OF TEST				

BORING NO. 18

SAMPLE NO. 6

DEPTH 51.4' TO 51.7'

SOIL DESCRIPTION: SILTY CLAY (CL)

LIQUID LIMIT 39 PLASTIC LIMIT 18

UNCONSOLIDATED UNDRAINED TRIAXIAL COMPRESSION TESTS

THE DETROIT EDISON COMPANY
BELLE RIVER PLANT UNITS I & II

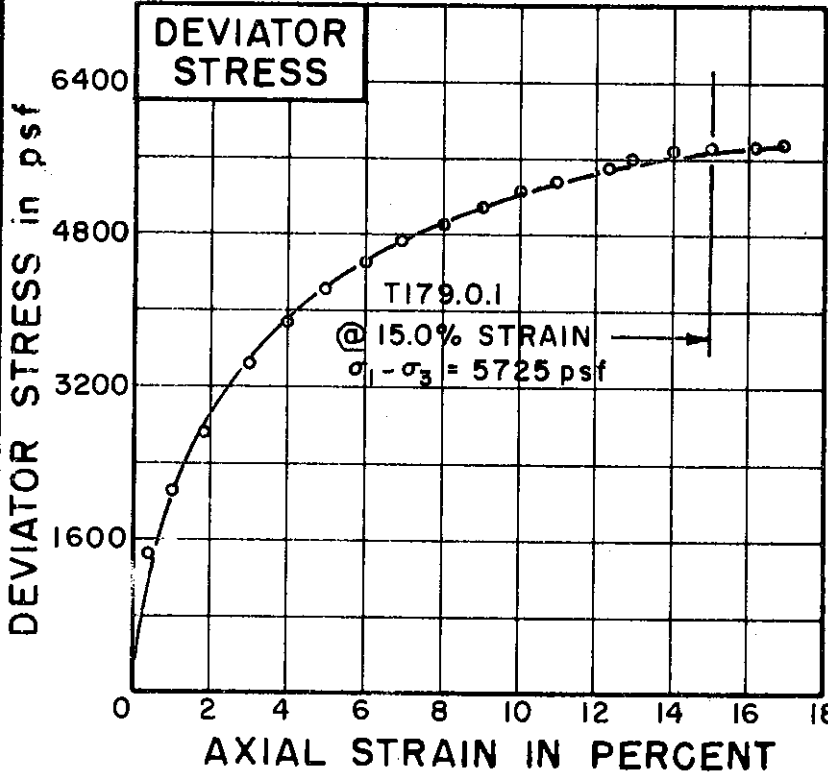
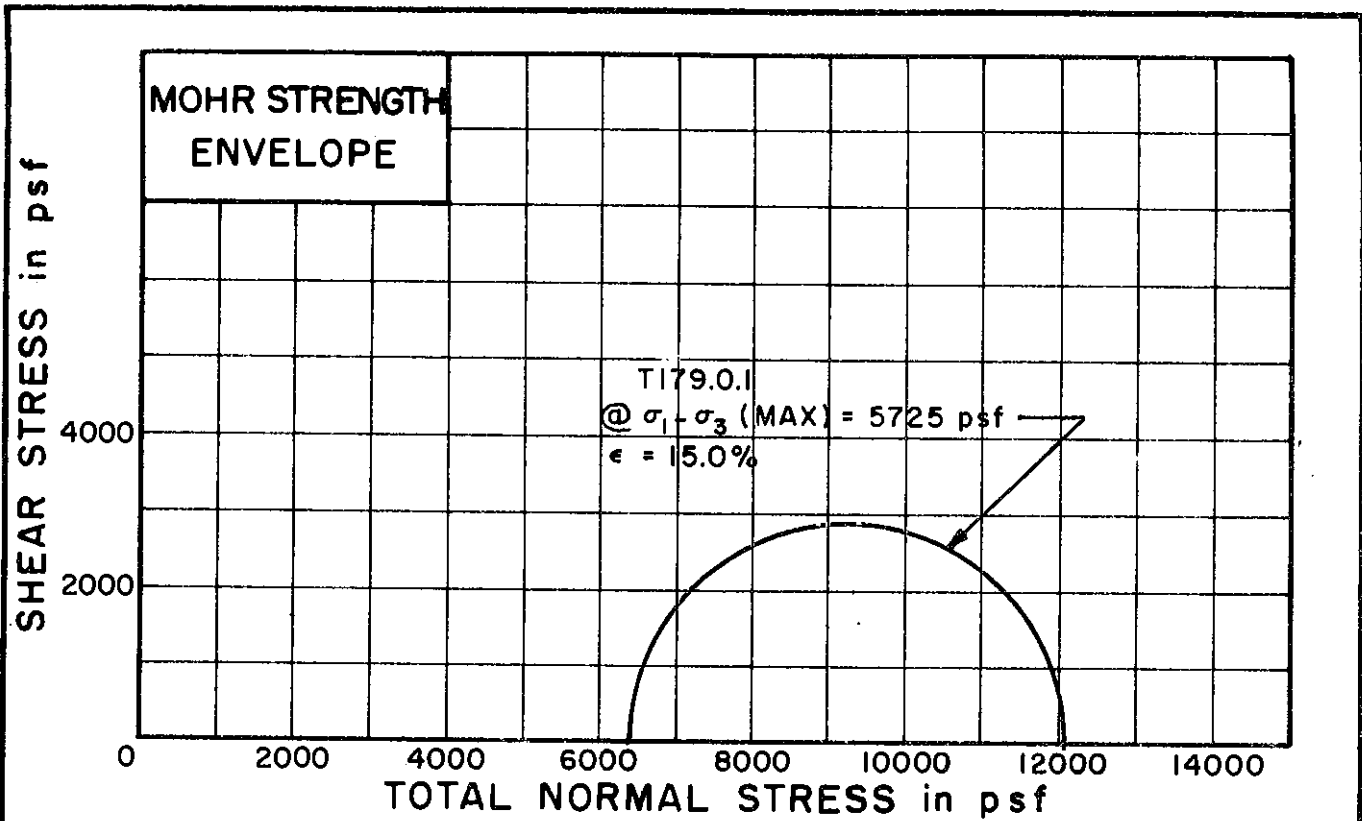

TEST NO./SYMBOL	T179.0.1		
-----------------	----------	--	--

INITIAL WATER CONTENT	w ₀	17.3%	
DRY DENSITY	ρ _d	111	
SAMPLE DIAMETER	D ₀	1.36	
SAMPLE HEIGHT	H ₀	3.22	

CONFINING PRESSURE	σ ₃	6336	
RATE OF STRAIN		0.26	

FINAL WATER CONTENT	w _f	17.2%	
SKETCH OF SAMPLE AT END OF TEST			

BORING NO. 18
 SAMPLE NO. 10
 DEPTH 88.8' TO 90.1'

SOIL DESCRIPTION: SILTY CLAY, SANDY (CL)
 LIQUID LIMIT 29 PLASTIC LIMIT 15

UNCONSOLIDATED UNDRAINED
 TRIAXIAL COMPRESSION
 TESTS

THE DETROIT EDISON COMPANY
 BELLE RIVER PLANT UNITS I & II

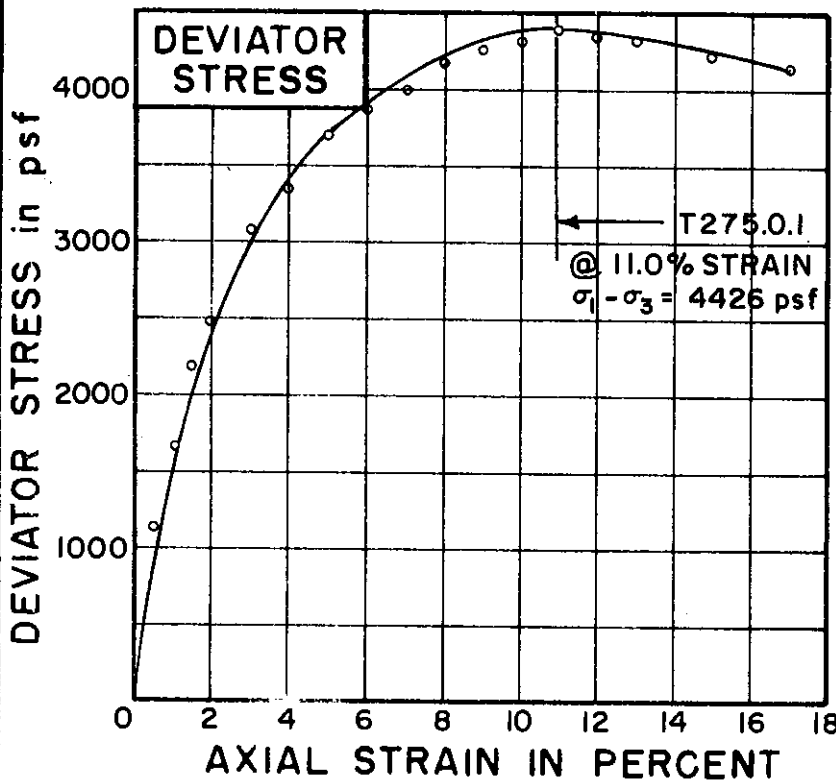
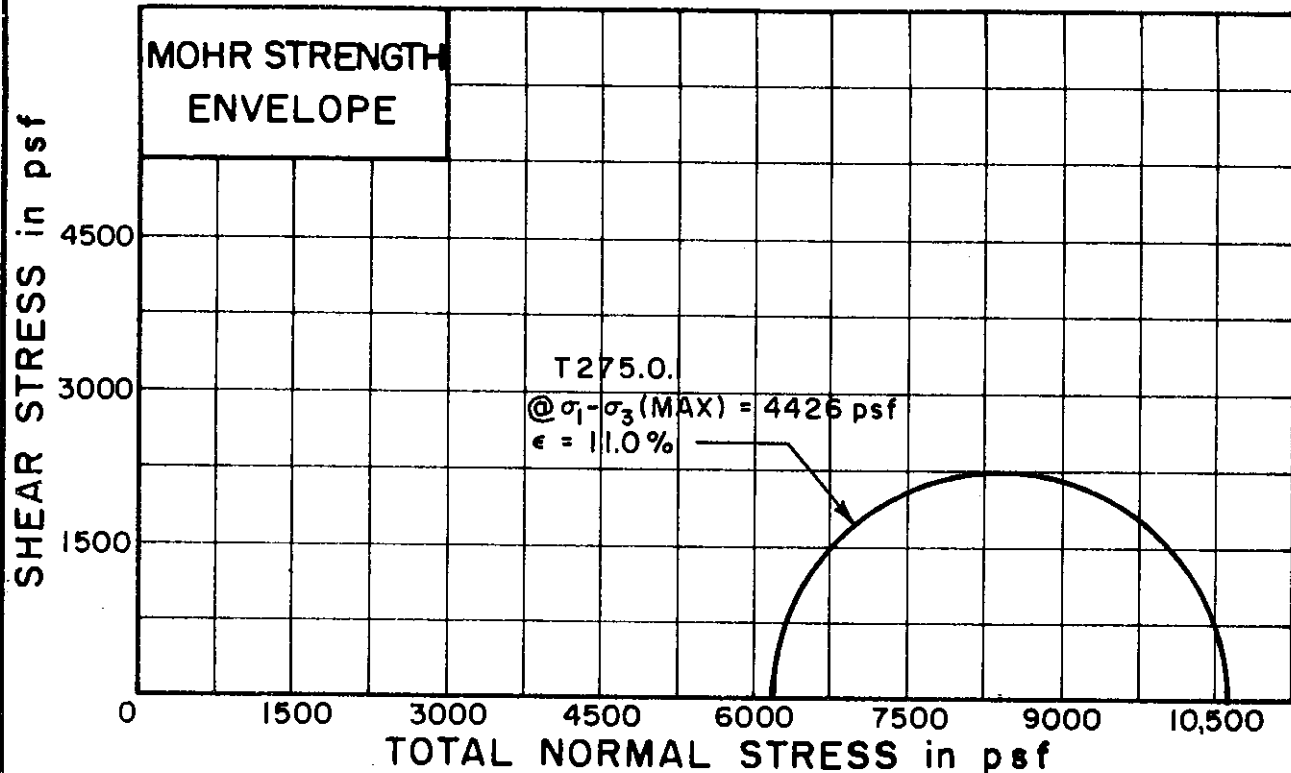

TEST NO./SYMBOL	T275.0		
-----------------	--------	--	--

INITIAL WATER CONTENT	w_o	22.5%	
DRY DENSITY pcf	γ_d	104	
SAMPLE DIAMETER in.	D_o	1.39	
SAMPLE HEIGHT in.	H_o	3.35	

CONFINING PRESSURE psf	σ_3	6192	
RATE OF STRAIN PERCENT/MINUTE		0.27	

FINAL WATER CONTENT	w_f	22.4%	
SKETCH OF SAMPLE AT END OF TEST			

BORING NO. 25
 SAMPLE NO. 10
 DEPTH 88.9' TO 89.2'
 SOIL DESCRIPTION: SILTY CLAY (CL)
 LIQUID LIMIT 36 PLASTIC LIMIT 19

**UNCONSOLIDATED UNDRAINED
 TRIAXIAL COMPRESSION
 TESTS**

THE DETROIT EDISON COMPANY
 BELLE RIVER PLANT UNITS I & II

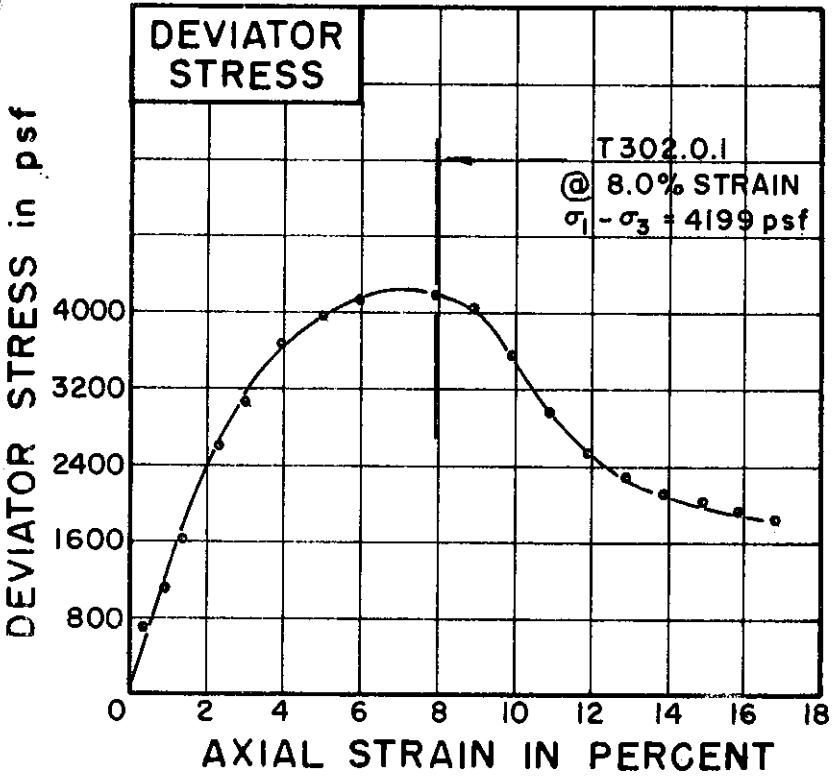
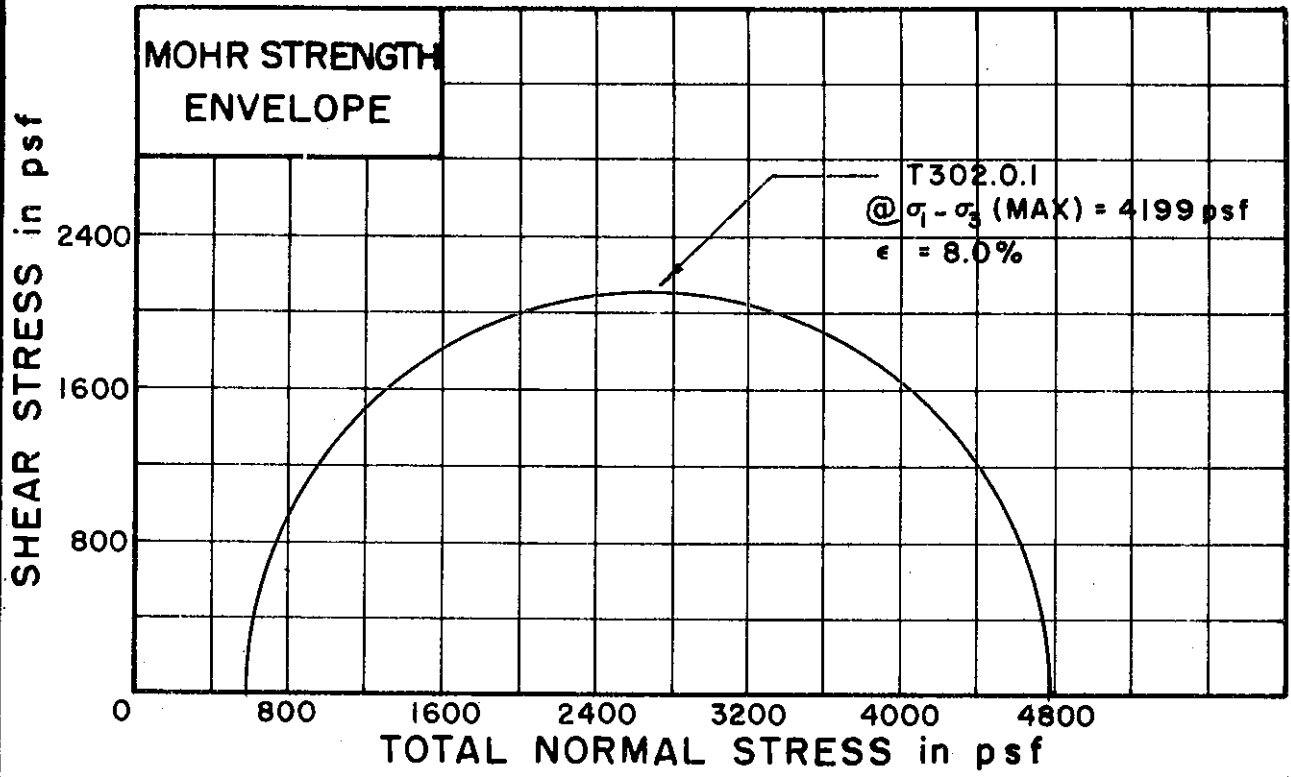

TEST NO./SYMBOL	T302.0.		
-----------------	---------	--	--

INITIAL WATER CONTENT	w_o	24.9%		
DRY DENSITY	γ_d pcf	103		
SAMPLE DIAMETER	D_o in.	1.40		
SAMPLE HEIGHT	H_o in.	3.33		

CONFINING PRESSURE	σ_3 psf	576		
RATE OF STRAIN	PERCENT/MINUTE	.25		

FINAL WATER CONTENT	w_f	24.7%		
SKETCH OF SAMPLE AT END OF TEST				

BORING NO. 27

SAMPLE NO. 2

DEPTH 4.5' TO 4.8'

SOIL DESCRIPTION: SILTY CLAY (CL-CH)

LIQUID LIMIT 48 PLASTIC LIMIT 24

UNCONSOLIDATED UNDRAINED TRIAXIAL COMPRESSION TESTS

THE DETROIT EDISON COMPANY
BELLE RIVER PLANT UNITS I & II

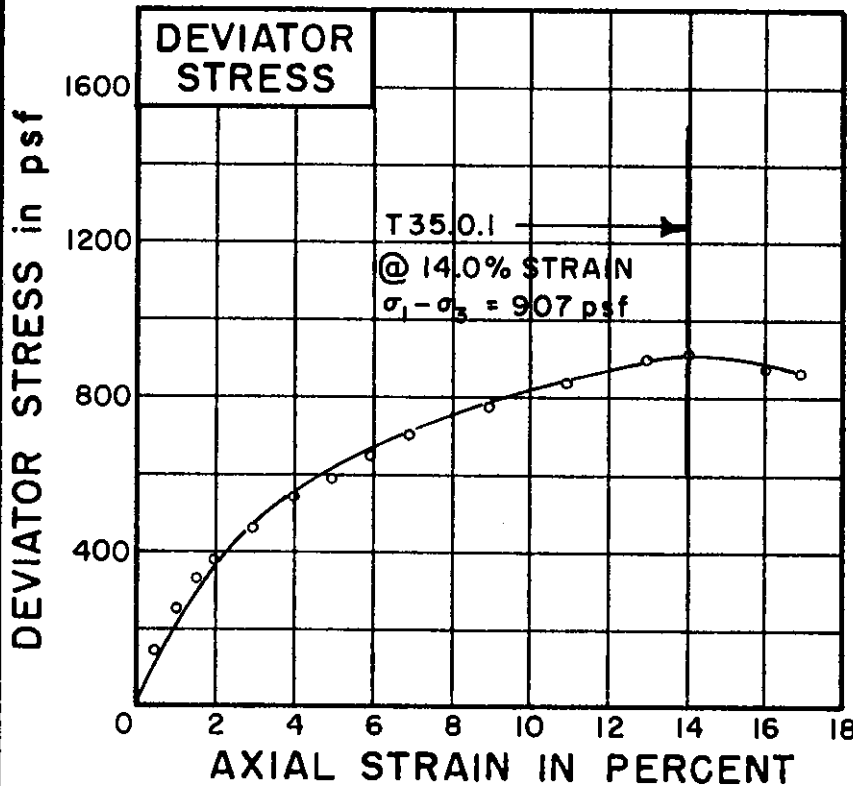
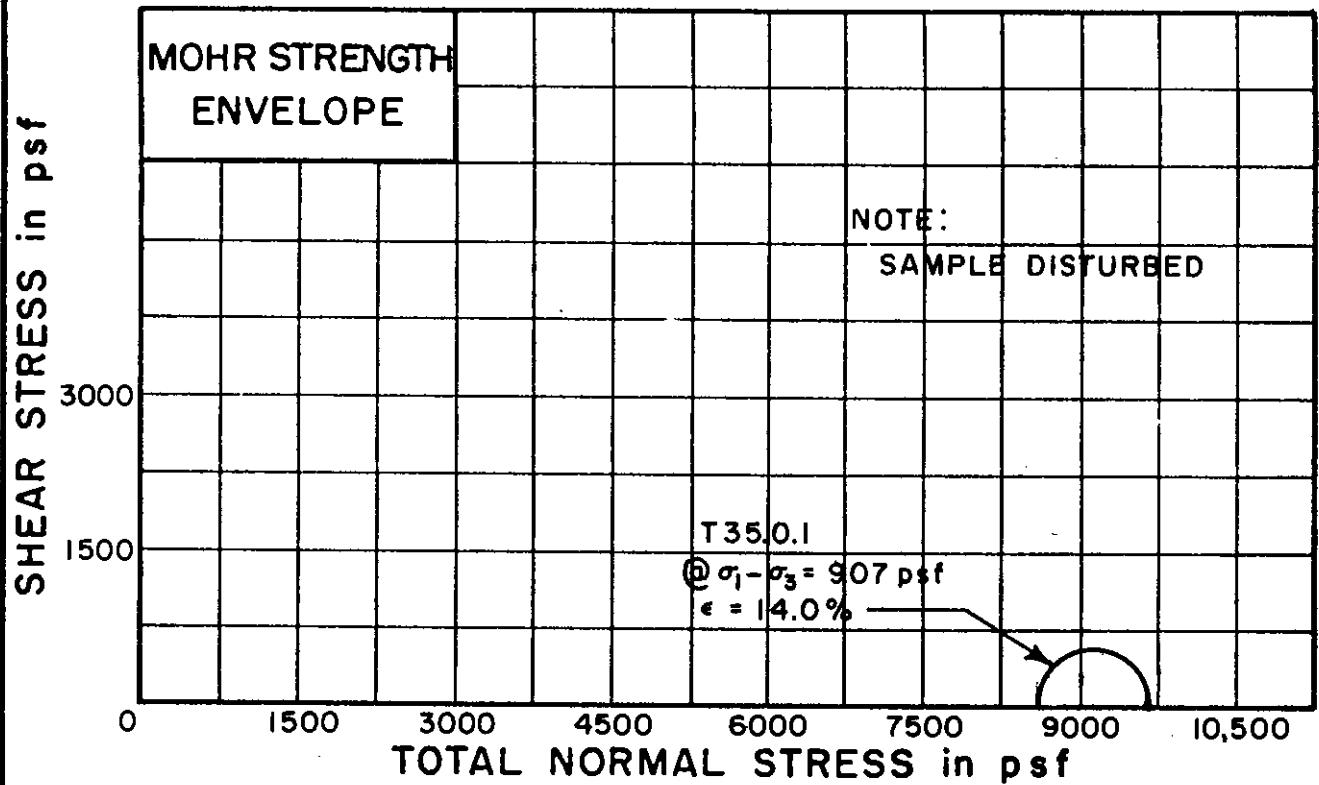

TEST NO./SYMBOL	T35.0.1		
-----------------	---------	--	--

INITIAL WATER CONTENT	w_0	19.6%	
DRY DENSITY pcf	γ_d	105	
SAMPLE DIAMETER in.	D_0	1.41	
SAMPLE HEIGHT in.	H_0	3.50	

CONFINING PRESSURE psf	σ_3	8654	
RATE OF STRAIN PERCENT/MINUTE		0.26	

FINAL WATER CONTENT	w_f	19.6%	
SKETCH OF SAMPLE AT END OF TEST			

BORING NO. 41

SAMPLE NO. 17

DEPTH 72.9' TO 73.2'

SOIL DESCRIPTION: SILTY CLAY, SANDY (CL)
 LIQUID LIMIT 25% PLASTIC LIMIT 15%

UNCONSOLIDATED UNDRAINED
 TRIAXIAL COMPRESSION
 TESTS

THE DETROIT EDISON COMPANY
 BELLE RIVER PLANT UNITS I & II

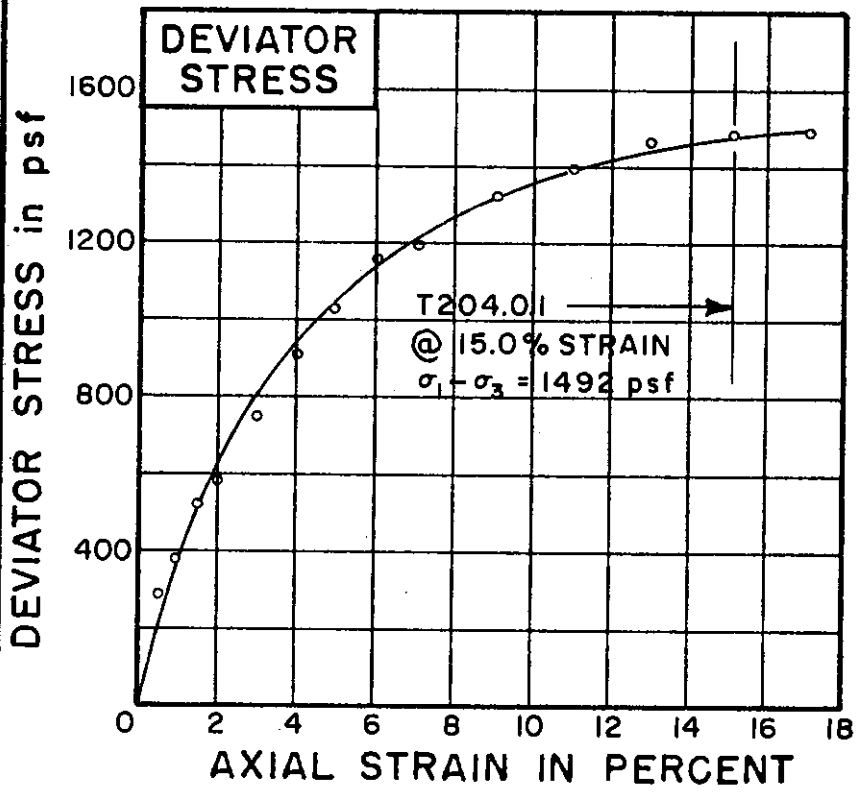
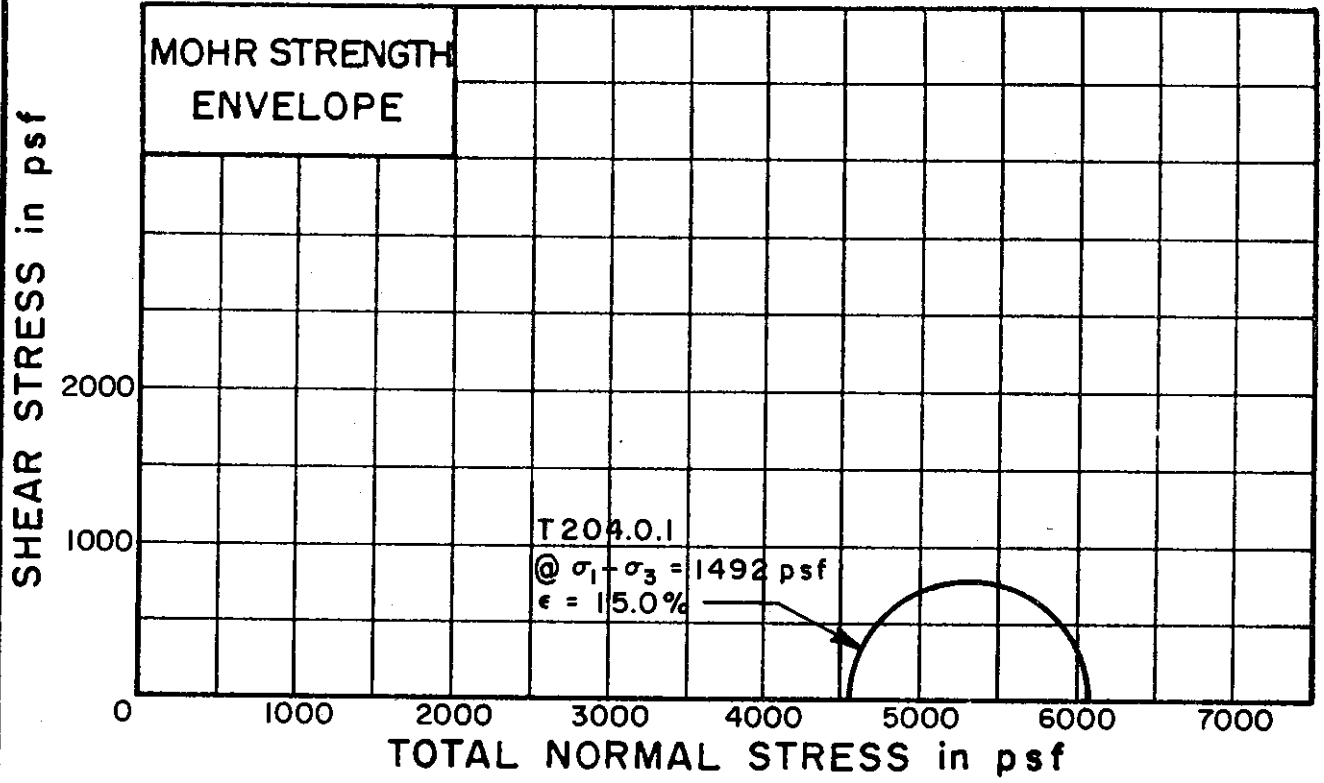

TEST NO./SYMBOL	T204.0.1		
-----------------	----------	--	--

INITIAL WATER CONTENT	w_o	26.3%	
DRY DENSITY	γ_d pcf	99	
SAMPLE DIAMETER	D_o in.	1.40	
SAMPLE HEIGHT	H_o in.	3.43	

CONFINING PRESSURE	σ_3 psf	4608	
RATE OF STRAIN	PERCENT/MINUTE	0.26	

FINAL WATER CONTENT	w_f	25.8%	
SKETCH OF SAMPLE AT END OF TEST			

BORING NO. 48

SAMPLE NO. 14

DEPTH 60.8' TO 61.1'

SOIL DESCRIPTION: SILTY CLAY, SANDY (CL)

LIQUID LIMIT 34% PLASTIC LIMIT 16%

UNCONSOLIDATED UNDRAINED
 TRIAXIAL COMPRESSION
 TESTS

THE DETROIT EDISON COMPANY
 BELLE RIVER PLANT UNITS I & II

SHEAR STRESS in psf

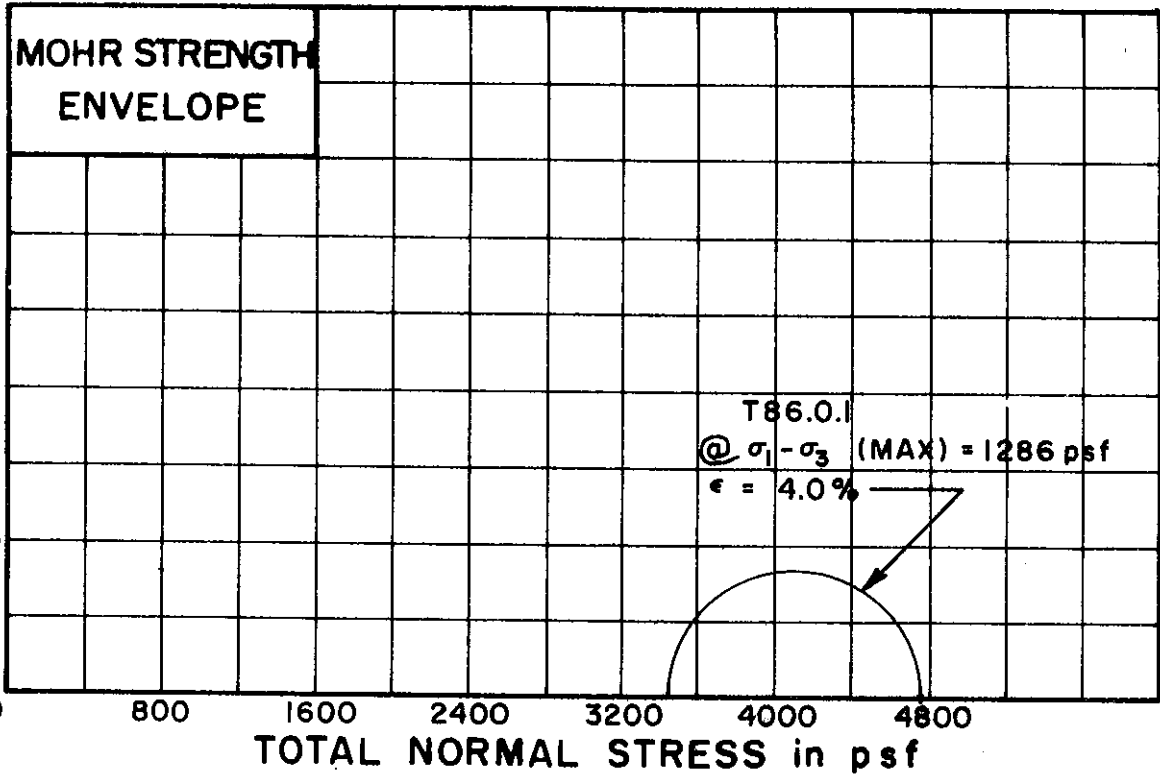

DEVIATOR STRESS in psf

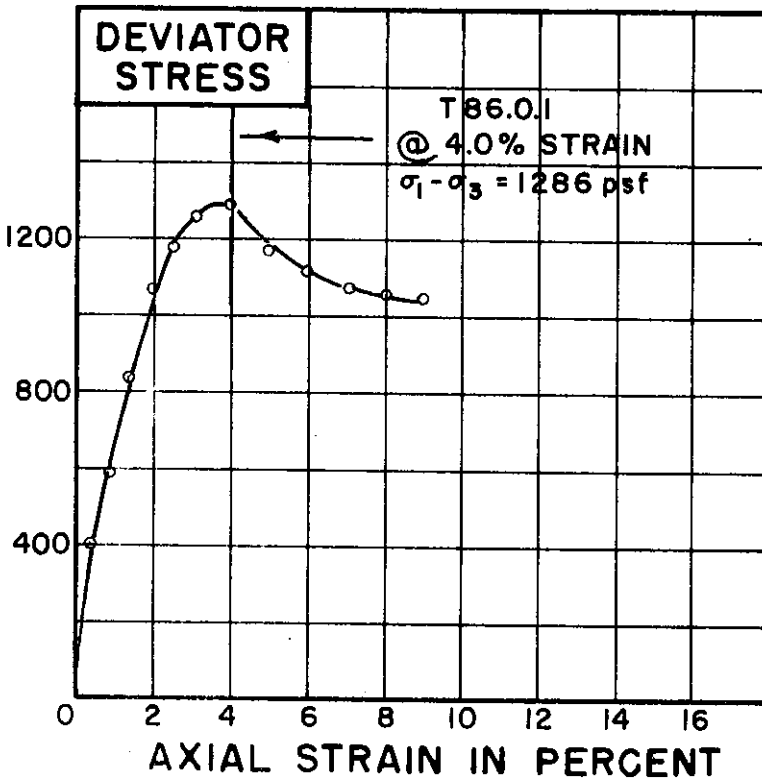

TEST NO./SYMBOL	T86.0.1	
-----------------	---------	--

INITIAL WATER CONTENT	w _o	46.2%
-----------------------	----------------	-------

DRY DENSITY pcf	γ _d	74
-----------------	----------------	----

SAMPLE DIAMETER in.	D _o	1.40
---------------------	----------------	------

SAMPLE HEIGHT in.	H _o	3.27
-------------------	----------------	------

CONFINING PRESSURE psf	σ ₃	3456
------------------------	----------------	------

RATE OF STRAIN PERCENT/MINUTE		.25
-------------------------------	--	-----

FINAL WATER CONTENT	w _f	46.3%
---------------------	----------------	-------

SKETCH OF SAMPLE AT END OF TEST		
---------------------------------	--	--

BORING NO. 50
 SAMPLE NO. 8
 DEPTH 38.1' TO 38.4'
 SOIL DESCRIPTION: SILTY CLAY (CH)
 LIQUID LIMIT 55 PLASTIC LIMIT 23

**UNCONSOLIDATED UNDRAINED
TRIAxIAL COMPRESSION
TESTS**

THE DETROIT EDISON COMPANY
BELLE RIVER PLANT UNITS I & II

SHEAR STRESS in psf

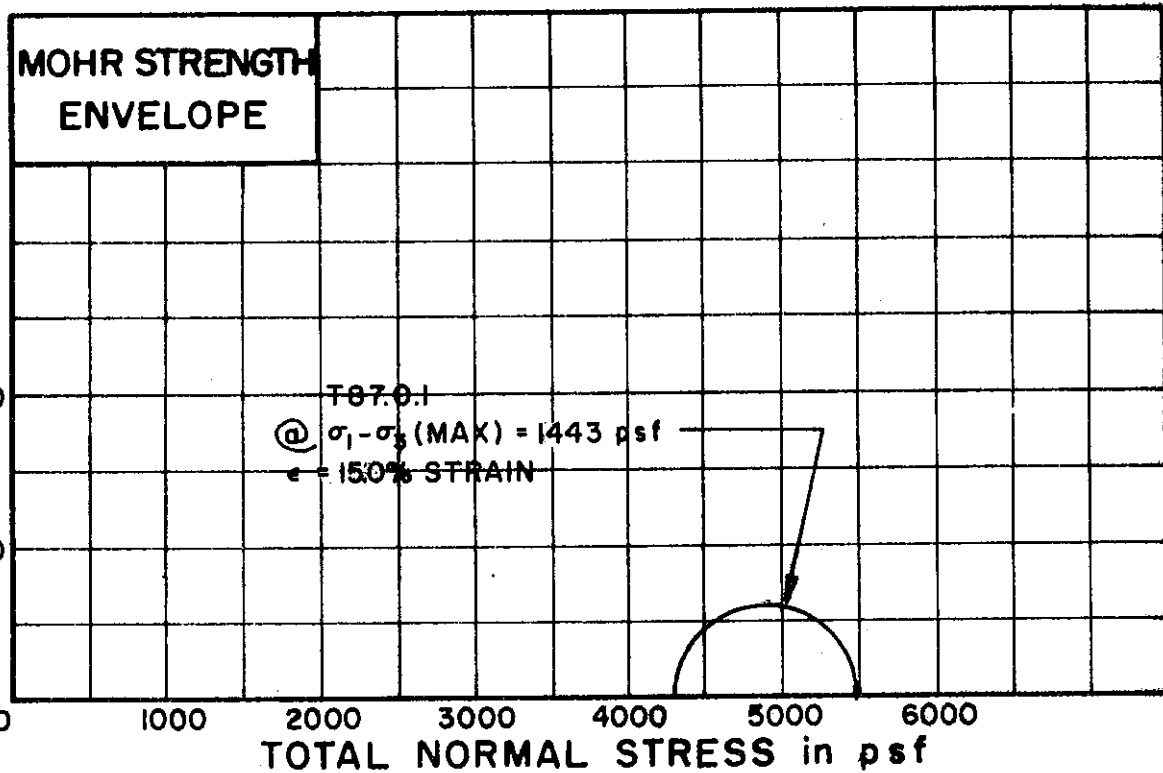

DEVIATOR STRESS in psf

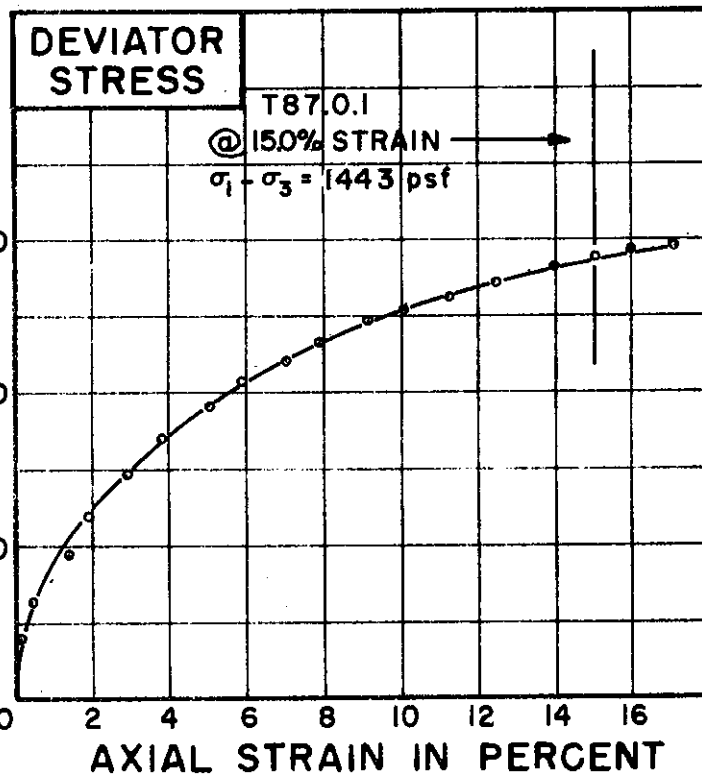

TEST NO./SYMBOL	T87.0.1		
-----------------	---------	--	--

INITIAL WATER CONTENT	w _o	23.2	
DRY DENSITY	γ _d	100	
SAMPLE DIAMETER	D _o	1.40	
SAMPLE HEIGHT	H _o	3.12	

CONFINING PRESSURE	σ ₃	4320	
RATE OF STRAIN		.25	

FINAL WATER CONTENT	w _f	23.0	
SKETCH OF SAMPLE AT END OF TEST			

BORING NO. 50

SAMPLE NO. 10

DEPTH 49.3' TO 49.6'

SOIL DESCRIPTION: SILTY CLAY, SANDY
 LIQUID LIMIT 36 PLASTIC LIMIT 16 (CL)

**UNCONSOLIDATED UNDRAINED
 TRIAXIAL COMPRESSION
 TESTS**

THE DETROIT EDISON COMPANY
 BELLE RIVER PLANT UNITS I & II

SHEAR STRESS in psf

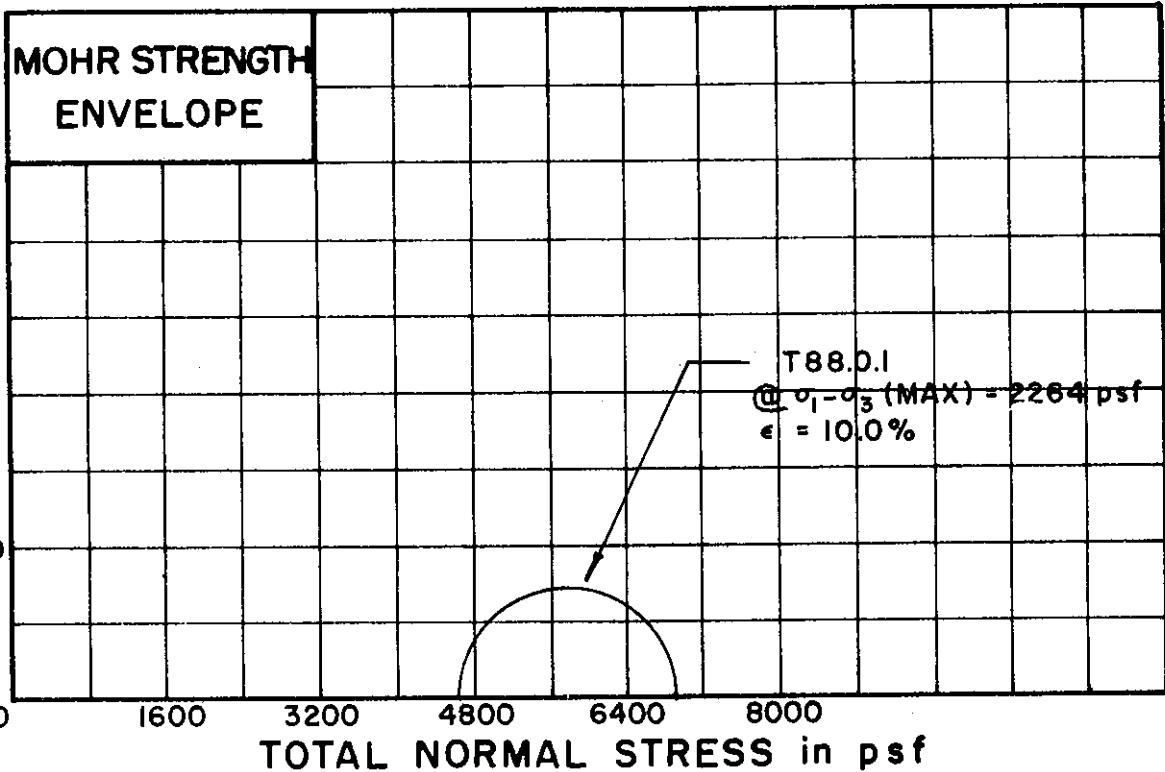

DEVIATOR STRESS in psf

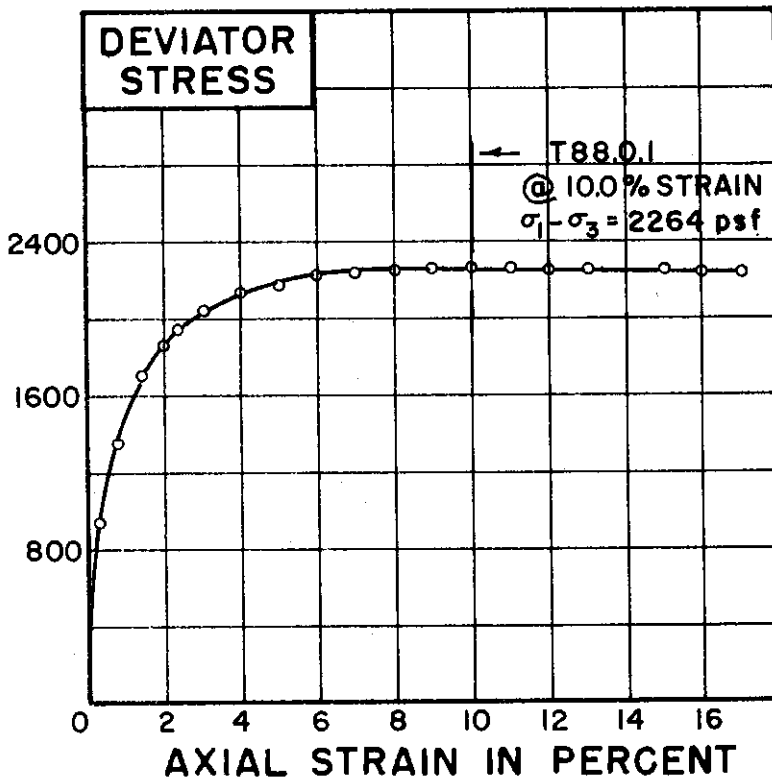

TEST NO./SYMBOL	T88.0.1		
-----------------	---------	--	--

INITIAL WATER CONTENT	w_0	24.3	
DRY DENSITY pcf	γ_d	101	
SAMPLE DIAMETER in.	D_0	1.38	
SAMPLE HEIGHT in.	H_0	3.11	

CONFINING PRESSURE psf	σ_3	4608	
RATE OF STRAIN PERCENT/MINUTE		.26	

FINAL WATER CONTENT	w_f	23.5	
SKETCH OF SAMPLE AT END OF TEST			

BORING NO. 50

SAMPLE NO. 12

DEPTH 59.1' TO 59.4'

SOIL DESCRIPTION: SILTY CLAY, SANDY (CL)

LIQUID LIMIT 39 PLASTIC LIMIT 18

**UNCONSOLIDATED UNDRAINED
 TRIAXIAL COMPRESSION
 TESTS**

THE DETROIT EDISON COMPANY
 BELLE RIVER PLANT UNITS I & II

SHEAR STRESS in psf

MOHR STRENGTH ENVELOPE

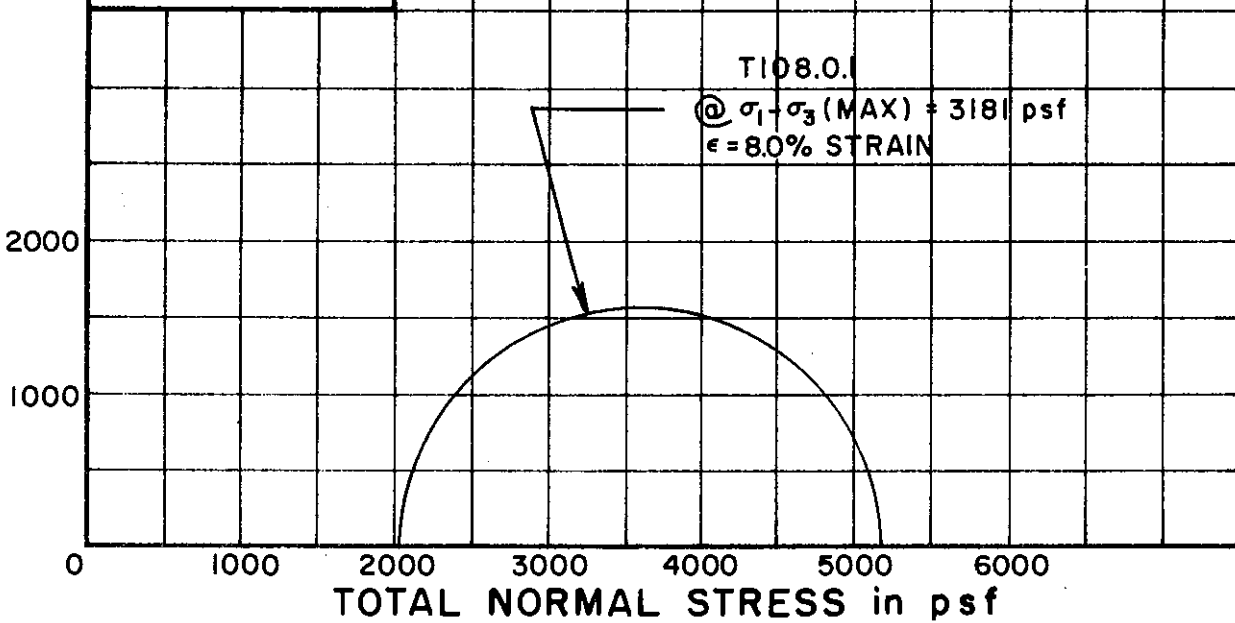

DEVIATOR STRESS in psf

DEVIATOR STRESS

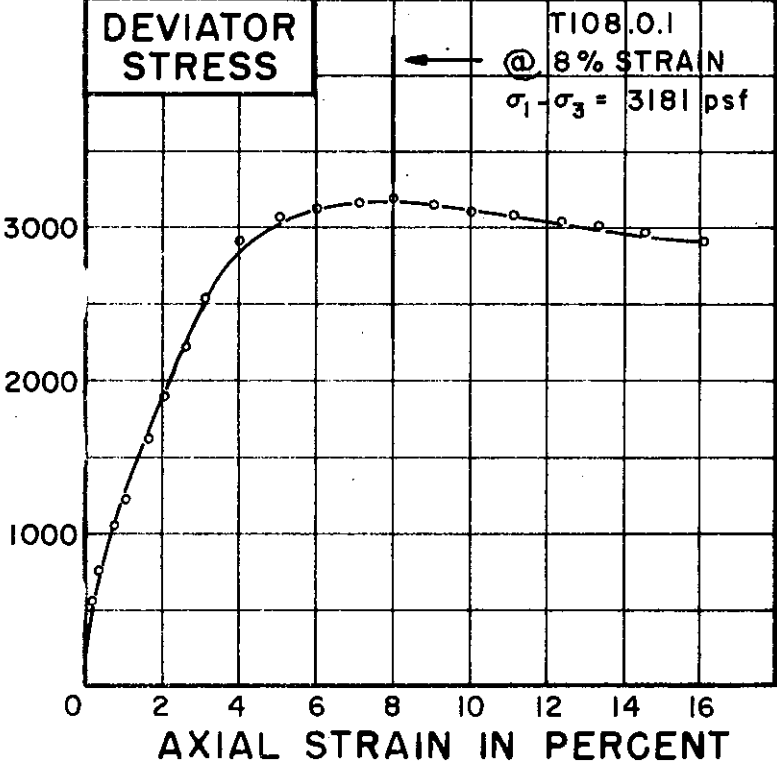

TEST NO./SYMBOL	T108.0.1		
-----------------	----------	--	--

INITIAL WATER CONTENT	w _o	31.1		
DRY DENSITY p _{cf}	γ _d	92		
SAMPLE DIAMETER in.	D _o	1.41		
SAMPLE HEIGHT in.	H _o	3.25		

CONFINING PRESSURE p _{sf}	σ ₃	2016		
RATE OF STRAIN PERCENT/MINUTE		.25		

FINAL WATER CONTENT	w _f	30.9		
SKETCH OF SAMPLE AT END OF TEST				

BORING NO. 52
 SAMPLE NO. 3
 DEPTH 21.2' TO 21.5'
 SOIL DESCRIPTION: SILTY CLAY (CL-CH)
 LIQUID LIMIT 49 PLASTIC LIMIT 20

UNCONSOLIDATED UNDRAINED TRIAXIAL COMPRESSION TESTS

THE DETROIT EDISON COMPANY
 BELLE RIVER PLANT UNITS I & II

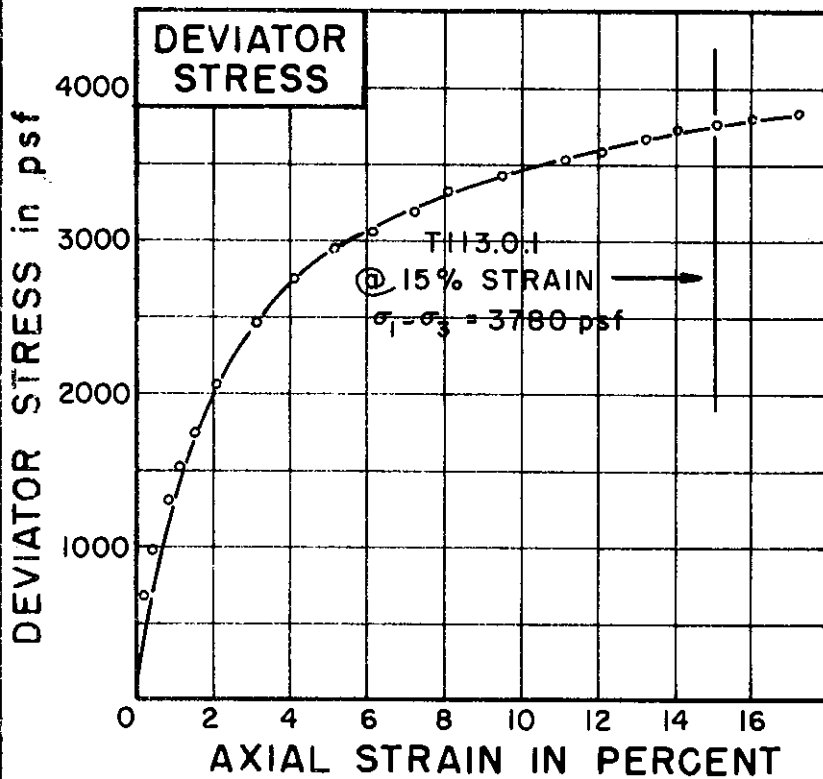
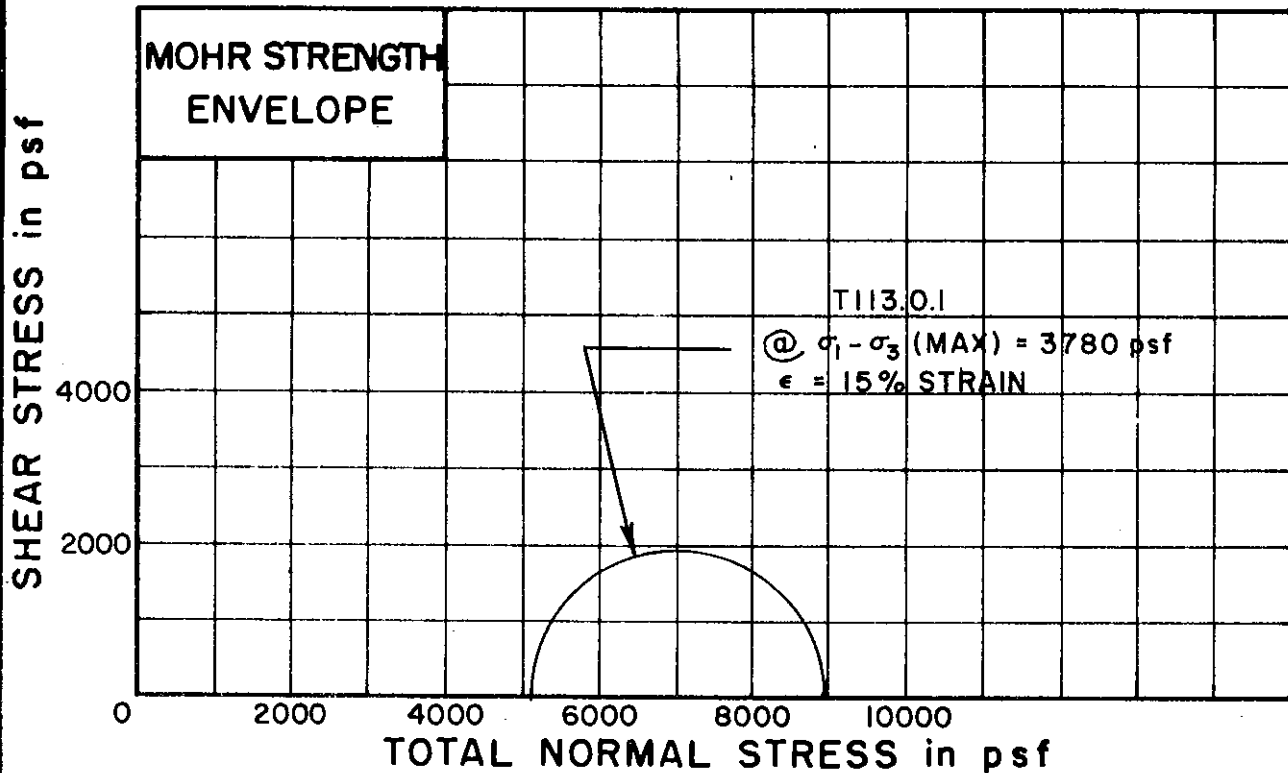

TEST NO./SYMBOL	T113.0.1		
-----------------	----------	--	--

INITIAL WATER CONTENT	w_0	16.2		
DRY DENSITY pcf	γ_d	111		
SAMPLE DIAMETER, in.	D_0	1.38		
SAMPLE HEIGHT in.	H_0	3.18		

CONFINING PRESSURE psf	σ_3	5184		
RATE OF STRAIN PERCENT/MINUTE		.25		

FINAL WATER CONTENT	w_f	16.1		
SKETCH OF SAMPLE AT END OF TEST				

BORING NO. 52

SAMPLE NO. 8

DEPTH 69.0 TO 69.4'

SOIL DESCRIPTION: SILTY CLAY, SANDY
 LIQUID LIMIT 24 PLASTIC LIMIT 14 (CL)

UNCONSOLIDATED UNDRAINED
 TRIAXIAL COMPRESSION
 TESTS

THE DETROIT EDISON COMPANY
 BELLE RIVER PLANT UNITS I & II

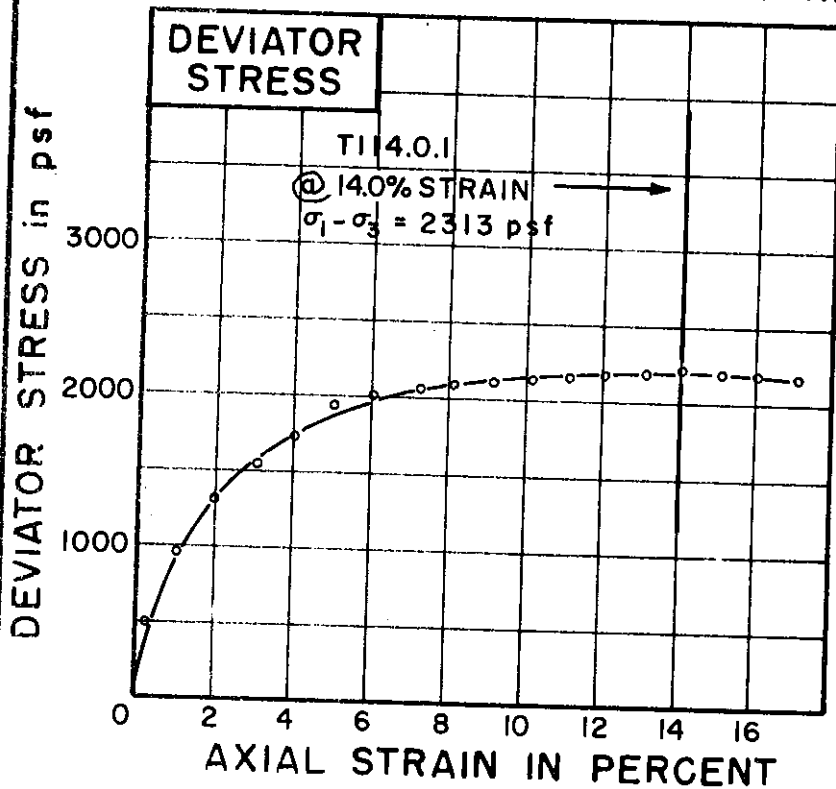
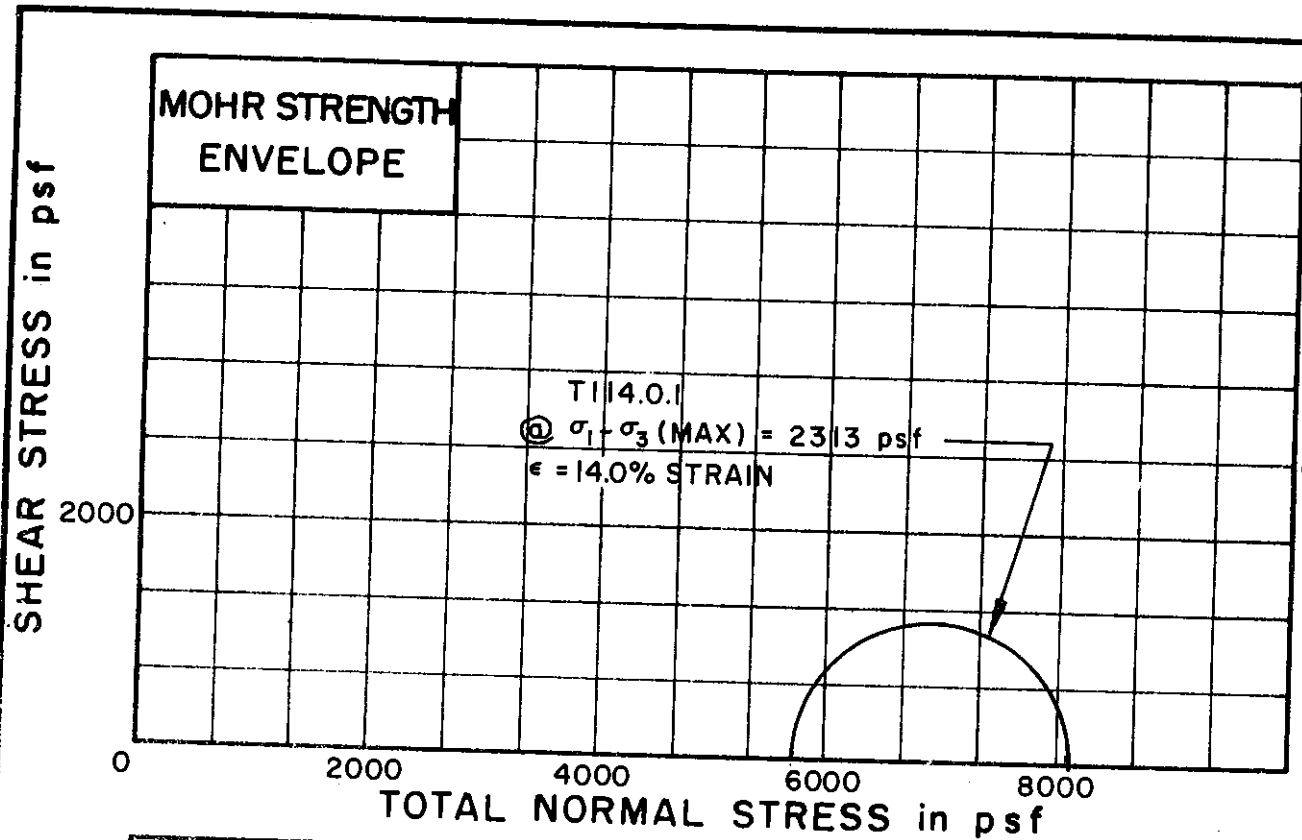

TEST NO./SYMBOL	T114.0.1		
-----------------	----------	--	--

INITIAL WATER CONTENT	w_o	21.8		
DRY DENSITY	γ_d pcf	105		
SAMPLE DIAMETER	D_o in.	1.38		
SAMPLE HEIGHT	H_o in.	3.31		

CONFINING PRESSURE	σ_3 psf	5760		
RATE OF STRAIN	PERCENT/MINUTE	.25		

FINAL WATER CONTENT	w_f	21.7		
SKETCH OF SAMPLE AT END OF TEST				

BORING NO. 52

SAMPLE NO. 9

DEPTH 78.6' TO 78.9'

SOIL DESCRIPTION: SILTY CLAY (CL)

LIQUID LIMIT 35 PLASTIC LIMIT 18

**UNCONSOLIDATED UNDRAINED
 TRIAXIAL COMPRESSION
 TESTS**

THE DETROIT EDISON COMPANY
 BELLE RIVER PLANT UNITS I & II

SHEAR STRESS in psf

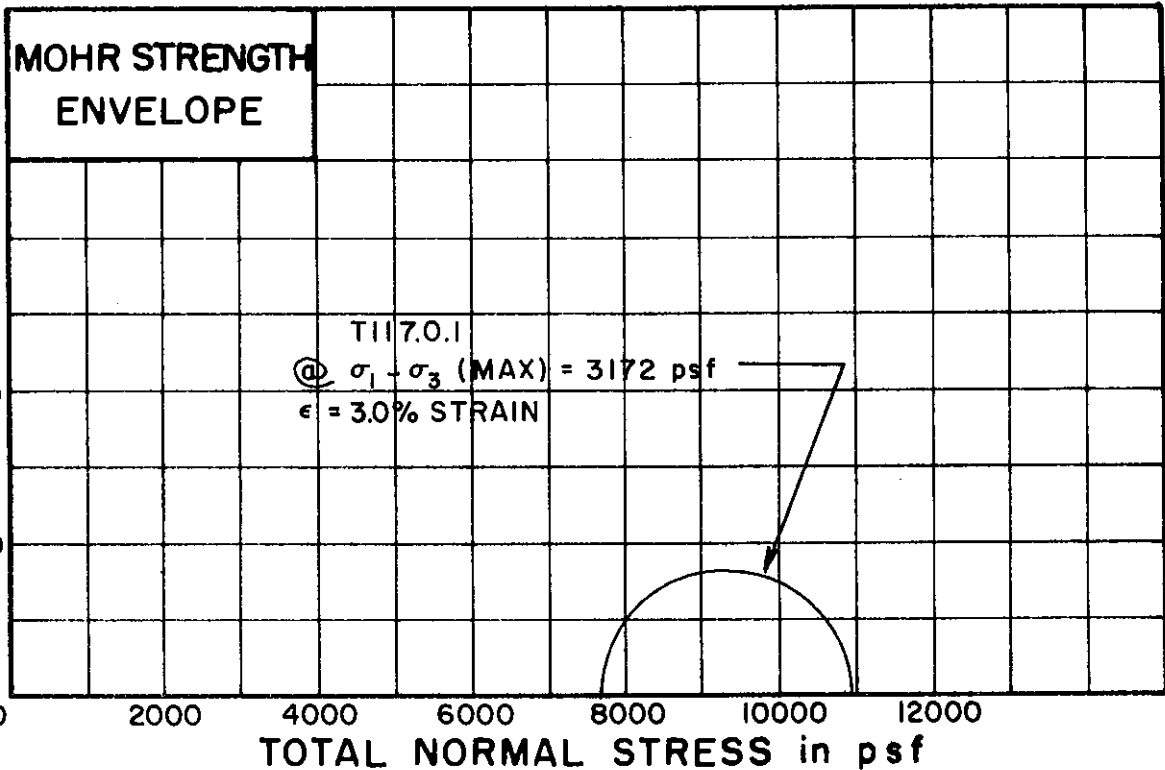

DEVIATOR STRESS in psf

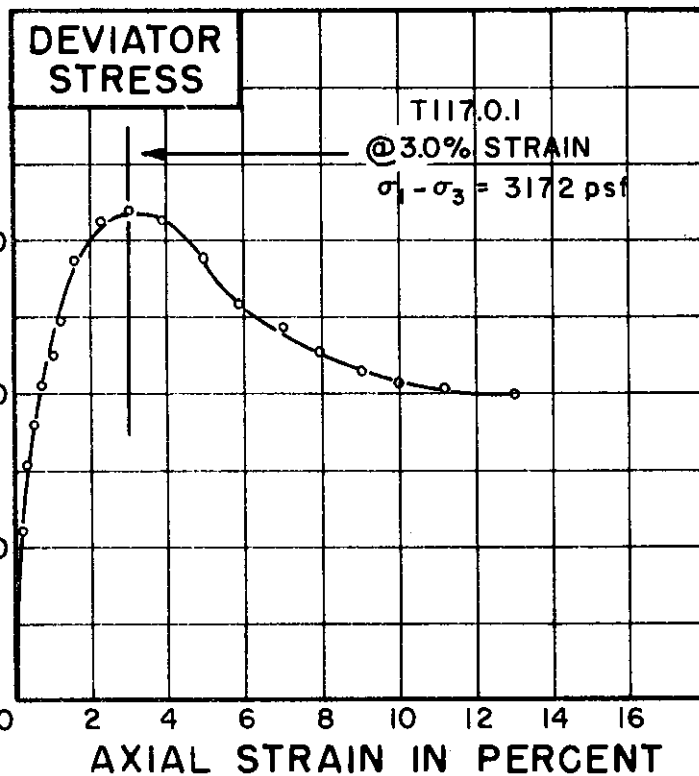

TEST NO./SYMBOL	T117.0.1		
-----------------	----------	--	--

INITIAL WATER CONTENT	w_o	35.8		
DRY DENSITY pcf	γ_d	87		
SAMPLE DIAMETER in.	D_o	1.38		
SAMPLE HEIGHT in.	H_o	3.45		

CONFINING PRESSURE psf	σ_3	7632		
RATE OF STRAIN PERCENT/MINUTE		.25		

FINAL WATER CONTENT	w_f	35.7		
SKETCH OF SAMPLE AT END OF TEST				

BORING NO. 52
 SAMPLE NO. 12
 DEPTH 109.3' TO 109.6'
 SOIL DESCRIPTION: SILTY CLAY (CL)
 LIQUID LIMIT 46 PLASTIC LIMIT 22

**UNCONSOLIDATED UNDRAINED
 TRIAXIAL COMPRESSION
 TESTS**

THE DETROIT EDISON COMPANY
 BELLE RIVER PLANT UNITS I & II

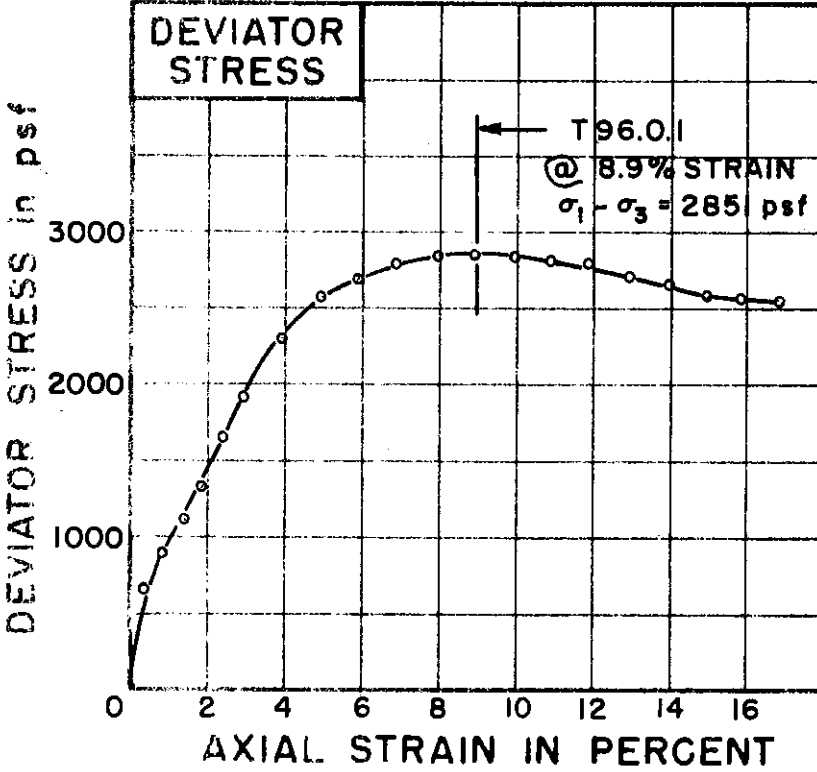
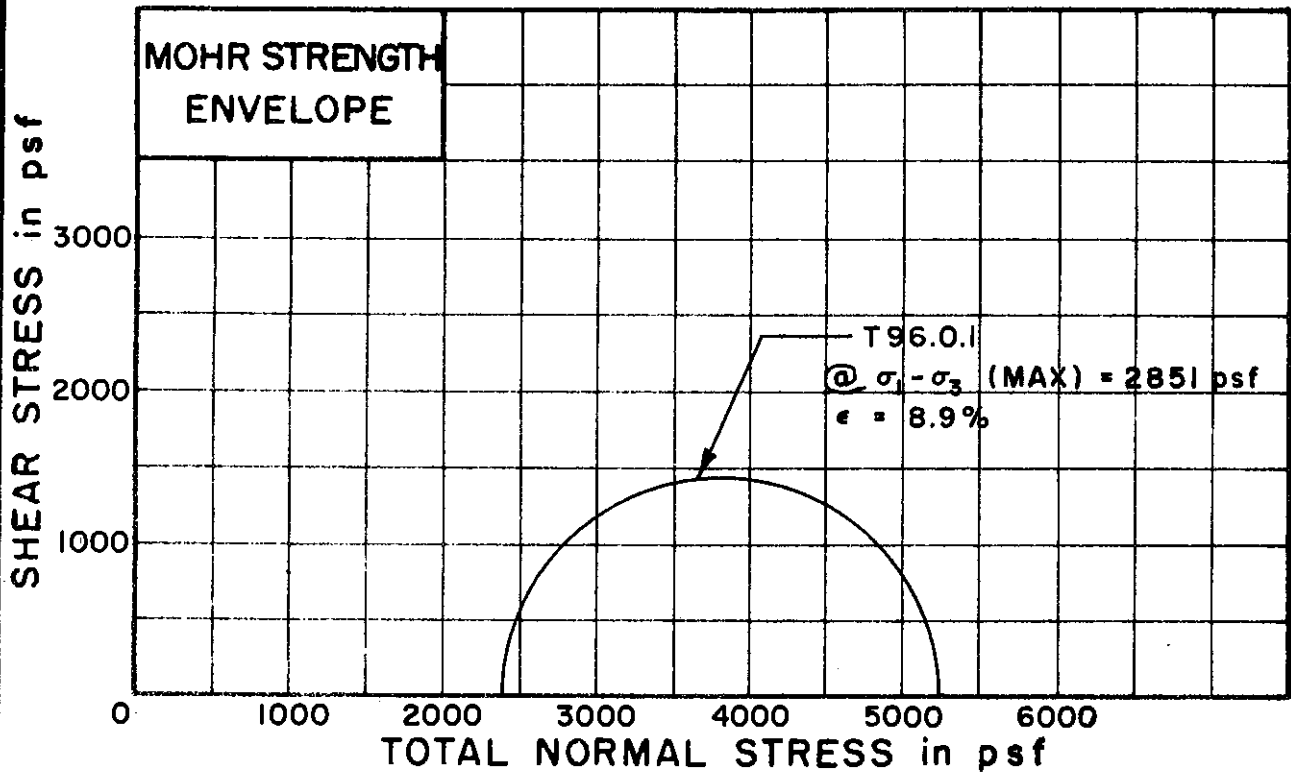

TEST NO./SYMBOL	T96.0.1		
-----------------	---------	--	--

INITIAL WATER CONTENT	w_0	32.2%		
DRY DENSITY pcf	γ_d	91		
SAMPLE DIAMETER in.	D_0	1.39		
SAMPLE HEIGHT in.	H_0	3.26		

CONFINING PRESSURE psf	σ_3	2405		
RATE OF STRAIN PERCENT/MINUTE		.25		

FINAL WATER CONTENT	w_f	31.8%		
SKETCH OF SAMPLE AT END OF TEST				

BORING NO. 53

SAMPLE NO. 3

DEPTH 20.1' TO 20.4'

SOIL DESCRIPTION: SILTY CLAY (CL-CH)

LIQUID LIMIT 49 PLASTIC LIMIT 20

UNCONSOLIDATED UNDRAINED
 TRIAXIAL COMPRESSION
 TESTS

THE DETROIT EDISON COMPANY
 BELLE RIVER PLANT UNITS I & II

SHEAR STRESS in psf

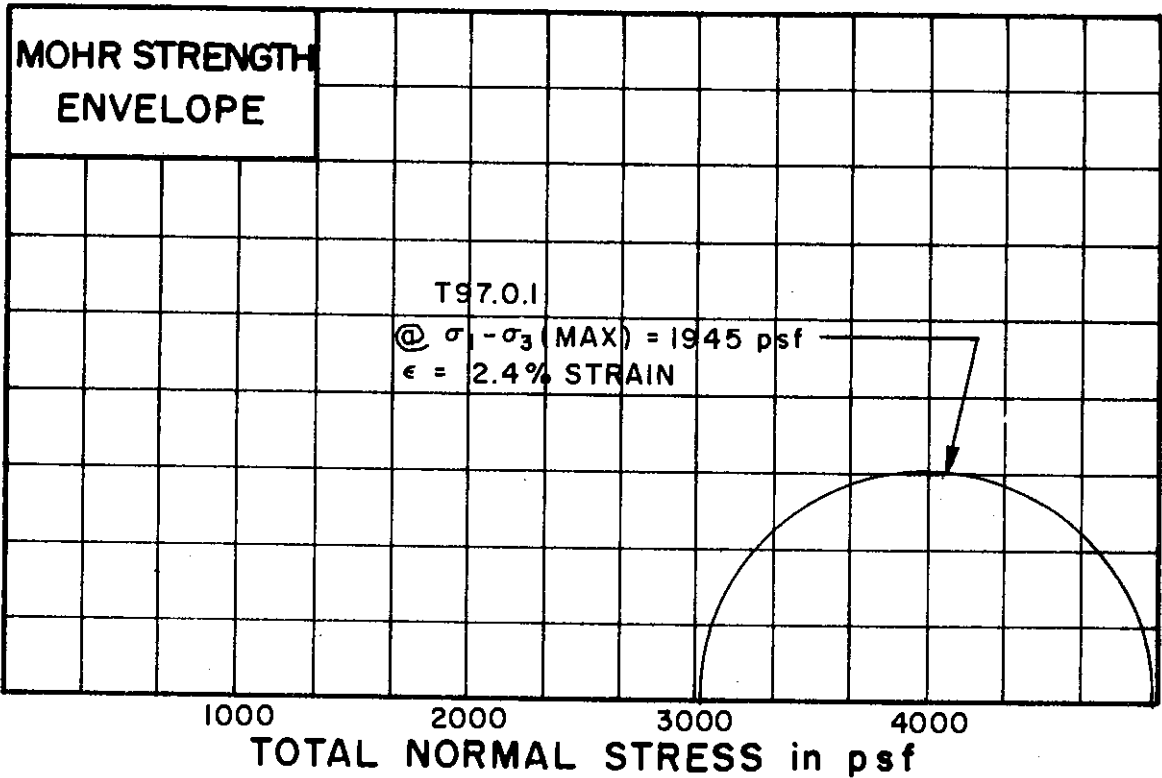

DEVIATOR STRESS in psf

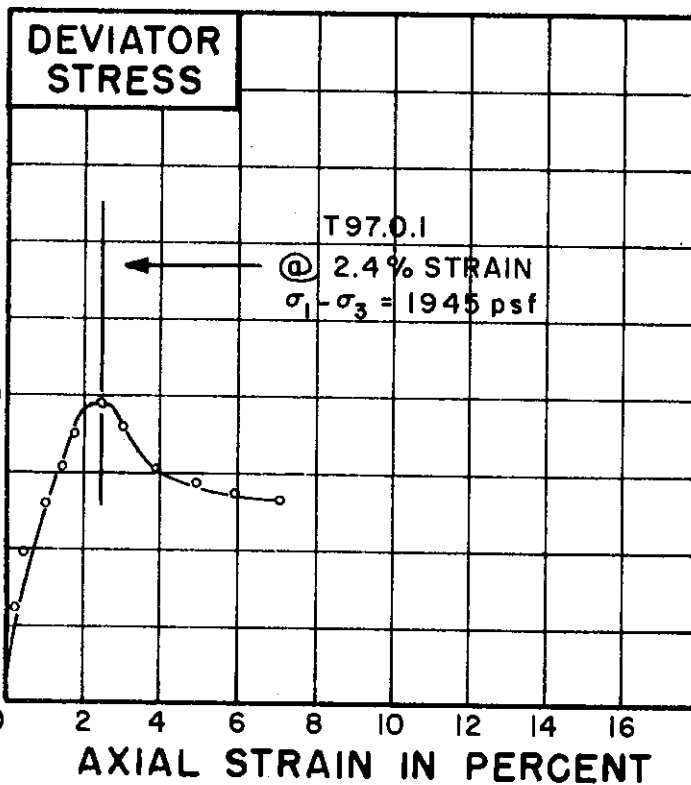

TEST NO./SYMBOL	T97.0.1		
-----------------	---------	--	--

INITIAL WATER CONTENT	w_0	34.0	
DRY DENSITY pcf	γ_d	88	
SAMPLE DIAMETER, in.	D_0	1.39	
SAMPLE HEIGHT in.	H_0	3.21	

CONFINING PRESSURE psf	σ_3	3024	
RATE OF STRAIN PERCENT/MINUTE		.25	

FINAL WATER CONTENT	w_f	3.42	
SKETCH OF SAMPLE AT END OF TEST			

BORING NO. 53
 SAMPLE NO. 4
 DEPTH 30.1' TO 30.4'

SOIL DESCRIPTION: SILTY CLAY (CL-CH)
 LIQUID LIMIT 49 PLASTIC LIMIT 22

**UNCONSOLIDATED UNDRAINED
 TRIAXIAL COMPRESSION
 TESTS**

THE DETROIT EDISON COMPANY
 BELLE RIVER PLANT UNITS I & II

SHEAR STRESS in psf

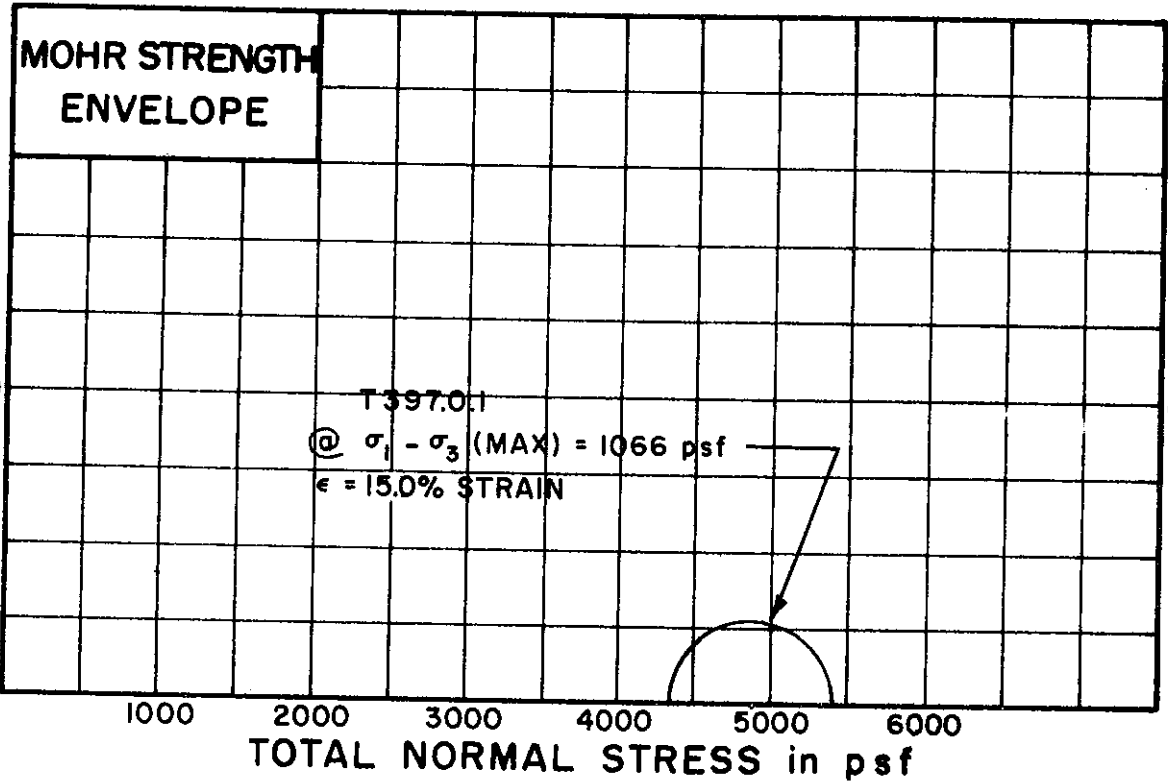

DEVIATOR STRESS in psf

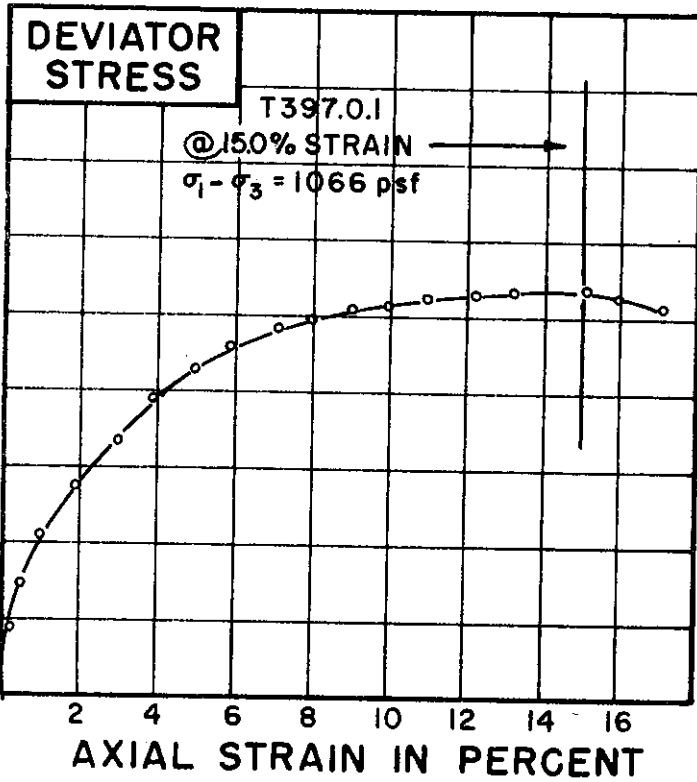

TEST NO./SYMBOL	T397.0.1		
-----------------	----------	--	--

INITIAL WATER CONTENT	w_o	24.4	
DRY DENSITY pcf	γ_d	99	
SAMPLE DIAMETER in.	D_o	1.39	
SAMPLE HEIGHT in.	H_o	3.24	

CONFINING PRESSURE psf	σ_3	4320	
RATE OF STRAIN PERCENT/MINUTE		.25	

FINAL WATER CONTENT	w_f	23.9	
SKETCH OF SAMPLE AT END OF TEST			

BORING NO. 54
 SAMPLE NO. 4
 DEPTH 53.2' TO 53.5'
 SOIL DESCRIPTION: CLAYEY SILT (ML-CL)
 LIQUID LIMIT 21 PLASTIC LIMIT 17

UNCONSOLIDATED UNDRAINED TRIAXIAL COMPRESSION TESTS

THE DETROIT EDISON COMPANY
 BELLE RIVER PLANT UNITS I & II

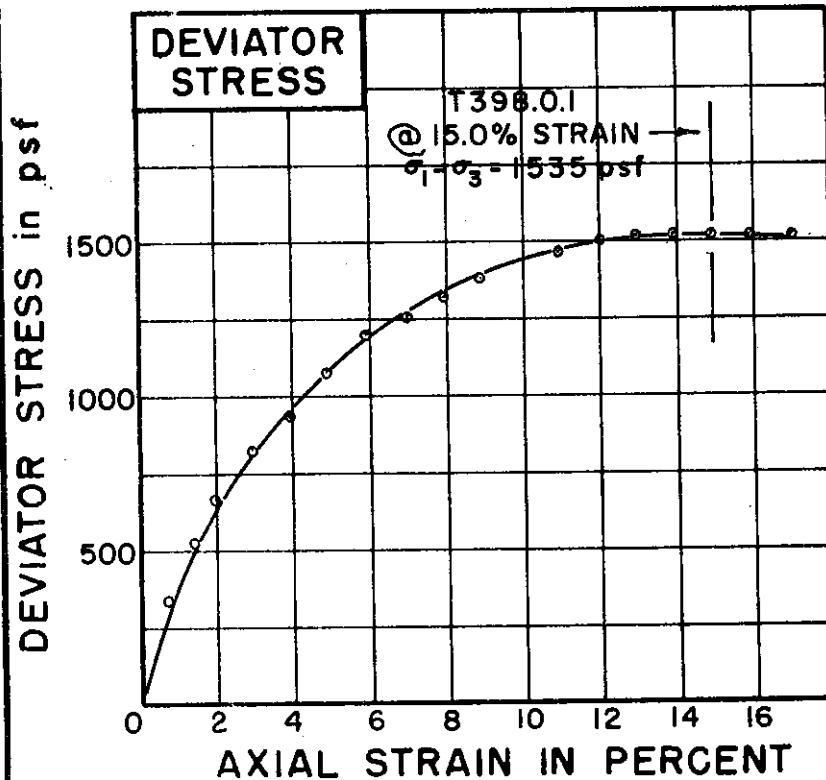
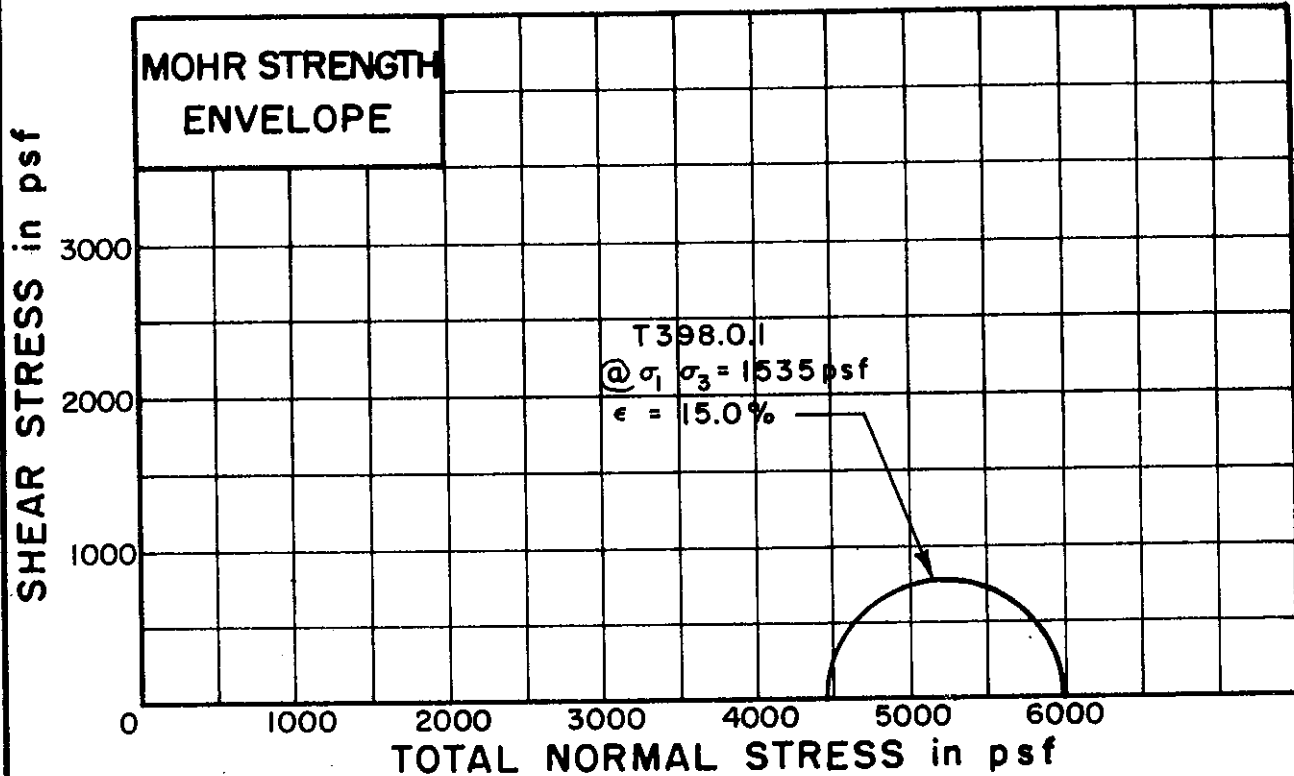

TEST NO./SYMBOL	T398.0.1	
-----------------	----------	--

INITIAL WATER CONTENT	w_o	25.4%	
DRY DENSITY pcf	γ_d	99	
SAMPLE DIAMETER in.	D_o	1.38	
SAMPLE HEIGHT in.	H_o	3.26	

CONFINING PRESSURE psf	σ_3	4464	
RATE OF STRAIN PERCENT/MINUTE		.25	

FINAL WATER CONTENT	w_f	25.5%	
SKETCH OF SAMPLE AT END OF TEST			

BORING NO. 54

SAMPLE NO. 5

DEPTH 59.0' TO 59.3'

SOIL DESCRIPTION: SILTY CLAY, SANDY (CL)

LIQUID LIMIT 38 PLASTIC LIMIT 17

**UNCONSOLIDATED UNDRAINED
TRIAXIAL COMPRESSION
TESTS**

THE DETROIT EDISON COMPANY
BELLE RIVER PLANT UNITS I & II

SHEAR STRESS in psf

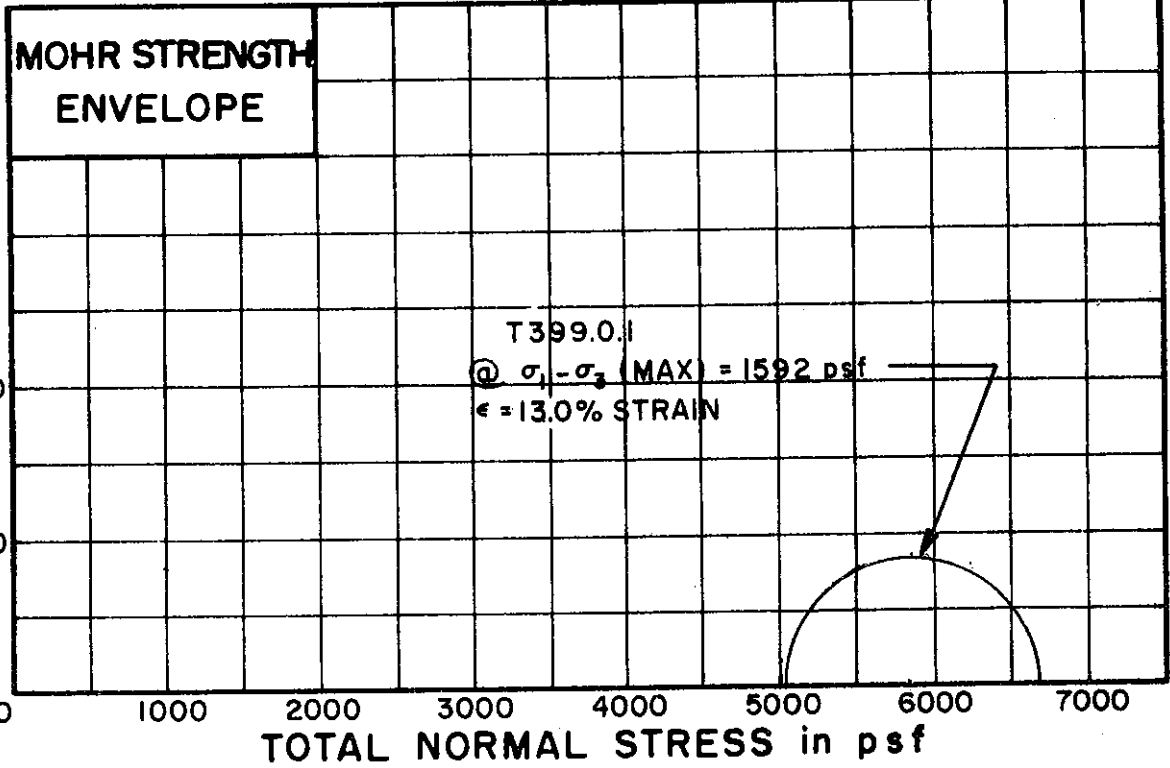

DEVIATOR STRESS in psf

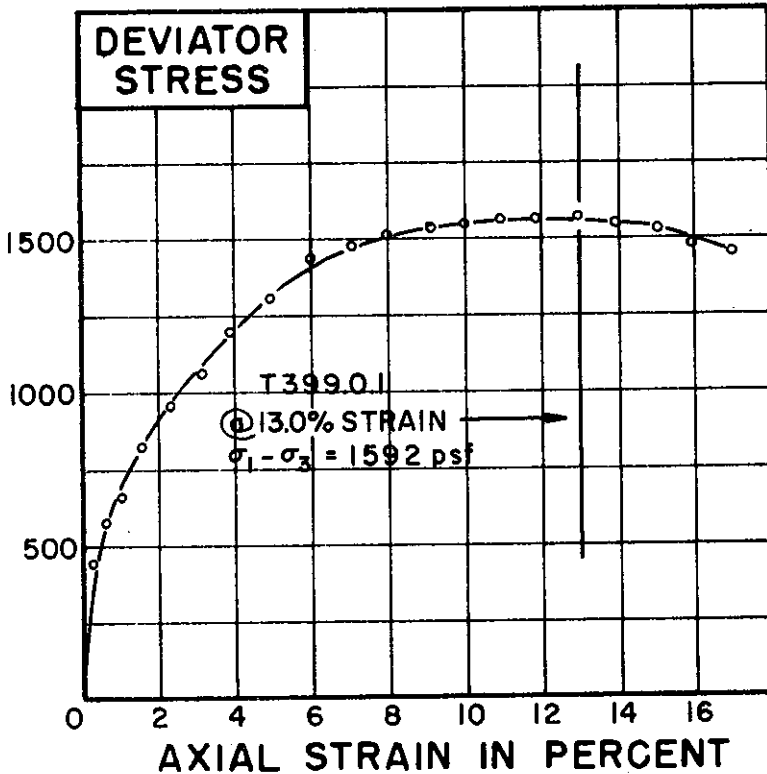

TEST NO./SYMBOL	T399.0.1		
-----------------	----------	--	--

INITIAL WATER CONTENT	w _o	26.1		
DRY DENSITY pcf	γ _d	98		
SAMPLE DIAMETER in.	D _o	1.38		
SAMPLE HEIGHT in.	H _o	3.33		

CONFINING PRESSURE psf	σ ₃	5040		
RATE OF STRAIN PERCENT/MINUTE		.25		

FINAL WATER CONTENT	w _f	25.8		
SKETCH OF SAMPLE AT END OF TEST				

BORING NO. 54

SAMPLE NO. 6

DEPTH 63.1' TO 63.4'

SOIL DESCRIPTION: SILTY CLAY, SANDY
 LIQUID LIMIT 36 PLASTIC LIMIT 18 (CL)

UNCONSOLIDATED UNDRAINED
 TRIAXIAL COMPRESSION
 TESTS

THE DETROIT EDISON COMPANY
 BELLE RIVER PLANT UNITS I & II

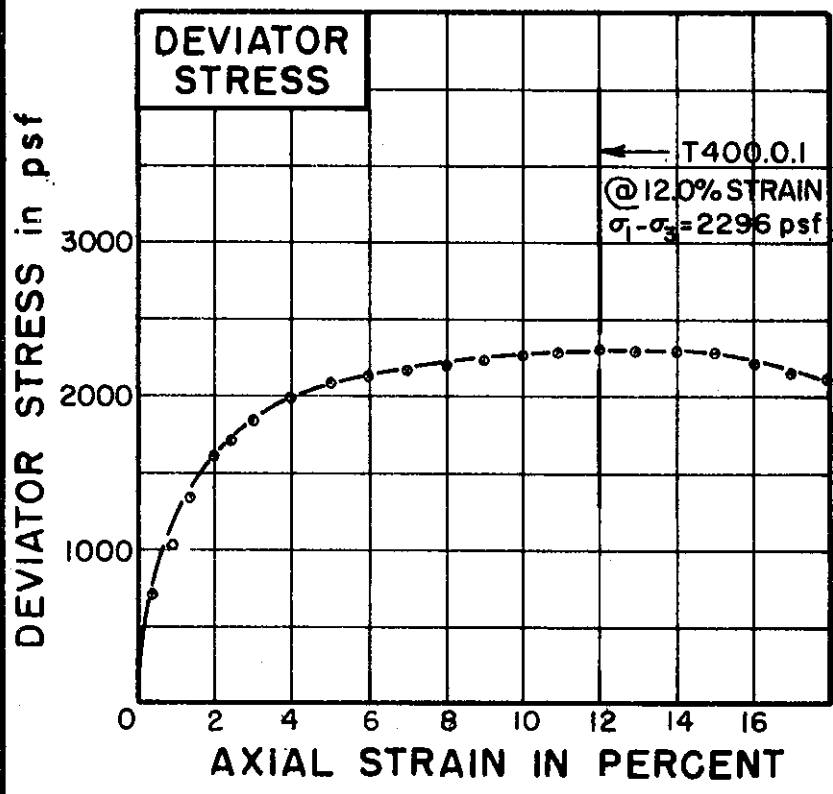
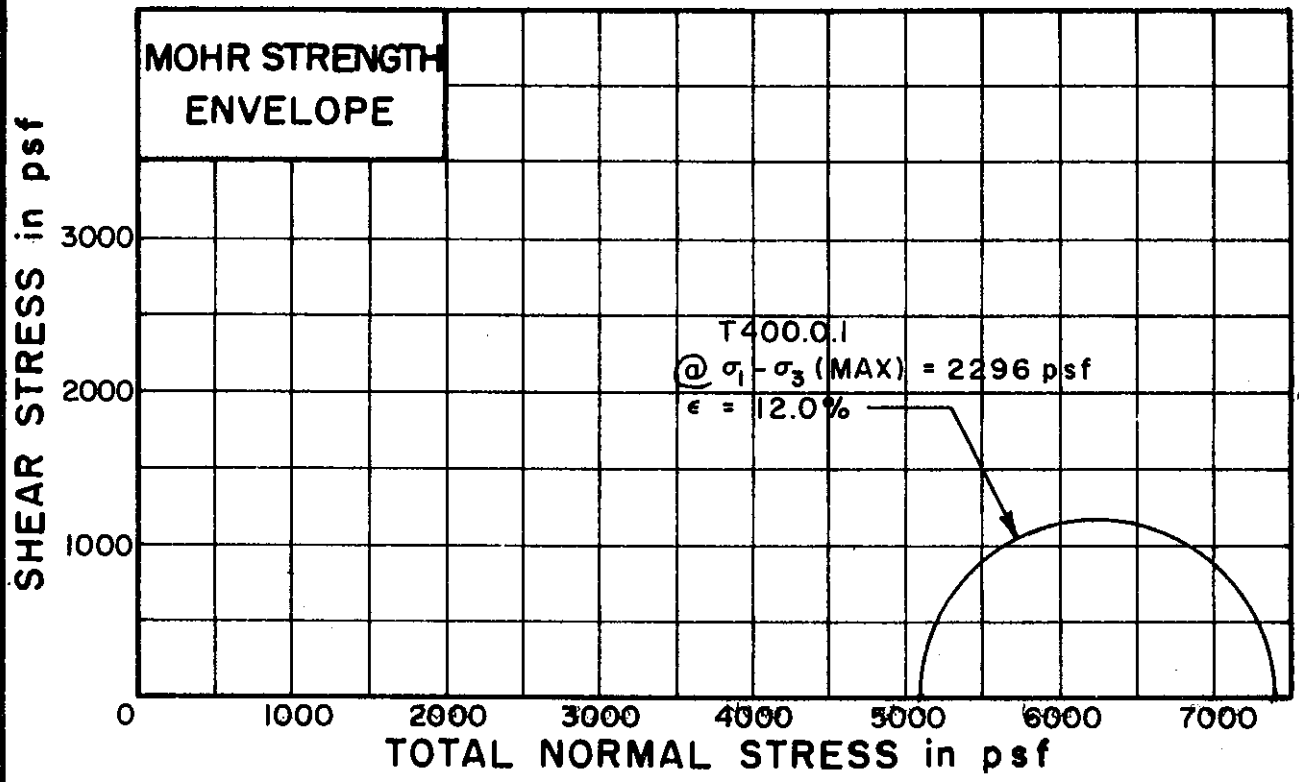

TEST NO./SYMBOL	T400.0.		
-----------------	---------	--	--

INITIAL WATER CONTENT	w_0	25.9%		
DRY DENSITY pcf	γ_d	98		
SAMPLE DIAMETER in.	D_0	1.39		
SAMPLE HEIGHT in.	H_0	3.25		

CONFINING PRESSURE psf	σ_3	5112		
RATE OF STRAIN PERCENT/MINUTE		.25		

FINAL WATER CONTENT	w_f	25.5%		
SKETCH OF SAMPLE AT END OF TEST				

BORING NO. 54

SAMPLE NO. 7

DEPTH 68.8' TO 69.1'

SOIL DESCRIPTION: SILTY CLAY, SANDY (CL)

LIQUID LIMIT 37 PLASTIC LIMIT 18

UNCONSOLIDATED UNDRAINED
 TRIAXIAL COMPRESSION
 TESTS

THE DETROIT EDISON COMPANY
 BELLE RIVER PLANT UNITS I & II

SHEAR STRESS in psf

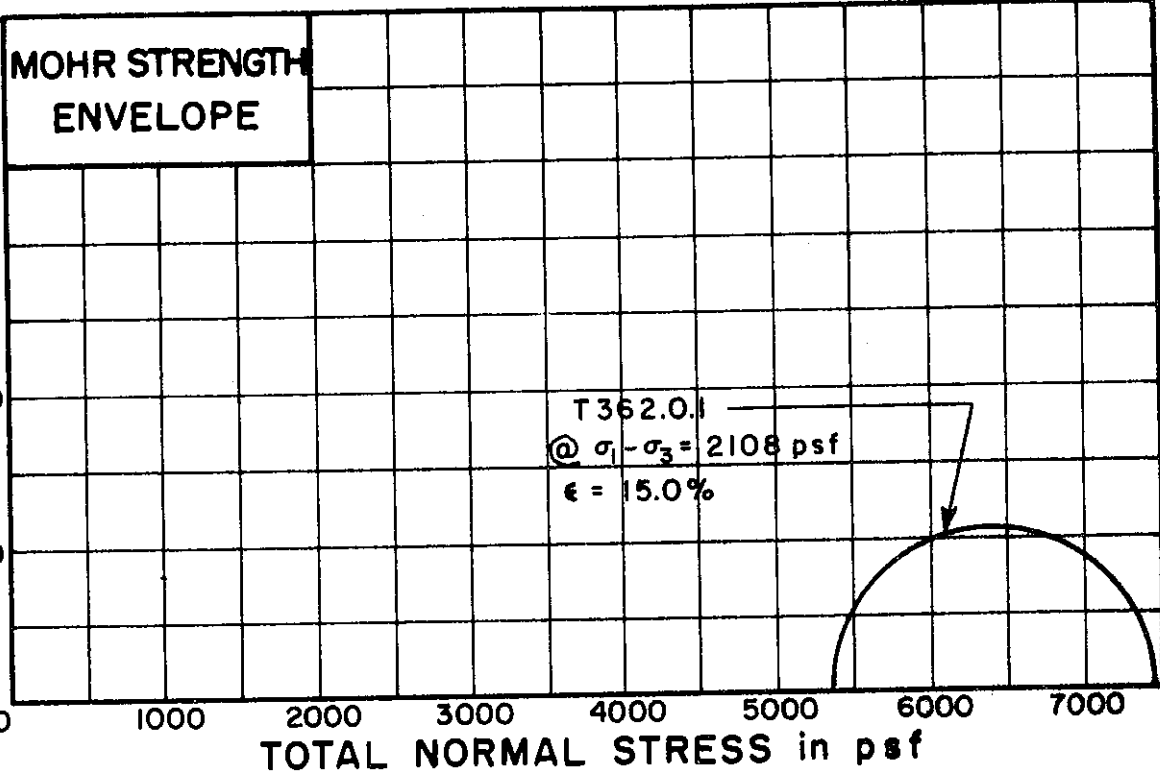

DEVIATOR STRESS in psf

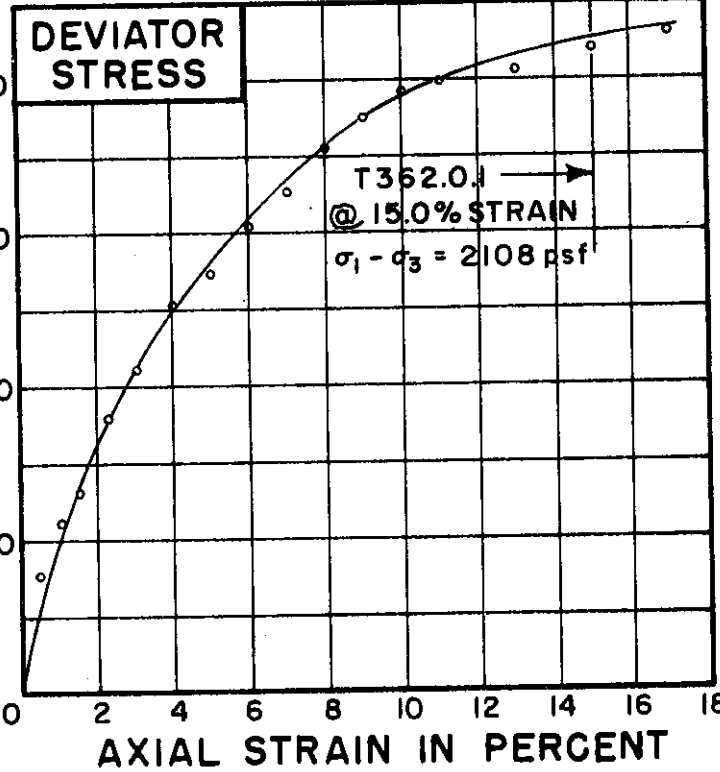

TEST NO./SYMBOL	T362.0.1		
-----------------	----------	--	--

INITIAL WATER CONTENT	w_o	22.6%	
DRY DENSITY	γ_d	105	
SAMPLE DIAMETER	D_o	1.40	
SAMPLE HEIGHT	H_o	3.31	

CONFINING PRESSURE	σ_3	5328	
RATE OF STRAIN		0.27	

FINAL WATER CONTENT	w_f	22.6%	
SKETCH OF SAMPLE AT END OF TEST			

BORING NO. 101

SAMPLE NO. 15

DEPTH 74.6' TO 74.9'

SOIL DESCRIPTION: SILTY CLAY, SANDY (CL)

LIQUID LIMIT 36 PLASTIC LIMIT 21

**UNCONSOLIDATED UNDRAINED
TRIAxIAL COMPRESSION
TESTS**

THE DETROIT EDISON COMPANY
BELLE RIVER PLANT UNITS I & II

FILE 1255

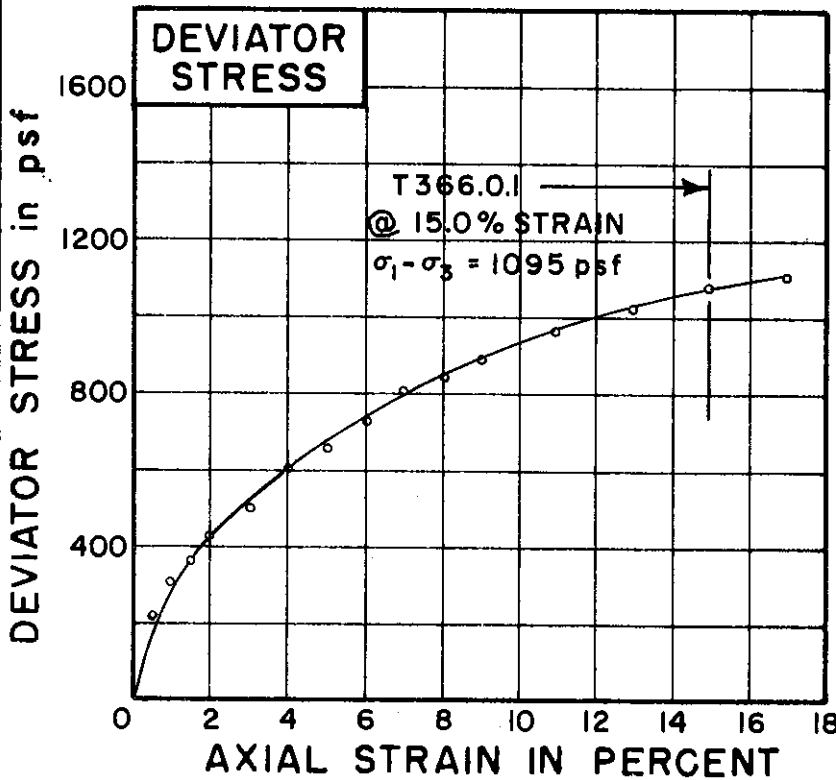
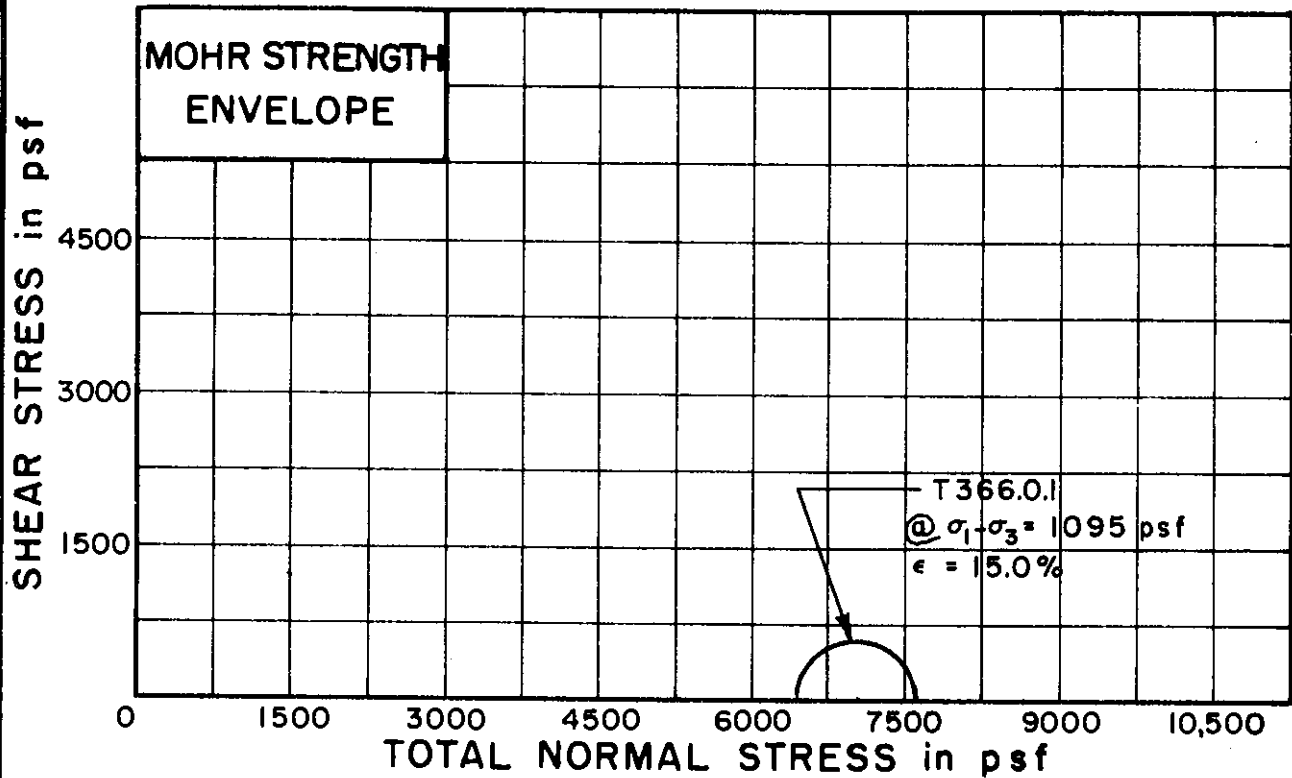

TEST NO./SYMBOL	T366.0.1		
-----------------	----------	--	--

INITIAL WATER CONTENT	w_0	24.5%	
DRY DENSITY pcf	γ_d	100	
SAMPLE DIAMETER in.	D_0	1.40	
SAMPLE HEIGHT in.	H_0	3.27	

CONFINING PRESSURE psf	σ_3	6480	
RATE OF STRAIN PERCENT/MINUTE		0.27	

FINAL WATER CONTENT	w_1	24.3%	
SKETCH OF SAMPLE AT END OF TEST			

BORING NO. 101

SAMPLE NO. 19

DEPTH 94.9' TO 95.3'

SOIL DESCRIPTION: SILTY CLAY (CL)

LIQUID LIMIT 36 PLASTIC LIMIT 20

**UNCONSOLIDATED UNDRAINED
TRIAxIAL COMPRESSION
TESTS**

THE DETROIT EDISON COMPANY
BELLE RIVER PLANT UNITS I & II

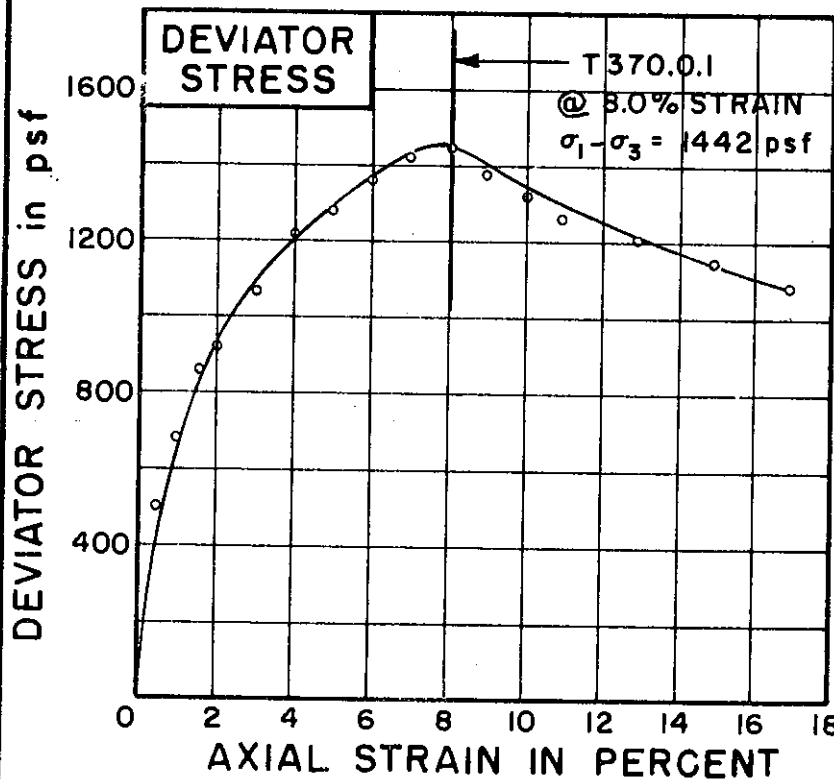
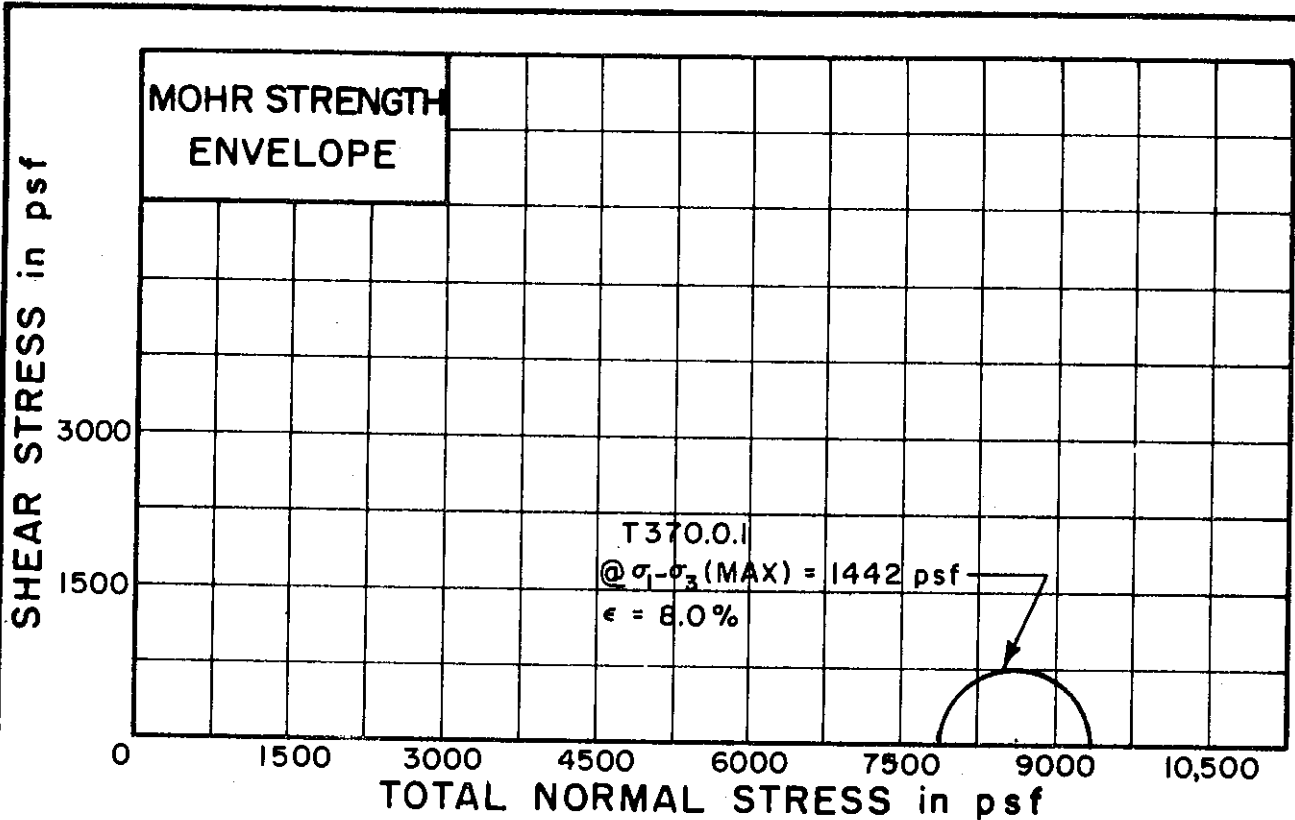

TEST NO./SYMBOL	T370.0.1		
-----------------	----------	--	--

INITIAL WATER CONTENT	w_0	37.2%	
DRY DENSITY ρ_{cf}	γ_d	85	
SAMPLE DIAMETER, in.	D_0	1.40	
SAMPLE HEIGHT, in.	H_0	3.23	

CONFINING PRESSURE ρ_{cf}	σ_3	7920	
RATE OF STRAIN PERCENT/MINUTE		0.27	

FINAL WATER CONTENT	w_f	36.9%	
SKETCH OF SAMPLE AT END OF TEST			

BORING NO. 101
 SAMPLE NO. 23
 DEPTH 119.8' TO 120.2'
 SOIL DESCRIPTION: SILTY CLAY (CL)
 LIQUID LIMIT 44 PLASTIC LIMIT 22

**UNCONSOLIDATED UNDRAINED
 TRIAXIAL COMPRESSION
 TESTS**

THE DETROIT EDISON COMPANY
 BELLE RIVER PLANT UNITS I & II

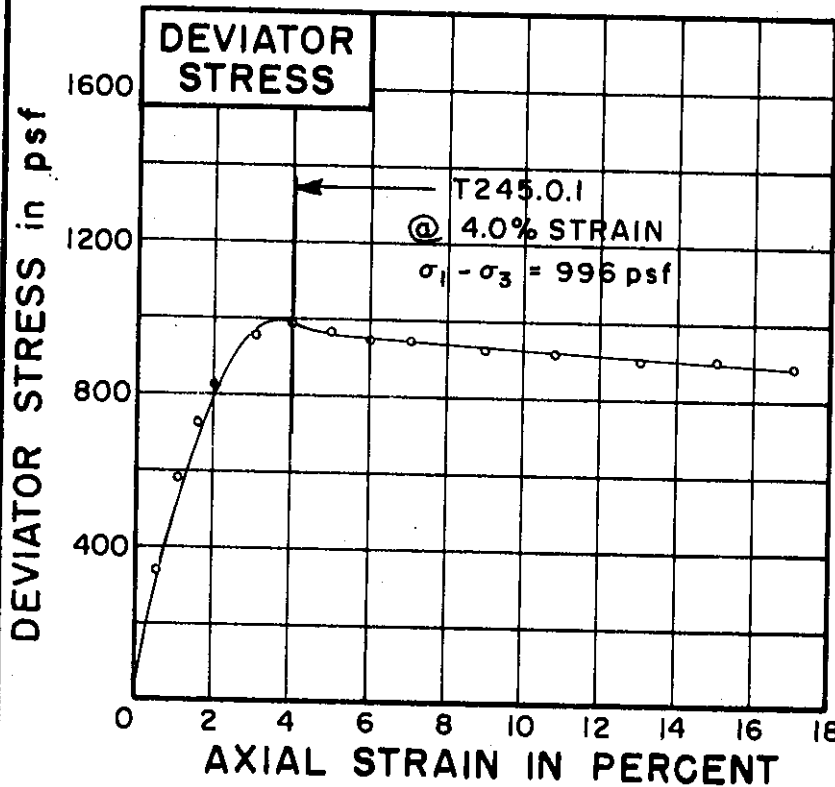
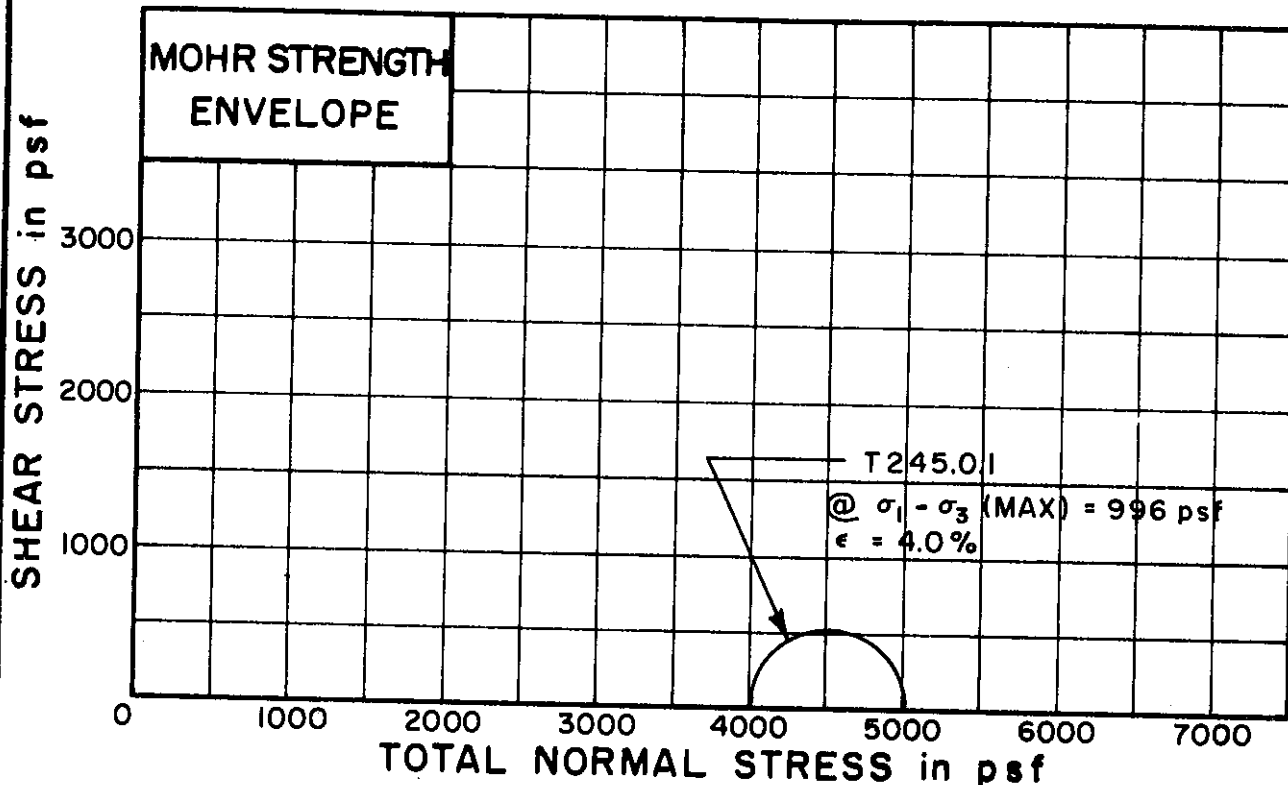

TEST NO./SYMBOL	T245.0.1		
-----------------	----------	--	--

INITIAL WATER CONTENT	w_0	41.1%	
DRY DENSITY psf	γ_d	81	
SAMPLE DIAMETER in.	D_0	1.41	
SAMPLE HEIGHT in.	H_0	3.25	

CONFINING PRESSURE psf	σ_3	4032	
RATE OF STRAIN PERCENT/MINUTE		0.27	

FINAL WATER CONTENT	w_f	40.9%	
SKETCH OF SAMPLE AT END OF TEST			

BORING NO. 126

SAMPLE NO. 11

DEPTH 49.1' TO 49.4'

SOIL DESCRIPTION: SILTY CLAY (CH)

LIQUID LIMIT 59 PLASTIC LIMIT 25

UNCONSOLIDATED UNDRAINED
 TRIAXIAL COMPRESSION
 TESTS

THE DETROIT EDISON COMPANY
 BELLE RIVER PLANT UNITS I & II

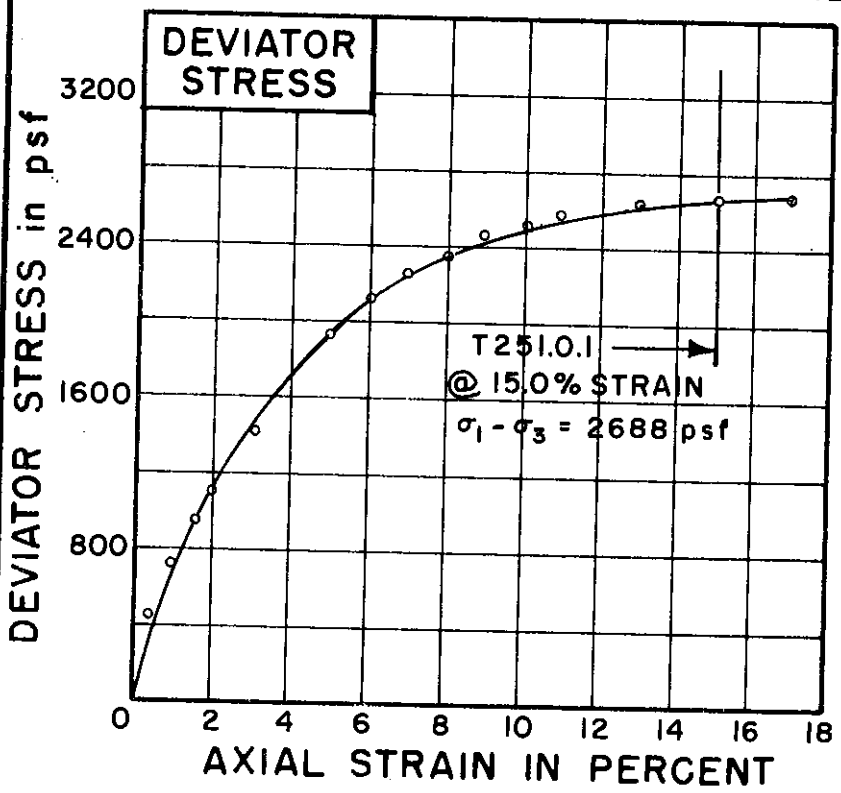
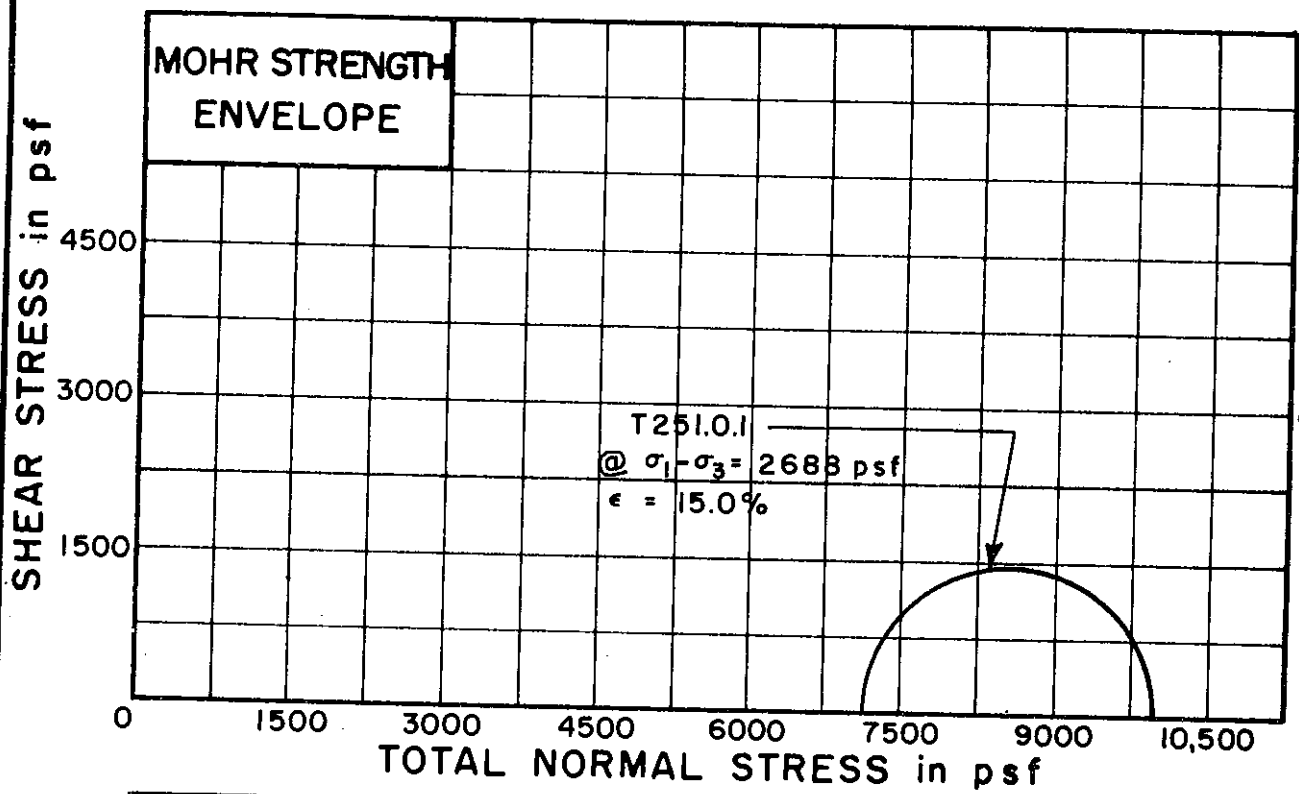

TEST NO./SYMBOL	T251.0.1		
-----------------	----------	--	--

INITIAL WATER CONTENT	w_0	25.3%	
DRY DENSITY pcf	γ_d	96	
SAMPLE DIAMETER in.	D_0	1.40	
SAMPLE HEIGHT in.	H_0	3.33	

CONFINING PRESSURE psf	σ_3	7200	
RATE OF STRAIN PERCENT/MINUTE		0.27	

FINAL WATER CONTENT	w_f	25.2%	
SKETCH OF SAMPLE AT END OF TEST			

BORING NO. 126
 SAMPLE NO. 23
 DEPTH 108.6' TO 108.9'
 SOIL DESCRIPTION: SILTY CLAY (CL)
 LIQUID LIMIT 36 PLASTIC LIMIT 20

UNCONSOLIDATED UNDRAINED
 TRIAXIAL COMPRESSION
 TESTS

THE DETROIT EDISON COMPANY
 BELLE RIVER PLANT UNITS I & II

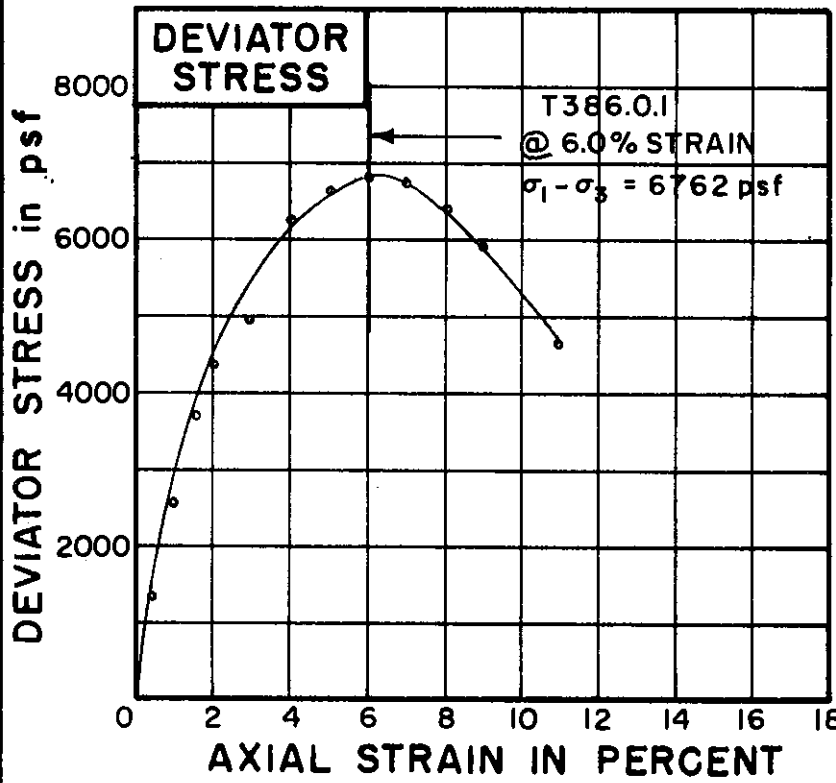
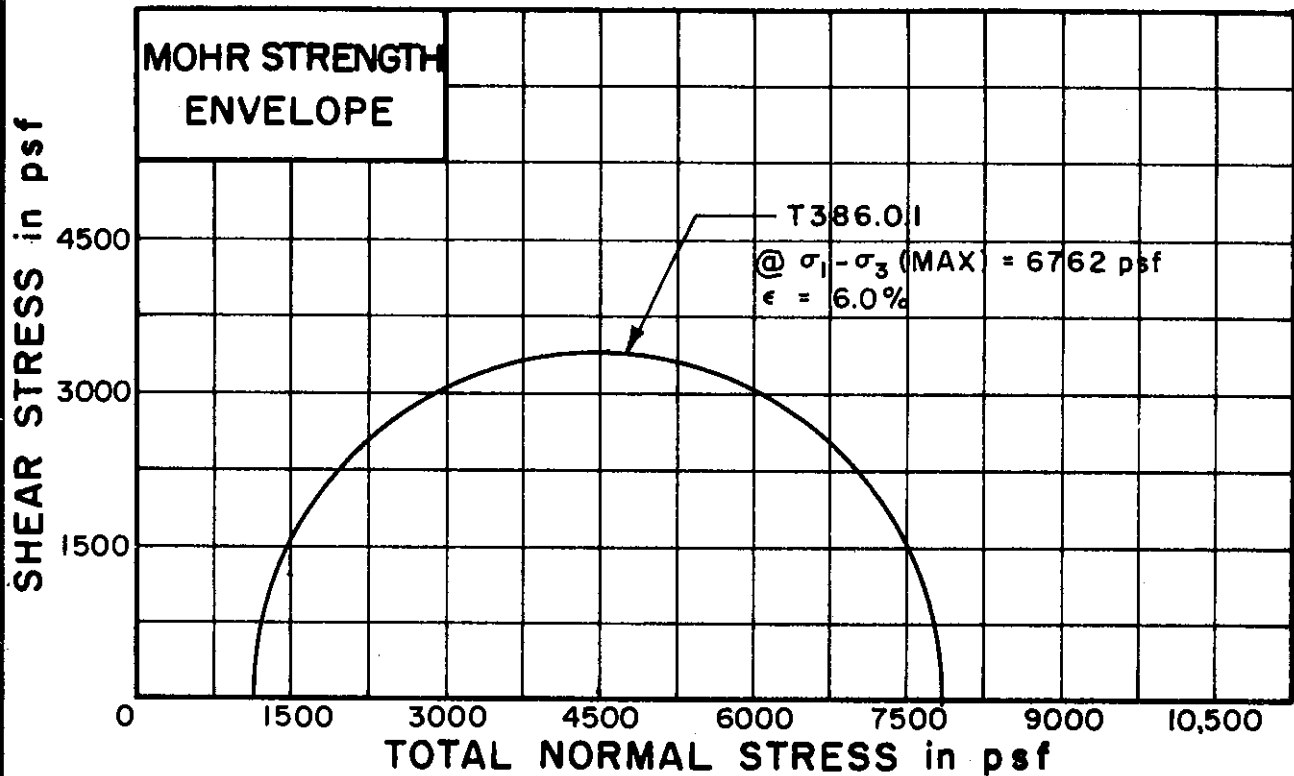

TEST NO./SYMBOL	T386.0.1		
INITIAL WATER CONTENT	w_0 22.3%		
DRY DENSITY pcf	γ_d 108		
SAMPLE DIAMETER in.	D_0 1.45		
SAMPLE HEIGHT in.	H_0 3.50		
CONFINING PRESSURE psf	σ_3 1080		
RATE OF STRAIN PERCENT/MINUTE	0.26		
FINAL WATER CONTENT	w_f 22.2%		
SKETCH OF SAMPLE AT END OF TEST			

BORING NO. 129

SAMPLE NO. 3

DEPTH 8.7' TO 9.0'

SOIL DESCRIPTION: SILTY CLAY (CL-CH)

LIQUID LIMIT 48 PLASTIC LIMIT 23

**UNCONSOLIDATED UNDRAINED
TRIAxIAL COMPRESSION
TESTS**

THE DETROIT EDISON COMPANY
BELLE RIVER PLANT UNITS I & II

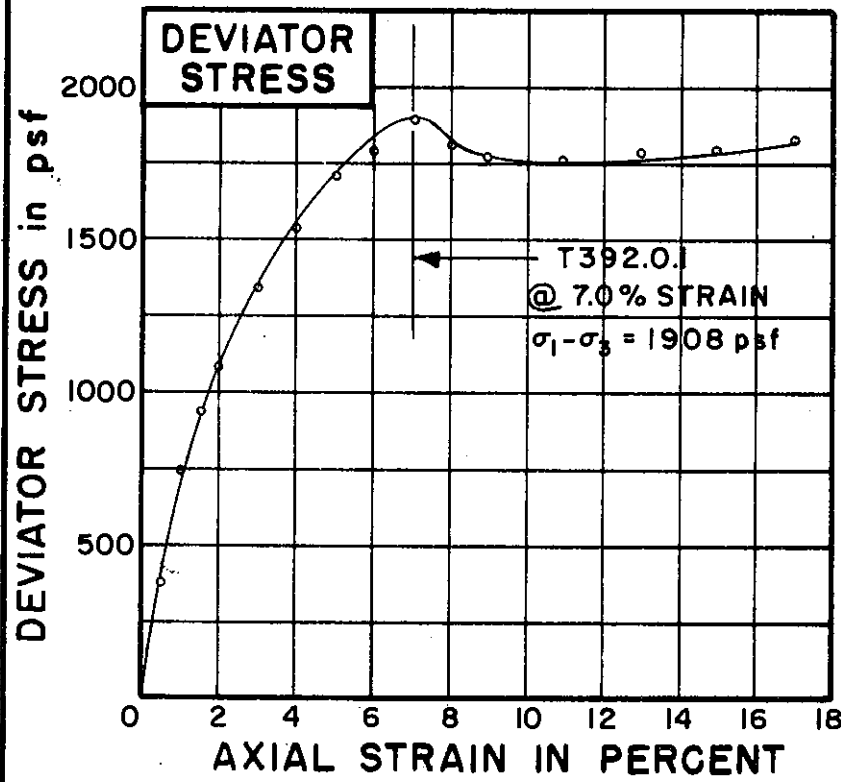
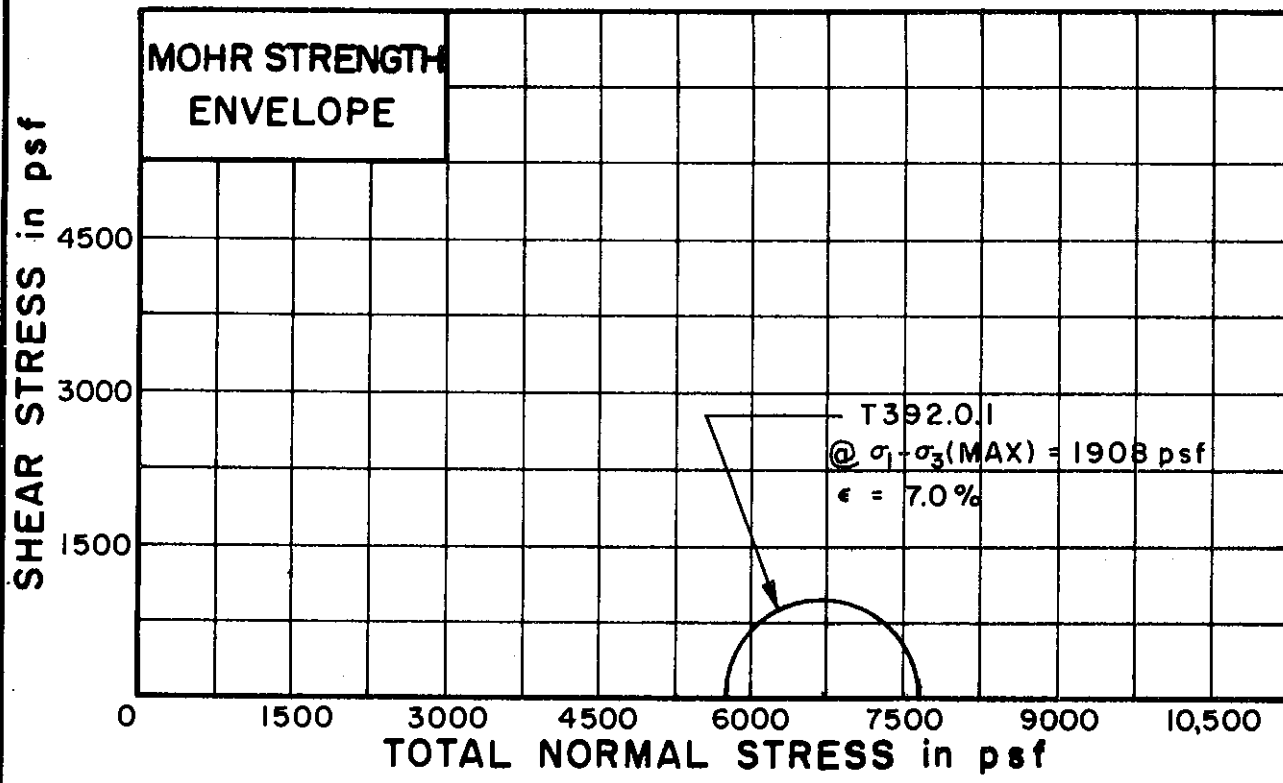

TEST NO./SYMBOL	T392.0.1		
INITIAL WATER CONTENT	w _o 24.8%		
DRY DENSITY pcf	γ_d 101		
SAMPLE DIAMETER, in.	D _o 1.41		
SAMPLE HEIGHT in.	H _o 3.35		
CONFINING PRESSURE psf	σ_3 5760		
RATE OF STRAIN PERCENT/MINUTE	0.27		
FINAL WATER CONTENT	w _f 24.6%		
SKETCH OF SAMPLE AT END OF TEST			

BORING NO. 129

SAMPLE NO. 15

DEPTH 74.0' TO 74.3'

SOIL DESCRIPTION: SILTY CLAY (CL)

LIQUID LIMIT 36 PLASTIC LIMIT 21

UNCONSOLIDATED UNDRAINED TRIAXIAL COMPRESSION TESTS

THE DETROIT EDISON COMPANY
 BELLE RIVER PLANT UNITS I & II

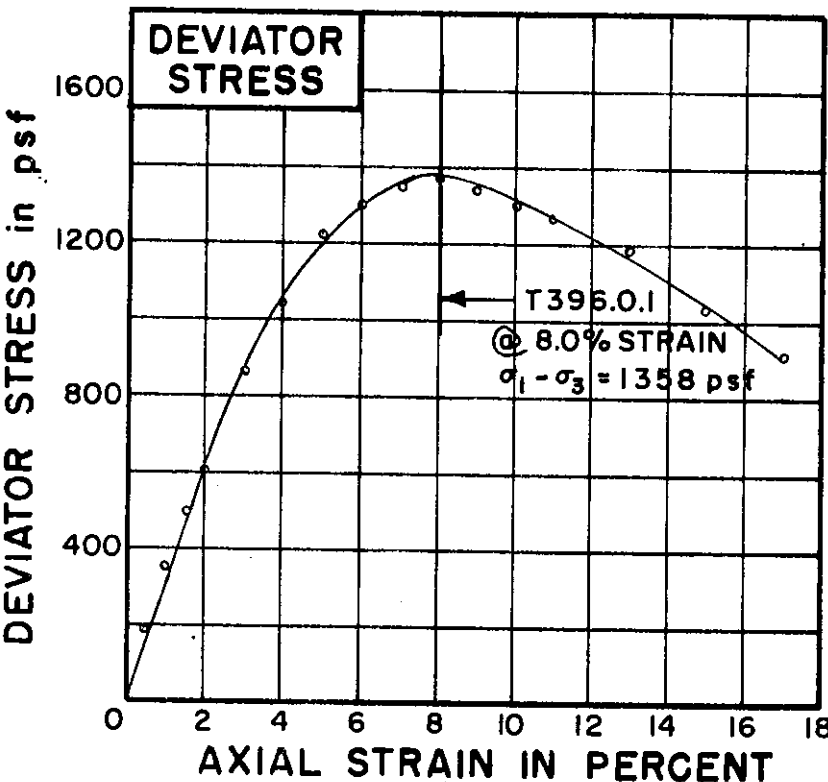
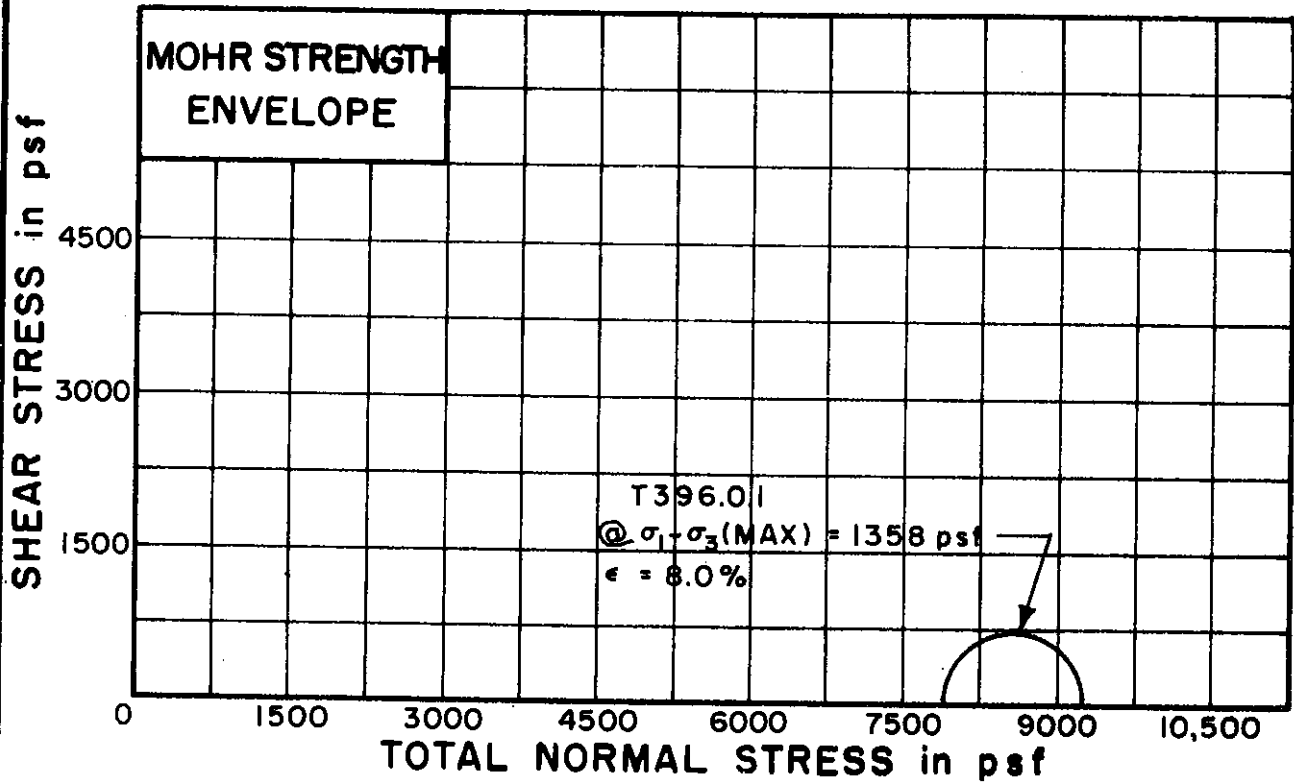

TEST NO./SYMBOL	T396.01		
-----------------	---------	--	--

INITIAL WATER CONTENT	w_0	30.6%	
DRY DENSITY pcf	γ_d	95	
SAMPLE DIAMETER, in.	D_0	1.41	
SAMPLE HEIGHT in.	H_0	3.20	

CONFINING PRESSURE psf	σ_3	7920	
RATE OF STRAIN PERCENT/MINUTE		0.28	

FINAL WATER CONTENT	w_f	30.3%	
SKETCH OF SAMPLE AT END OF TEST			

BORING NO. 129
 SAMPLE NO. 24
 DEPTH 124.1' TO 124.4'
 SOIL DESCRIPTION: SILTY CLAY (CL-CH)
 LIQUID LIMIT 46 PLASTIC LIMIT 22

UNCONSOLIDATED UNDRAINED
 TRIAXIAL COMPRESSION
 TESTS
 THE DETROIT EDISON COMPANY
 BELLE RIVER PLANT UNITS I & II

SHEAR STRESS in psf

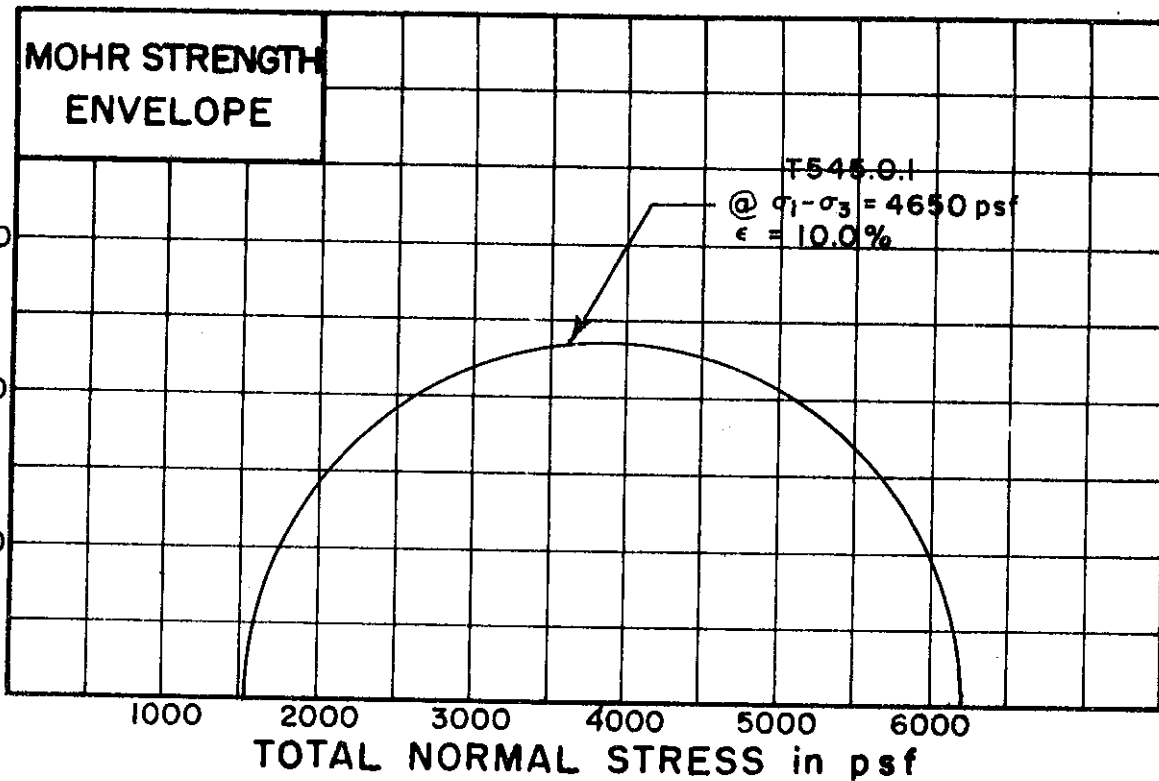

DEVIATOR STRESS in psf

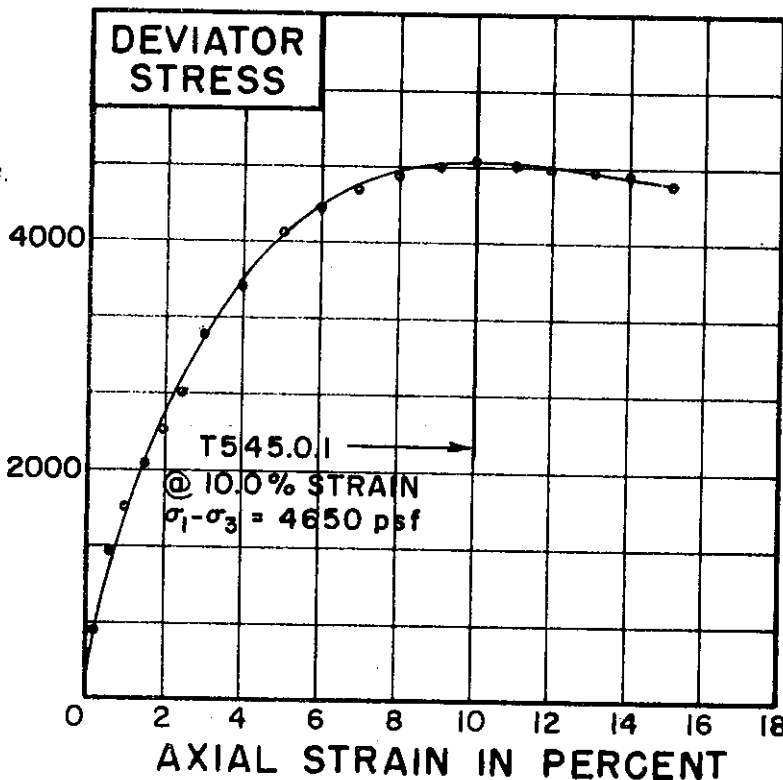

TEST NO./SYMBOL	T545.0.1		
-----------------	----------	--	--

INITIAL WATER CONTENT	w_o	28.3%	
DRY DENSITY pcf	γ_d	95	
SAMPLE DIAMETER in.	D_o	1.41	
SAMPLE HEIGHT in.	H_o	3.32	

CONFINING PRESSURE psf	σ_3	1555	
RATE OF STRAIN PERCENT/MINUTE		0.27	

FINAL WATER CONTENT	w_f	28.1%	
SKETCH OF SAMPLE AT END OF TEST			

BORING NO. 151A
 SAMPLE NO. 3
 DEPTH 13.0' TO 13.3'
 SOIL DESCRIPTION: SILTY CLAY (CL-CH)
 LIQUID LIMIT 48 PLASTIC LIMIT 20

UNCONSOLIDATED UNDRAINED
 TRIAXIAL COMPRESSION
 TESTS

THE DETROIT EDISON COMPANY
 BELLE RIVER PLANT UNITS I & II

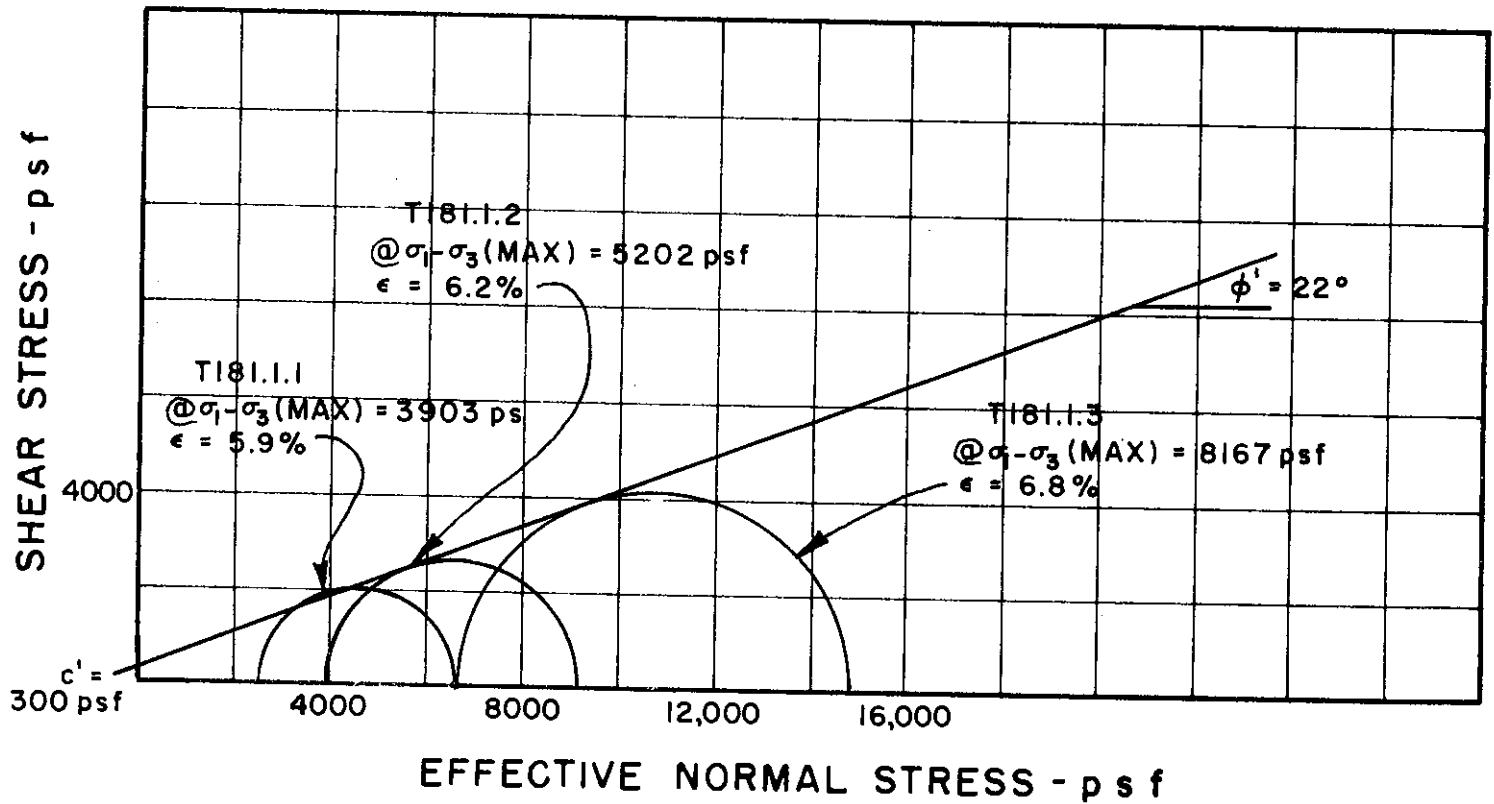
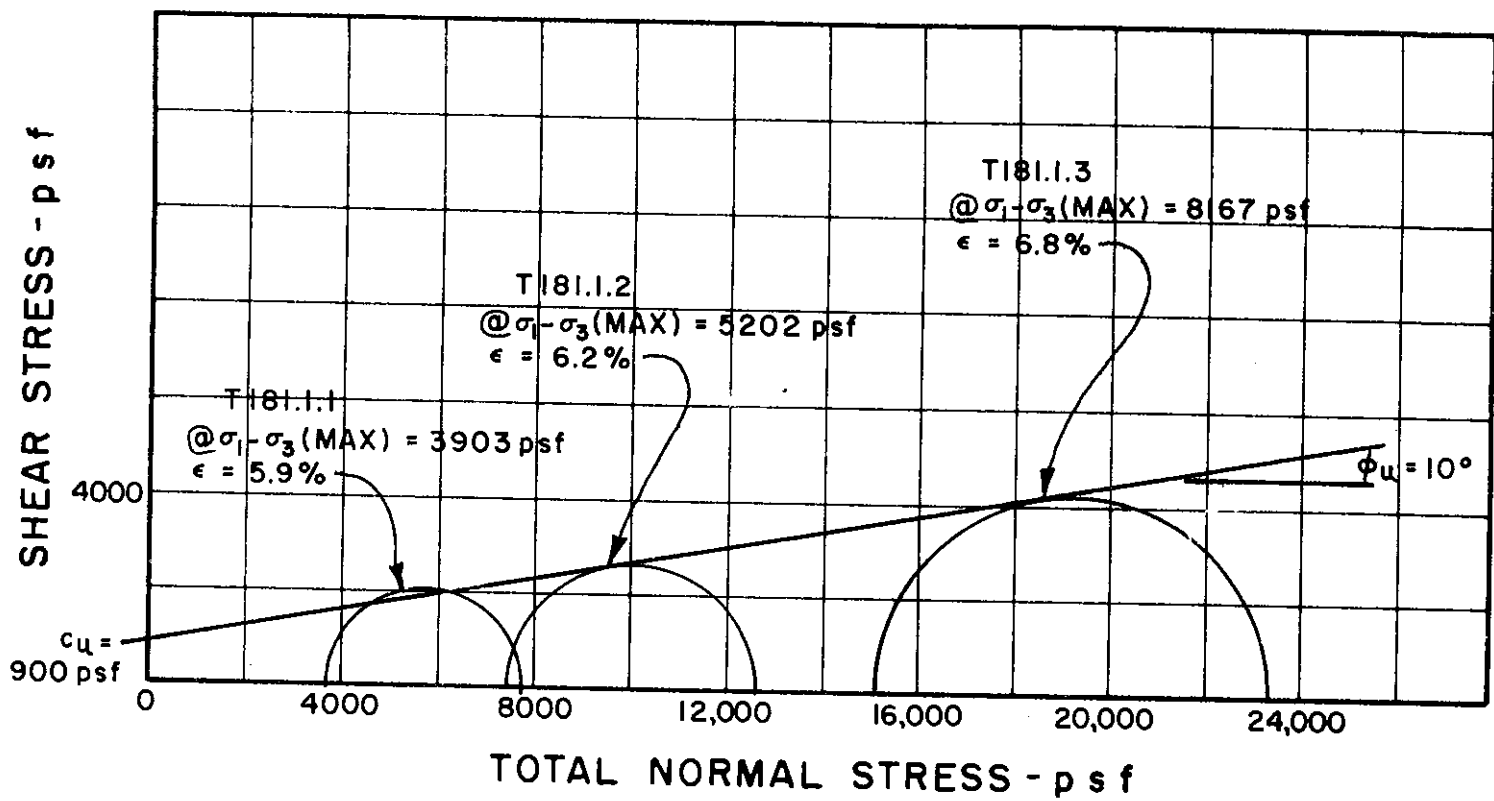

BORING NO. 18

SAMPLE NO. 12

DEPTH 108.0' TO 110.0'

REMARKS ENVELOPE IS INTERPRETIVE,
BASED ON LIMITED DATA POINTS
AVAILABLE

GOLDBERG-ZOINO AND ASSOCIATES, INC.
 CONSULTANTS IN GEOTECHNICAL ENGINEERING

MOHR STRENGTH ENVELOPE
 TRIAXIAL COMPRESSION
 TESTS

THE DETROIT EDISON COMPANY
 BELLE RIVER PLANT UNITS I & II
 FILE 1255

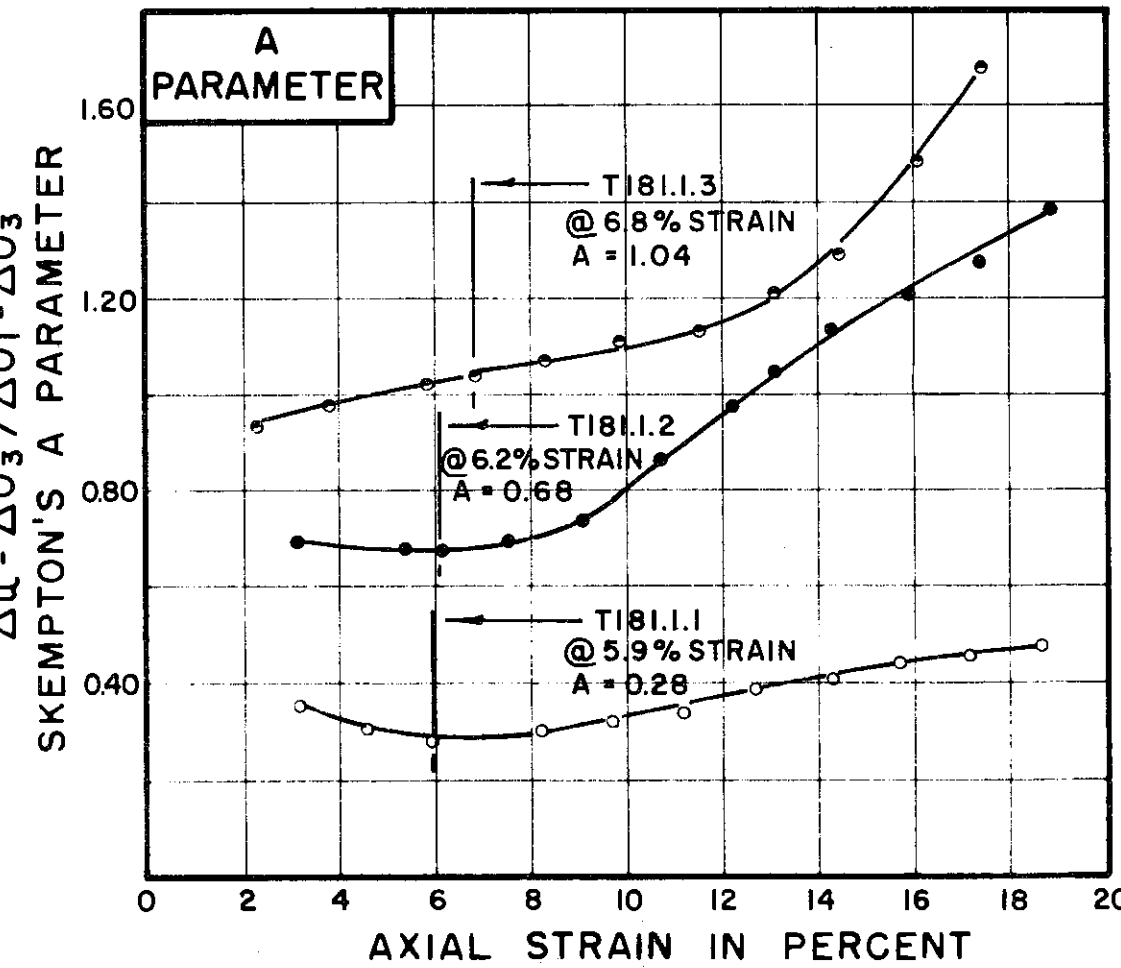
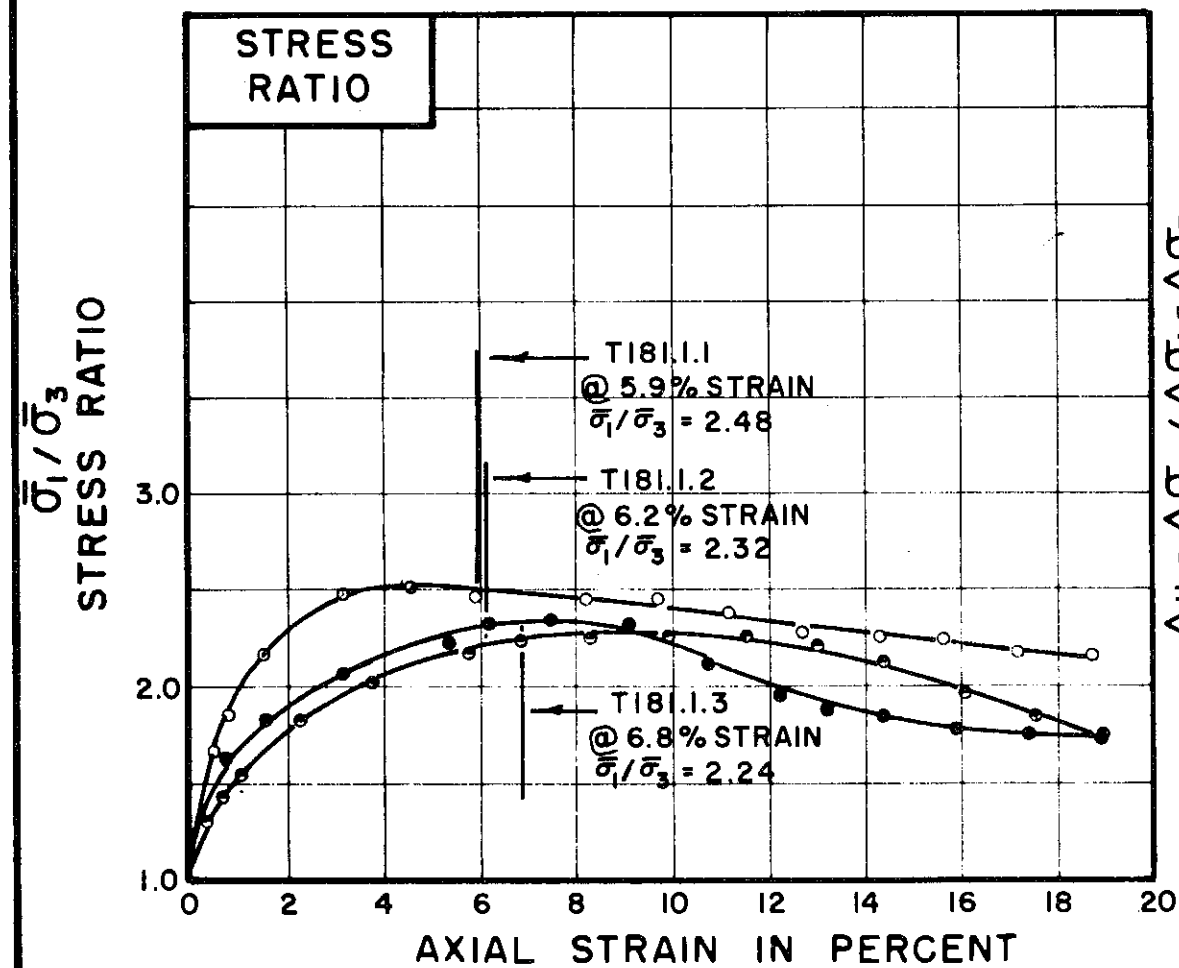
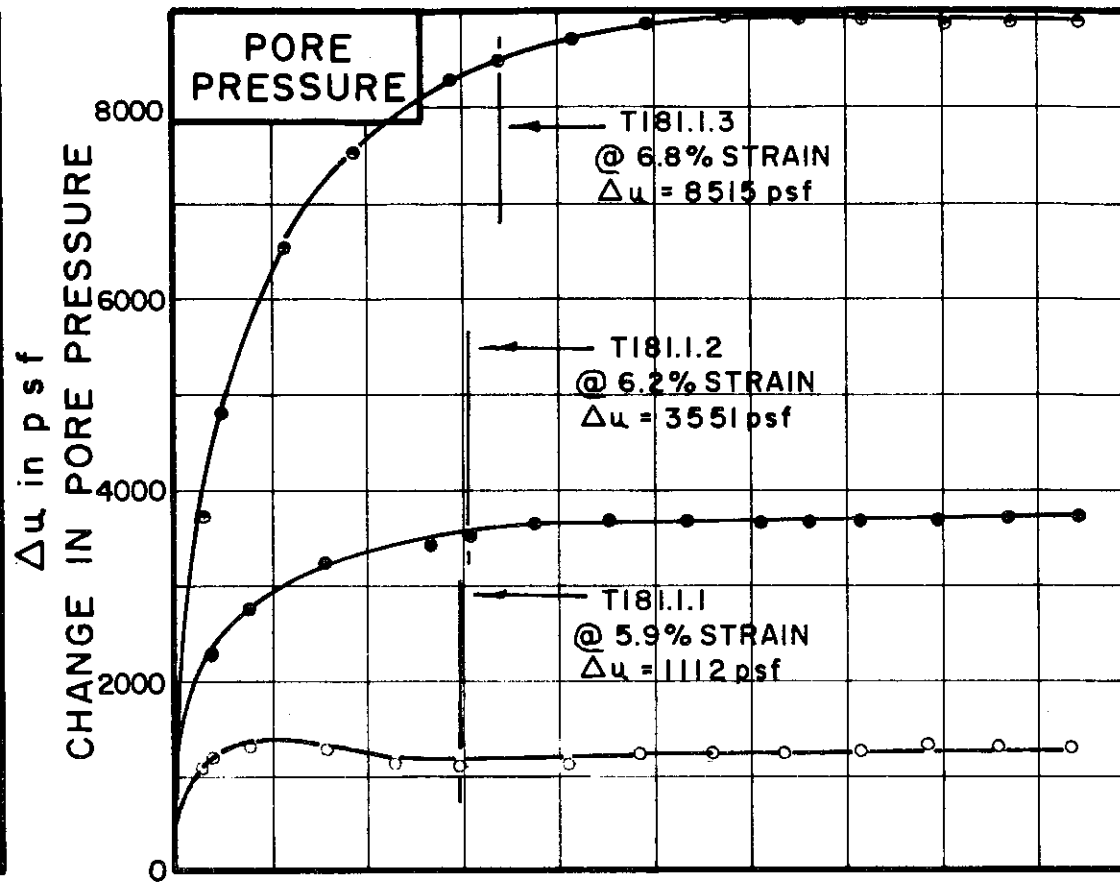
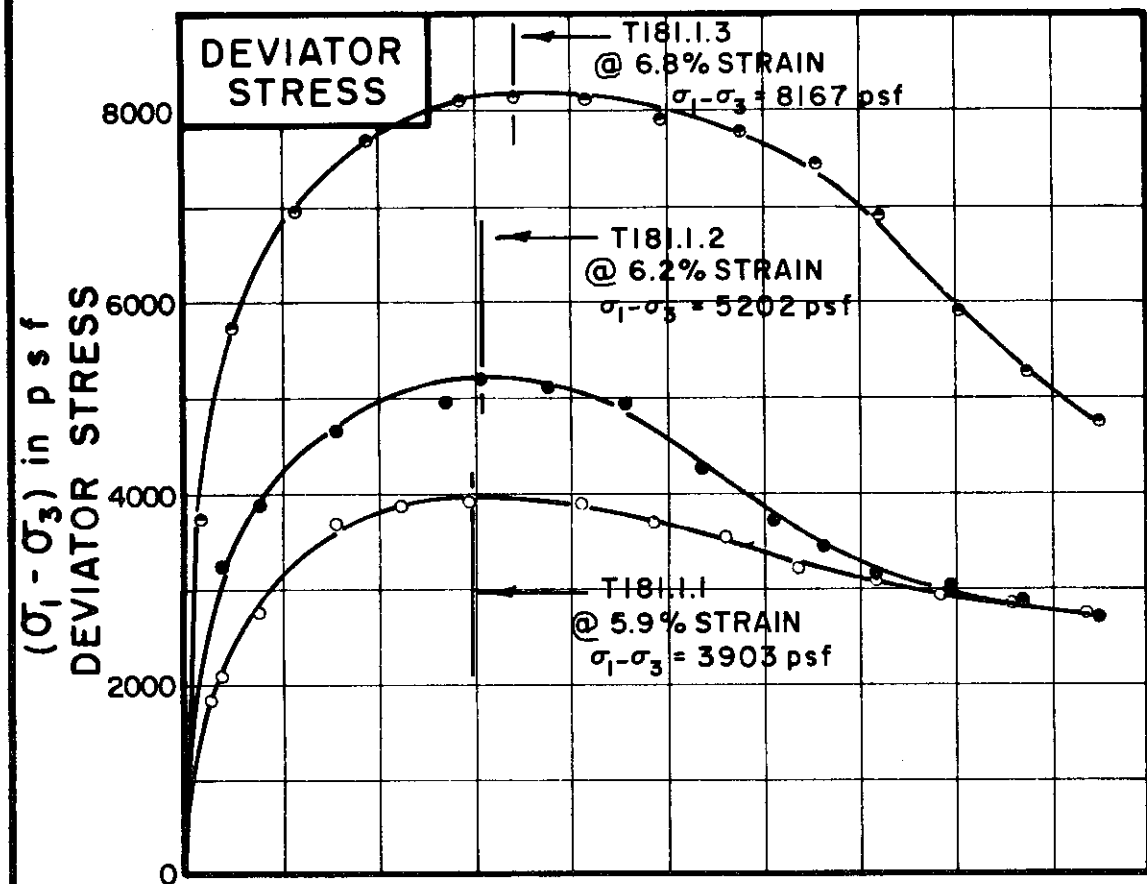

TEST NO. / SYMBOL	T181.1.1	T181.1.2	T181.1.3
-------------------	----------	----------	----------

INITIAL CONDITIONS	WATER CONTENT	w ₀	34.5%	31.0%	30.7%
	DRY DENSITY	γ _d	87	92	92
	lb/cu ft				
CONDITIONS BEFORE SHEAR	SAMPLE DIAMETER	D ₀	1.40	1.39	1.37
	in.				
	SAMPLE HEIGHT	H ₀	3.37	3.35	3.37
FINAL CONDITIONS	FINAL BACK PRESSURE	u ₀	10080	7200	6480
	psf				
	INITIAL EFFECTIVE STRESS	σ̄ ₁ / σ̄ ₃	3744	7488	15120
CONDITIONS AFTER SHEAR	VOLUMETRIC STRAIN	ε _{vol}	2.32%	4.19%	6.61%
	PORE PRESSURE RESPONSE		95%	97%	93%
	WATER CONTENT	w _f	33.7%	29.3%	27.7%
SKETCH OF SAMPLE AT END OF TEST					

RATE OF STRAIN PERCENT/MINUTE	.024	.024	.024
-------------------------------	------	------	------

BORING NO. 18
SAMPLE NO. 12
DEPTH 108.0' TO 110.0'
SOIL DESCRIPTION SILTY CLAY (CL)
LIQUID LIMIT 46 PLASTIC LIMIT 22

CONSOLIDATED UNDRAINED
TRIAxIAL COMPRESSION
TESTS
THE DETROIT EDISON COMPANY
BELLE RIVER PLANT UNITS I & II
FILE 1255

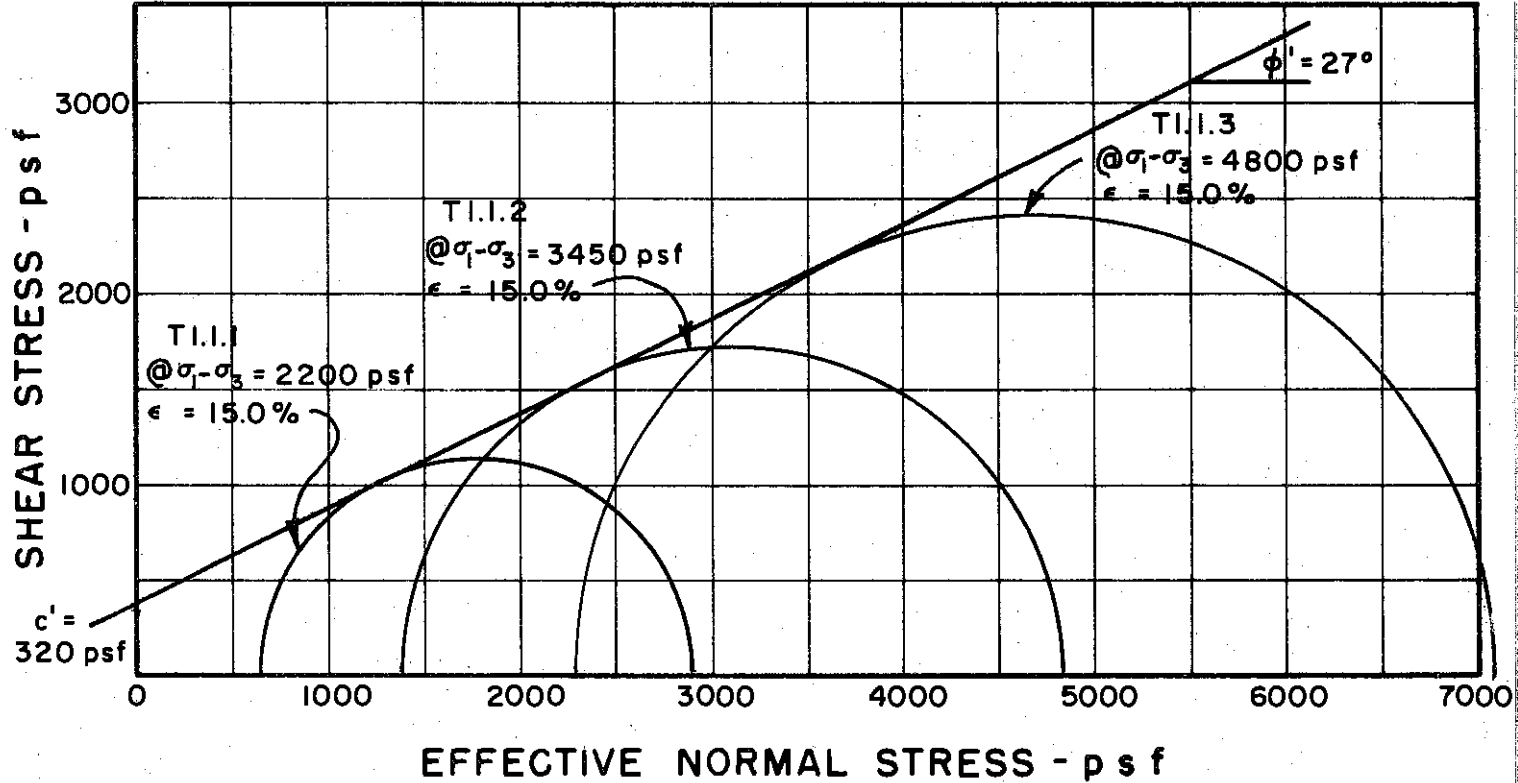
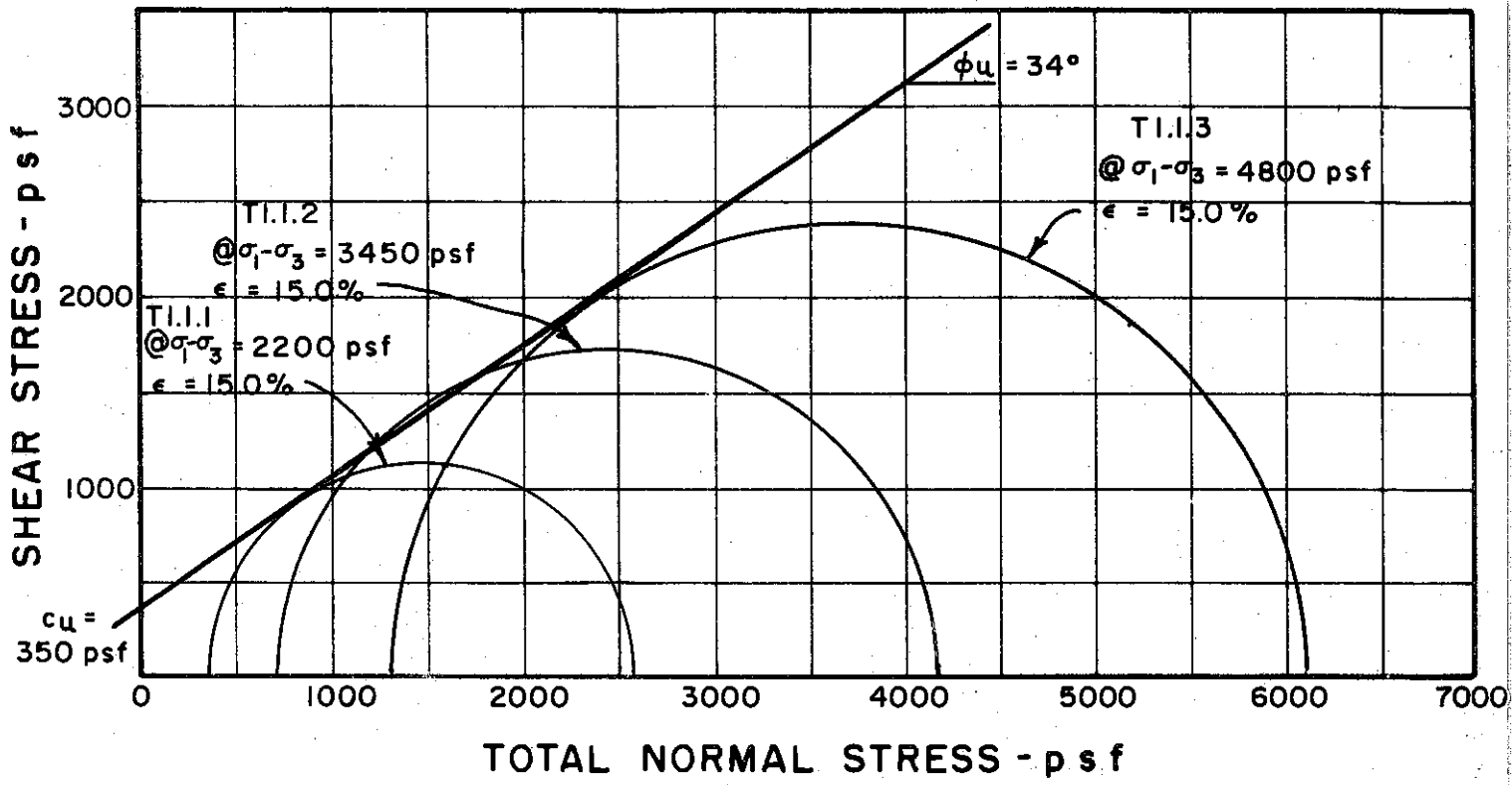

BORING NO. 26
 SAMPLE NO. 2
 DEPTH 3.5 TO 5.5

MOHR STRENGTH ENVELOPE
 TRIAXIAL COMPRESSION
 TESTS

REMARKS ENVELOPE IS INTERPRETIVE,
BASED ON LIMITED DATA POINTS
AVAILABLE
 GOLDBERG-ZOINO AND ASSOCIATES, INC.
 CONSULTANTS IN GEOTECHNICAL ENGINEERING

THE DETROIT EDISON COMPANY
 BELLE RIVER PLANT UNITS I & II
 FILE 1255
 C-387

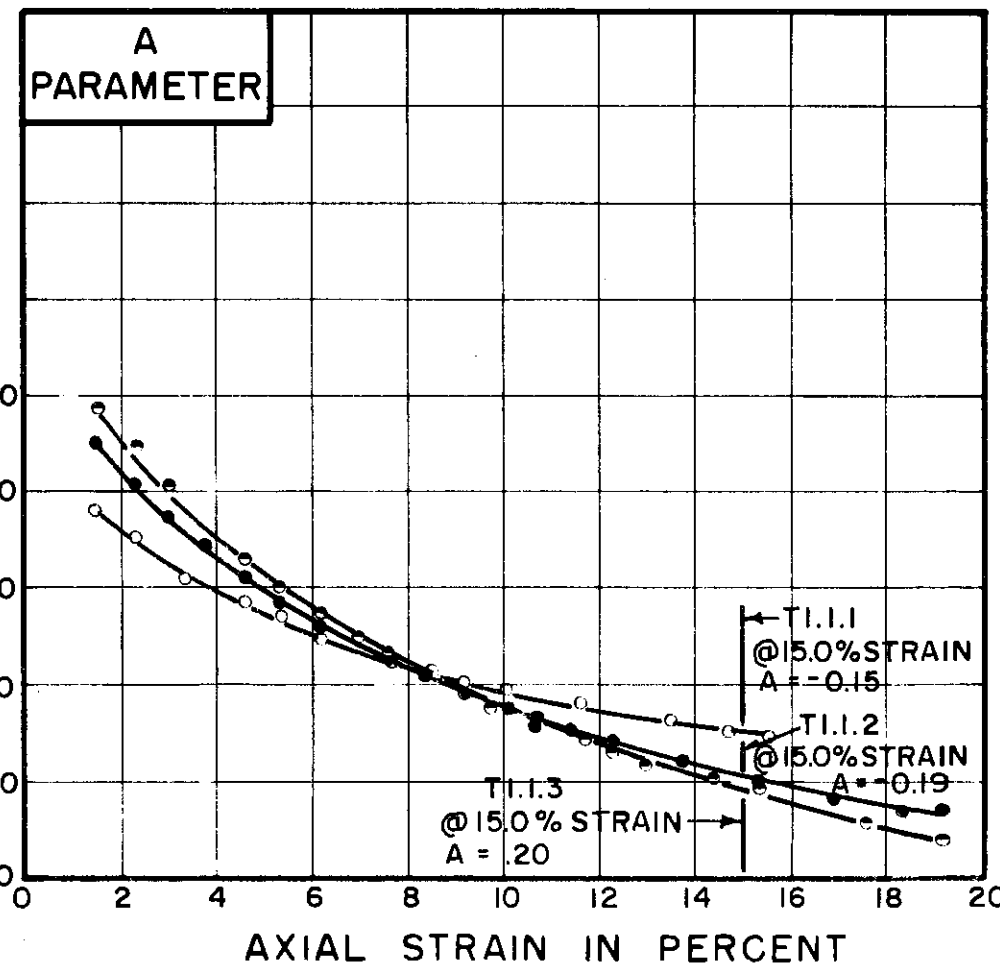
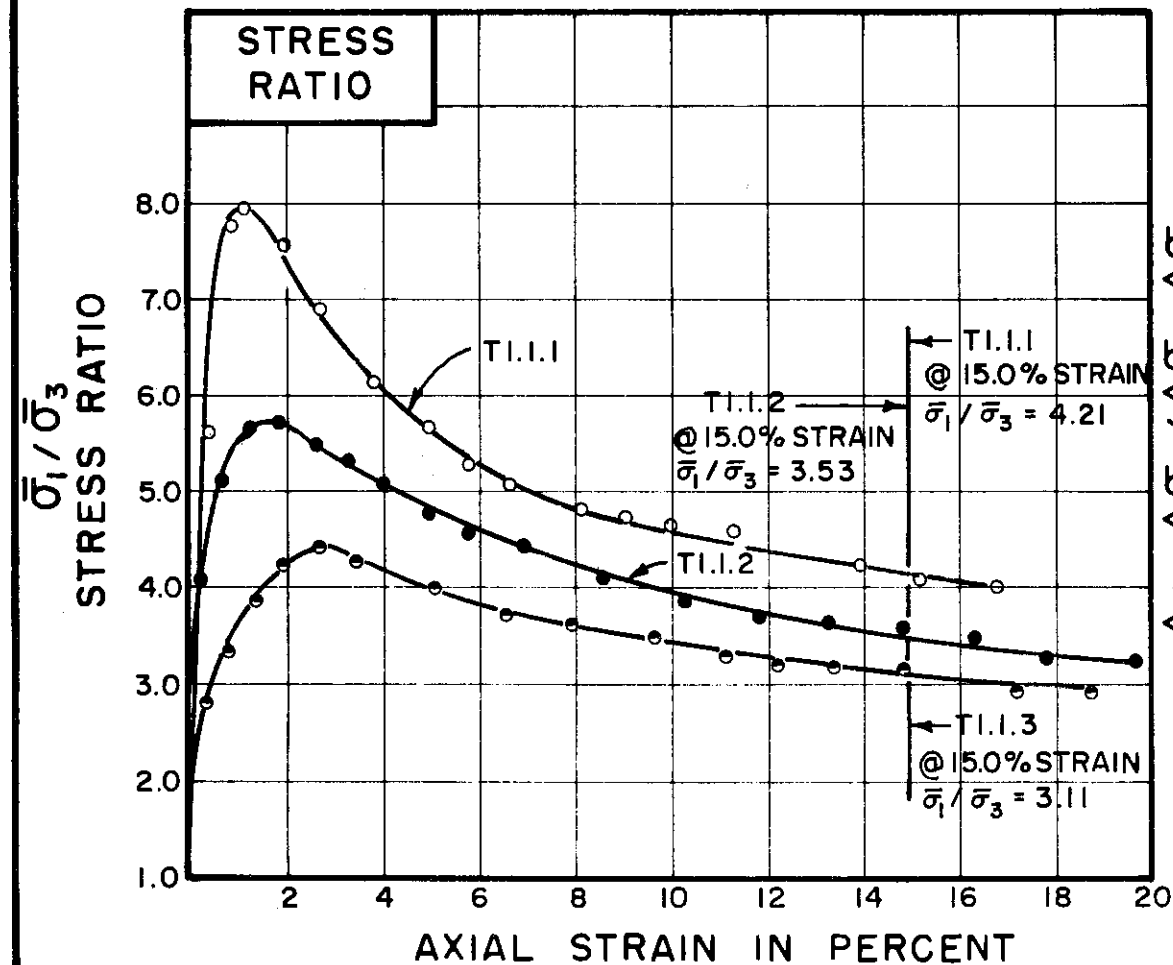
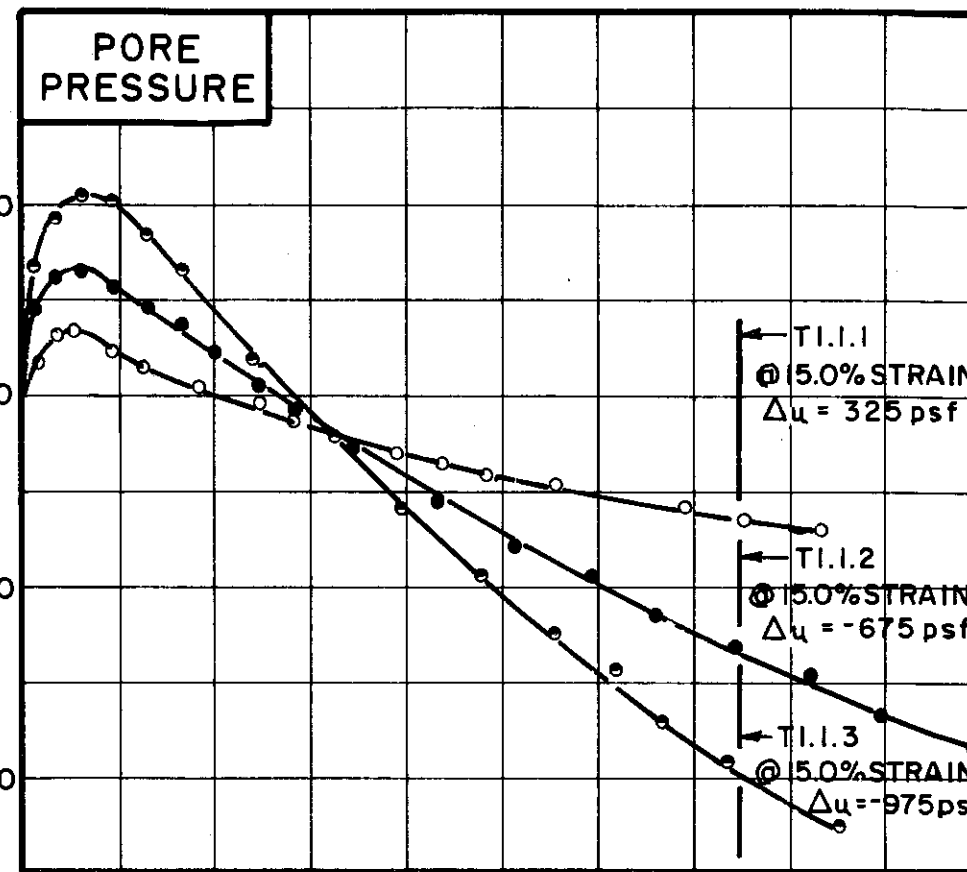
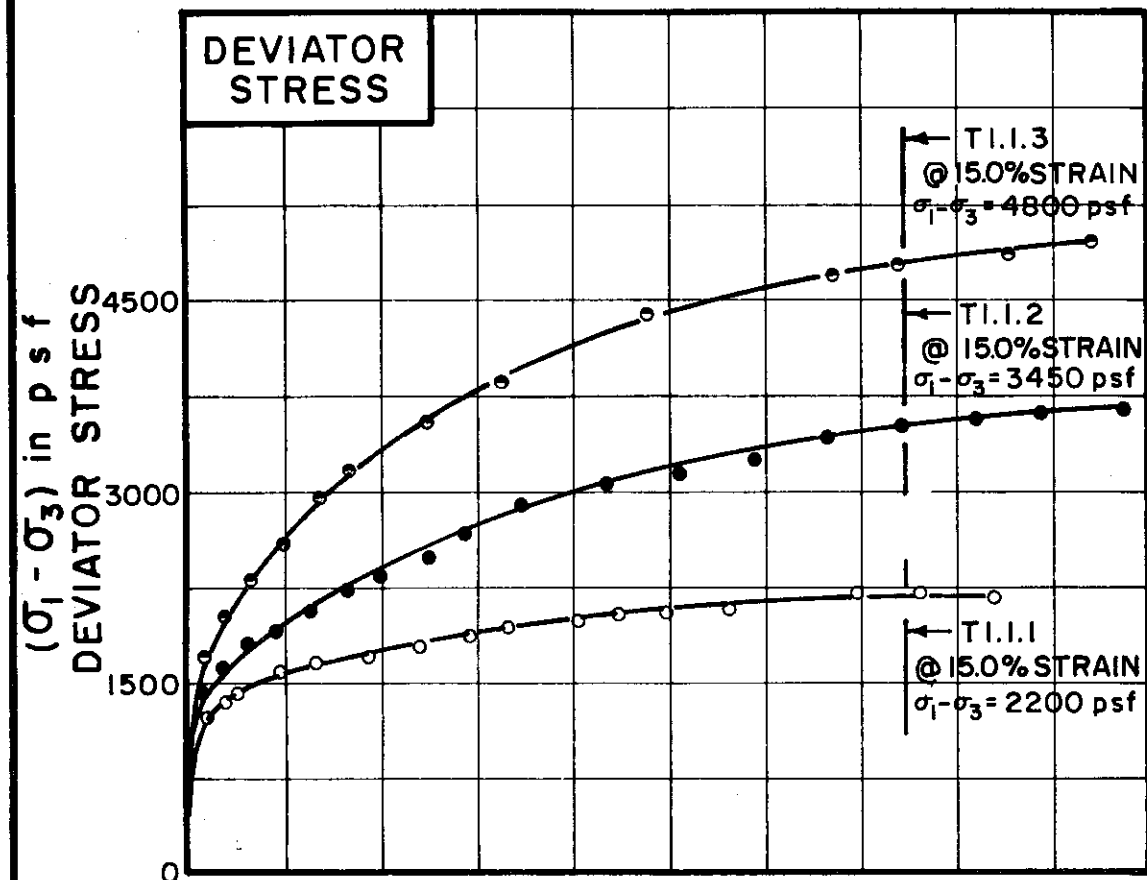

TEST NO. / SYMBOL	T1.1.1	T1.1.2	T1.1.3
	○	●	○

INITIAL CONDITIONS		T1.1.1	T1.1.2	T1.1.3
WATER CONTENT	w_0	23.0%	23.9%	22.3%
DRY DENSITY	γ_d pcf	104	103	108
SAMPLE DIAMETER	D_0 in.	1.39	1.39	1.47
SAMPLE HEIGHT	H_0 in.	3.22	3.25	3.26
FINAL CONDITIONS BEFORE SHEAR		T1.1.1	T1.1.2	T1.1.3
FINAL BACK PRESSURE	u_0 psf	8740	8352	8410
INITIAL EFFECTIVE STRESS	$\bar{\sigma}_1, \bar{\sigma}_3$ psf	360	691	1296
VOLUMETRIC STRAIN	ϵ_{vol}	.4%	1.0%	1.4%
PORE PRESSURE RESPONSE		100%	98%	94%
FINAL CONDITIONS AFTER SHEAR		T1.1.1	T1.1.2	T1.1.3
WATER CONTENT	w_f	26.7%	26.7%	25.3%
SKETCH OF SAMPLE AT END OF TEST				

RATE OF STRAIN PERCENT/MINUTE	.025	.025	.025
-------------------------------	------	------	------

BORING NO. 26
 SAMPLE NO. 2
 DEPTH 3.5 TO 5.5
 SOIL DESCRIPTION SILTY CLAY (CL-CH)
 LIQUID LIMIT 53 PLASTIC LIMIT 24

CONSOLIDATED UNDRAINED
 TRIAXIAL COMPRESSION
 TESTS

THE DETROIT EDISON COMPANY
 BELLE RIVER PLANT UNITS I & II

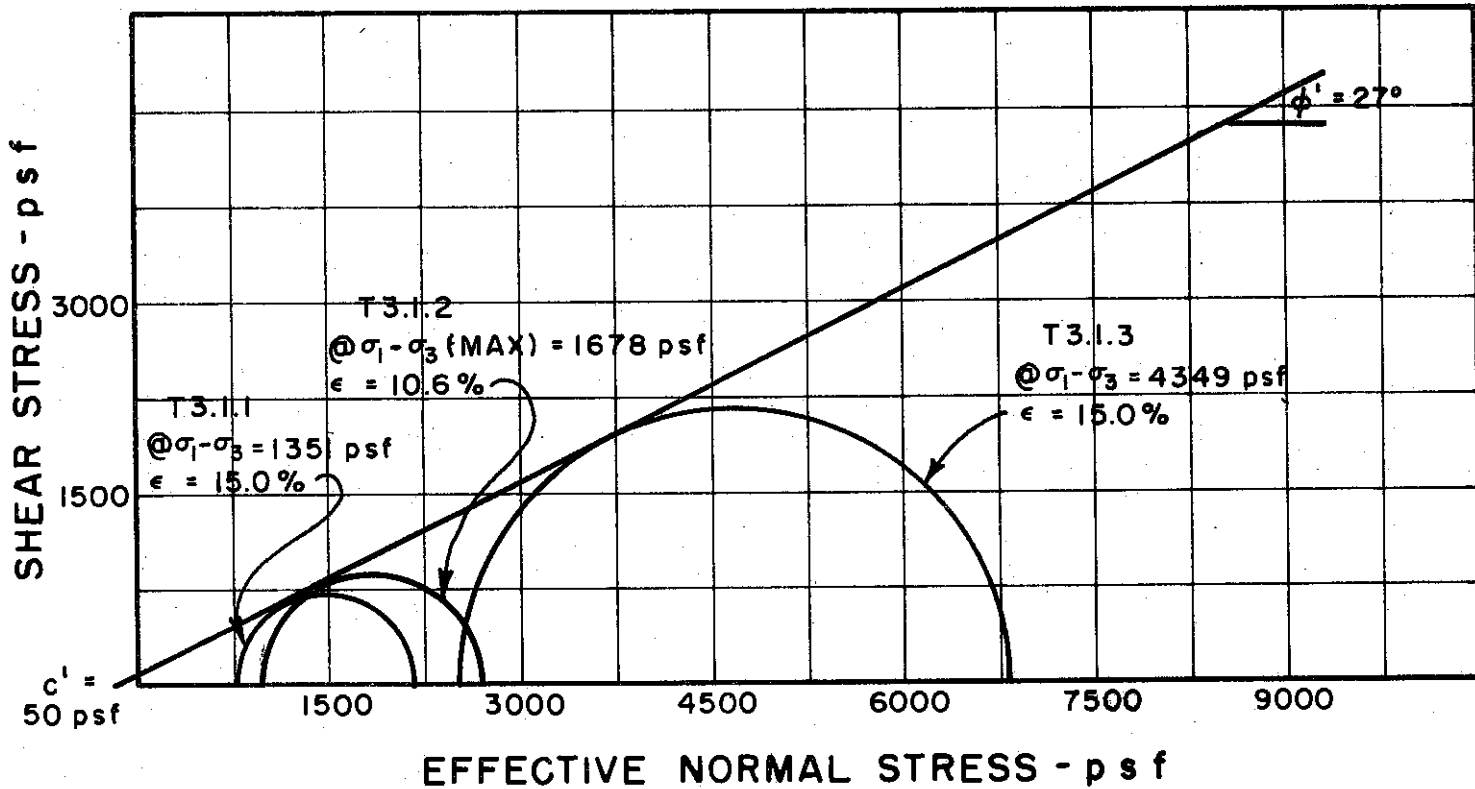
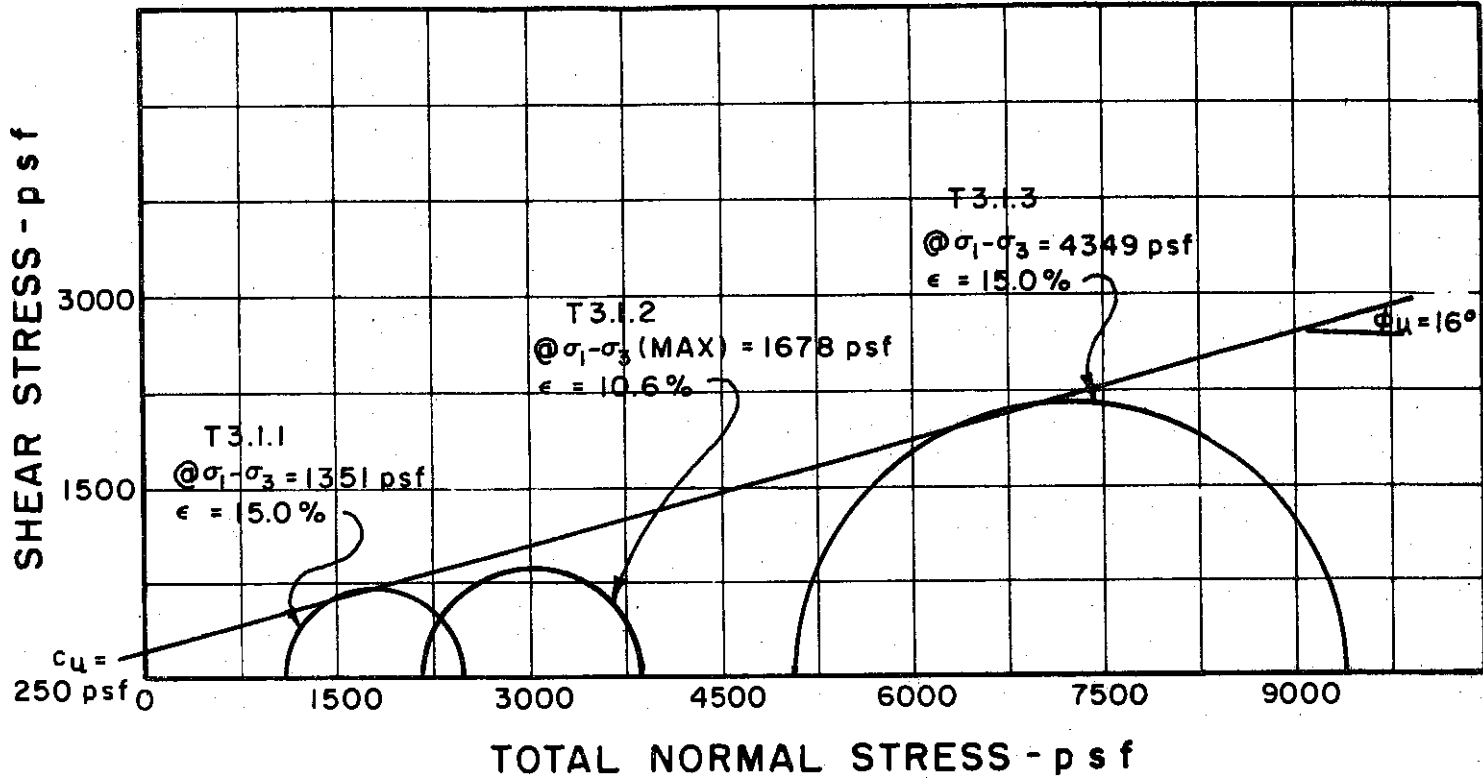

BORING NO. 26

SAMPLE NO. 5

DEPTH 18.0 TO 20.0

REMARKS ENVELOPE IS INTERPRETIVE,
BASED ON LIMITED DATA POINTS
AVAILABLE

GOLDBERG-ZOINO AND ASSOCIATES, INC.
 CONSULTANTS IN GEOTECHNICAL ENGINEERING

MOHR STRENGTH ENVELOPE
 TRIAXIAL COMPRESSION
 TESTS

THE DETROIT EDISON COMPANY
 BELLE RIVER PLANT UNITS I & II

FILE 1255

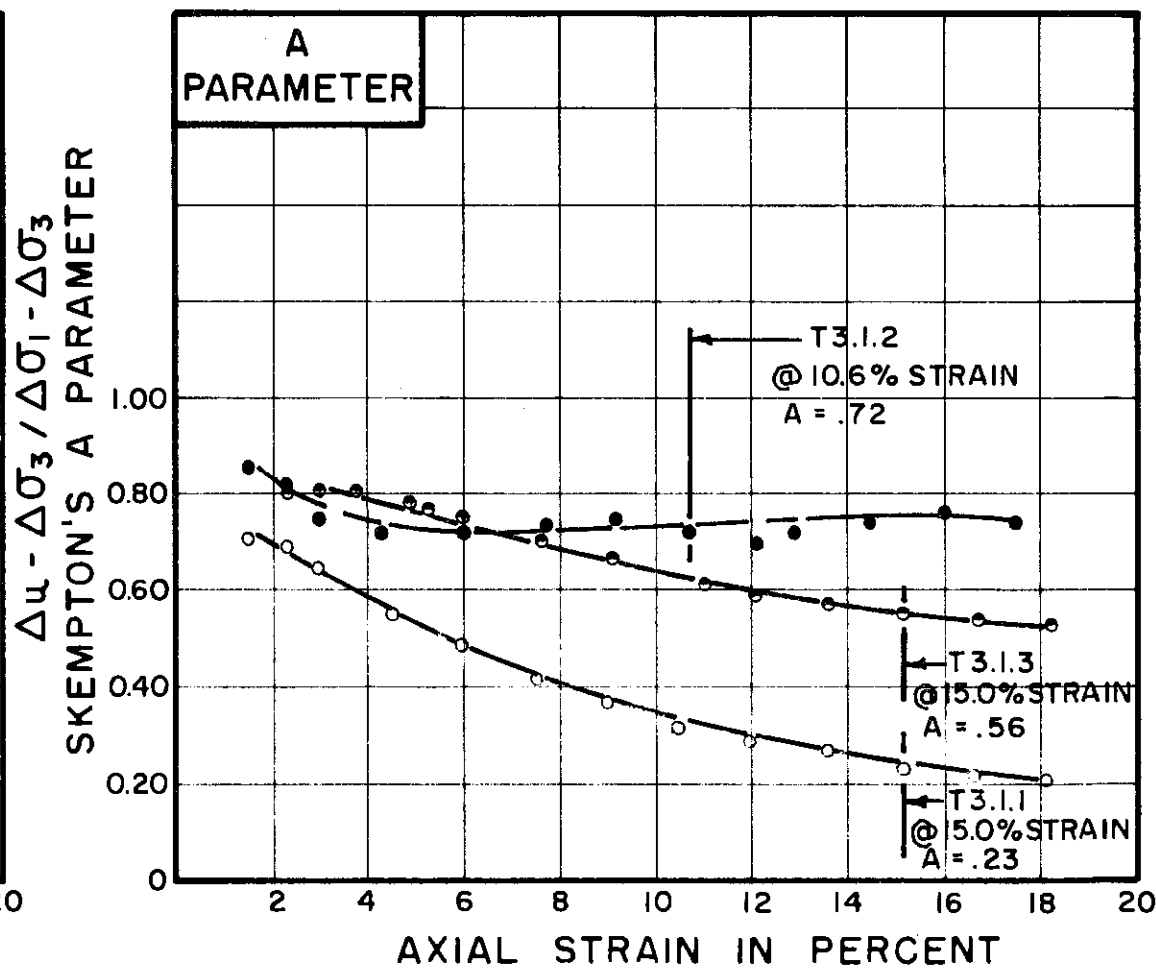
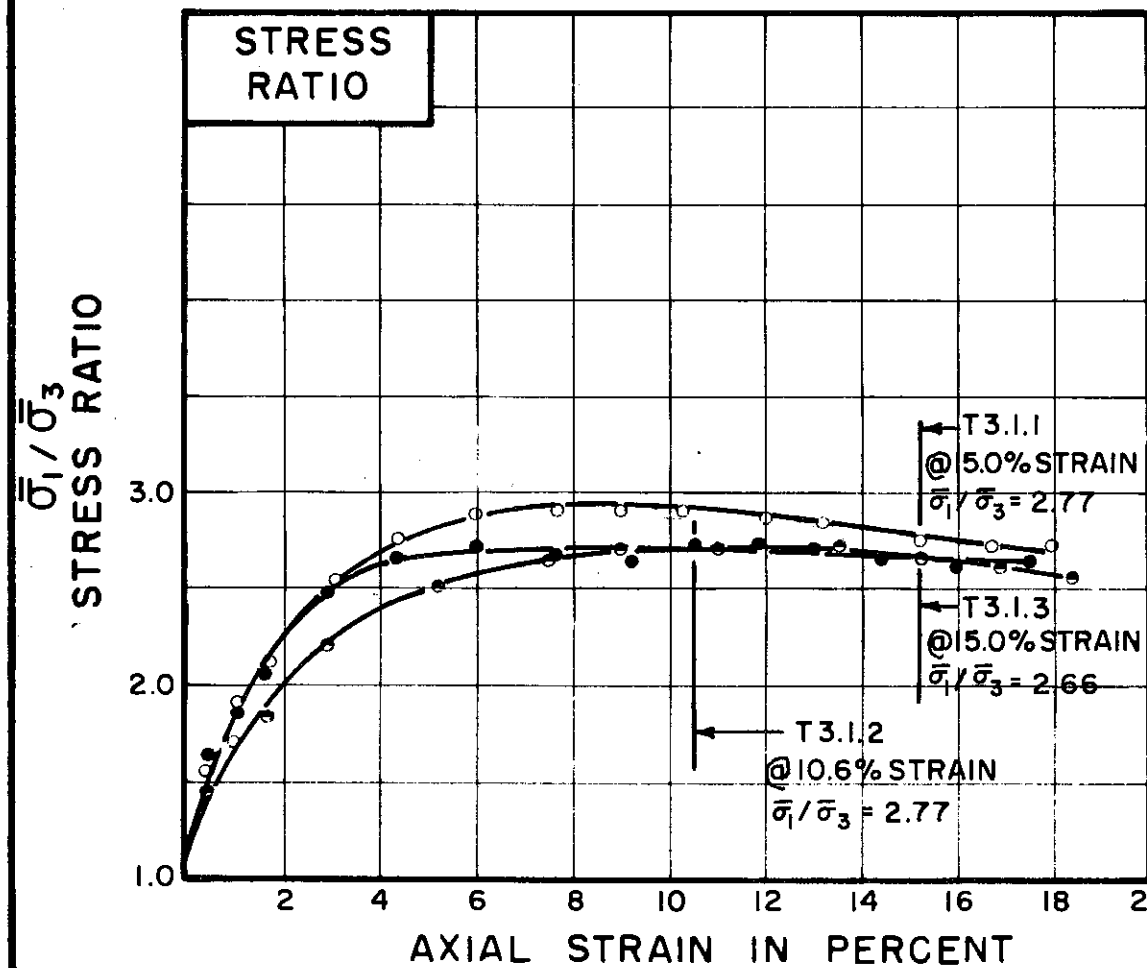
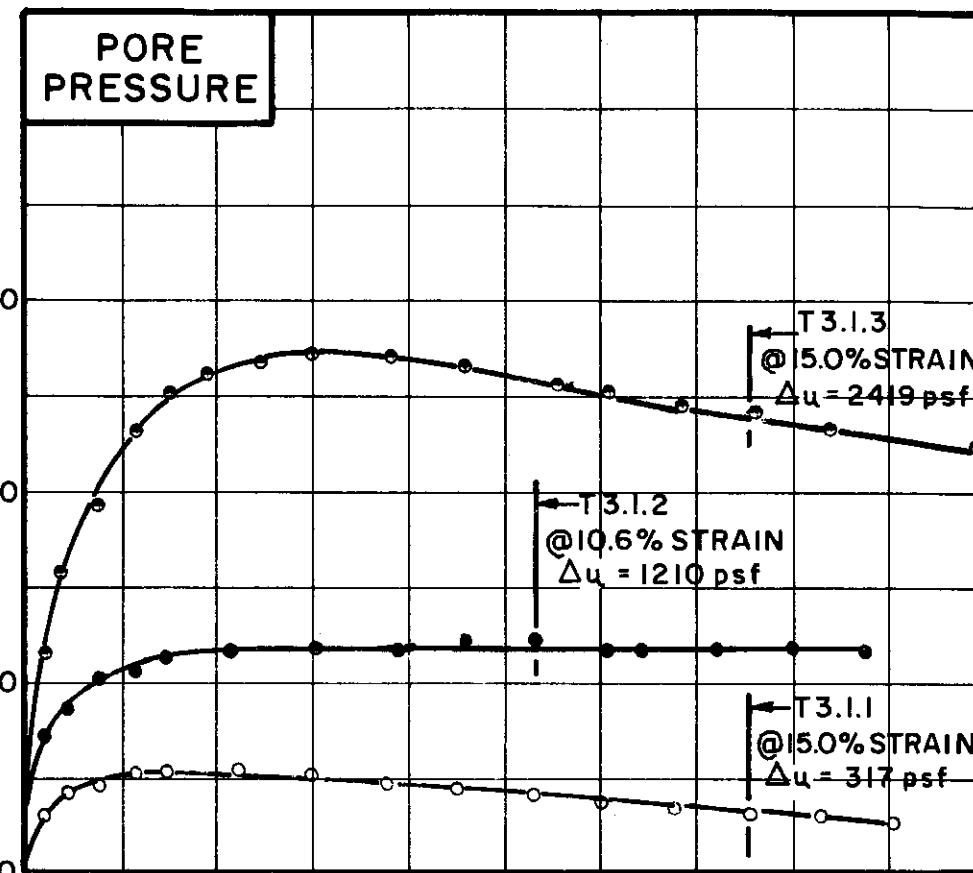
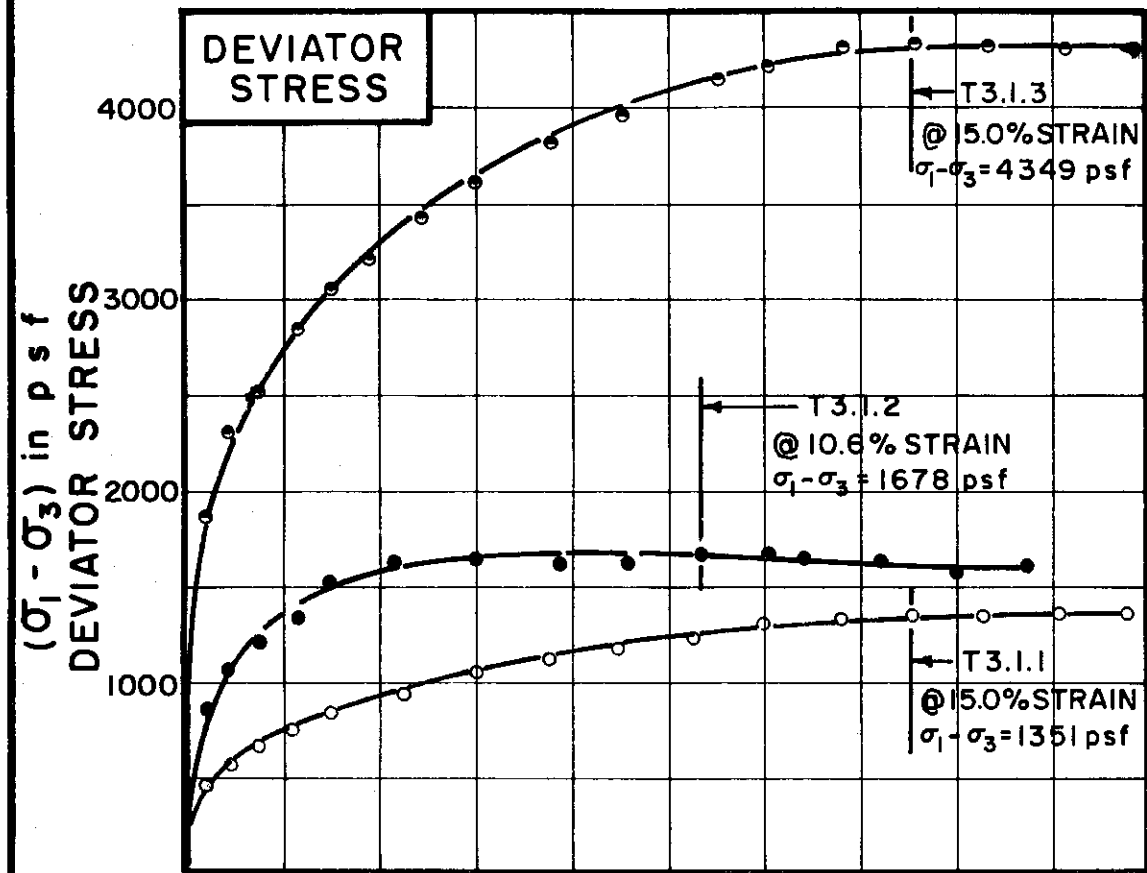

TEST NO. / SYMBOL	T3.1.1 ○	T3.1.2 ●	T3.1.3 ◉
-------------------	-------------	-------------	-------------

INITIAL CONDITIONS		WATER CONTENT	W ₀	35.4%	35.3%	35.7%	
DRY DENSITY		pcf	γ _d	89	86	86	
SAMPLE DIAMETER		in.	D ₀	1.40	1.40	1.41	
SAMPLE HEIGHT		in.	H ₀	3.36	3.35	3.35	
FINAL CONDITIONS BEFORE SHEAR		FINAL BACK PRESSURE	psf	u ₀	7200	7200	10800
INITIAL EFFECTIVE STRESS		psf	$\sigma_{1,0} / \sigma_{3,0}$	1080	2160	5040	
VOLUMETRIC STRAIN			ε _{vol}	5.3%	6.2%	8.7%	
PORE PRESSURE RESPONSE				100%	98%	95%	
FINAL CONDITIONS		WATER CONTENT	w _f	31.1%	30.8%	28.4%	
SKETCH OF SAMPLE AT END OF TEST							

RATE OF STRAIN PERCENT/MINUTE	.024	.024	.024
-------------------------------	------	------	------

BORING NO. 26

SAMPLE NO. 5

DEPTH 18.0 TO 20.0

SOIL DESCRIPTION SILTY CLAY (CL-CH)

LIQUID LIMIT _____ PLASTIC LIMIT _____

CONSOLIDATED UNDRAINED TRIAXIAL COMPRESSION TESTS

THE DETROIT EDISON COMPANY
BELLE RIVER PLANT UNITS I & II

FILE 1255

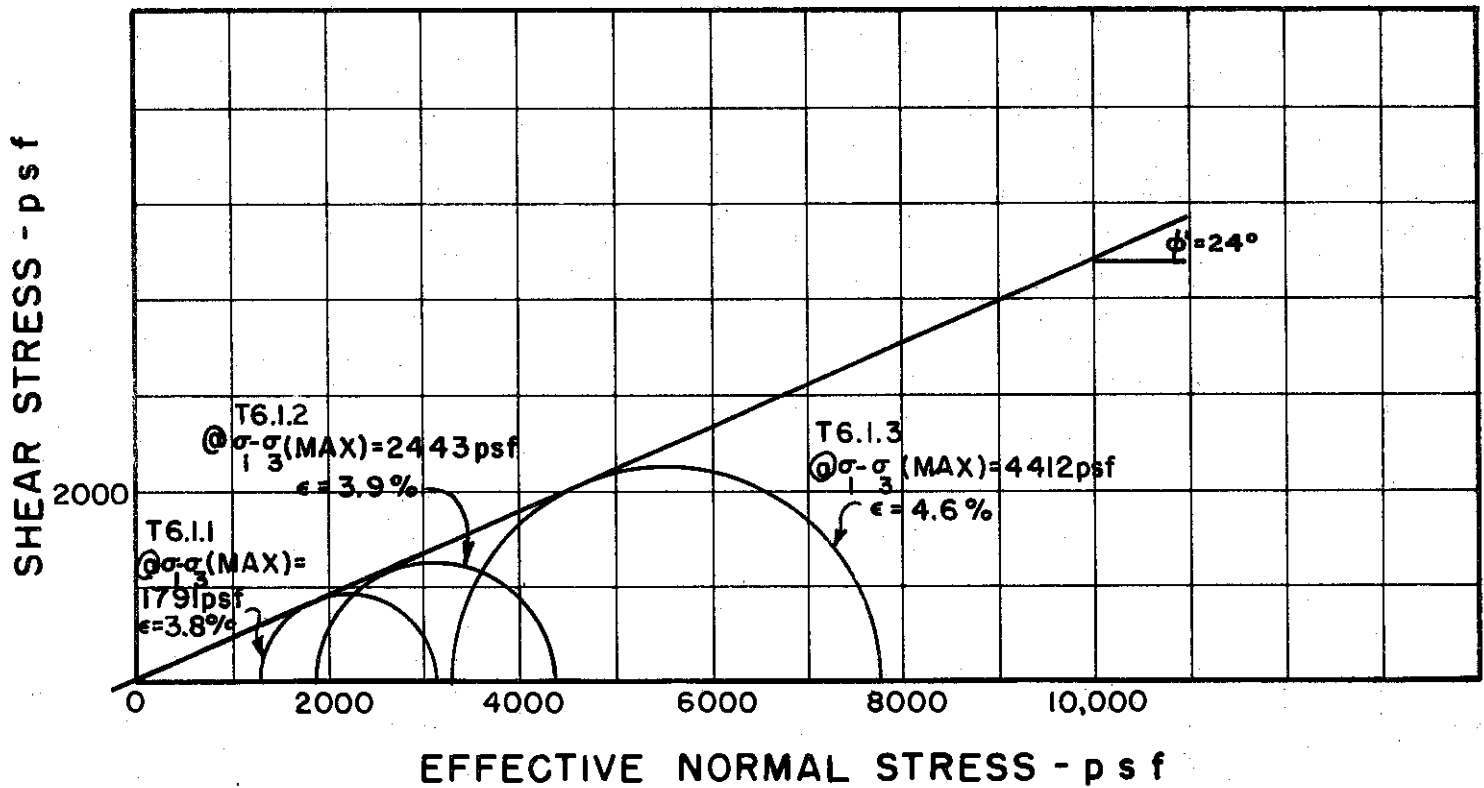
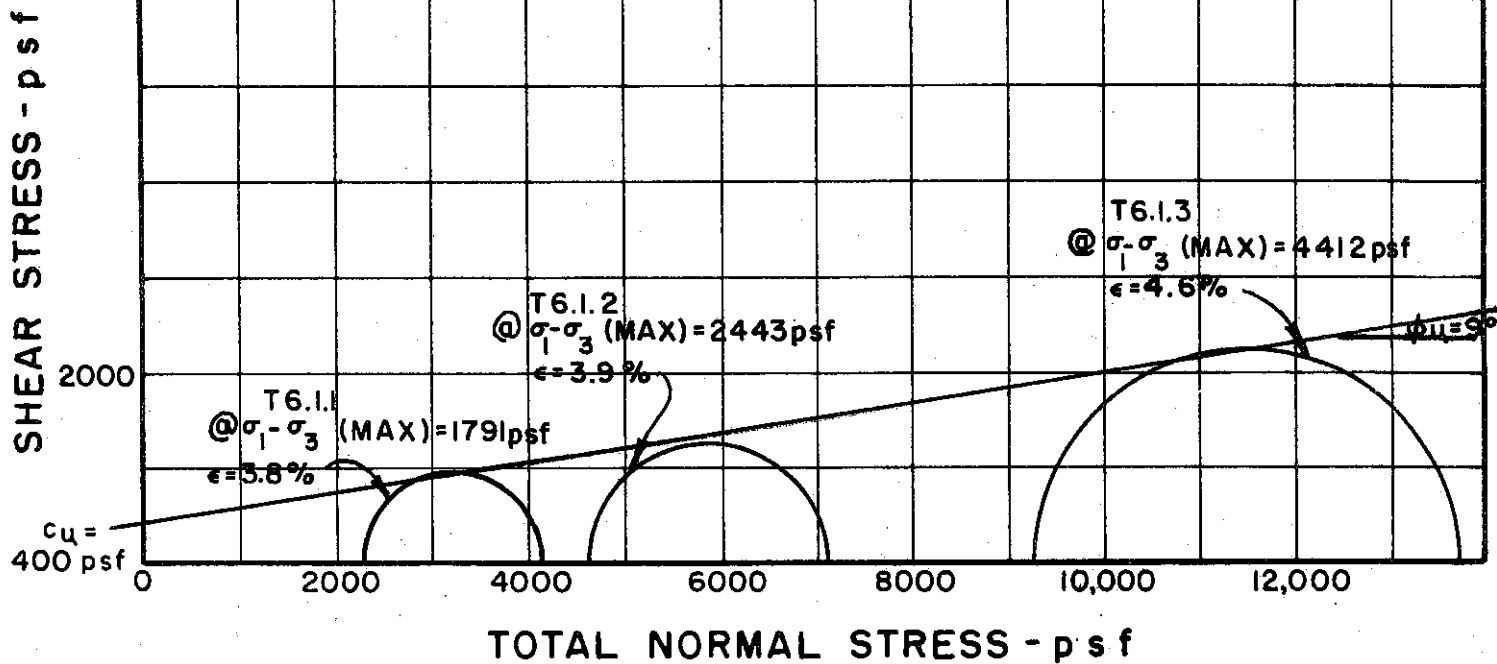

BORING NO. 26

SAMPLE NO. 11

DEPTH 48.0 TO 50.0

REMARKS ENVELOPE IS INTERPRETIVE,
BASED ON LIMITED DATA POINTS

AVAILABLE

GOLDBERG-ZOINO AND ASSOCIATES, INC.
CONSULTANTS IN GEOTECHNICAL ENGINEERING

MOHR STRENGTH ENVELOPE
TRIAXIAL COMPRESSION
TESTS

THE DETROIT EDISON COMPANY
BELLE RIVER PLANT UNITS I & II
FILE 1255

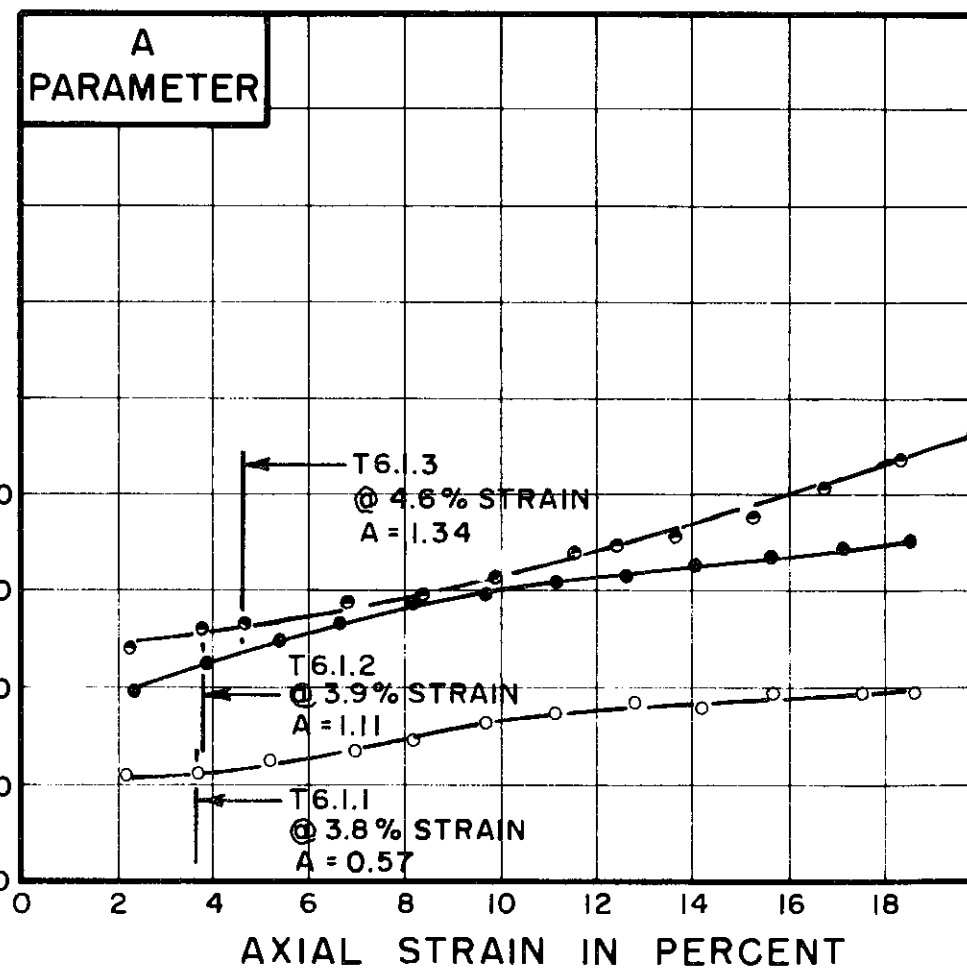
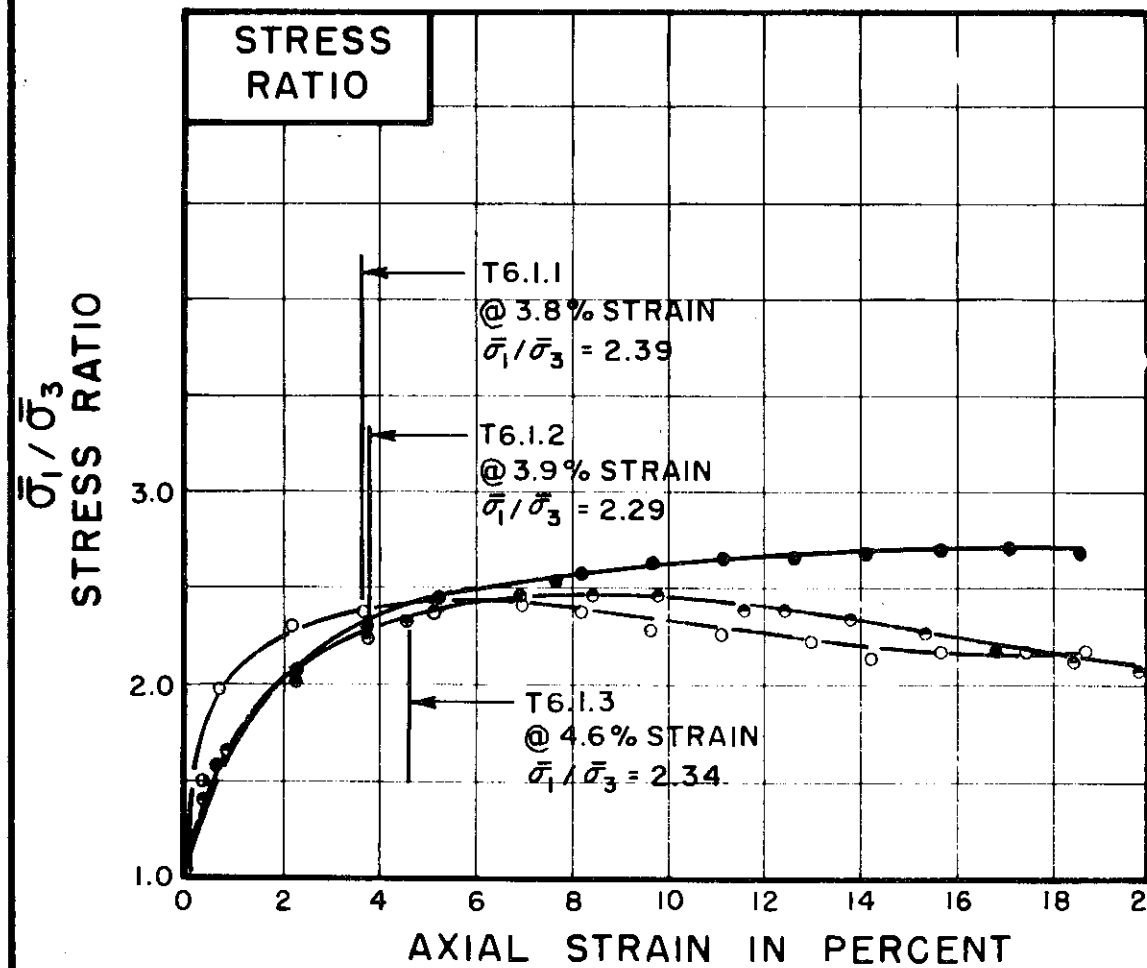
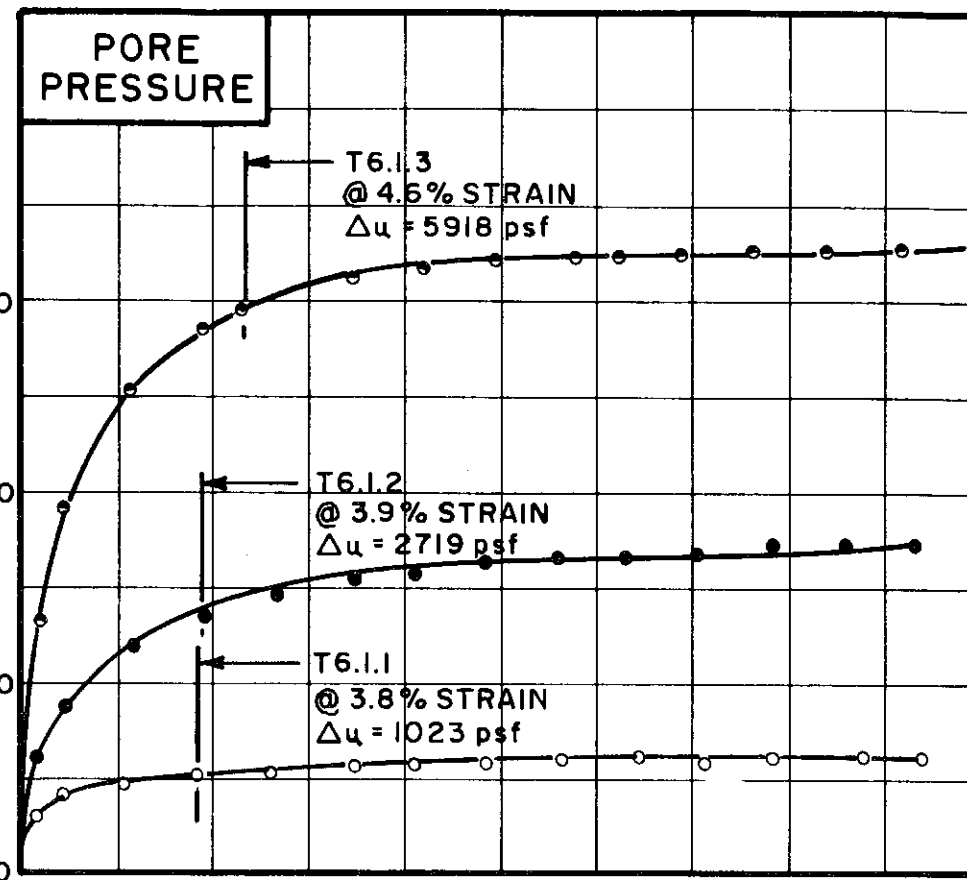
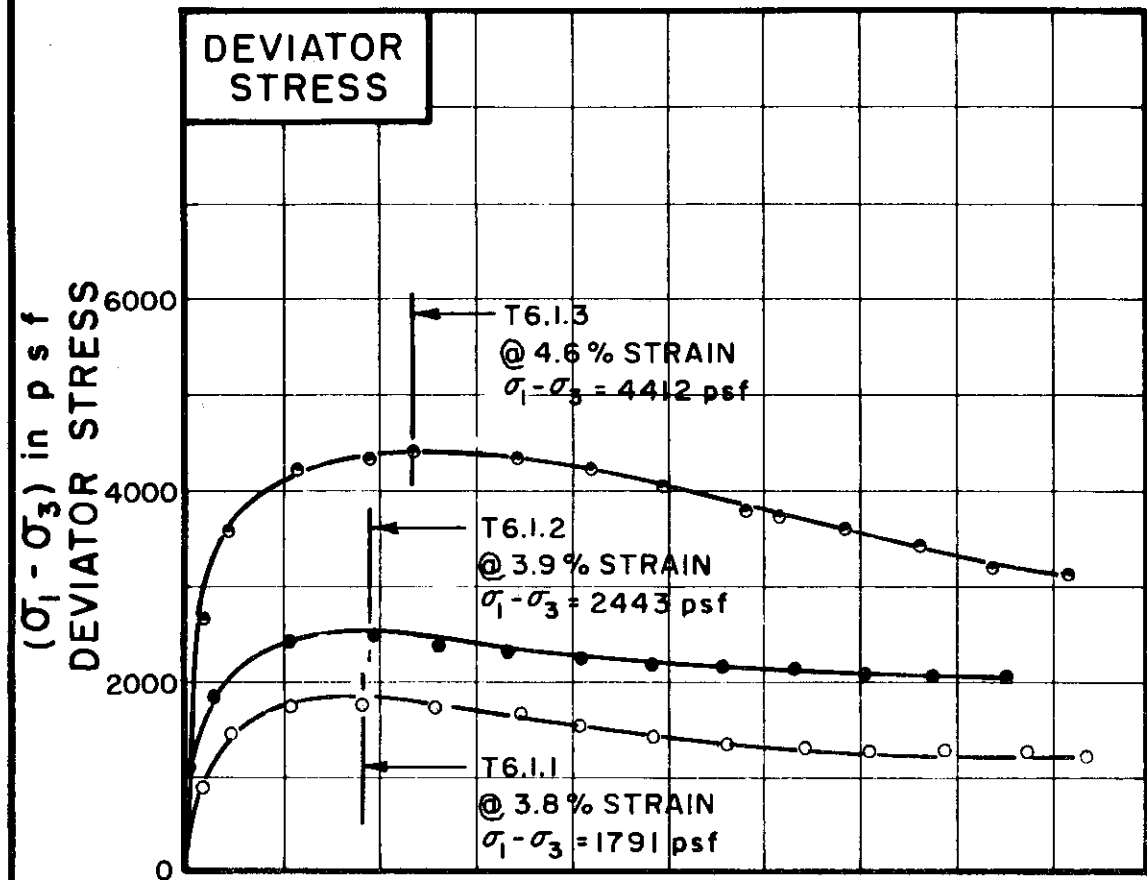

TEST NO. / SYMBOL	T6.1.1	T6.1.2	T6.1.3
	○	●	○

INITIAL CONDITIONS	WATER CONTENT	w_0	36.1%	36.5%	30.0%
	DRY DENSITY	γ_d	88	86	93
	SAMPLE DIAMETER	D_0	1.40	1.40	1.40
	SAMPLE HEIGHT	H_0	3.35	3.40	3.36
CONDITIONS BEFORE SHEAR	FINAL BACK PRESSURE	u_0	5760	7200	7200
	INITIAL EFFECTIVE STRESS	$\sigma'_{1/3}$	2304	4608	9216
	VOLUMETRIC STRAIN	ϵ_{vol}	2.0%	4.8%	8.5%
PORE PRESSURE RESPONSE			99%	95%	100%
FINAL CONDITIONS	WATER CONTENT	w_f	34.3%	32.9%	23.8%
	SKETCH OF SAMPLE AT END OF TEST				

RATE OF STRAIN PERCENT / MINUTE	.024	.024	.025
---------------------------------	------	------	------

BORING NO. 26
 SAMPLE NO. 11
 DEPTH 48.0 TO 50.0
 SOIL DESCRIPTION SILTY CLAY (CL)
 LIQUID LIMIT 41 PLASTIC LIMIT 21

CONSOLIDATED UNDRAINED
 TRIAXIAL COMPRESSION
 TESTS
 THE DETROIT EDISON COMPANY
 BELLE RIVER PLANT UNITS I & II

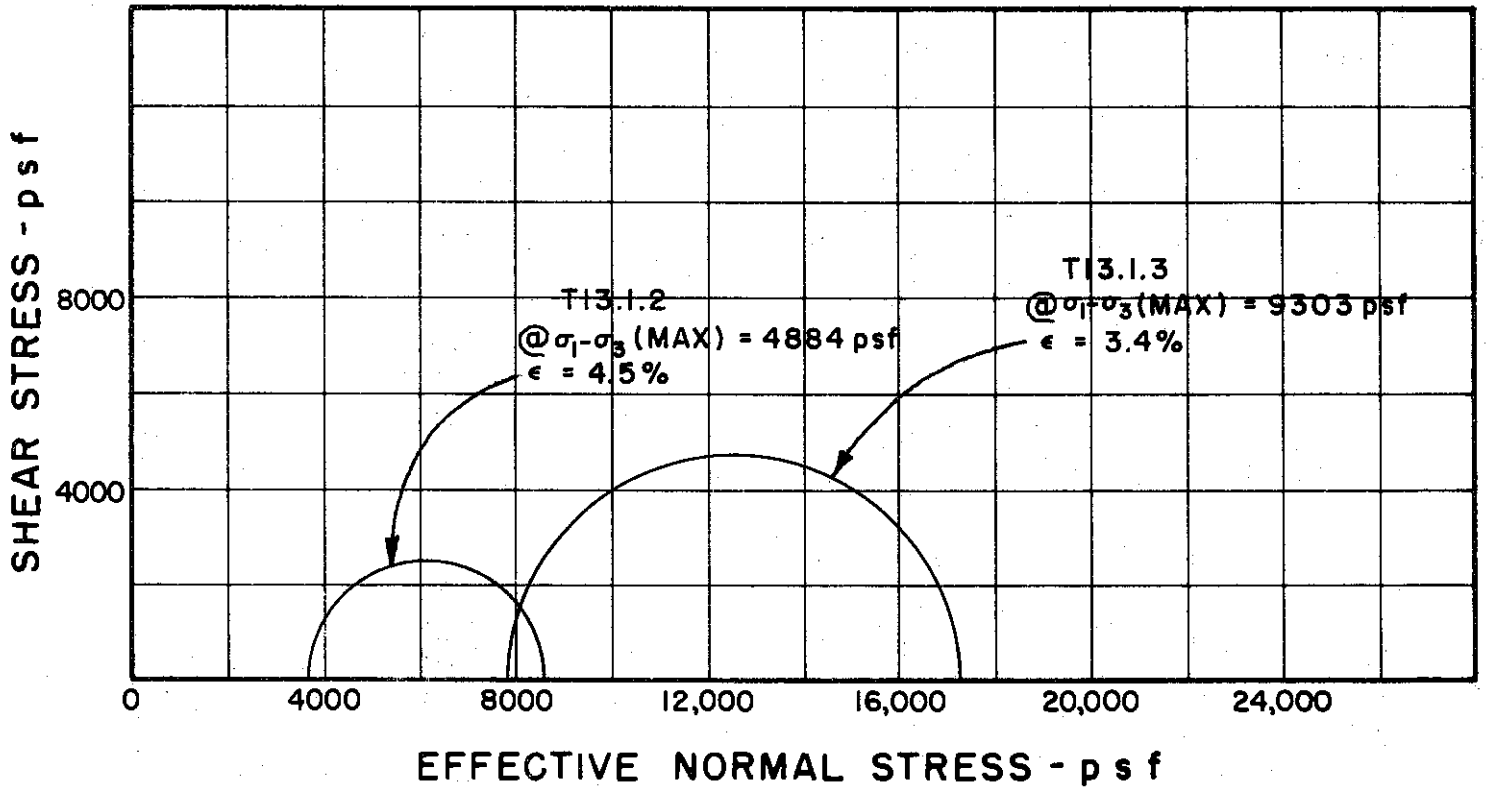
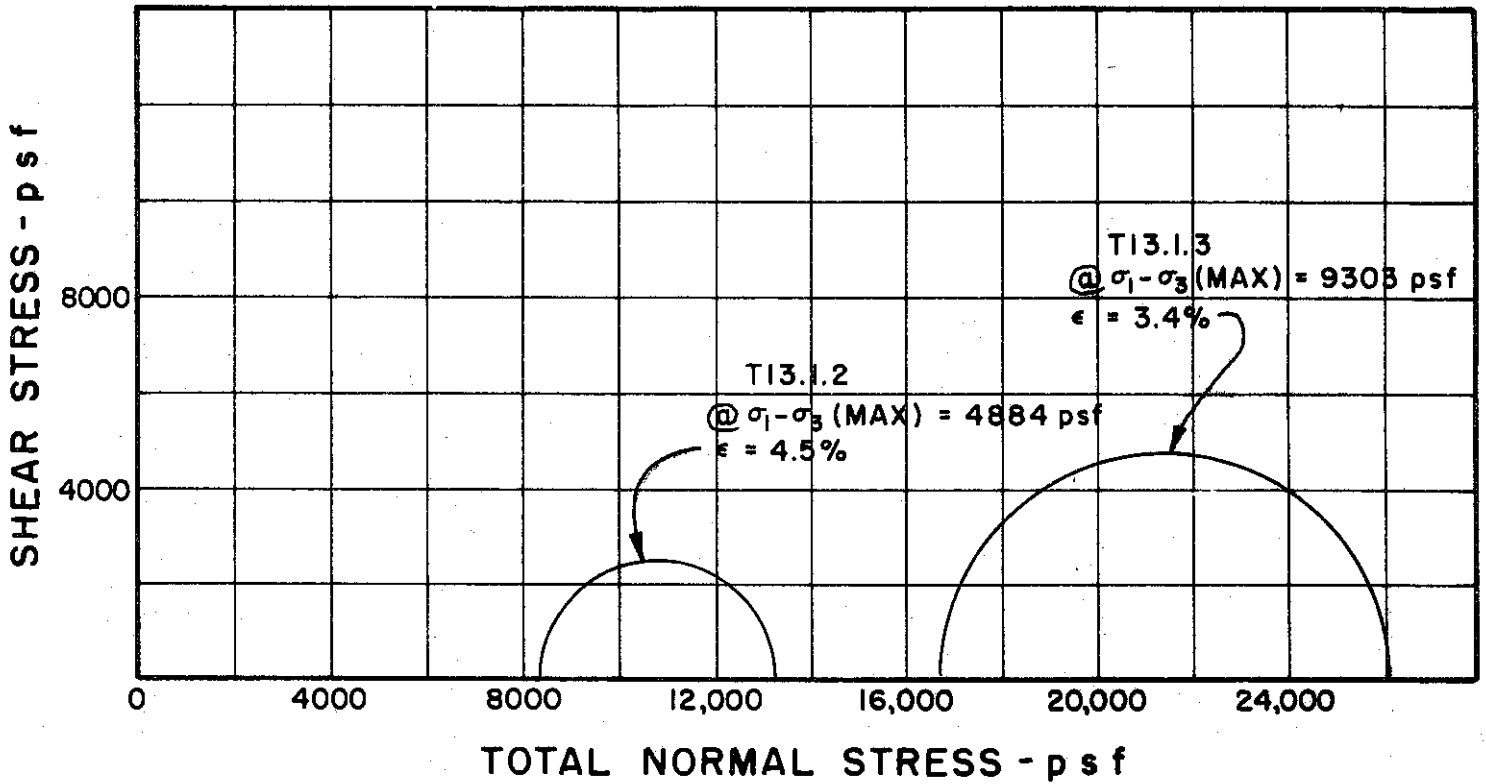

BORING NO. 26

SAMPLE NO. 28

DEPTH 128.0' TO 130.0'

REMARKS SOILS WITHIN THIS
SAMPLE ARE VARIABLE - SEE TEST
RESULTS FOR T13.1.1

GOLDBERG-ZOINO AND ASSOCIATES, INC.
 CONSULTANTS IN GEOTECHNICAL ENGINEERING

MOHR STRENGTH ENVELOPE
 TRIAXIAL COMPRESSION
 TESTS

THE DETROIT EDISON COMPANY
 BELLE RIVER PLANT UNITS I & II

FILE 1255

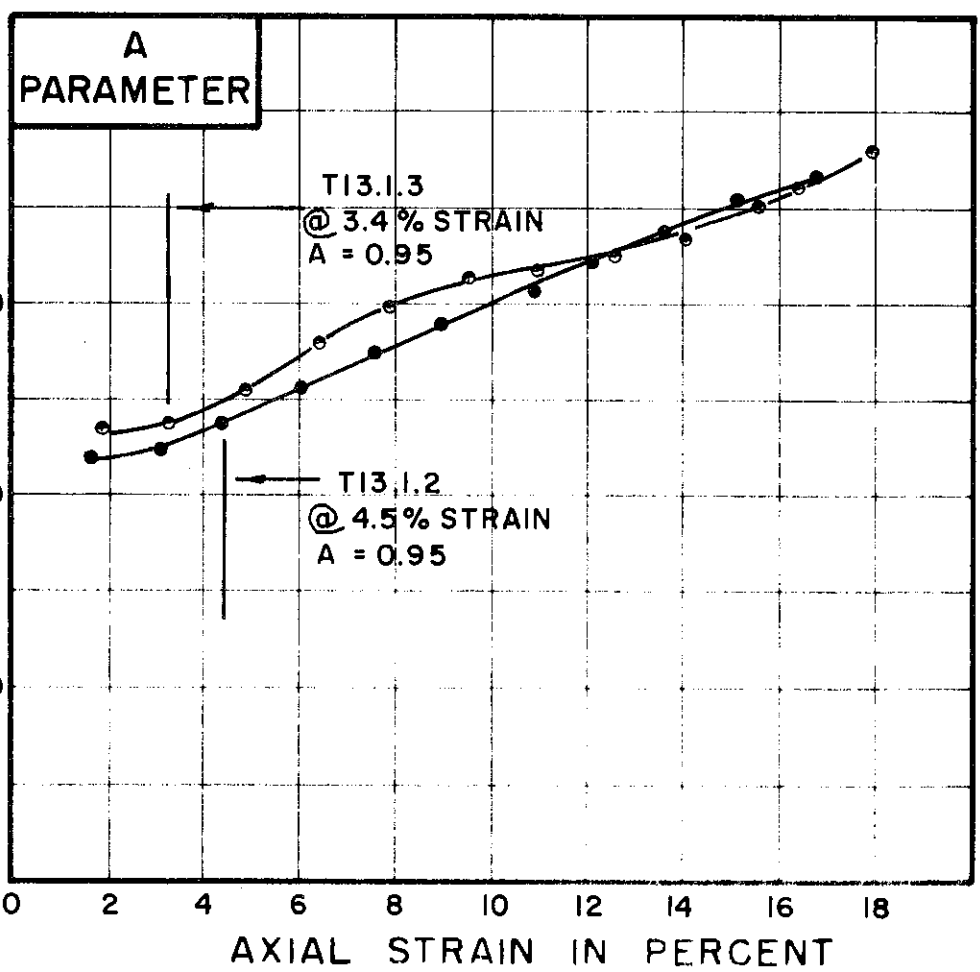
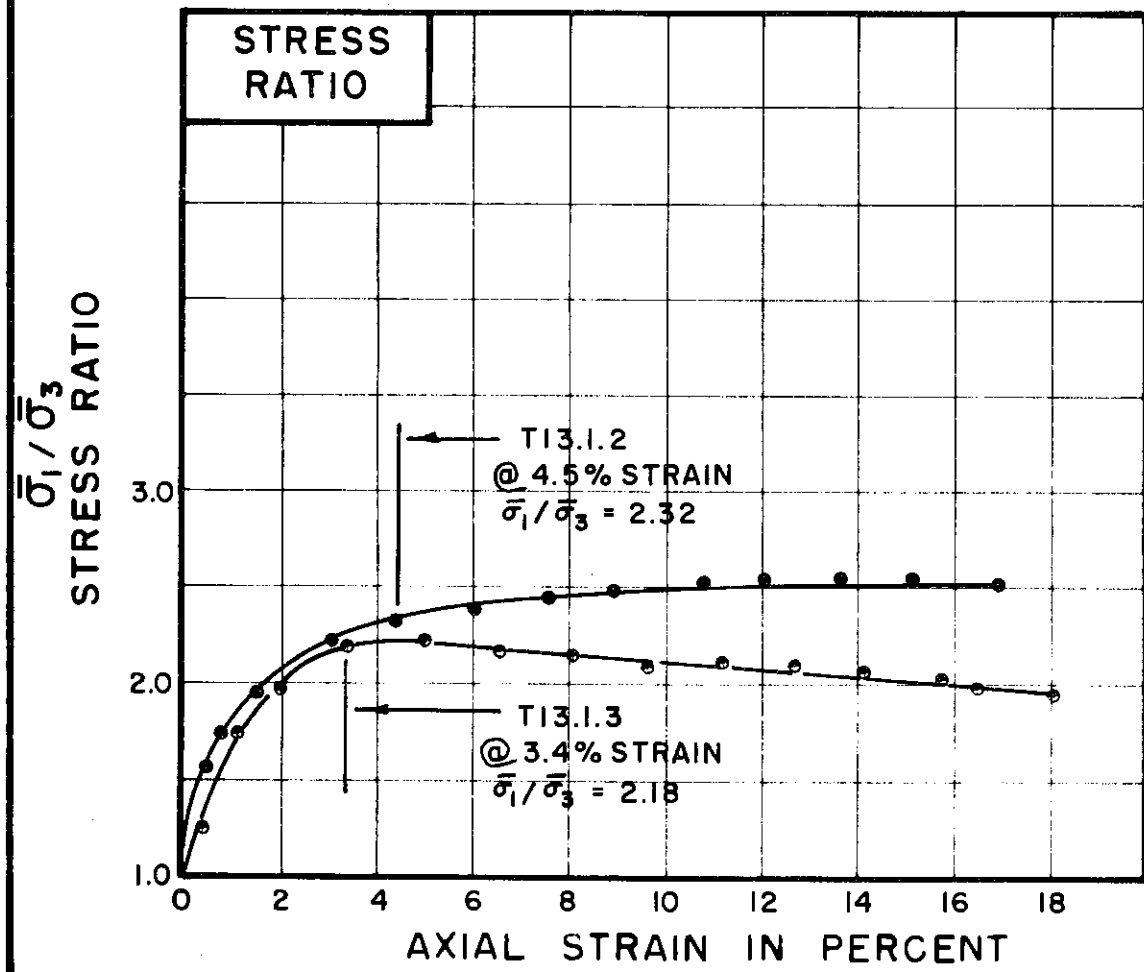
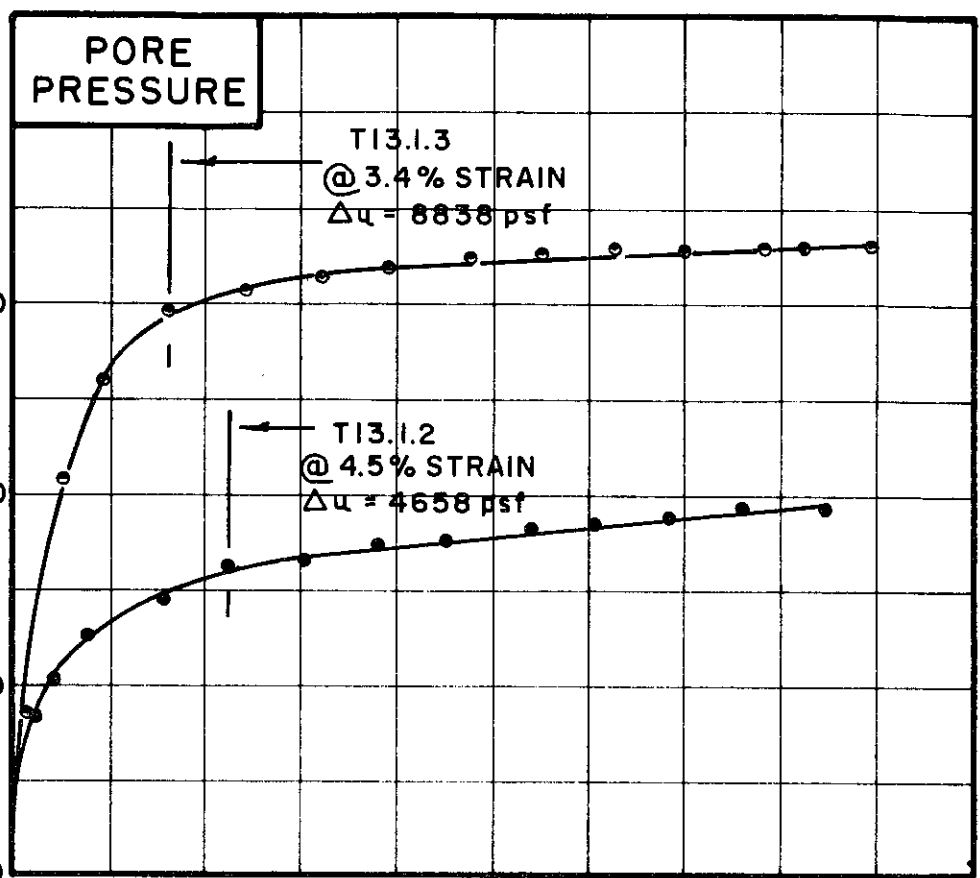
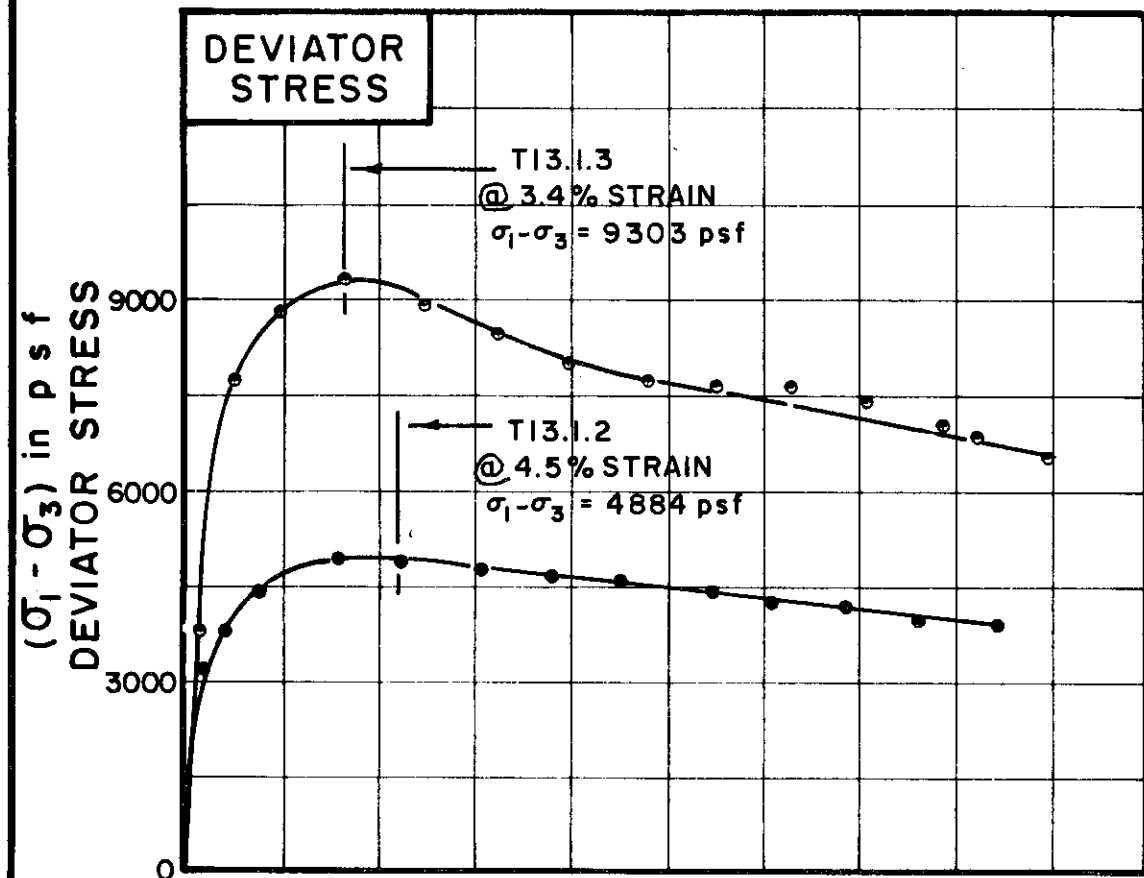

TEST NO. / SYMBOL	T13.1.2	T13.1.3
-------------------	---------	---------

INITIAL CONDITIONS			T13.1.2	T13.1.3	
WATER CONTENT	w_0		35.6%	34.0%	%
DRY DENSITY	γ_d	lb/cu ft	86	90	
SAMPLE DIAMETER	D_0	in.	1.40	1.40	
SAMPLE HEIGHT	H_0	in.	3.35	3.38	
FINAL CONDITIONS BEFORE SHEAR			T13.1.2	T13.1.3	
FINAL BACK PRESSURE	u_0	psf	6480	8640	
INITIAL EFFECTIVE STRESS	$\bar{\sigma}_1, \bar{\sigma}_3$	psf	8352	16704	
VOLUMETRIC STRAIN	ϵ_{vol}		60.9%	10.9%	%
PORE PRESSURE RESPONSE			98%	98%	
FINAL CONDITIONS			T13.1.2	T13.1.3	
WATER CONTENT	w_f		31.4%	27.6%	%
SKETCH OF SAMPLE AT END OF TEST					

RATE OF STRAIN PERCENT/MINUTE	.024	.025
-------------------------------	------	------

BORING NO. 26
 SAMPLE NO. 28
 DEPTH 128.0' TO 130.0'
 SOIL DESCRIPTION SILTY CLAY (CL)

LIQUID LIMIT 39 PLASTIC LIMIT 21
 NOTE: SOILS WITHIN THIS SAMPLE ARE VARIABLE - SEE TEST RESULTS FOR T13.1.1

CONSOLIDATED UNDRAINED TRIAXIAL COMPRESSION TESTS
 THE DETROIT EDISON COMPANY
 BELLE RIVER PLANT UNITS I & II

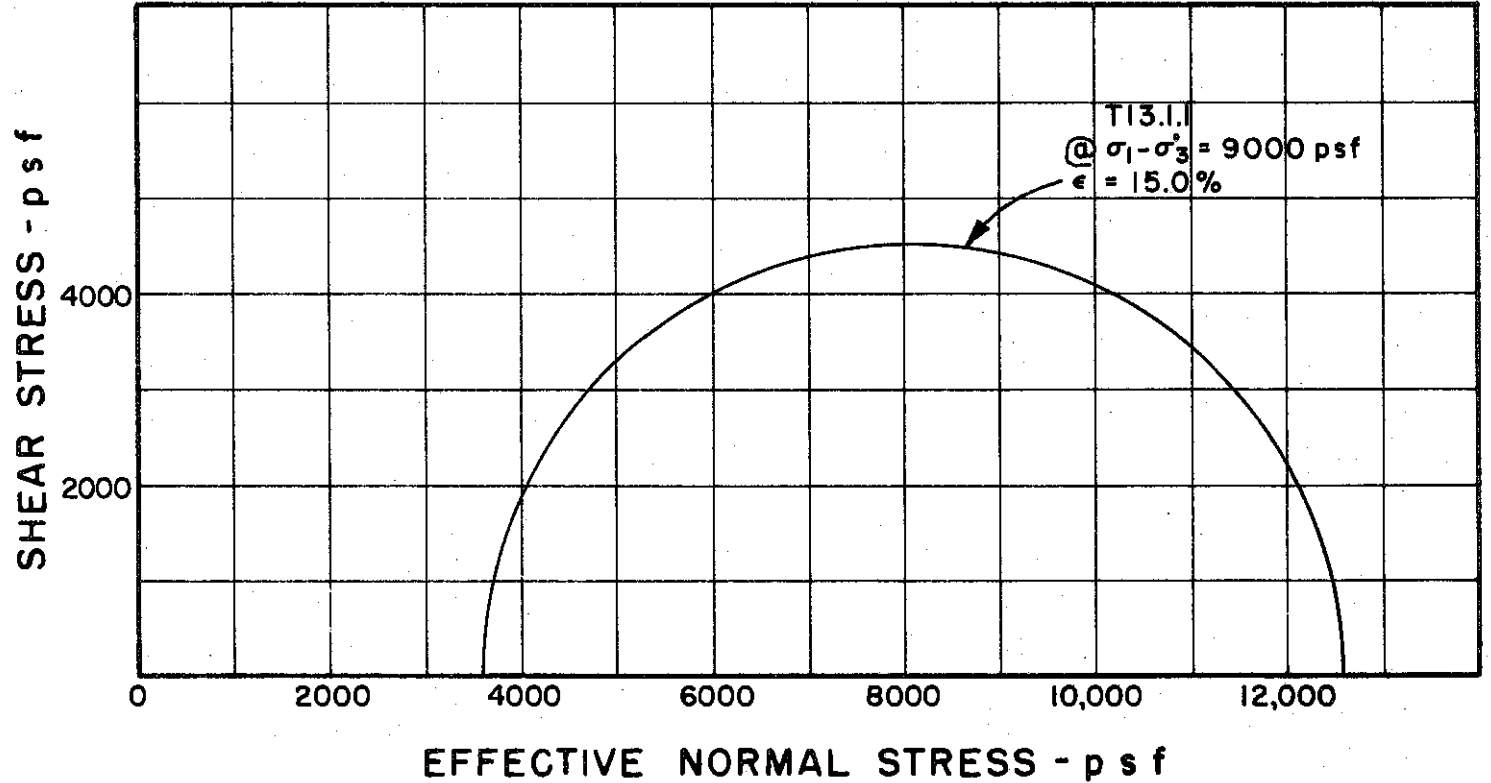
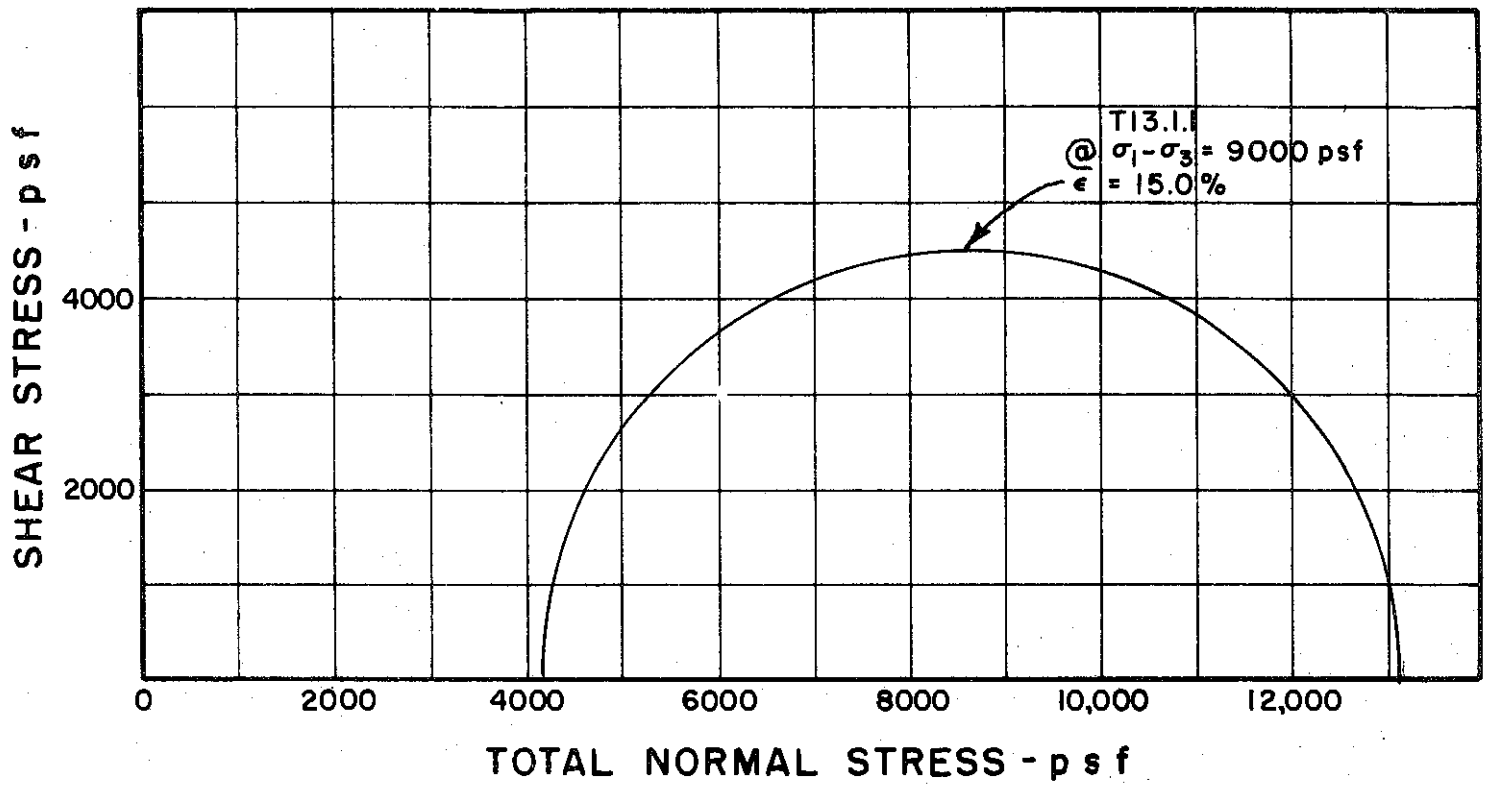

BORING NO. 26
 SAMPLE NO. 28
 DEPTH 128.0' TO 130.0'

MOHR STRENGTH ENVELOPE
 TRIAXIAL COMPRESSION
 TESTS

REMARKS SOILS WITHIN THIS
SAMPLE ARE VARIABLE - SEE TEST
RESULTS FOR T13.1.2 & T13.1.3
 GOLDBERG-ZOINO AND ASSOCIATES, INC.
 CONSULTANTS IN GEOTECHNICAL ENGINEERING

THE DETROIT EDISON COMPANY
 BELLE RIVER PLANT UNITS I & II
 FILE 1255
 C-395

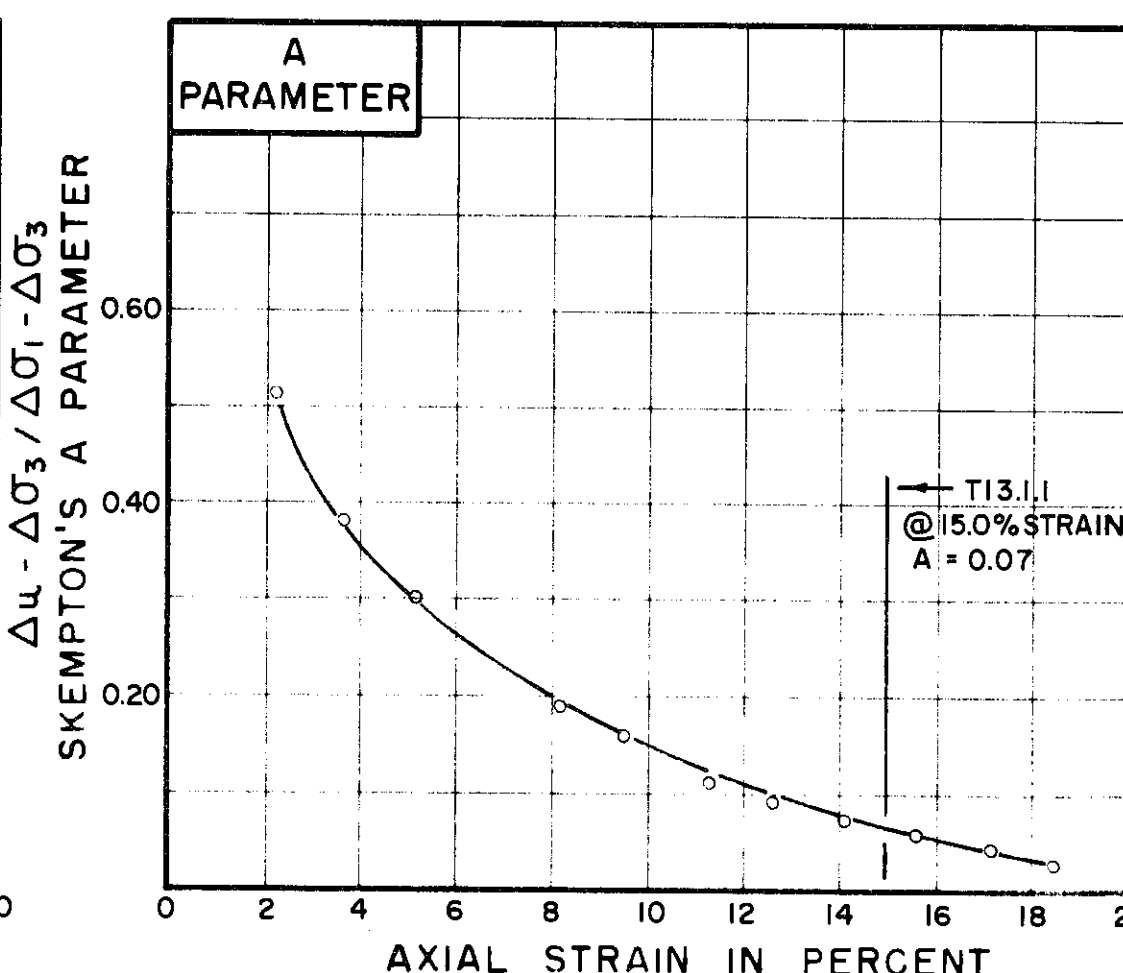
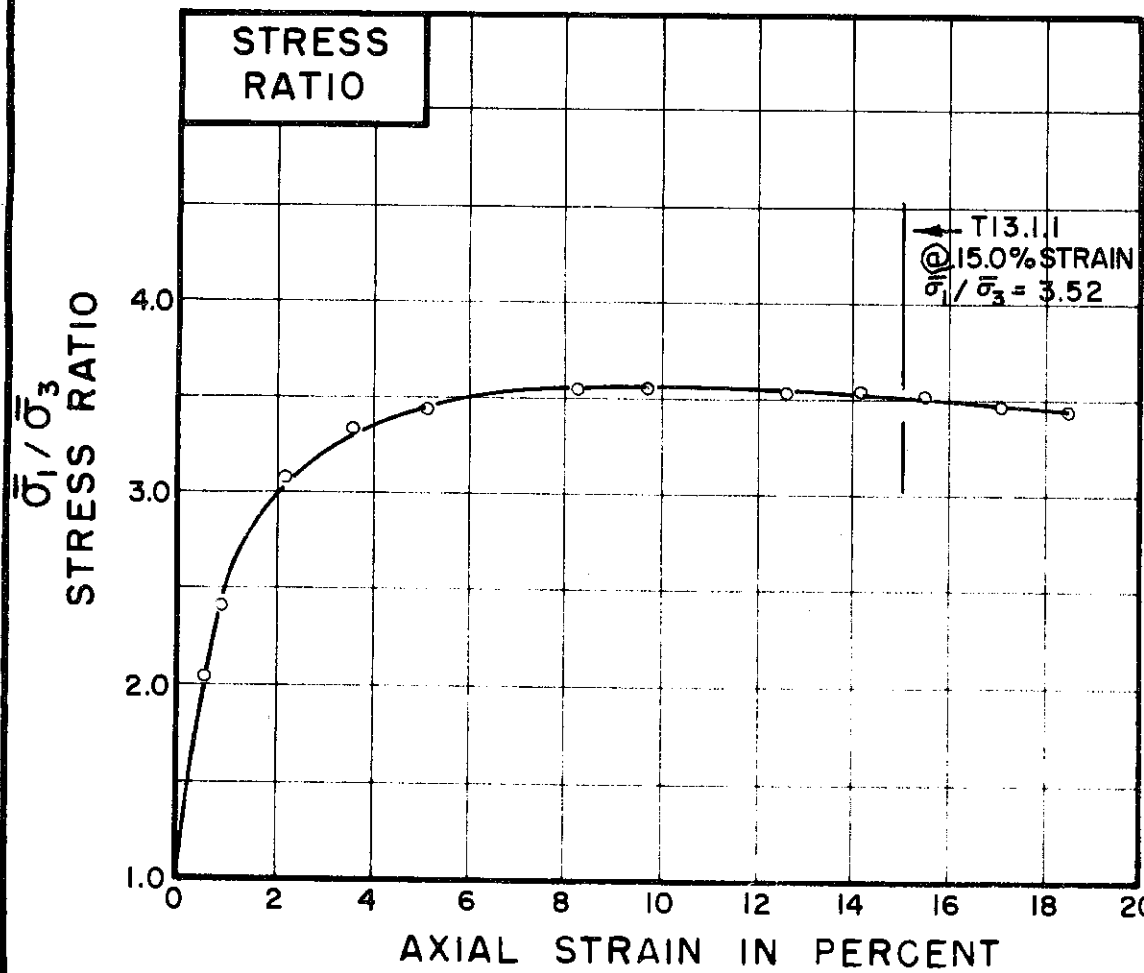
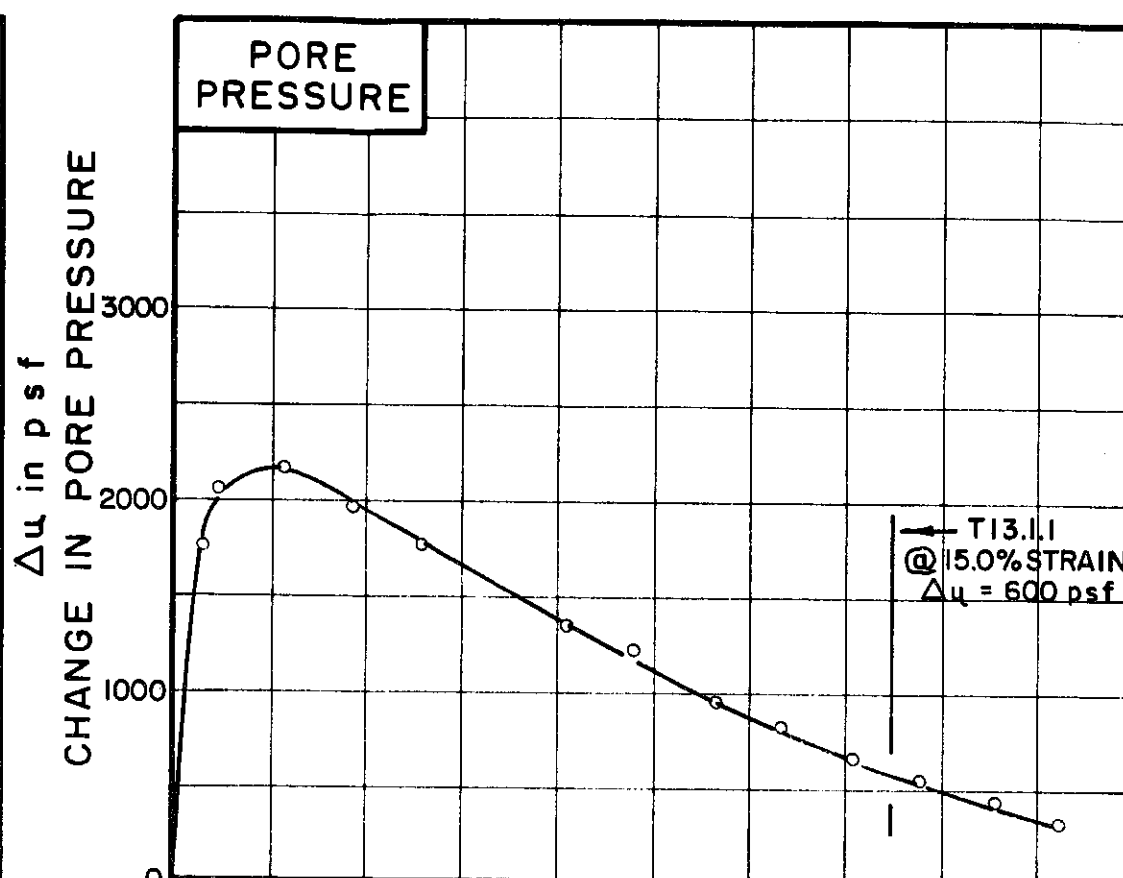
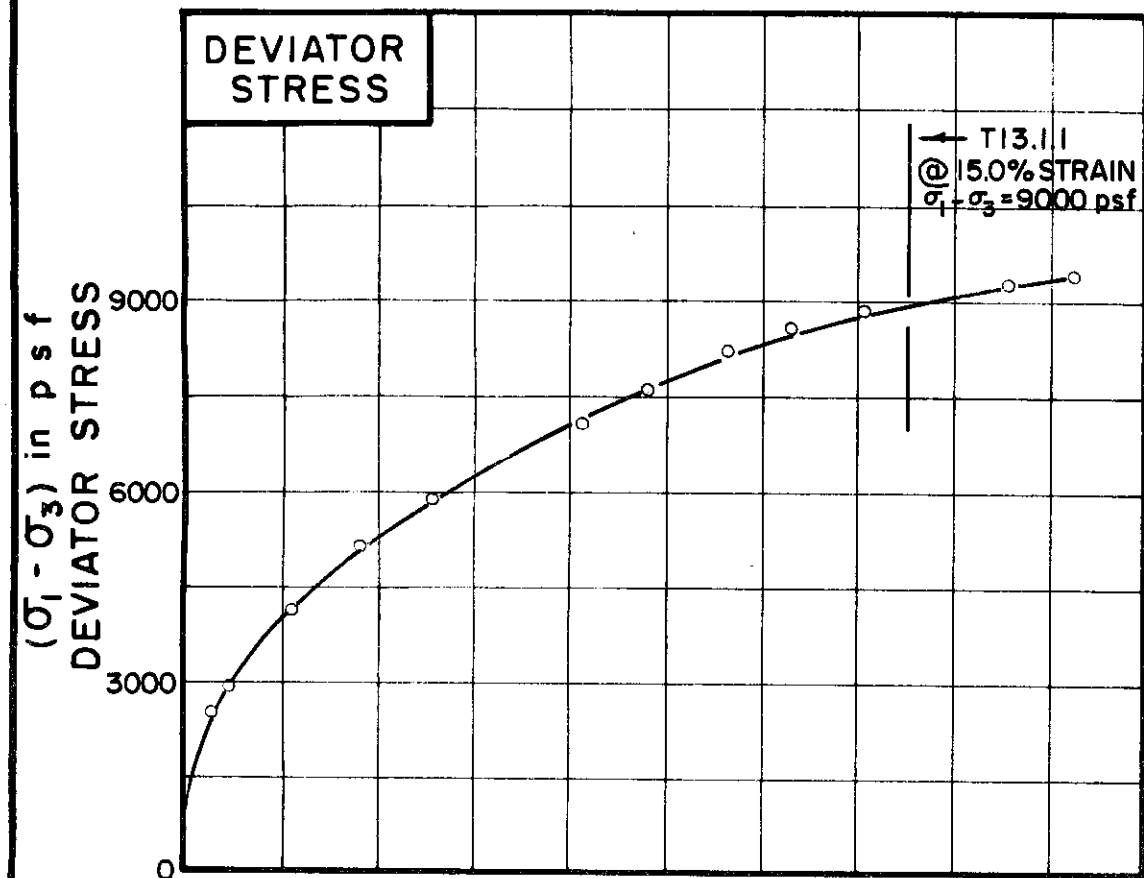

TEST NO. / SYMBOL T13.1.1

INITIAL CONDITIONS	WATER CONTENT	w _o	22.9%	%	%
	DRY DENSITY	γ _d	96		
	SAMPLE DIAMETER	D _o	1.40		
	SAMPLE HEIGHT	H _o	3.38		
FINAL CONDITIONS BEFORE SHEAR	FINAL BACK PRESSURE	u _o	6480		
	INITIAL EFFECTIVE STRESS	σ ₁ / σ ₃	4176		
	VOLUMETRIC STRAIN	ε _{vol}	1.77%	%	%
	PORE PRESSURE RESPONSE		96%		
FINAL CONDITIONS	WATER CONTENT	w _f	22.9%	%	%
	SKETCH OF SAMPLE AT END OF TEST				

RATE OF STRAIN PERCENT/MINUTE .024

BORING NO. 26

SAMPLE NO. 28

DEPTH 128.0' TO 130.0'

SOIL DESCRIPTION SILTY CLAY WITH LAYERS OF FINE SAND & SILT

LIQUID LIMIT — PLASTIC LIMIT —

NOTE: SOILS WITHIN THIS SAMPLE ARE VARIABLE - SEE TEST RESULTS FOR T13.1.2 & T13.1.3

CONSOLIDATED UNDRAINED TRIAXIAL COMPRESSION TESTS
THE DETROIT EDISON COMPANY
BELLE RIVER PLANT UNITS I & II

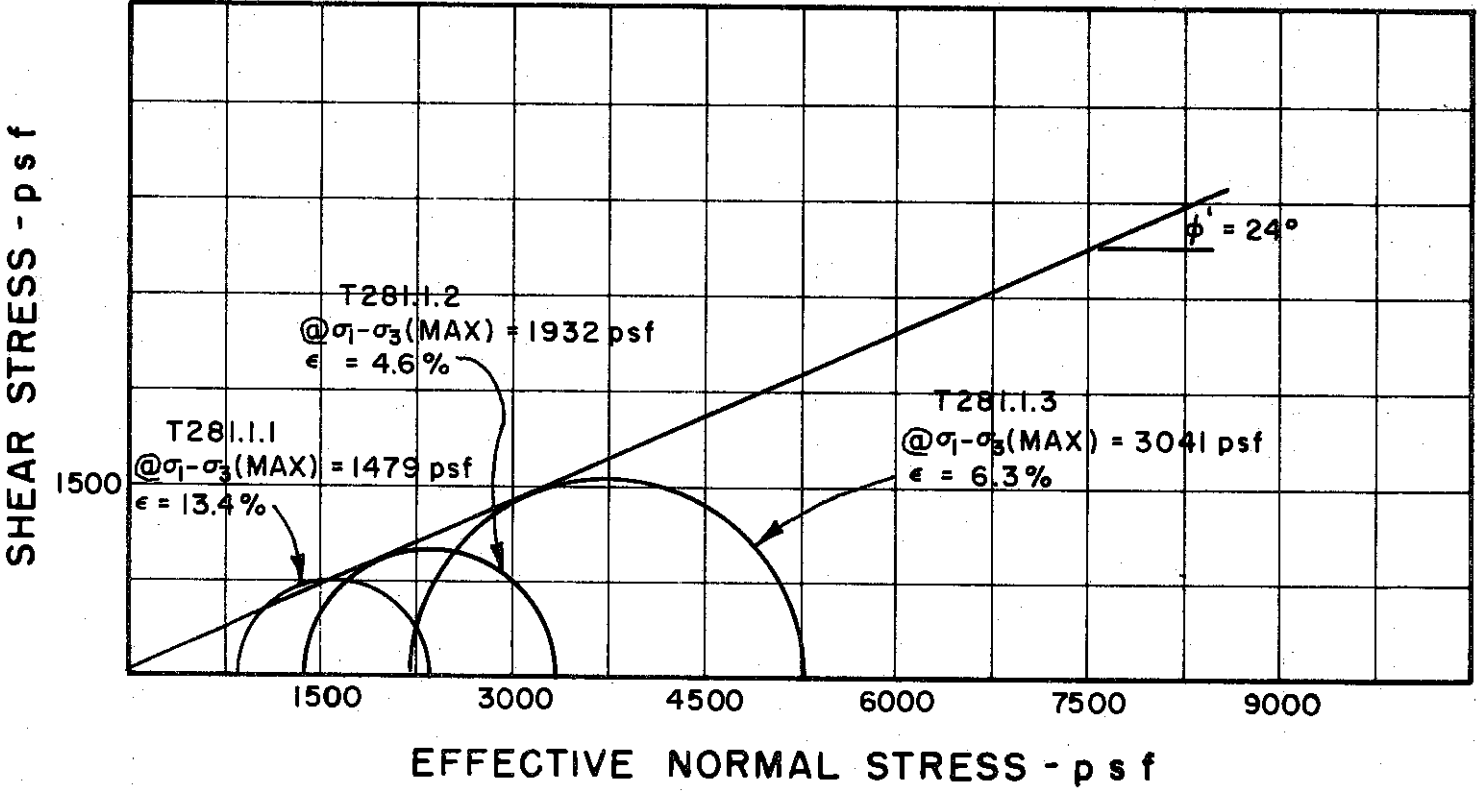
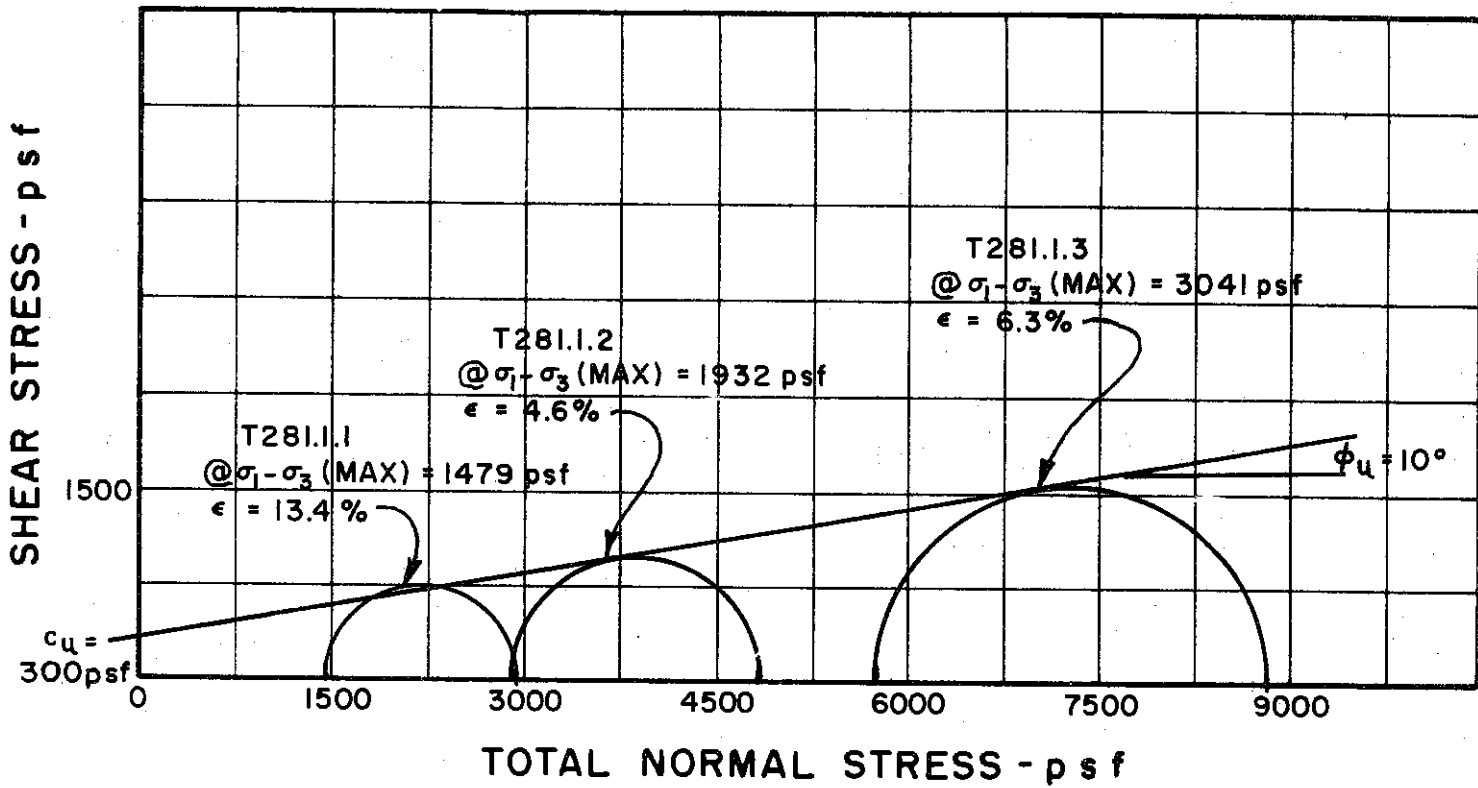

BORING NO. 33

SAMPLE NO. 7

DEPTH 28.0' TO 30.5'

REMARKS ENVELOPE IS INTERPRETIVE,
BASED ON LIMITED DATA POINTS
AVAILABLE

GOLDBERG-ZOINO AND ASSOCIATES, INC.
 CONSULTANTS IN GEOTECHNICAL ENGINEERING

MOHR STRENGTH ENVELOPE
 TRIAXIAL COMPRESSION
 TESTS

THE DETROIT EDISON COMPANY
 BELLE RIVER PLANT UNITS I & II

FILE 1255

C-397

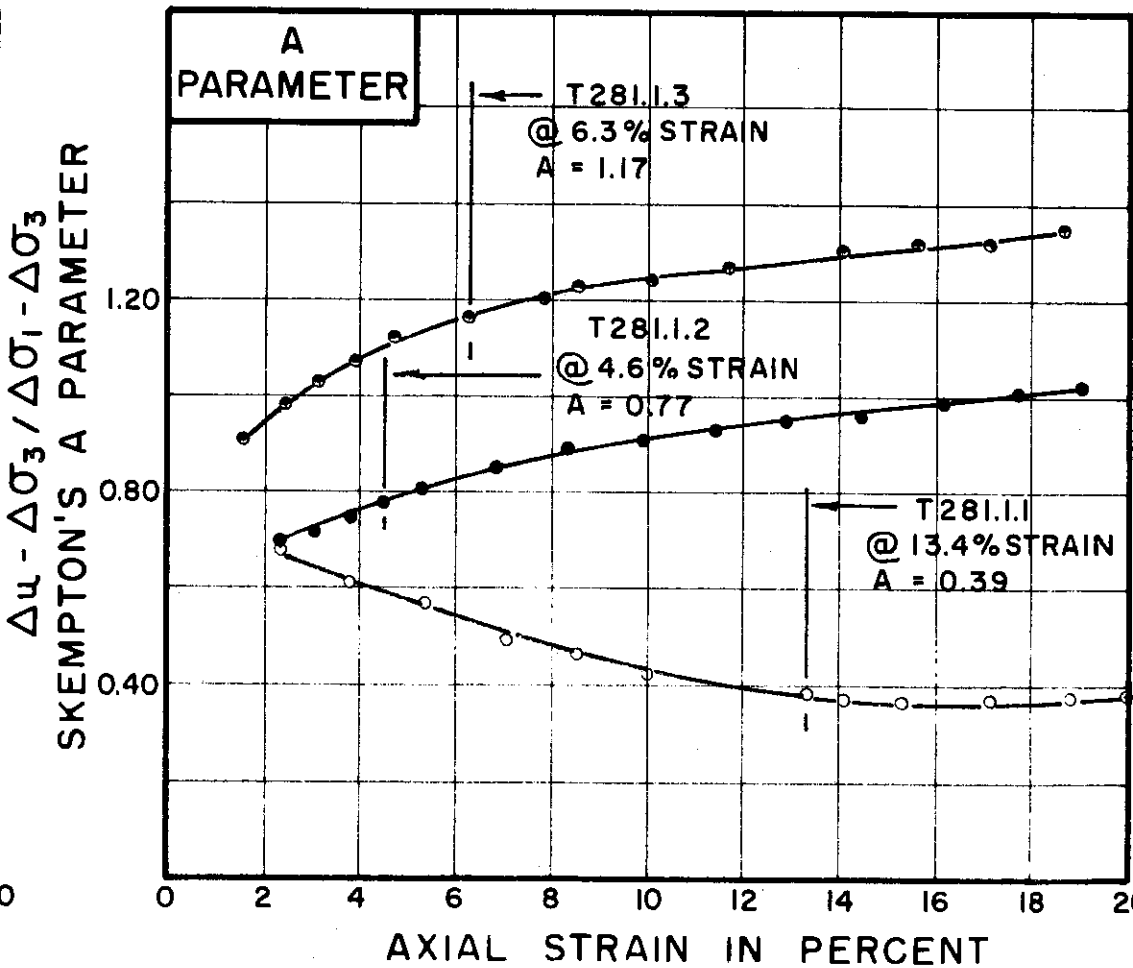
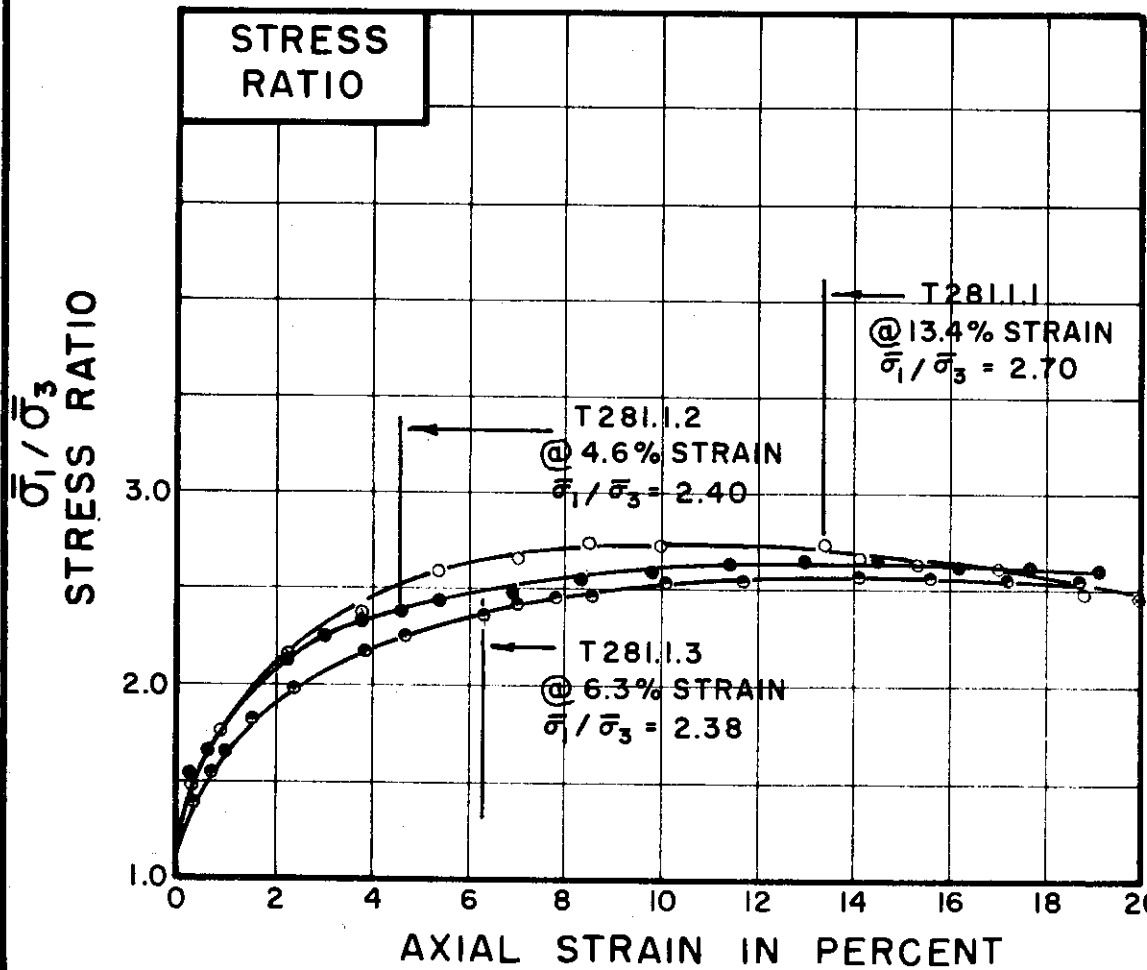
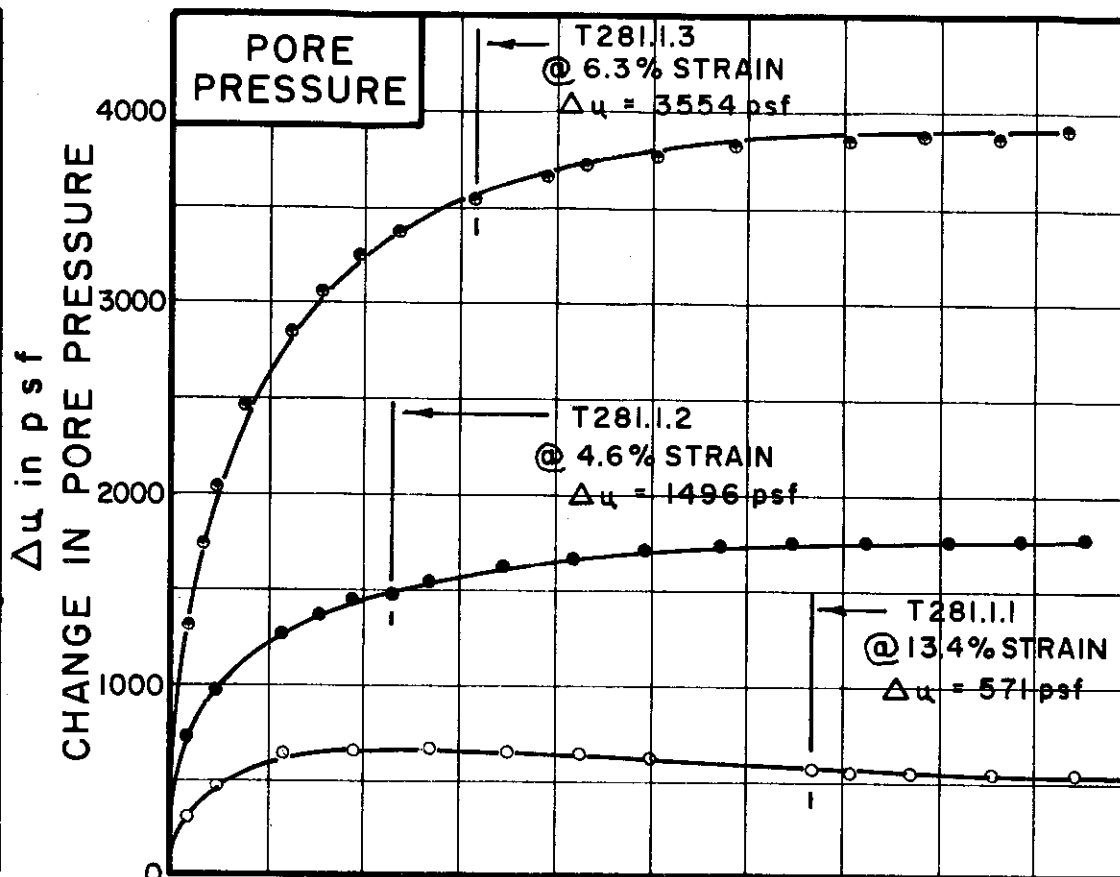
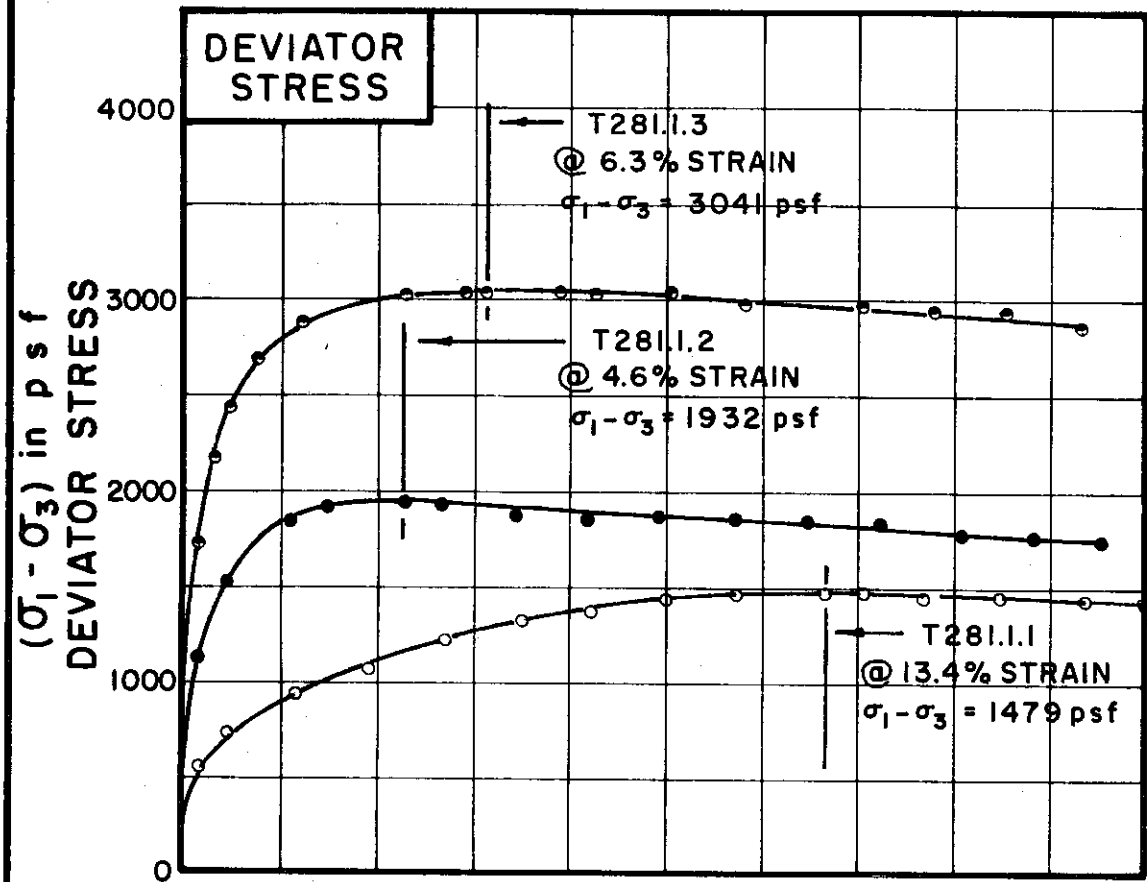

TEST NO. / SYMBOL	T281.1.1	T281.1.2	T281.1.3
-------------------	----------	----------	----------

INITIAL CONDITIONS			T281.1.1	T281.1.2	T281.1.3
WATER CONTENT	w_0		39.0%	39.7%	38.3%
DRY DENSITY	γ_d	lb/cu ft	82	82	84
SAMPLE DIAMETER	D_0	in.	1.38	1.38	1.38
SAMPLE HEIGHT	H_0	in.	3.28	3.27	3.28
CONDITIONS BEFORE SHEAR					
FINAL BACK PRESSURE	u_0	psf	7200	7200	11520
INITIAL EFFECTIVE STRESS	$\bar{\sigma}_1$ $\bar{\sigma}_3$	psf	1440	2880	5760
VOLUMETRIC STRAIN	ϵ_{vol}		2.96%	4.10%	7.21%
PORE PRESSURE RESPONSE			98%	98%	96%
FINAL CONDITIONS					
WATER CONTENT	w_f		37.3%	36.6%	31.7%
SKETCH OF SAMPLE AT END OF TEST					

RATE OF STRAIN PERCENT/MINUTE	.025	.025	.025
-------------------------------	------	------	------

BORING NO. 33
 SAMPLE NO. 7
 DEPTH 28.0' TO 30.5'
 SOIL DESCRIPTION SILTY CLAY (CL)
 LIQUID LIMIT 46 PLASTIC LIMIT 22

CONSOLIDATED UNDRAINED
 TRIAXIAL COMPRESSION
 TESTS
 THE DETROIT EDISON COMPANY
 BELLE RIVER PLANT UNITS I & II

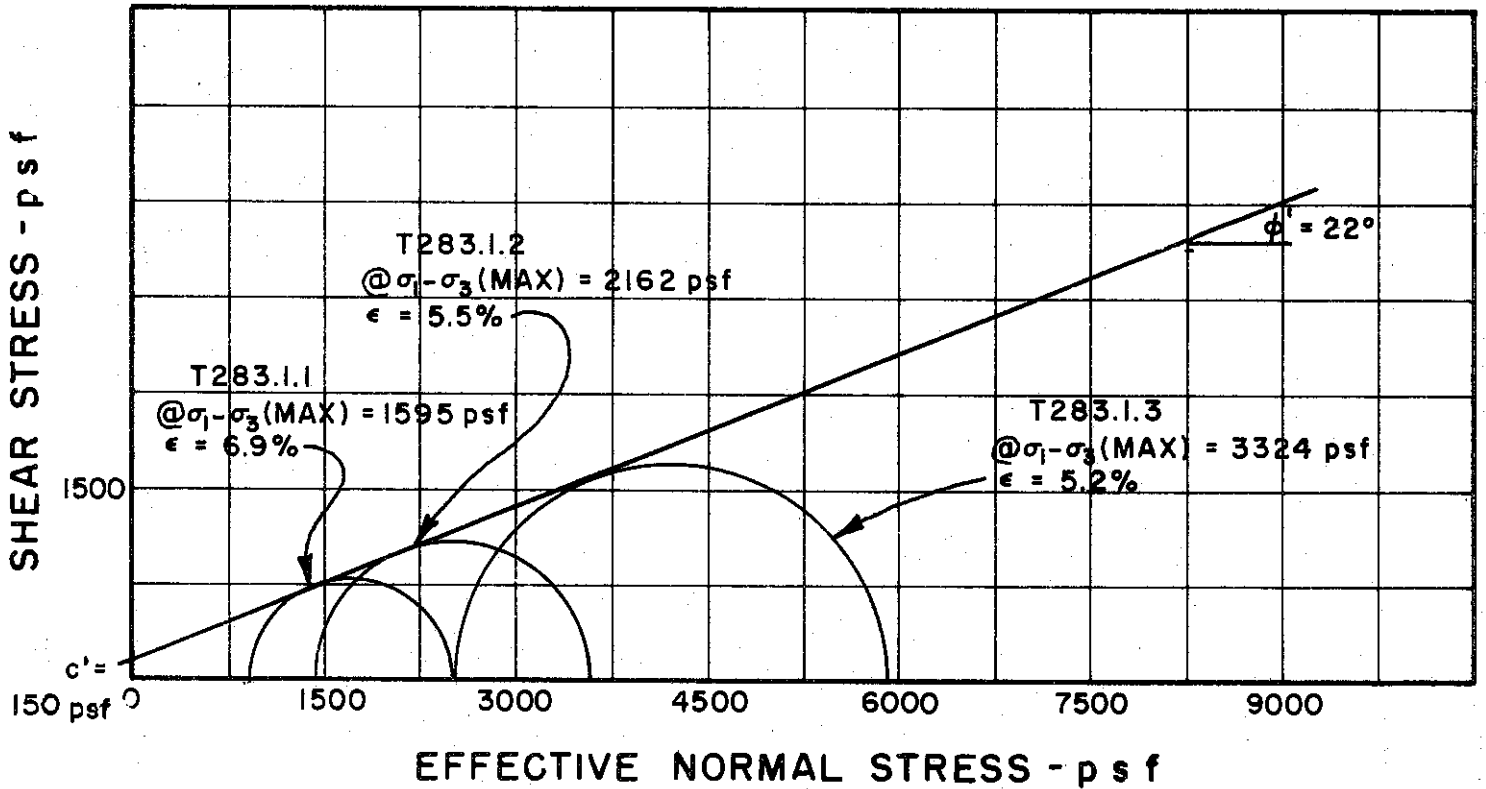
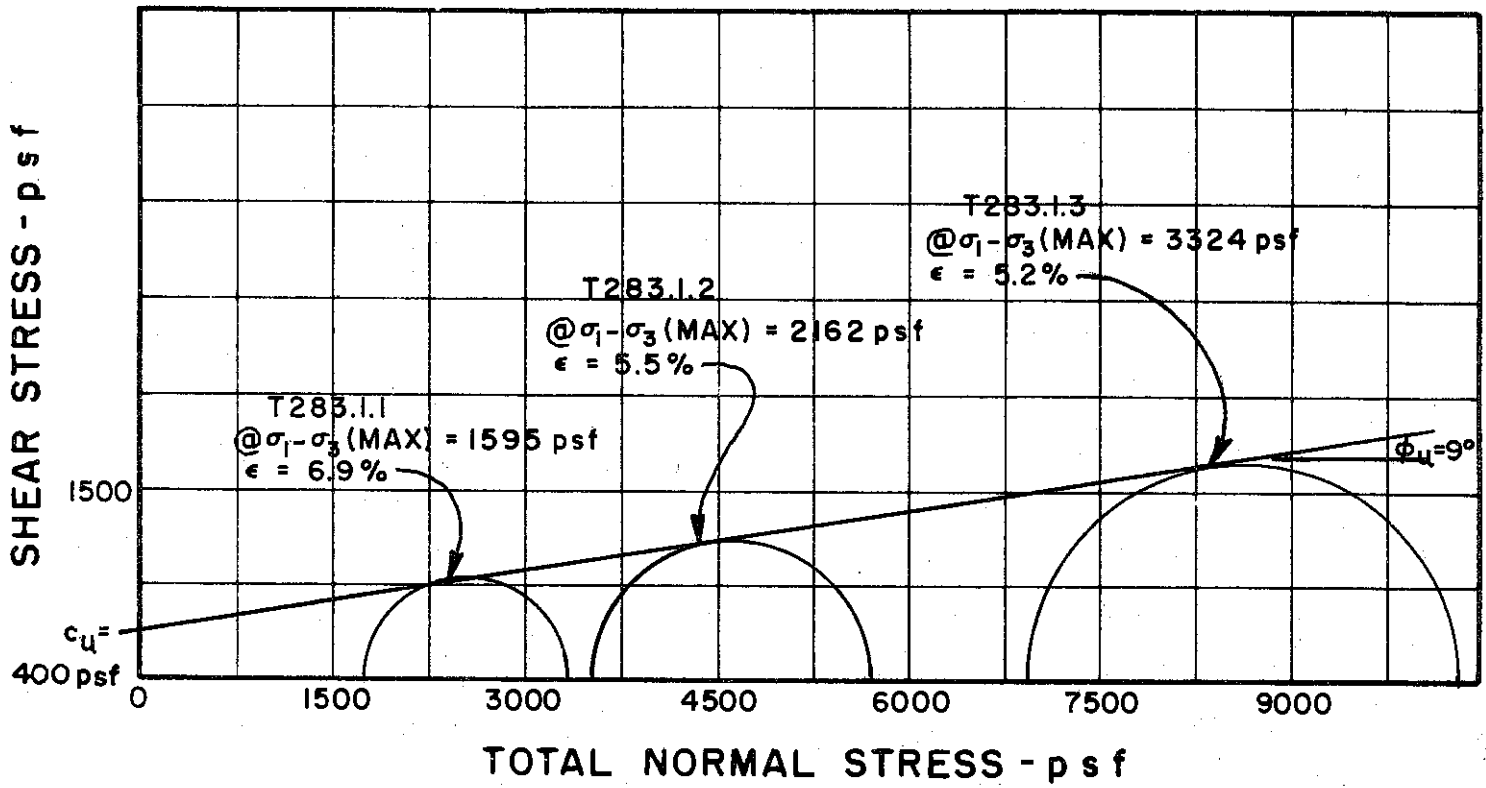

BORING NO. 33

SAMPLE NO. 9

DEPTH 38.0' TO 40.5'

REMARKS ENVELOPE IS INTERPRETIVE,
BASED ON LIMITED DATA POINTS
AVAILABLE

GOLDBERG-ZOINO AND ASSOCIATES, INC.
CONSULTANTS IN GEOTECHNICAL ENGINEERING

MOHR STRENGTH ENVELOPE
TRIAxIAL COMPRESSION
TESTS

THE DETROIT EDISON COMPANY
BELLE RIVER PLANT UNITS I & II

FILE 1255

C-399

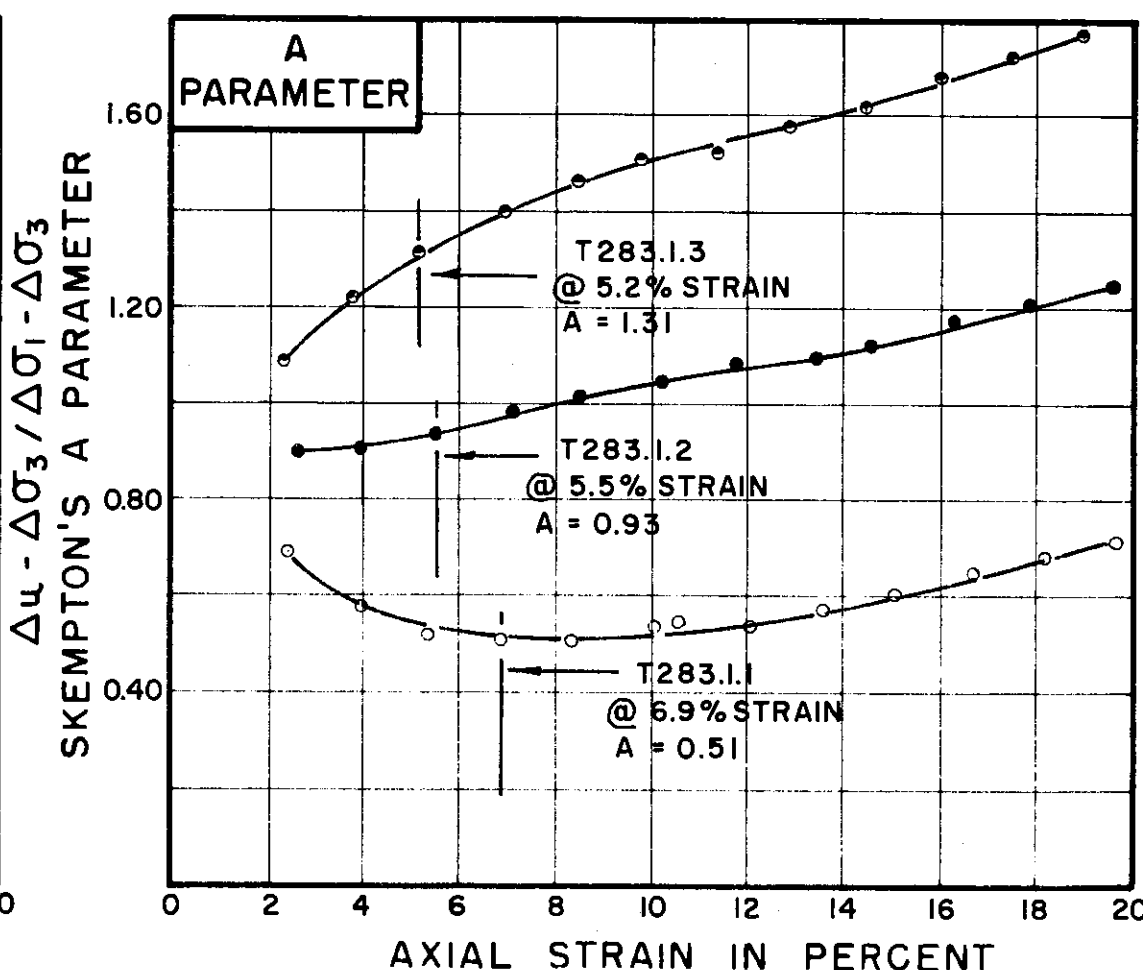
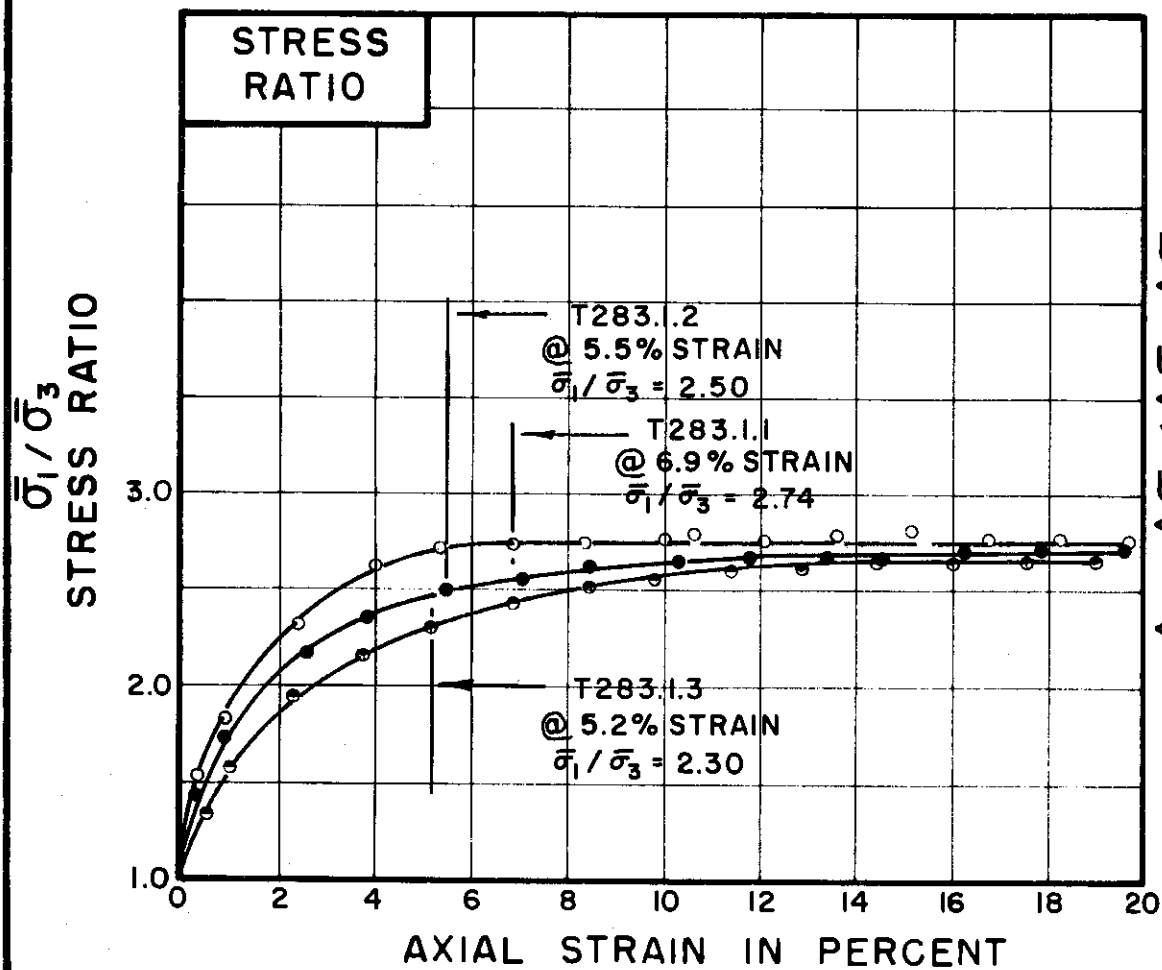
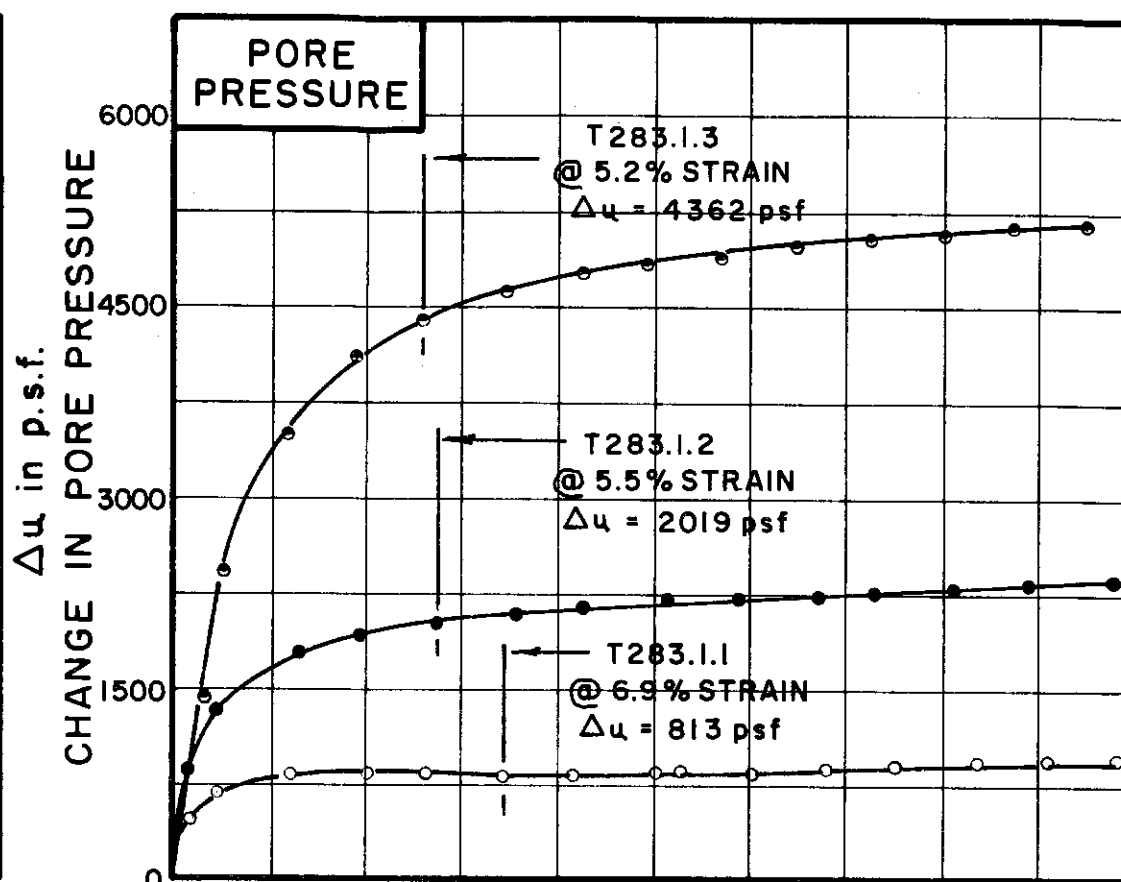
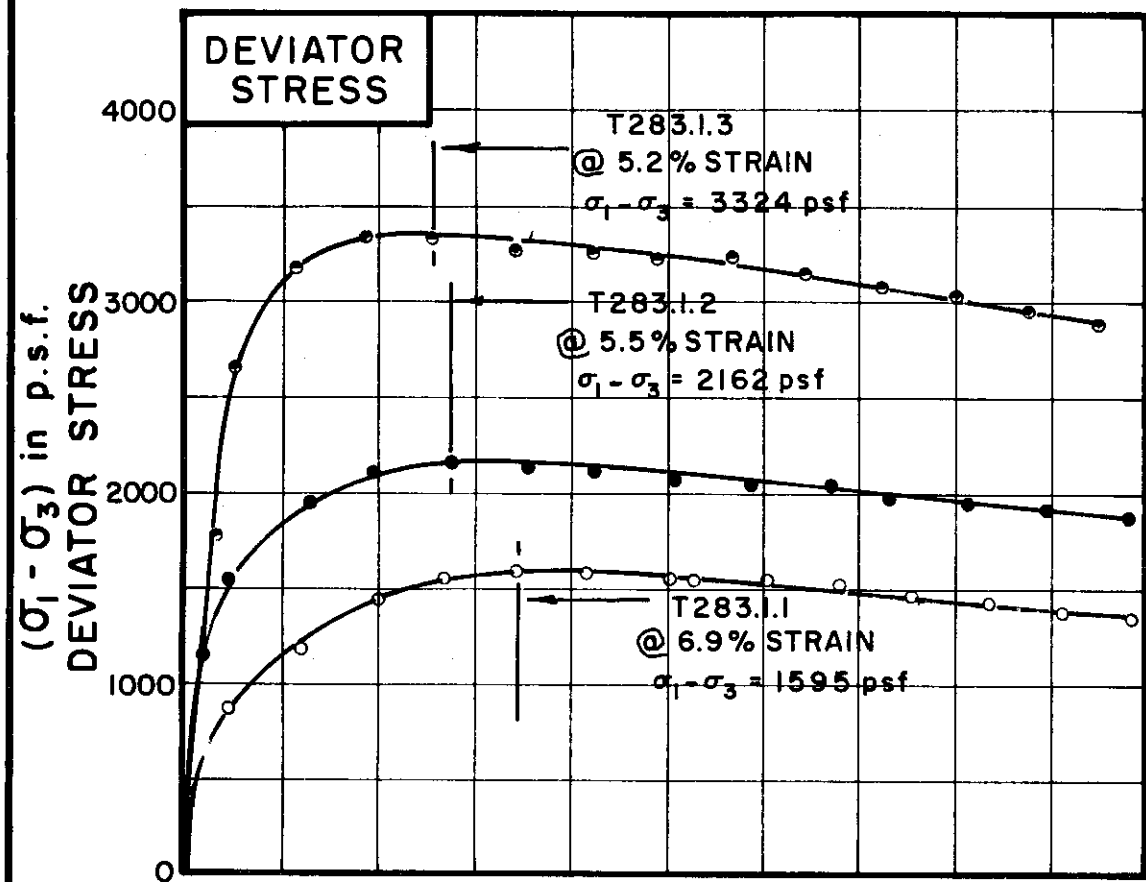

TEST NO. / SYMBOL	T283.1.1	T283.1.2	T283.1.3
-------------------	----------	----------	----------

INITIAL CONDITIONS			T283.1.1	T283.1.2	T283.1.3
WATER CONTENT	w_0		37.4%	37.1%	36.2%
DRY DENSITY	γ_d	lb/cu ft	83	85	86
SAMPLE DIAMETER	D_0	in.	1.40	1.39	1.39
SAMPLE HEIGHT	H_0	in.	3.31	3.25	3.32
CONDITIONS BEFORE SHEAR			T283.1.1	T283.1.2	T283.1.3
FINAL BACK PRESSURE	u_0	p.s.f.	7200	7200	12960
INITIAL EFFECTIVE STRESS	$\bar{\sigma}_1, \bar{\sigma}_3$	p.s.f.	1728	3456	6912
VOLUMETRIC STRAIN	ϵ_{vol}		1.77%	3.35%	5.16%
PORE PRESSURE RESPONSE			96%	98%	95%
FINAL CONDITIONS			T283.1.1	T283.1.2	T283.1.3
WATER CONTENT	w_f		35.5%	33.6%	30.8%
SKETCH OF SAMPLE AT END OF TEST					

RATE OF STRAIN PERCENT/MINUTE	.024	.025	.024
-------------------------------	------	------	------

BORING NO. 33
 SAMPLE NO. 9
 DEPTH 38.0' TO 40.5'
 SOIL DESCRIPTION SILTY CLAY (CL)
 LIQUID LIMIT 43 PLASTIC LIMIT 23

CONSOLIDATED UNDRAINED
 TRIAXIAL COMPRESSION
 TESTS

THE DETROIT EDISON COMPANY
 BELLE RIVER PLANT UNITS I & II

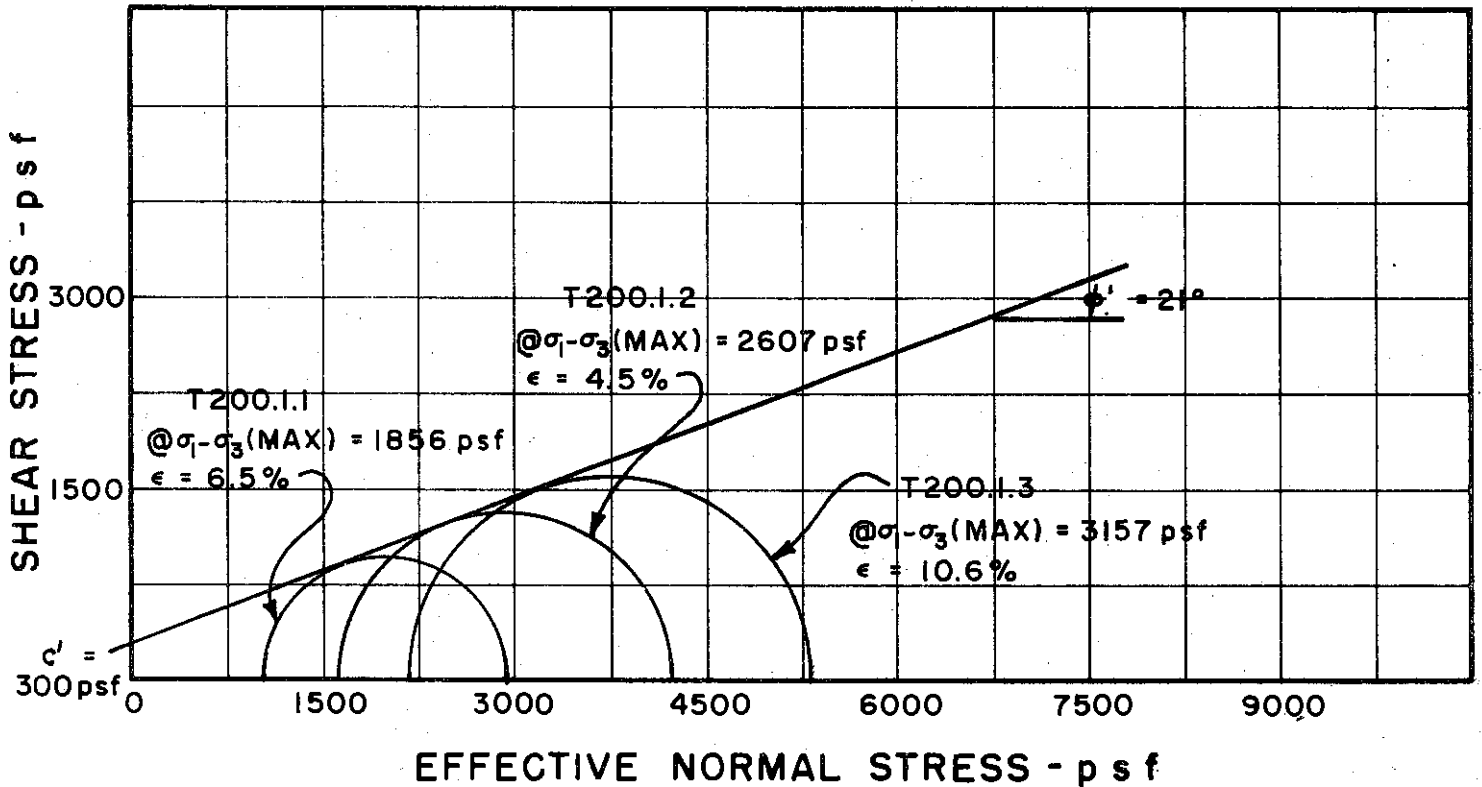
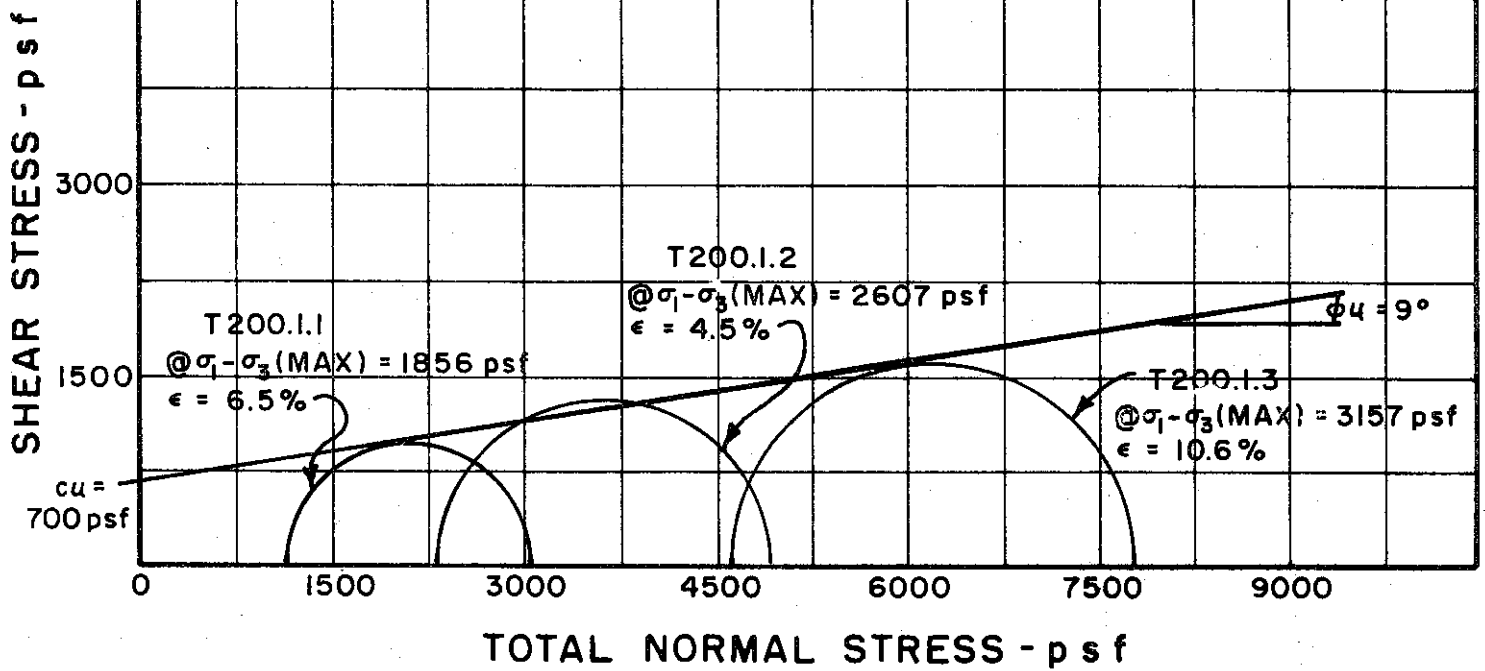

BORING NO. 48
 SAMPLE NO. 6
 DEPTH 18.0 TO 20.0

MOHR STRENGTH ENVELOPE
 TRIAXIAL COMPRESSION
 TESTS

REMARKS ENVELOPE IS INTERPRETIVE,
BASED ON LIMITED DATA POINTS
AVAILABLE

THE DETROIT EDISON COMPANY
 BELLE RIVER PLANT UNITS I & II

GOLDBERG-ZOINO AND ASSOCIATES, INC.
 CONSULTANTS IN GEOTECHNICAL ENGINEERING

FILE 1255

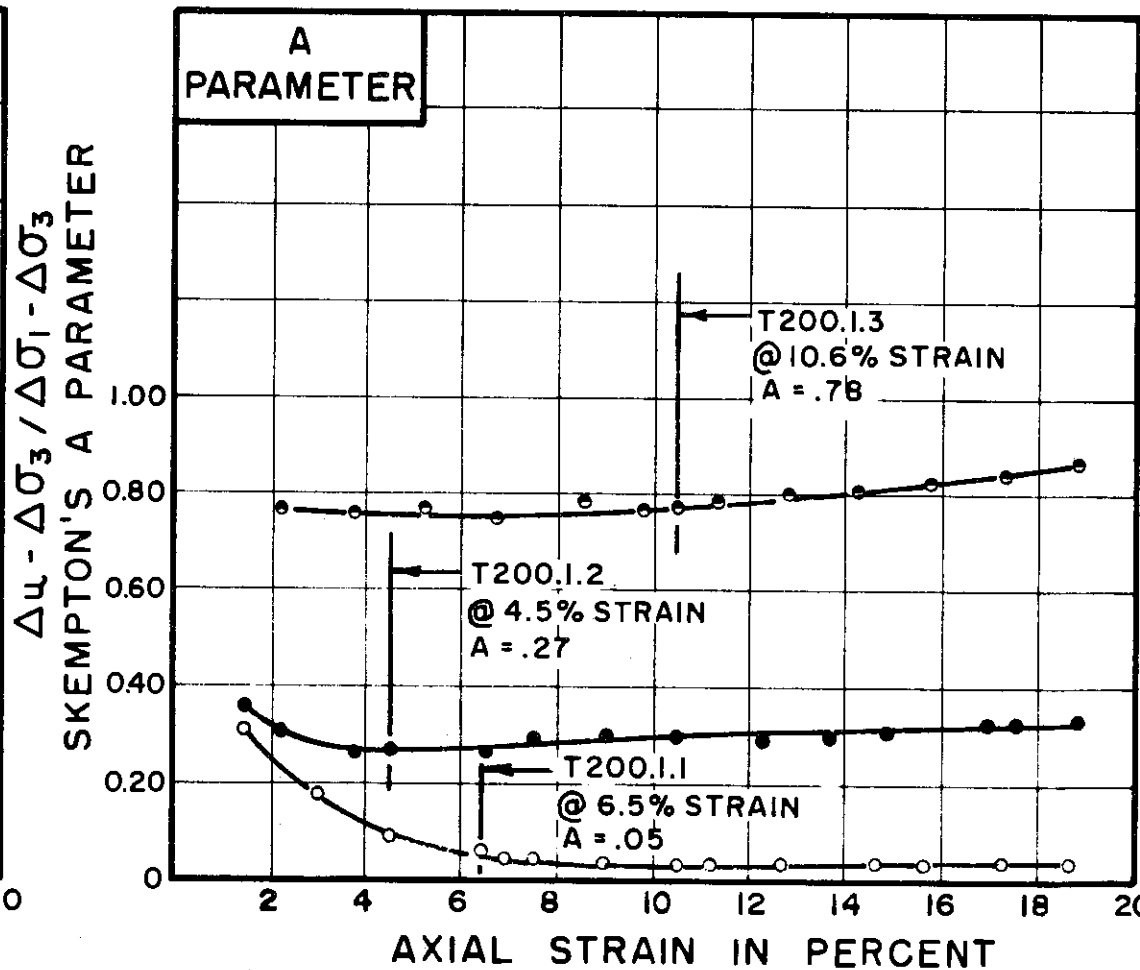
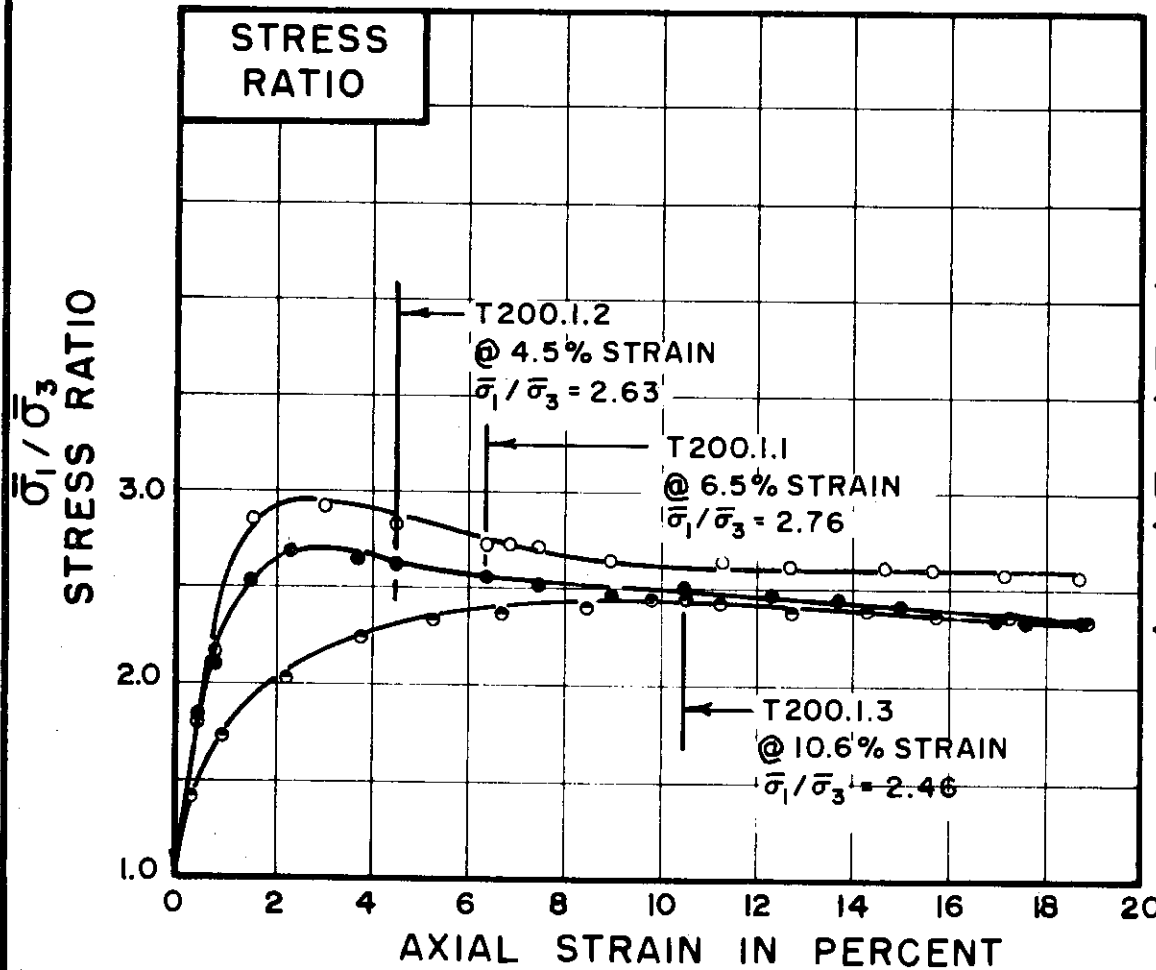
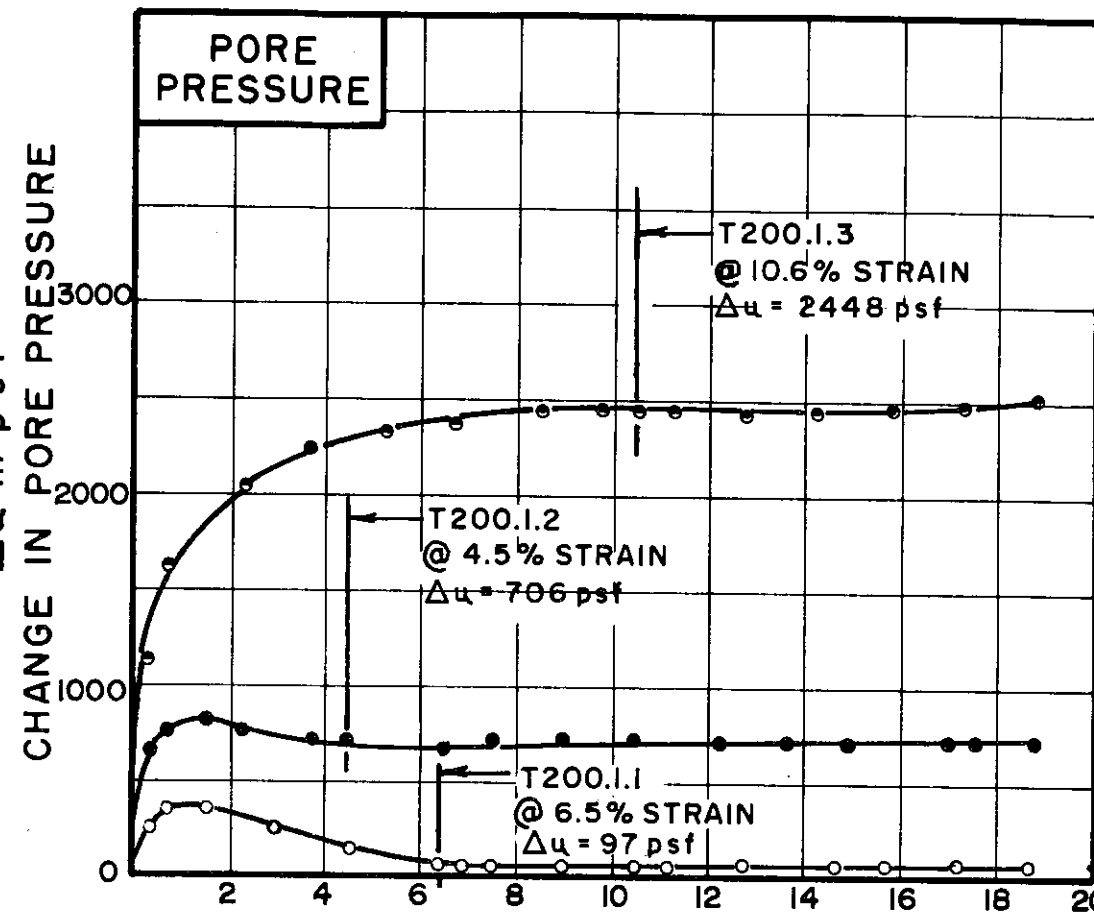
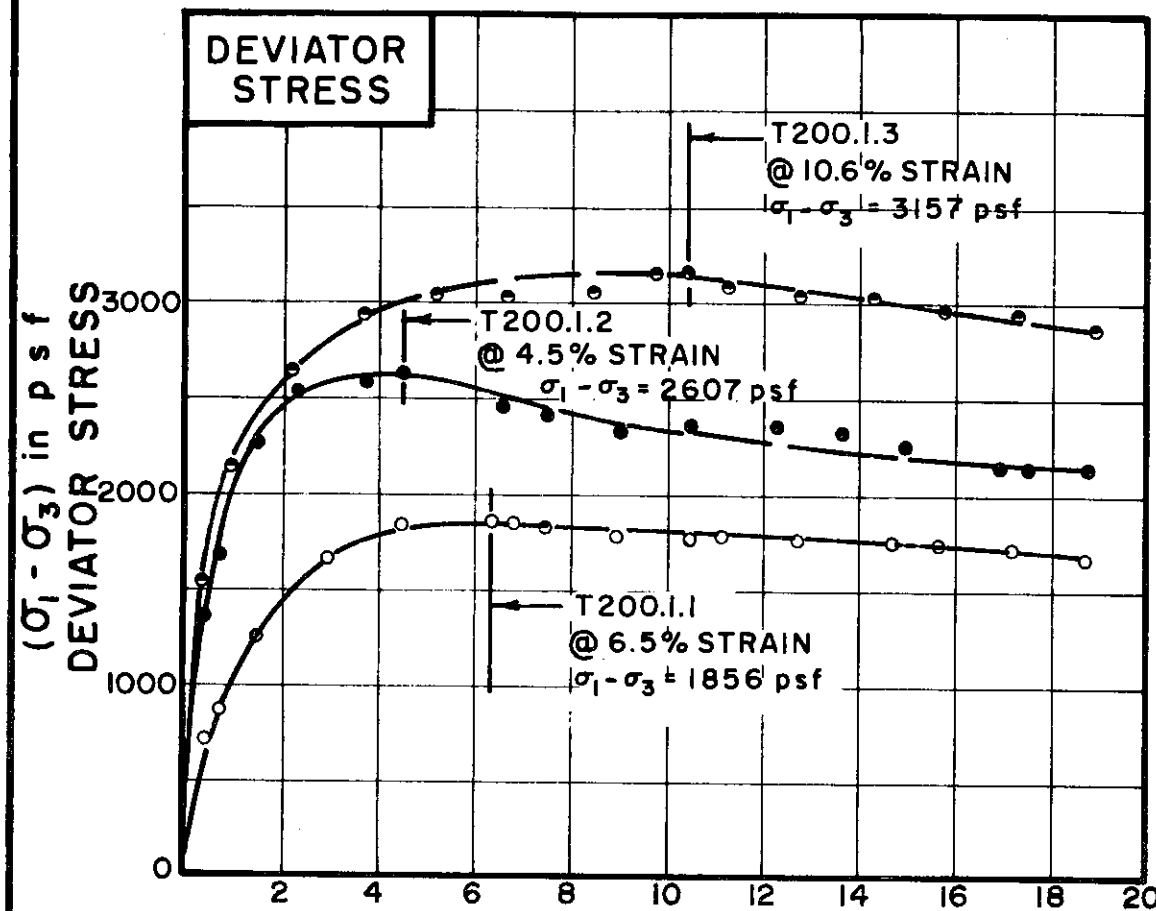

TEST NO. / SYMBOL	T200.1.1	T200.1.2	T200.1.3
	○	●	○

INITIAL CONDITIONS			T200.1.1	T200.1.2	T200.1.3
WATER CONTENT	w_0		32.8%	34.2%	35.6%
DRY DENSITY	γ_d	pcf	90	89	88
SAMPLE DIAMETER	D_0	in.	1.41	1.41	1.41
SAMPLE HEIGHT	H_0	in.	3.35	3.35	3.38
FINAL CONDITIONS BEFORE SHEAR			T200.1.1	T200.1.2	T200.1.3
FINAL BACK PRESSURE	u_0	psf	8640	8640	8640
INITIAL EFFECTIVE STRESS	$\bar{\sigma}_1, \bar{\sigma}_3$	psf	1152	2304	4608
VOLUMETRIC STRAIN	ϵ_{vol}		1.6%	2.7%	5.9%
PORE PRESSURE RESPONSE			96%	99%	100%
FINAL CONDITIONS			T200.1.1	T200.1.2	T200.1.3
WATER CONTENT	w_f		32.1%	33.4%	31.0%
SKETCH OF SAMPLE AT END OF TEST					

RATE OF STRAIN PERCENT/MINUTE	.024	.024	.024
-------------------------------	------	------	------

BORING NO. 48
 SAMPLE NO. 6
 DEPTH 18.0 TO 20.0
 SOIL DESCRIPTION SILTY CLAY, (CL-CH)
 LIQUID LIMIT 47 PLASTIC LIMIT 25

CONSOLIDATED UNDRAINED
 TRIAXIAL COMPRESSION
 TESTS

THE DETROIT EDISON COMPANY
 BELLE RIVER PLANT UNITS I & II

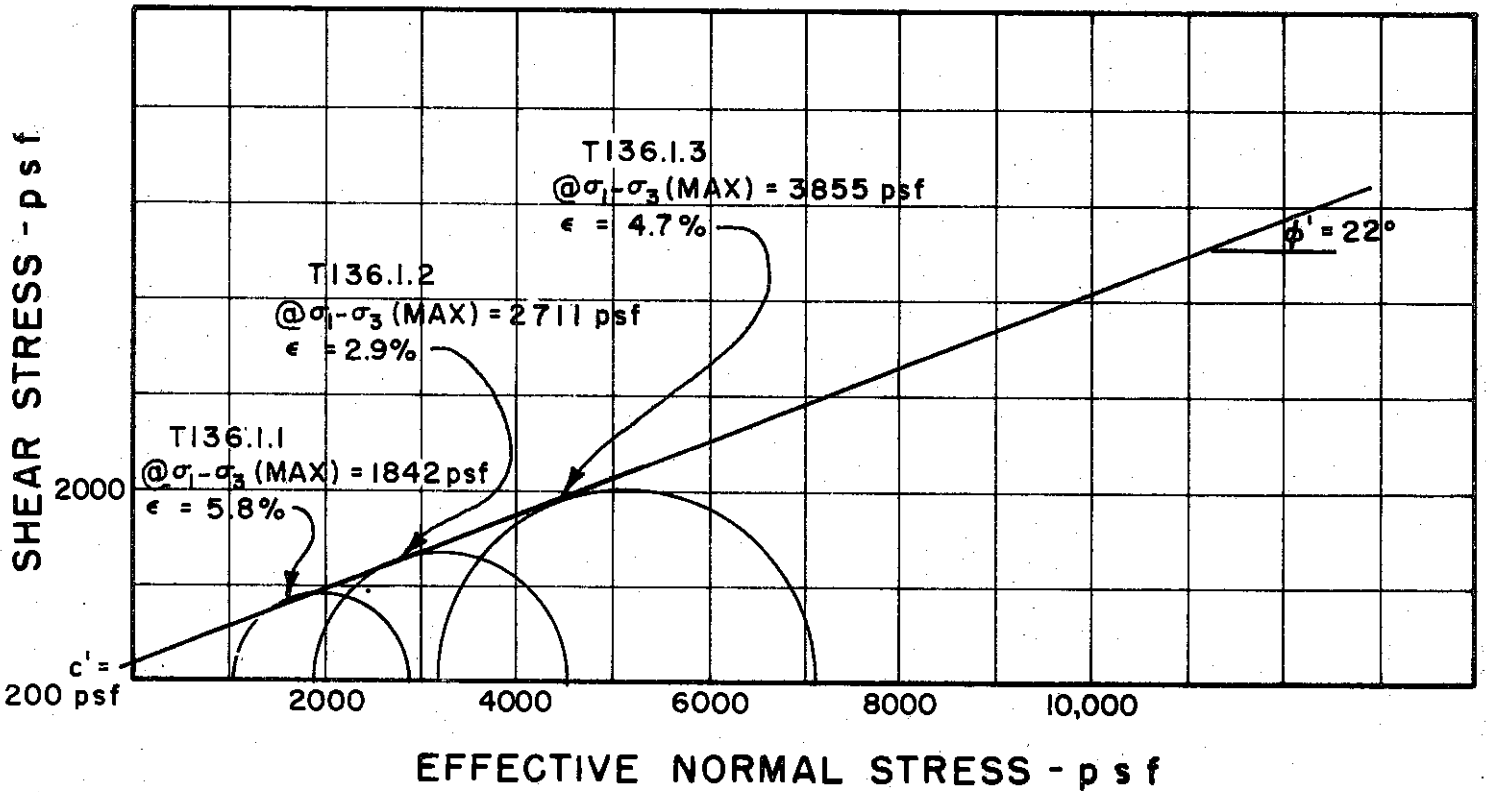
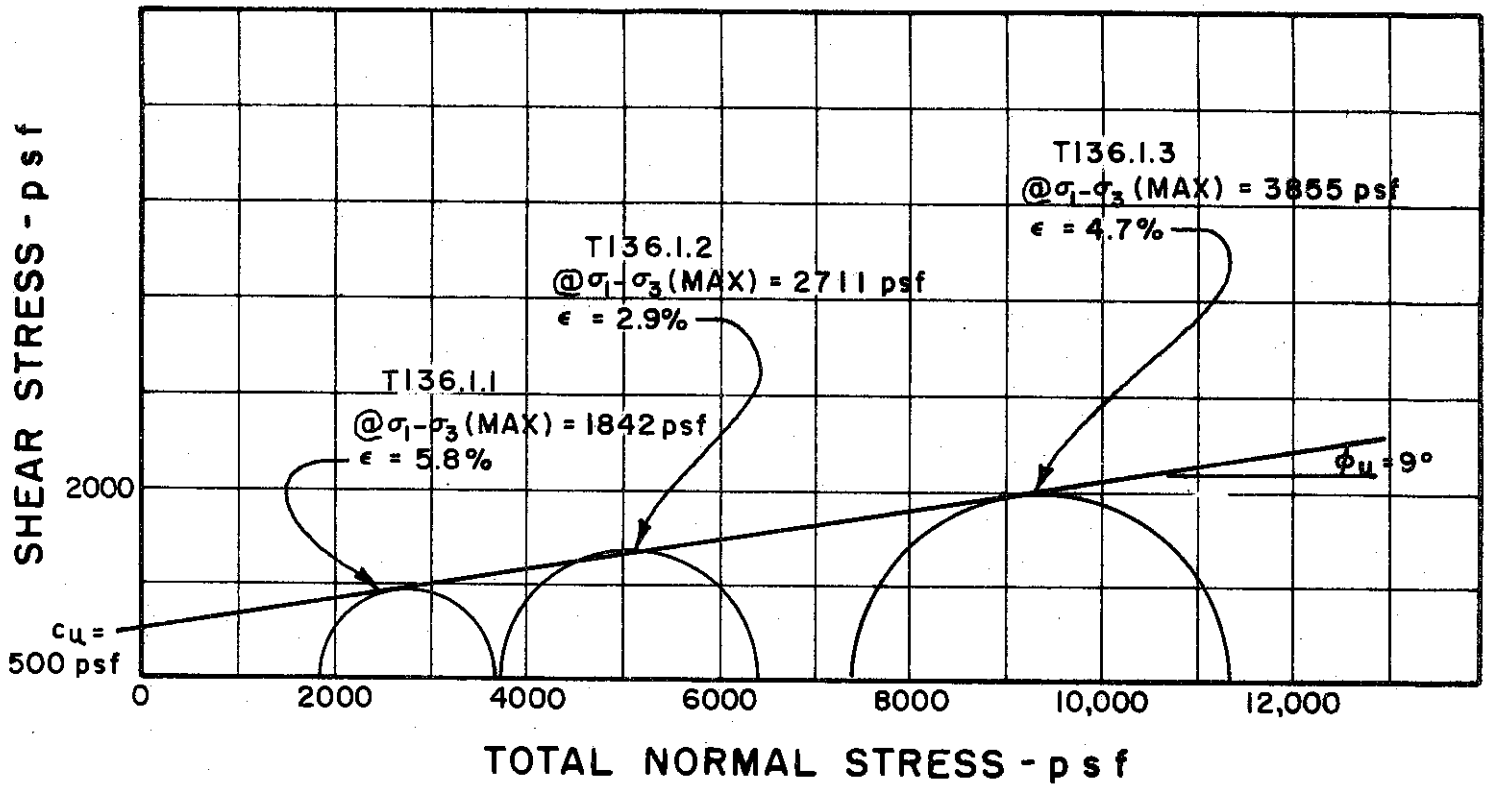

BORING NO. 49

SAMPLE NO. 6

DEPTH 43.0' TO 45.0'

REMARKS ENVELOPE IS INTERPRETIVE,
BASED ON LIMITED DATA POINTS
AVAILABLE

GOLDBERG-ZOINO AND ASSOCIATES, INC.
 CONSULTANTS IN GEOTECHNICAL ENGINEERING

MOHR STRENGTH ENVELOPE
 TRIAXIAL COMPRESSION
 TESTS

THE DETROIT EDISON COMPANY
 BELLE RIVER PLANT UNITS I & II

FILE 1255

C-403

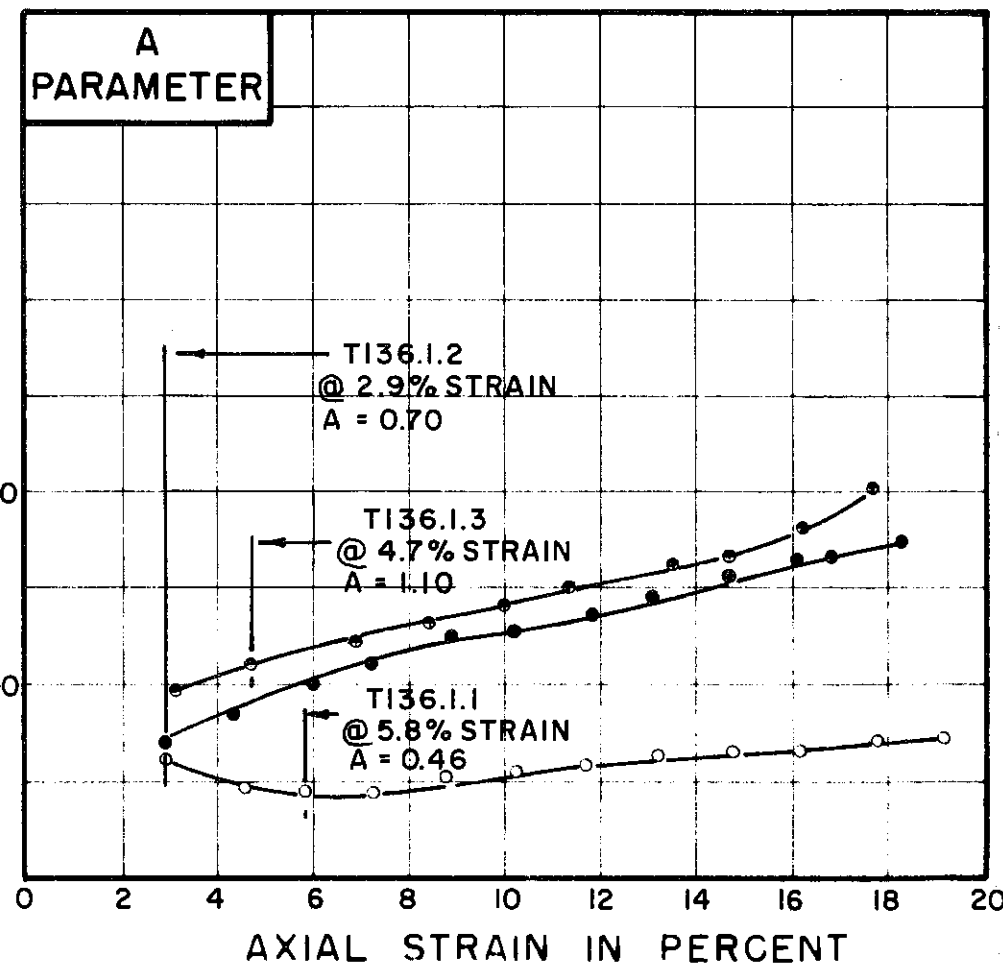
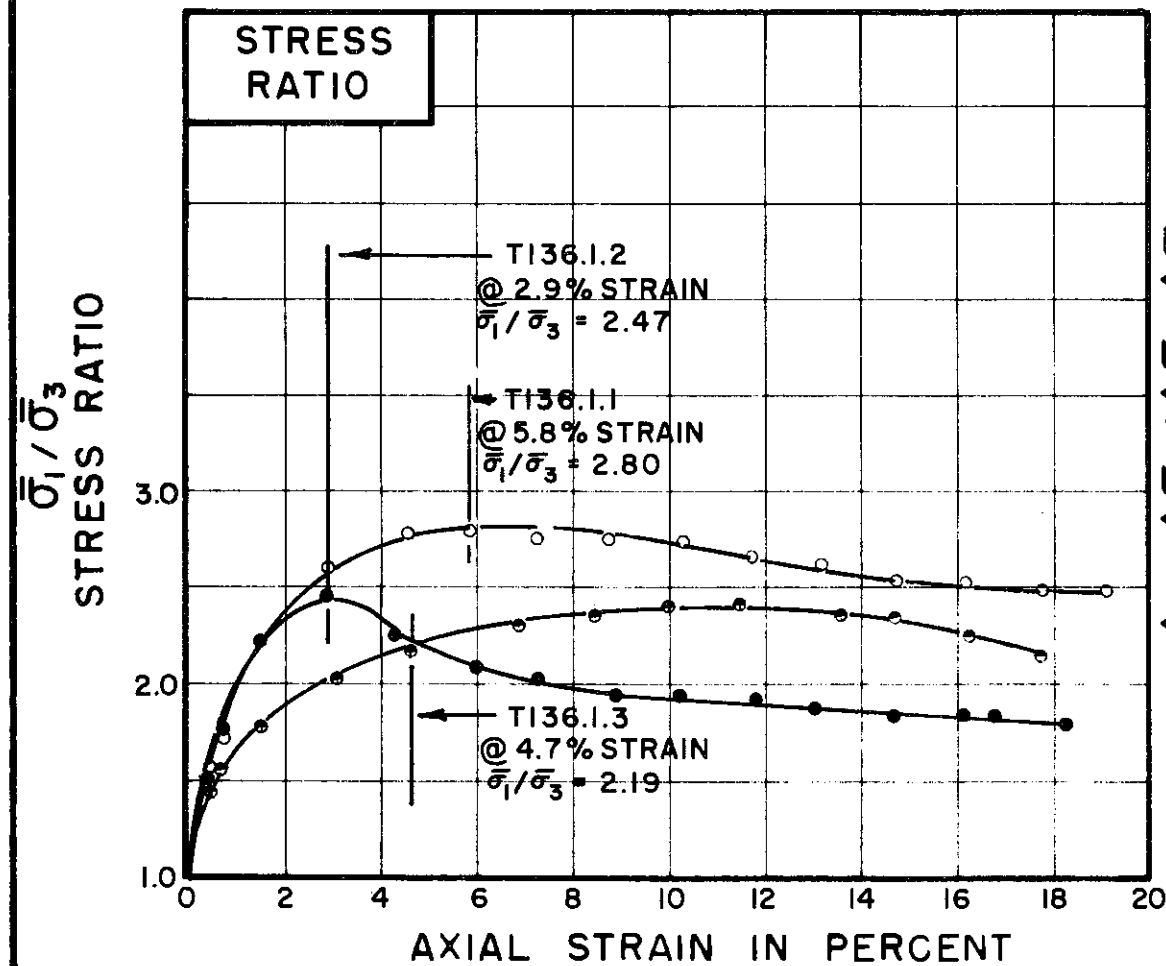
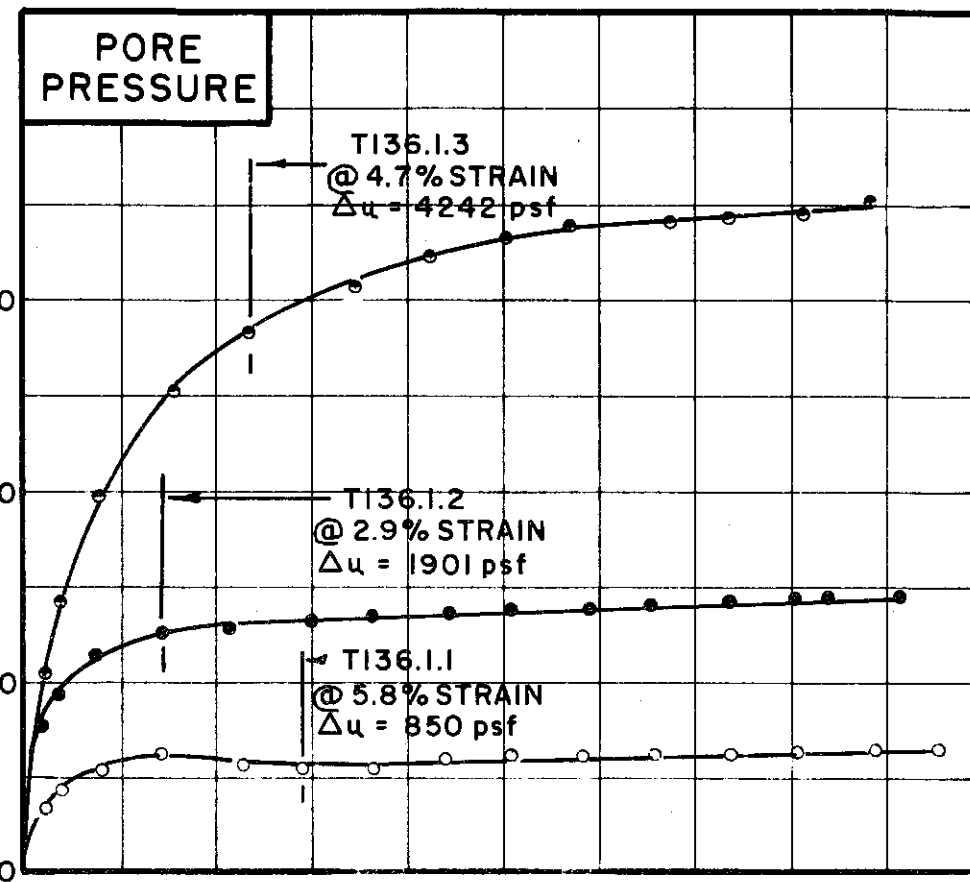
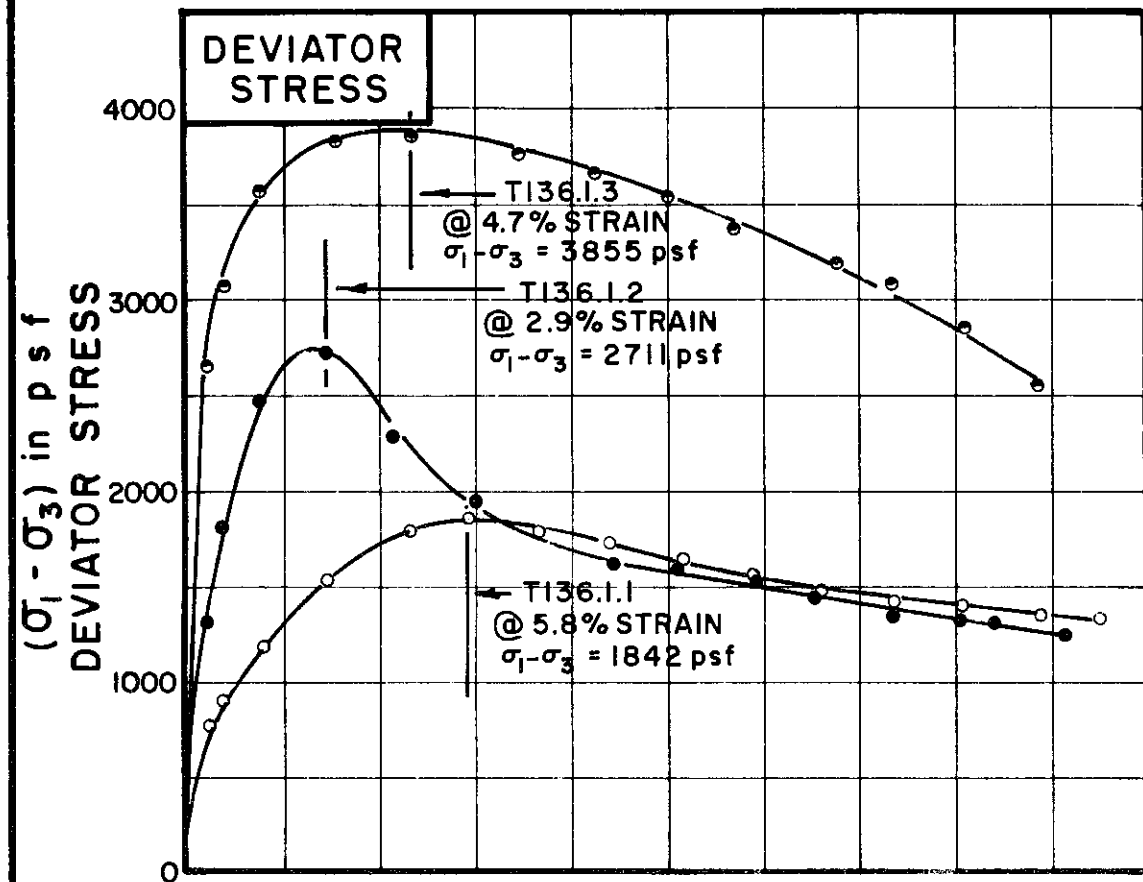

TEST NO. / SYMBOL	T136.1.1	T136.1.2	T136.1.3
	○	●	○

INITIAL CONDITIONS	WATER CONTENT	w_0	43.5%	46.3%	44.9%
		DRY DENSITY lb/cu ft	γ_d	78	75
	SAMPLE DIAMETER in.	D_0	1.40	1.40	1.41
	SAMPLE HEIGHT in.	H_0	3.43	3.45	3.34
FINAL CONDITIONS BEFORE SHEAR	FINAL BACK PRESSURE psf	u_0	11520	8640	7200
	INITIAL EFFECTIVE STRESS psf	$\bar{\sigma}_1, \bar{\sigma}_3$	1872	3744	7488
	VOLUMETRIC STRAIN	ϵ_{vol}	2.55%	2.88%	8.59%
	PORE PRESSURE RESPONSE		98%	100%	96%
FINAL CONDITIONS	WATER CONTENT	w_f	41.5%	44.7%	38.5%
	SKETCH OF SAMPLE AT END OF TEST				

RATE OF STRAIN PERCENT/MINUTE	.024	.023	.025
-------------------------------	------	------	------

BORING NO. 49
 SAMPLE NO. 6
 DEPTH 43.0' TO 45.0'
 SOIL DESCRIPTION SILTY CLAY (CH-CL)
 LIQUID LIMIT 53 PLASTIC LIMIT 22

CONSOLIDATED UNDRAINED
 TRIAXIAL COMPRESSION
 TESTS

THE DETROIT EDISON COMPANY
 BELLE RIVER PLANT UNITS I & II

SHEAR STRESS - p.s.f.

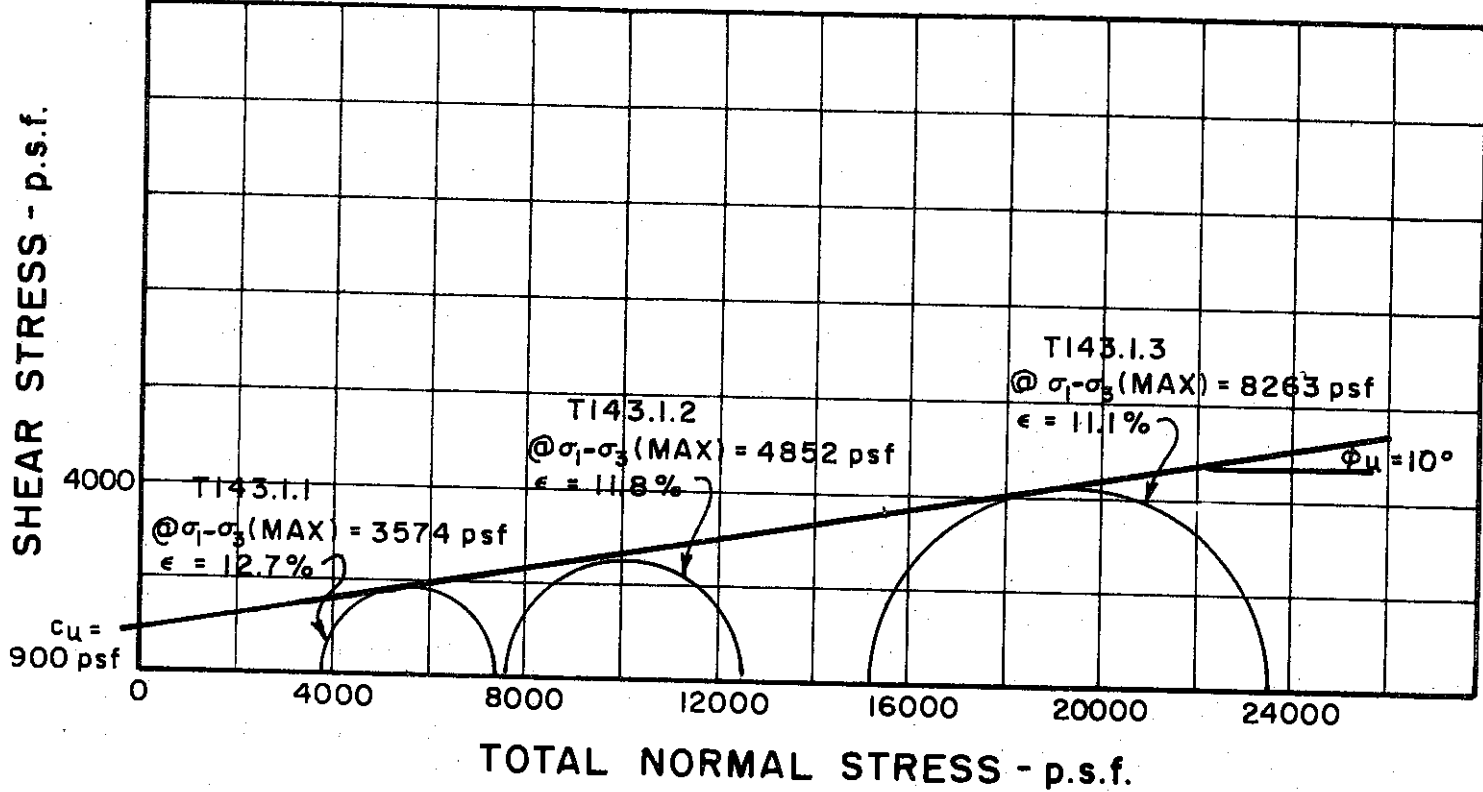

SHEAR STRESS - p.s.f.

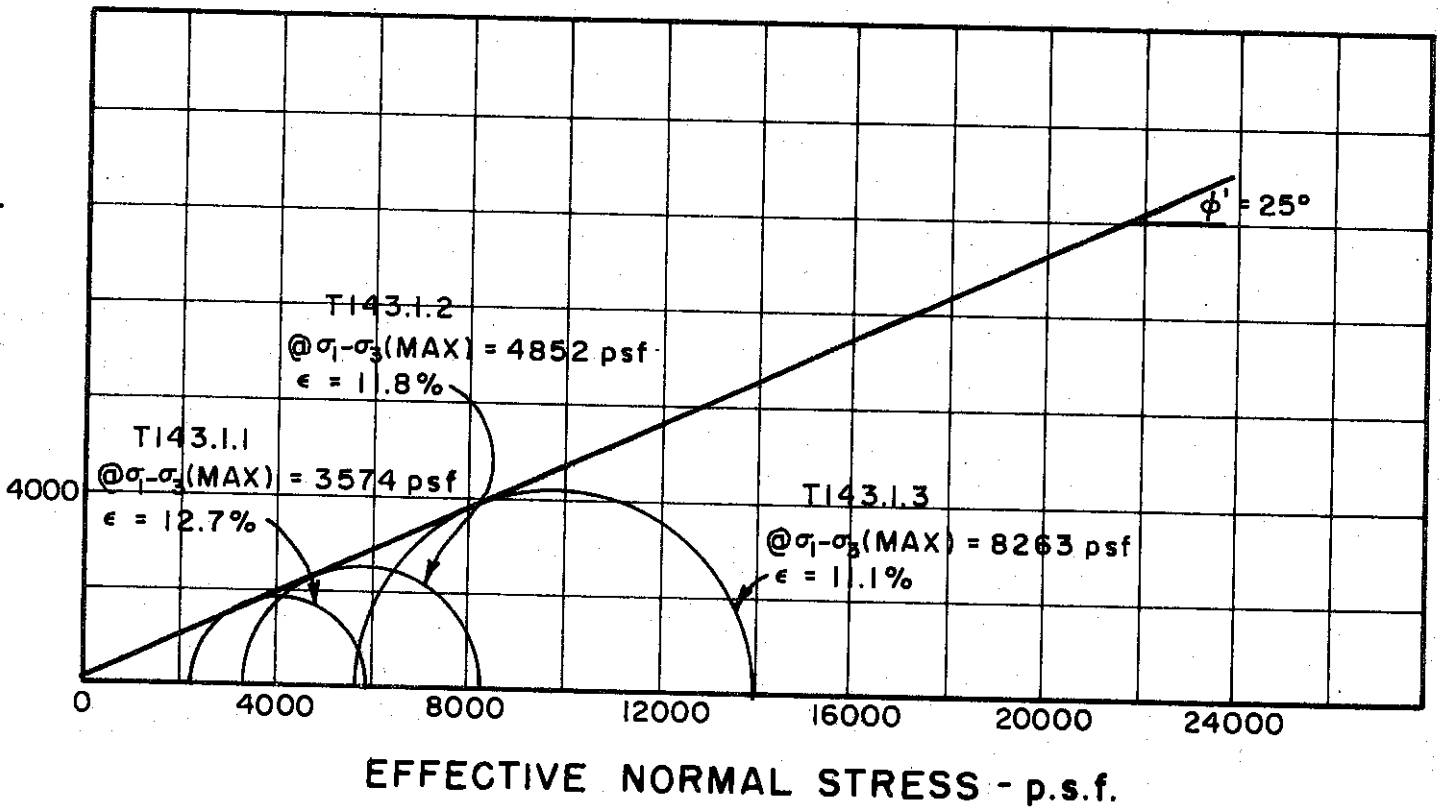

BORING NO. 49

SAMPLE NO. 13

DEPTH 113.0' TO 115.0'

REMARKS ENVELOPE IS INTERPRETIVE,
BASED ON LIMITED DATA POINTS
AVAILABLE

GOLDBERG-ZOINO AND ASSOCIATES, INC.
CONSULTANTS IN GEOTECHNICAL ENGINEERING

MOHR STRENGTH ENVELOPE
TRIAXIAL COMPRESSION
TESTS

THE DETROIT EDISON COMPANY
BELLE RIVER PLANT UNITS I & II

FILE 1255

C-405

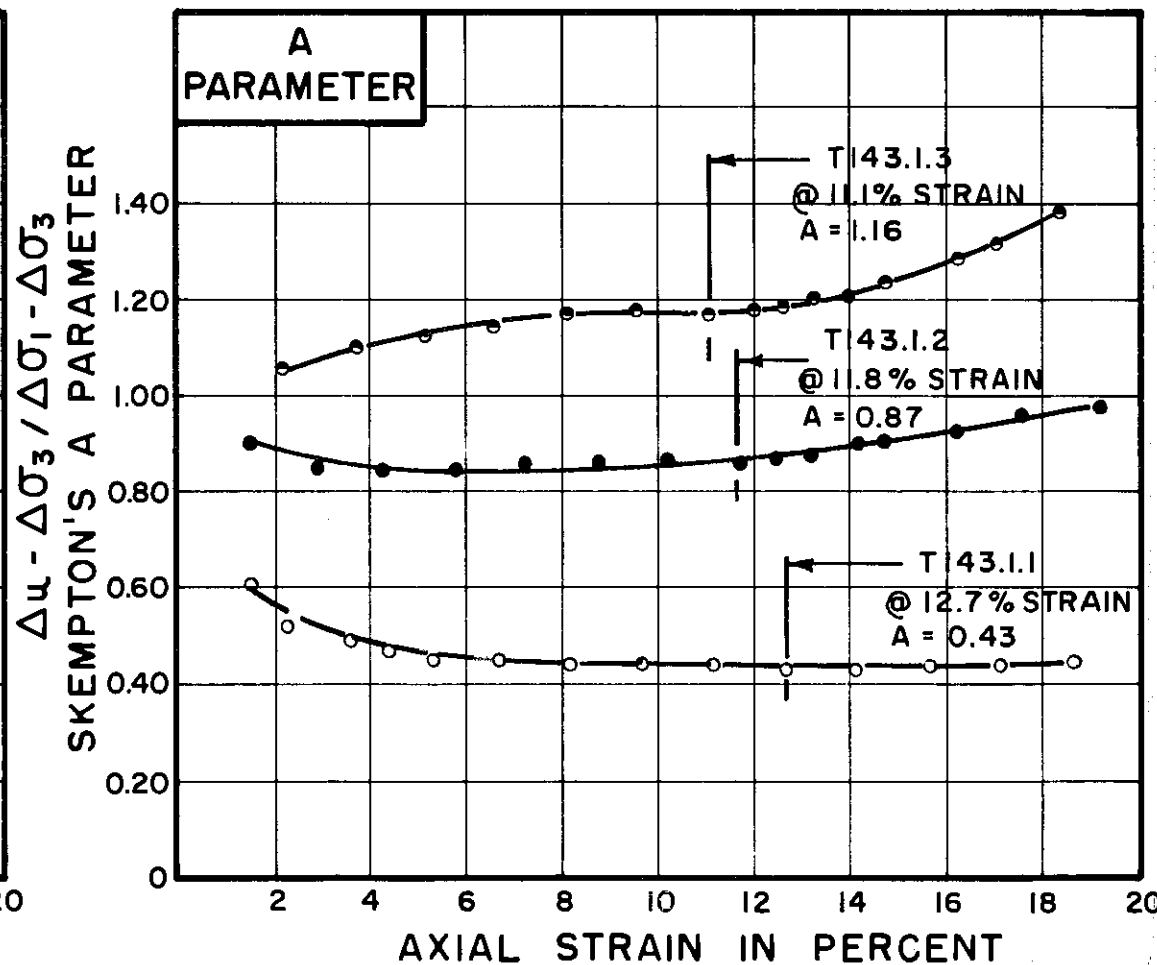
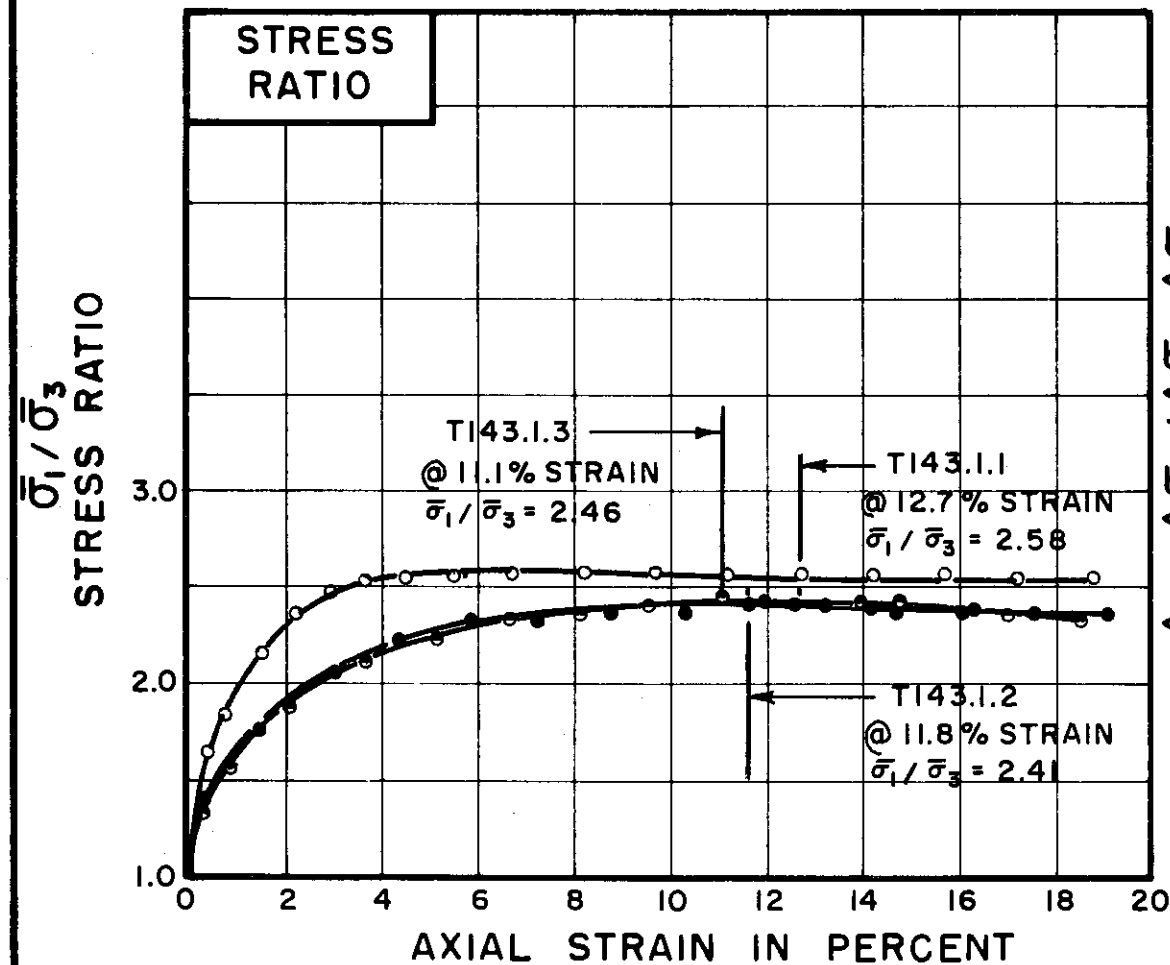
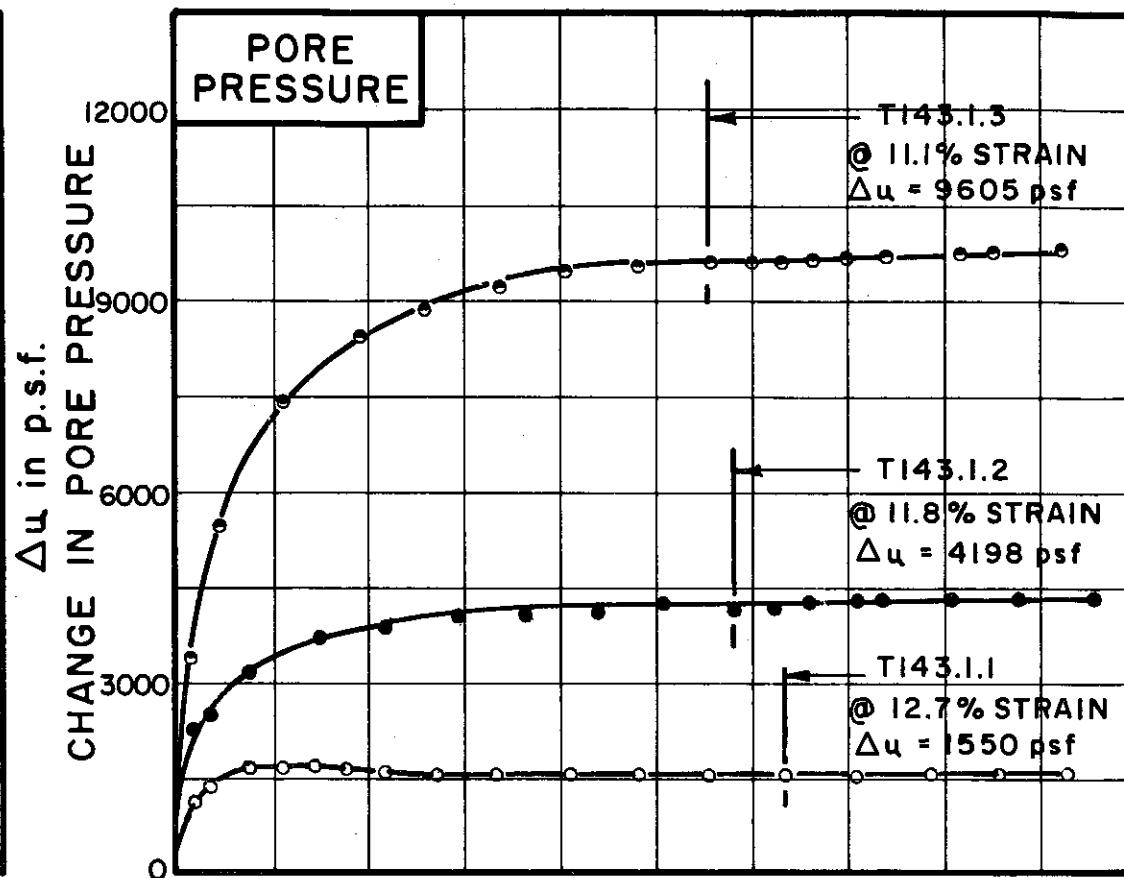
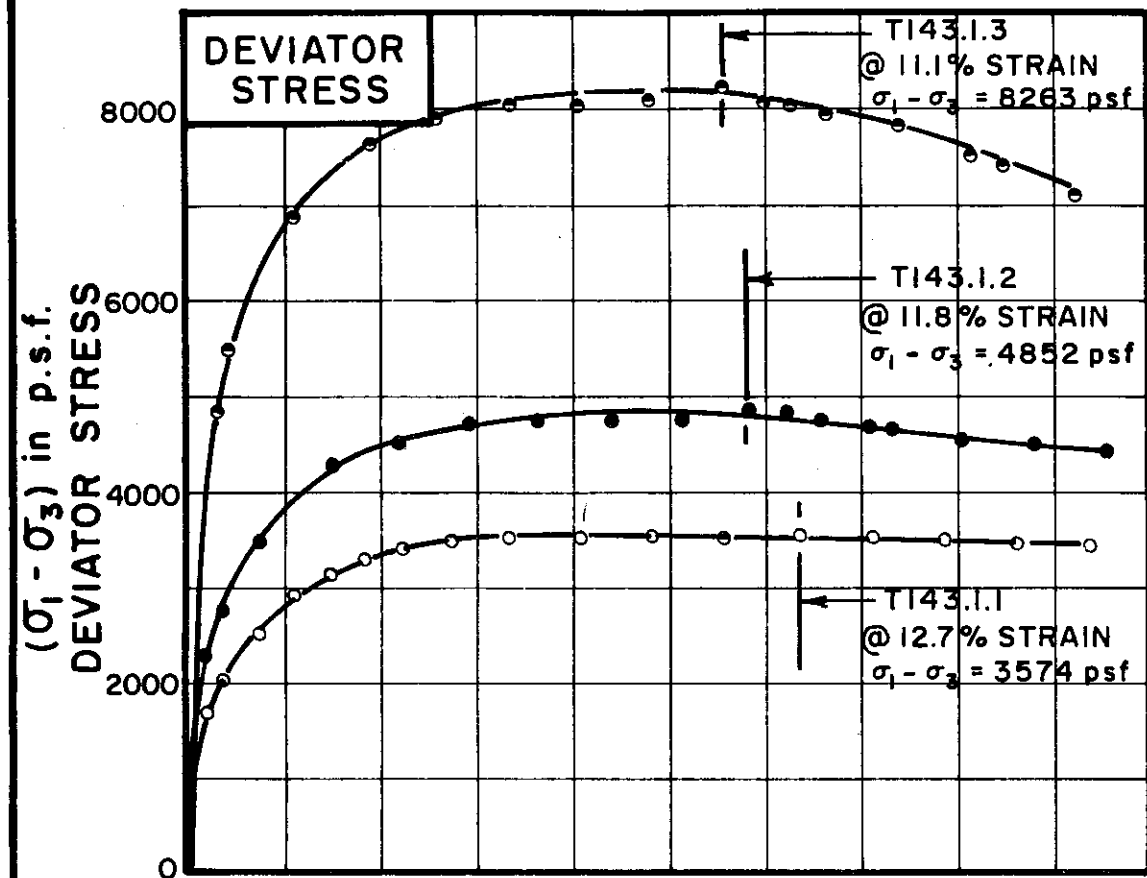

TEST NO. / SYMBOL	T143.1.1	T143.1.2	T143.1.3
	○	●	○

INITIAL CONDITIONS		T143.1.1	T143.1.2	T143.1.3
WATER CONTENT	w_0	24.0%	28.7%	29.2%
DRY DENSITY	γ_d pcf	100	95	93
SAMPLE DIAMETER	D_0 in.	1.40	1.40	1.41
SAMPLE HEIGHT	H_0 in.	3.37	3.46	3.44
FINAL CONDITIONS BEFORE SHEAR		T143.1.1	T143.1.2	T143.1.3
FINAL BACK PRESSURE	u_0 p.s.f.	11520	7200	7200
INITIAL EFFECTIVE STRESS	$\frac{\bar{\sigma}_1}{\bar{\sigma}_3}$ p.s.f.	3816	7632	15264
VOLUMETRIC STRAIN	ϵ_{vol}	2.6%	5.1%	6.3%
PORE PRESSURE RESPONSE		95	100	100
FINAL CONDITIONS AT END OF TEST		T143.1.1	T143.1.2	T143.1.3
WATER CONTENT	w_f	23.1%	26.5%	24.4%
SKETCH OF SAMPLE AT END OF TEST				

RATE OF STRAIN PERCENT/MINUTE	.024	.023	.024
-------------------------------	------	------	------

BORING NO. 49
 SAMPLE NO. 13
 DEPTH 113.0' TO 115.0'
 SOIL DESCRIPTION SILTY CLAY, SANDY (CL)
 LIQUID LIMIT 33 PLASTIC LIMIT 22

CONSOLIDATED UNDRAINED
 TRIAXIAL COMPRESSION
 TESTS

THE DETROIT EDISON COMPANY
 BELLE RIVER PLANT UNITS I & II

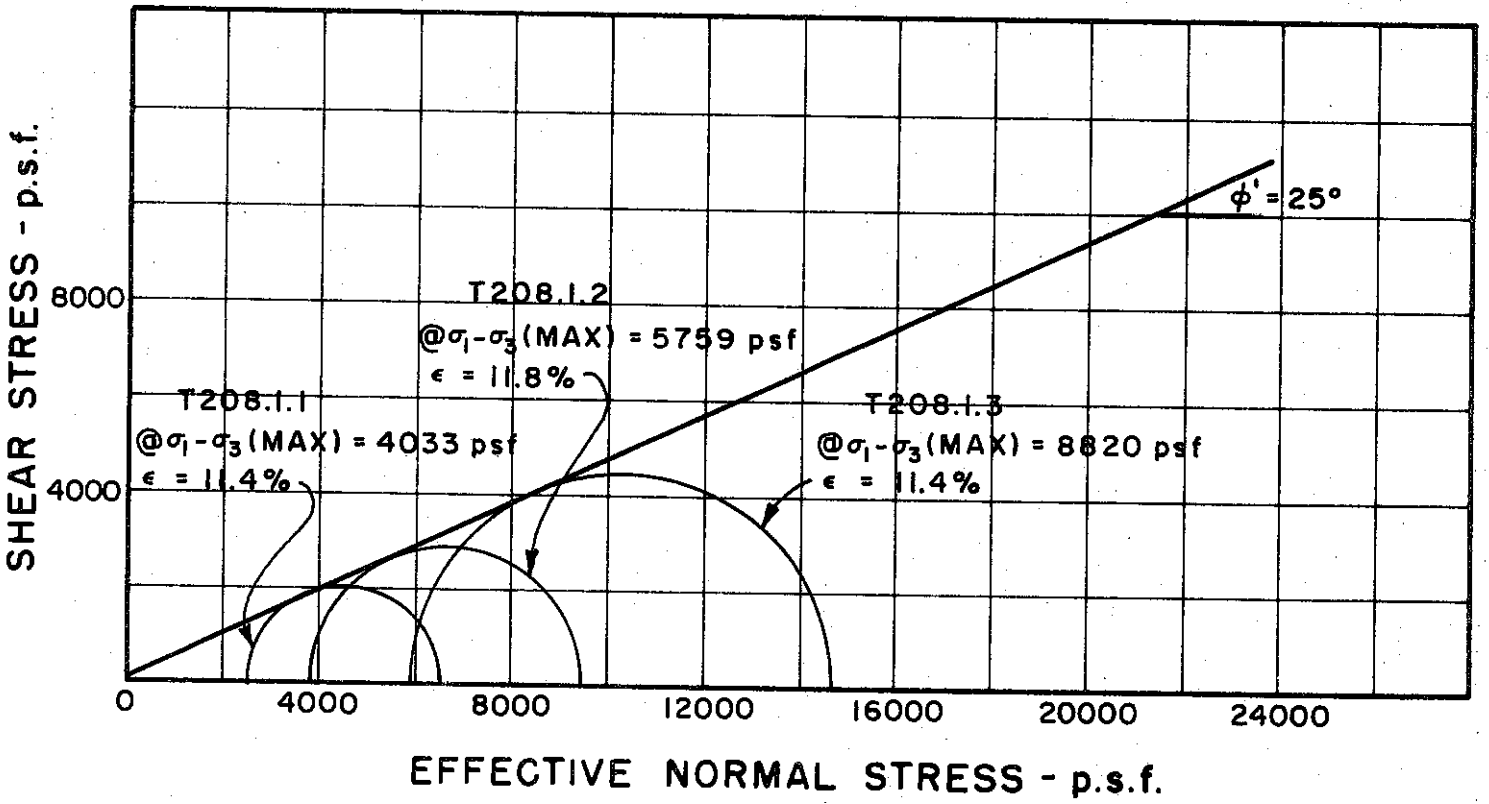
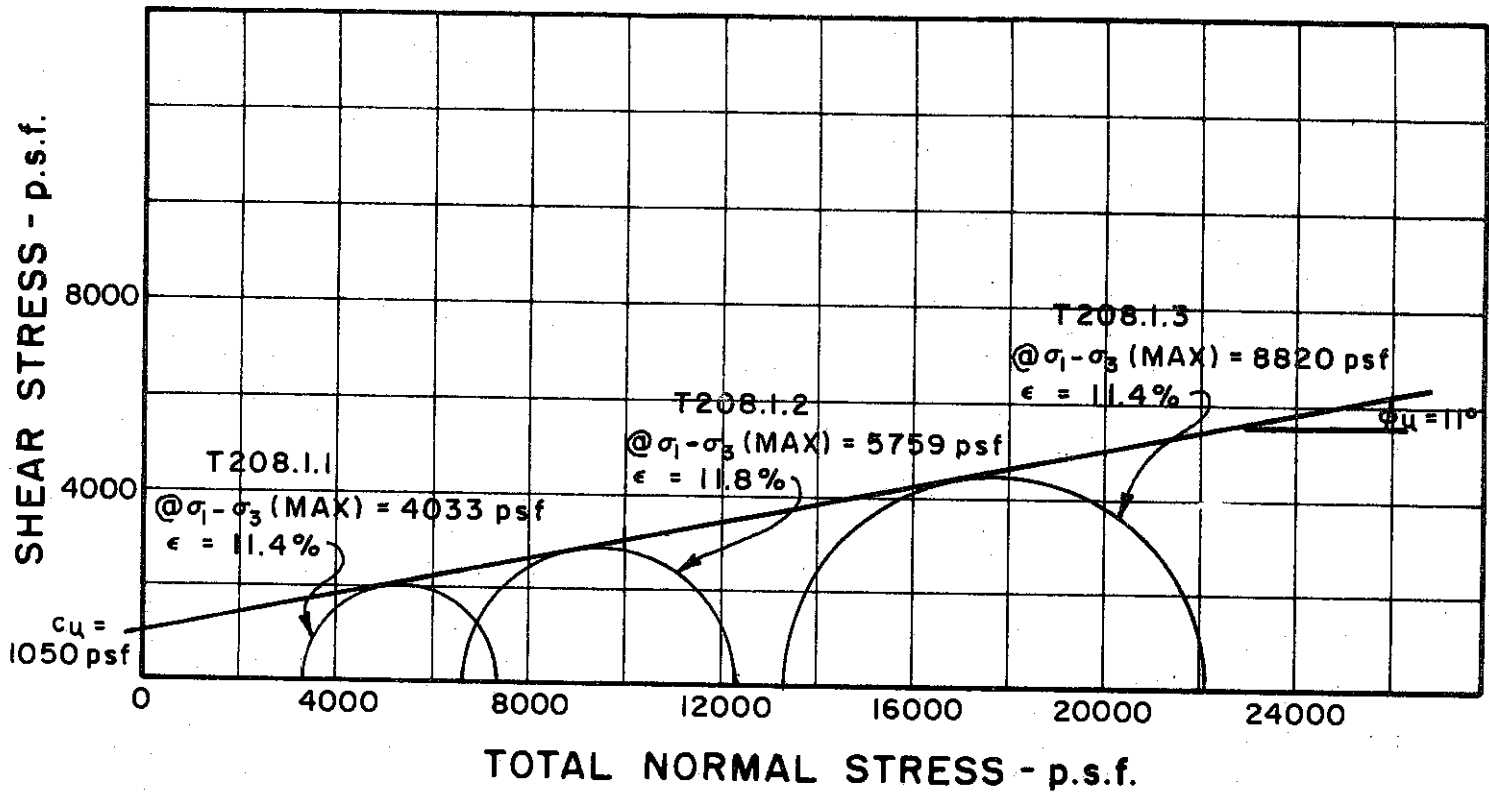

BORING NO. 48
 SAMPLE NO. 22
 DEPTH 98.0' TO 100.0'

MOHR STRENGTH ENVELOPE
 TRIAXIAL COMPRESSION
 TESTS

REMARKS ENVELOPE IS INTERPRETIVE,
BASED ON LIMITED DATA POINTS
AVAILABLE

 GOLDBERG-ZOINO AND ASSOCIATES, INC.
 CONSULTANTS IN GEOTECHNICAL ENGINEERING

THE DETROIT EDISON COMPANY
 BELLE RIVER PLANT UNITS I & II
 FILE 1255
 C-407

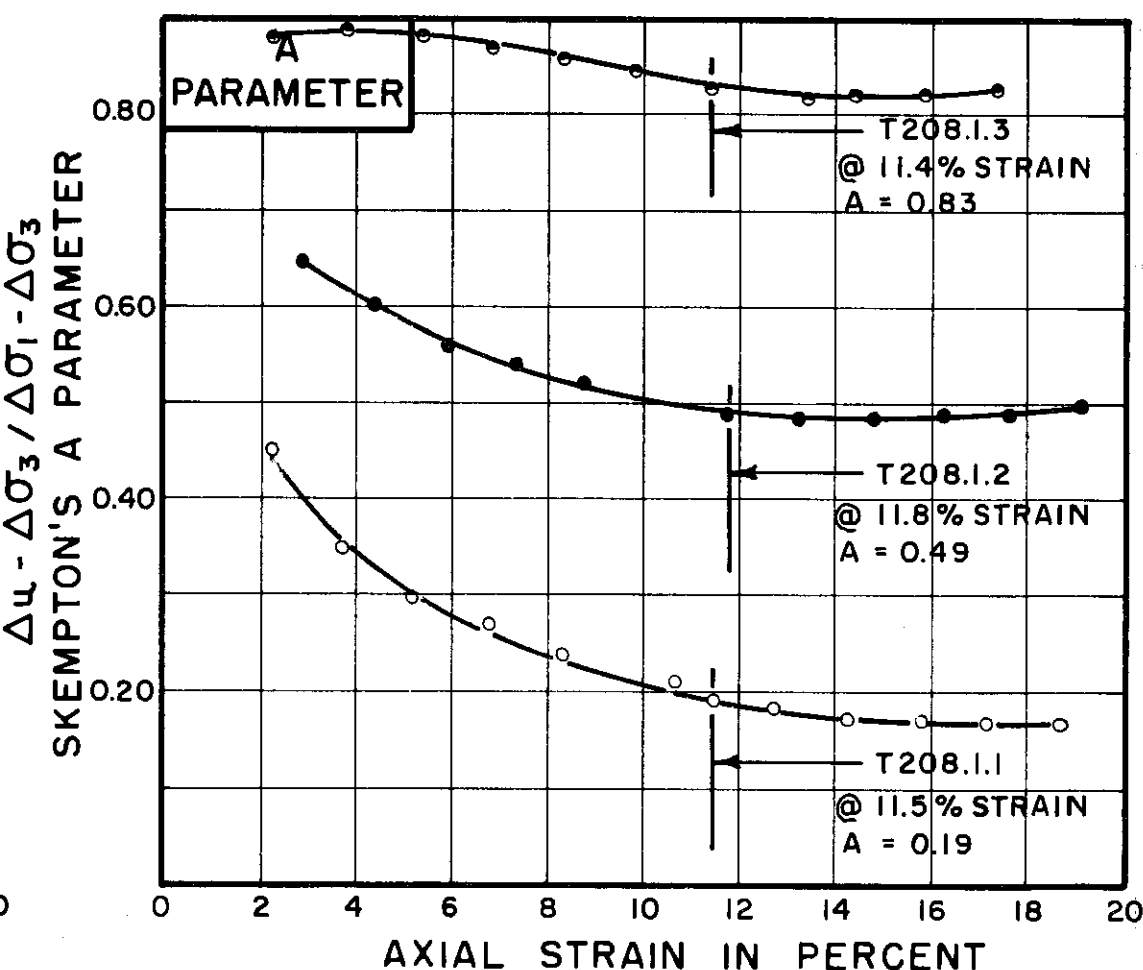
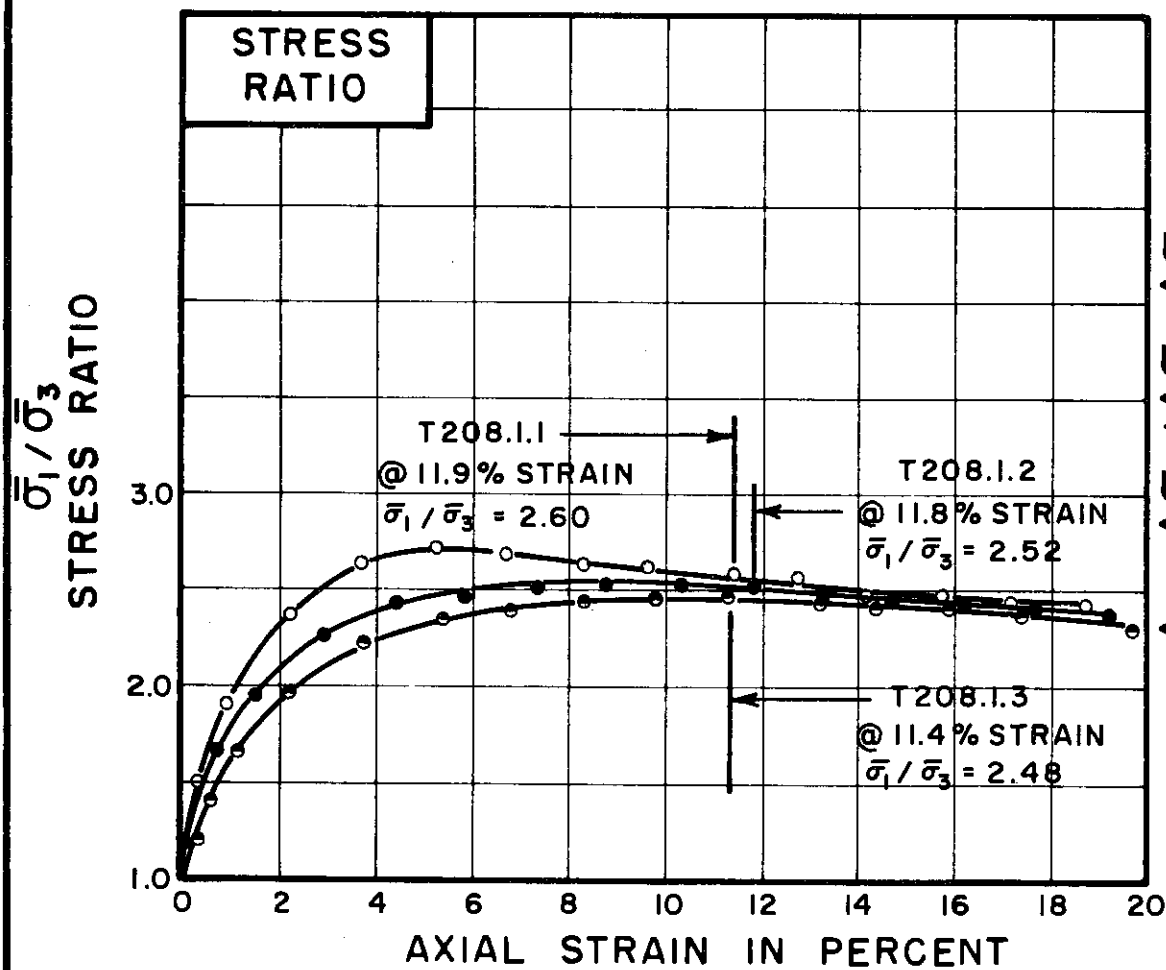
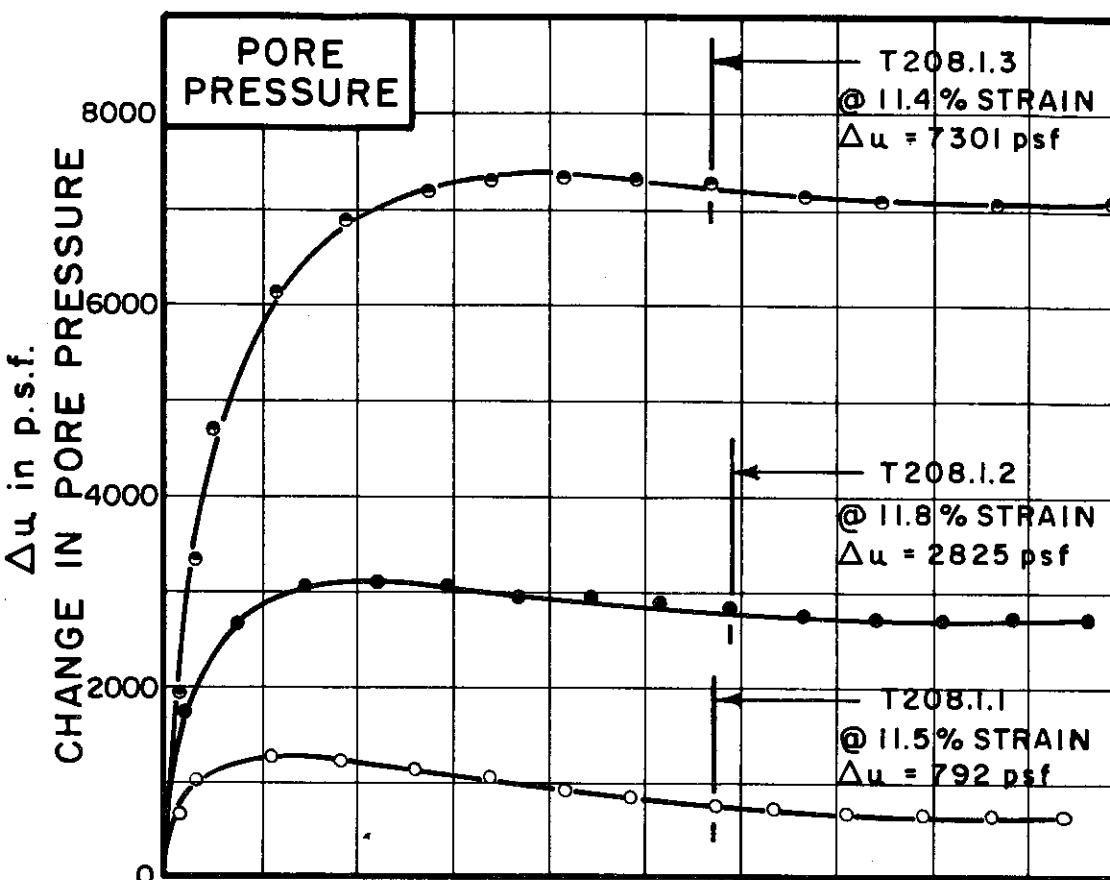
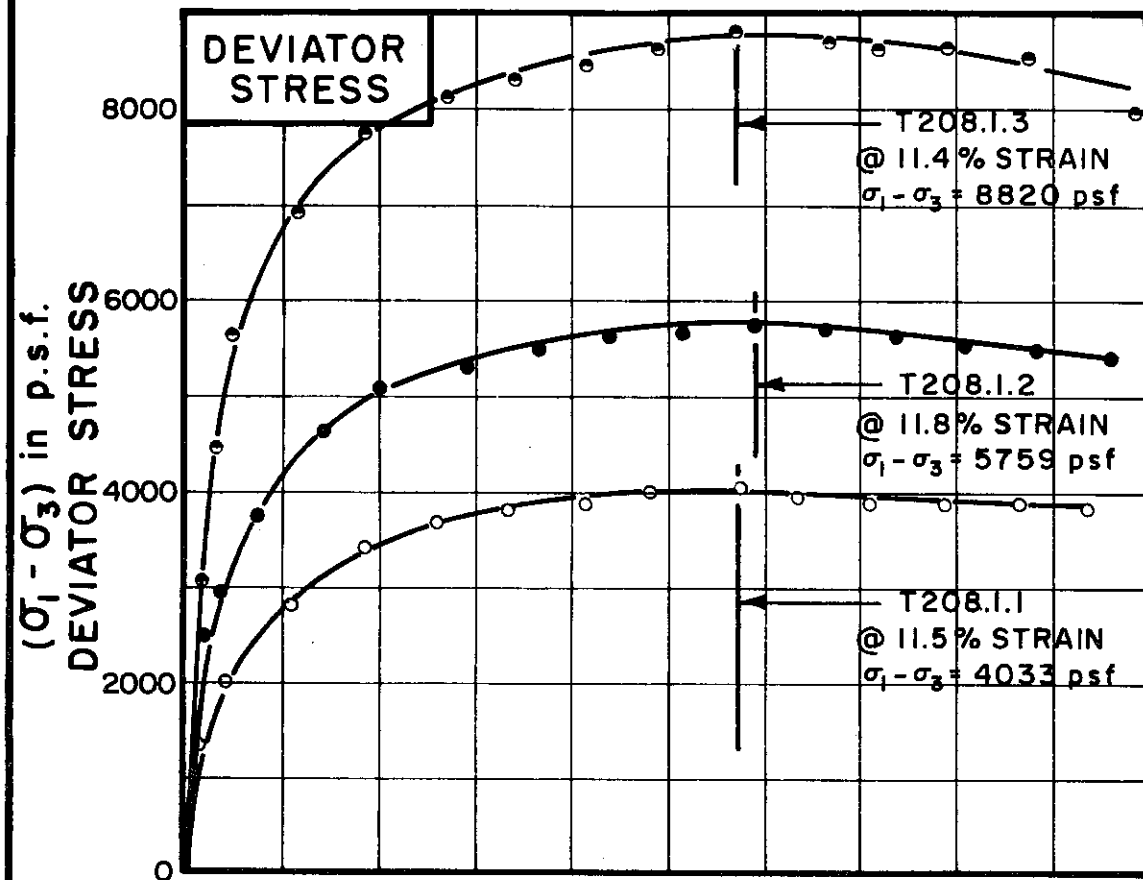

TEST NO. / SYMBOL	T208.1.1	T208.1.2	T208.1.3
	○	●	○

INITIAL CONDITIONS			T208.1.1	T208.1.2	T208.1.3
WATER CONTENT	w ₀		26.8%	26.0%	27.6%
DRY DENSITY	γ _d	pcf	99	96	97
SAMPLE DIAMETER	D ₀	in.	1.40	1.40	1.40
SAMPLE HEIGHT	H ₀	in.	3.36	3.44	3.32
FINAL CONDITIONS BEFORE SHEAR			T208.1.1	T208.1.2	T208.1.3
FINAL BACK PRESSURE	u ₀	p.s.f.	8640	11520	7200
INITIAL EFFECTIVE STRESS	σ̄ ₁ / σ̄ ₃	p.s.f.	3312	6624	13248
VOLUMETRIC STRAIN	ε _{vol}		3.0%	5.2%	7.8%
PORE PRESSURE RESPONSE			95%	94%	98%
FINAL CONDITIONS			T208.1.1	T208.1.2	T208.1.3
WATER CONTENT	w _f		25.3%	23.7%	22.8%
SKETCH OF SAMPLE AT END OF TEST					

RATE OF STRAIN PERCENT/MINUTE	.024	.023	.024
-------------------------------	------	------	------

BORING NO. 48
 SAMPLE NO. 22
 DEPTH 98.0' TO 100.0'
 SOIL DESCRIPTION SILTY CLAY (CL)
 LIQUID LIMIT 36 PLASTIC LIMIT 19

CONSOLIDATED UNDRAINED
 TRIAXIAL COMPRESSION
 TESTS
 THE DETROIT EDISON COMPANY
 BELLE RIVER PLANT UNITS I & II

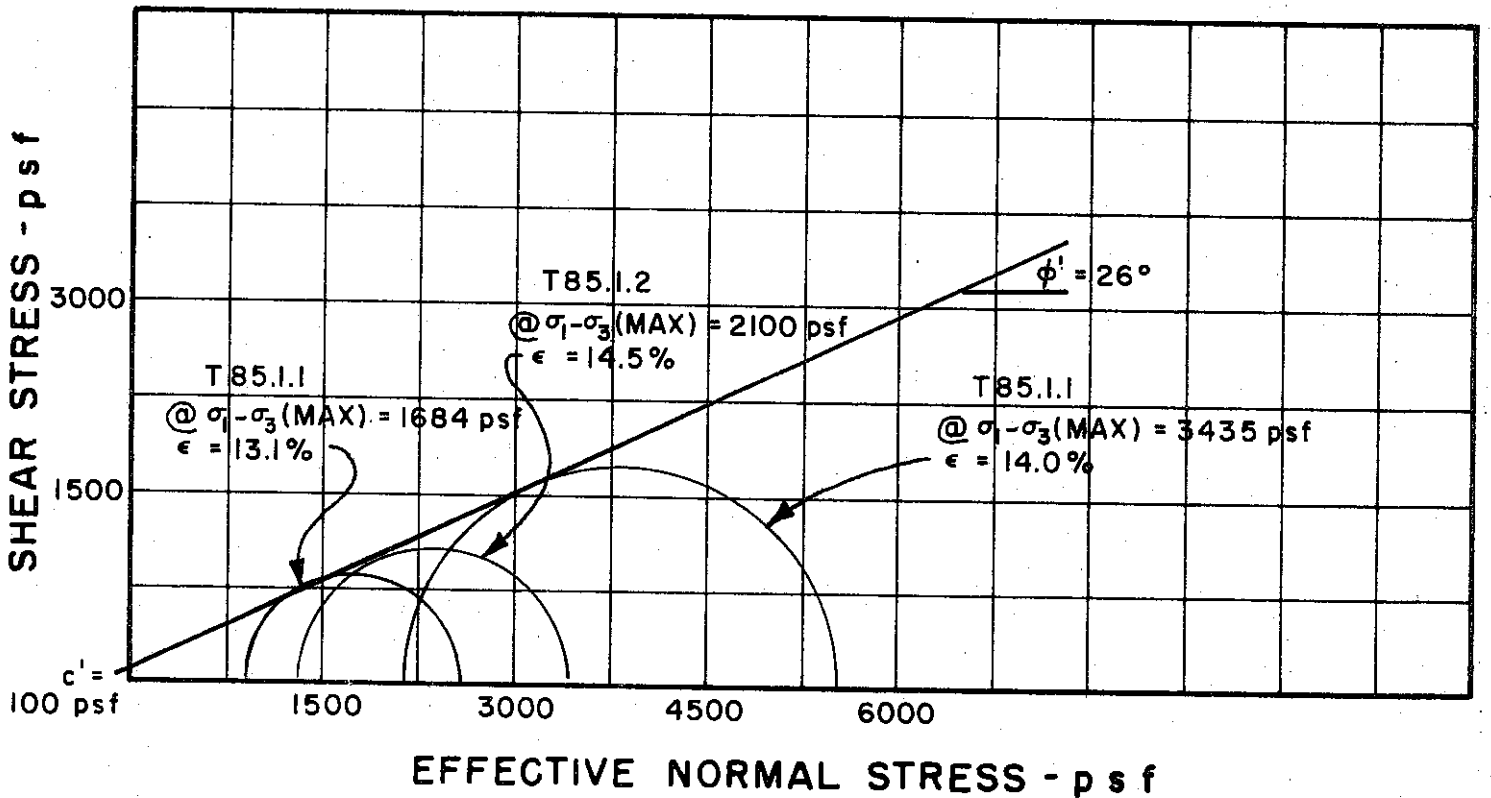
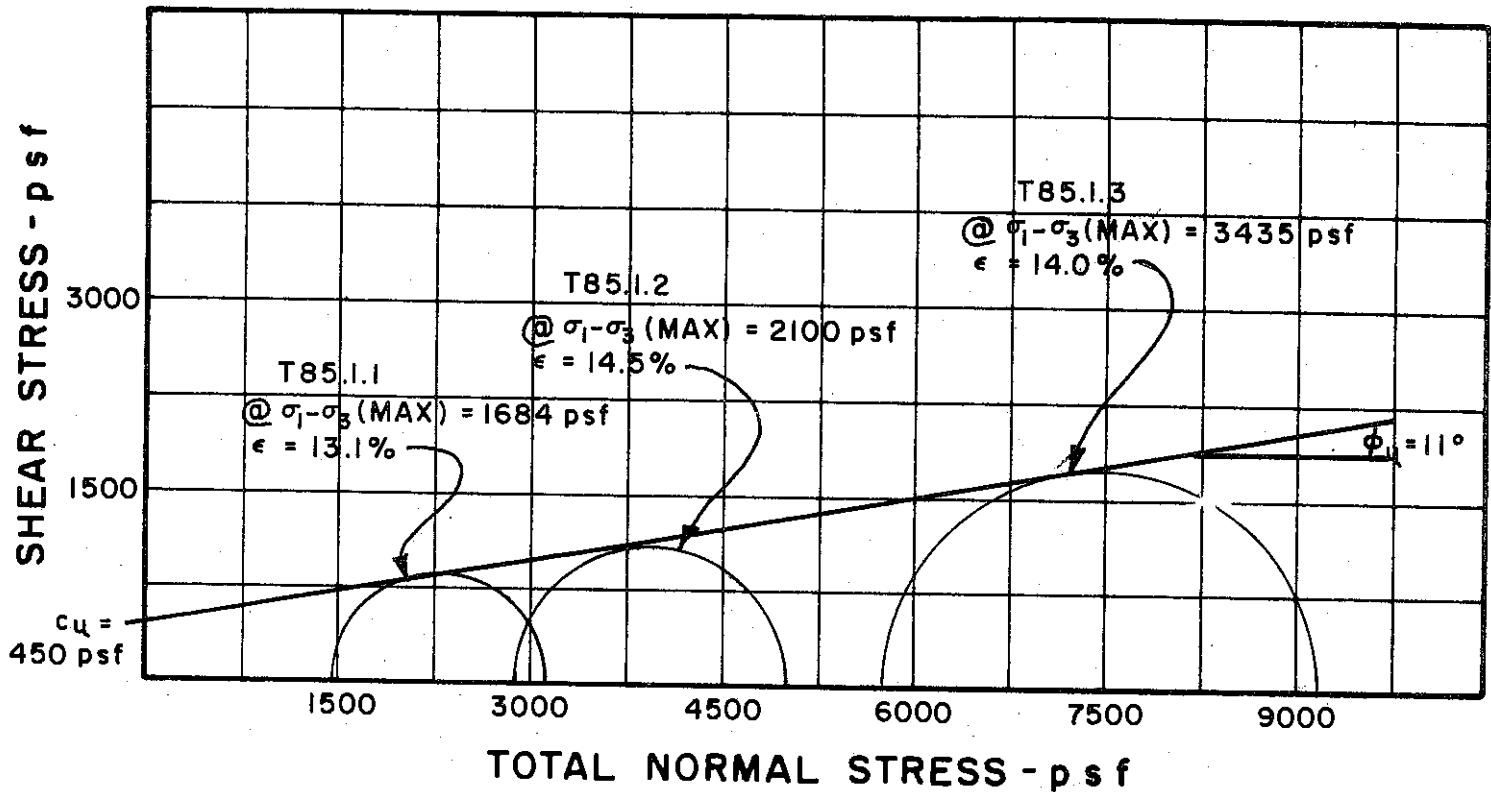

BORING NO. 50

SAMPLE NO. 6

DEPTH 28.0' TO 30.0'

REMARKS ENVELOPE IS INTERPRETIVE,
BASED ON LIMITED DATA POINTS
AVAILABLE

GOLDBERG-ZOINO AND ASSOCIATES, INC.
 CONSULTANTS IN GEOTECHNICAL ENGINEERING

MOHR STRENGTH ENVELOPE
 TRIAXIAL COMPRESSION
 TESTS

THE DETROIT EDISON COMPANY
 BELLE RIVER PLANT UNITS I & II

FILE 1255

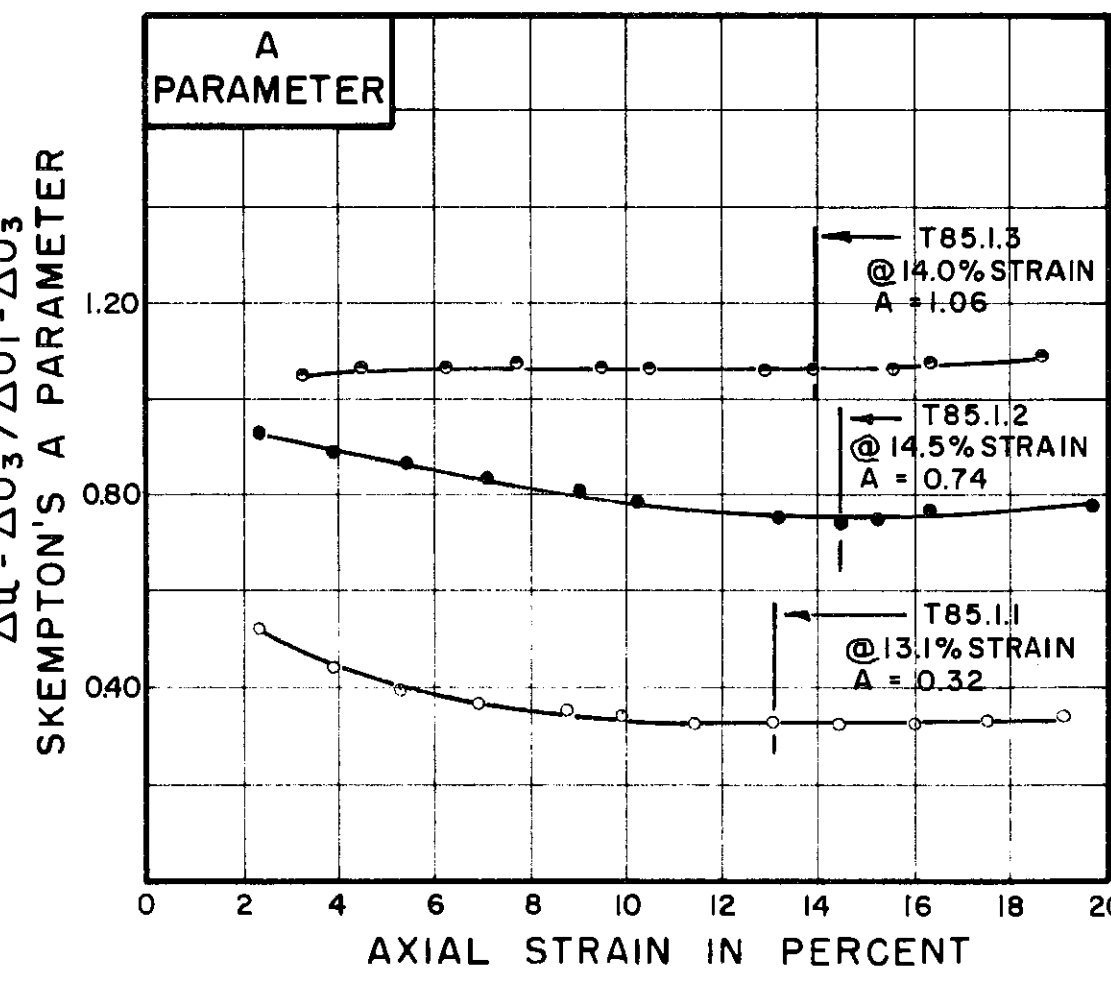
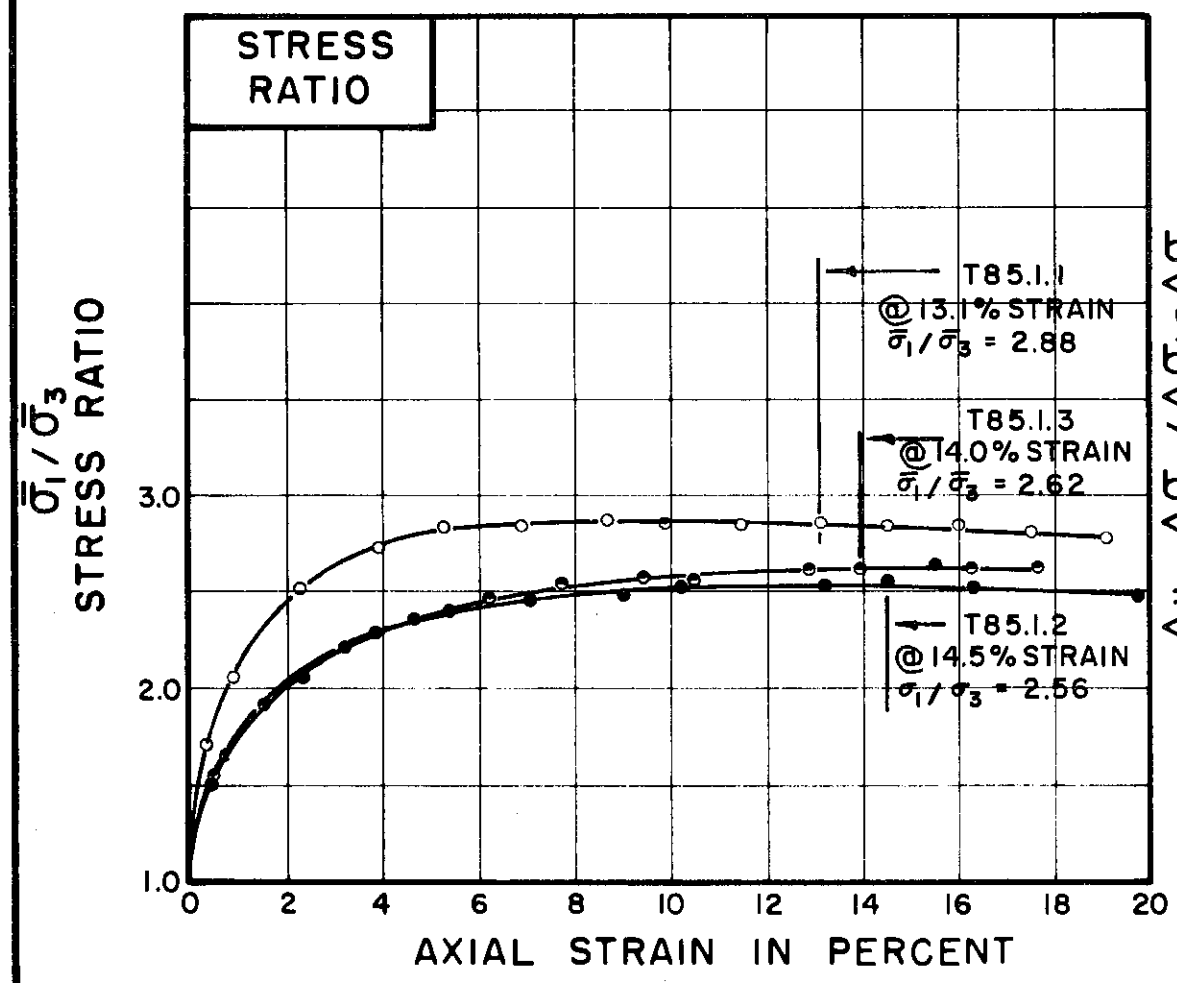
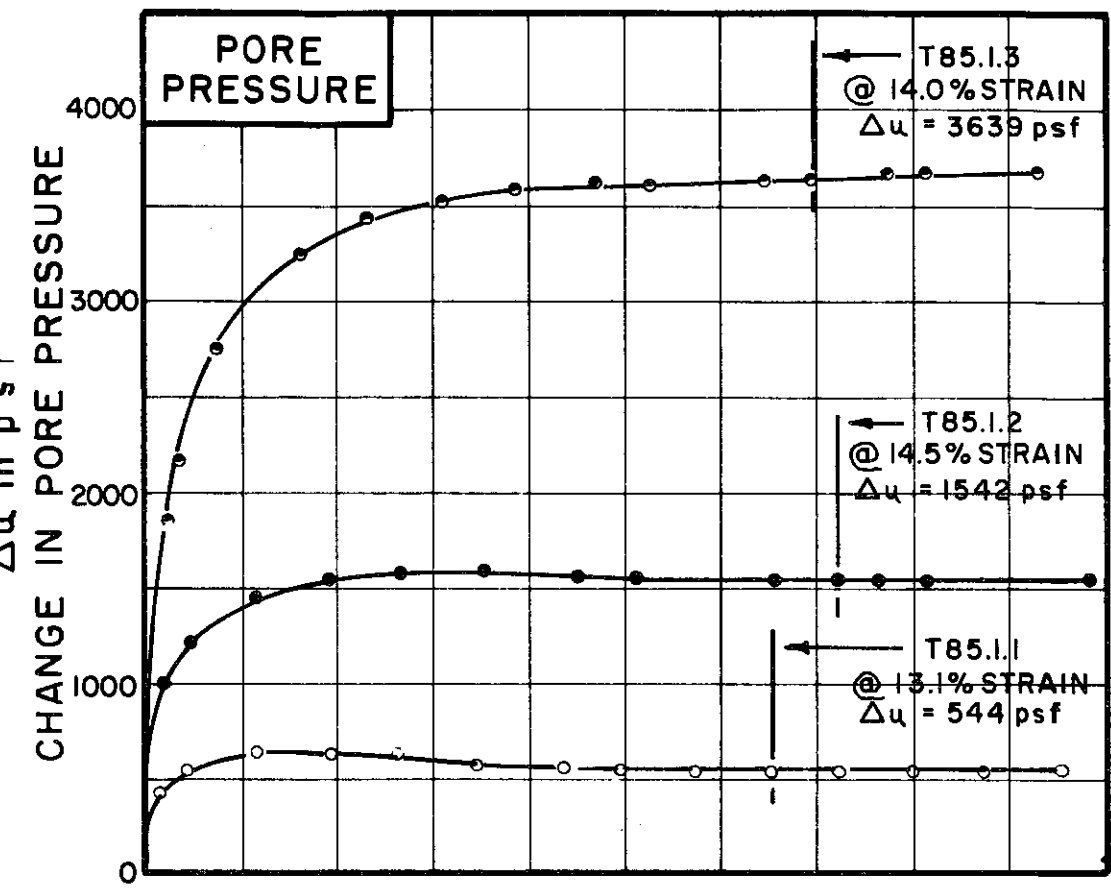
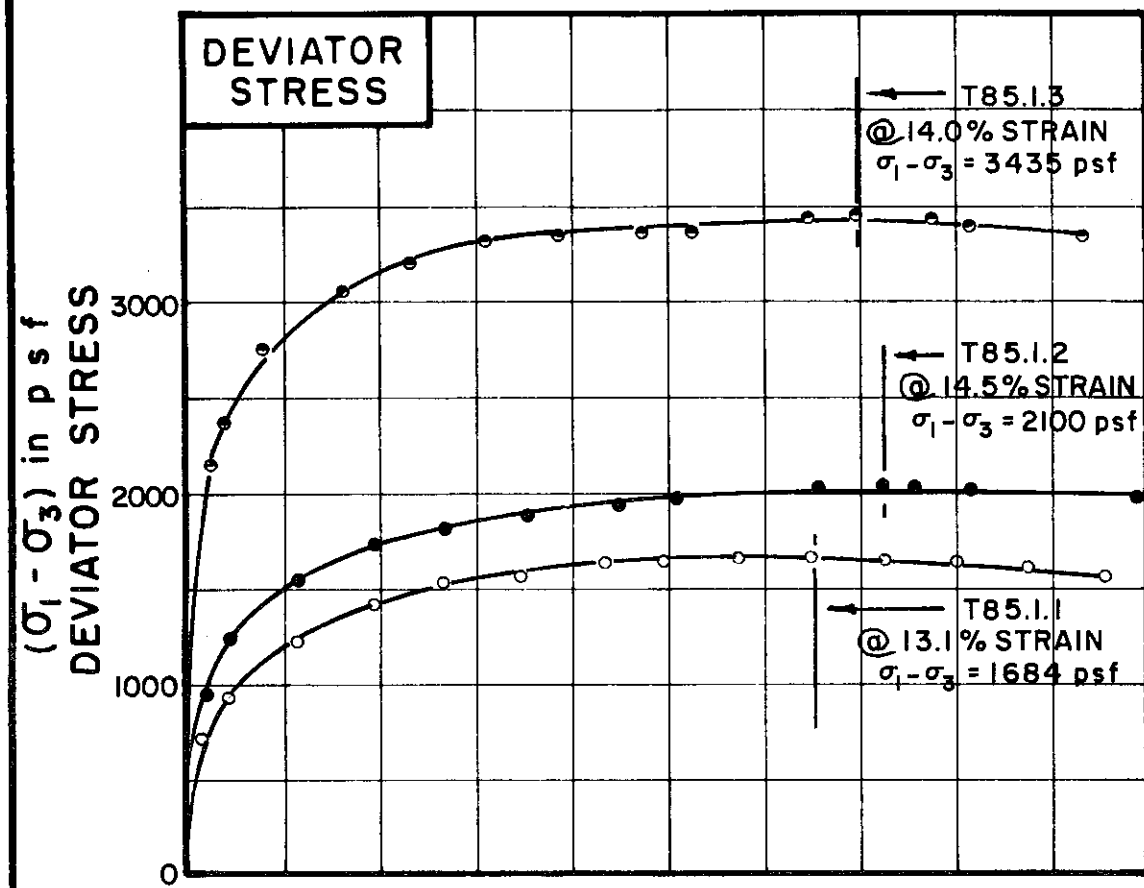

TEST NO. / SYMBOL	T85.1.1	T85.1.2	T85.1.3
-------------------	---------	---------	---------

INITIAL CONDITIONS	WATER CONTENT	w_0	33.0%	33.1%	34.3%
	DRY DENSITY lb/cu ft	γ_d	88	90	86
SAMPLE DIAMETER in.	D_0	1.38	1.39	1.39	
SAMPLE HEIGHT in.	H_0	3.30	3.25	3.27	
FINAL CONDITIONS BEFORE SHEAR	FINAL BACK PRESSURE psf	u_0	10,080	10,080	10,080
	INITIAL EFFECTIVE STRESS psf	$\bar{\sigma}_1, \bar{\sigma}_3$	1440	2880	5760
	VOLUMETRIC STRAIN	ϵ_{vol}	2.58%	3.18%	4.86%
	PORE PRESSURE RESPONSE	96%	95%	100%	
FINAL CONDITIONS	WATER CONTENT	w_f	31.5%	27.3%	28.5%
	SKETCH OF SAMPLE AT END OF TEST				

RATE OF STRAIN PERCENT/MINUTE	.025	.025	.024
-------------------------------	------	------	------

BORING NO. 50
 SAMPLE NO. 6
 DEPTH 28.0' TO 30.0'
 SOIL DESCRIPTION SILTY CLAY (CL)
 LIQUID LIMIT 39 PLASTIC LIMIT 18

CONSOLIDATED UNDRAINED
 TRIAXIAL COMPRESSION
 TESTS

THE DETROIT EDISON COMPANY
 BELLE RIVER PLANT UNITS I & II

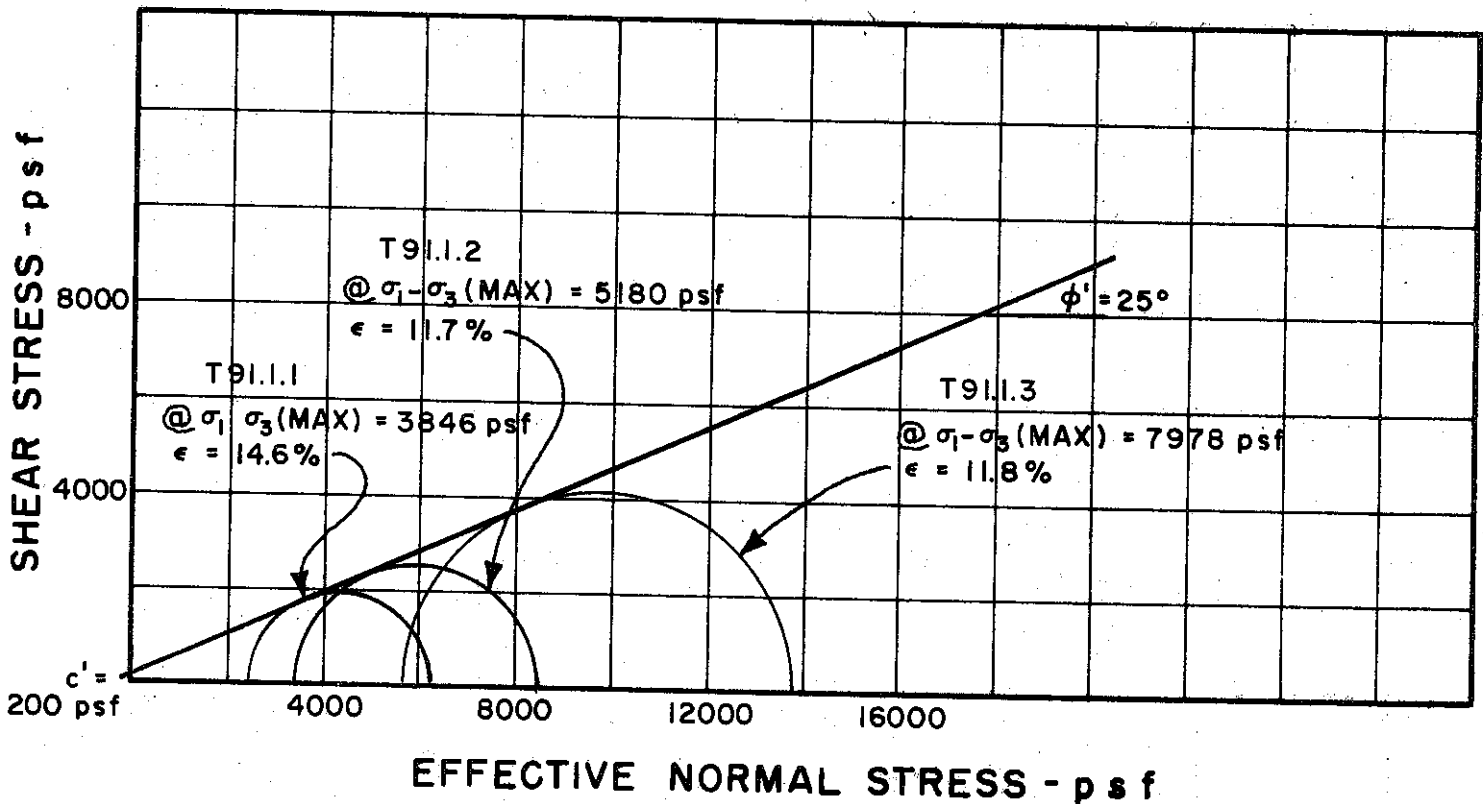
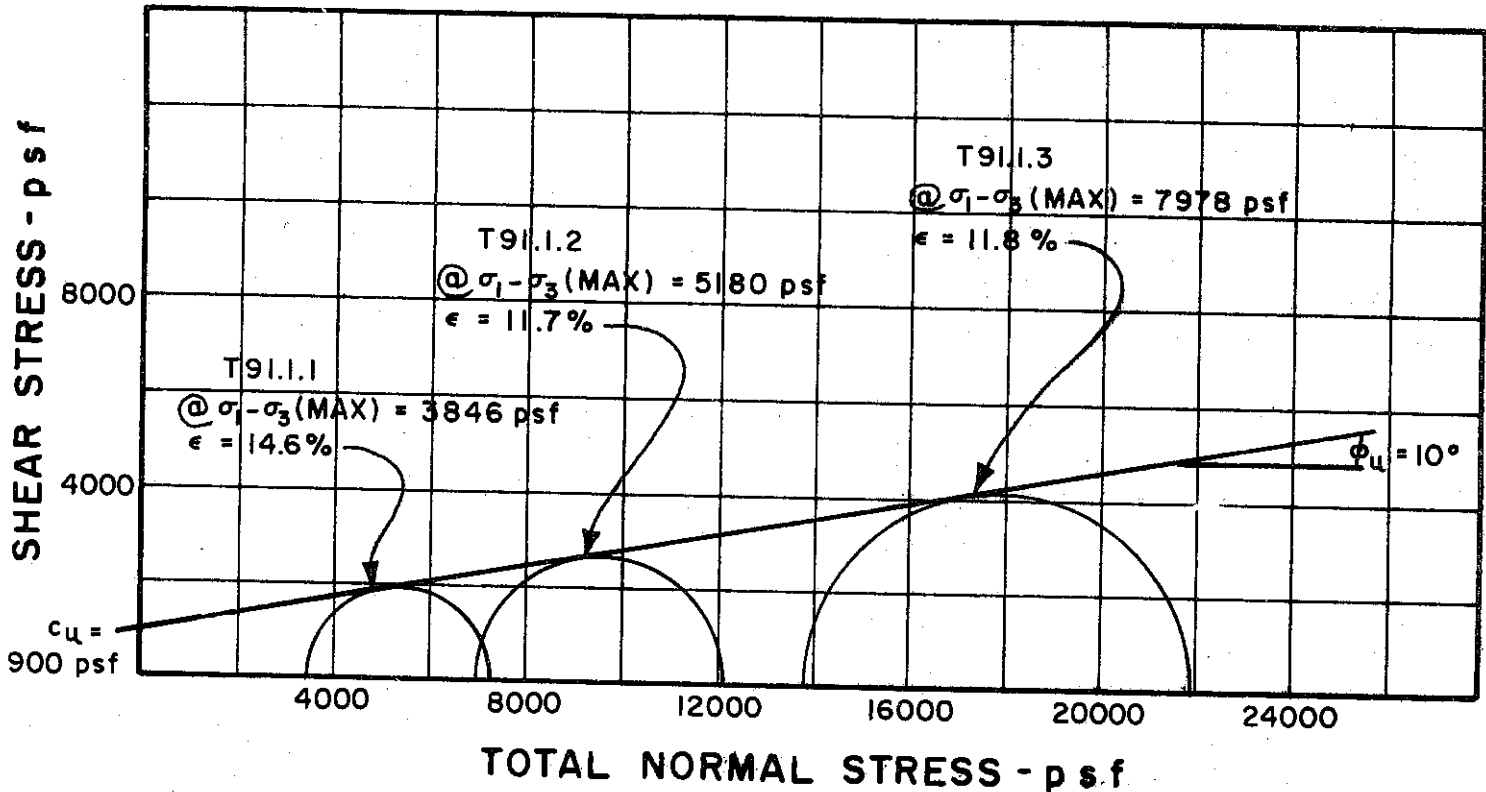

BORING NO. 50

SAMPLE NO. 18

DEPTH 88.0' TO 90.0'

REMARKS ENVELOPE IS INTERPRETIVE,
BASED ON LIMITED DATA POINTS
AVAILABLE

GOLDBERG-ZOINO AND ASSOCIATES, INC.
 CONSULTANTS IN GEOTECHNICAL ENGINEERING

MOHR STRENGTH ENVELOPE
 TRIAXIAL COMPRESSION
 TESTS

THE DETROIT EDISON COMPANY
 BELLE RIVER PLANT UNITS I & II

FILE 1255
 C-411

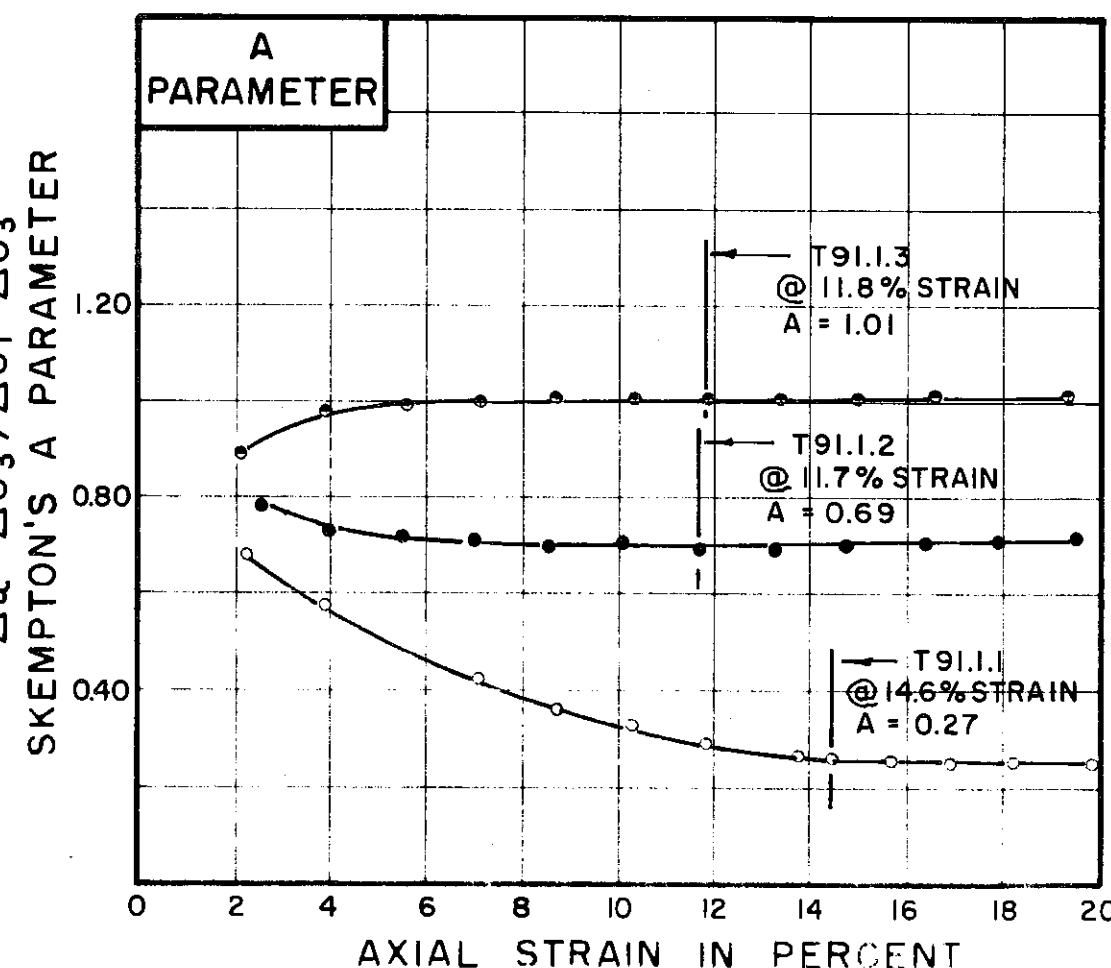
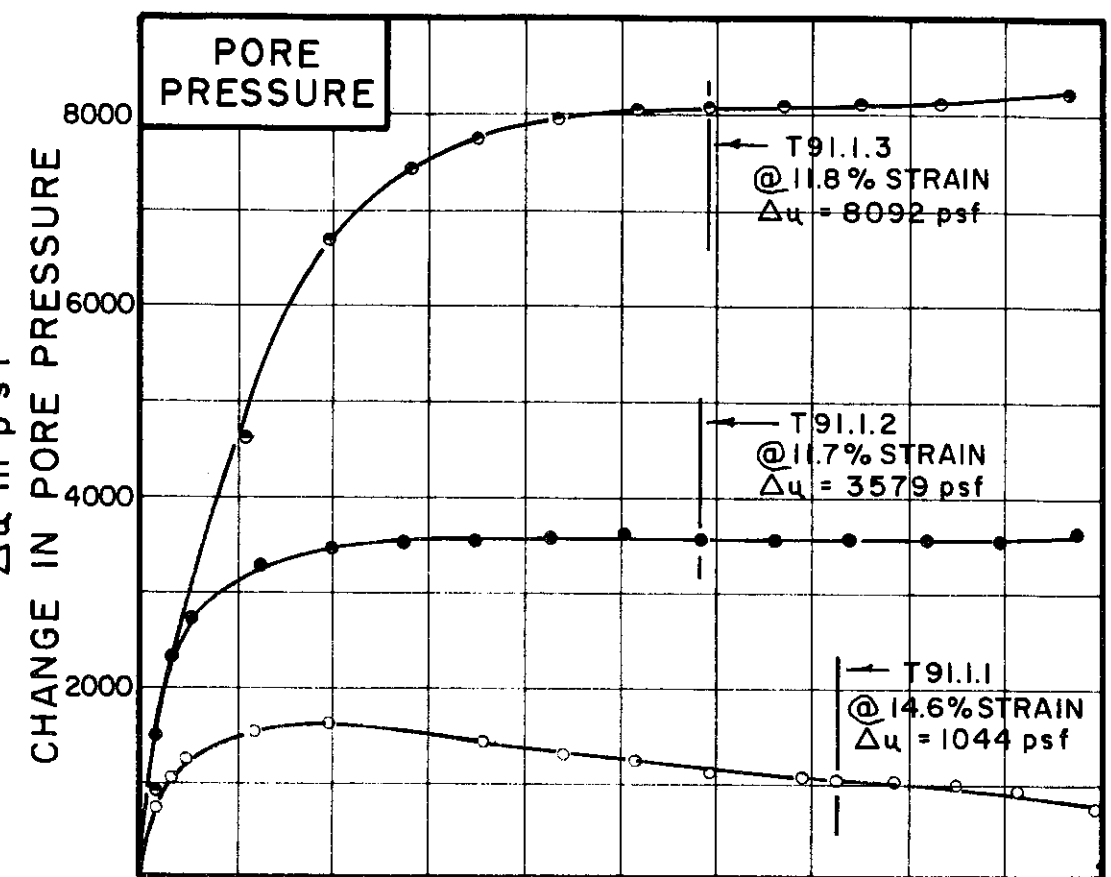
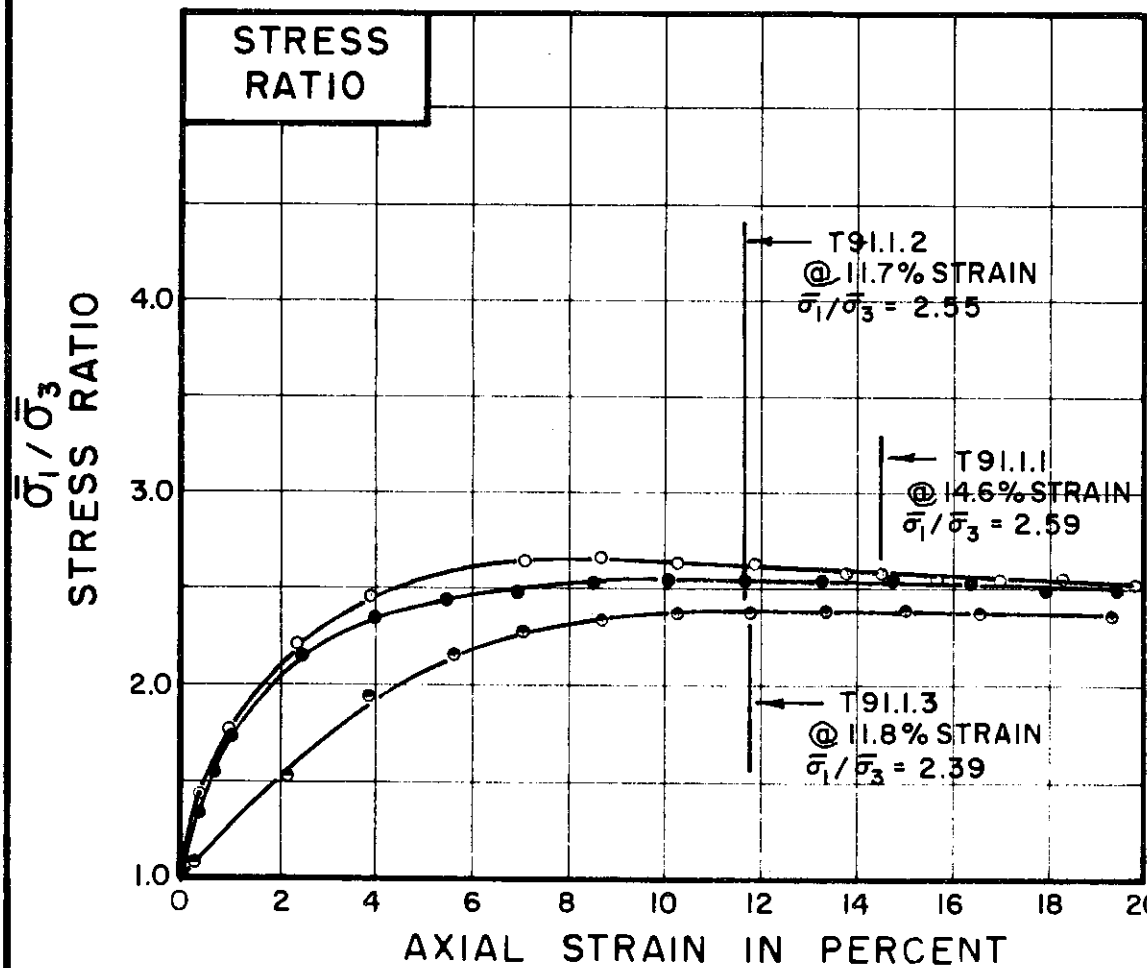
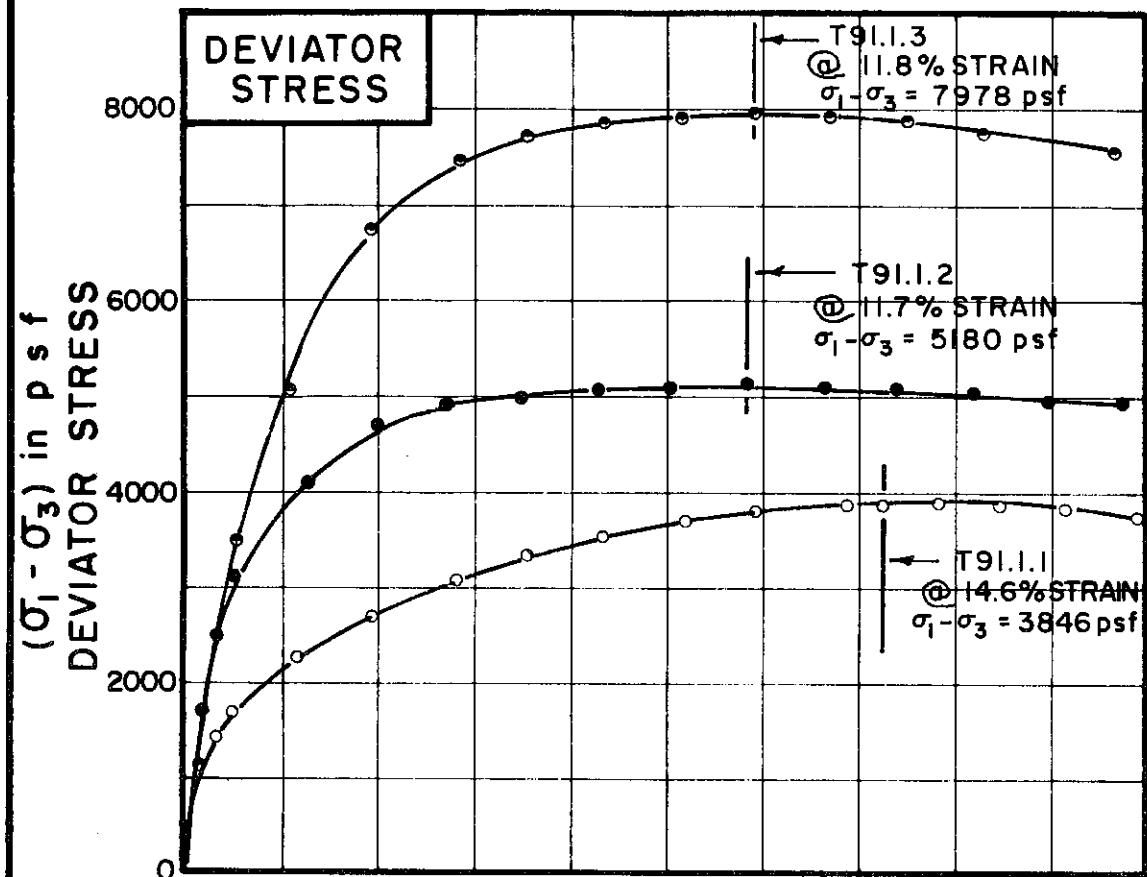

TEST NO. / SYMBOL	T91.1.1	T91.1.2	T91.1.3
-------------------	---------	---------	---------

INITIAL CONDITIONS		T91.1.1	T91.1.2	T91.1.3
WATER CONTENT	w_0	28.0%	27.6%	27.6%
DRY DENSITY	γ_d lb/cu ft	97	97	96
SAMPLE DIAMETER	D_0 in.	1.37	1.38	1.41
SAMPLE HEIGHT	H_0 in.	3.18	3.25	3.25
FINAL CONDITIONS BEFORE SHEAR				
FINAL BACK PRESSURE	u_0 psf	8640	8640	12960
INITIAL EFFECTIVE STRESS	σ_1', σ_3' psf	3456	6912	13824
VOLUMETRIC STRAIN	ϵ_{vol}	3.54%	4.24%	6.87%
PORE PRESSURE RESPONSE		96%	95%	96%
FINAL CONDITIONS				
WATER CONTENT	w_f	25.5%	26.0%	22.7%
SKETCH OF SAMPLE AT END OF TEST				

RATE OF STRAIN PERCENT / MINUTE	.025	.025	.025
---------------------------------	------	------	------

BORING NO. 50
 SAMPLE NO. 18
 DEPTH 88.0' TO 90.0'

SOIL DESCRIPTION SILTY CLAY, SANDY (CL)

LIQUID LIMIT 39 PLASTIC LIMIT 23

CONSOLIDATED UNDRAINED
 TRIAXIAL COMPRESSION
 TESTS

THE DETROIT EDISON COMPANY
 BELLE RIVER PLANT UNITS I & II

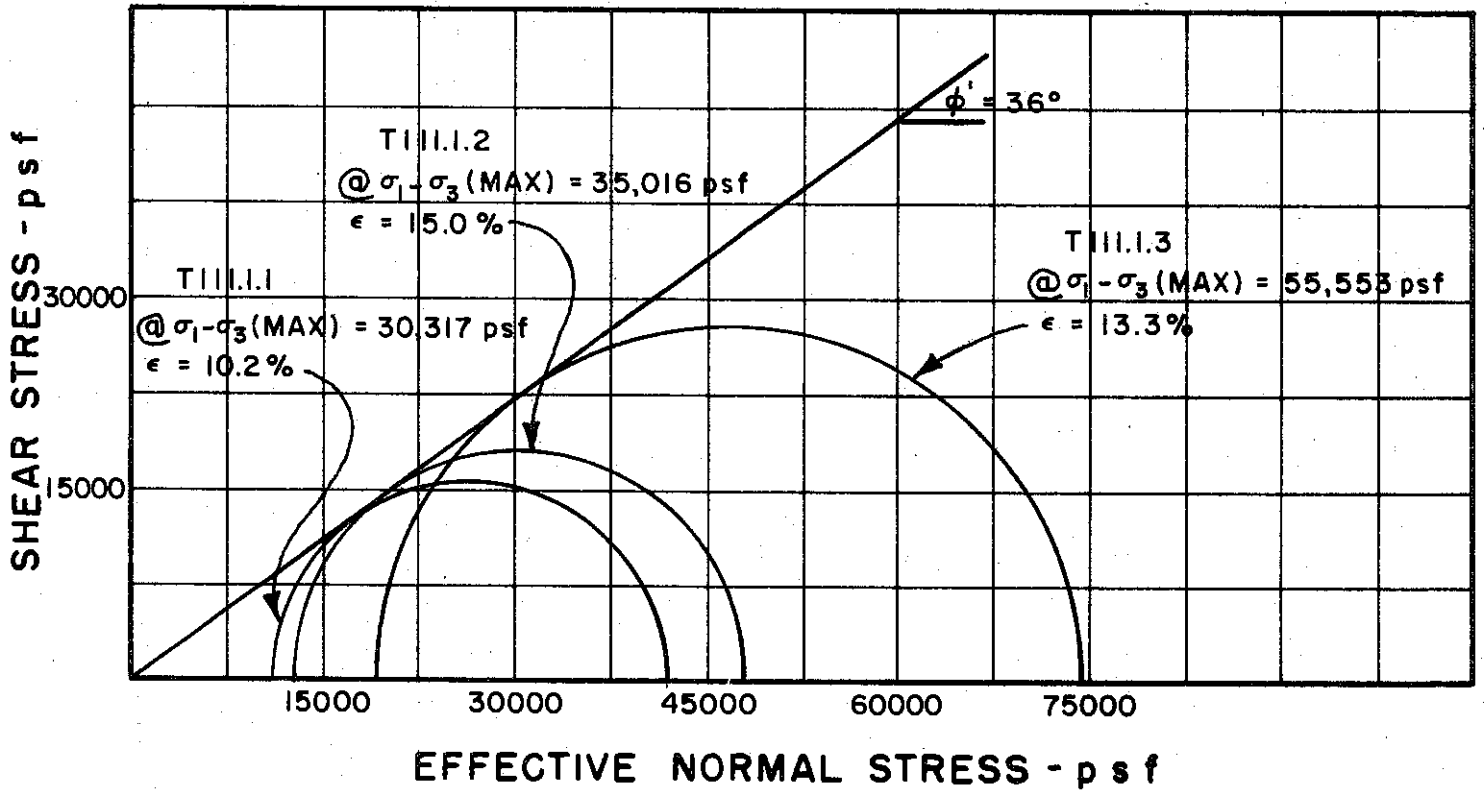
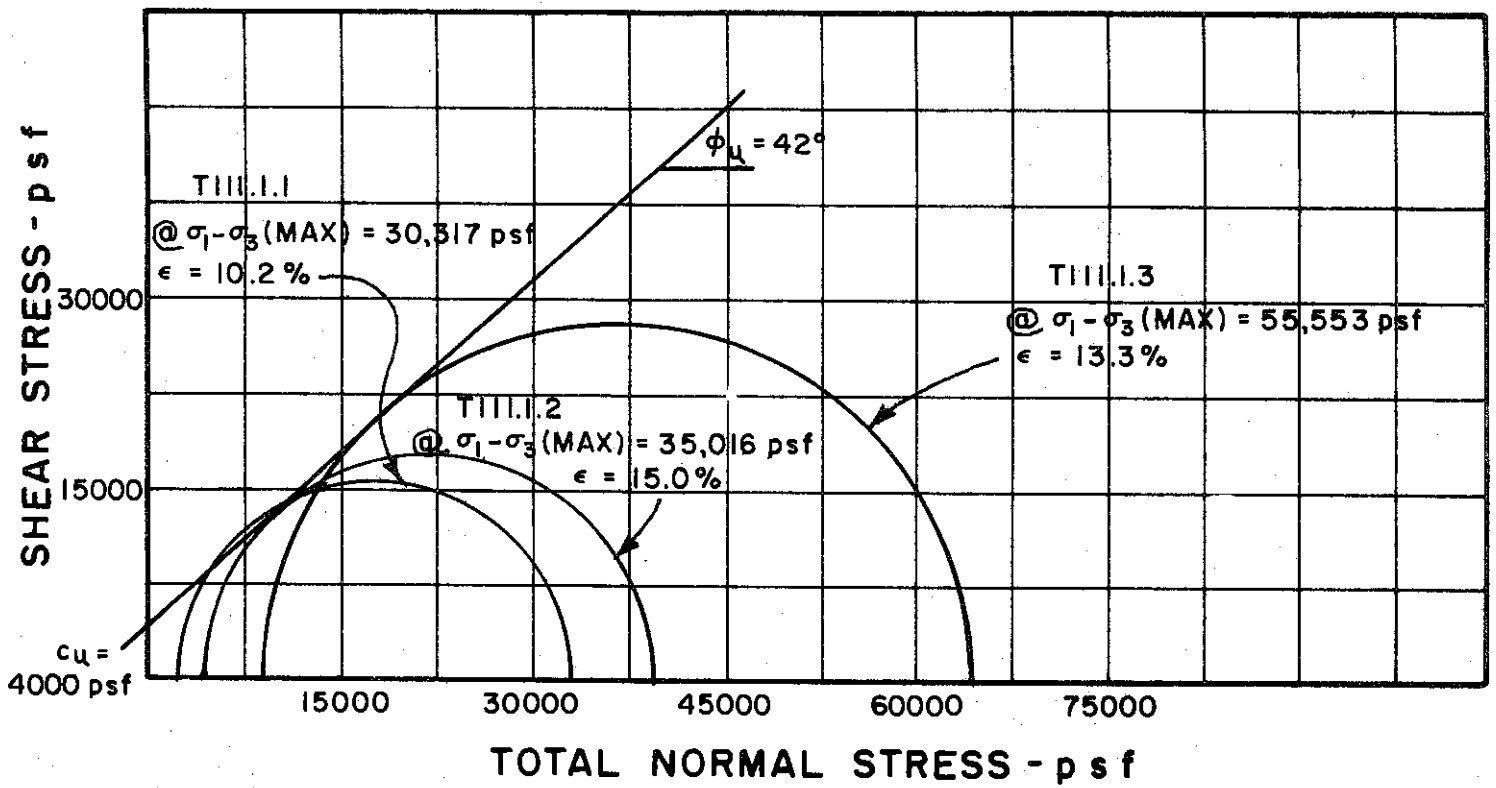

BORING NO. 52

SAMPLE NO. 6

DEPTH 48.0' TO 50.5'

REMARKS ENVELOPE IS INTERPRETIVE,
BASED ON LIMITED DATA POINTS
AVAILABLE

GOLDBERG-ZOINO AND ASSOCIATES, INC.
 CONSULTANTS IN GEOTECHNICAL ENGINEERING

MOHR STRENGTH ENVELOPE
 TRIAXIAL COMPRESSION
 TESTS

THE DETROIT EDISON COMPANY
 BELLE RIVER PLANT UNITS I & II

FILE 1255

C-413

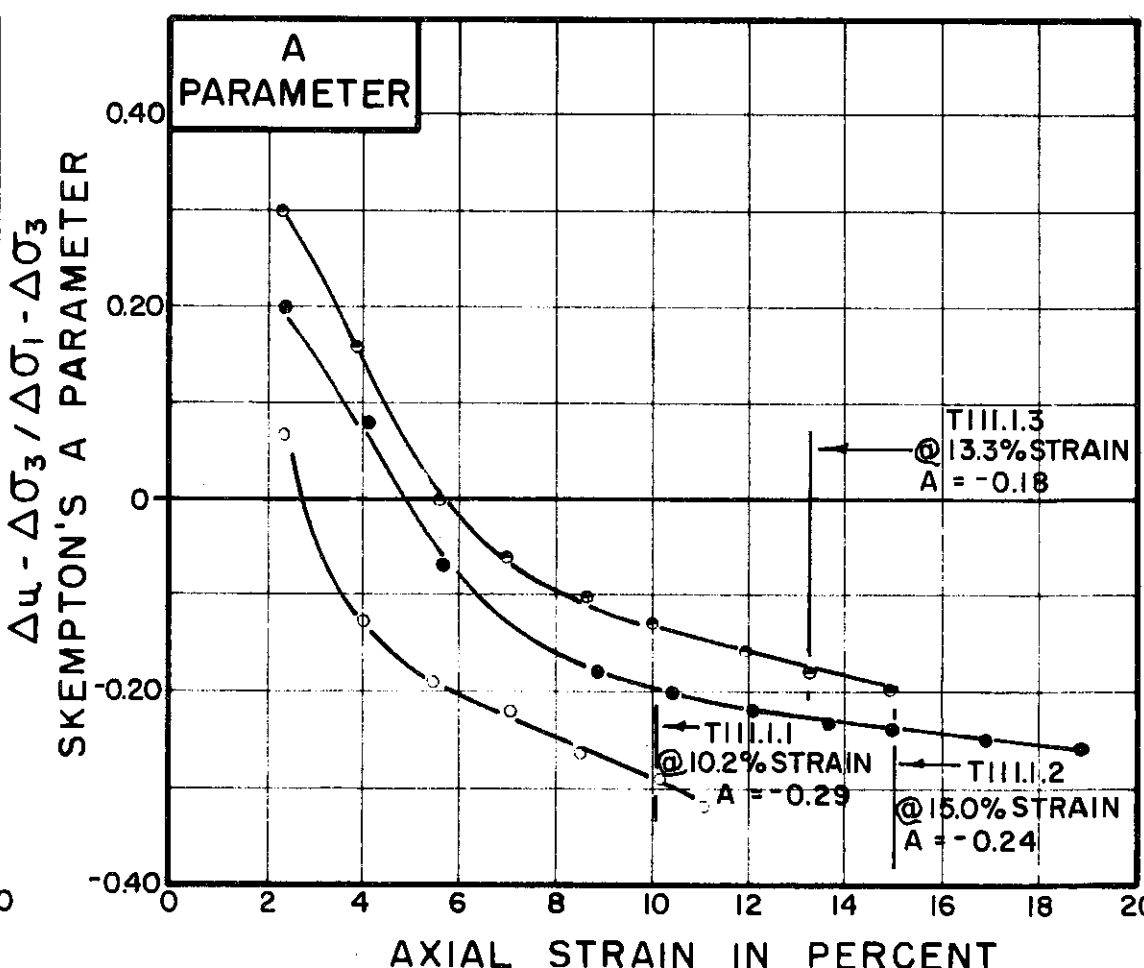
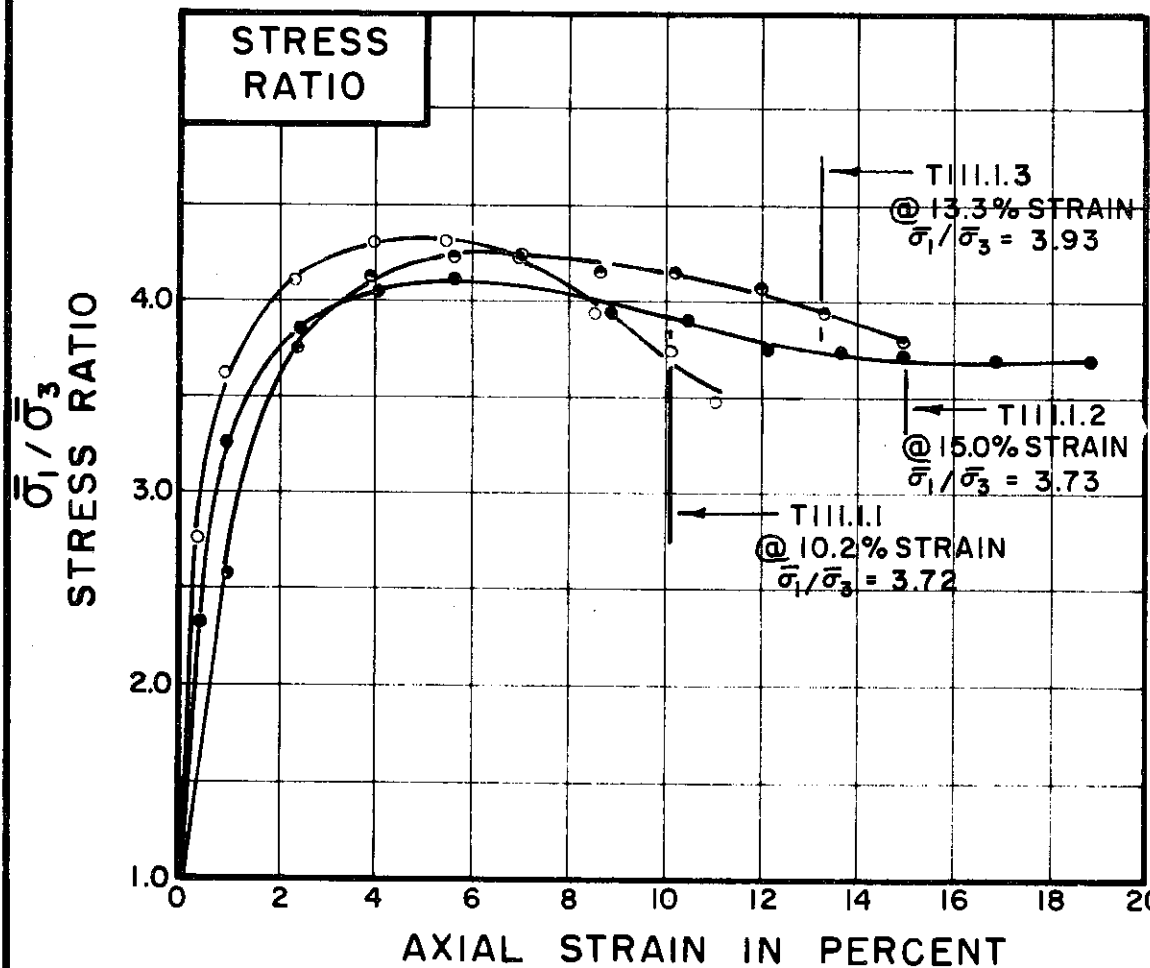
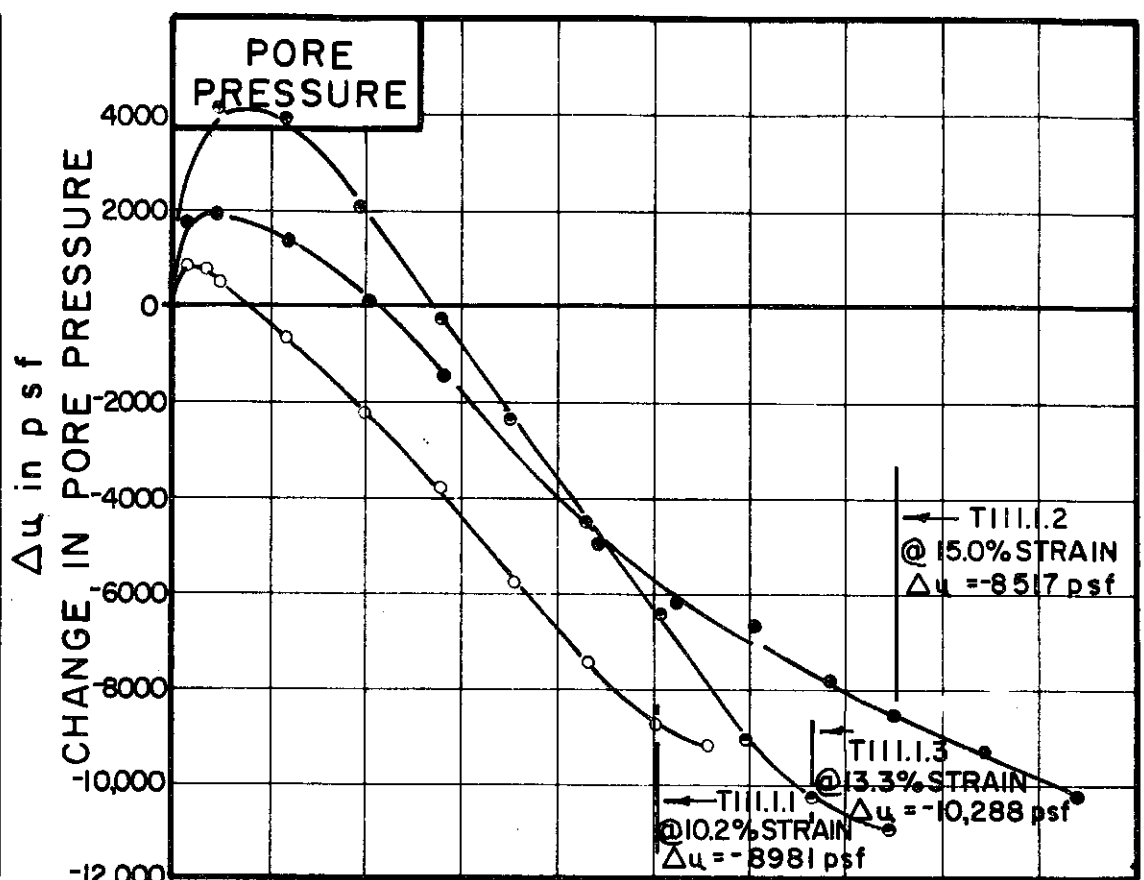
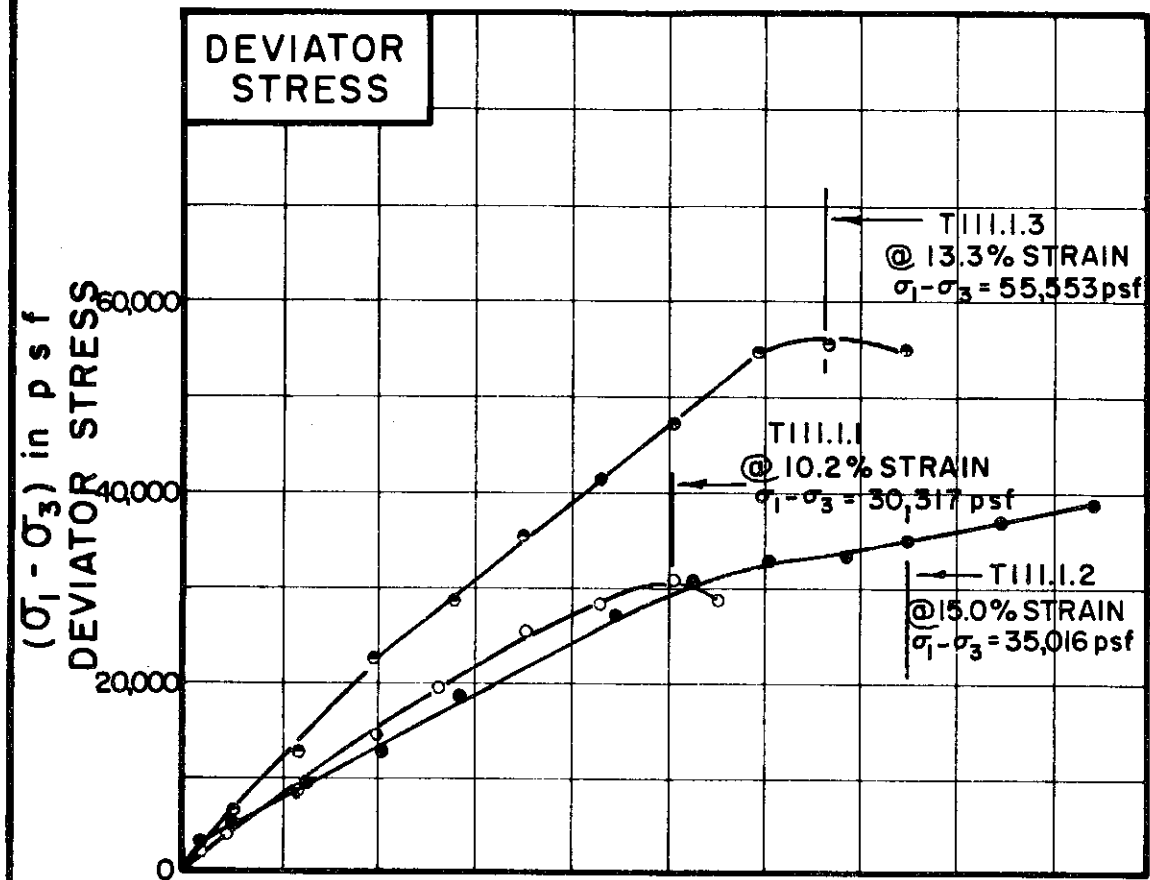

TEST NO. / SYMBOL	TIII.I.1	TIII.I.2	TIII.I.3
-------------------	----------	----------	----------

INITIAL CONDITIONS		TIII.I.1	TIII.I.2	TIII.I.3
WATER CONTENT	w_0	22.1%	22.7%	22.1%
DRY DENSITY	γ_d lb/cu ft	101	99	104
SAMPLE DIAMETER	D_0 in.	1.39	1.38	1.38
SAMPLE HEIGHT	H_0 in.	3.20	3.10	3.21
FINAL CONDITIONS BEFORE SHEAR		TIII.I.1	TIII.I.2	TIII.I.3
FINAL BACK PRESSURE	u_0 psf	9360	11,520	11,520
INITIAL EFFECTIVE STRESS	$\bar{\sigma}_1, \bar{\sigma}_3$ psf	2160	4320	8640
VOLUMETRIC STRAIN	ϵ_{vol}	0.62%	1.22%	1.78%
PORE PRESSURE RESPONSE		99%	97%	97%
FINAL CONDITIONS		TIII.I.1	TIII.I.2	TIII.I.3
WATER CONTENT	w_f	21.8%	21.8%	21.8%
SKETCH OF SAMPLE AT END OF TEST				

RATE OF STRAIN PERCENT/MINUTE	.025	.026	.025
-------------------------------	------	------	------

BORING NO. 52
 SAMPLE NO. 6
 DEPTH 48.0' TO 50.5'
 SOIL DESCRIPTION SILT (ML)
 LIQUID LIMIT NON-PLASTIC
 PLASTIC LIMIT PLASTIC LIMIT

CONSOLIDATED UNDRAINED TRIAXIAL COMPRESSION TESTS

THE DETROIT EDISON COMPANY
 BELLE RIVER PLANT UNITS I & II

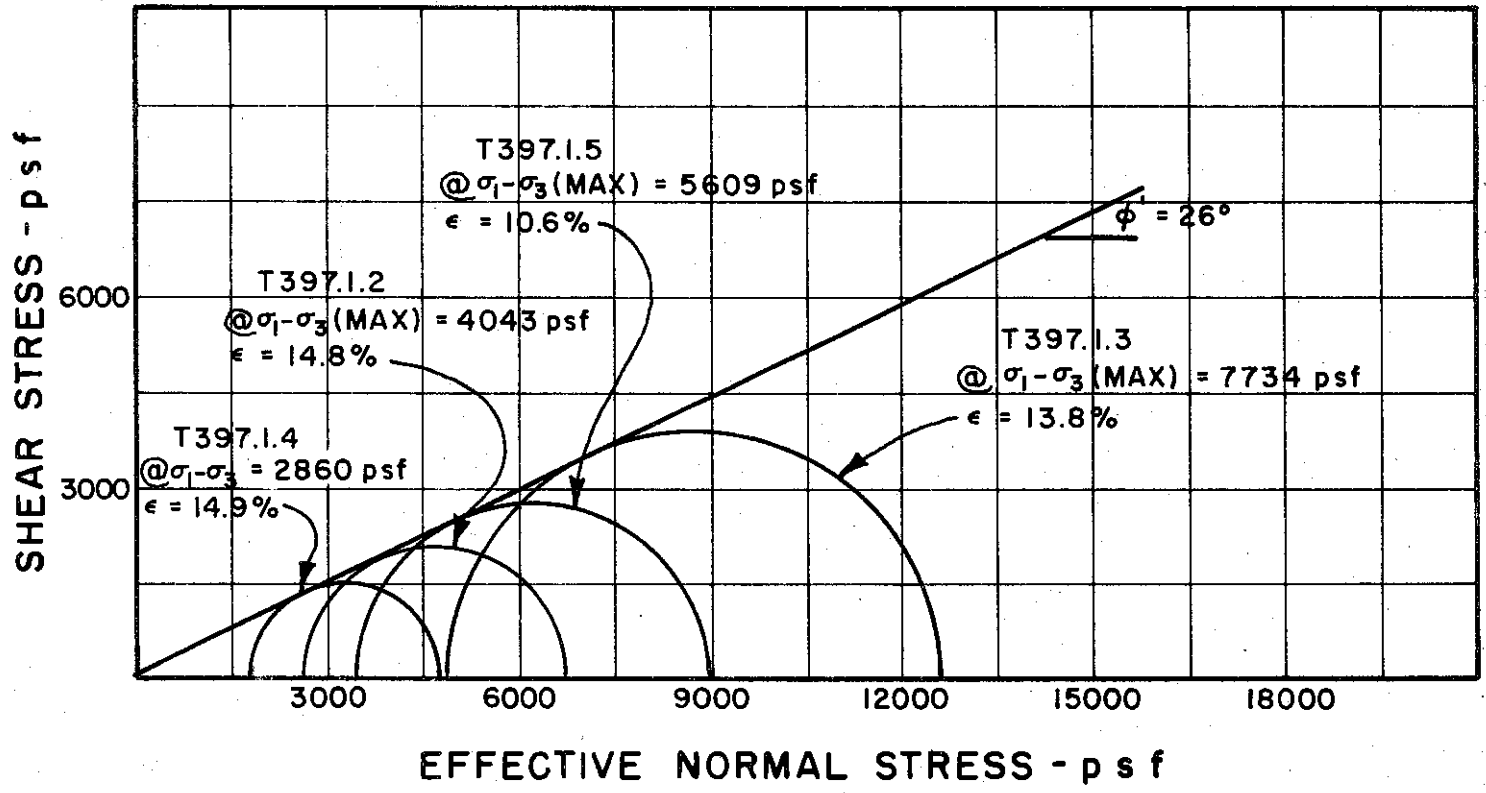
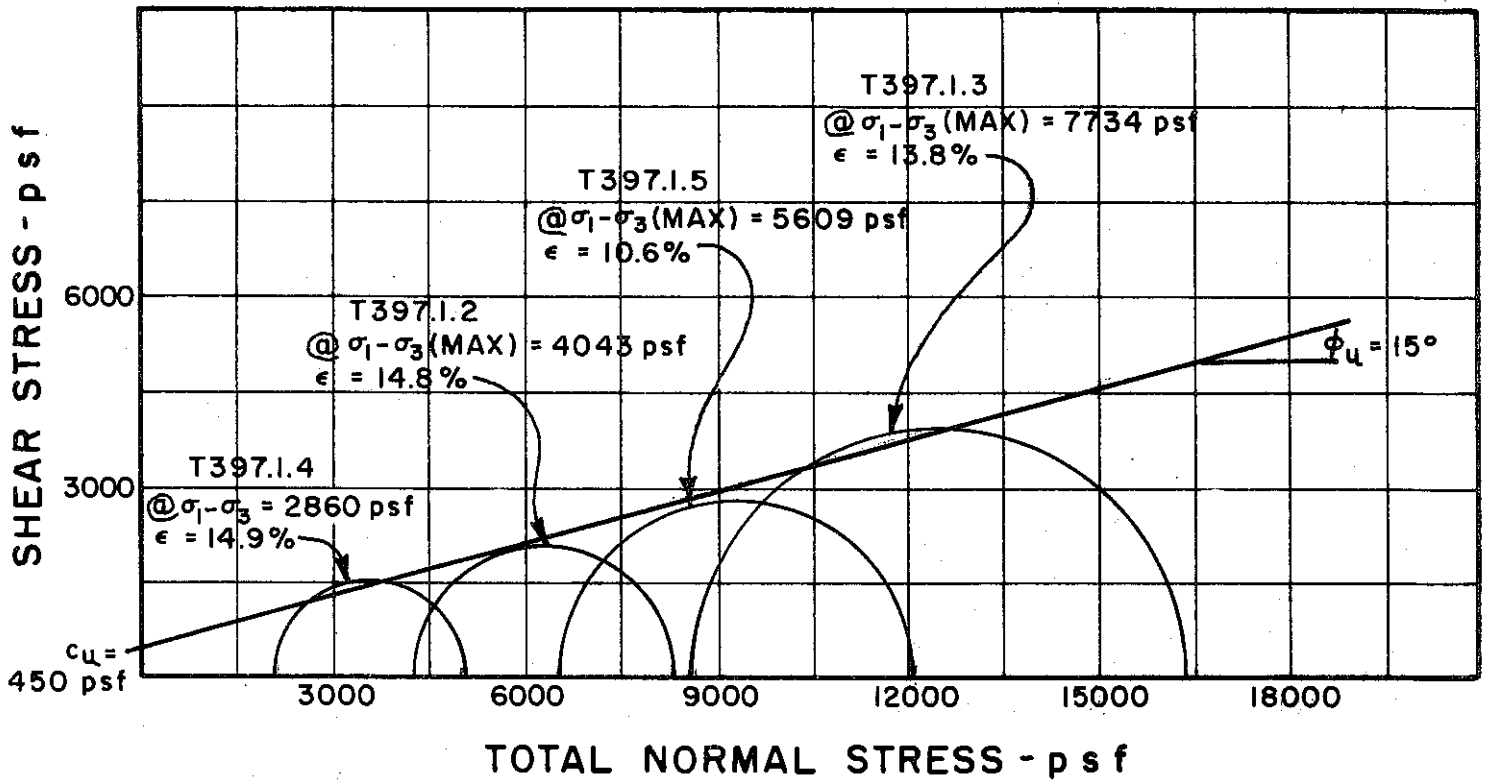

BORING NO. 54
 SAMPLE NO. 4
 DEPTH 53.0' TO 55.0'

**MOHR STRENGTH ENVELOPE
 TRIAXIAL COMPRESSION
 TESTS**

REMARKS ENVELOPE IS INTERPRETIVE,
 BASED ON LIMITED DATA POINTS
 AVAILABLE
 GOLDBERG-ZOINO AND ASSOCIATES, INC.
 CONSULTANTS IN GEOTECHNICAL ENGINEERING

THE DETROIT EDISON COMPANY
 BELLE RIVER PLANT UNITS I & II
 FILE 1255
 C-415

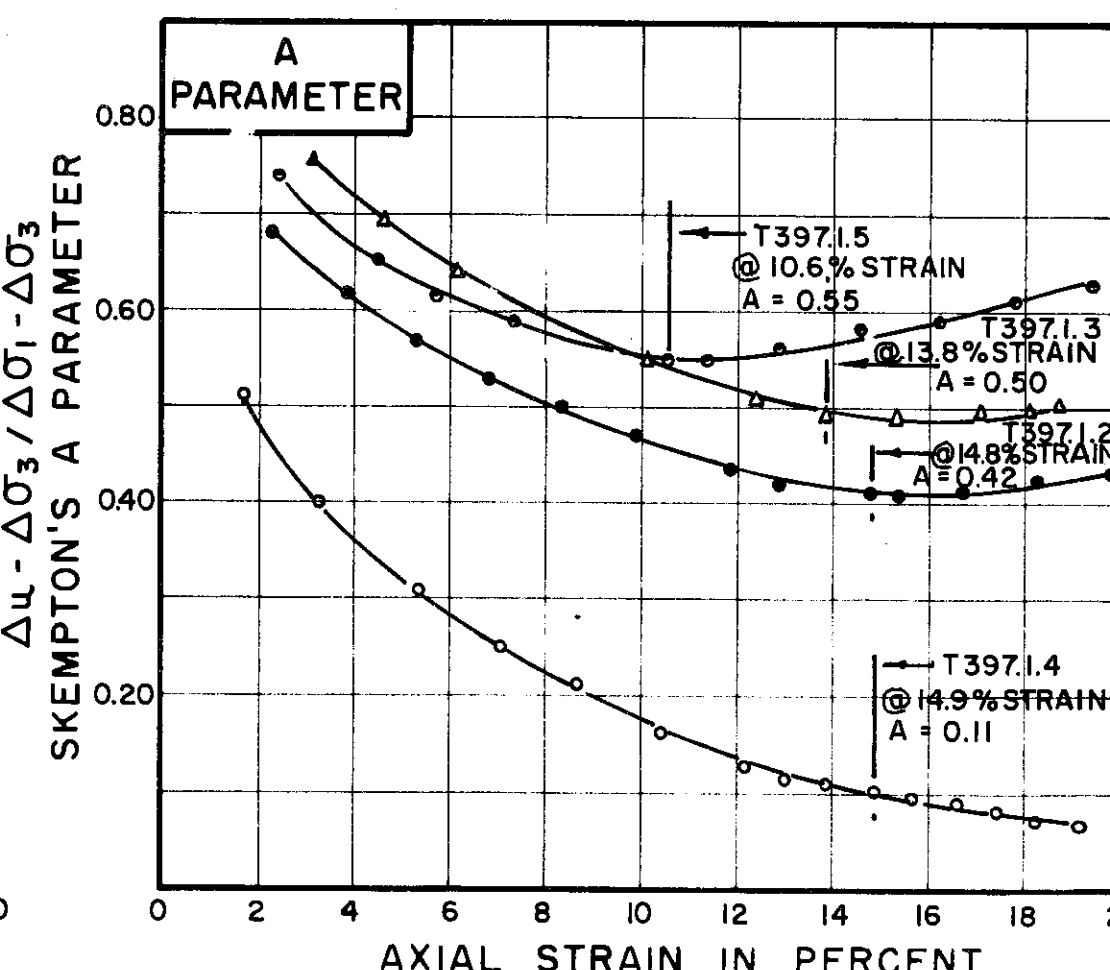
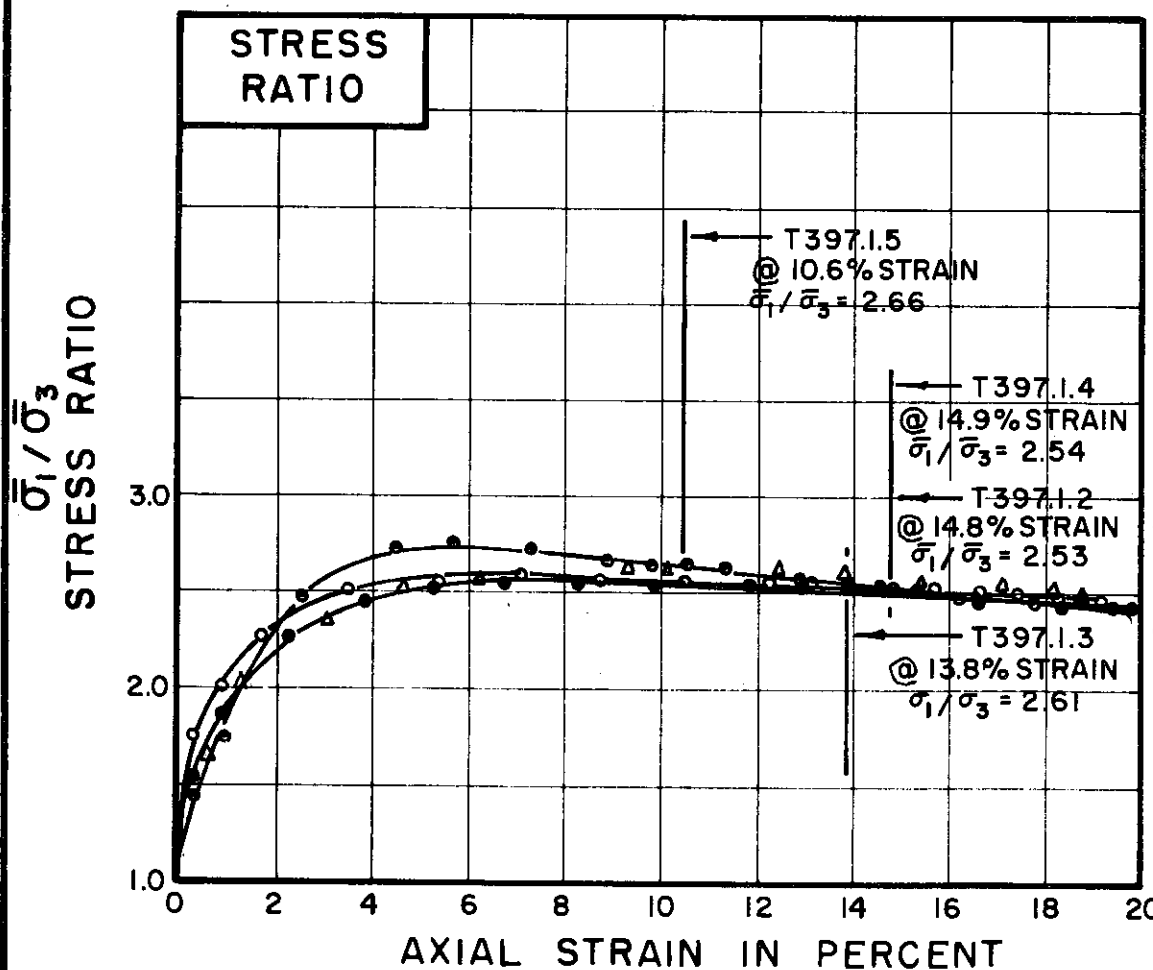
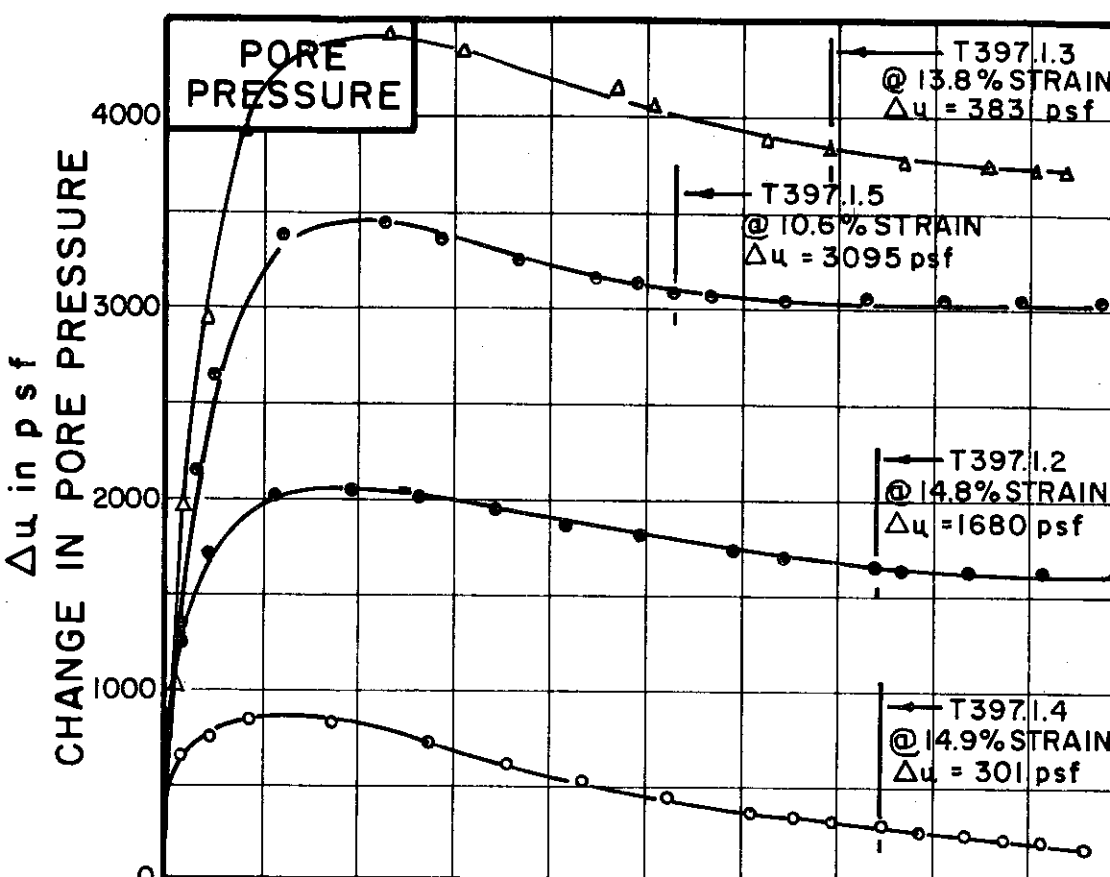
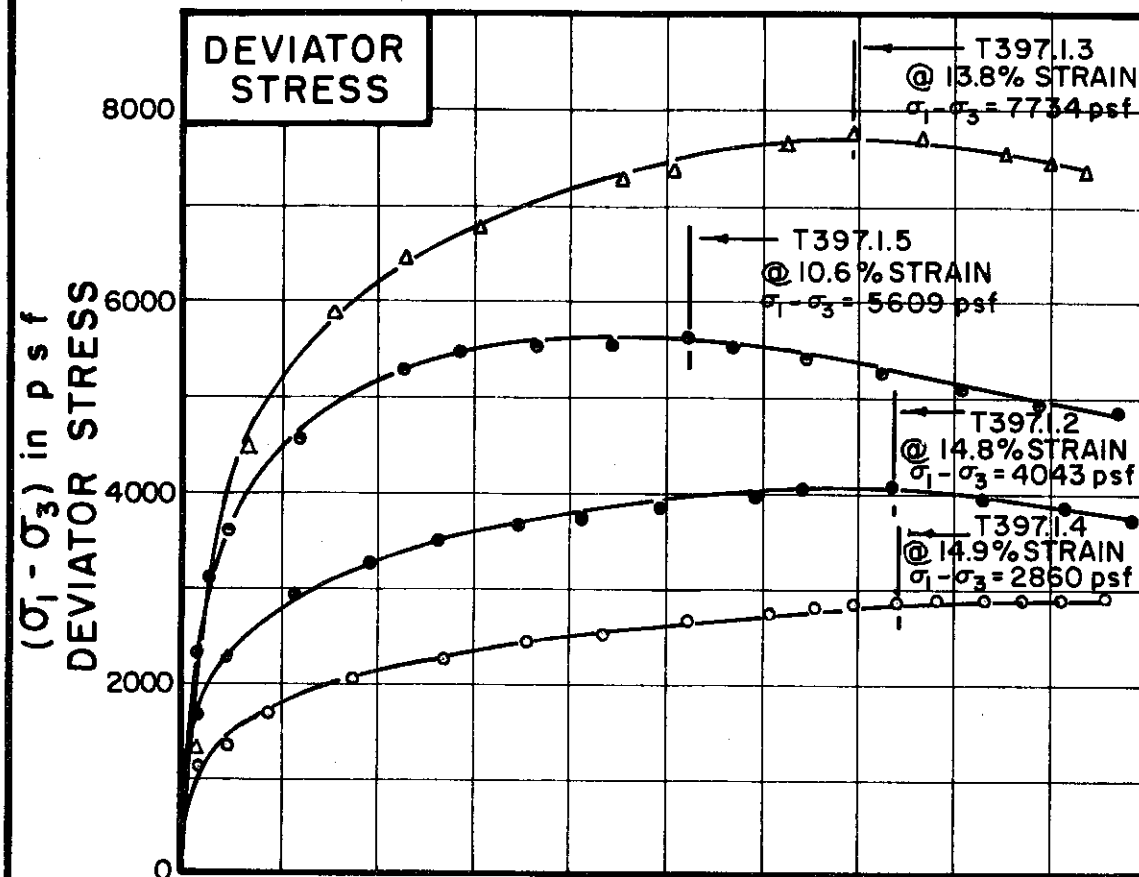

TEST NO. / SYMBOL	T397.1.4	T397.1.2	T397.1.5	T397.1.3
	○	●	●	△

INITIAL CONDITIONS			T397.1.4	T397.1.2	T397.1.5	T397.1.3
WATER CONTENT	w_0		22.6%	23.2%	24.0%	23.2%
DRY DENSITY	γ_d	lb/cu ft	101	102	100	102
SAMPLE DIAMETER	D_0	in.	1.37	1.37	1.37	1.38
SAMPLE HEIGHT	H_0	in.	2.88	3.30	3.12	3.30
FINAL CONDITIONS BEFORE SHEAR			T397.1.4	T397.1.2	T397.1.5	T397.1.3
FINAL BACK PRESSURE	u_0	psf	7200	10080	8640	7200
INITIAL EFFECTIVE STRESS	σ_1, σ_3	psf	2160	4320	6480	8640
VOLUMETRIC STRAIN	ϵ_{vol}		1.68%	1.94%	3.33%	4.95%
PORE PRESSURE RESPONSE			95%	96%	98%	95%
FINAL CONDITIONS AT END OF TEST			T397.1.4	T397.1.2	T397.1.5	T397.1.3
WATER CONTENT	w_f		21.5%	21.3%	19.9%	19.8%
SKETCH OF SAMPLE AT END OF TEST						

RATE OF STRAIN PERCENT/MINUTE	.028	.024	.026	.025
-------------------------------	------	------	------	------

BORING NO. 54
 SAMPLE NO. 4
 DEPTH 53.0' TO 55.0'
 SOIL DESCRIPTION SILTY CLAY (CL)
 LIQUID LIMIT 31 PLASTIC LIMIT 18

CONSOLIDATED UNDRAINED
 TRIAXIAL COMPRESSION
 TESTS

THE DETROIT EDISON COMPANY
 BELLE RIVER PLANT UNITS I & II

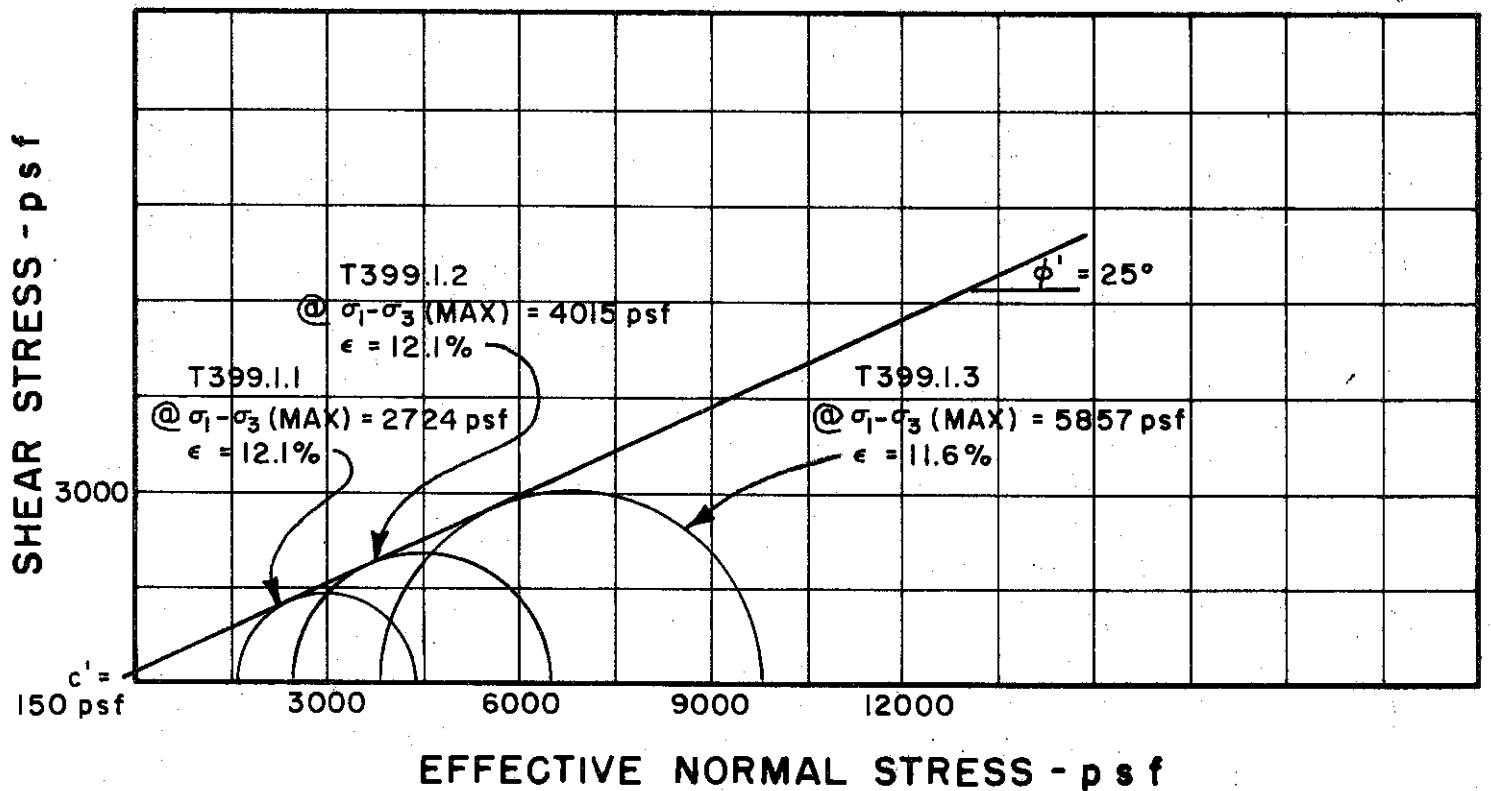
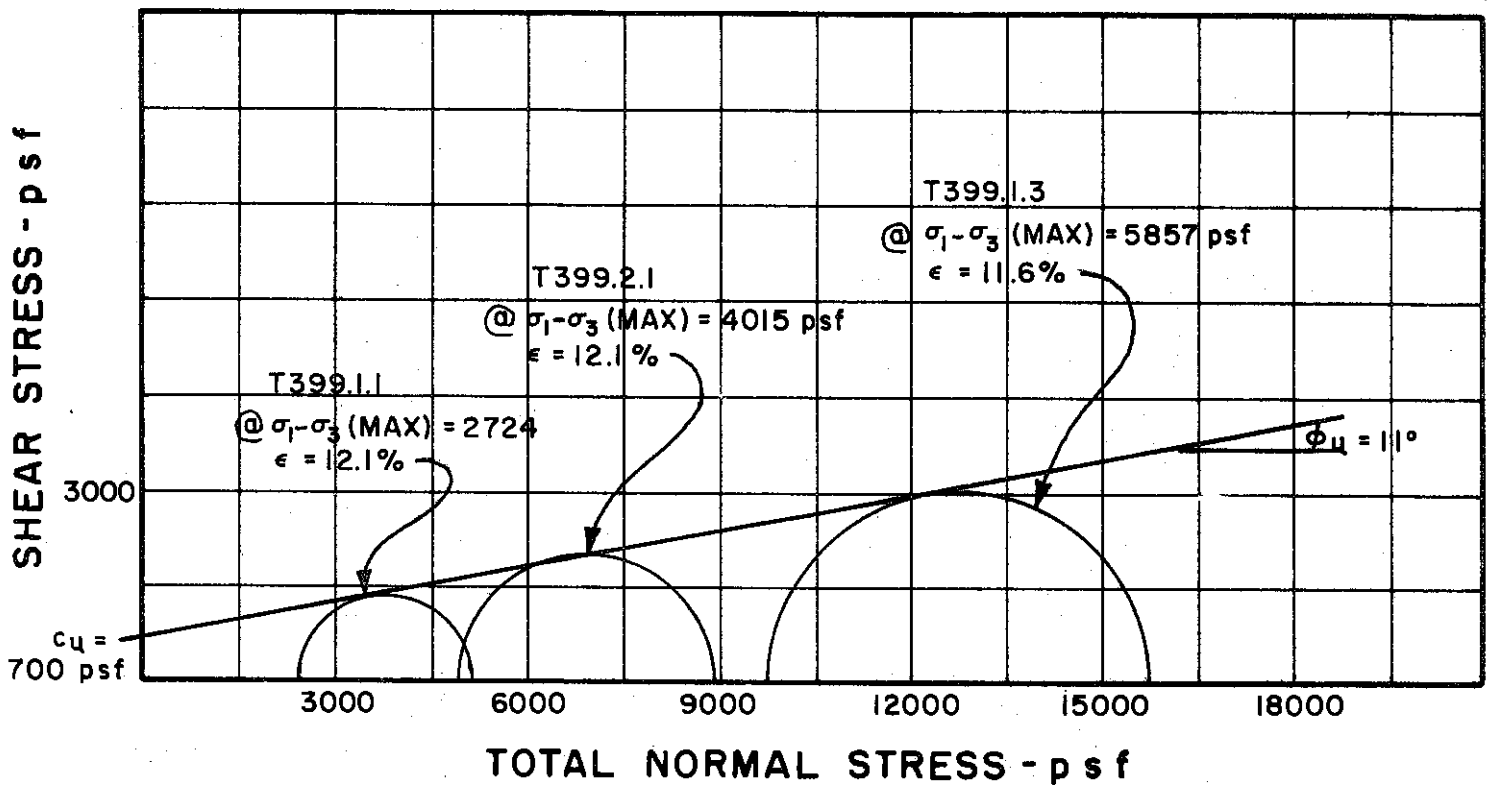

BORING NO. 54

SAMPLE NO. 6

DEPTH 63.0' TO 65.0'

REMARKS ENVELOPE IS INTERPRETIVE,
BASED ON LIMITED DATA POINTS
AVAILABLE

GOLDBERG-ZOINO AND ASSOCIATES, INC.
 CONSULTANTS IN GEOTECHNICAL ENGINEERING

MOHR STRENGTH ENVELOPE
 TRIAXIAL COMPRESSION
 TESTS

THE DETROIT EDISON COMPANY
 BELLE RIVER PLANT UNITS I & II

FILE 1255

C-417

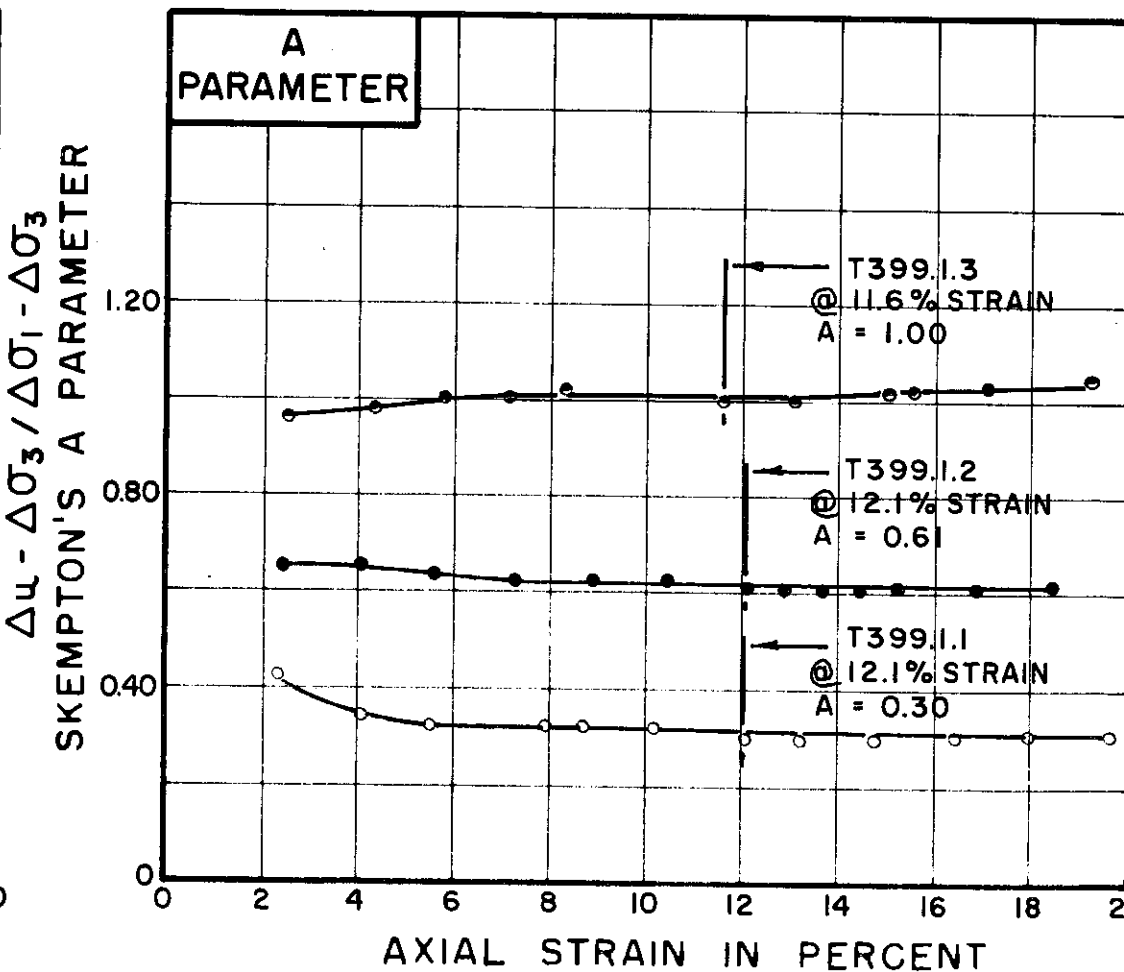
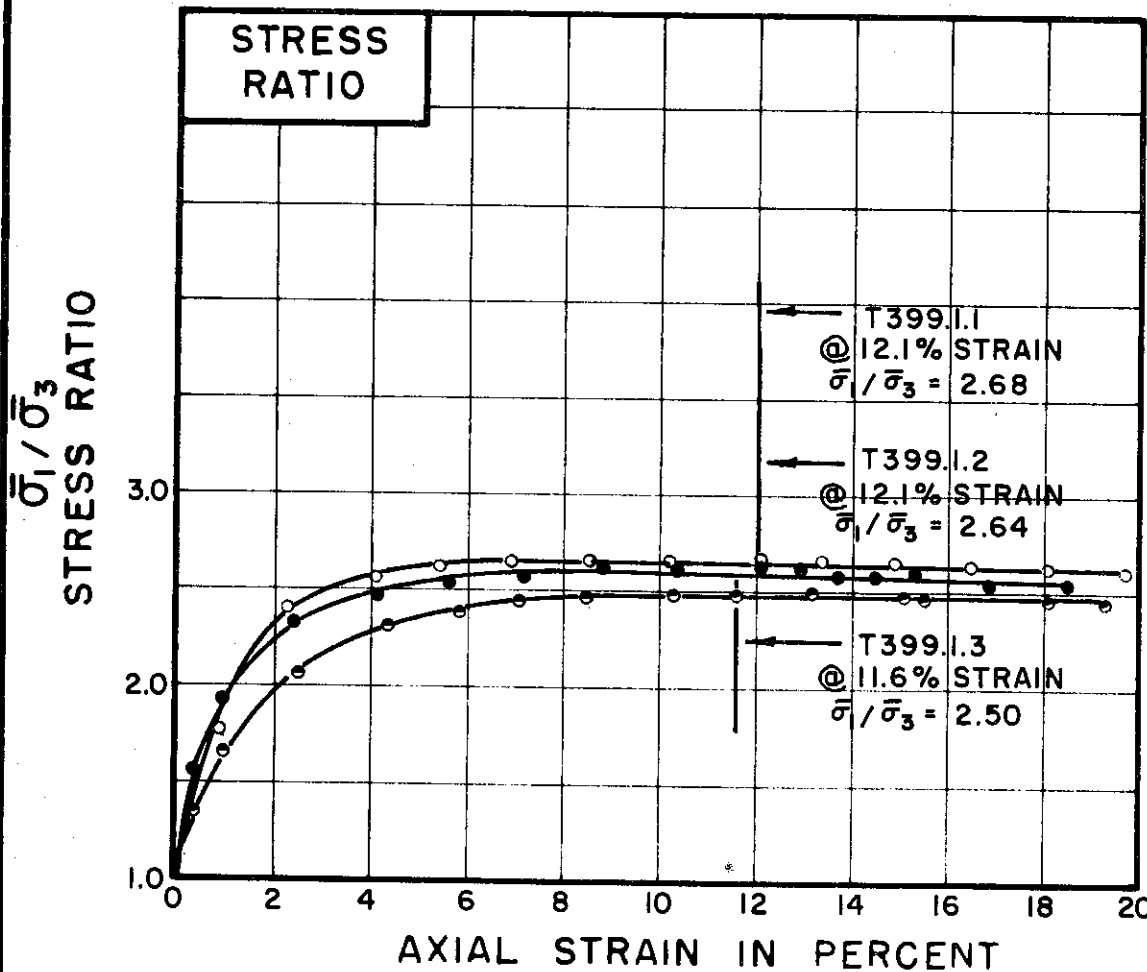
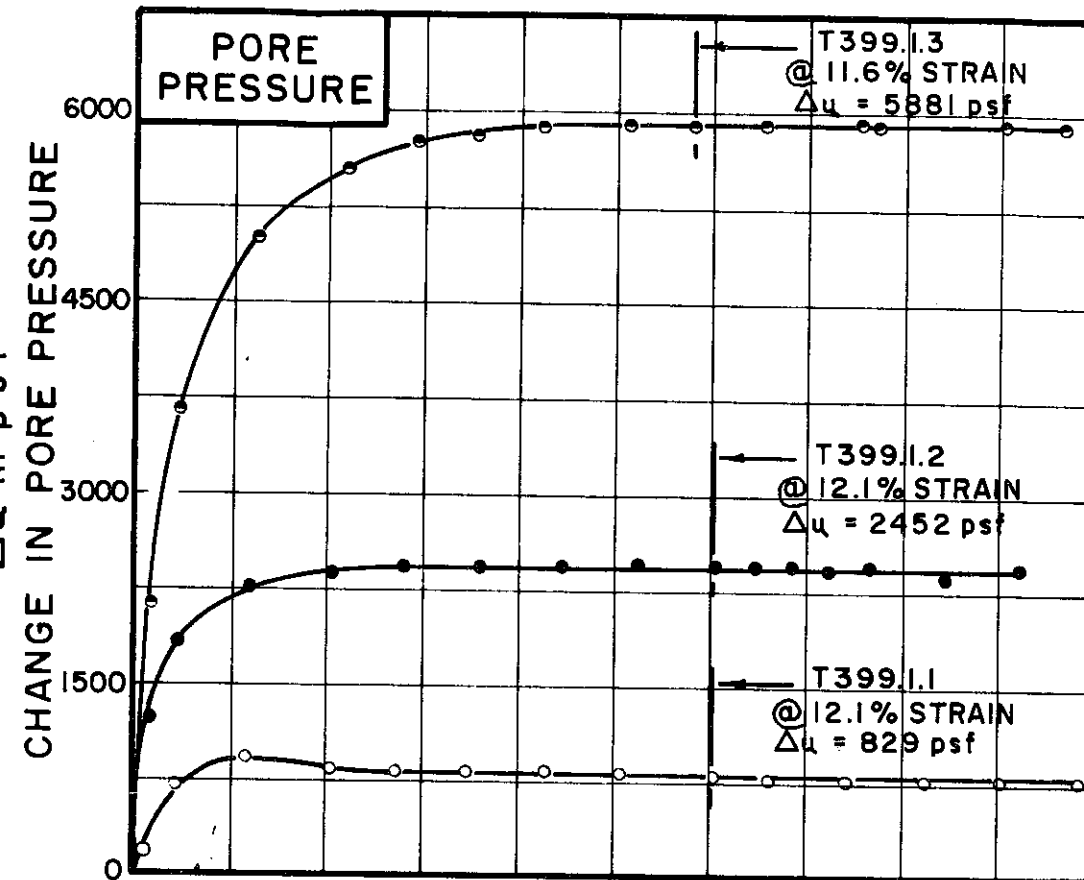
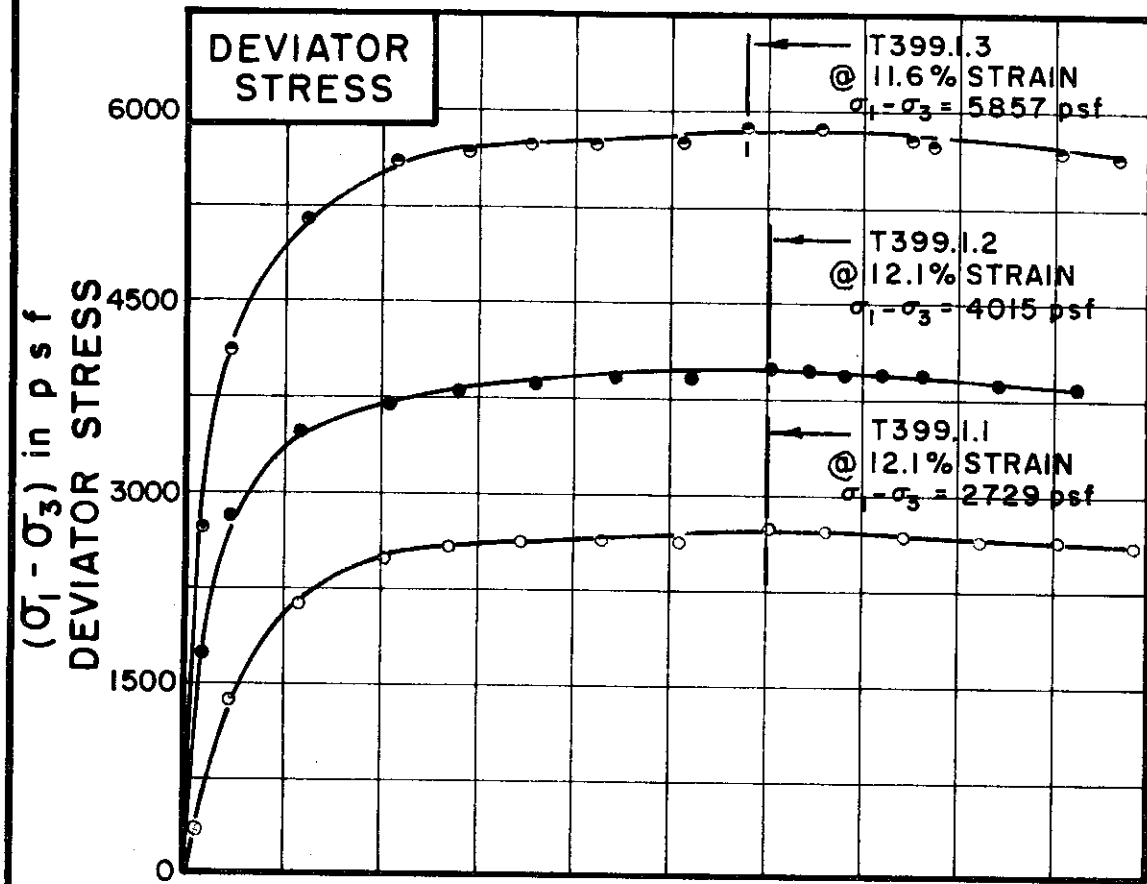

TEST NO. / SYMBOL	T399.1.1	T399.1.2	T399.1.3
-------------------	----------	----------	----------

INITIAL CONDITIONS			T399.1.1	T399.1.2	T399.1.3
WATER CONTENT	w_0		26.4%	25.2%	25.8%
DRY DENSITY	γ_d	lb/cu ft	98	98	98
SAMPLE DIAMETER	D_0	in.	1.39	1.38	1.39
SAMPLE HEIGHT	H_0	in.	3.20	3.14	3.29
FINAL CONDITIONS BEFORE SHEAR					
FINAL BACK PRESSURE	u_0	psf	10,080	10,080	10,080
INITIAL EFFECTIVE STRESS	$\sigma'_1 = \sigma'_3$	psf	2448	4896	9792
VOLUMETRIC STRAIN	ϵ_{vol}		1.77%	3.48%	5.79%
PORE PRESSURE RESPONSE			96%	95%	98%
WATER CONTENT	w_f		25.5%	22.8%	22.2%
SKETCH OF SAMPLE AT END OF TEST					

RATE OF STRAIN PERCENT / MINUTE	.025	.026	.025
---------------------------------	------	------	------

BORING NO. 54
 SAMPLE NO. 6
 DEPTH 63.0' TO 65.0'
 SOIL DESCRIPTION SILTY CLAY, SANDY (CL)
 LIQUID LIMIT 36 PLASTIC LIMIT 18

CONSOLIDATED UNDRAINED
 TRIAXIAL COMPRESSION
 TESTS
 THE DETROIT EDISON COMPANY
 BELLE RIVER PLANT UNITS I & II

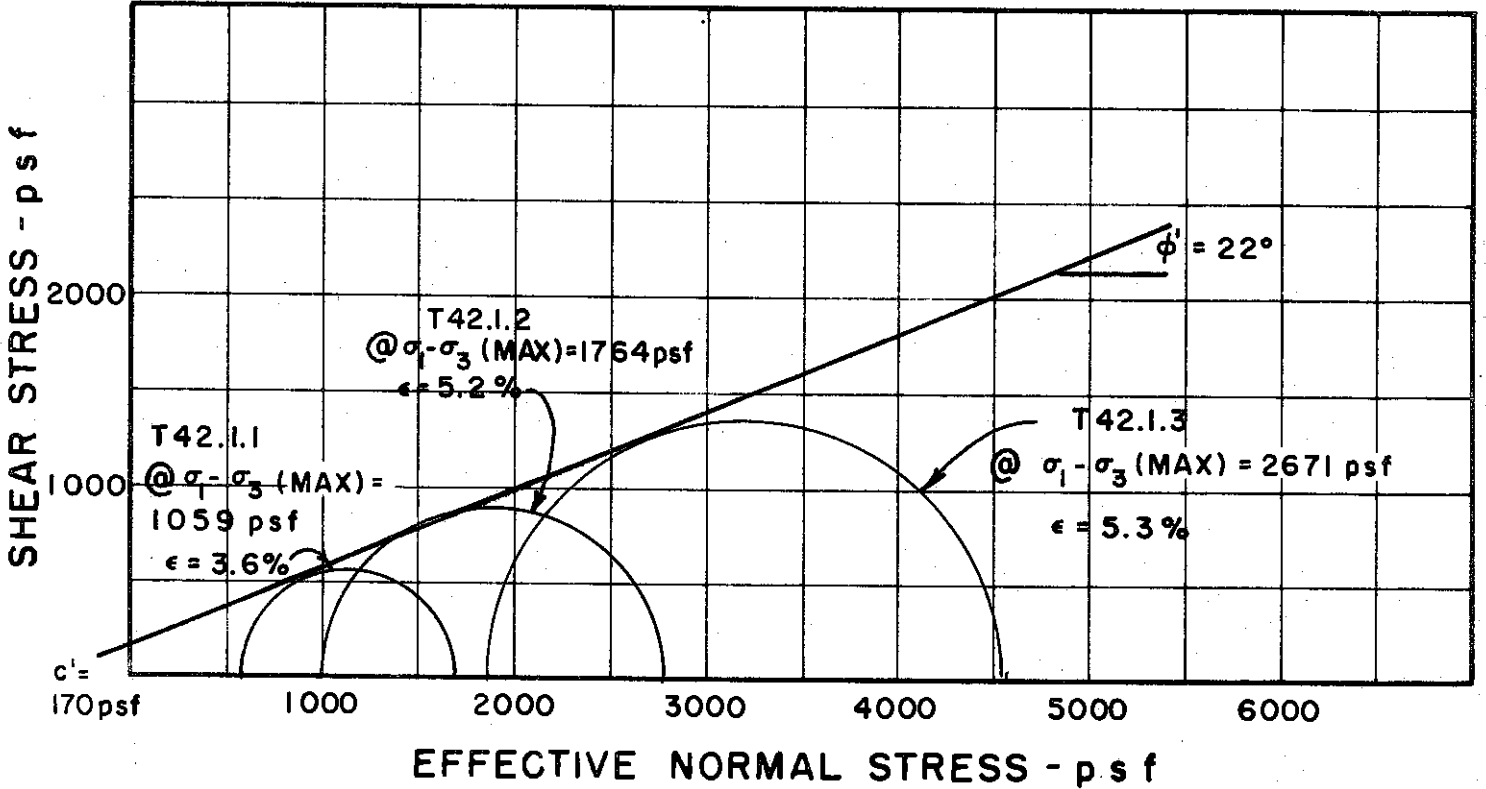
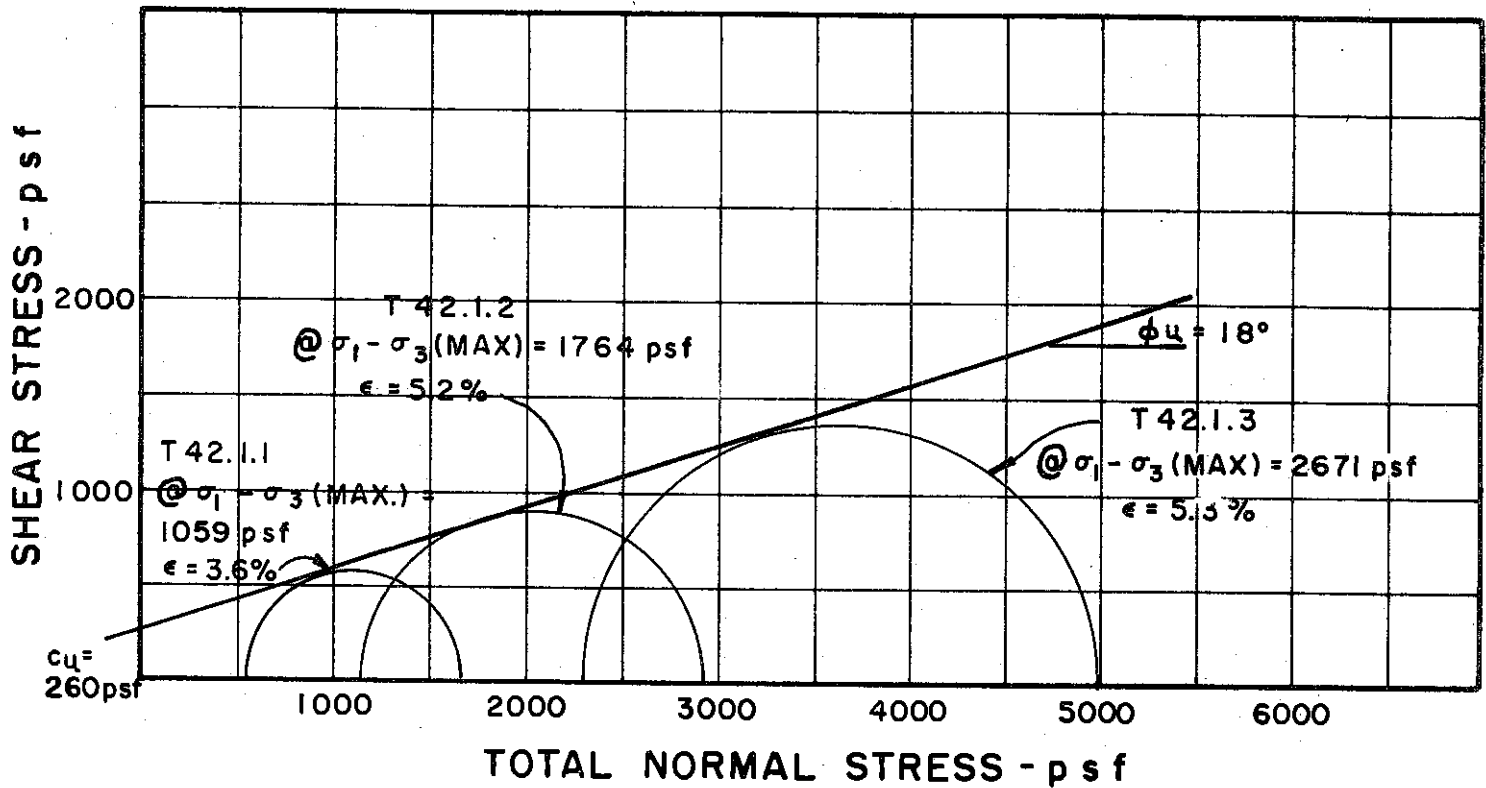

BORING NO. 60

SAMPLE NO. 2

DEPTH 8.0 TO 10.0

REMARKS ENVELOPE IS INTERPRETIVE,
BASED ON LIMITED DATA POINTS
AVAILABLE

GOLDBERG-ZOINO AND ASSOCIATES, INC.
 CONSULTANTS IN GEOTECHNICAL ENGINEERING

MOHR STRENGTH ENVELOPE
 TRIAXIAL COMPRESSION
 TESTS

THE DETROIT EDISON COMPANY
 BELLE RIVER PLANT UNITS I & II

FILE 1255

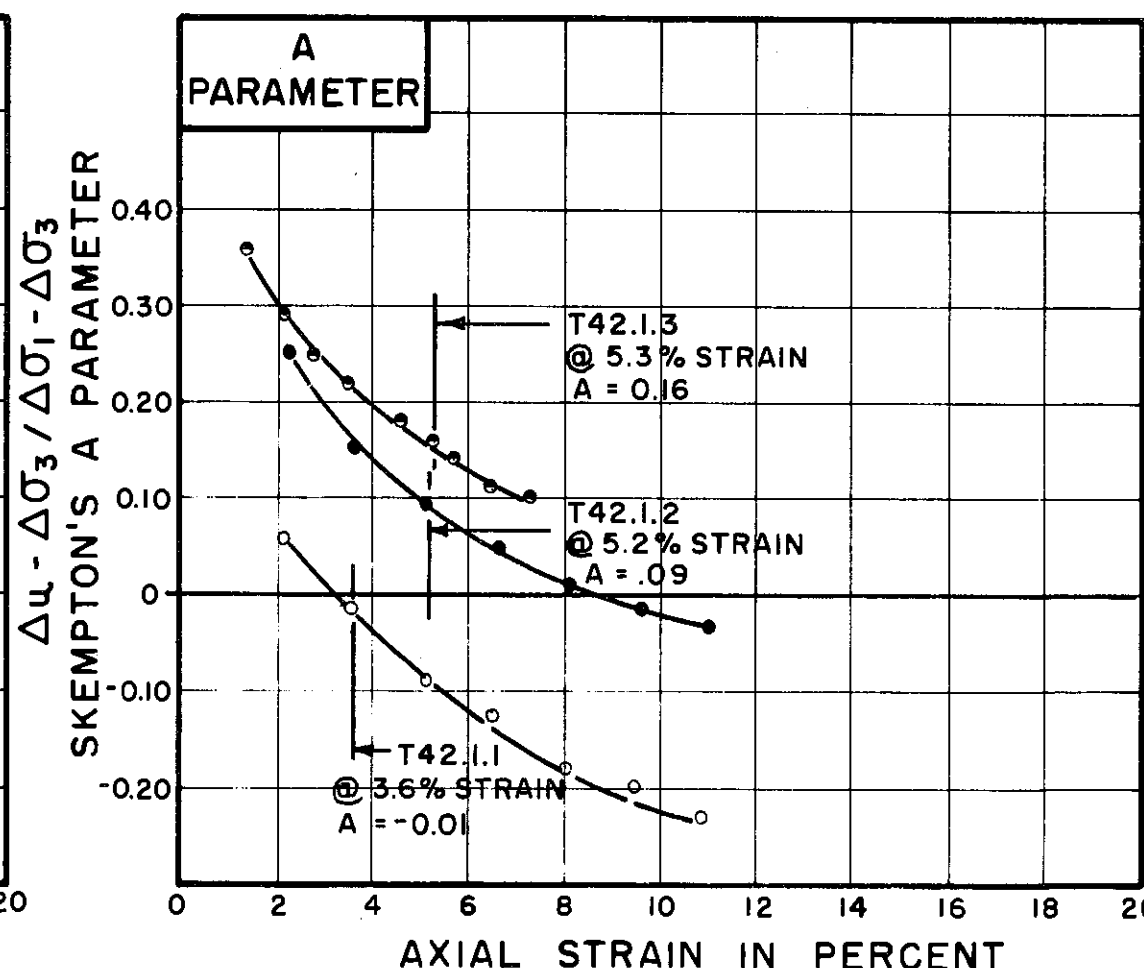
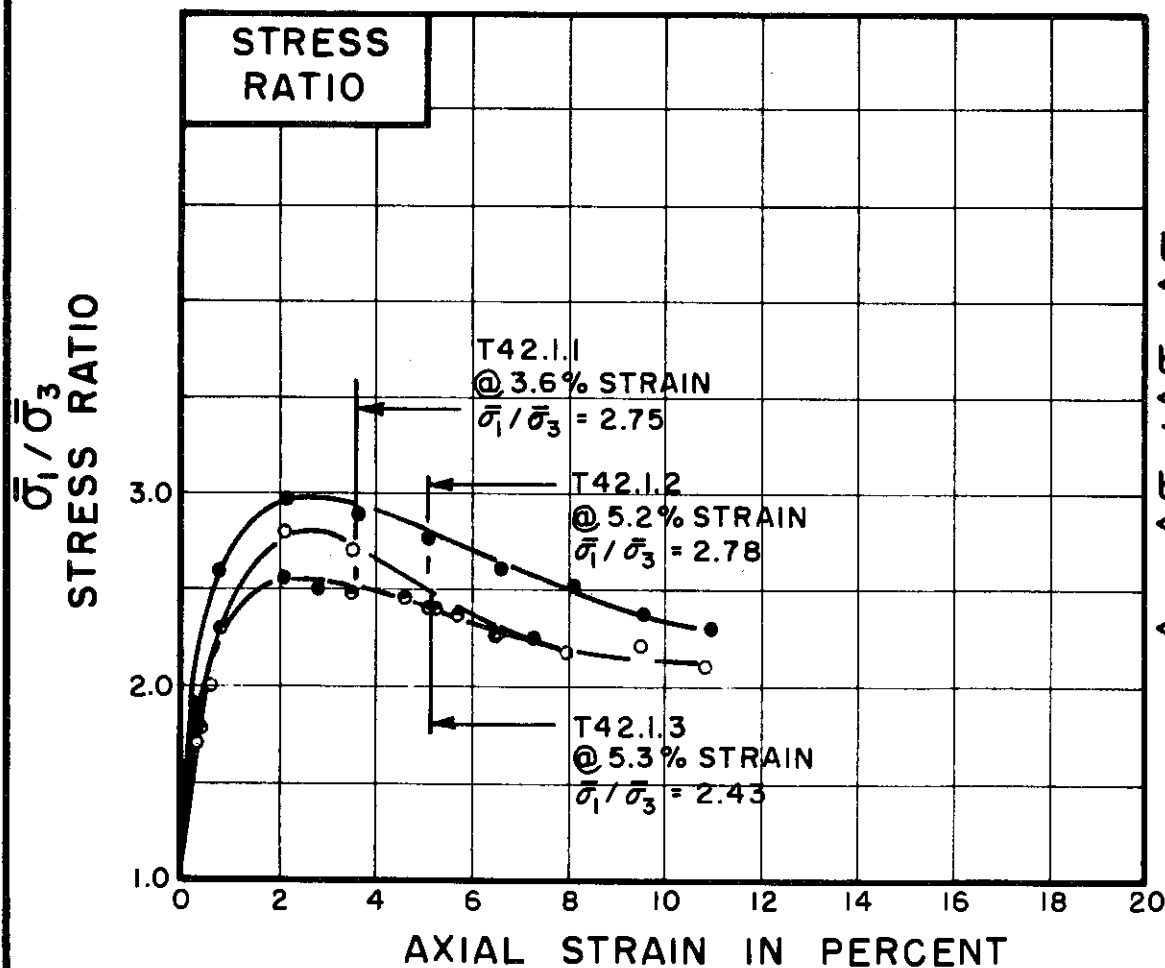
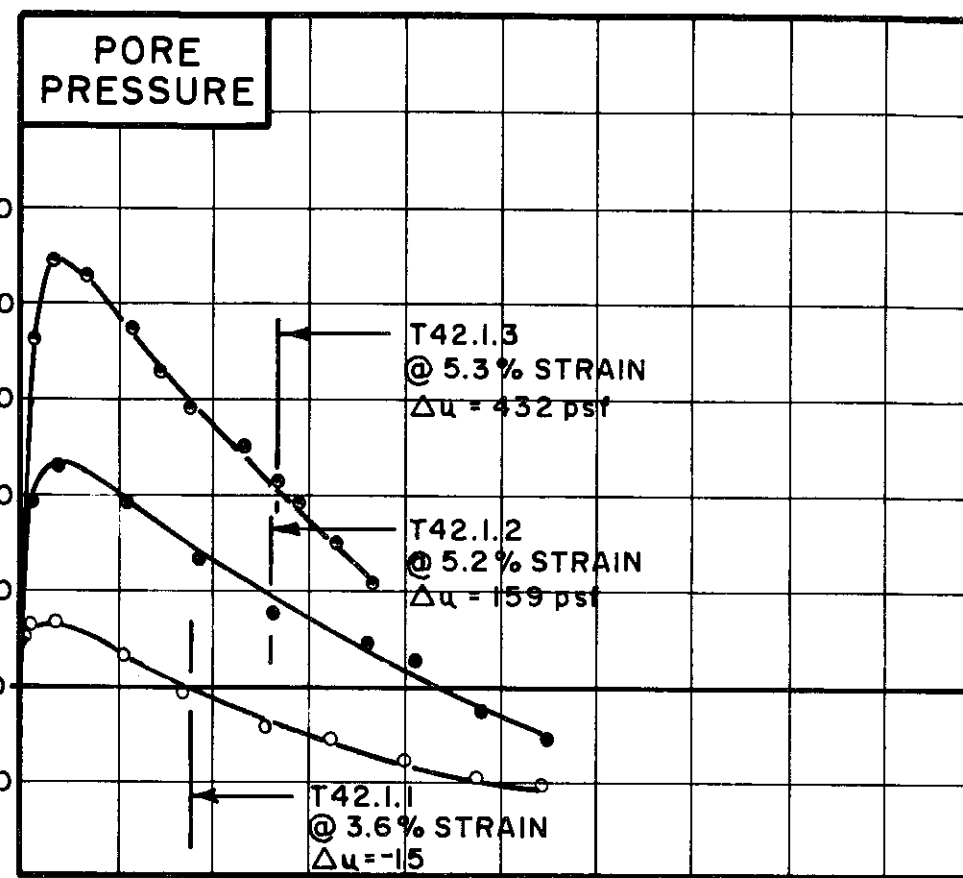
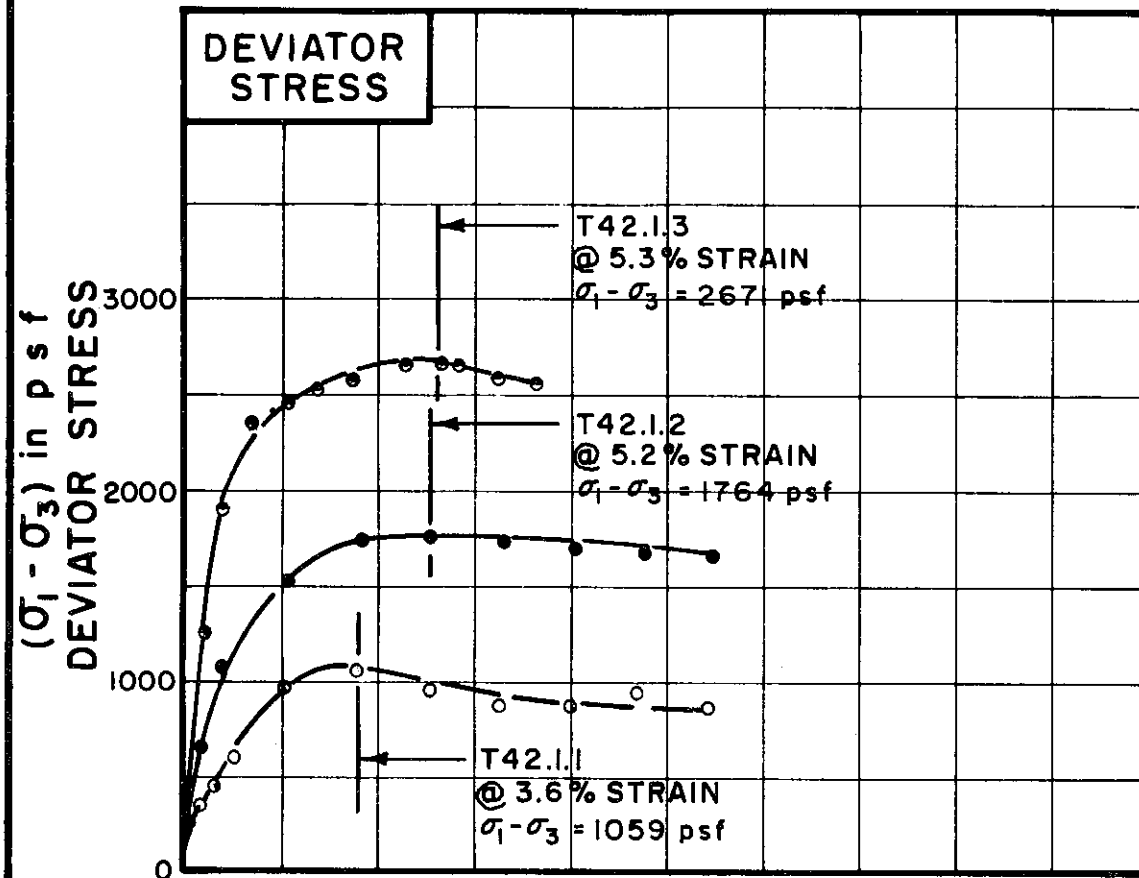

TEST NO. / SYMBOL	T42.1.1	T42.1.2	T42.1.3
	○	●	○

INITIAL CONDITIONS			T42.1.1	T42.1.2	T42.1.3
WATER CONTENT	w_0		29.8%	29.3%	28.9%
DRY DENSITY	γ_d	pcf	94	95	96
SAMPLE DIAMETER	D_0	in.	1.40	1.40	1.40
SAMPLE HEIGHT	H_0	in.	3.43	3.40	3.42
FINAL CONDITIONS BEFORE SHEAR			T42.1.1	T42.1.2	T42.1.3
FINAL BACK PRESSURE	u_0	psf	7200	7200	8784
INITIAL EFFECTIVE STRESS	$\bar{\sigma}_1 / \bar{\sigma}_3$	psf	590	1152	2304
VOLUMETRIC STRAIN	ϵ_{vol}		0.2%	1.6%	1.4%
PORE PRESSURE RESPONSE			98%	99%	98%
FINAL CONDITIONS			T42.1.1	T42.1.2	T42.1.3
WATER CONTENT	w_f		32.3%	30.9%	29.6%
SKETCH OF SAMPLE AT END OF TEST					

RATE OF STRAIN PERCENT/MINUTE	.023	.024	.023
-------------------------------	------	------	------

BORING NO. 60

SAMPLE NO. 2

DEPTH 8.0 TO 10.0

SOIL DESCRIPTION SILTY CLAY (CH)

LIQUID LIMIT 53 PLASTIC LIMIT 26

CONSOLIDATED UNDRAINED
 TRIAXIAL COMPRESSION
 TESTS

THE DETROIT EDISON COMPANY
 BELLE RIVER PLANT UNITS I & II

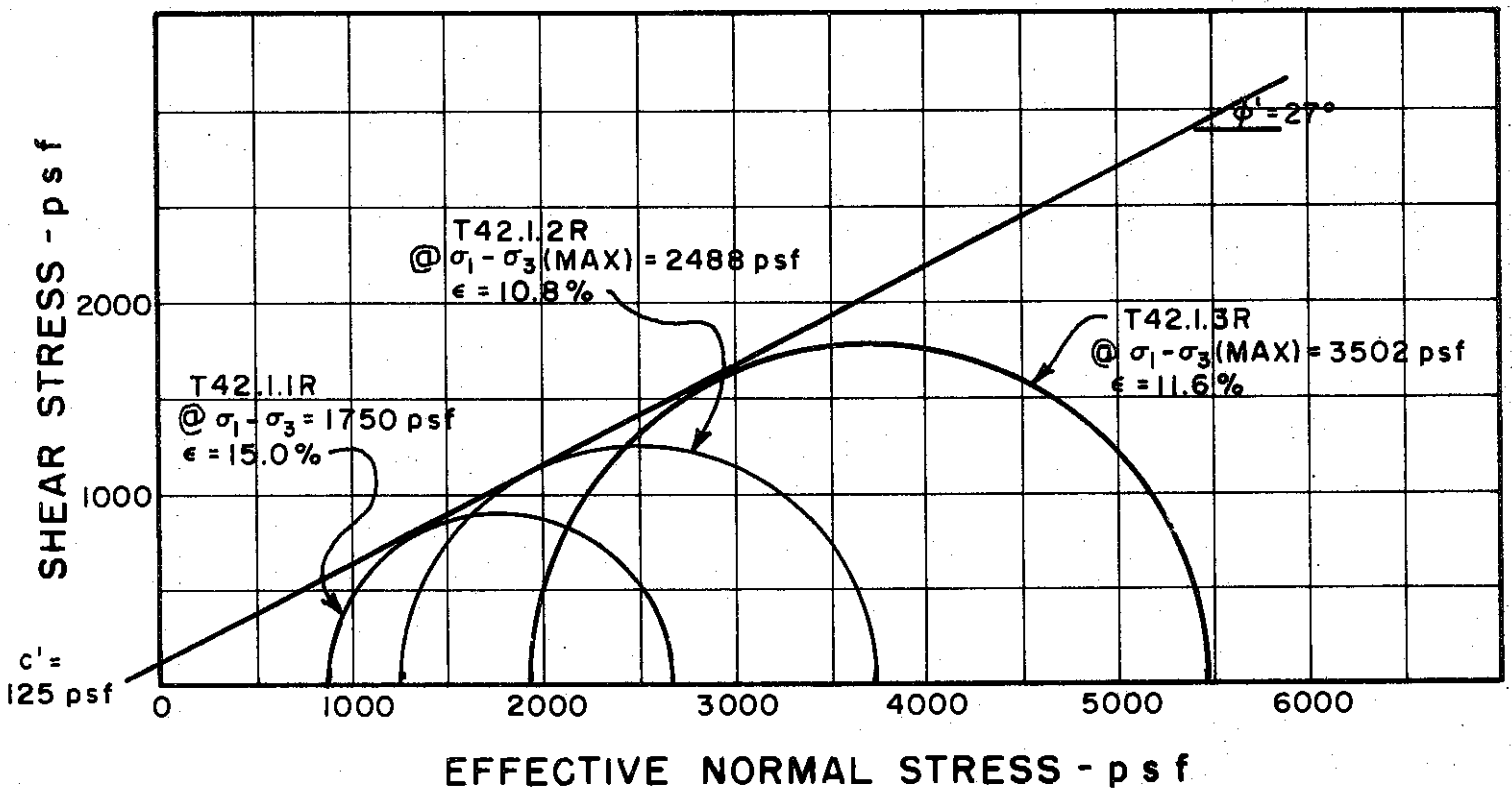
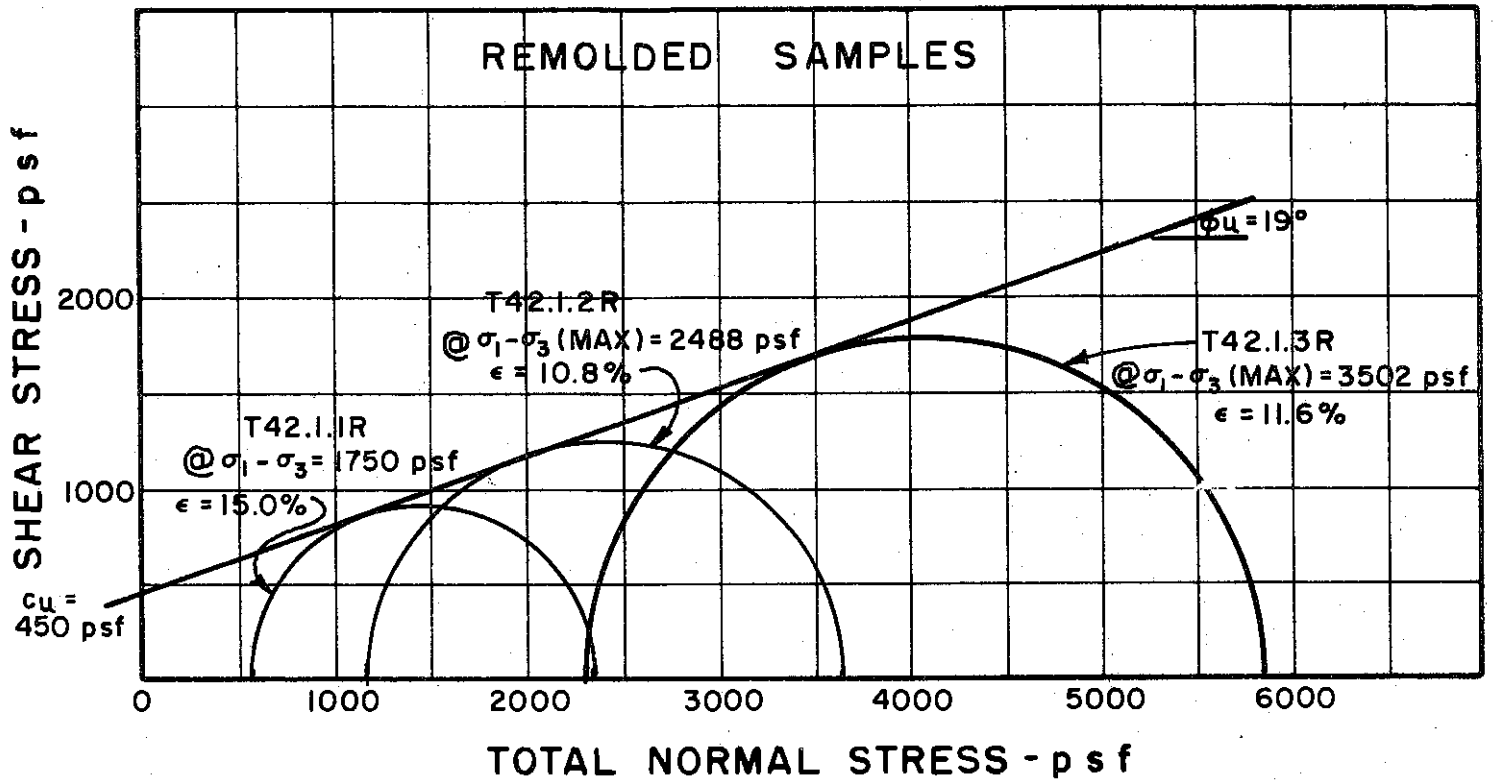

BORING NO. 60

SAMPLE NO. 2

DEPTH 8.0 TO 10.0

REMARKS ENVELOPE IS INTERPRETIVE
BASED ON LIMITED DATA POINTS
AVAILABLE

GOLDBERG-ZOINO AND ASSOCIATES, INC.
CONSULTANTS IN GEOTECHNICAL ENGINEERING

**MOHR STRENGTH ENVELOPE
TRIAXIAL COMPRESSION
TESTS**

THE DETROIT EDISON COMPANY
BELLE RIVER PLANT UNITS I & II

FILE 1255

C-421

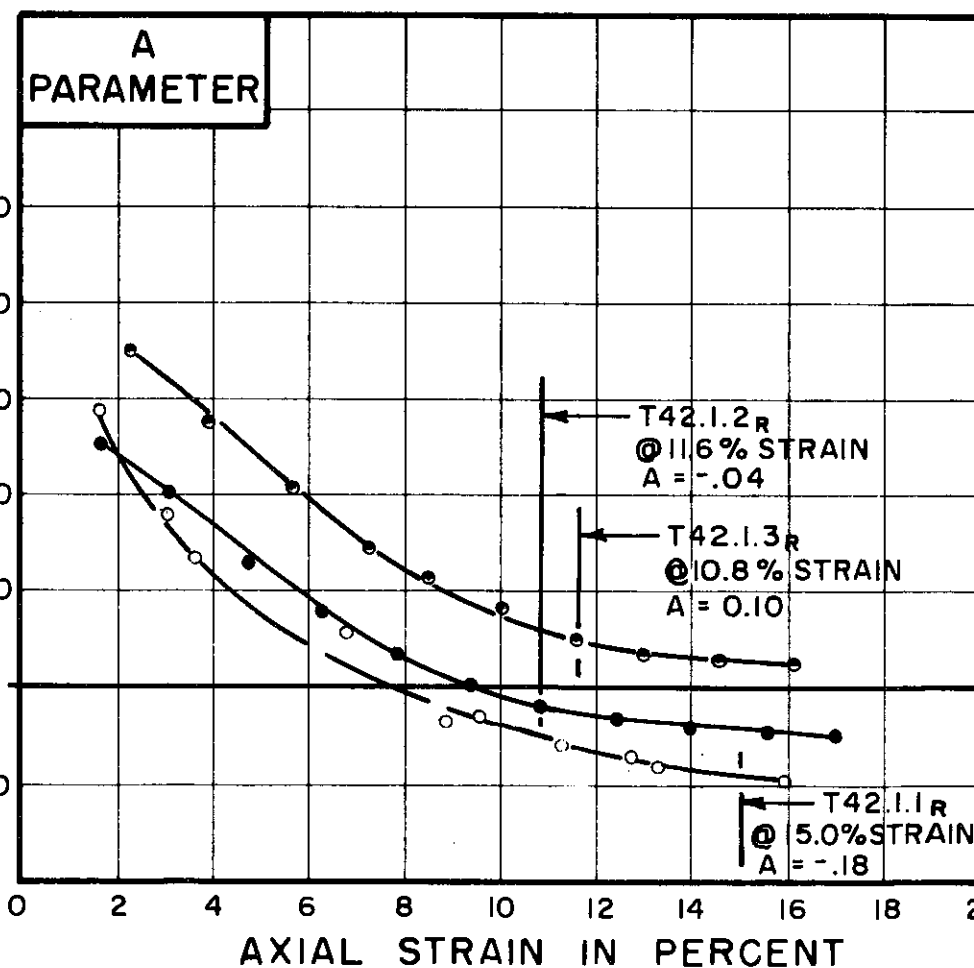
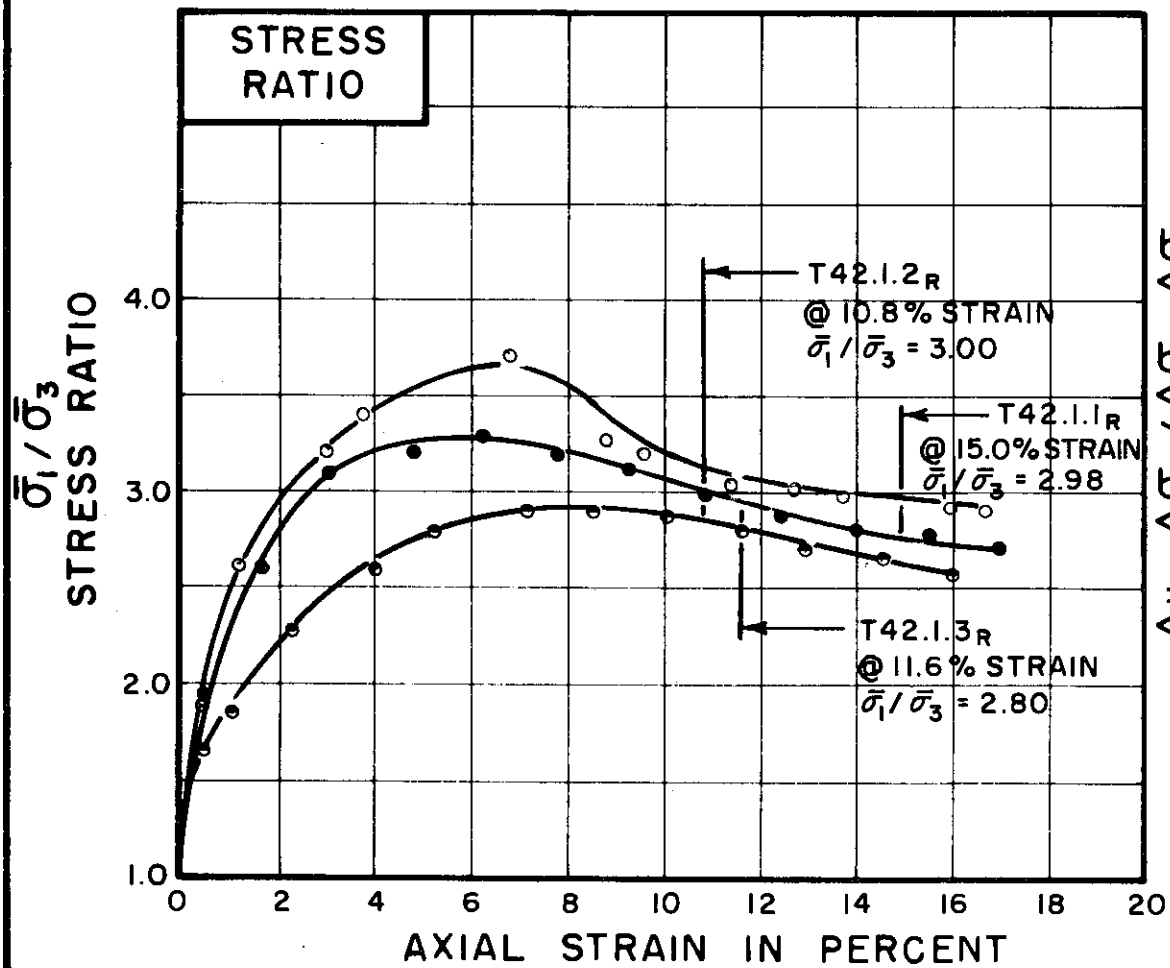
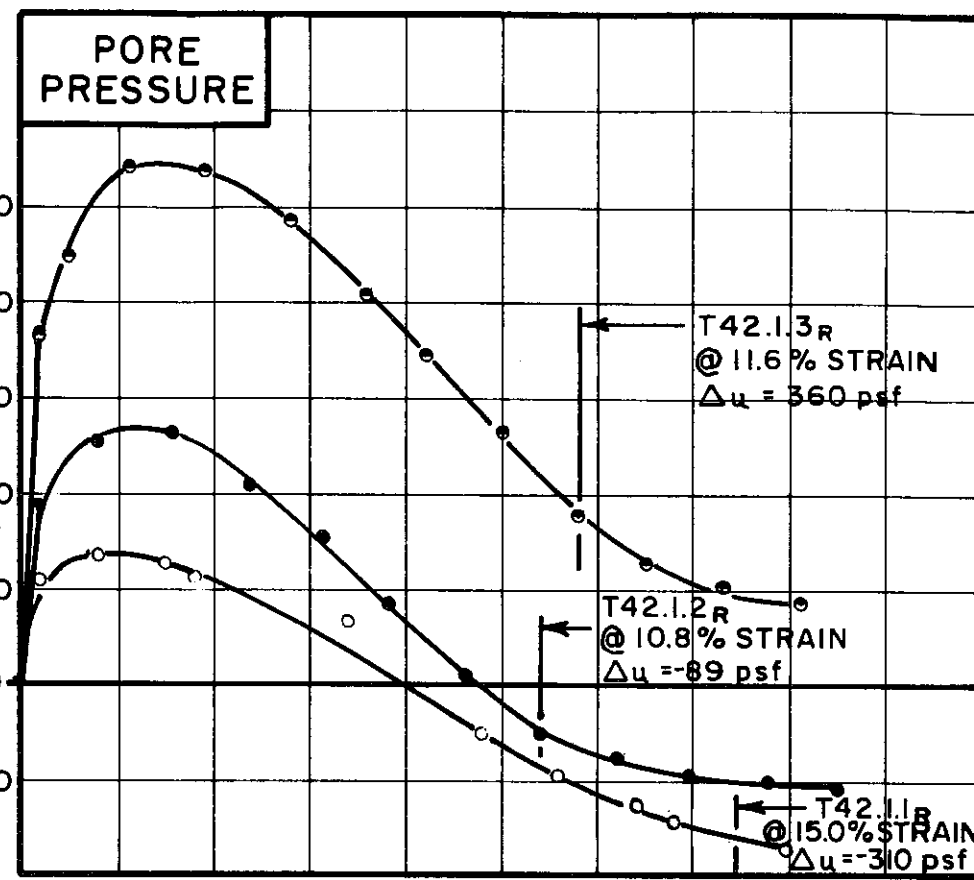
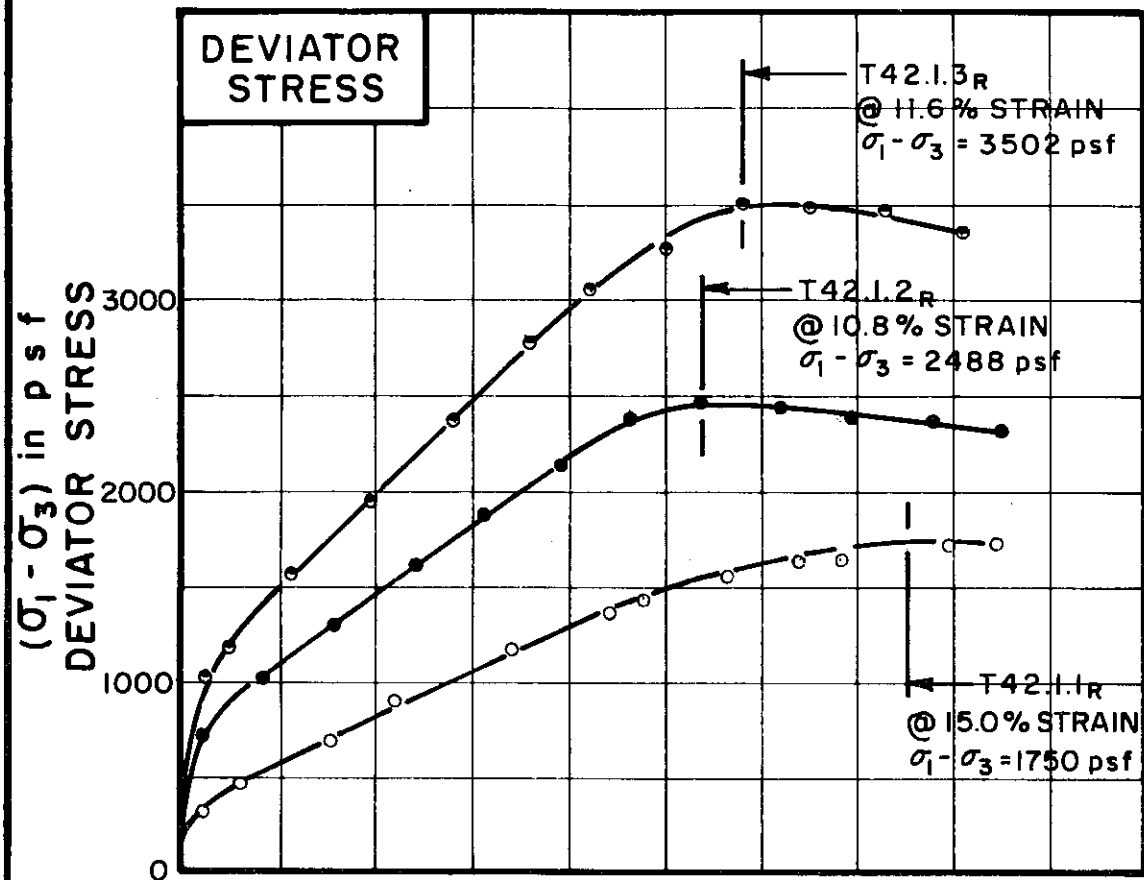

TEST NO. / SYMBOL	T42.1.1 _R	T42.1.2 _R	T42.1.3 _R
-------------------	----------------------	----------------------	----------------------

INITIAL CONDITIONS		T42.1.1 _R	T42.1.2 _R	T42.1.3 _R
WATER CONTENT	w ₀	29.3%	29.3%	29.3%
DRY DENSITY	γ _d	96	99	98
pcf				
SAMPLE DIAMETER	D ₀	1.40	1.40	1.40
in.				
SAMPLE HEIGHT	H ₀	3.30	3.25	3.29
in.				
FINAL CONDITIONS BEFORE SHEAR				
FINAL BACK PRESSURE	u ₀	8640	8640	8640
psf				
INITIAL EFFECTIVE STRESS	σ̄ ₁ / σ̄ ₃	576	1152	2304
psf				
VOLUMETRIC STRAIN	ε _{vol}	0.7%	2.4%	3.3%
PORE PRESSURE RESPONSE		97%	97%	97%
FINAL CONDITIONS				
WATER CONTENT	w _f	29.0%	26.1%	25.8%
SKETCH OF SAMPLE AT END OF TEST				

RATE OF STRAIN PERCENT / MINUTE	.024	.025	.025
---------------------------------	------	------	------

BORING NO. 60

SAMPLE NO. 2

DEPTH 8.0 TO 10.0

SOIL DESCRIPTION SILTY CLAY (CL)

LIQUID LIMIT 53 PLASTIC LIMIT 26

REMOLDED SAMPLES

CONSOLIDATED UNDRAINED
TRIAXIAL COMPRESSION
TESTS

THE DETROIT EDISON COMPANY
BELLE RIVER PLANT UNITS I & II

FILE 1255

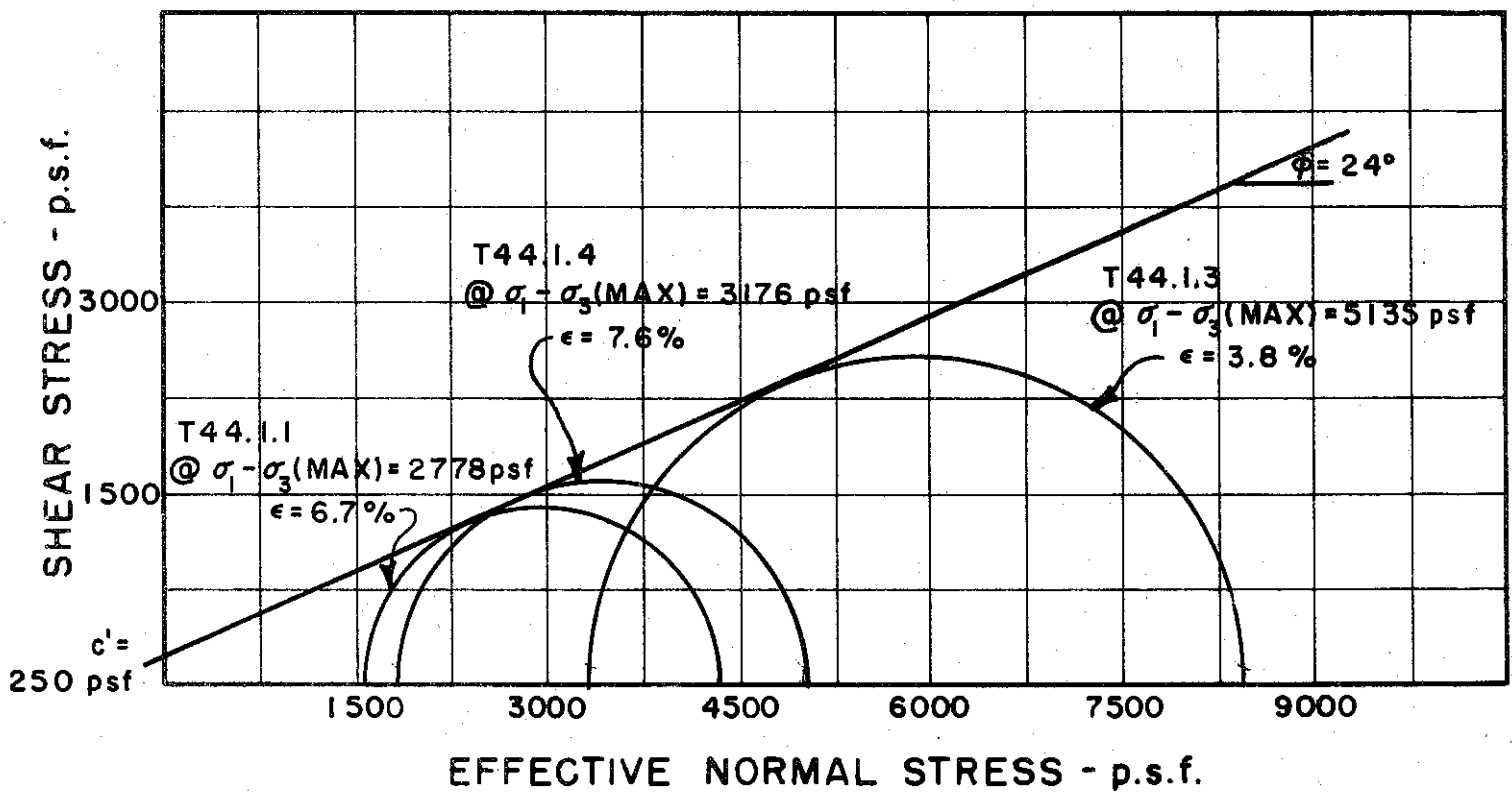
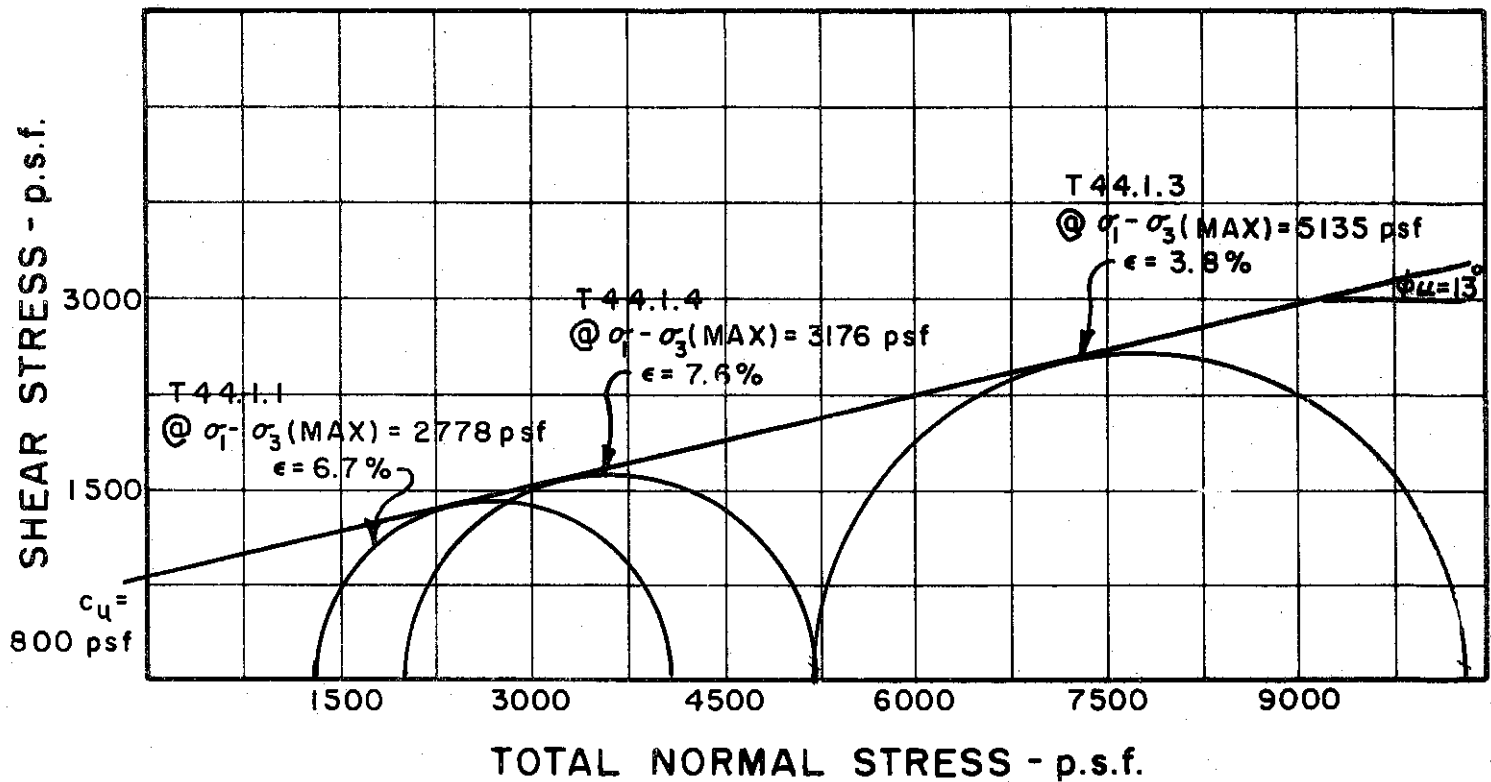

BORING NO. 60
 SAMPLE NO. 4
 DEPTH 21.0 TO 23.0

MOHR STRENGTH ENVELOPE
 TRIAXIAL COMPRESSION
 TESTS

REMARKS ENVELOPE IS INTERPRETIVE,
BASED ON LIMITED DATA POINTS
AVAILABLE
 GOLDBERG-ZOINO AND ASSOCIATES, INC.
 CONSULTANTS IN GEOTECHNICAL ENGINEERING

THE DETROIT EDISON COMPANY
 BELLE RIVER PLANT UNITS I & II

FILE 1255

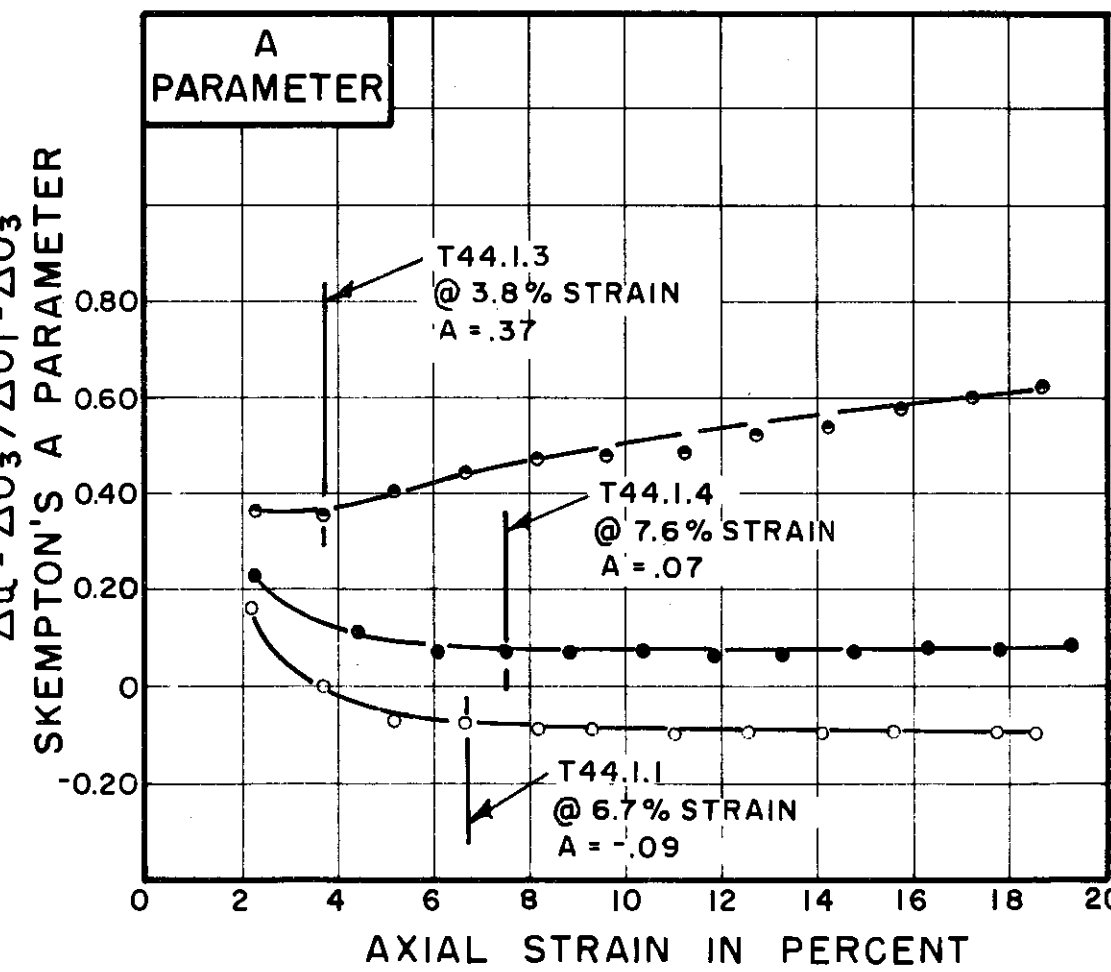
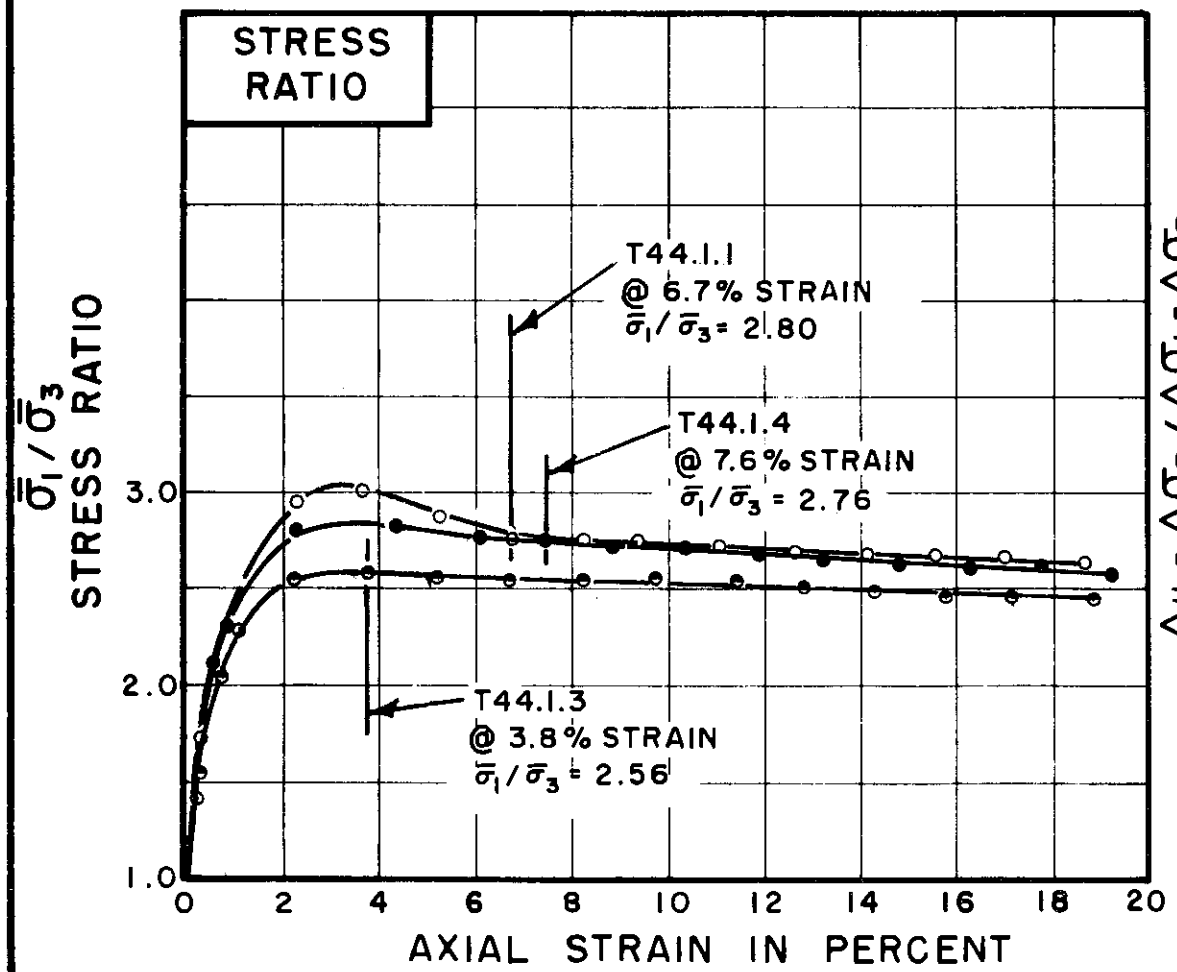
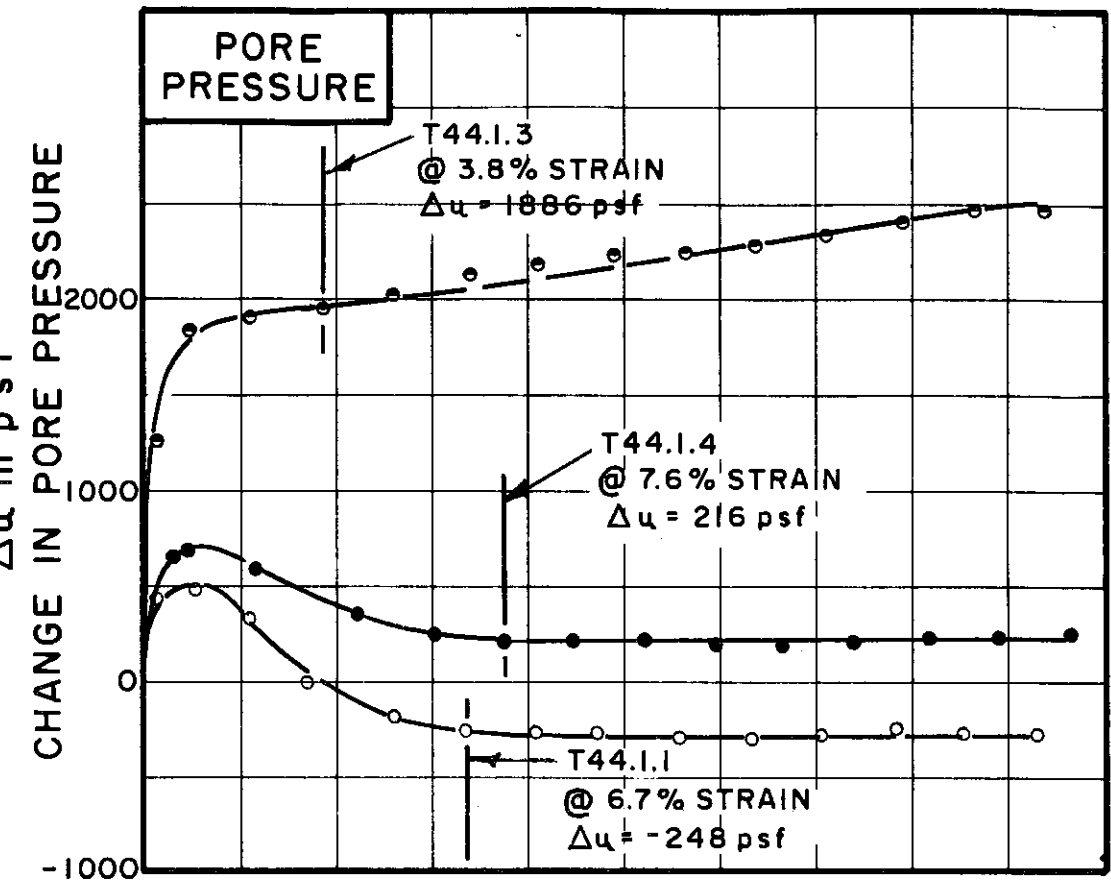
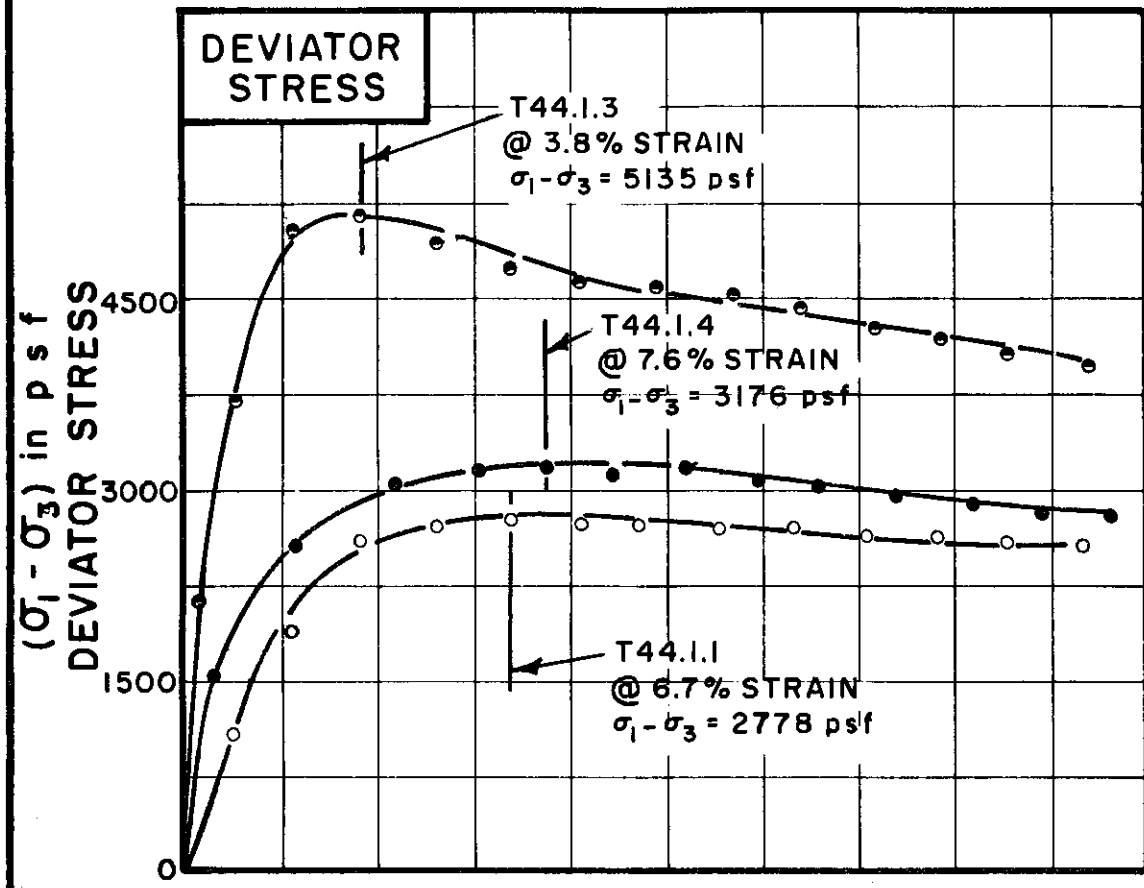

TEST NO. / SYMBOL	T44.1.1	T44.1.4	T44.1.3
-------------------	---------	---------	---------

INITIAL CONDITIONS			T44.1.1	T44.1.4	T44.1.3
WATER CONTENT	w_0		30.4%	30.6%	31.0%
DRY DENSITY	γ_d	pcf	94	95	94
SAMPLE DIAMETER	D_0	in.	1.43	1.42	1.43
SAMPLE HEIGHT	H_0	in.	3.37	3.40	3.36
CONDITIONS BEFORE SHEAR			T44.1.1	T44.1.4	T44.1.3
FINAL BACK PRESSURE	u_0	psf	10080	8640	10080
INITIAL EFFECTIVE STRESS	$\sigma'_{1,0}$ $\sigma'_{3,0}$	psf	1296 5184	2016 5184	5184 5184
VOLUMETRIC STRAIN	ϵ_{vol}		1.5%	3.6%	3.8%
PORE PRESSURE RESPONSE			98%	97%	96%
FINAL CONDITIONS			T44.1.1	T44.1.4	T44.1.3
WATER CONTENT	w_f		31.2%	30.1%	29.5%
SKETCH OF SAMPLE AT END OF TEST					

RATE OF STRAIN PERCENT / MINUTE	.024	.024	.024
---------------------------------	------	------	------

BORING NO. 60

SAMPLE NO. 4

DEPTH 21.0 TO 23.0

SOIL DESCRIPTION SILTY CLAY, (CL)

LIQUID LIMIT 43 PLASTIC LIMIT 17

CONSOLIDATED UNDRAINED
 TRIAXIAL COMPRESSION
 TESTS

THE DETROIT EDISON COMPANY
 BELLE RIVER PLANT UNITS I & II

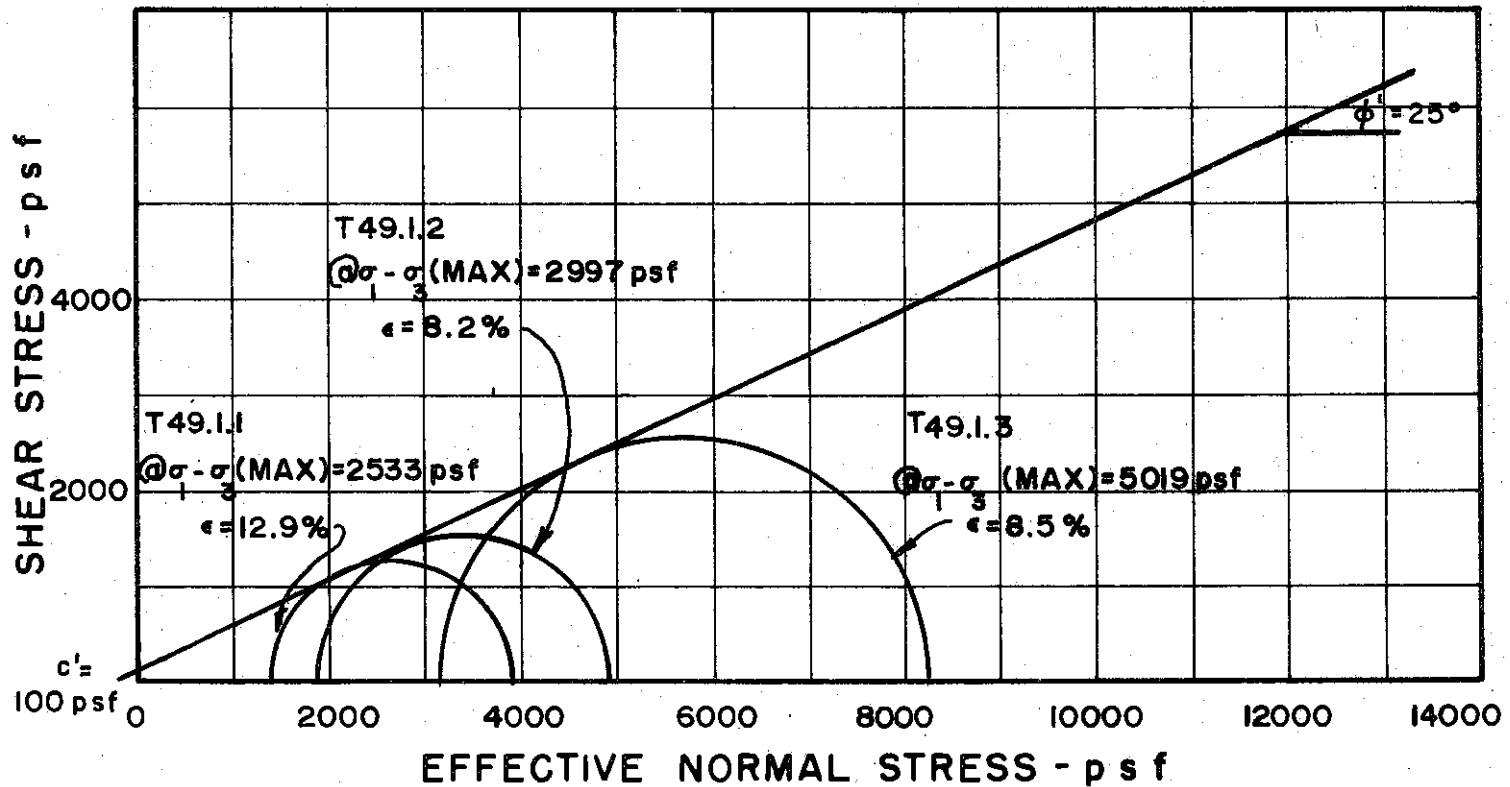
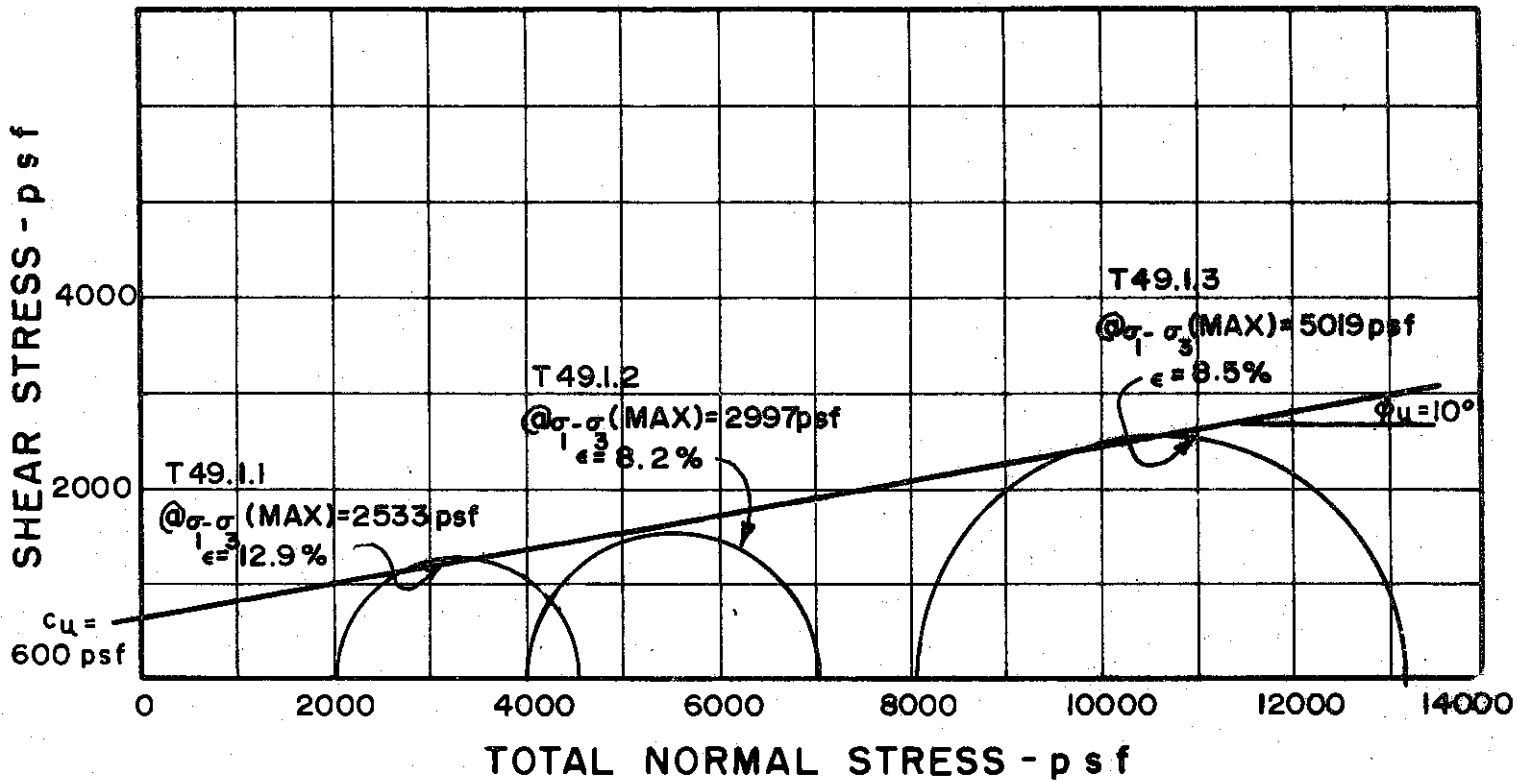

BORING NO. 60

SAMPLE NO. 9

DEPTH 45.0 TO 47.0

REMARKS ENVELOPE IS INTERPRETIVE,
BASED ON LIMITED DATA POINTS
AVAILABLE

GOLDBERG-ZOINO AND ASSOCIATES, INC.
 CONSULTANTS IN GEOTECHNICAL ENGINEERING

MOHR STRENGTH ENVELOPE
 TRIAXIAL COMPRESSION
 TESTS

THE DETROIT EDISON COMPANY
 BELLE RIVER PLANT UNITS I & II

FILE 1255

C-425

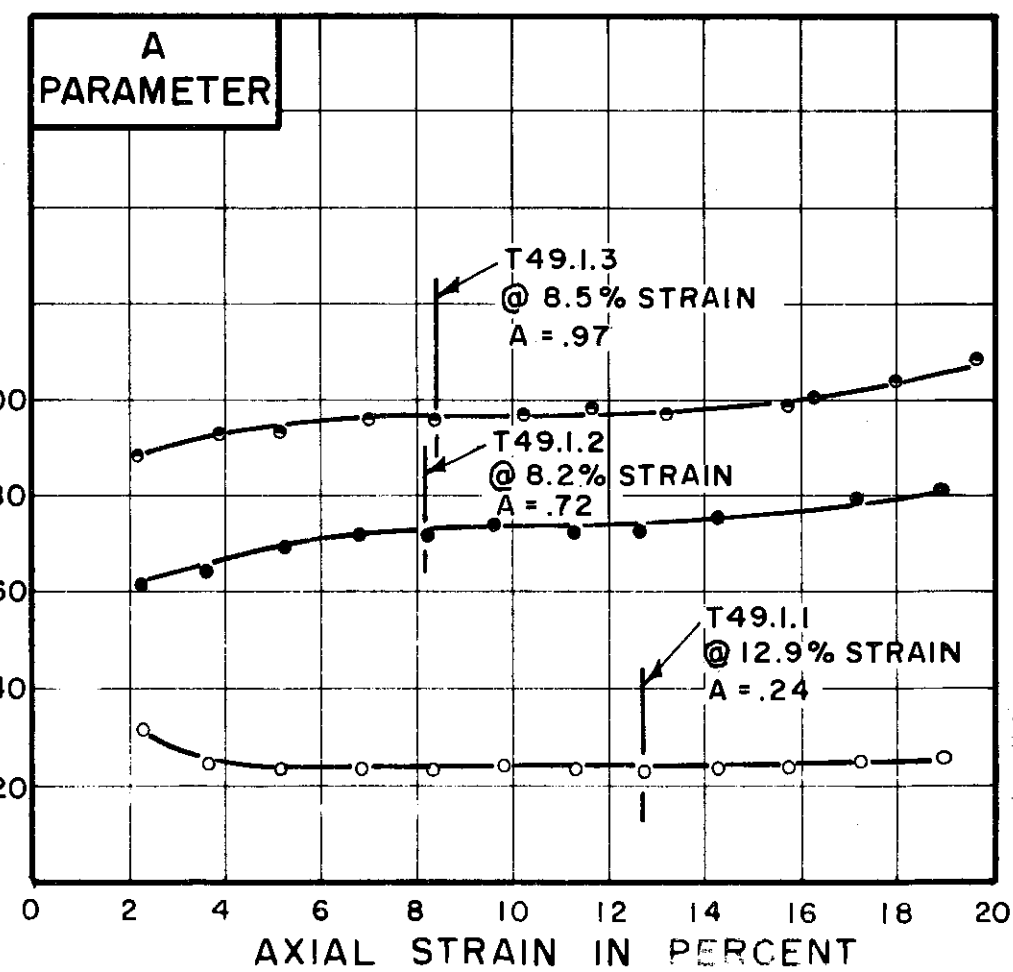
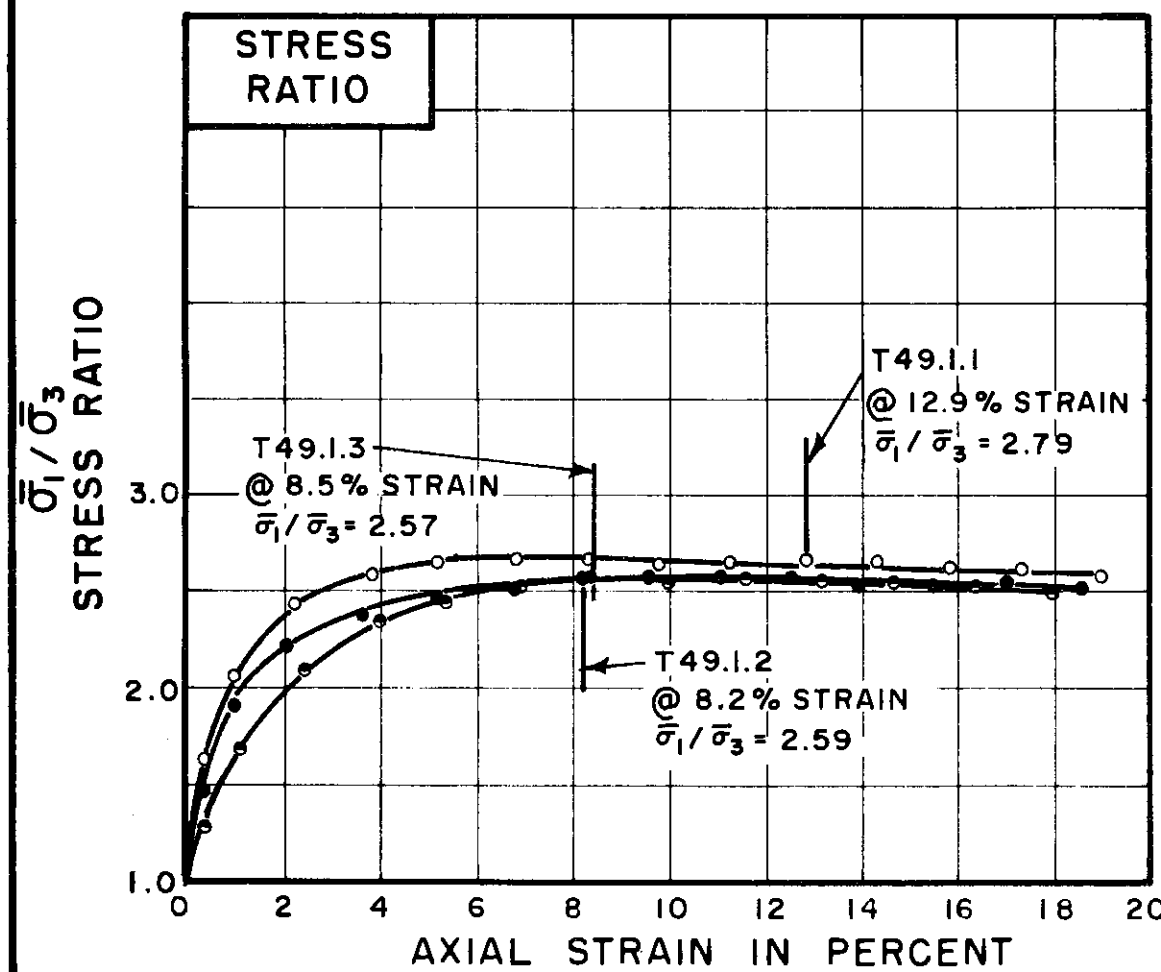
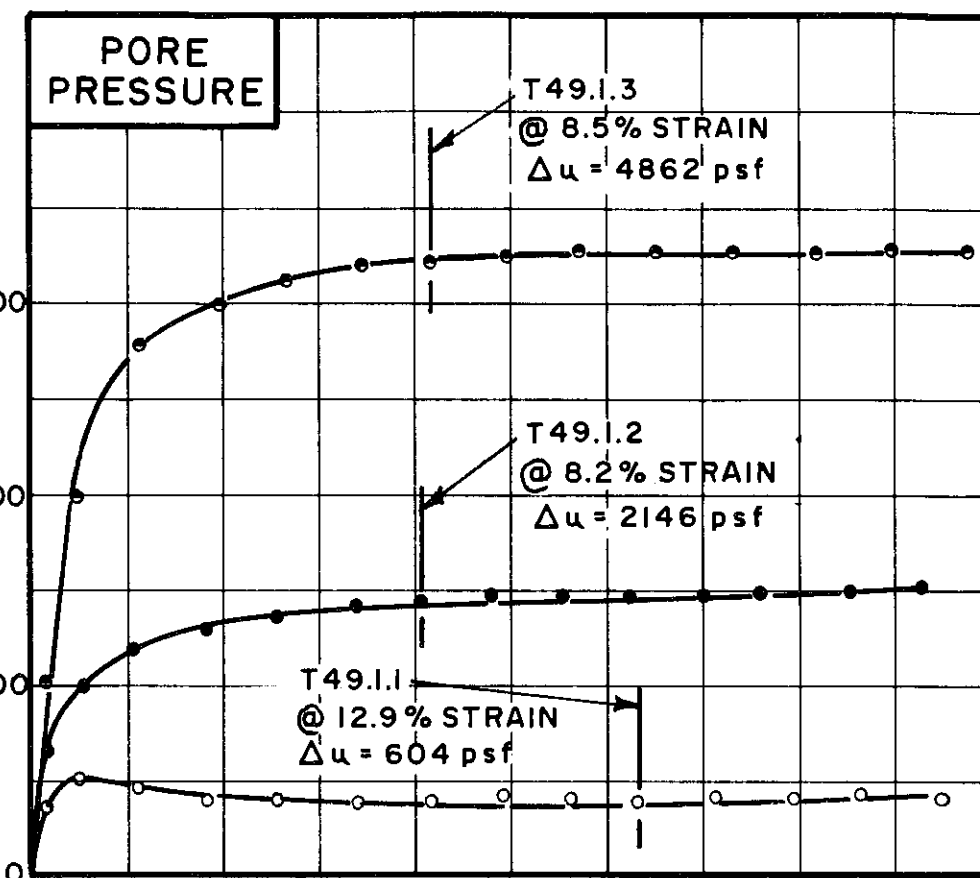
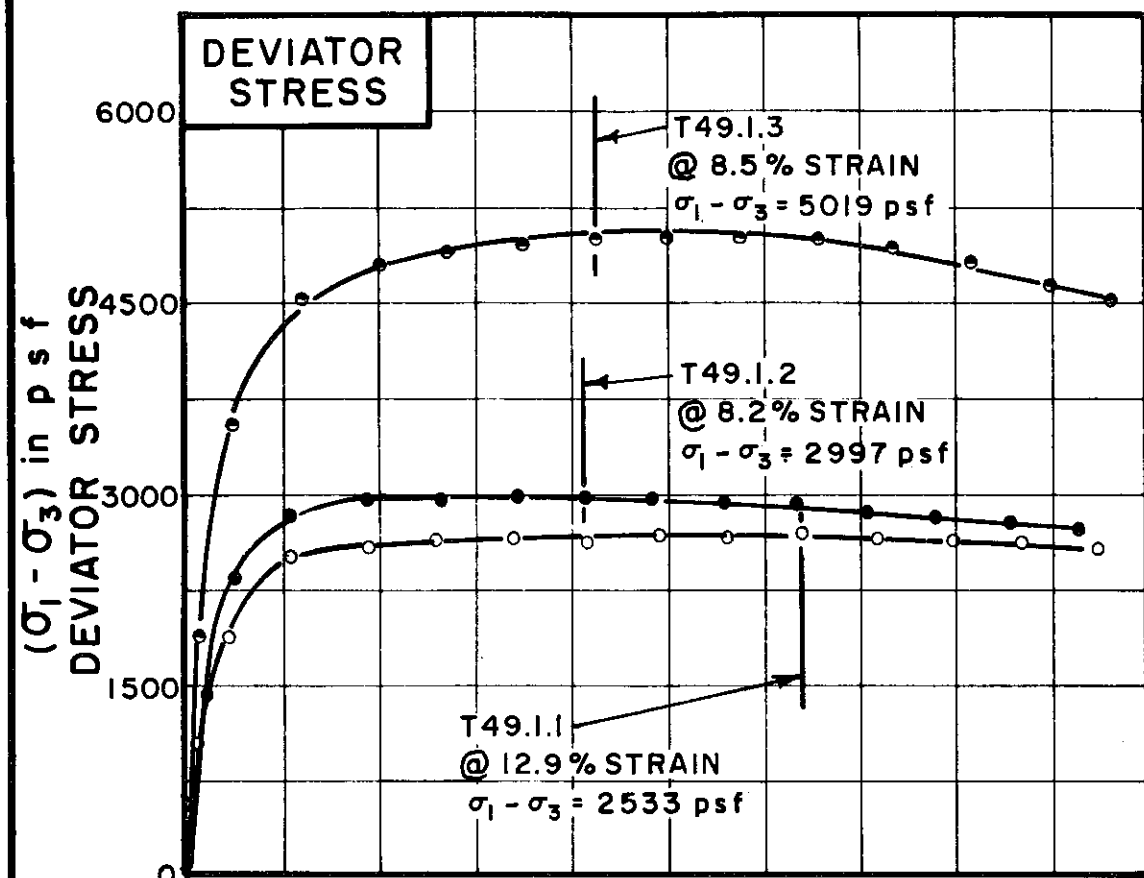

TEST NO. / SYMBOL	T49.1.1	T49.1.2	T49.1.3
-------------------	---------	---------	---------

INITIAL CONDITIONS		T49.1.1	T49.1.2	T49.1.3
WATER CONTENT	w_0	26.6%	27.0%	26.0%
DRY DENSITY	γ_d	99	98	102
SAMPLE DIAMETER	D_0	1.42	1.40	1.39
SAMPLE HEIGHT	H_0	3.32	3.40	3.26
FINAL CONDITIONS BEFORE SHEAR				
FINAL BACK PRESSURE	u_0	10080	10080	11520
INITIAL EFFECTIVE STRESS	$\bar{\sigma}_1, \bar{\sigma}_3$	2016	4032	8064
VOLUMETRIC STRAIN	ϵ_{vol}	1.9%	3.5%	5.7%
PORE PRESSURE RESPONSE		97%	96%	91%
FINAL CONDITIONS AT END OF TEST				
WATER CONTENT	w_f	26.0%	25.5%	22.6%
SKETCH OF SAMPLE AT END OF TEST				

RATE OF STRAIN PERCENT/MINUTE	.024	.024	.025
-------------------------------	------	------	------

BORING NO. 60

SAMPLE NO. 9

DEPTH 45.0 TO 47.0

SOIL DESCRIPTION SILTY CLAY, SANDY
(CL)

LIQUID LIMIT 38 PLASTIC LIMIT 16

CONSOLIDATED UNDRAINED
TRIAxIAL COMPRESSION
TESTS

THE DETROIT EDISON COMPANY
BELLE RIVER PLANT UNITS I & II

NOTE SOIL PROPERTIES OF THIS SAMPLE ARE HIGHLY VARIABLE. STRENGTH RELATIONSHIPS SHOWN HERE REPRESENT FIVE SPECIMENS TESTED.

SHEAR STRESS - p s f

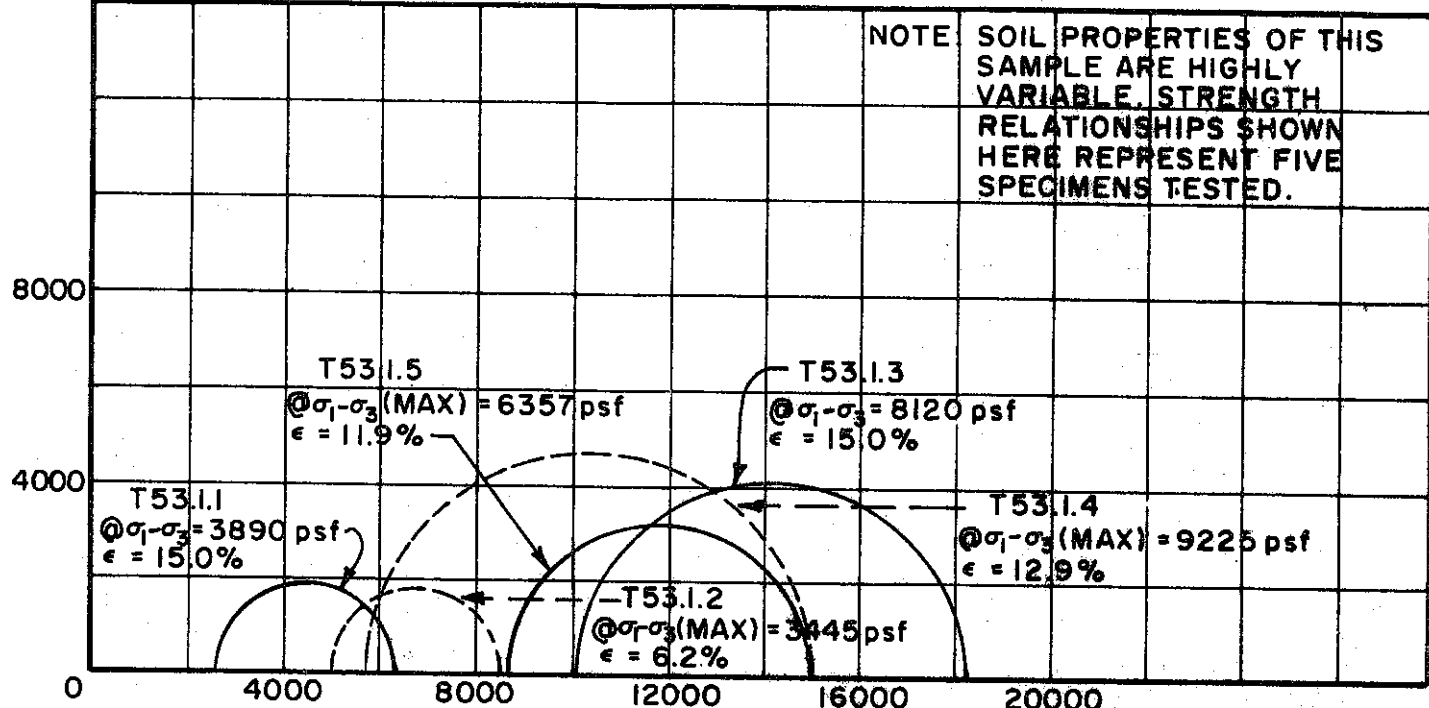

TOTAL NORMAL STRESS - p s f

SHEAR STRESS - p s f

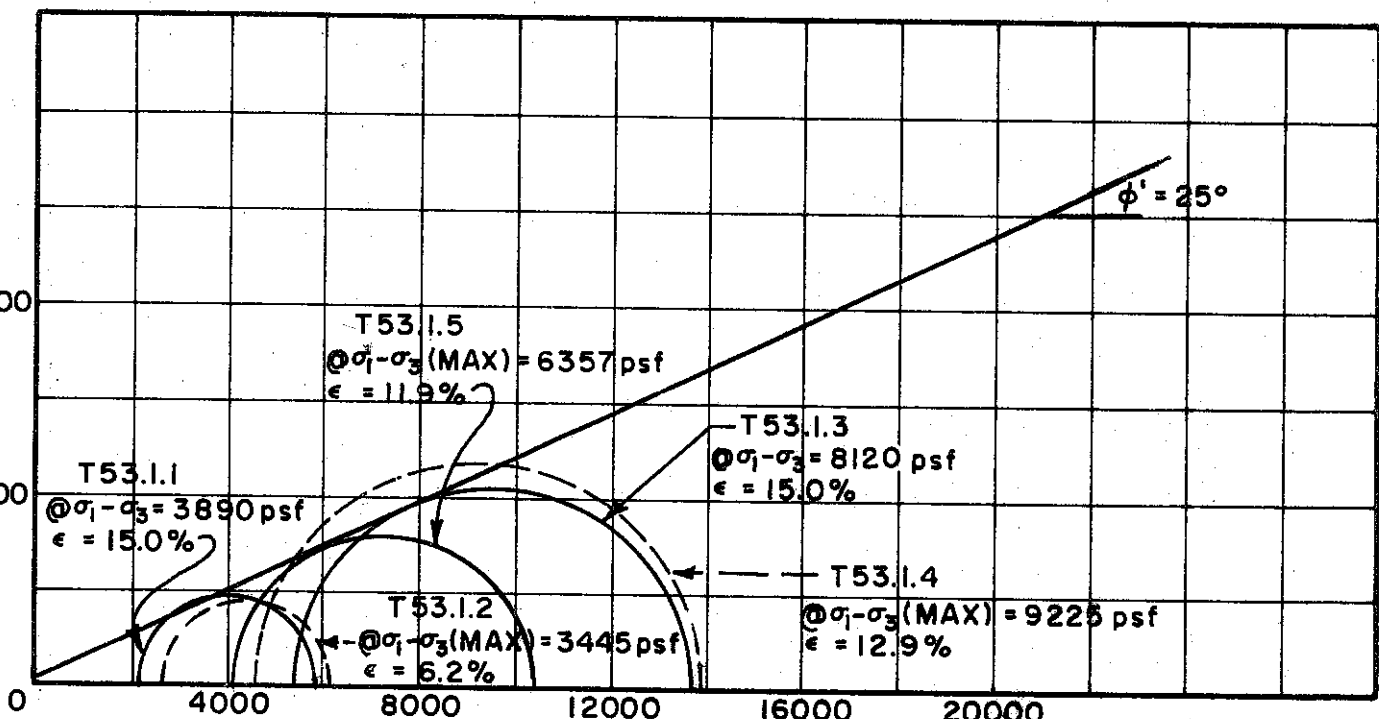

EFFECTIVE NORMAL STRESS - p s f

BORING NO. 60

SAMPLE NO. 13

DEPTH 67.0' TO 69.0'

REMARKS ENVELOPE IS INTERPRETIVE,
BASED ON DATA POINTS
AVAILABLE

GOLDBERG-ZOINO AND ASSOCIATES, INC.
CONSULTANTS IN GEOTECHNICAL ENGINEERING

MOHR STRENGTH ENVELOPE
TRIAxIAL COMPRESSION
TESTS

THE DETROIT EDISON COMPANY
BELLE RIVER PLANT UNITS I & II
FILE 1255

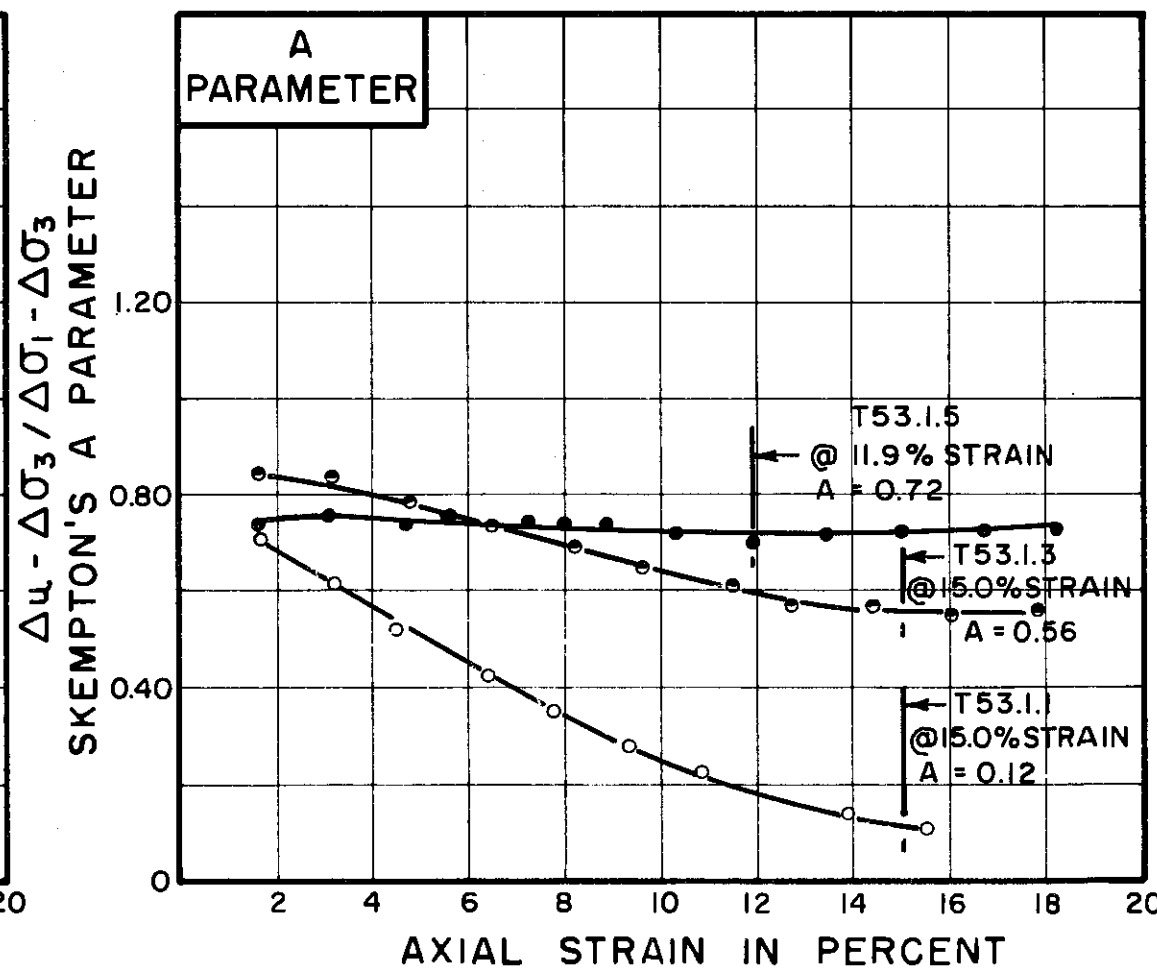
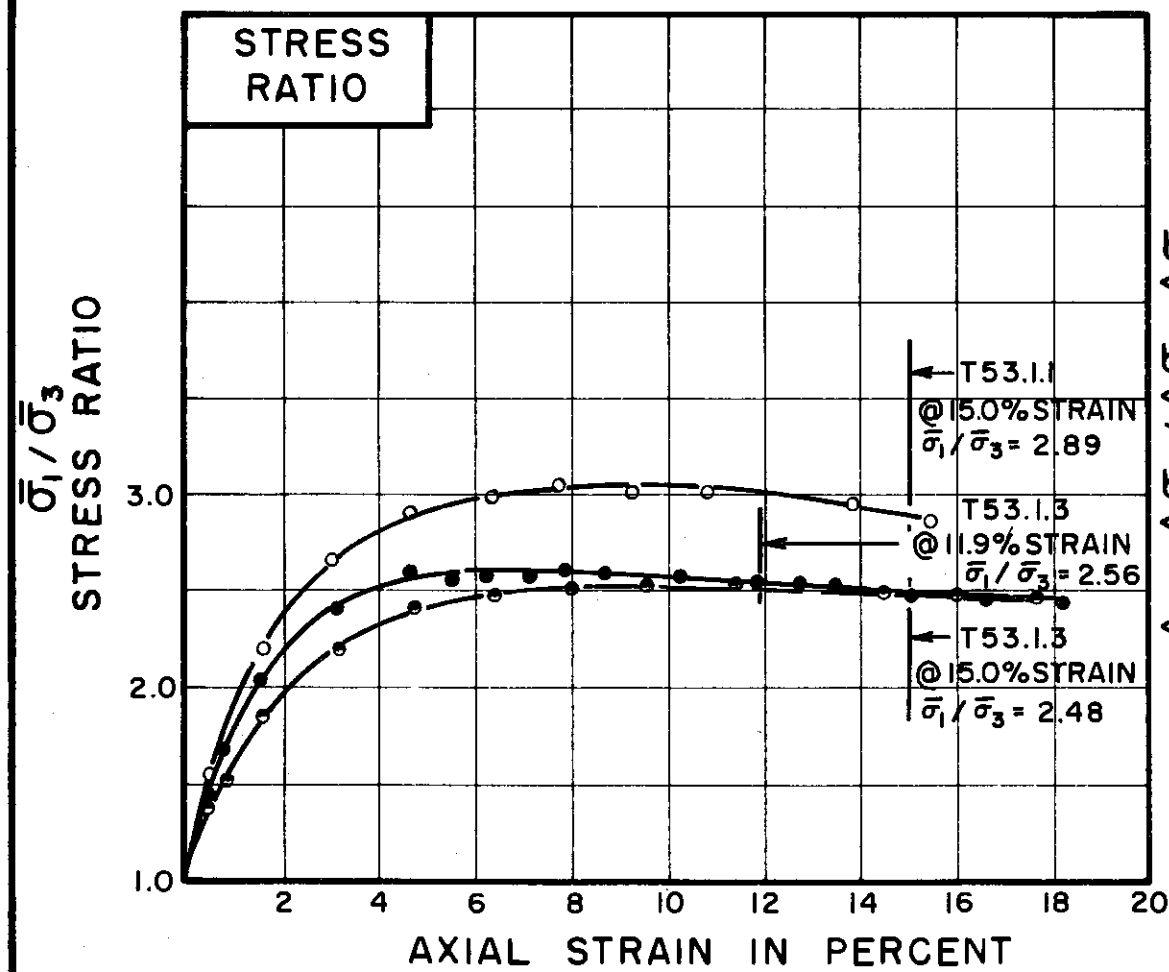
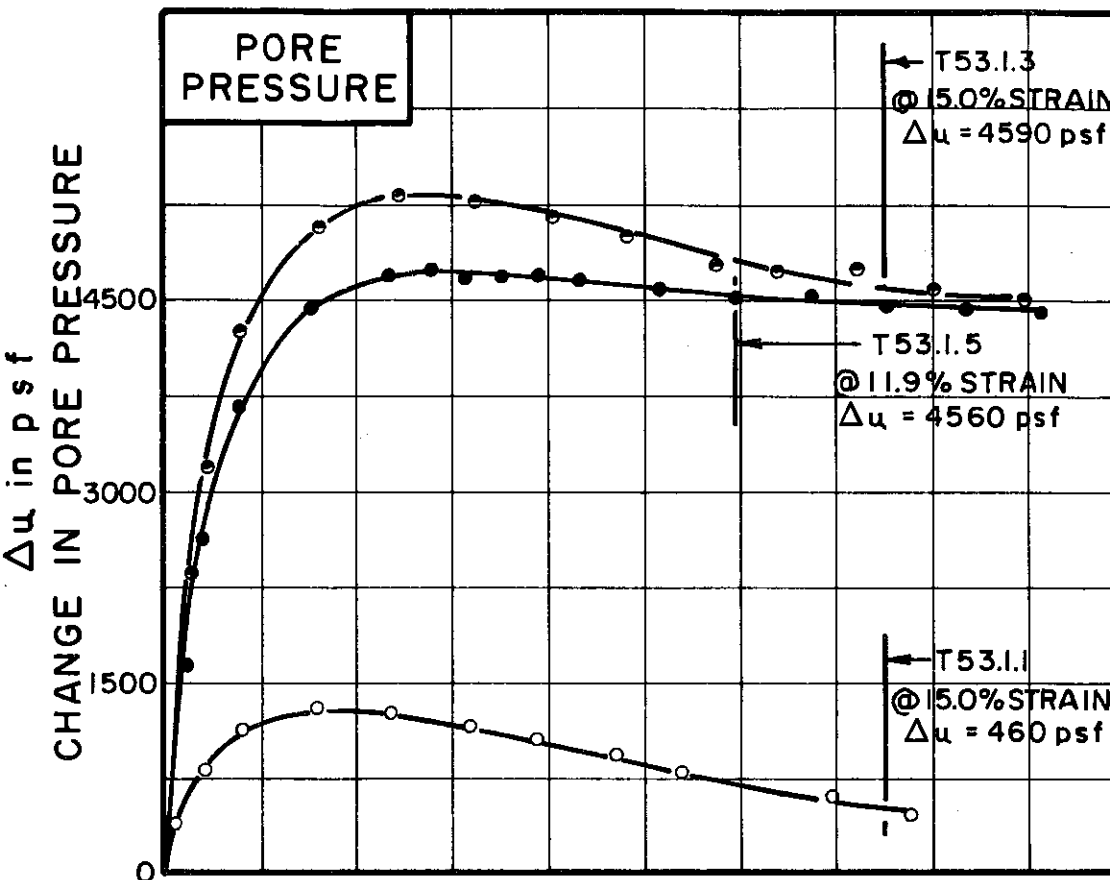
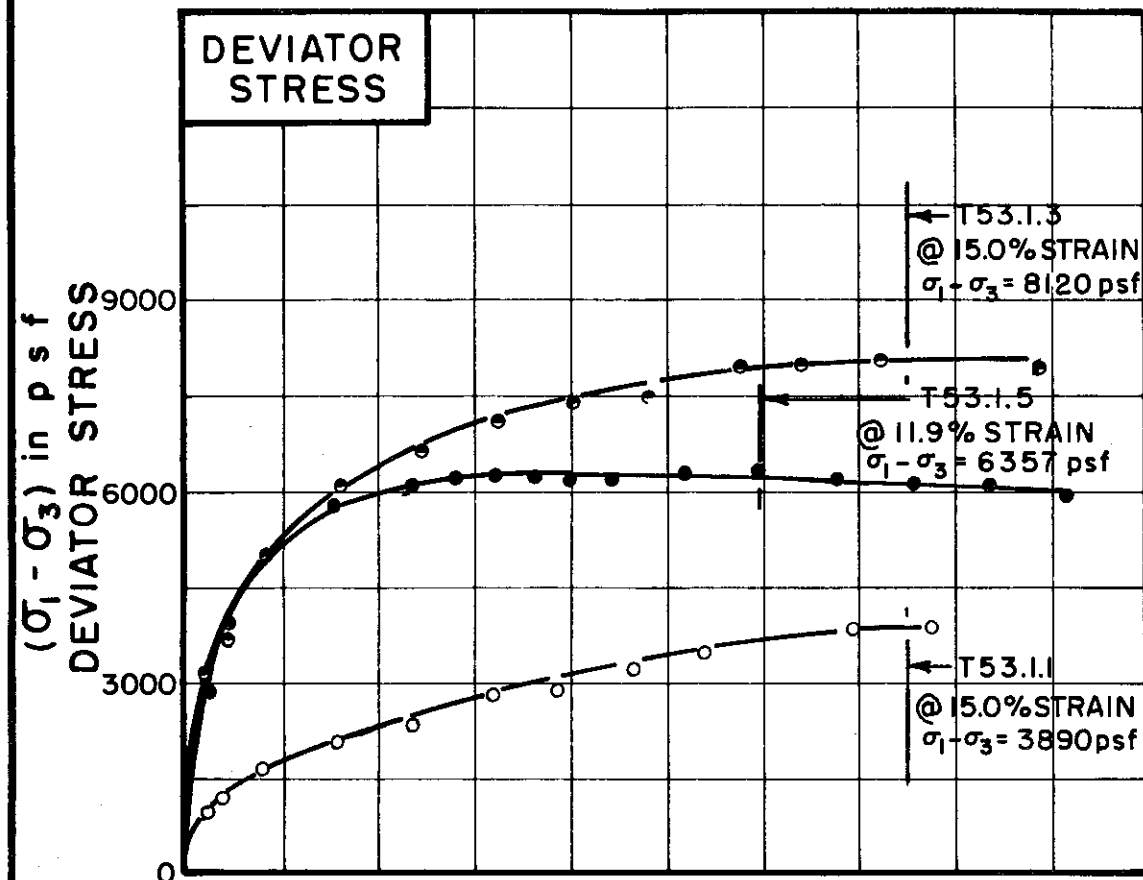

TEST NO.*/SYMBOL	T53.1.1	T53.1.5	T53.1.3
------------------	---------	---------	---------

INITIAL CONDITIONS		T53.1.1	T53.1.5	T53.1.3
WATER CONTENT	w_0	23.6%	21.0%	19.7%
DRY DENSITY	γ_d pcf	103	104	104
SAMPLE DIAMETER	D_0 in.	1.42	1.42	1.41
SAMPLE HEIGHT	H_0 in.	3.25	3.19	3.20
FINAL CONDITIONS BEFORE SHEAR				
FINAL BACK PRESSURE	u_0 p.s.f.	7200	8640	7200
INITIAL EFFECTIVE STRESS	σ_1, σ_3 p.s.f.	2520	8640	10080
VOLUMETRIC STRAIN	ϵ_{vol}	3.0%	5.0%	6.1%
PORE PRESSURE RESPONSE		97%	100%	100%
FINAL CONDITIONS AT END OF TEST				
WATER CONTENT	w_f	21.7%	18.9%	17.6%
SKETCH OF SAMPLE AT END OF TEST				

RATE OF STRAIN PERCENT/MINUTE	.025	.025	.025
-------------------------------	------	------	------

BORING NO. 60
 SAMPLE NO. 13
 DEPTH 67.0' TO 69.0'

SOIL DESCRIPTION SILTY CLAY, GRAVELLY
 (CL-ML)

LIQUID LIMIT _____ PLASTIC LIMIT _____
 * NOTE: SOIL PROPERTIES OF THIS SAMPLE ARE HIGHLY VARIABLE-SEE DATA FOR TESTS T53.1.2 AND T53.1.4

CONSOLIDATED UNDRAINED
 TRIAXIAL COMPRESSION
 TESTS

THE DETROIT EDISON COMPANY
 BELLE RIVER PLANT UNITS I & II

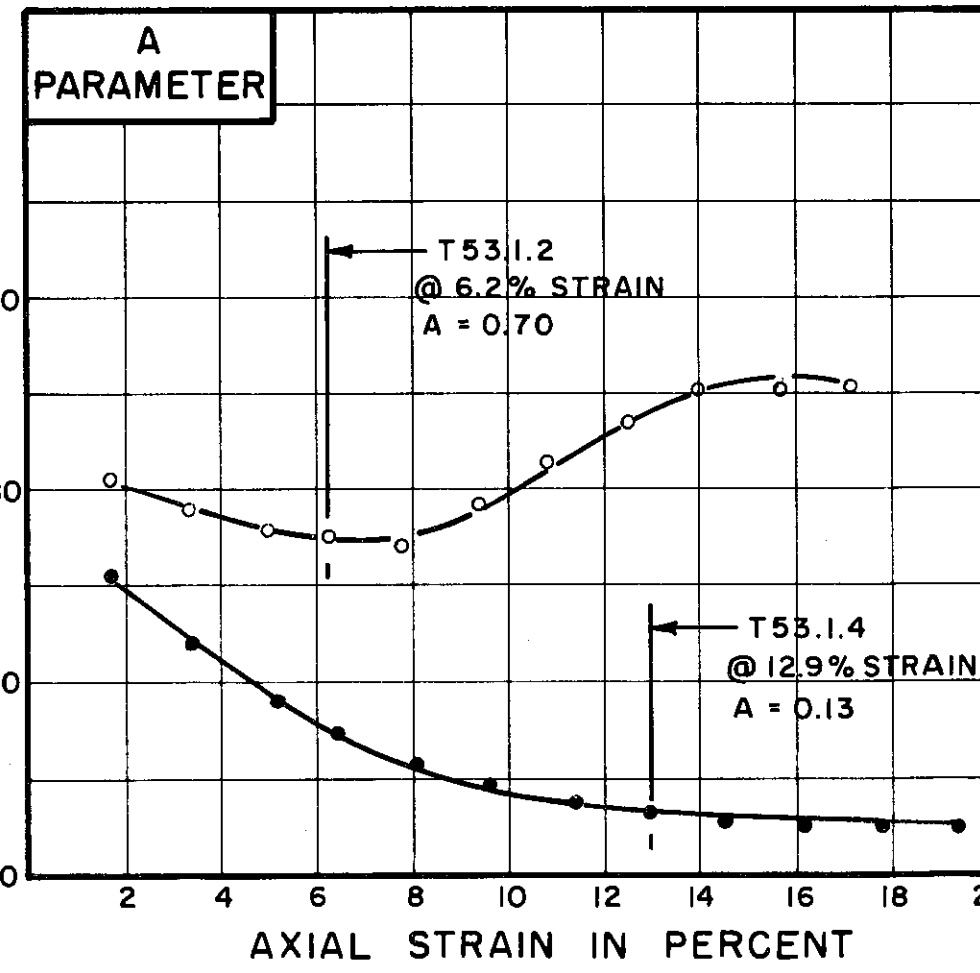
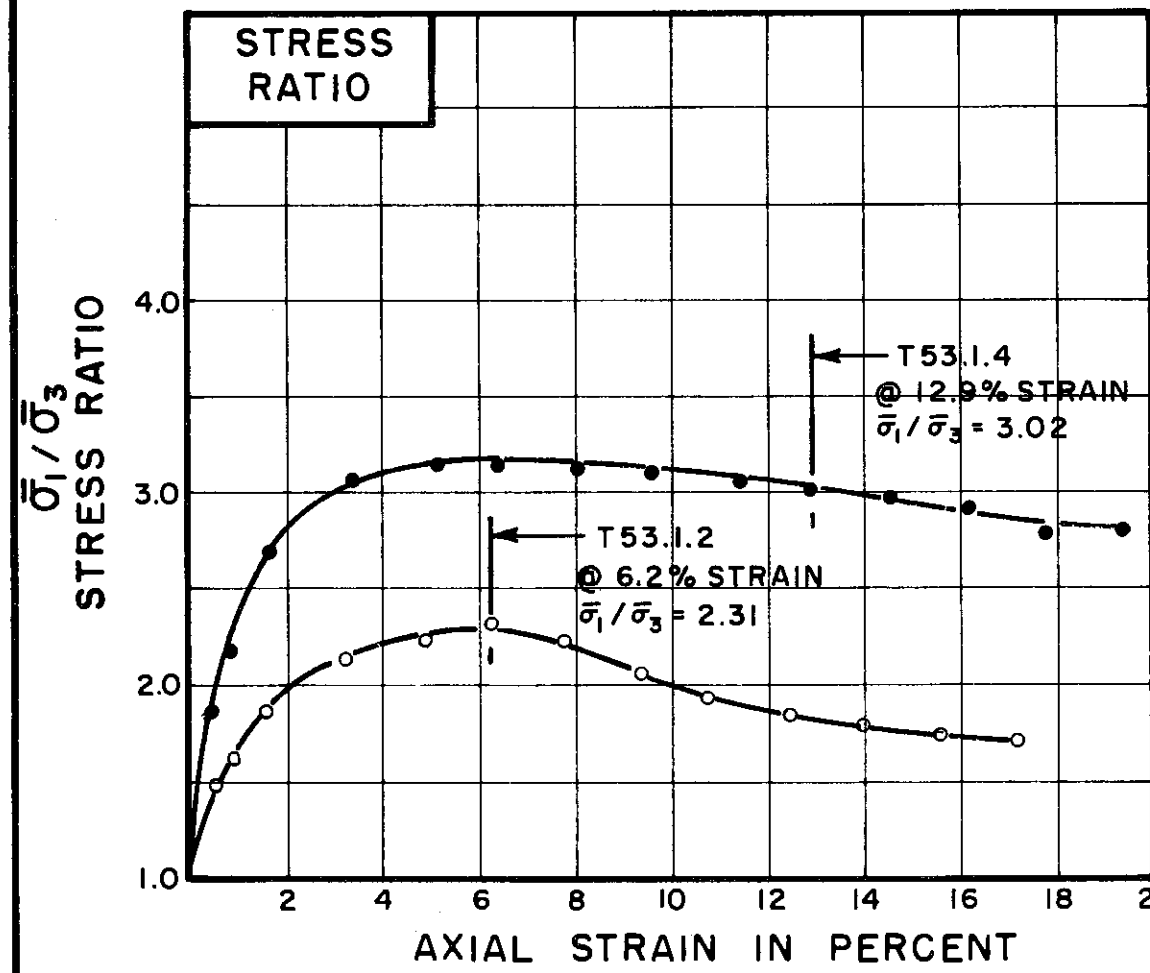
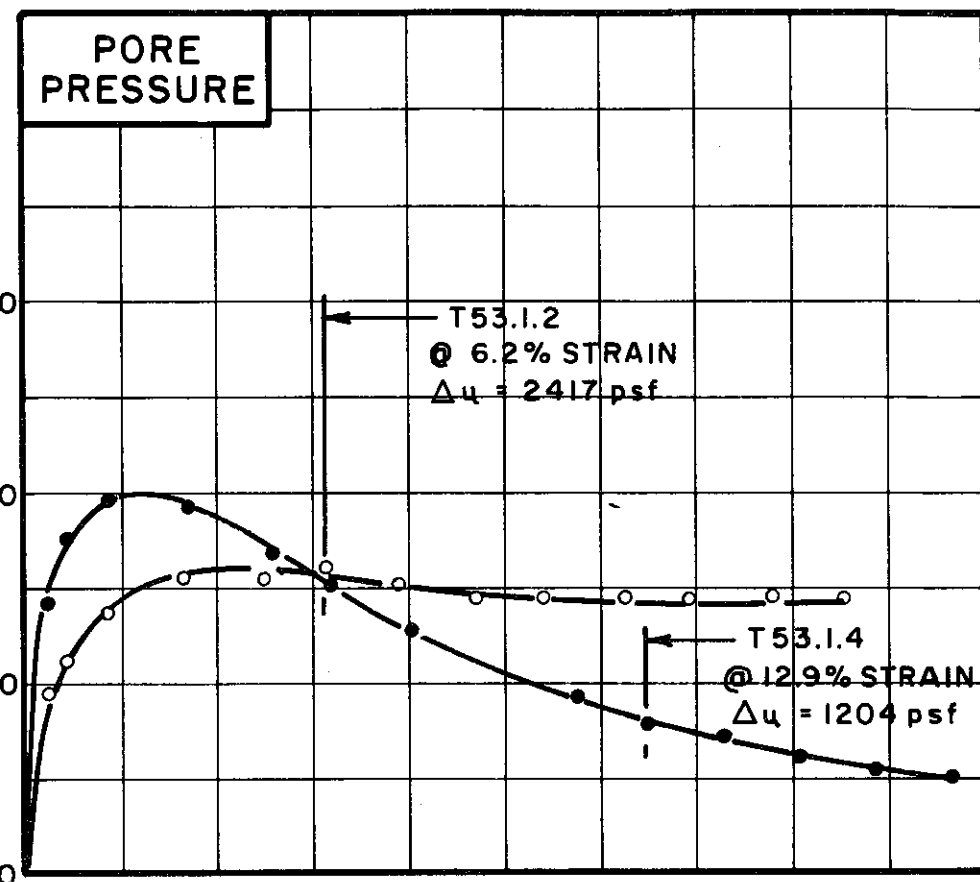
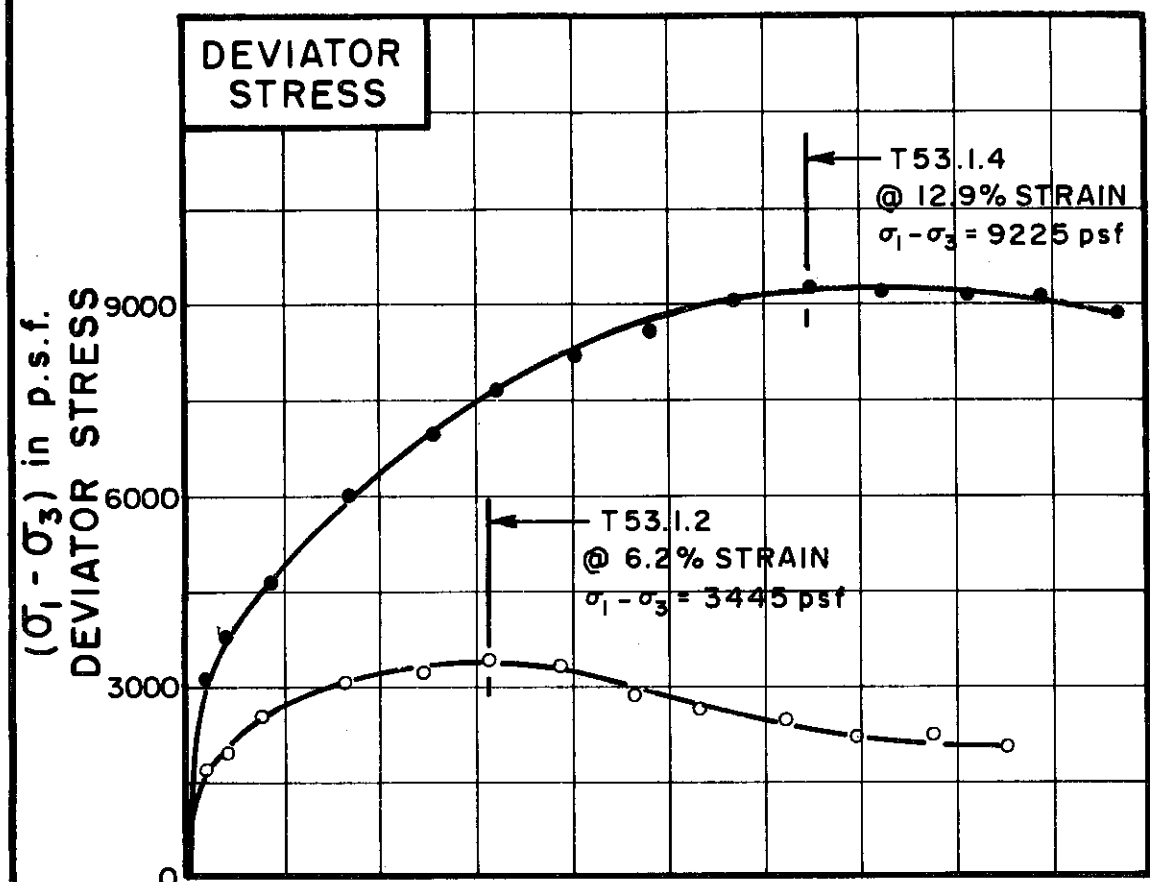

TEST NO. 7	SYMBOL	T53.1.2	T53.1.4
------------	--------	---------	---------

INITIAL CONDITIONS			T53.1.2	T53.1.4
WATER CONTENT	w_0	31.9%	%	15.5%
DRY DENSITY	γ_d	91		114
SAMPLE DIAMETER	D_0	1.41		1.40
SAMPLE HEIGHT	H_0	3.28		3.15
FINAL CONDITIONS BEFORE SHEAR			T53.1.2	T53.1.4
FINAL BACK PRESSURE	u_0	8640		11,520
INITIAL EFFECTIVE STRESS	$\bar{\sigma}_1 = \bar{\sigma}_3$	5040		5760
VOLUMETRIC STRAIN	ϵ_{vol}	5.3%	%	2.4%
PORE PRESSURE RESPONSE		97%		93%
FINAL CONDITIONS			T53.1.2	T53.1.4
WATER CONTENT	w_f	28.4%	%	14.9%
SKETCH OF SAMPLE AT END OF TEST				

RATE OF STRAIN PERCENT / MINUTE	.025	.026
---------------------------------	------	------

BORING NO. 60
 SAMPLE NO. 13
 DEPTH 67.0' TO 69.0'

SOIL DESCRIPTION T53.1.2-CLAYEY GRAVEL(GC)
T53.1.4-SILTY CLAY(CL)

LIQUID LIMIT (40) PLASTIC LIMIT (19)

* NOTE: SOIL PROPERTIES OF THIS SAMPLE ARE HIGHLY VARIABLE - SEE DATA FOR T53.1.1, T53.1.3 AND T53.1.5

CONSOLIDATED UNDRAINED TRIAXIAL COMPRESSION TESTS

THE DETROIT EDISON COMPANY
 BELLE RIVER PLANT UNITS I & II

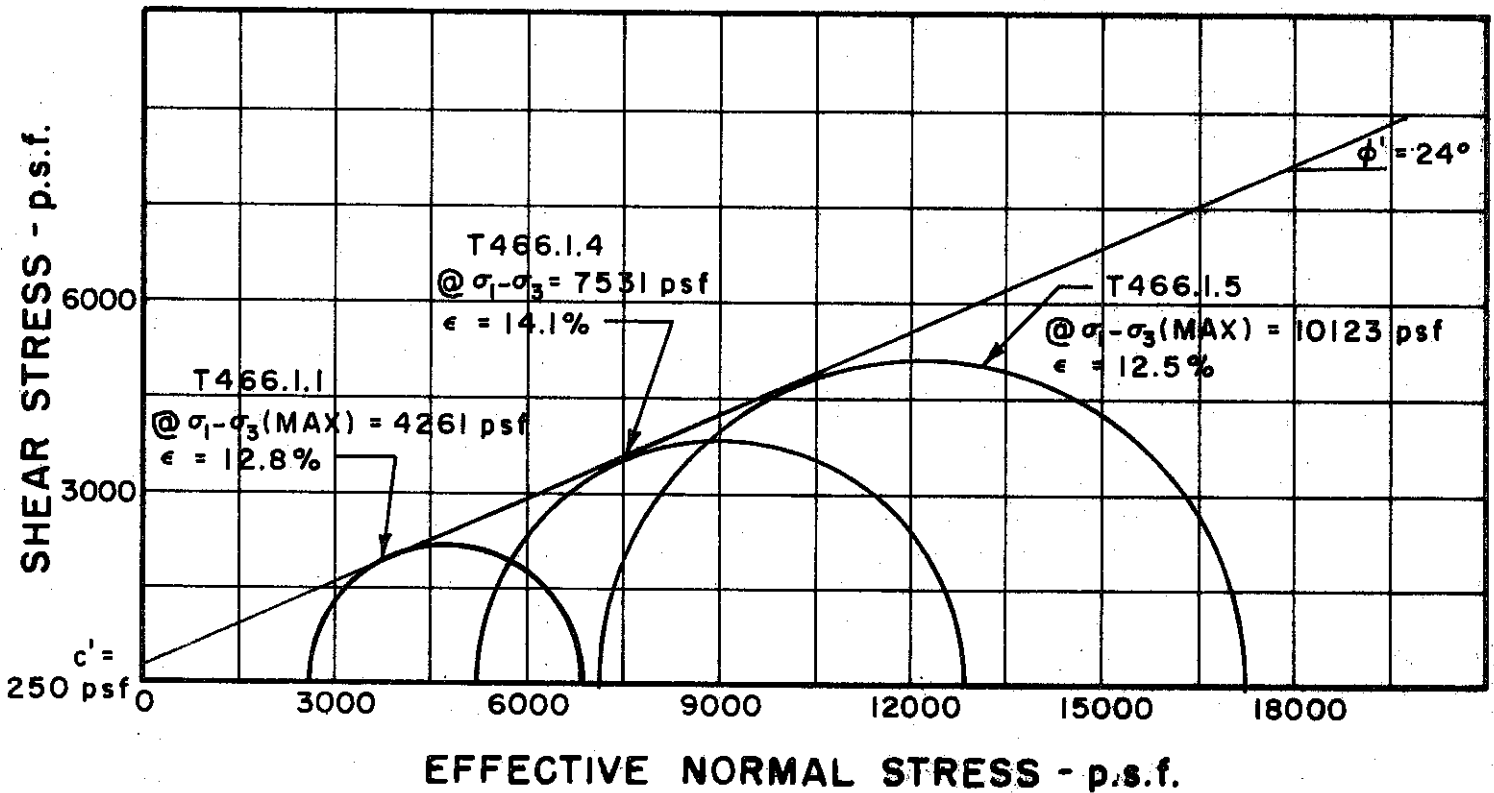
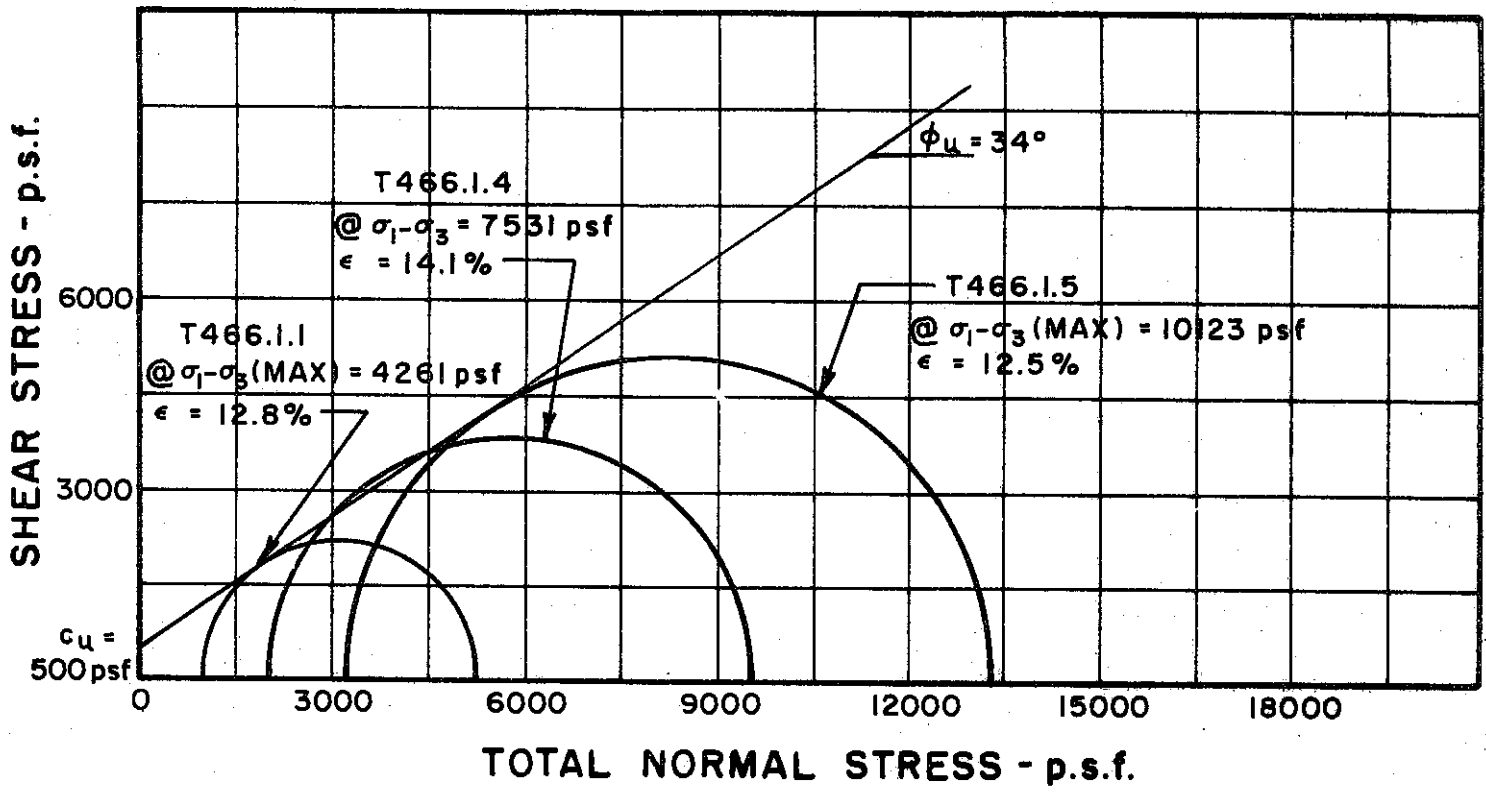

BORING NO. 101,105,127,128,180 & 183
 SAMPLE NO. COMBINED SAMPLES
 DEPTH 2.0' TO 10.0'

**MOHR STRENGTH ENVELOPE
 TRIAXIAL COMPRESSION
 TESTS**

REMARKS ENVELOPE IS INTERPRETIVE
 BASED ON LIMITED DATA POINTS
 AVAILABLE
 GOLDBERG-ZOINO AND ASSOCIATES, INC.
 CONSULTANTS IN GEOTECHNICAL ENGINEERING

THE DETROIT EDISON COMPANY
 BELLE RIVER PLANT UNITS I & II
 FILE 1255
 C-430

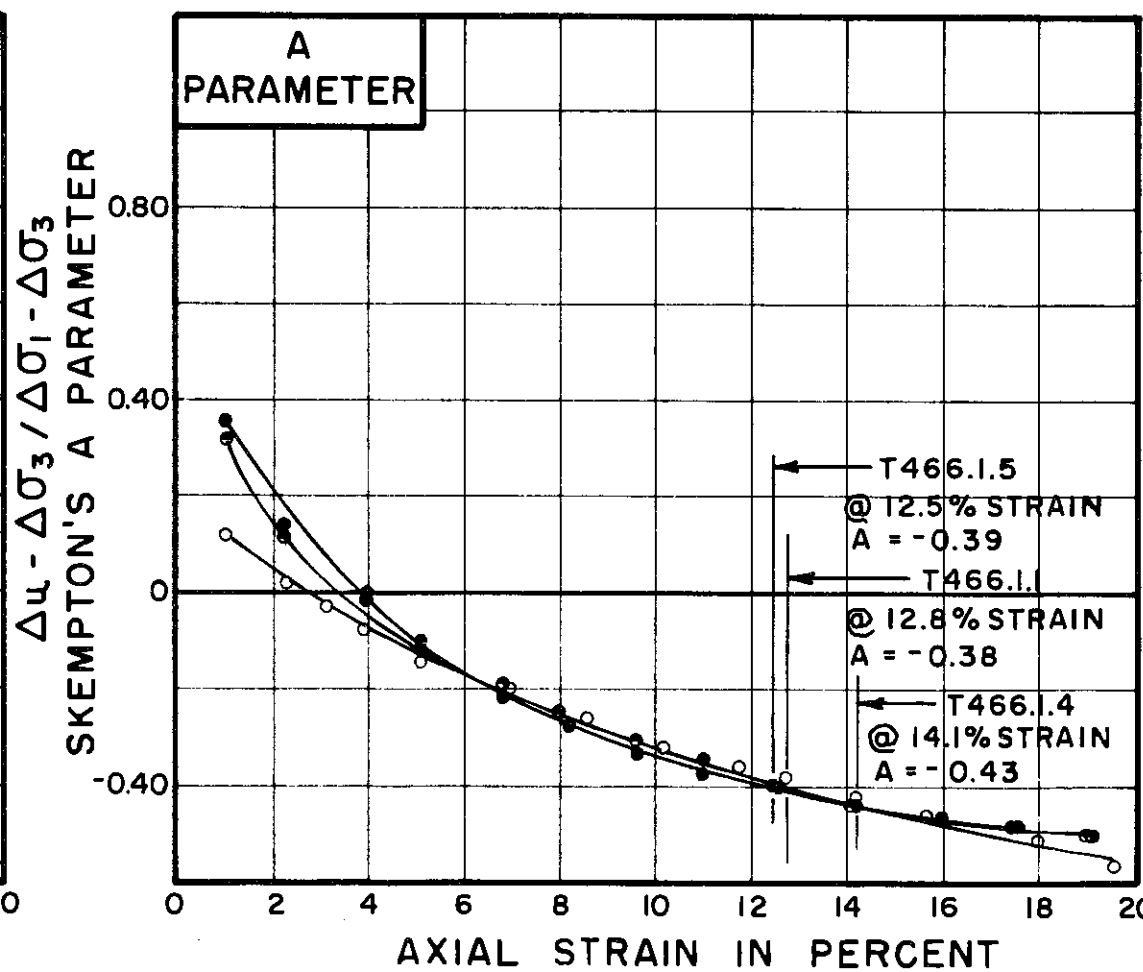
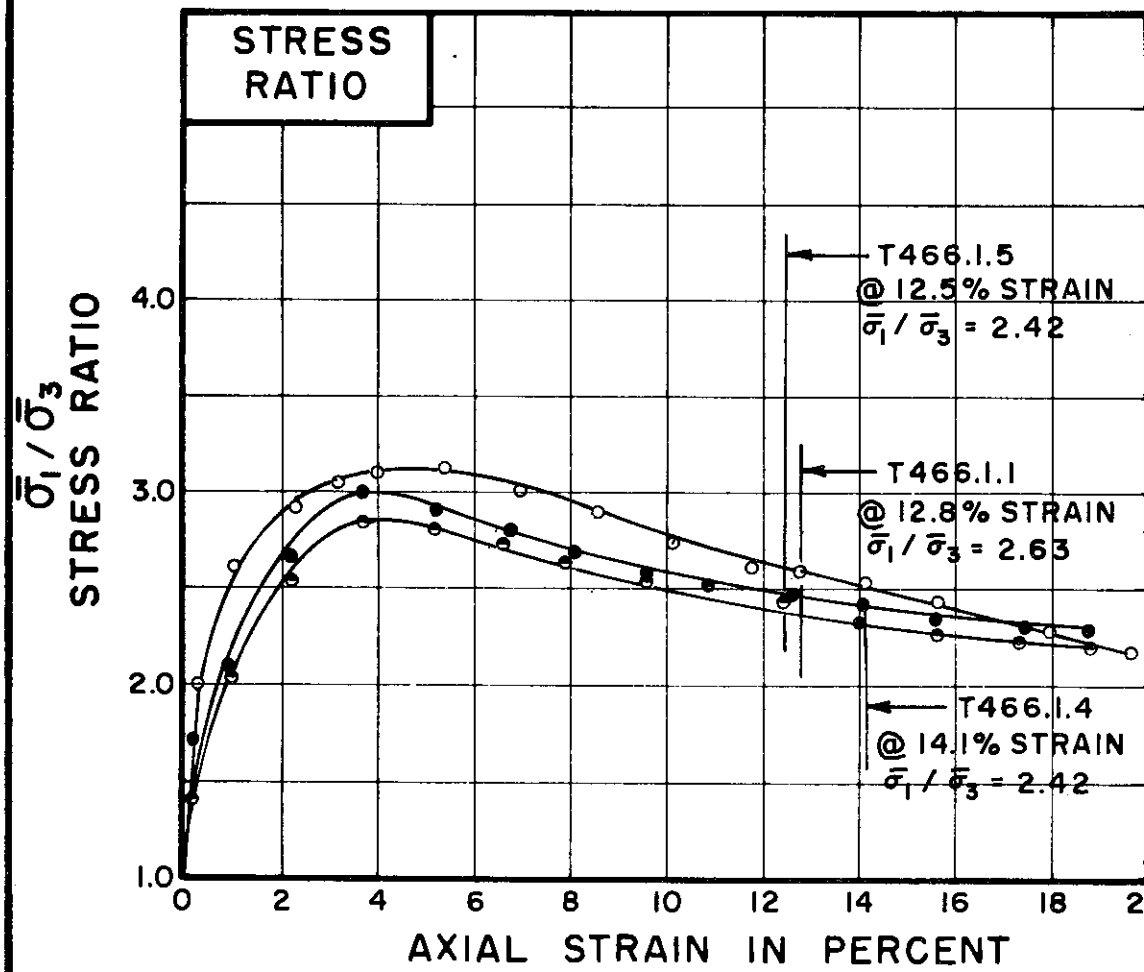
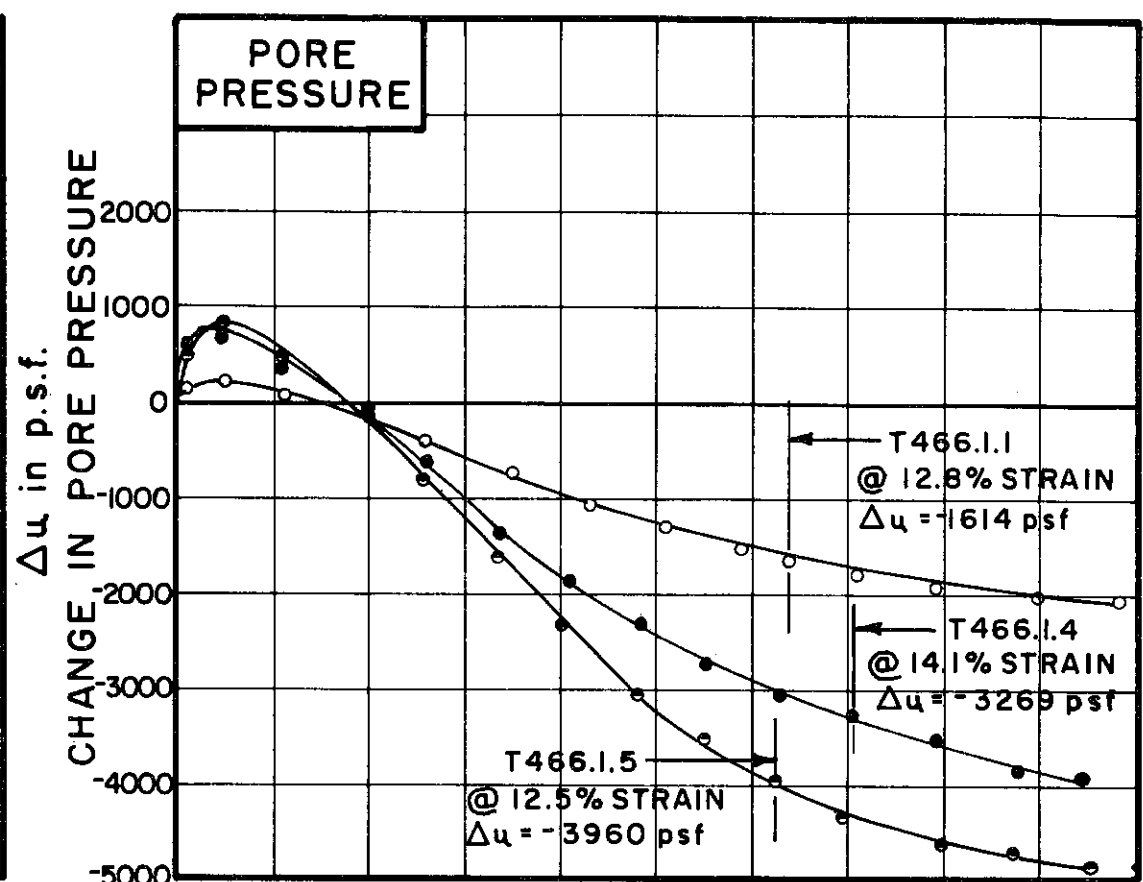
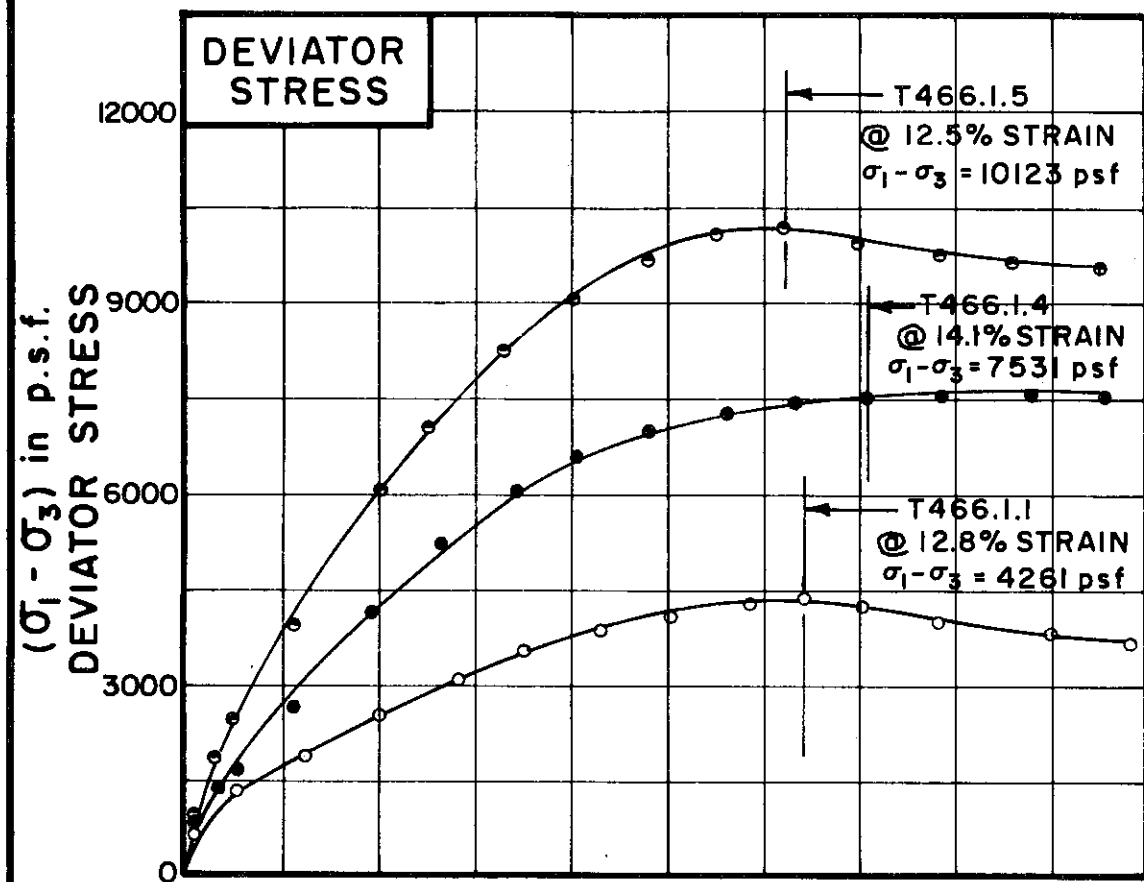

TEST NO. / SYMBOL	T466.1.1	T466.1.4	T466.1.5
-------------------	----------	----------	----------

INITIAL CONDITIONS			T466.1.1	T466.1.4	T466.1.5
WATER CONTENT	w_0		15.3%	15.5%	15.9%
DRY DENSITY	γ_d	pcf	113	114	114
SAMPLE DIAMETER	D_0	in.	1.38	1.39	1.40
SAMPLE HEIGHT	H_0	in.	3.19	3.36	3.44
FINAL CONDITIONS BEFORE SHEAR					
FINAL BACK PRESSURE	u_0	p.s.f.	7200	7200	7200
INITIAL EFFECTIVE STRESS	$\bar{\sigma}_1 = \bar{\sigma}_3$	p.s.f.	1008	2016	3168
VOLUMETRIC STRAIN	ϵ_{vol}	%	—	.14	.14
PORE PRESSURE RESPONSE		%	98	99	98
FINAL CONDITIONS					
WATER CONTENT	w_f	%	21.3	19.1	18.4
SKETCH OF SAMPLE AT END OF TEST					

RATE OF STRAIN PERCENT/MINUTE	.025	.024	.023
-------------------------------	------	------	------

BORING NO. 101, 105, 127, 128, 180 & 183
 SAMPLE NO. COMBINED SAMPLES
 DEPTH 2.0' TO 10.0'

SOIL DESCRIPTION SILTY CLAY (CL-CH)

LIQUID LIMIT _____ PLASTIC LIMIT _____
 SEE DATA FOR INDIVIDUAL SAMPLES

CONSOLIDATED UNDRAINED
 TRIAXIAL COMPRESSION
 TESTS

THE DETROIT EDISON COMPANY
 BELLE RIVER PLANT UNITS I & II

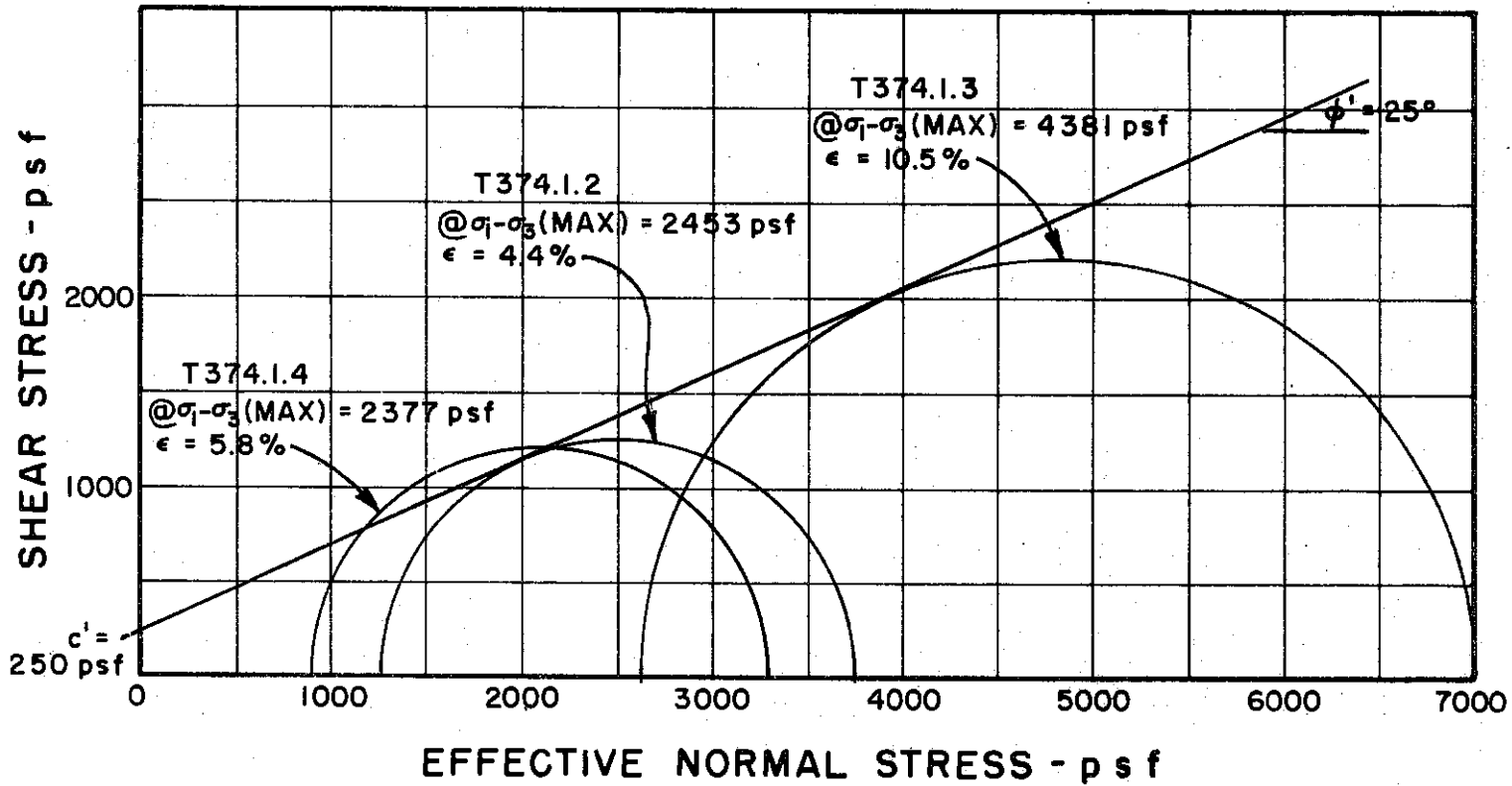
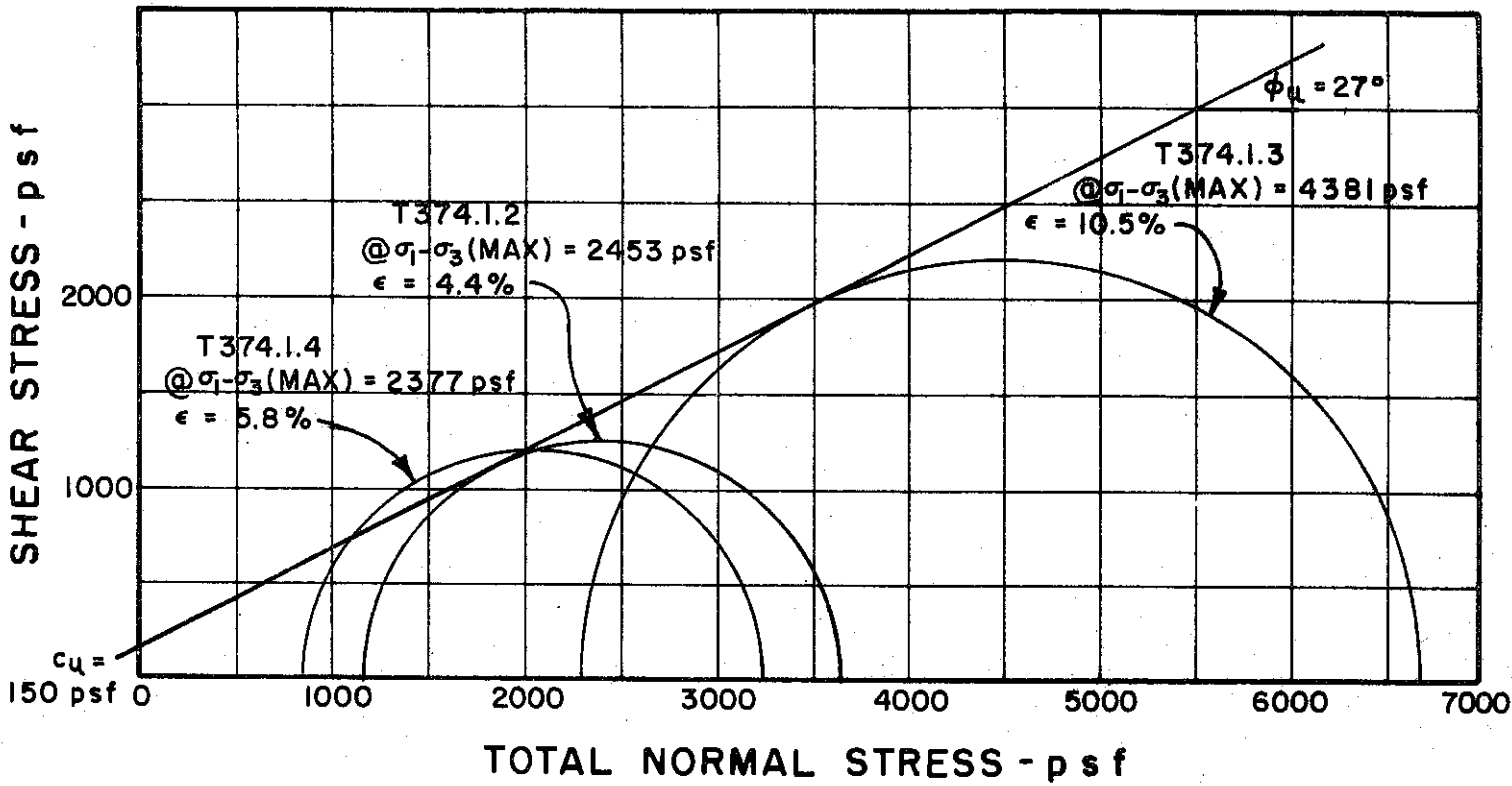

BORING NO. 105

SAMPLE NO. 2

DEPTH 9.0' TO 11.0'

REMARKS ENVELOPE IS INTERPRETIVE,
BASED ON LIMITED DATA POINTS
AVAILABLE

GOLDBERG-ZOINO AND ASSOCIATES, INC.
 CONSULTANTS IN GEOTECHNICAL ENGINEERING

MOHR STRENGTH ENVELOPE
 TRIAXIAL COMPRESSION
 TESTS

THE DETROIT EDISON COMPANY
 BELLE RIVER PLANT UNITS I & II

FILE 1255

C-432

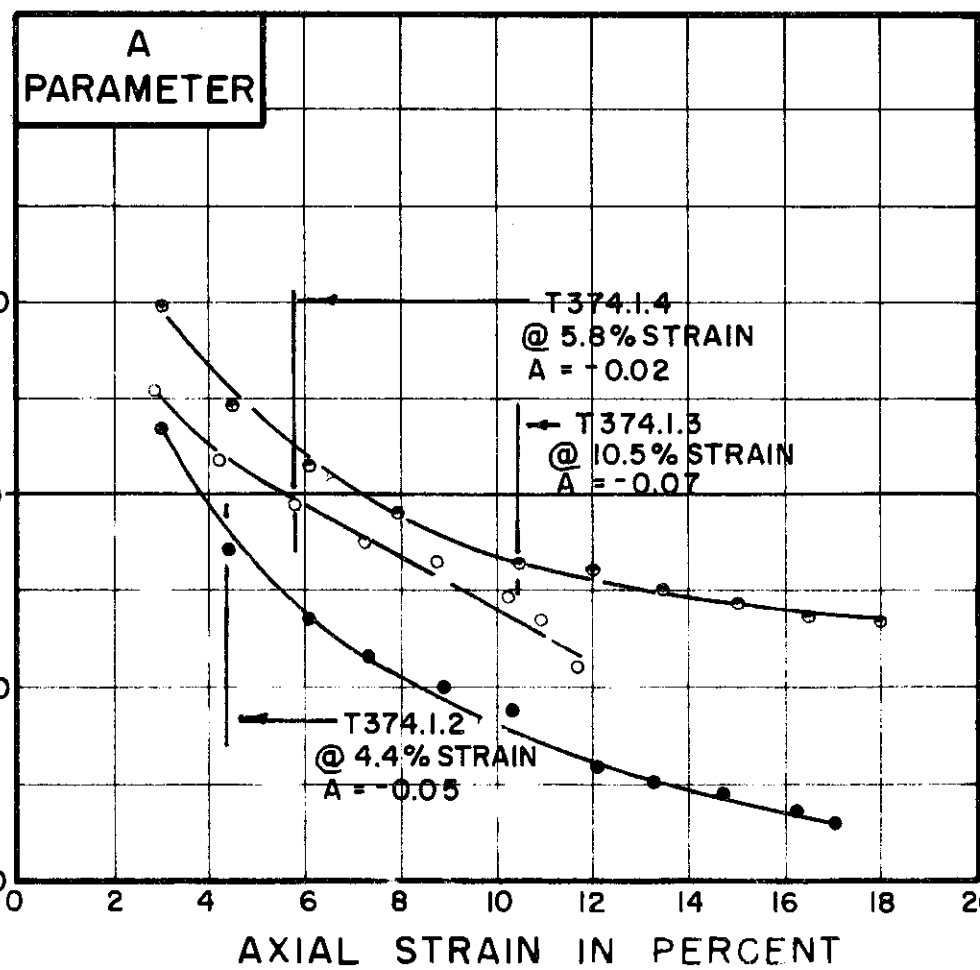
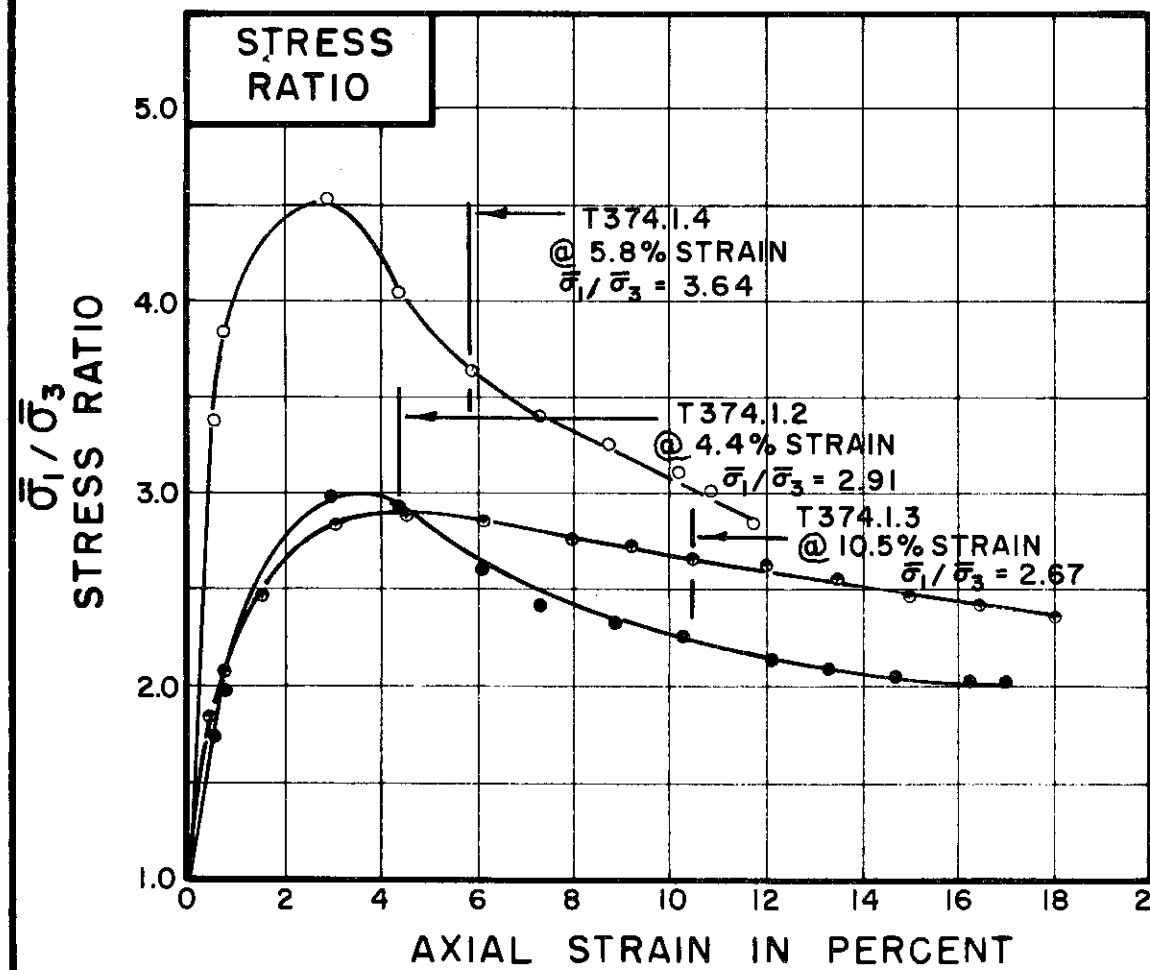
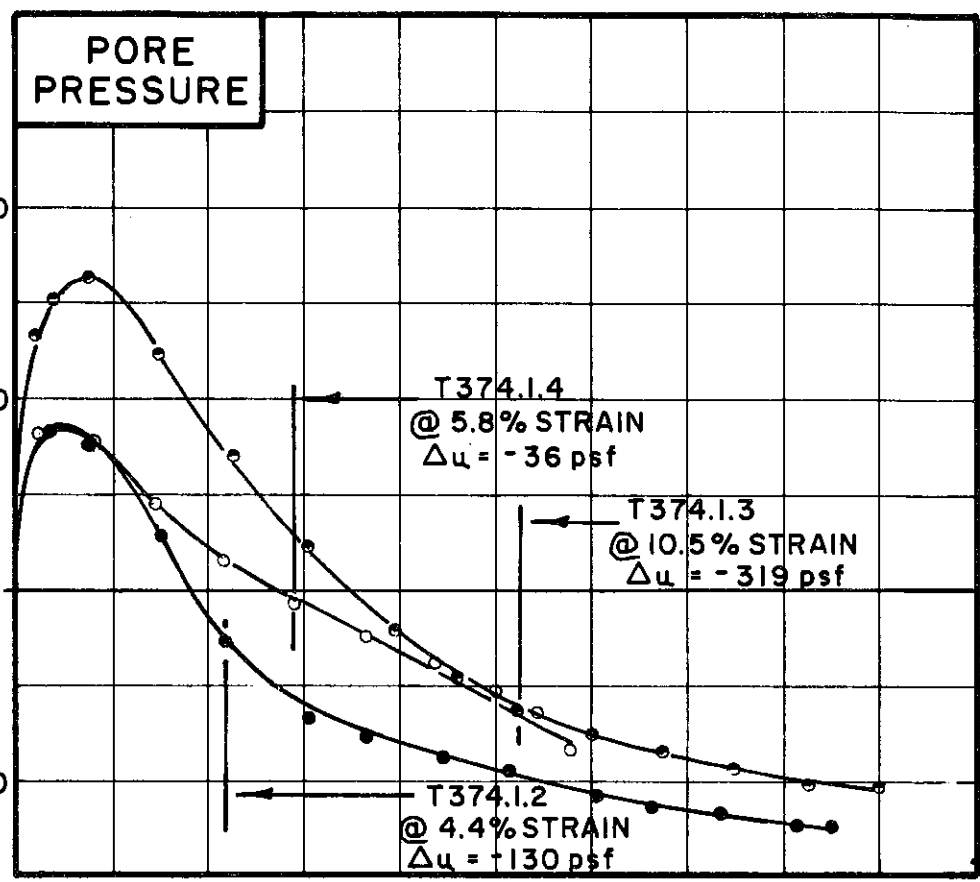
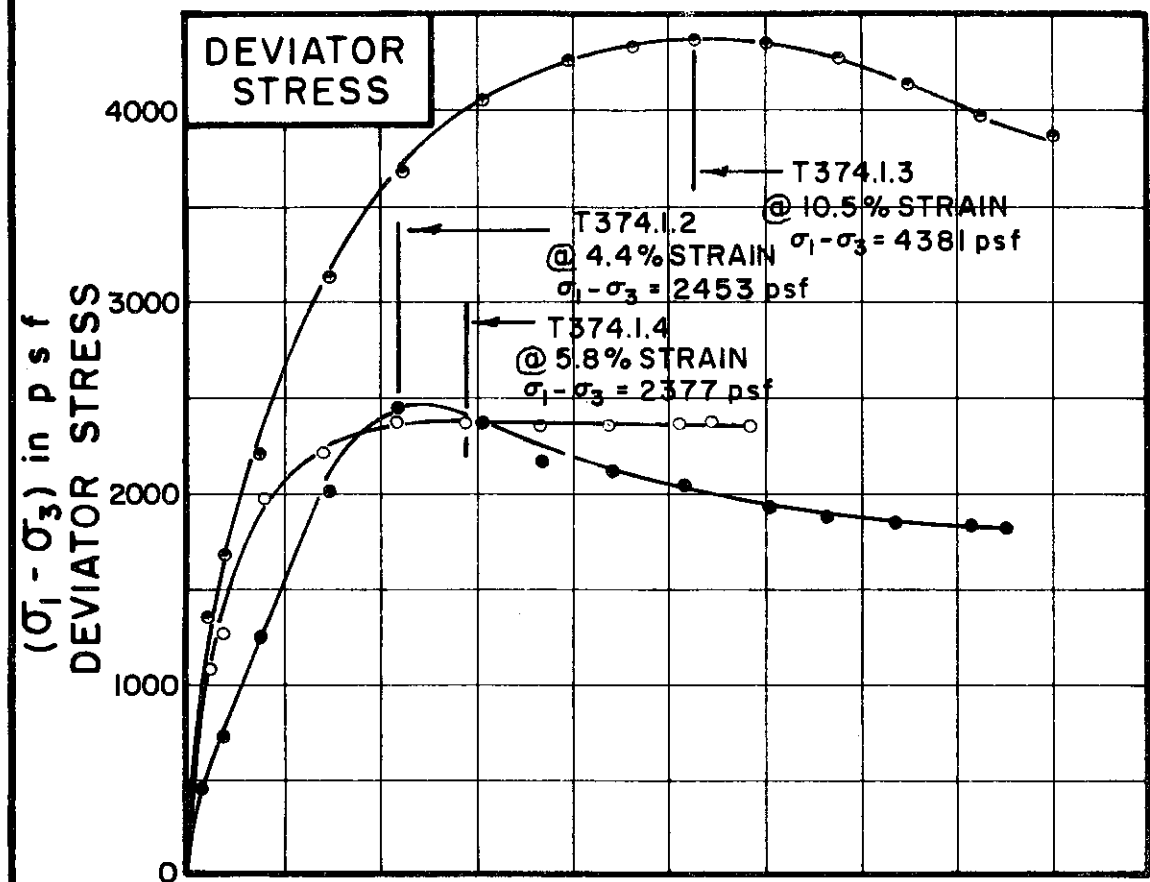

TEST NO. / SYMBOL	T374.1.4	T374.1.2	T374.1.3
-------------------	----------	----------	----------

INITIAL CONDITIONS		W ₀	27.7%	26.4%	26.9%
WATER CONTENT	W ₀				
DRY DENSITY	γ _d	98	99	96	
SAMPLE DIAMETER	D ₀	1.42	1.40	1.38	
SAMPLE HEIGHT	H ₀	3.44	3.39	3.35	
FINAL CONDITIONS BEFORE SHEAR					
FINAL BACK PRESSURE	u ₀	5760	6480	7200	
INITIAL EFFECTIVE STRESS	$\sigma_1 = \sigma_3$	864	1152	2304	
VOLUMETRIC STRAIN	ε _{vol}	0.60%	0.50%	1.35%	
PORE PRESSURE RESPONSE		98%	95%	95%	
FINAL CONDITIONS					
WATER CONTENT	W _f	28.5%	27.7%	27.6%	
SKETCH OF SAMPLE AT END OF TEST					

RATE OF STRAIN PERCENT/MINUTE	.023	.024	.024
-------------------------------	------	------	------

BORING NO. 105
 SAMPLE NO. 2
 DEPTH 9.0' TO 11.0'
 SOIL DESCRIPTION SILTY CLAY (CL)
 LIQUID LIMIT 46 PLASTIC LIMIT 24

CONSOLIDATED UNDRAINED
 TRIAXIAL COMPRESSION
 TESTS

THE DETROIT EDISON COMPANY
 BELLE RIVER PLANT UNITS I & II

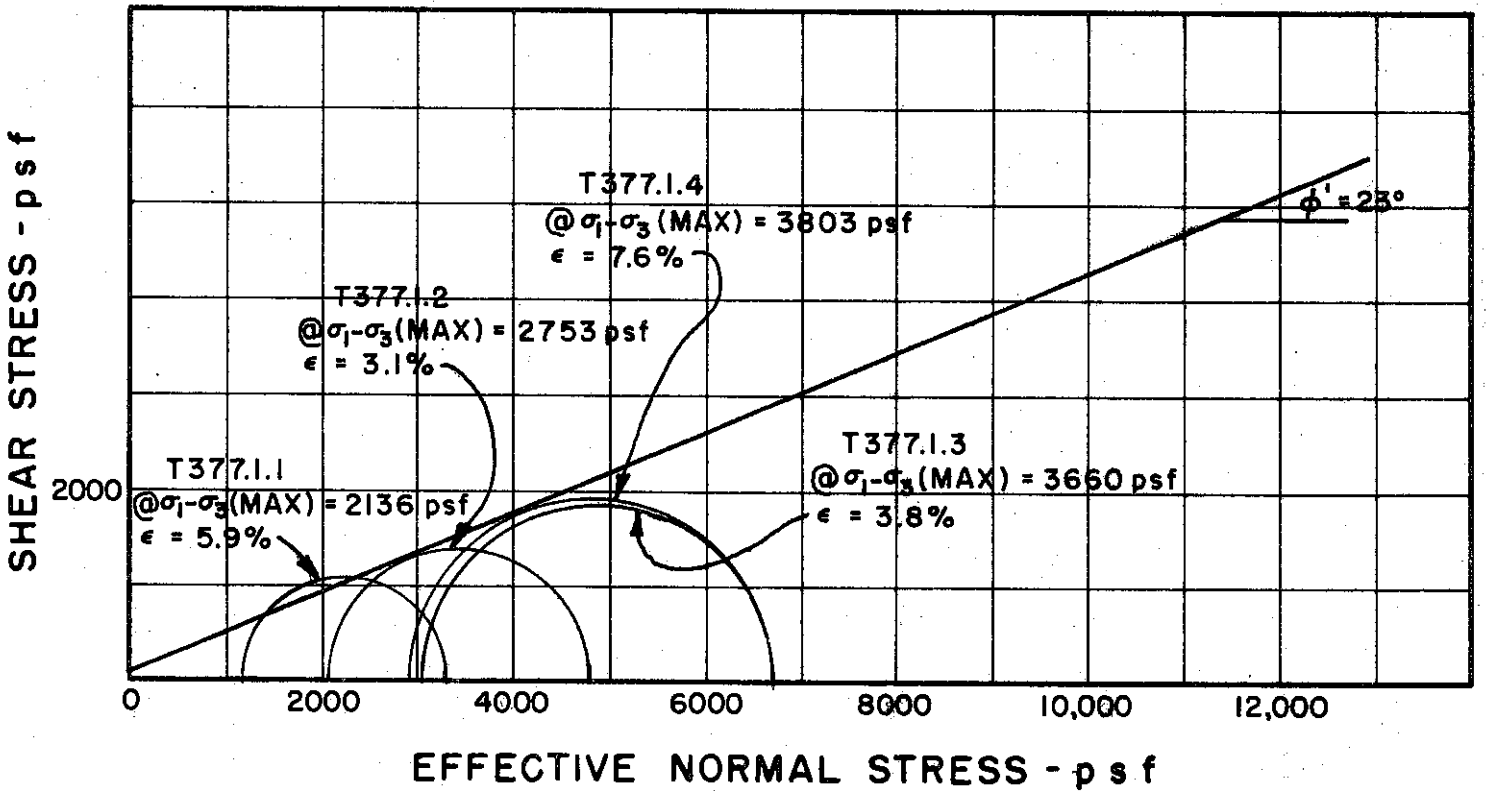
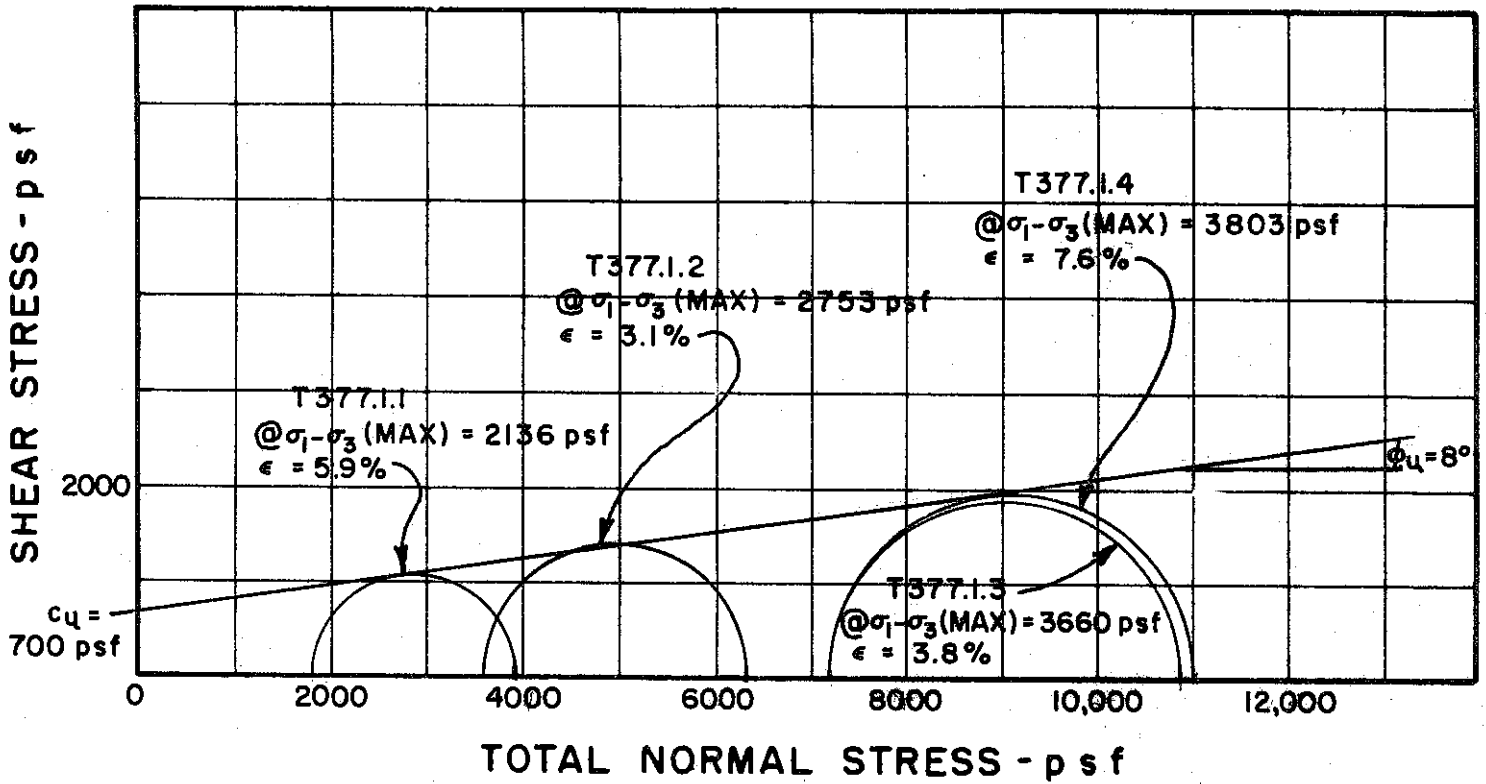

BORING NO. 105

SAMPLE NO. 5

DEPTH 40.0' TO 42.5'

REMARKS ENVELOPE IS INTERPRETIVE,
BASED ON LIMITED DATA POINTS
AVAILABLE

GOLDBERG-ZOINO AND ASSOCIATES, INC.
 CONSULTANTS IN GEOTECHNICAL ENGINEERING

MOHR STRENGTH ENVELOPE
 TRIAXIAL COMPRESSION
 TESTS

THE DETROIT EDISON COMPANY
 BELLE RIVER PLANT UNITS I & II

FILE 1255

C-434

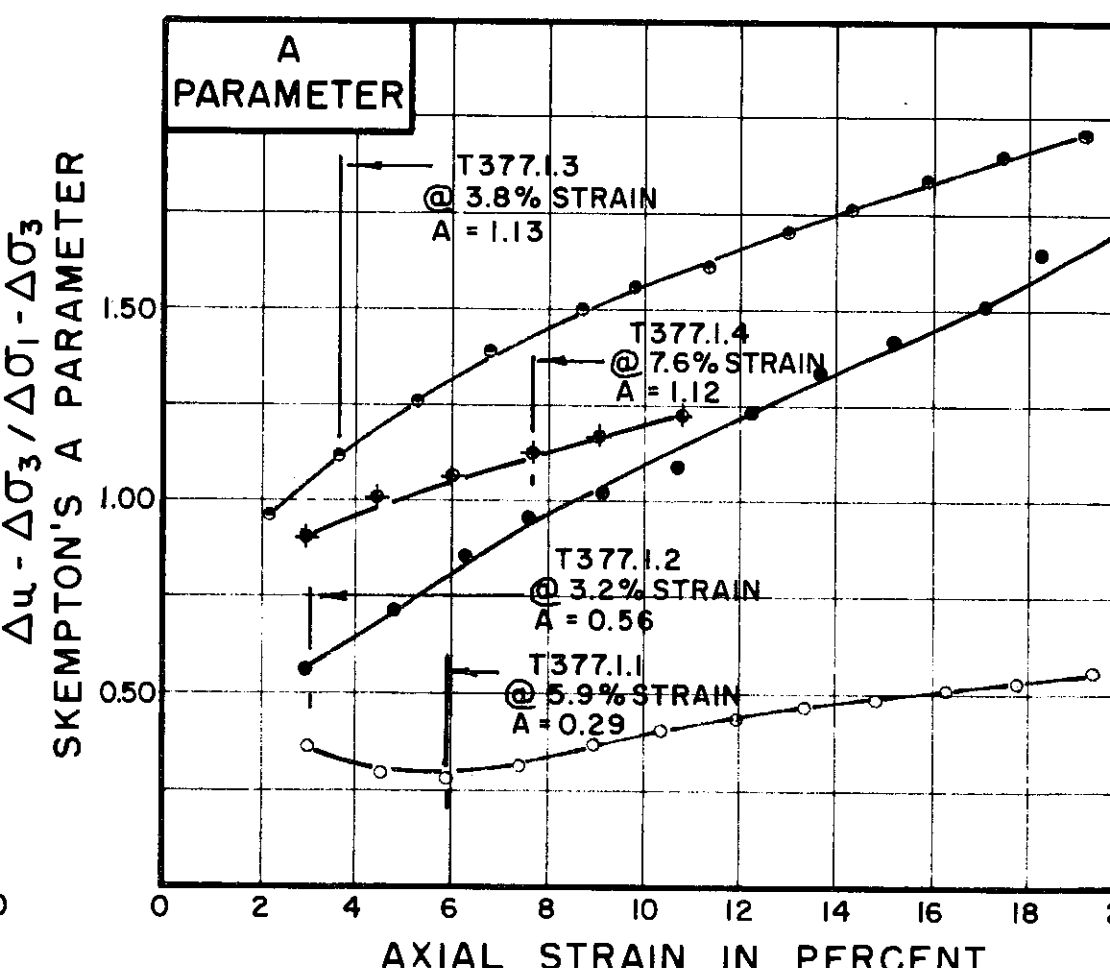
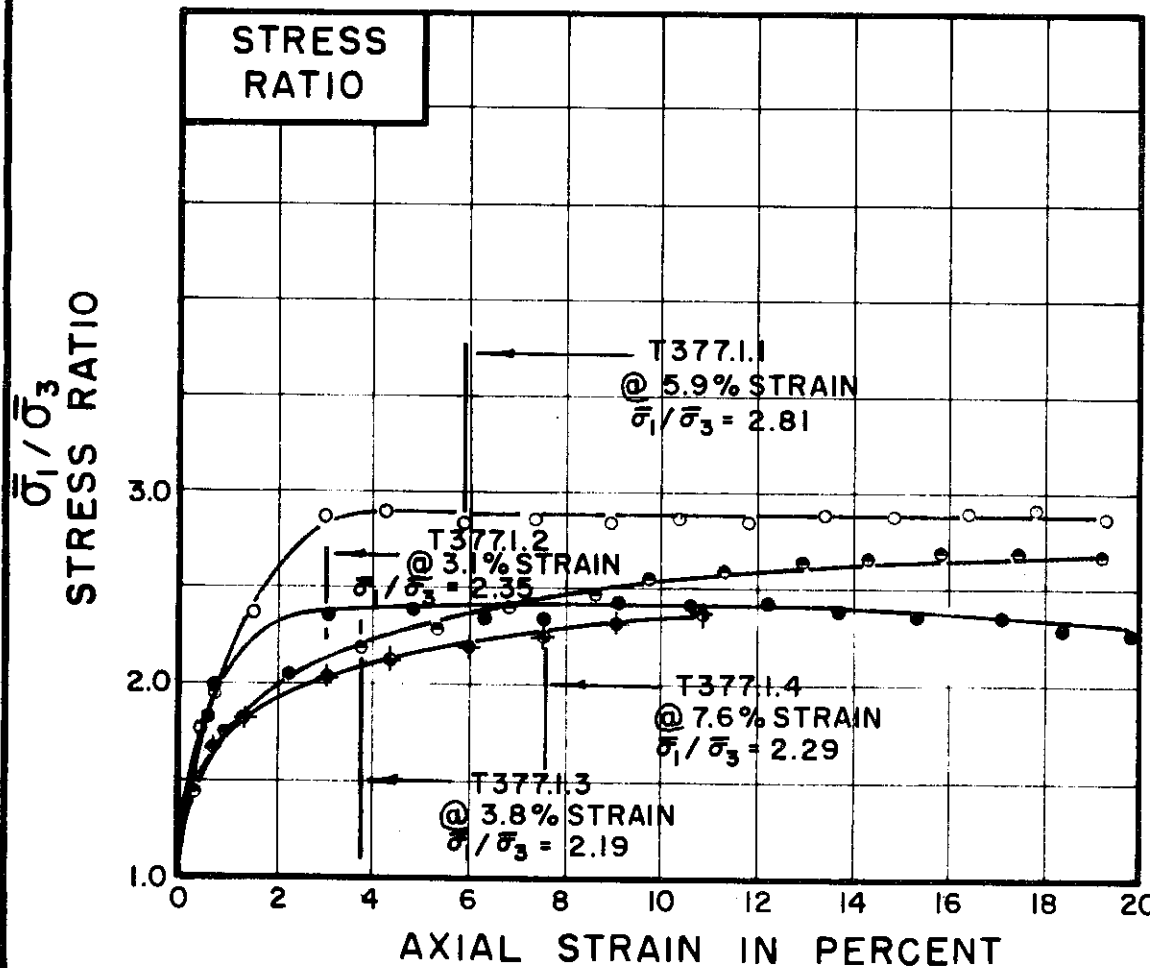
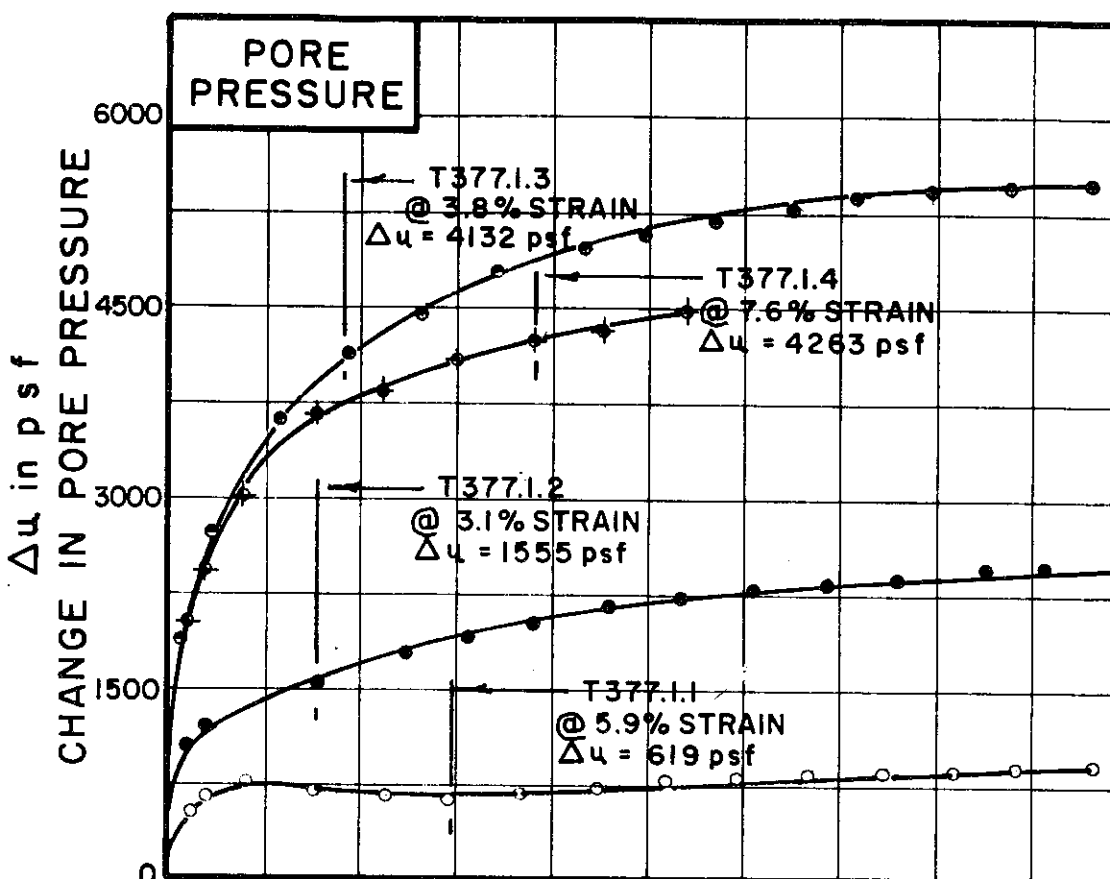
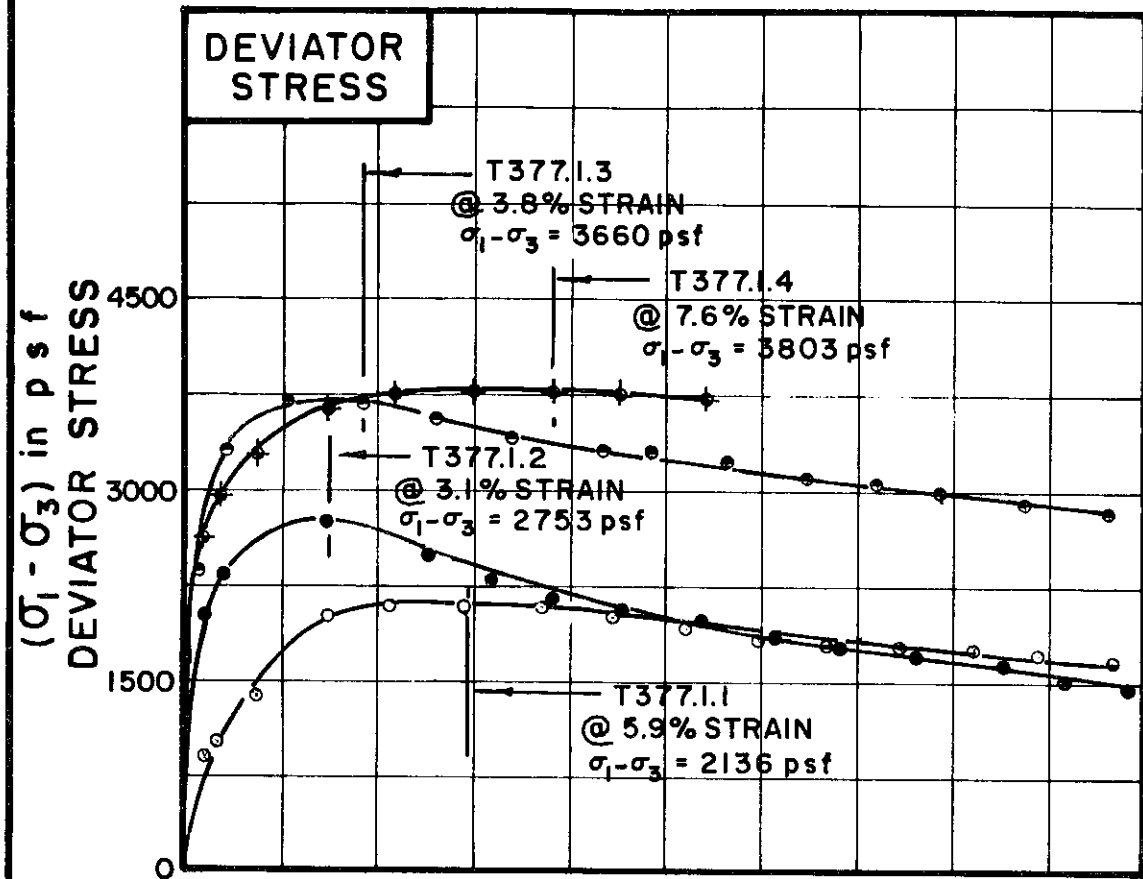

TEST NO. / SYMBOL	T377.1.1	T377.1.2	T377.1.3	T377.1.4
-------------------	----------	----------	----------	----------

INITIAL CONDITIONS			T377.1.1	T377.1.2	T377.1.3	T377.1.4
WATER CONTENT	w_0		35.9%	35.9%	35.1%	39.2%
DRY DENSITY	γ_d	lb/cu ft	84	85	85	84
SAMPLE DIAMETER	D_0	in.	1.39	1.42	1.38	1.41
SAMPLE HEIGHT	H_0	in.	3.38	3.30	3.34	3.37
CONDITIONS BEFORE SHEAR			T377.1.1	T377.1.2	T377.1.3	T377.1.4
FINAL BACK PRESSURE	u_0	psf	7200	7200	7200	7200
INITIAL EFFECTIVE STRESS	σ_1 / σ_3	psf	1800	3600	7200	7200
VOLUMETRIC STRAIN	ϵ_{vol}		1.49%	2.38%	4.36%	7.47%
PORE PRESSURE RESPONSE			97%	96%	96%	96%
FINAL CONDITIONS			T377.1.1	T377.1.2	T377.1.3	T377.1.4
WATER CONTENT	w_f		35.3%	34.1%	30.9%	33.4%
SKETCH OF SAMPLE AT END OF TEST						

RATE OF STRAIN PERCENT / MINUTE	.024	.024	.024	.024
---------------------------------	------	------	------	------

BORING NO. 105
 SAMPLE NO. 5
 DEPTH 40.0' TO 42.5'
 SOIL DESCRIPTION SILTY CLAY (CL)
 LIQUID LIMIT 44 PLASTIC LIMIT 21

CONSOLIDATED UNDRAINED
 TRIAXIAL COMPRESSION
 TESTS

THE DETROIT EDISON COMPANY
 BELLE RIVER PLANT UNITS I & II

SHEAR STRESS - p s f

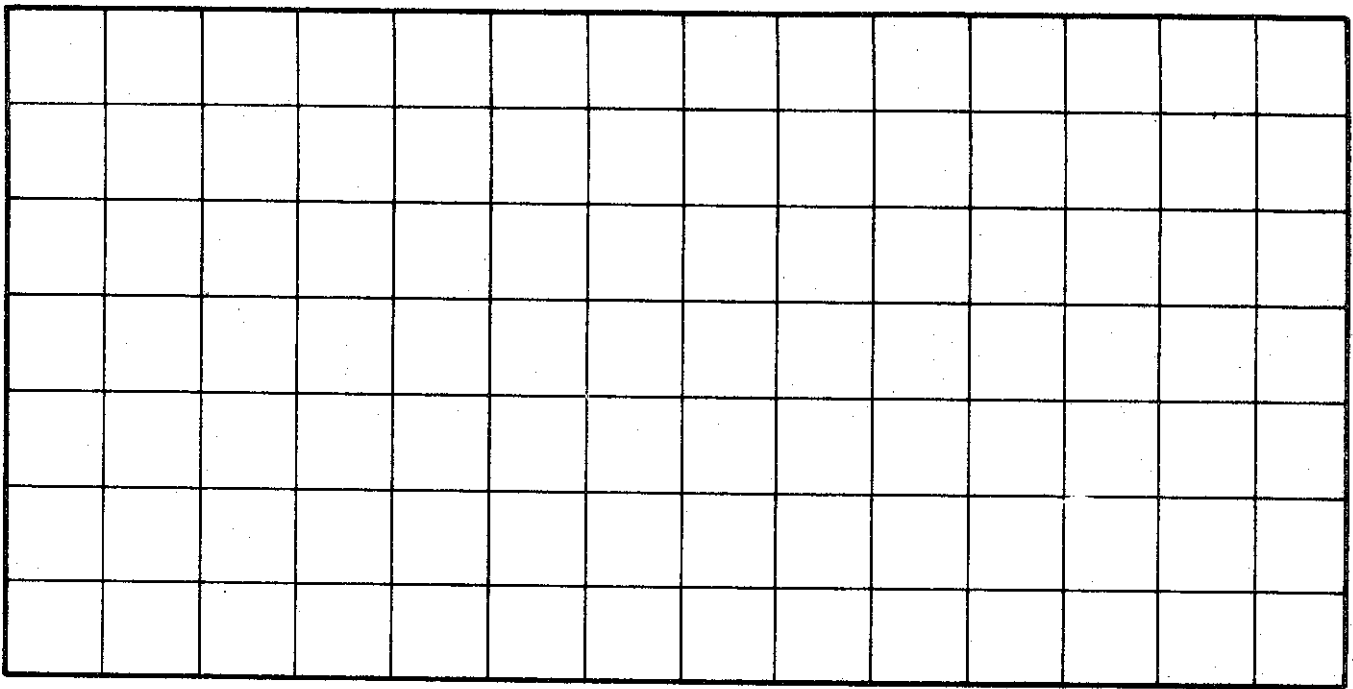

TOTAL NORMAL STRESS - p s f

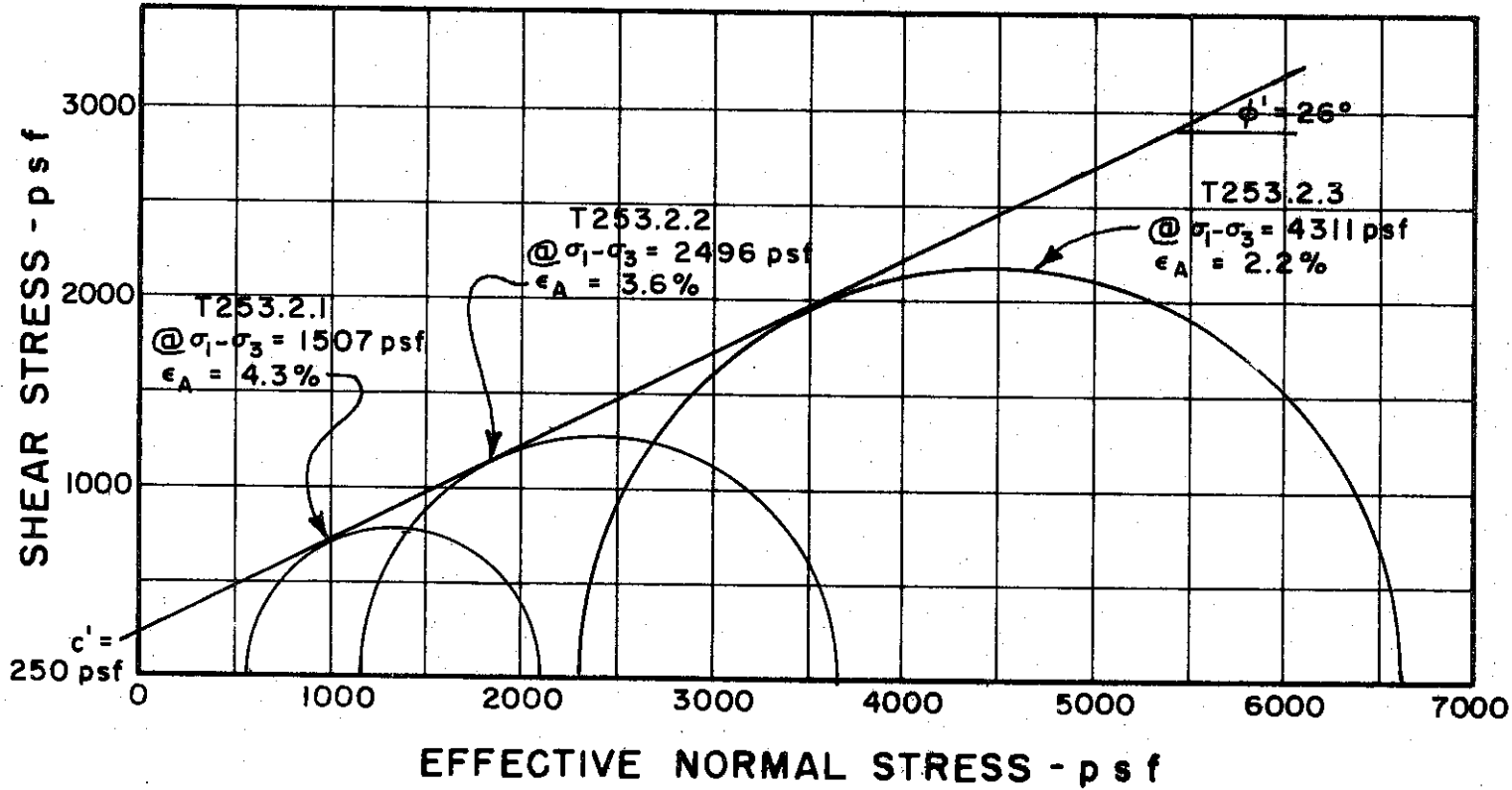

BORING NO. 118

SAMPLE NO. 2

DEPTH 8.2' TO 9.2'

REMARKS _____

MOHR STRENGTH ENVELOPE
TRIAXIAL COMPRESSION
TESTS

GOLDBERG-ZOINO AND ASSOCIATES, INC.
CONSULTANTS IN GEOTECHNICAL ENGINEERING

THE DETROIT EDISON COMPANY
BELLE RIVER PLANT UNITS I & II

FILE 1255

C-436

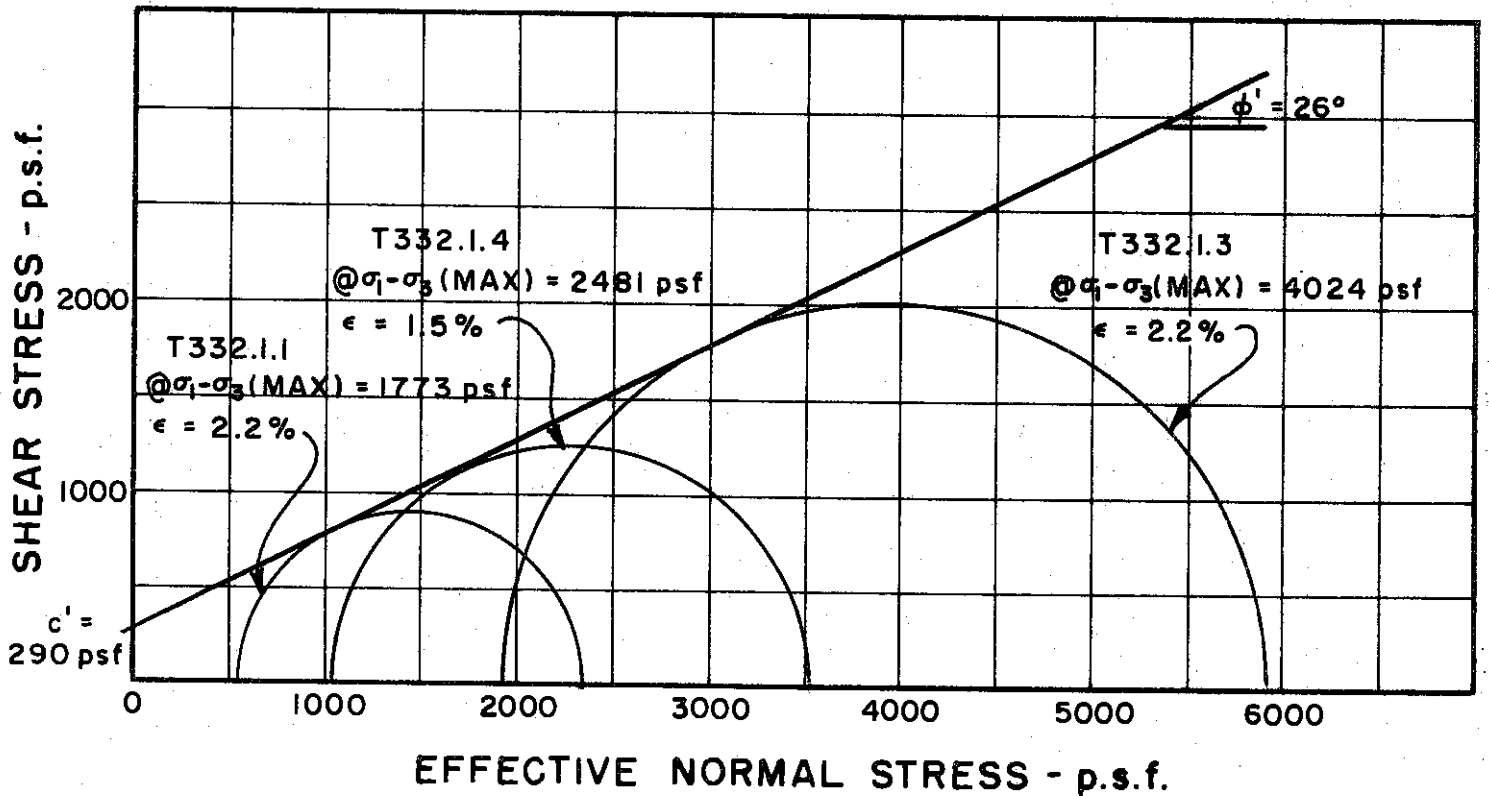
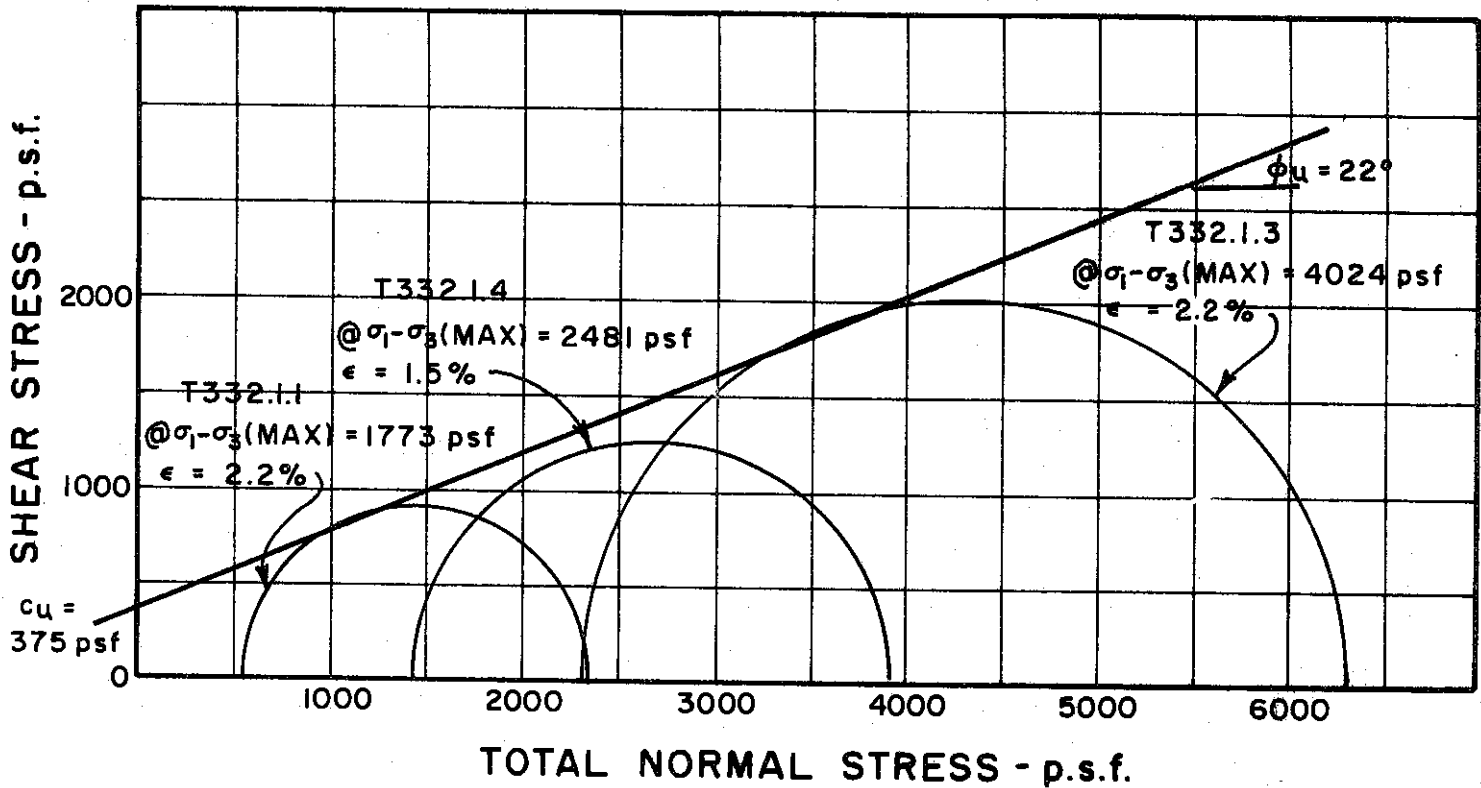

BORING NO. 119
 SAMPLE NO. 2
 DEPTH 8.0' TO 10.0'

**MOHR STRENGTH ENVELOPE
 TRIAXIAL COMPRESSION
 TESTS**

REMARKS ENVELOPE IS INTERPRETIVE
 BASED ON LIMITED DATA POINTS
 AVAILABLE

GOLDBERG-ZOINO AND ASSOCIATES, INC.
 CONSULTANTS IN GEOTECHNICAL ENGINEERING

THE DETROIT EDISON COMPANY
 BELLE RIVER PLANT UNITS I & II
 FILE 1255
 C-437

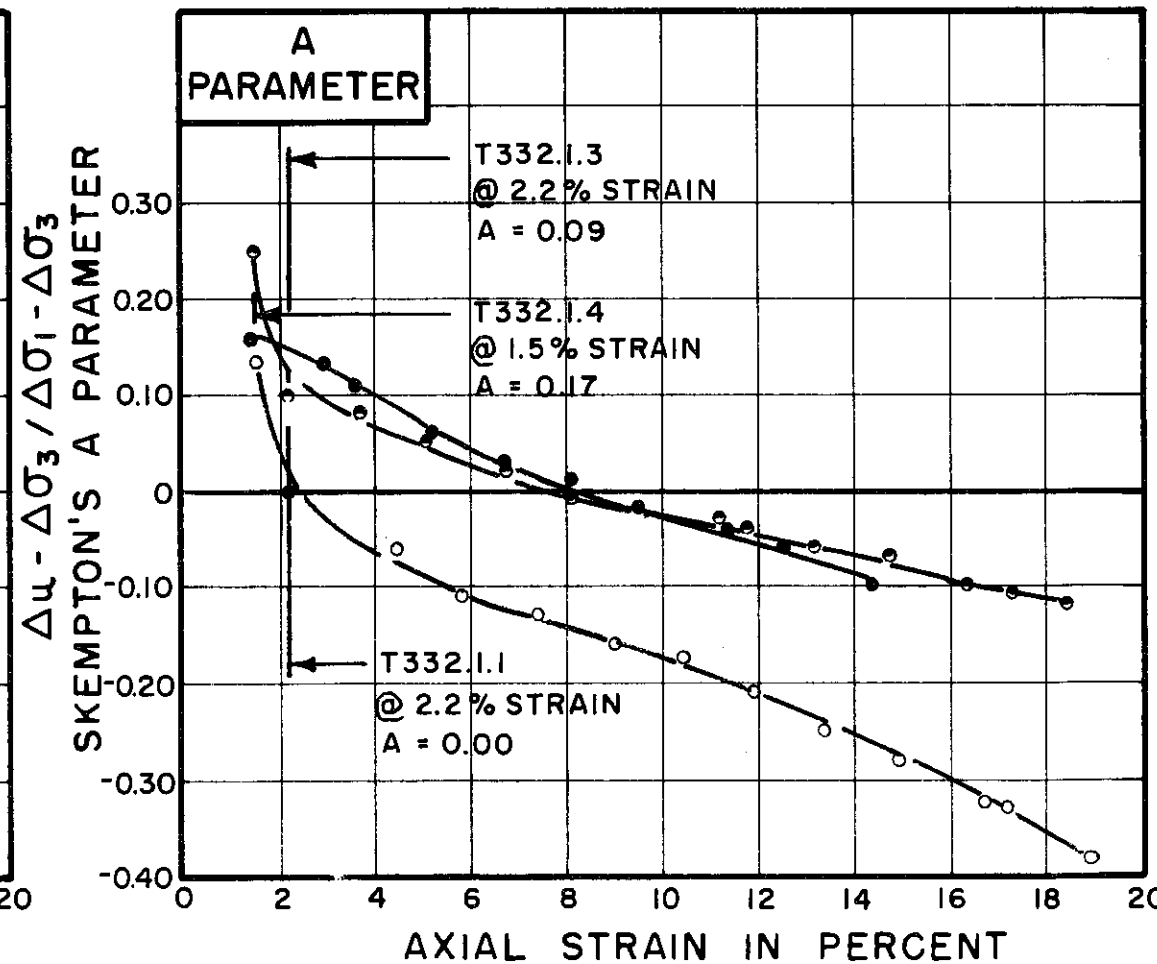
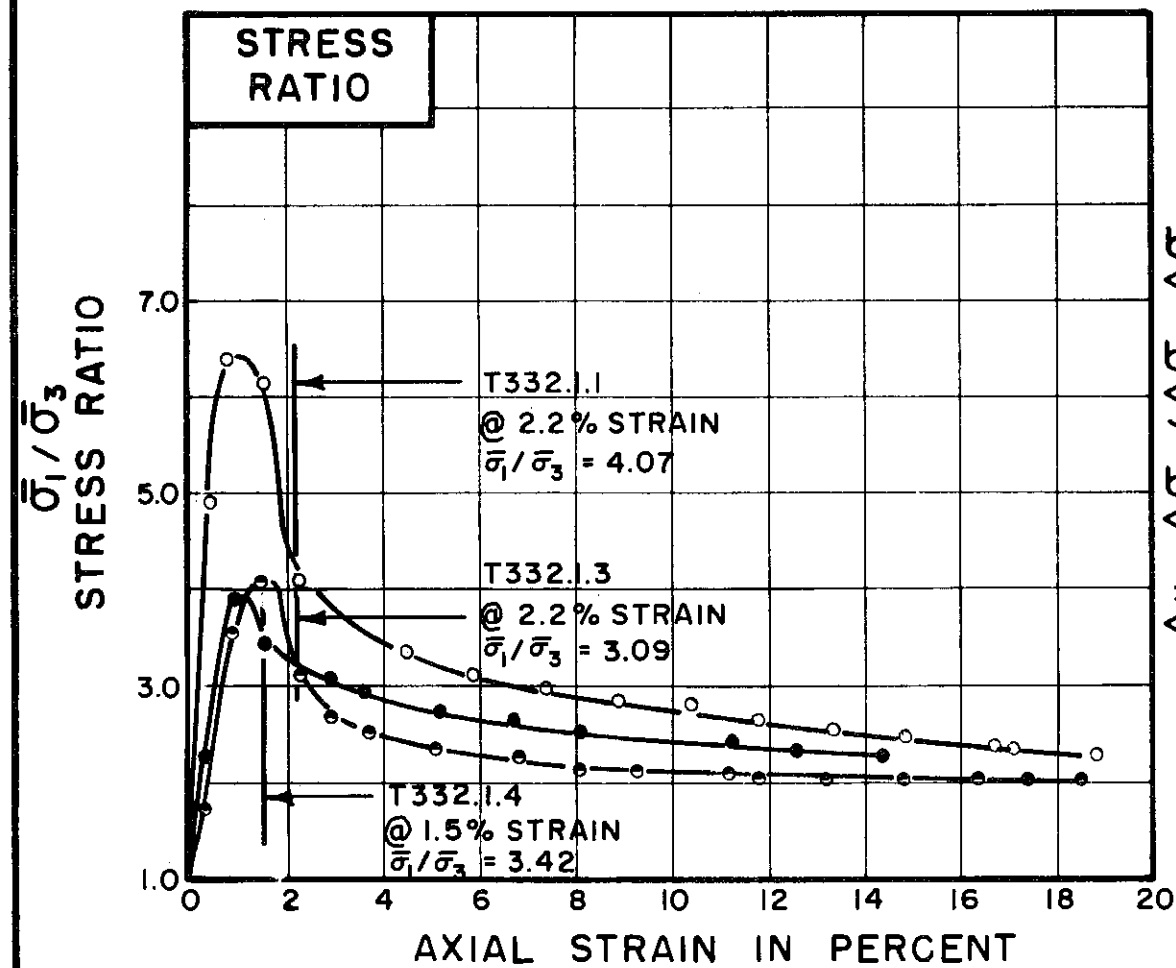
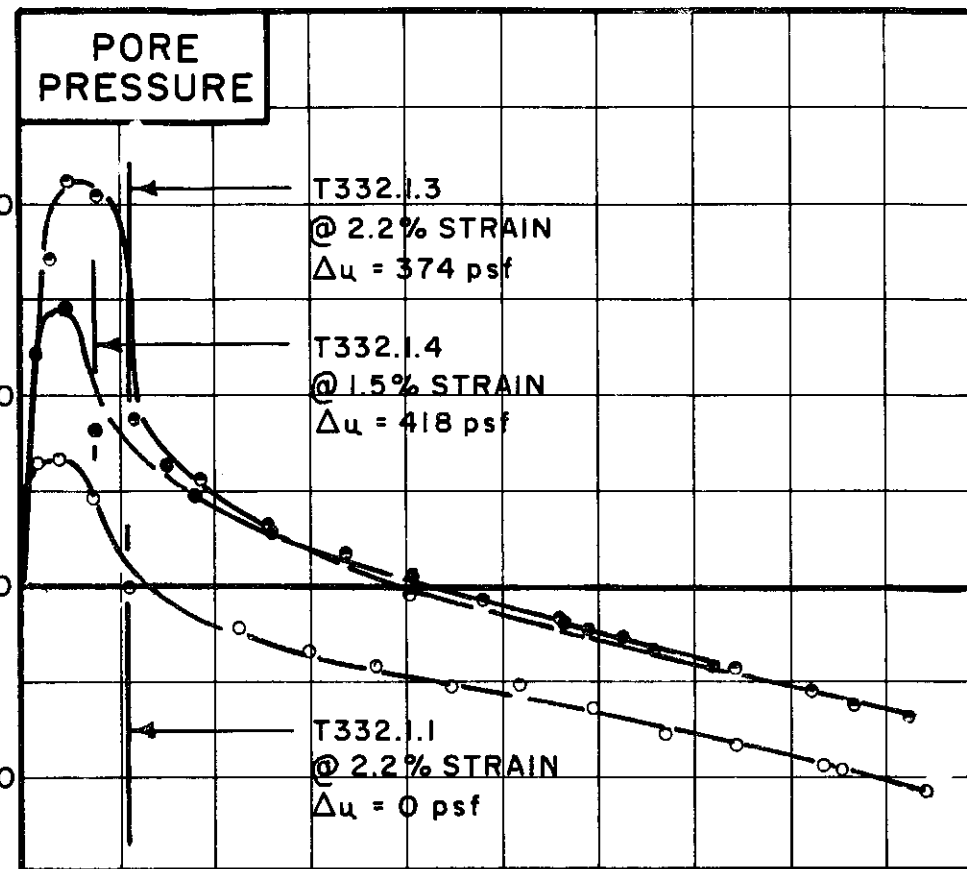
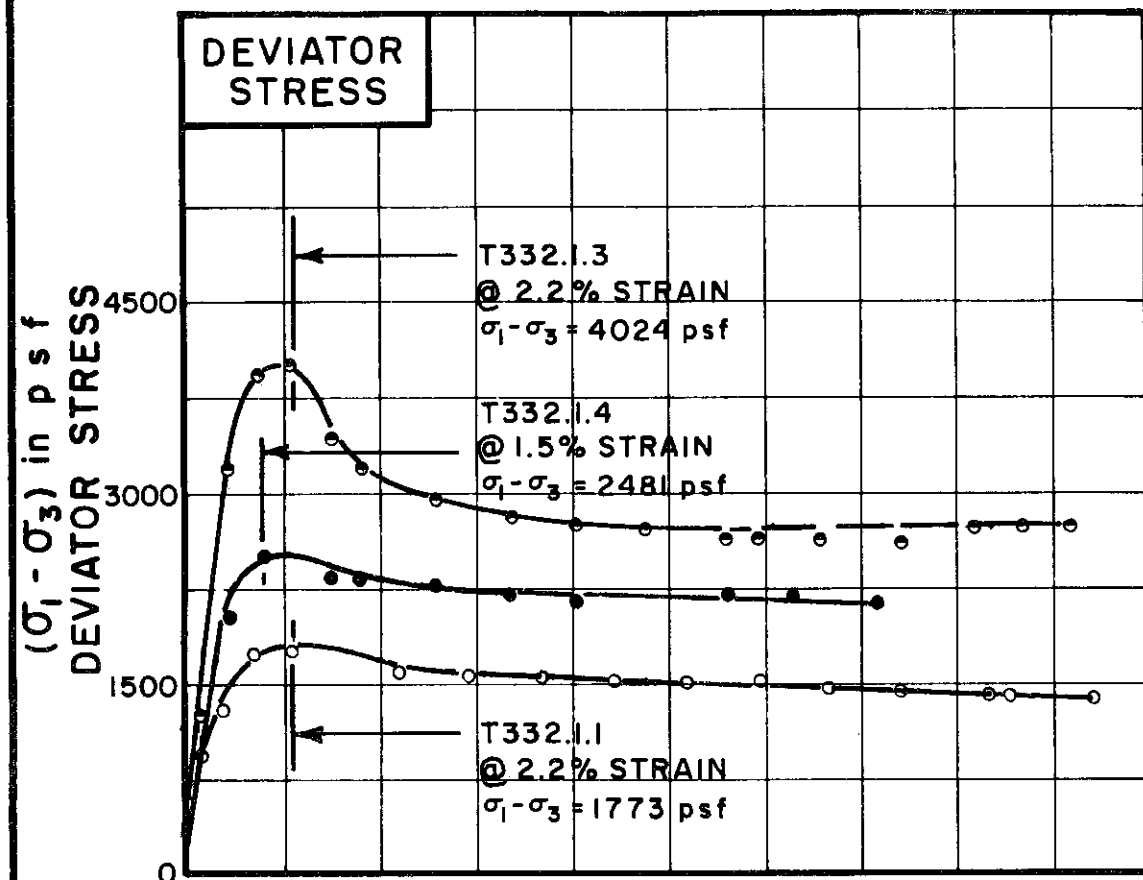

TEST NO. / SYMBOL	T332.1.1	T332.1.4	T332.1.3
	○	●	●

INITIAL CONDITIONS	WATER CONTENT	w_0	28.3%	29.2%	27.9%
	DRY DENSITY	γ_d	95	94	99
	pcf				
SAMPLE DIMENSIONS	SAMPLE DIAMETER	D_0	1.42	1.41	1.41
	in.				
	SAMPLE HEIGHT	H_0	3.36	3.38	3.40
in.					
FINAL CONDITIONS BEFORE SHEAR	FINAL BACK PRESSURE	u_0	8640	7200	8640
	psf				
	INITIAL EFFECTIVE STRESS	σ_1, σ_3	576	1440	2304
psf					
VOLUMETRIC STRAIN	ϵ_{vol}		0.4%	1.7%	1.9%
PORE PRESSURE RESPONSE			98%	98%	99%
FINAL CONDITIONS AFTER SHEAR	WATER CONTENT	w_f	29.4%	29.5%	27.6%
SKETCH OF SAMPLE AT END OF TEST					

RATE OF STRAIN PERCENT/MINUTE	.024	.024	.024
-------------------------------	------	------	------

BORING NO. 119

SAMPLE NO. 2

DEPTH 8.0' TO 10.0'

SOIL DESCRIPTION SILTY CLAY (CL-CH)

LIQUID LIMIT 53 PLASTIC LIMIT 26

CONSOLIDATED UNDRAINED
TRIAxIAL COMPRESSION
TESTS

THE DETROIT EDISON COMPANY
BELLE RIVER PLANT UNITS I & II

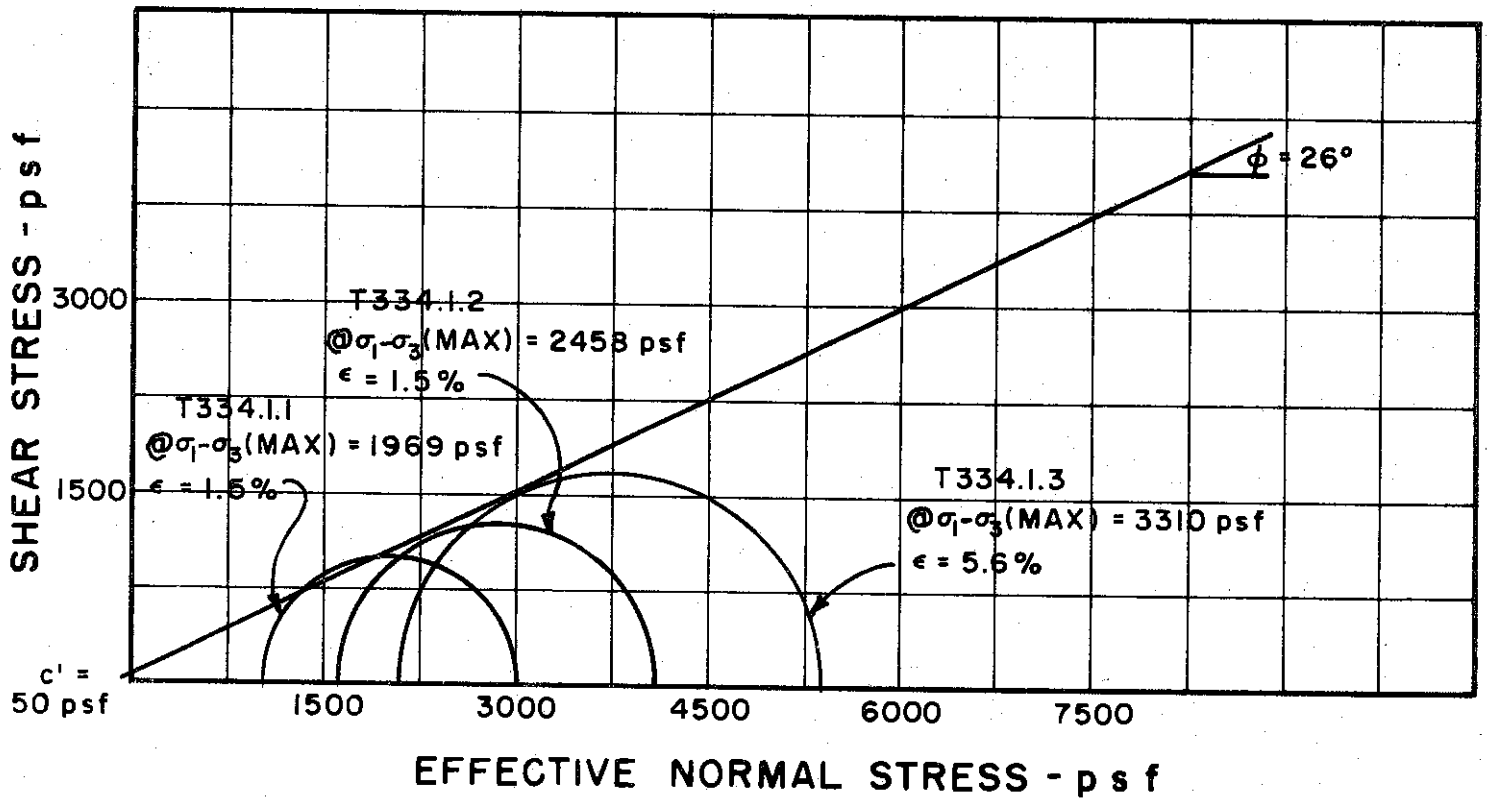
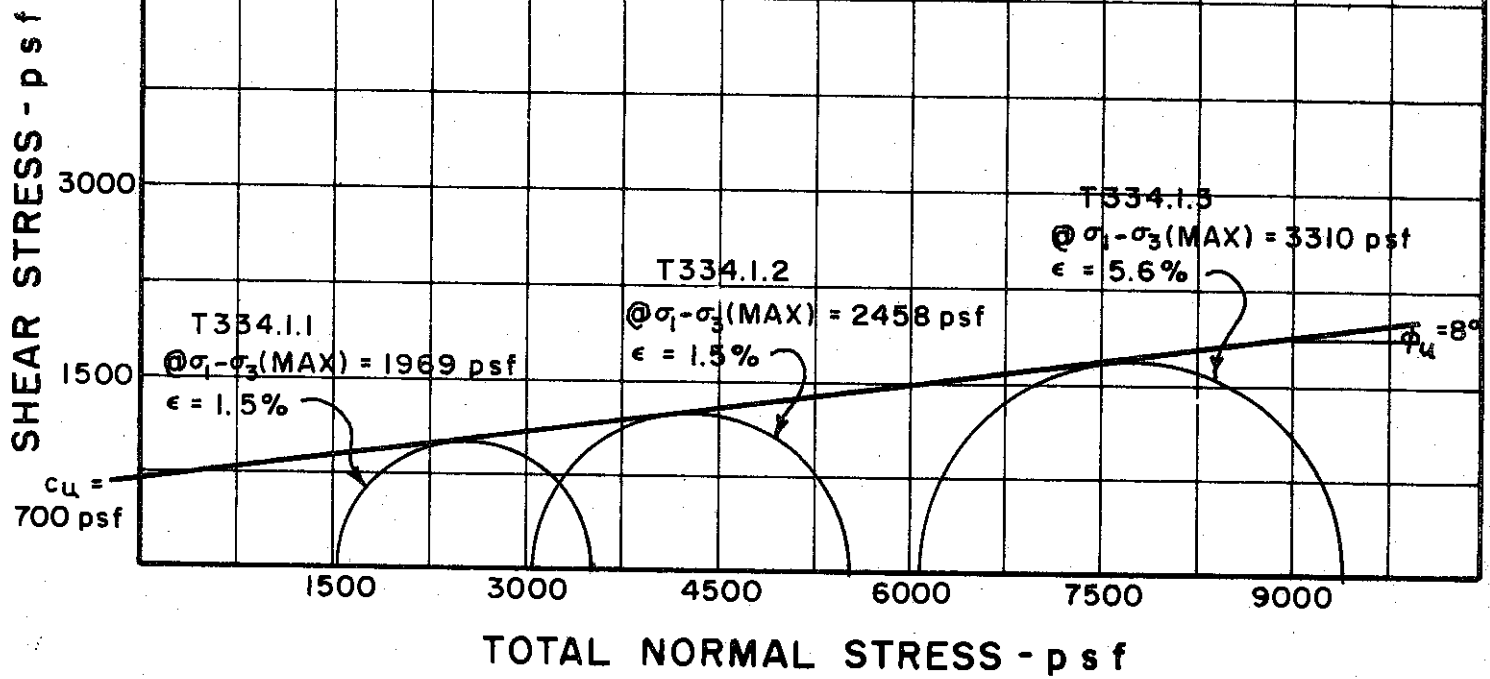

BORING NO. 119

SAMPLE NO. 4

DEPTH 30.0 TO 32.0

REMARKS ENVELOPE IS INTERPRETIVE,
BASED ON LIMITED DATA POINTS
AVAILABLE

GOLDBERG-ZOINO AND ASSOCIATES, INC.
CONSULTANTS IN GEOTECHNICAL ENGINEERING

MOHR STRENGTH ENVELOPE
TRIAxIAL COMPRESSION
TESTS

THE DETROIT EDISON COMPANY
BELLE RIVER PLANT UNITS I & II

FILE 1255

C-439

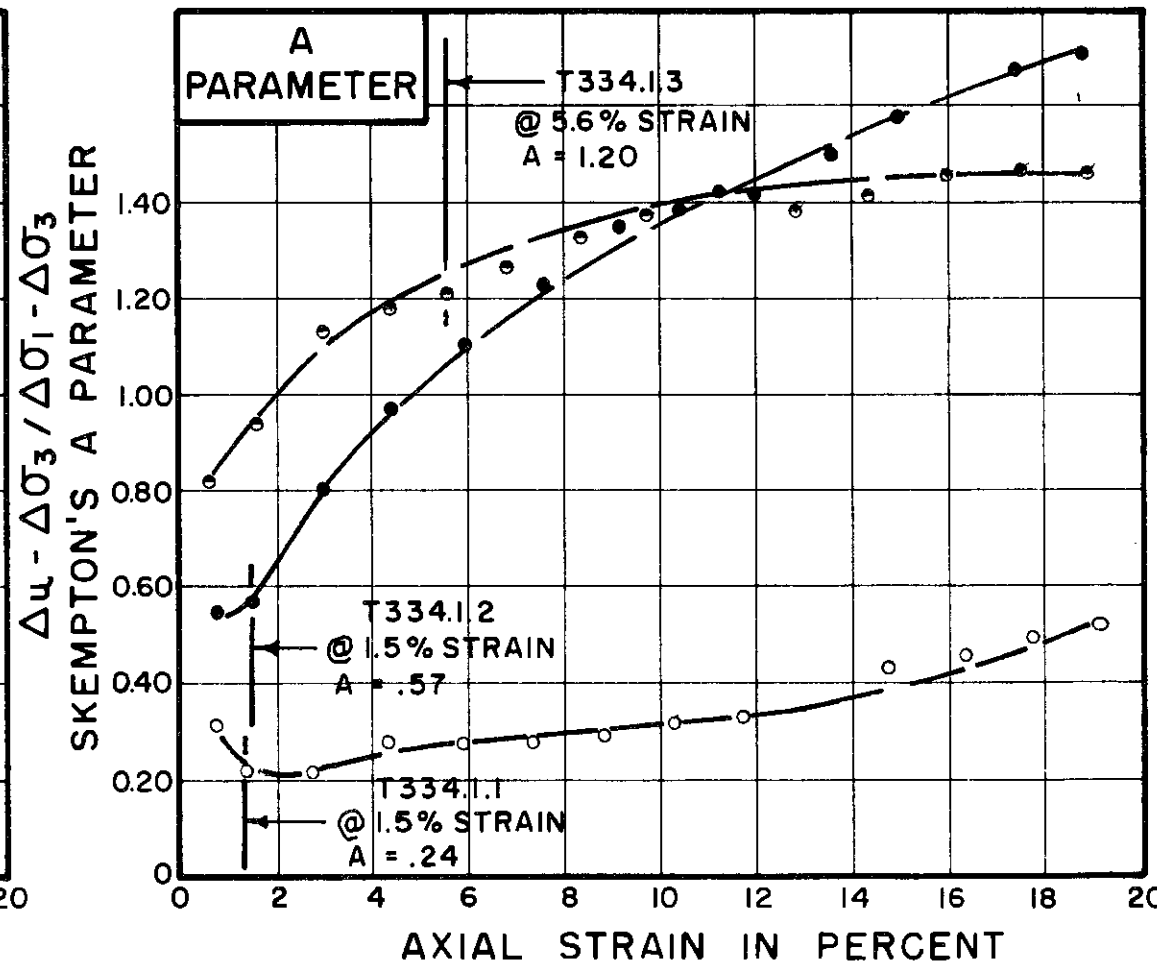
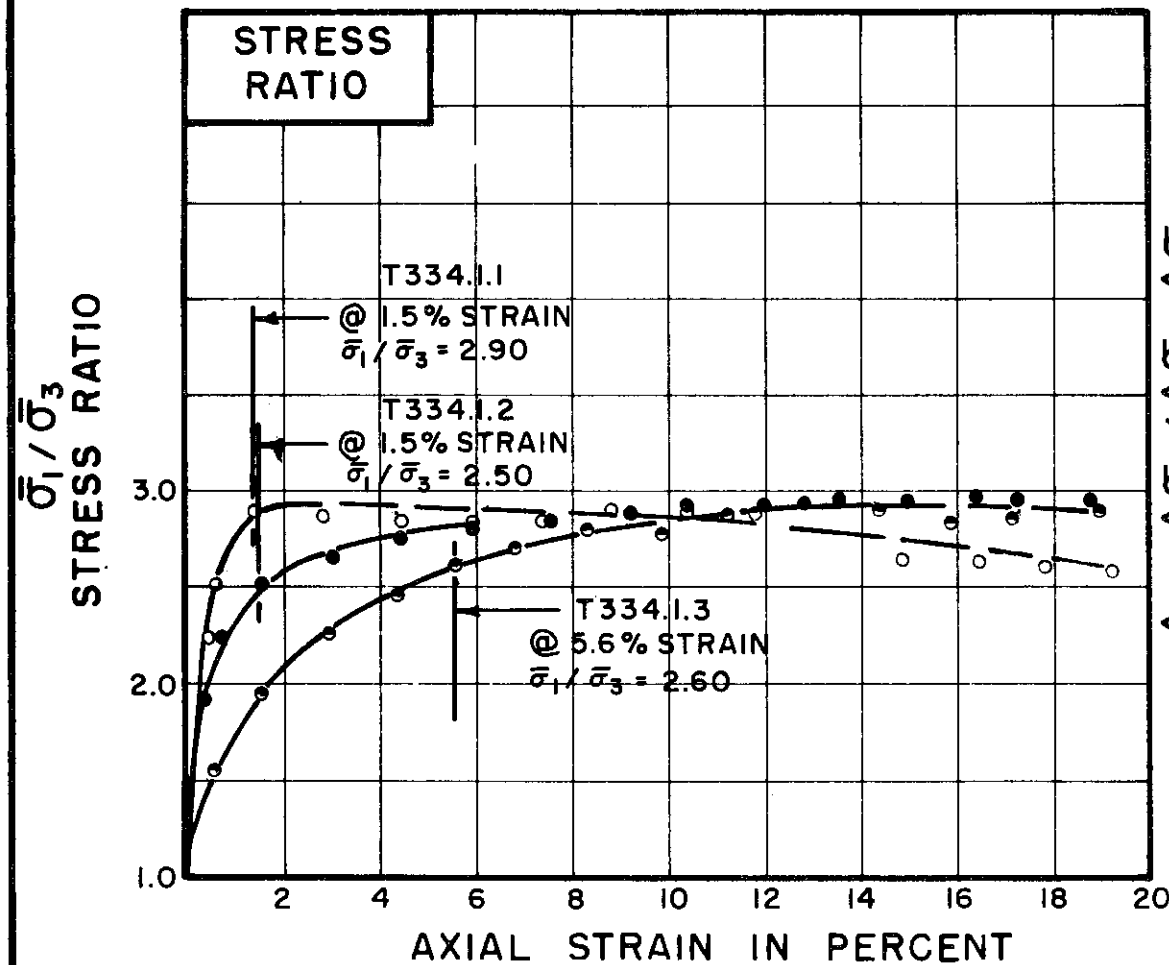
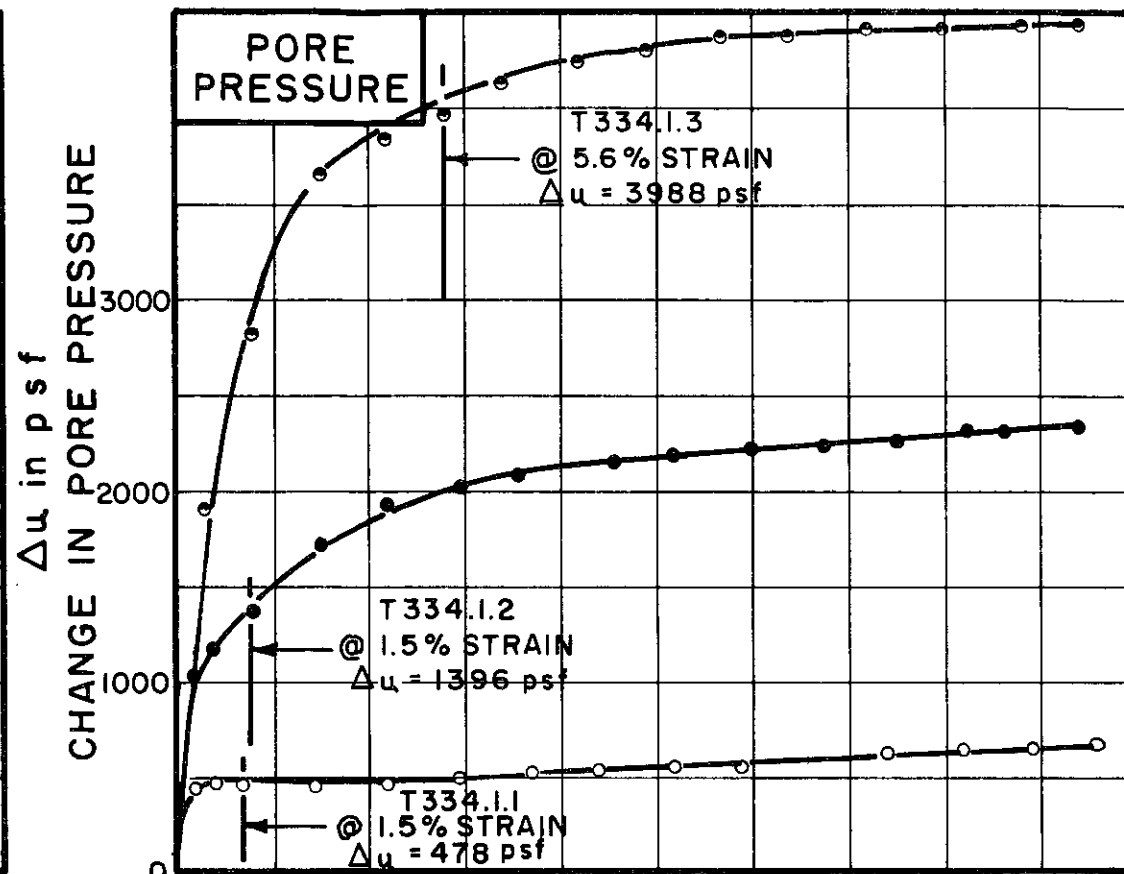
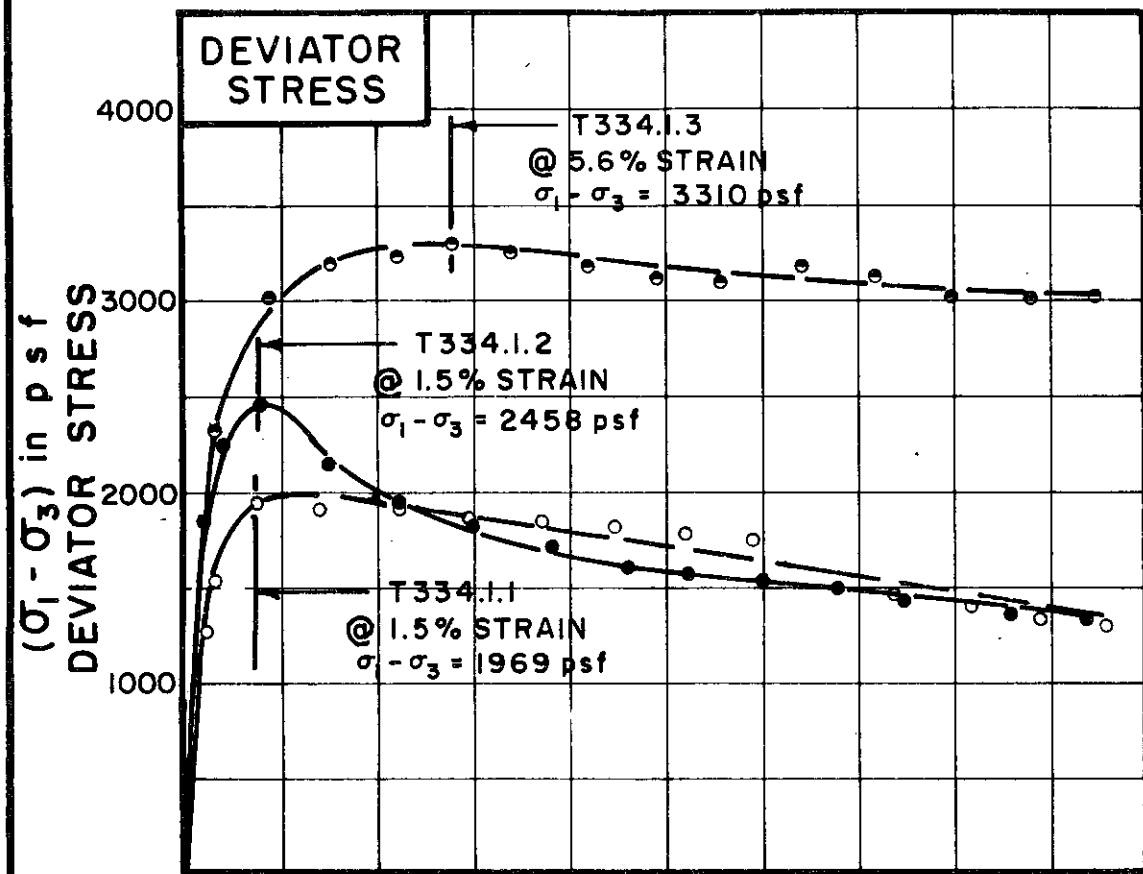

TEST NO. / SYMBOL	T334.1.1	T334.1.2	T334.1.3
	○	●	○

INITIAL CONDITIONS			T334.1.1	T334.1.2	T334.1.3
WATER CONTENT	w_0		36.9%	38.5%	35.3%
DRY DENSITY	γ_d	pcf	86	85	87
SAMPLE DIAMETER	D_0	in.	1.41	1.41	1.41
SAMPLE HEIGHT	H_0	in.	3.39	3.35	3.36
FINAL CONDITIONS BEFORE SHEAR			T334.1.1	T334.1.2	T334.1.3
FINAL BACK PRESSURE	u_0	psf	11520	7200	11520
INITIAL EFFECTIVE STRESS	$\frac{\sigma_1}{\sigma_3}$	psf	1512	3024	6048
VOLUMETRIC STRAIN	ϵ_{vol}		1.4%	2.7%	6.4%
PORE PRESSURE RESPONSE			95%	99%	100%
FINAL CONDITIONS			T334.1.1	T334.1.2	T334.1.3
WATER CONTENT	w_f		35.2%	36.1%	29.8%
SKETCH OF SAMPLE AT END OF TEST					

RATE OF STRAIN PERCENT/MINUTE	.024	.024	.024
-------------------------------	------	------	------

BORING NO. 119
 SAMPLE NO. 4
 DEPTH 30.0 TO 32.0
 SOIL DESCRIPTION SILTY CLAY (CL)
 LIQUID LIMIT 41 PLASTIC LIMIT 22

CONSOLIDATED UNDRAINED
 TRIAXIAL COMPRESSION
 TESTS
 THE DETROIT EDISON COMPANY
 BELLE RIVER PLANT UNITS I & II

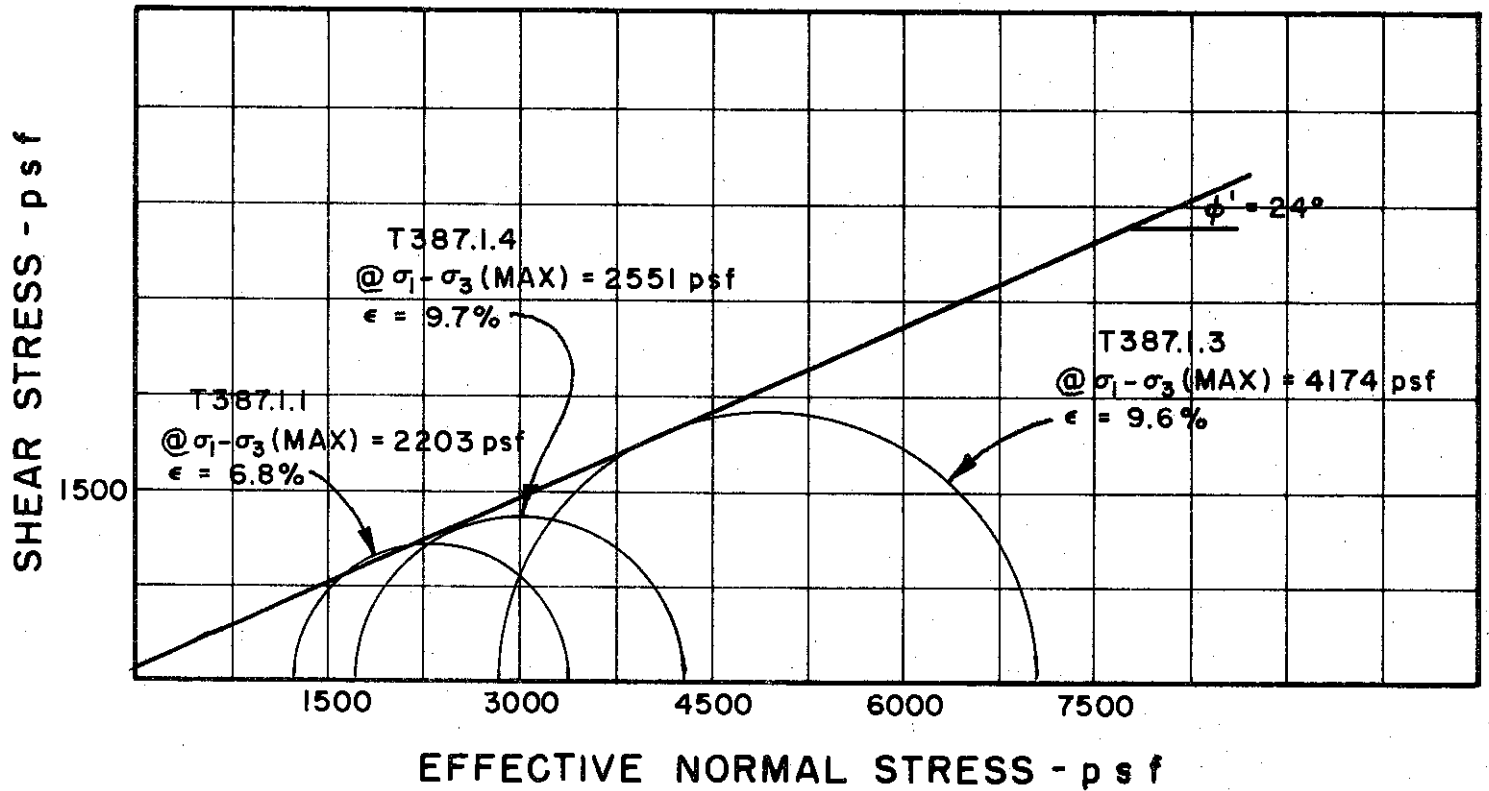
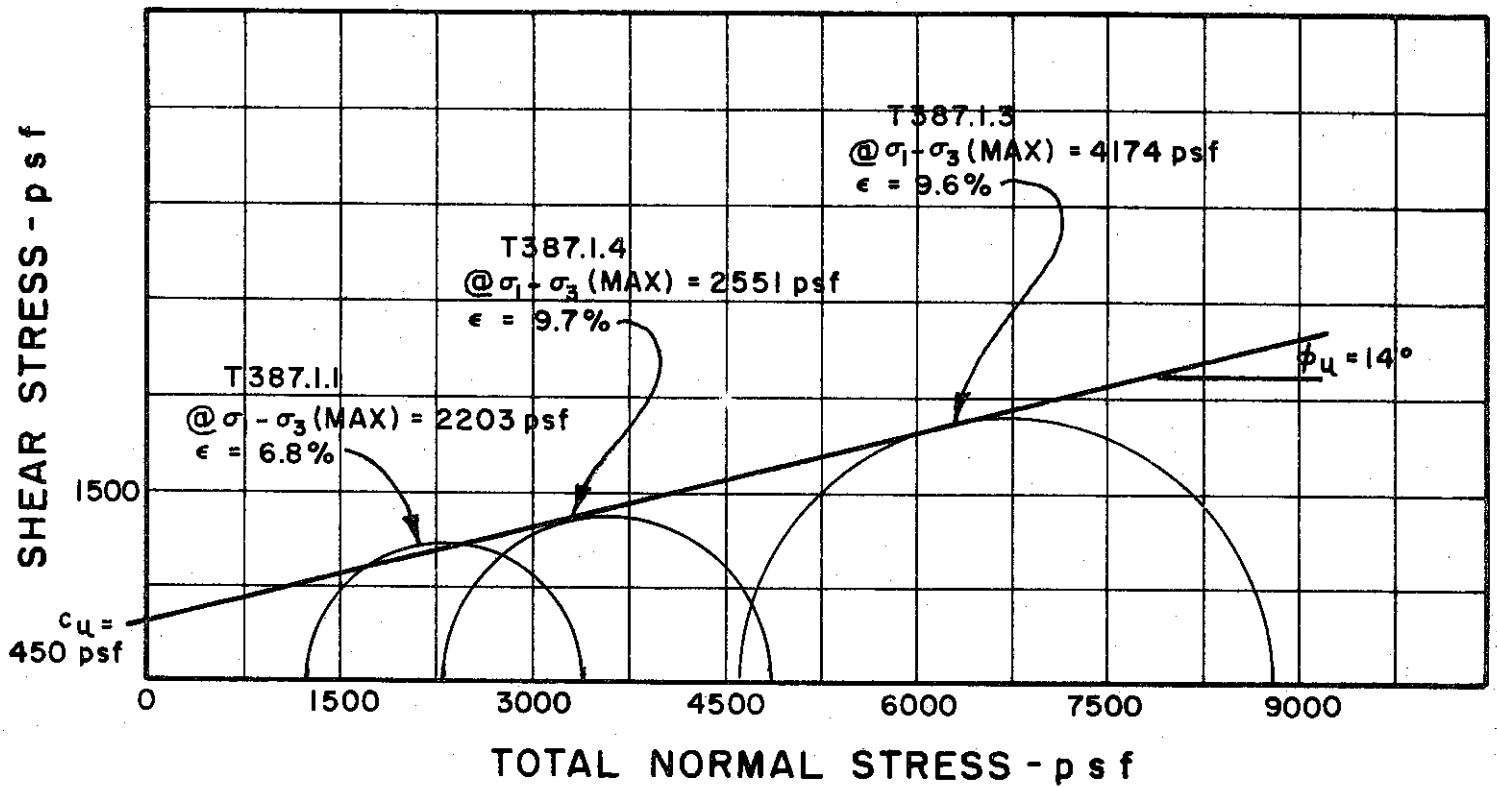

BORING NO. 129

SAMPLE NO. 5

DEPTH 18.0' TO 21.0'

REMARKS ENVELOPE IS INTERPRETIVE,
BASED ON LIMITED DATA POINTS
AVAILABLE

GOLDBERG-ZOINO AND ASSOCIATES, INC.
 CONSULTANTS IN GEOTECHNICAL ENGINEERING

MOHR STRENGTH ENVELOPE
 TRIAXIAL COMPRESSION
 TESTS

THE DETROIT EDISON COMPANY
 BELLE RIVER PLANT UNITS I & II

FILE 1255

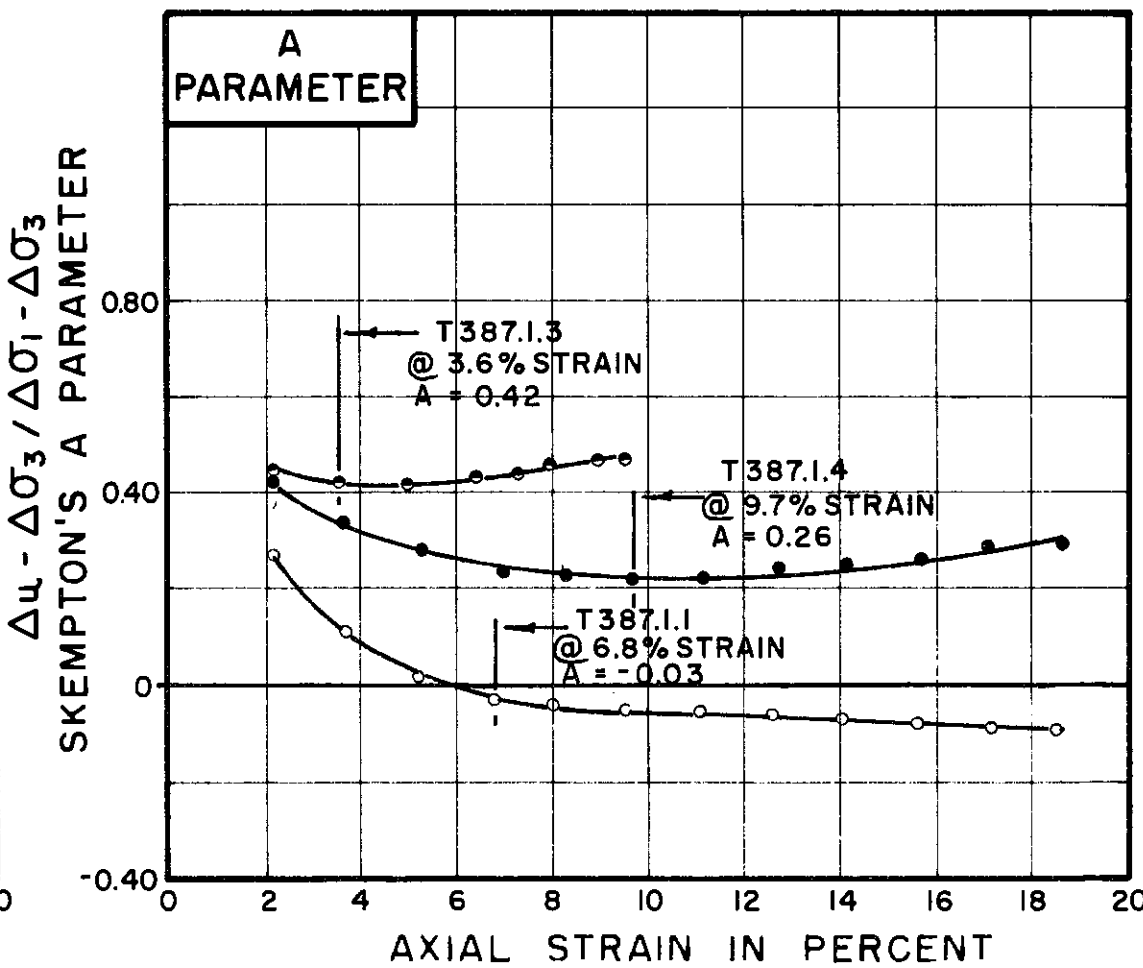
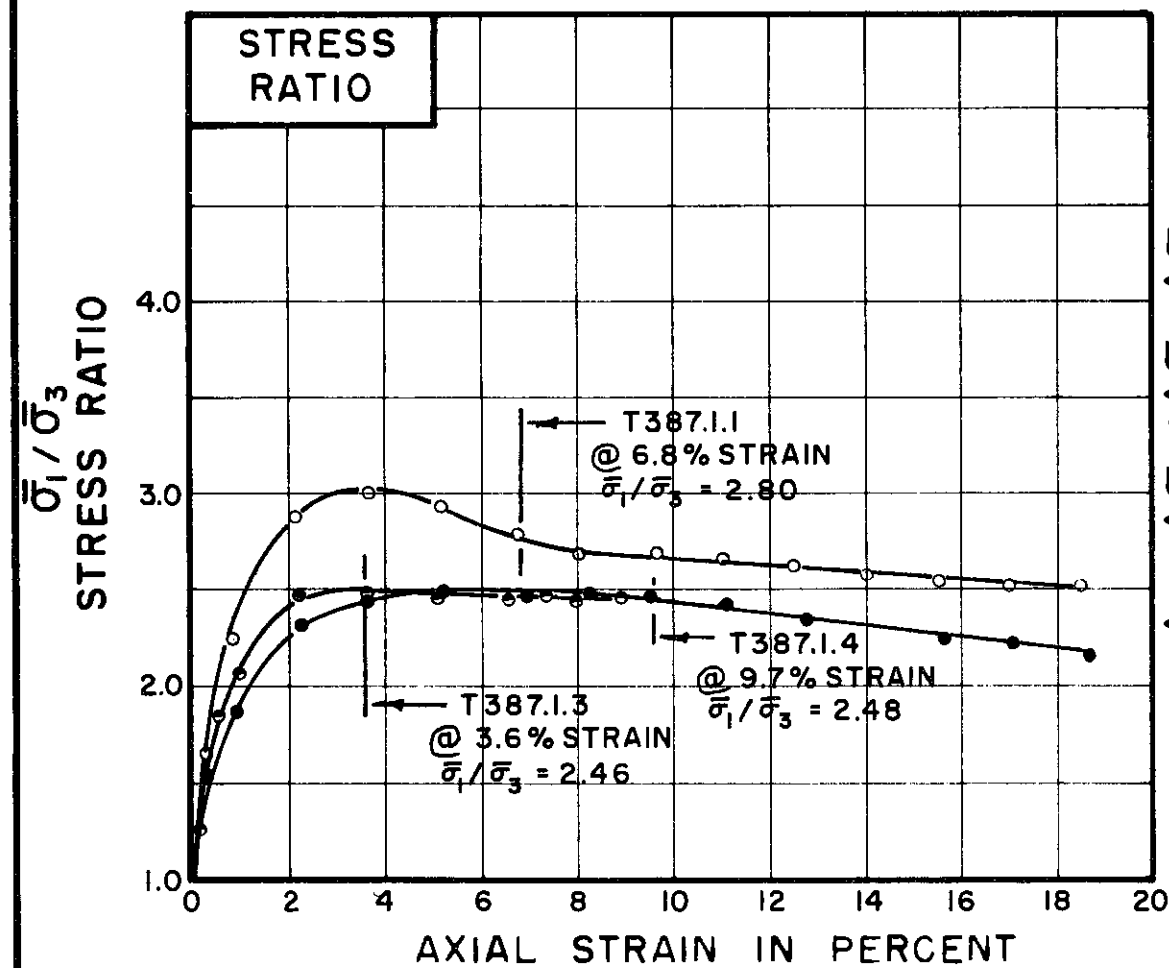
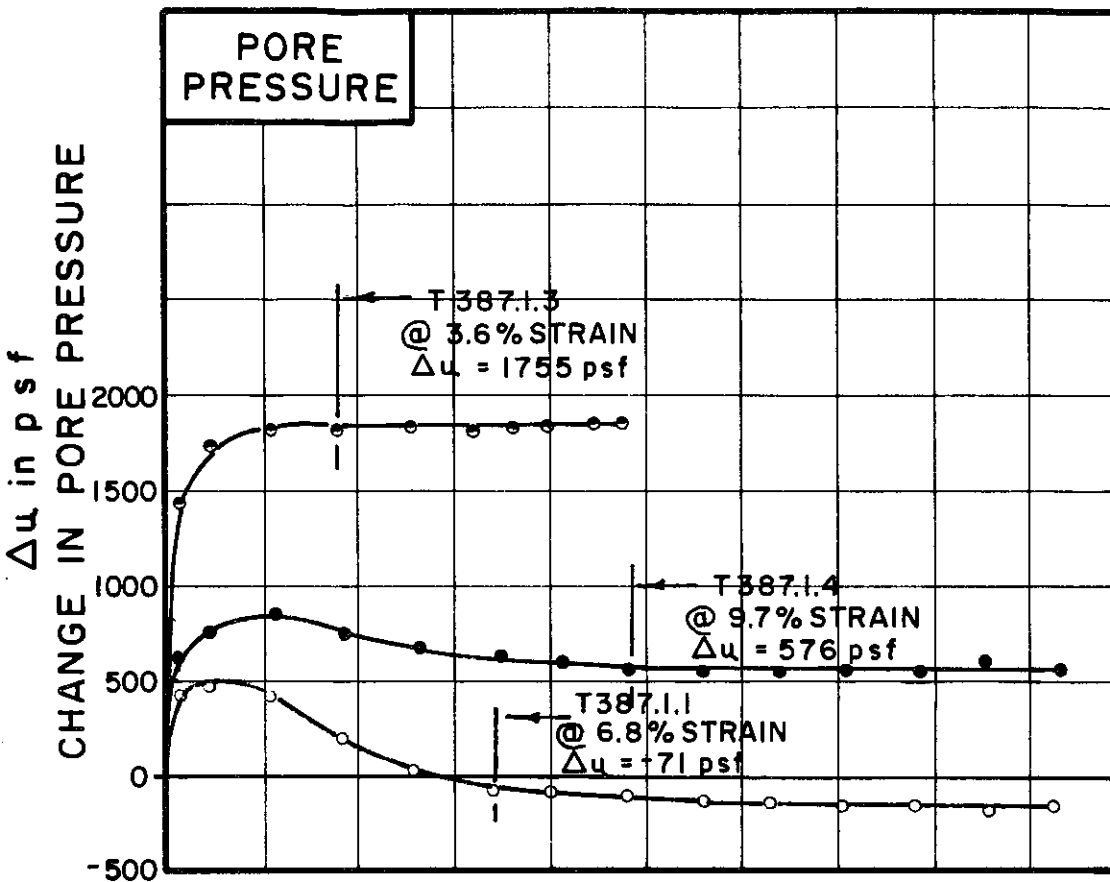
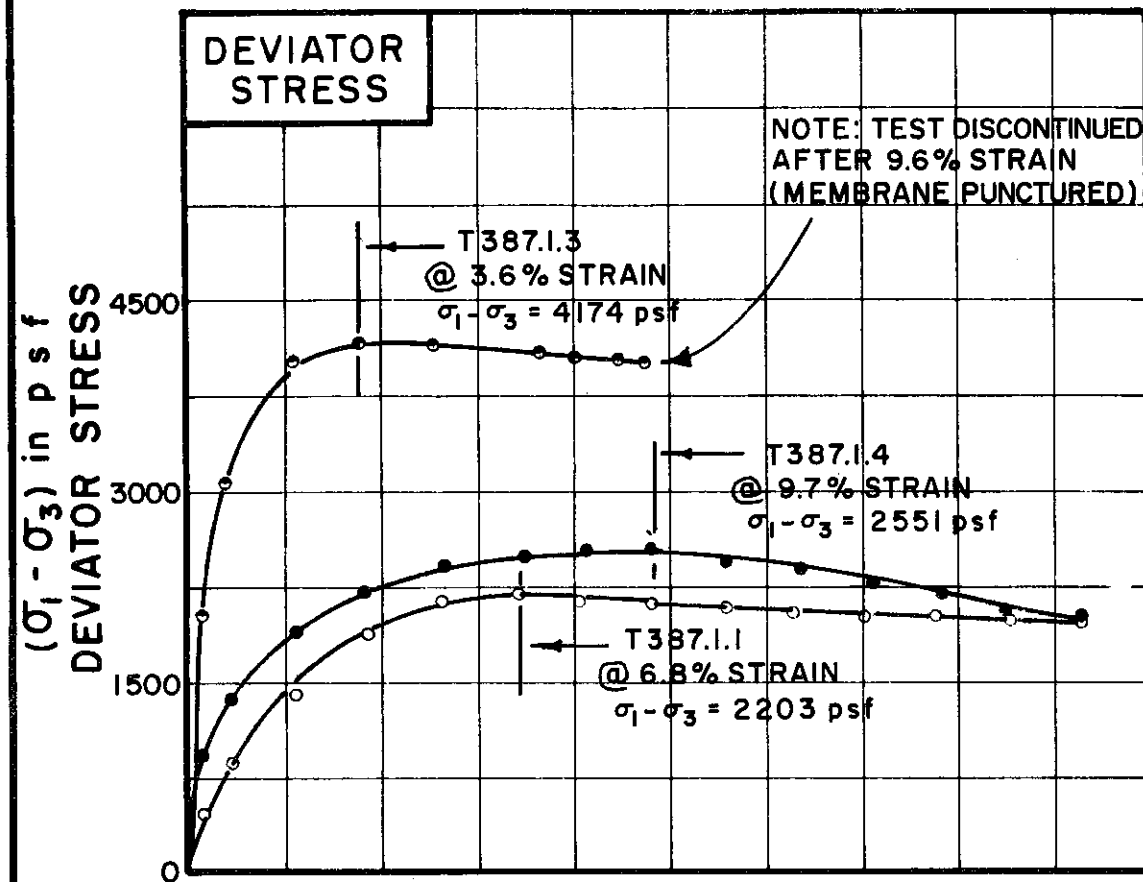

TEST NO. / SYMBOL	T387.1.1	T387.1.4	T387.1.3
-------------------	----------	----------	----------

INITIAL CONDITIONS			T387.1.1	T387.1.4	T387.1.3
WATER CONTENT	w_0		33.5%	33.1%	31.9%
DRY DENSITY	γ_d	lb/cu ft	90	90	90
SAMPLE DIAMETER	D_0	in.	1.41	1.41	1.41
SAMPLE HEIGHT	H_0	in.	3.39	3.38	3.45
FINAL CONDITIONS BEFORE SHEAR			T387.1.1	T387.1.4	T387.1.3
FINAL BACK PRESSURE	u_0	p.s.f.	6480	5760	6480
INITIAL EFFECTIVE STRESS	$\bar{\sigma}_1 / \bar{\sigma}_3$	p.s.f.	1152	2304	4608
VOLUMETRIC STRAIN	ϵ_{vol}		1.31%	2.94%	3.20%
PORE PRESSURE RESPONSE			98%	99%	97%
FINAL CONDITIONS			T387.1.1	T387.1.4	T387.1.3
WATER CONTENT	w_f		33.4%	31.9%	—%
SKETCH OF SAMPLE AT END OF TEST					

RATE OF STRAIN PERCENT/MINUTE	.024	.024	.023
-------------------------------	------	------	------

BORING NO. 129
 SAMPLE NO. 5
 DEPTH 18.0' TO 21.0'
 SOIL DESCRIPTION SILTY CLAY (CL-CH)
 LIQUID LIMIT 48 PLASTIC LIMIT 21

CONSOLIDATED UNDRAINED TRIAXIAL COMPRESSION TESTS

THE DETROIT EDISON COMPANY
 BELLE RIVER PLANT UNITS I & II

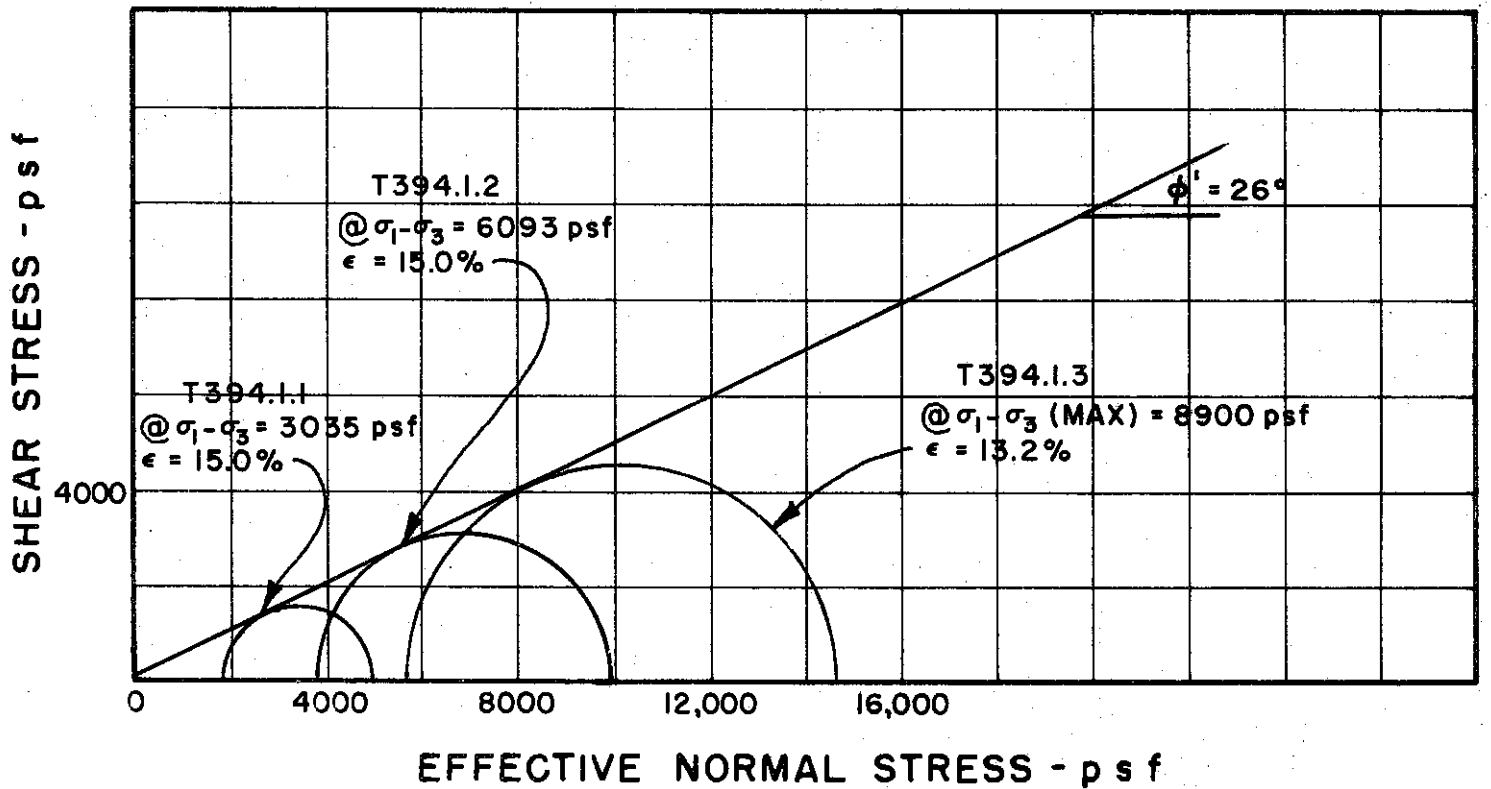
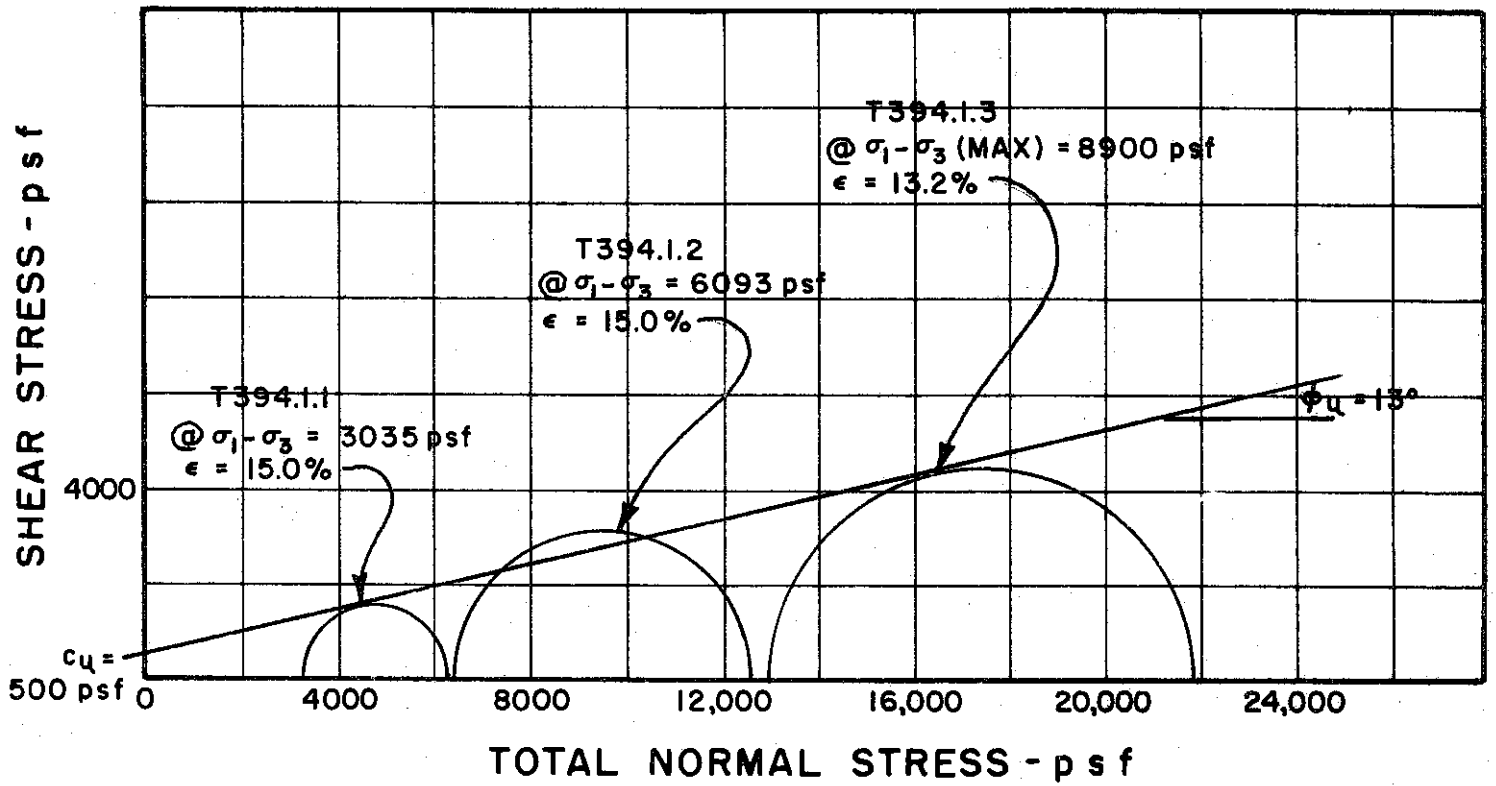

BORING NO. 129

SAMPLE NO. 19

DEPTH 93.0' TO 95.5'

REMARKS ENVELOPE IS INTERPRETIVE,
BASED ON LIMITED DATA POINTS
AVAILABLE

GOLDBERG-ZOINO AND ASSOCIATES, INC.
CONSULTANTS IN GEOTECHNICAL ENGINEERING

MOHR STRENGTH ENVELOPE
TRIAXIAL COMPRESSION
TESTS

THE DETROIT EDISON COMPANY
BELLE RIVER PLANT UNITS I & II

FILE 1255

C-443

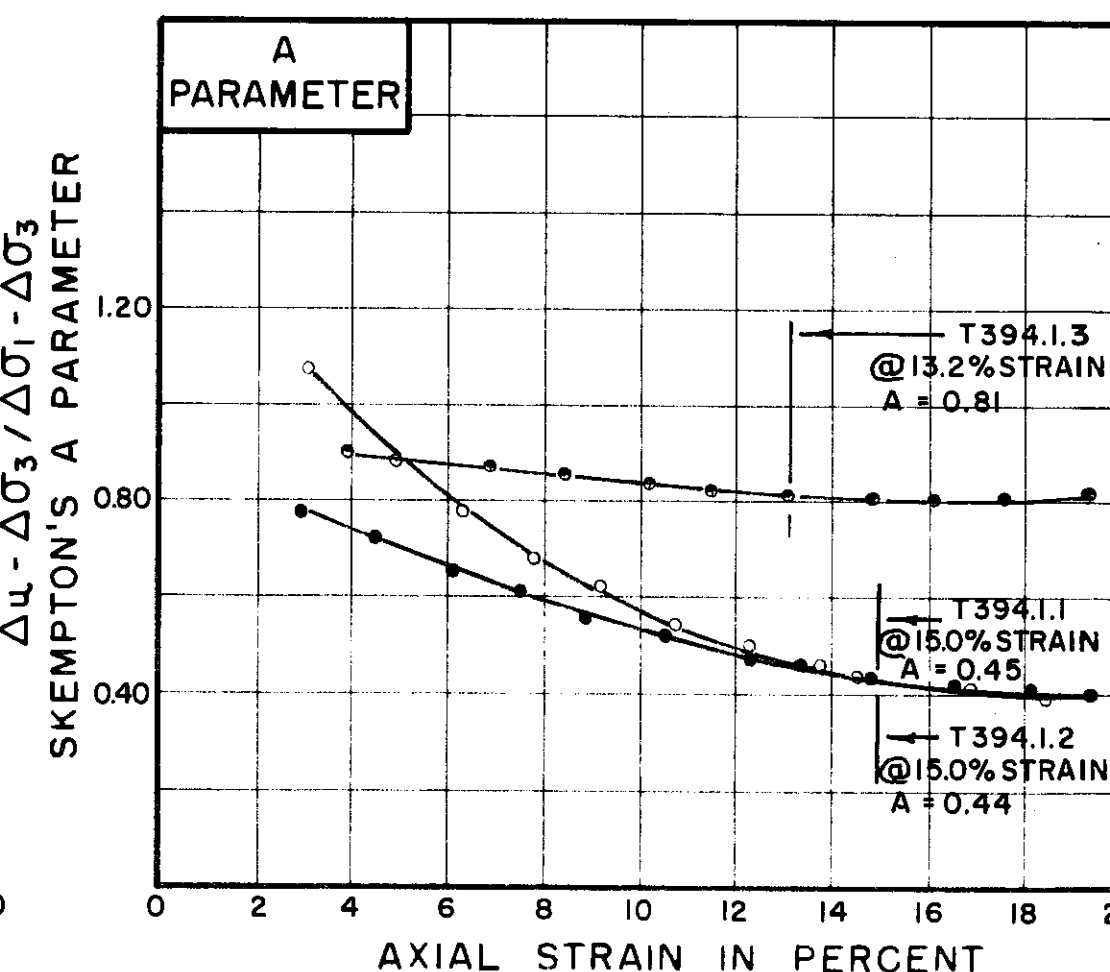
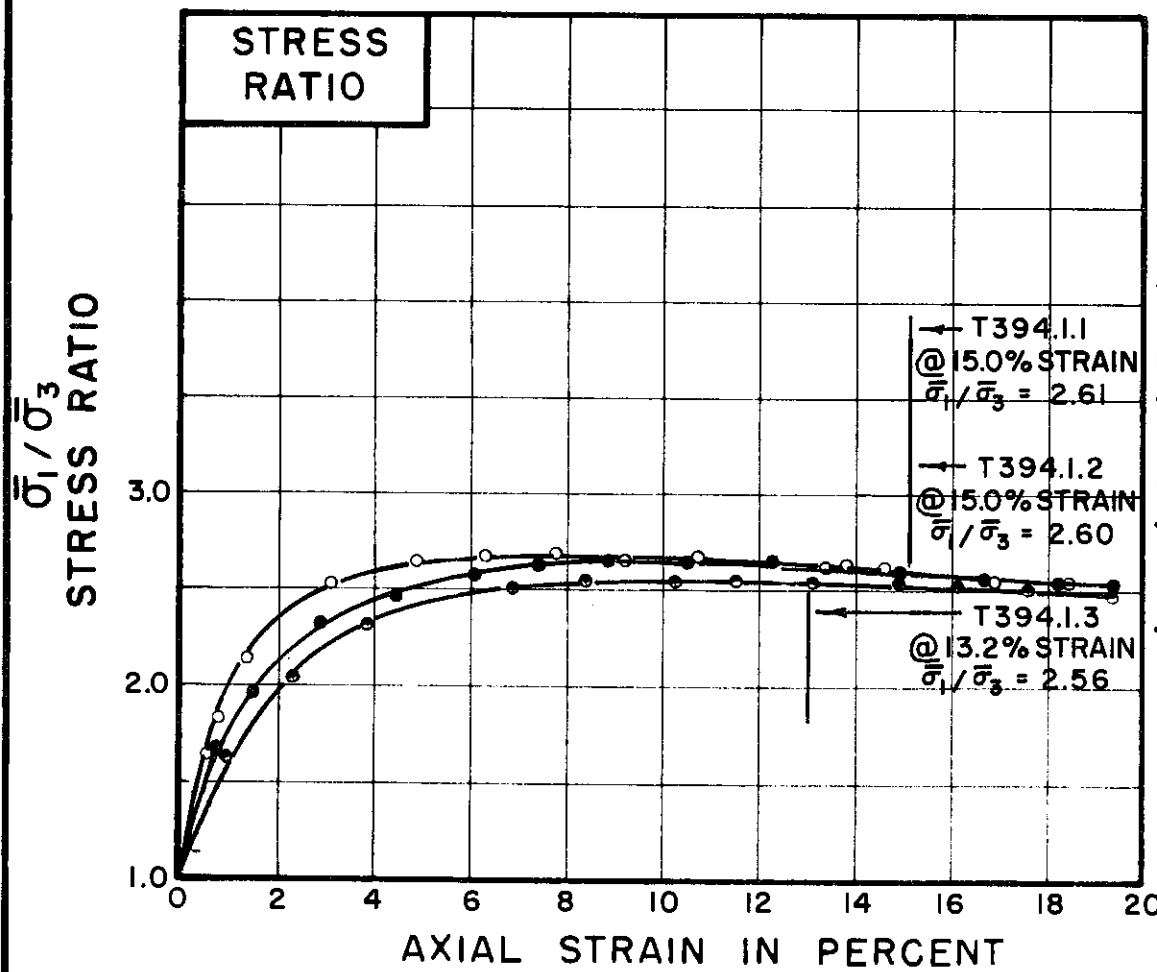
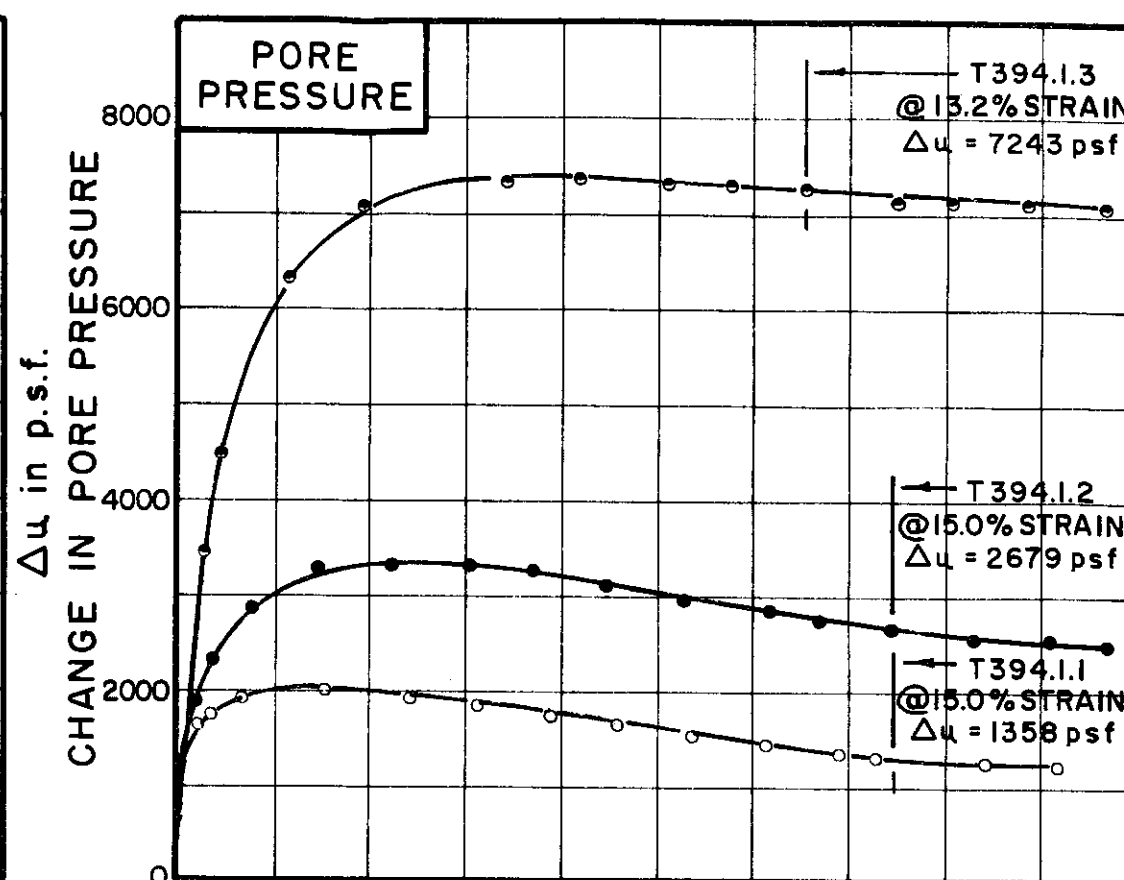
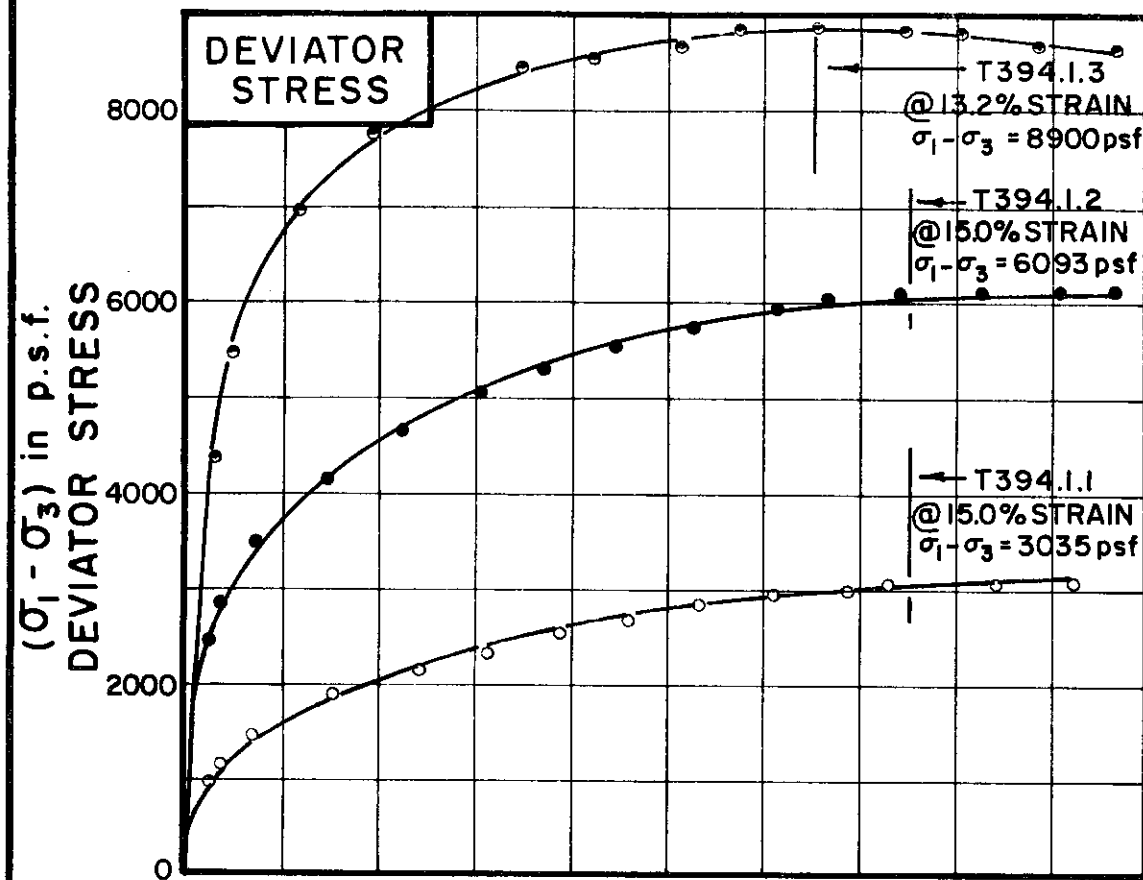

TEST NO. / SYMBOL	T394.1.1	T394.1.2	T394.1.3
-------------------	----------	----------	----------

INITIAL CONDITIONS		T394.1.1	T394.1.2	T394.1.3
WATER CONTENT	w_0	23.7%	25.9%	27.0%
DRY DENSITY	γ_d	99	99	99
SAMPLE DIAMETER	D_0	1.39	1.40	1.40
SAMPLE HEIGHT	H_0	3.27	3.38	3.32
FINAL CONDITIONS BEFORE SHEAR				
FINAL BACK PRESSURE	u_0	7200	7200	7200
INITIAL EFFECTIVE STRESS	$\bar{\sigma}_1, \bar{\sigma}_3$	3240	6480	12960
VOLUMETRIC STRAIN	ϵ_{vol}	1.73%	2.61%	5.03%
PORE PRESSURE RESPONSE		99%	98%	98%
FINAL CONDITIONS AT END OF TEST				
WATER CONTENT	w_f	22.2%	22.7%	21.5%
SKETCH OF SAMPLE AT END OF TEST				

RATE OF STRAIN PERCENT / MINUTE	.025	.024	.025
---------------------------------	------	------	------

BORING NO. 129
 SAMPLE NO. 19
 DEPTH 93.0' TO 95.5'
 SOIL DESCRIPTION SILTY CLAY (CL)
 LIQUID LIMIT 41 PLASTIC LIMIT 21

CONSOLIDATED UNDRAINED
 TRIAXIAL COMPRESSION
 TESTS

THE DETROIT EDISON COMPANY
 BELLE RIVER PLANT UNITS I & II

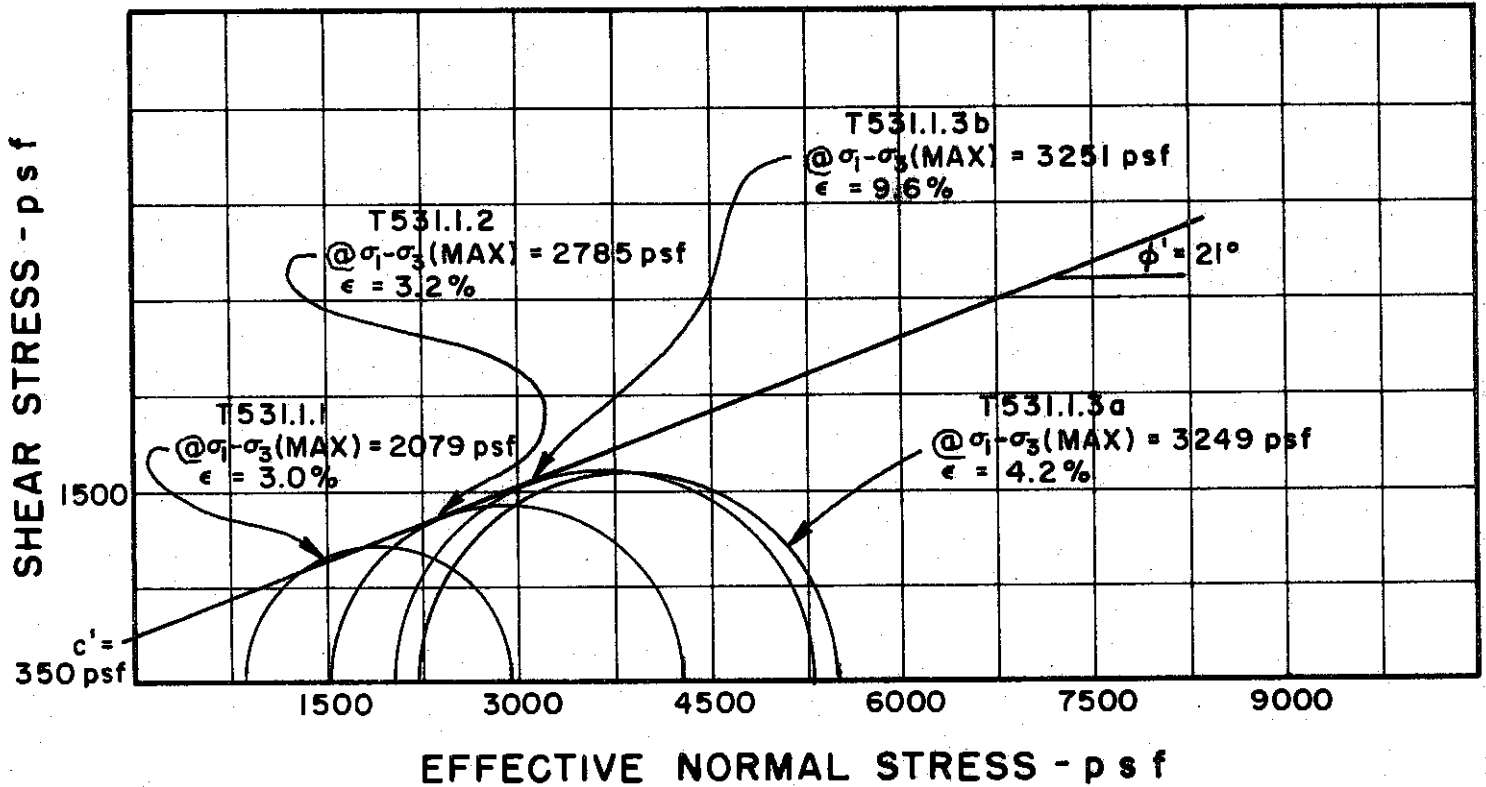
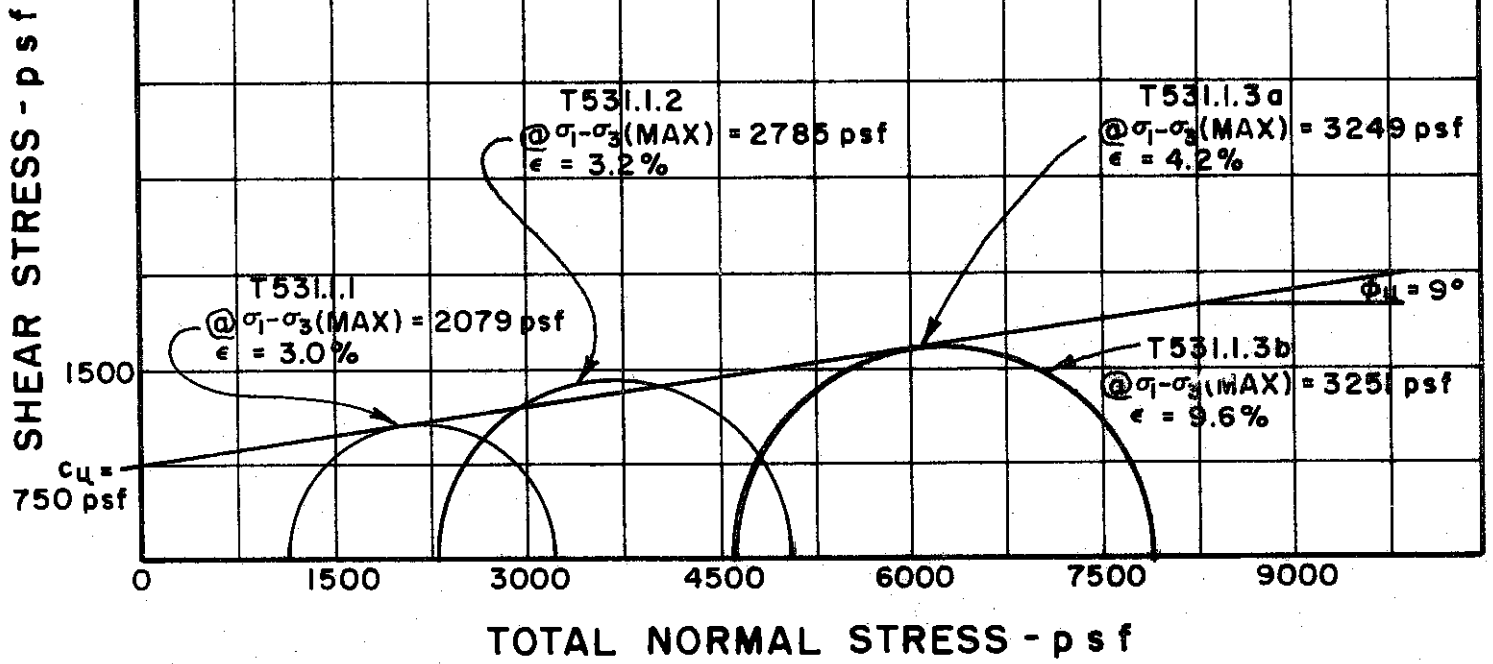

BORING NO. 141
 SAMPLE NO. 4
 DEPTH 18.0' TO 20.0'

MOHR STRENGTH ENVELOPE
 TRIAXIAL COMPRESSION
 TESTS

REMARKS ENVELOPE IS INTERPRETIVE,
BASED ON LIMITED DATA POINTS
AVAILABLE

THE DETROIT EDISON COMPANY
 BELLE RIVER PLANT UNITS I & II

GOLDBERG-ZOINO AND ASSOCIATES, INC.
 CONSULTANTS IN GEOTECHNICAL ENGINEERING

FILE 1255

C-445

TEST NO. / SYMBOL	T531.1.1	T531.1.2	T531.1.3a	T531.1.3b
	○	●	◊	◐

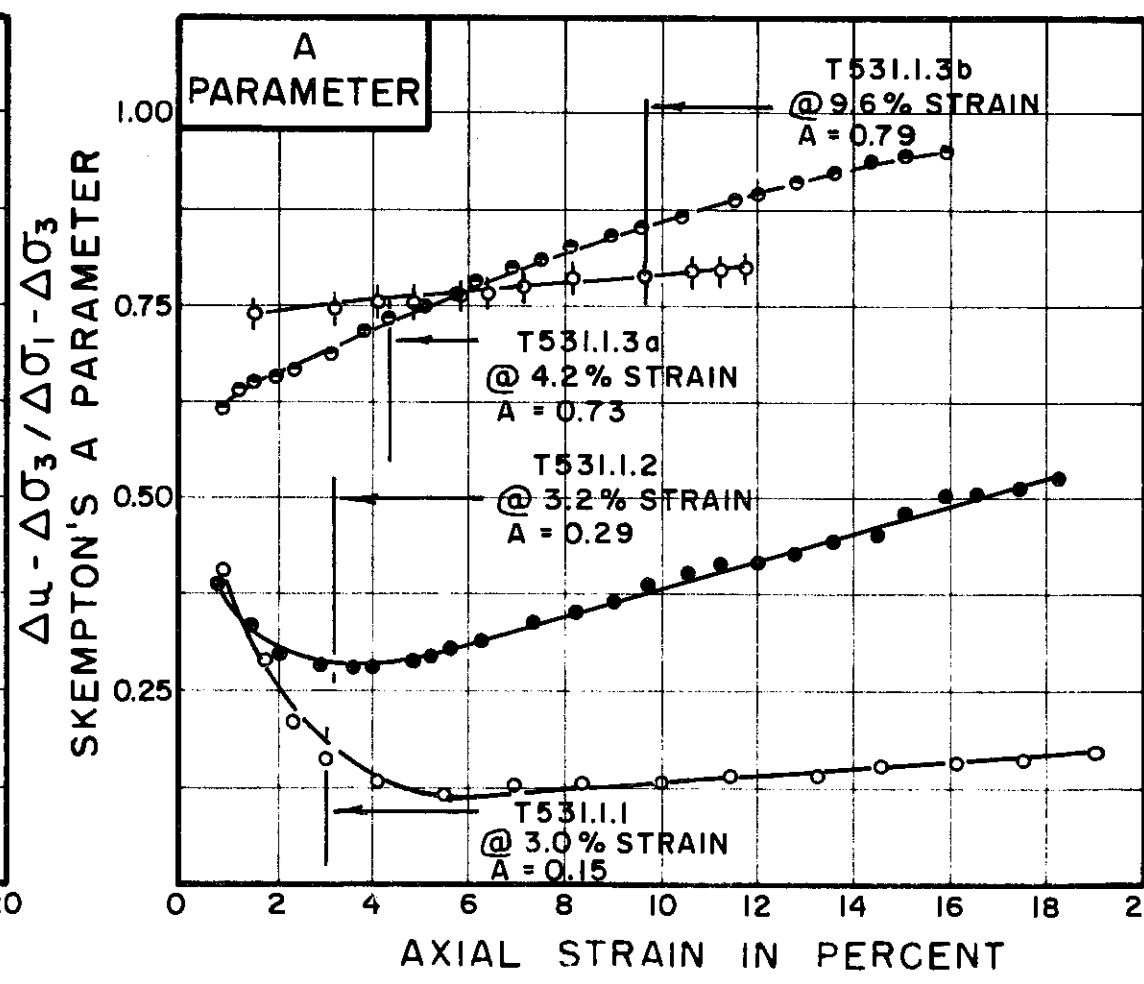
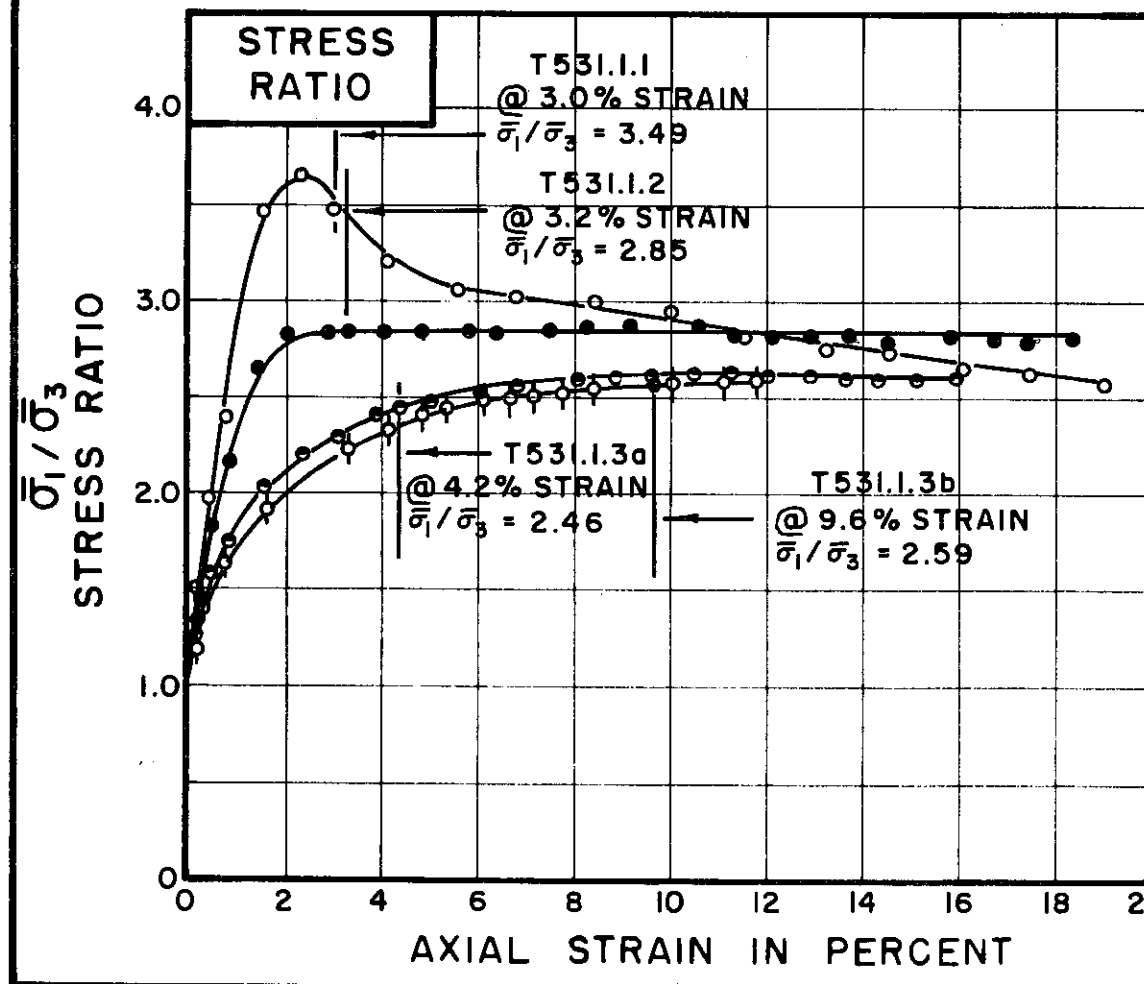
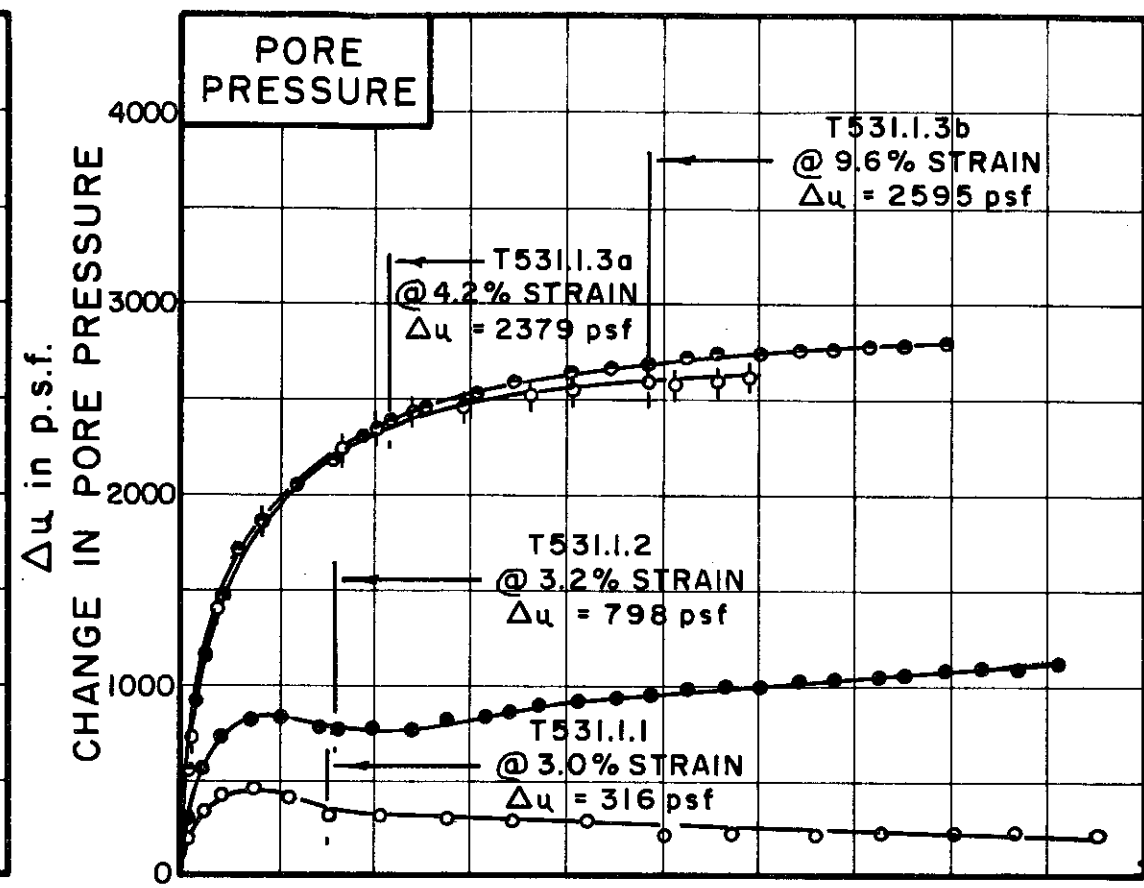
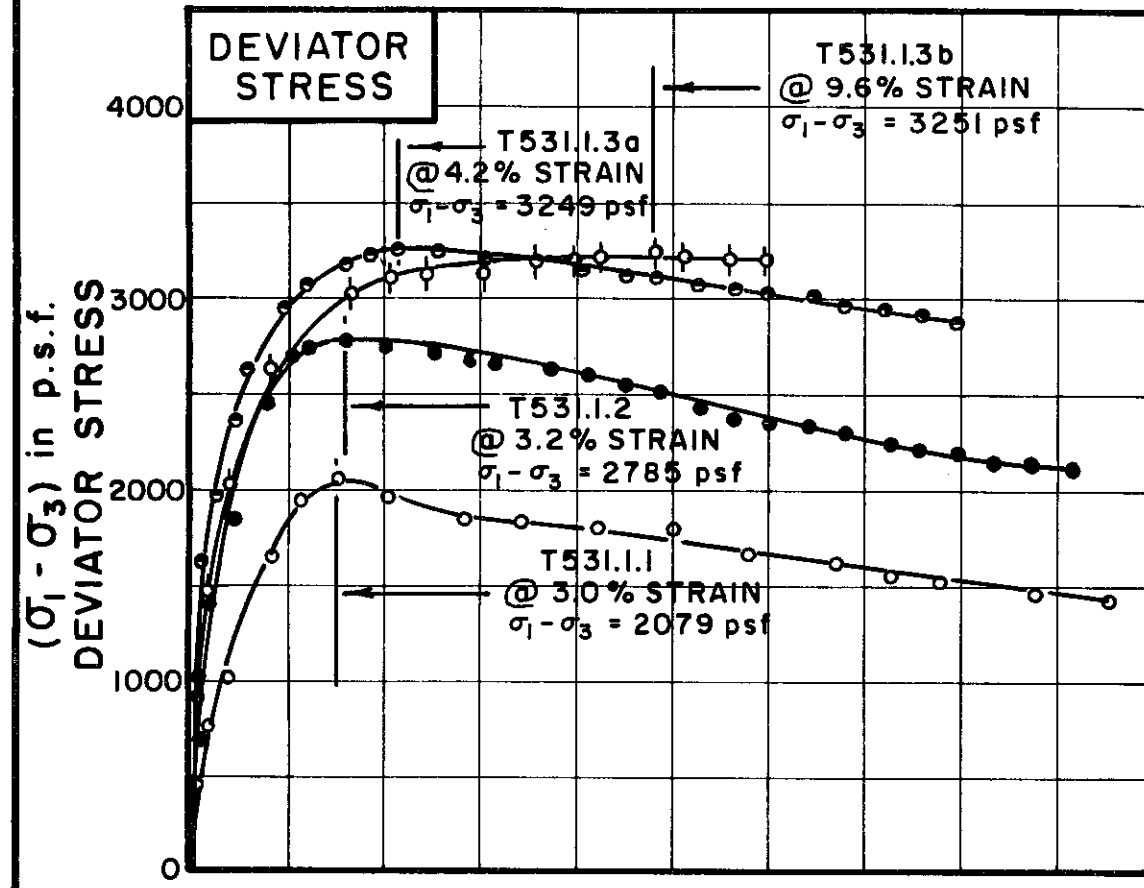

INITIAL CONDITIONS	WATER CONTENT w_0	36.3%	35.5%	35.1%
				37.3%
	DRY DENSITY γ_d lb/cu ft	86	87	85
				84
SAMPLE DIAMETER in.	D_0	1.39	1.40	1.41
SAMPLE HEIGHT in.	H_0	3.30	3.20	3.33
				3.28
FINAL CONDITIONS BEFORE SHEAR	FINAL BACK PRESSURE p.s.f.	u_0	10080	8640
				11520
	INITIAL EFFECTIVE STRESS p.s.f.	σ_1', σ_3'	1152	2304
				4608
				4637
VOLUMETRIC STRAIN ϵ_{vol}		0.9%	1.2%	4.3%
				5.1%
PORE PRESSURE RESPONSE		96%	95%	96%
				91%
FINAL CONDITIONS	WATER CONTENT w_f	35.5%	34.5%	30.9%
				34.4%
SKETCH OF SAMPLE AT END OF TEST				

RATE OF STRAIN PERCENT/MINUTE	0.24	.010	.010
			.007

BORING NO. 141

SAMPLE NO. 4

DEPTH 18.0' TO 20.0'

SOIL DESCRIPTION SILTY CLAY (CL)

LIQUID LIMIT 45 PLASTIC LIMIT 21

CONSOLIDATED UNDRAINED TRIAXIAL COMPRESSION TESTS

THE DETROIT EDISON COMPANY
BELLE RIVER PLANT UNITS I & II

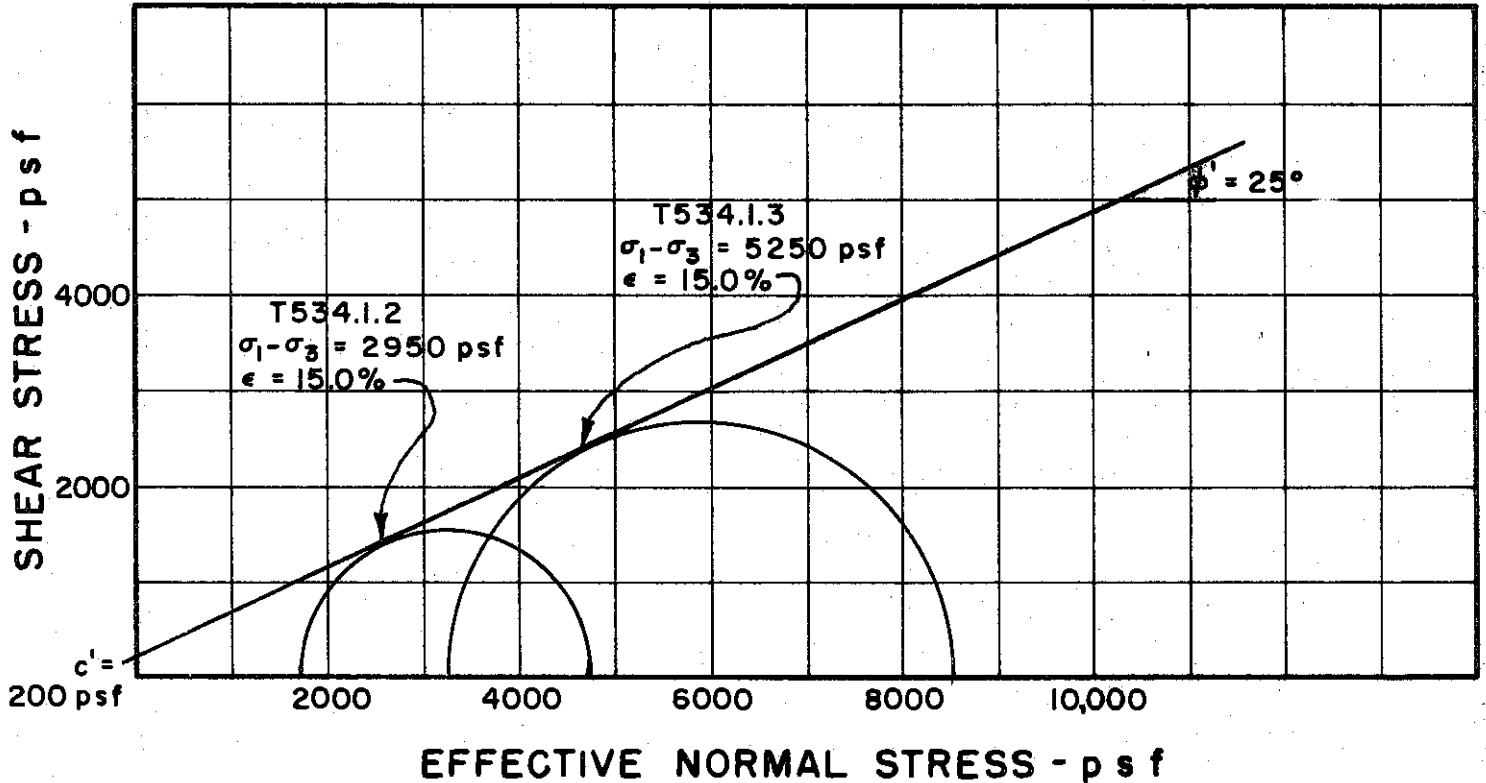
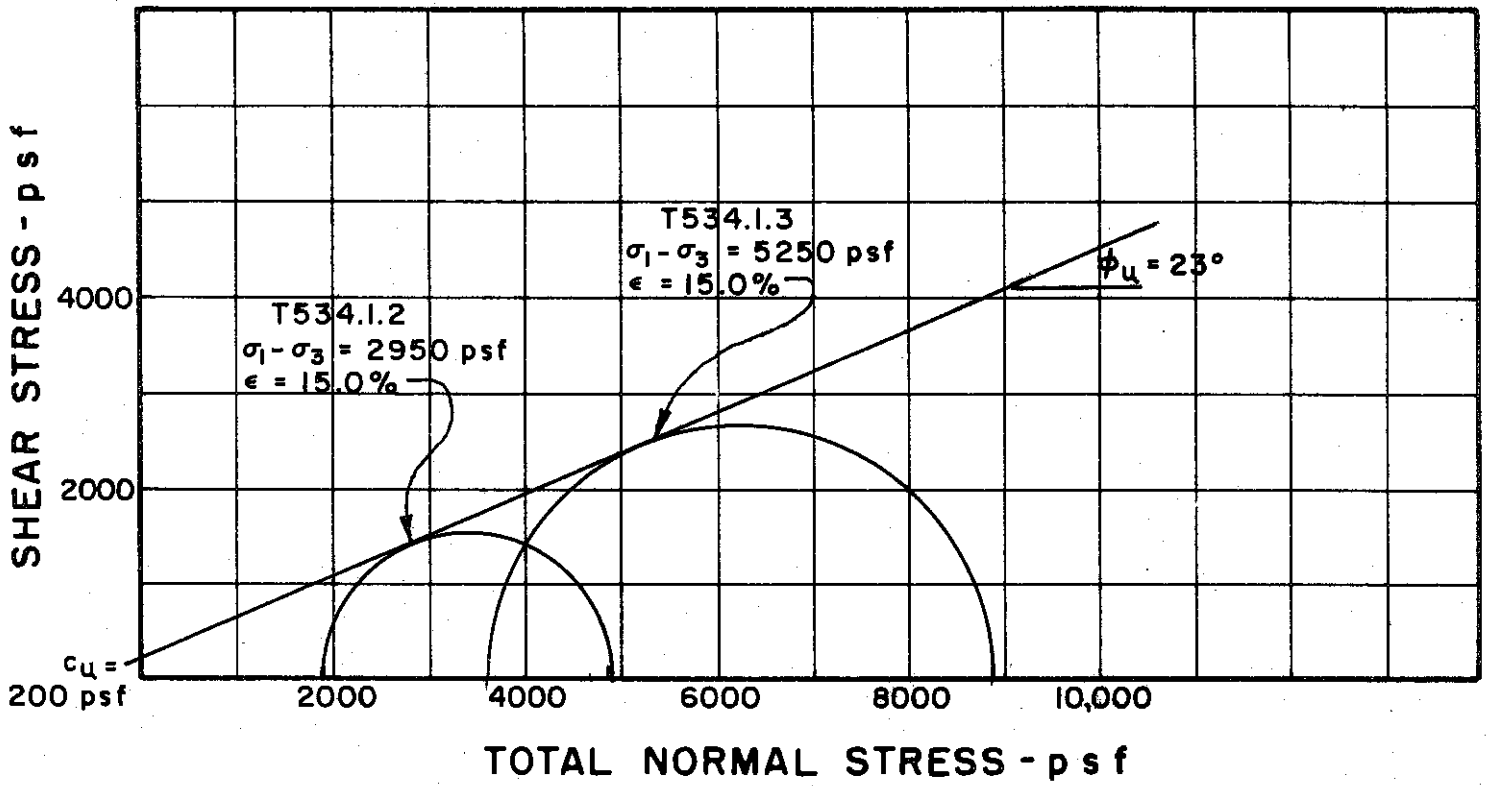

BORING NO. 142
 SAMPLE NO. 3
 DEPTH 14.0' TO 16.1'

MOHR STRENGTH ENVELOPE
 TRIAXIAL COMPRESSION
 TESTS

REMARKS ENVELOPE IS INTERPRETIVE,
BASED ON LIMITED DATA POINTS
AVAILABLE

THE DETROIT EDISON COMPANY
 BELLE RIVER PLANT UNITS I & II

GOLDBERG-ZOINO AND ASSOCIATES, INC.
 CONSULTANTS IN GEOTECHNICAL ENGINEERING

FILE 1255
 C-447

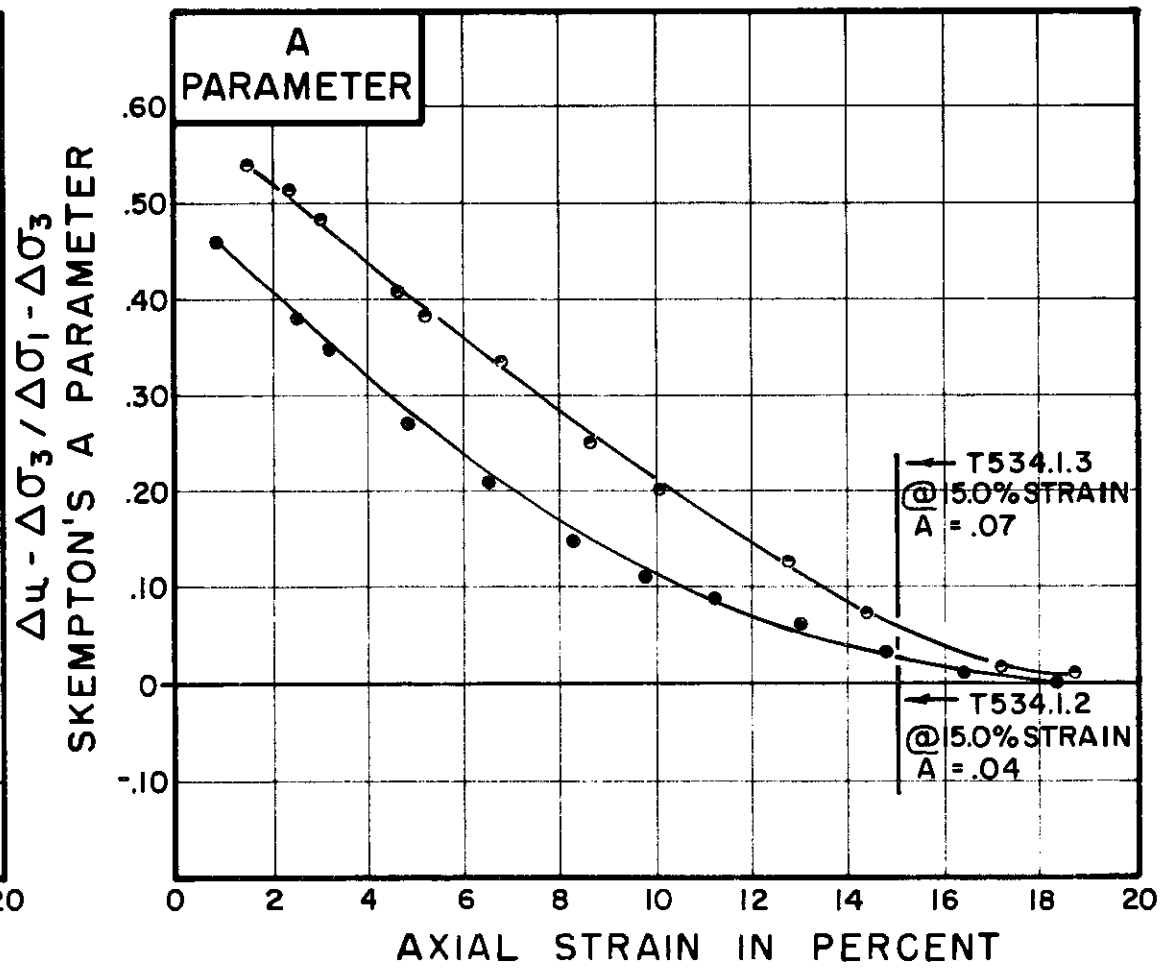
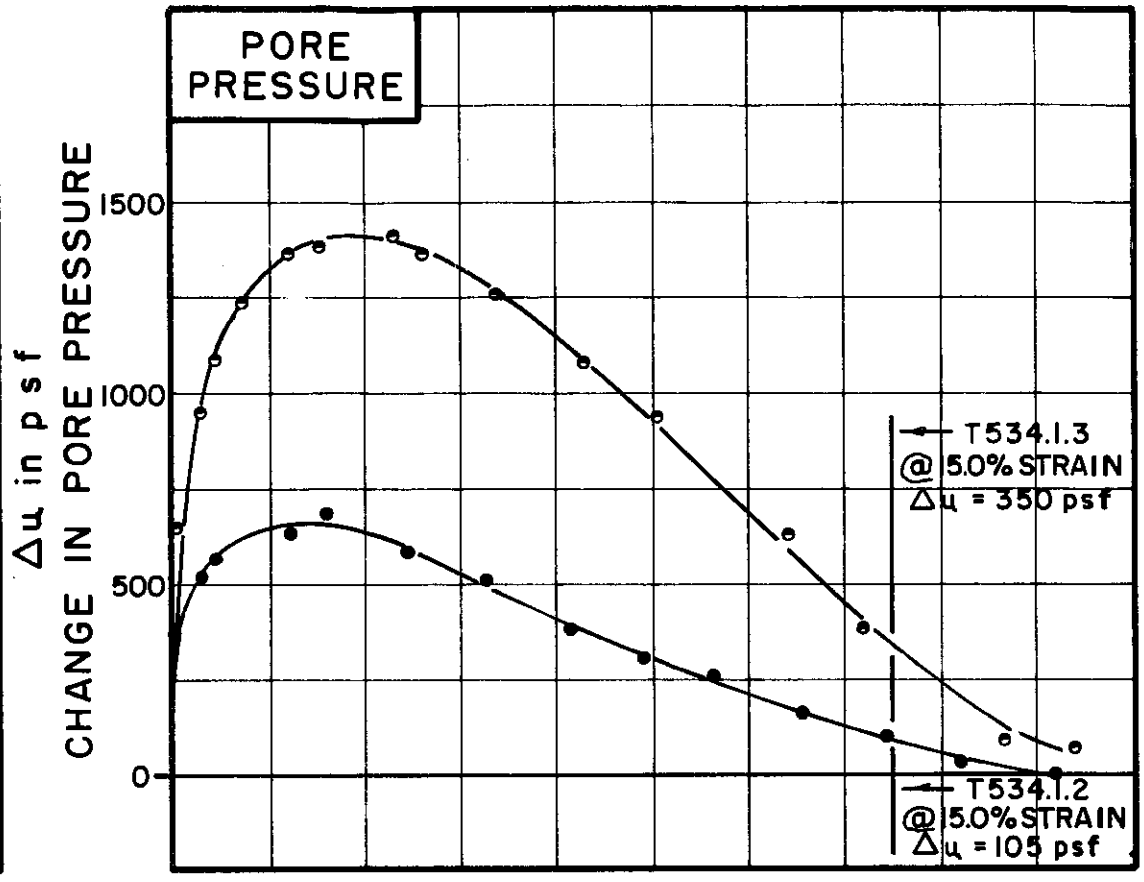
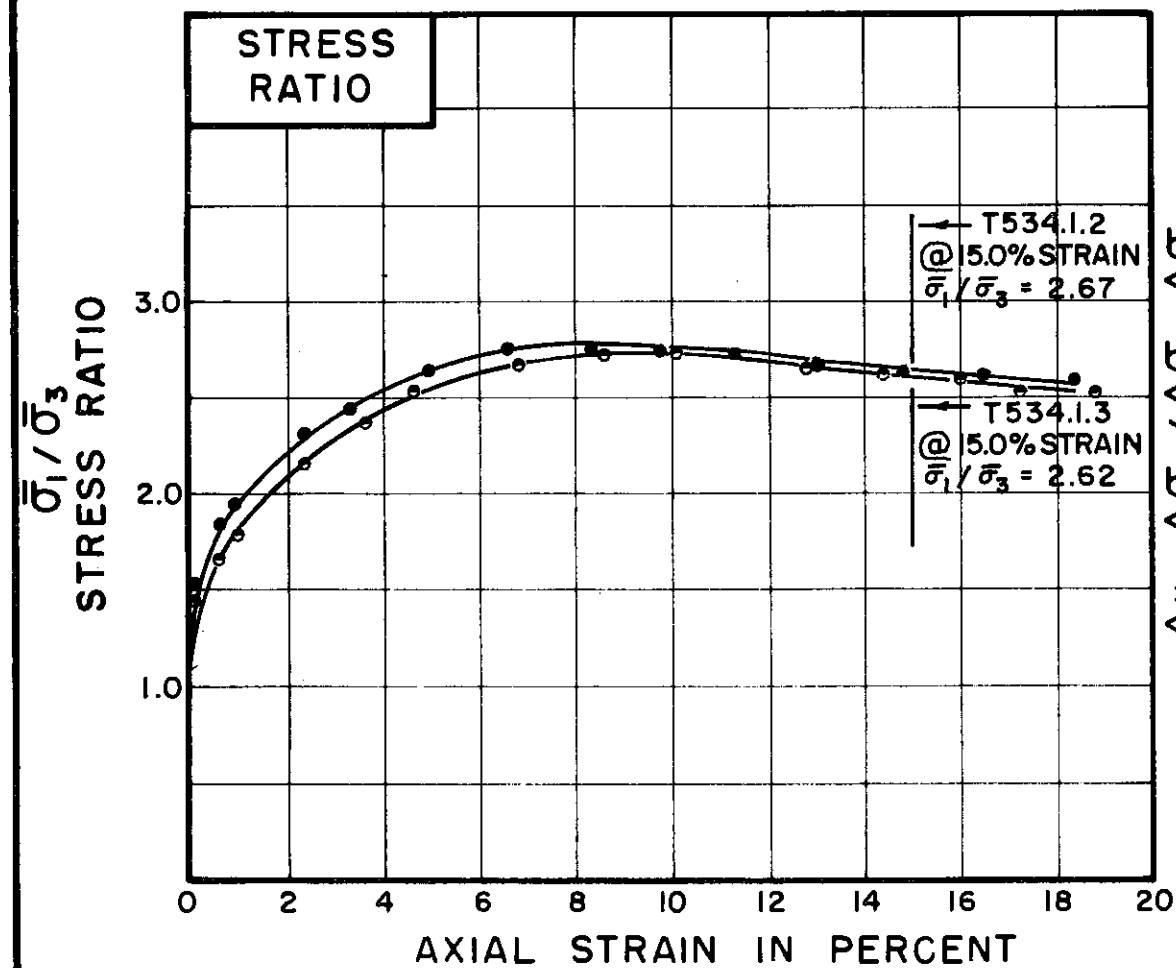
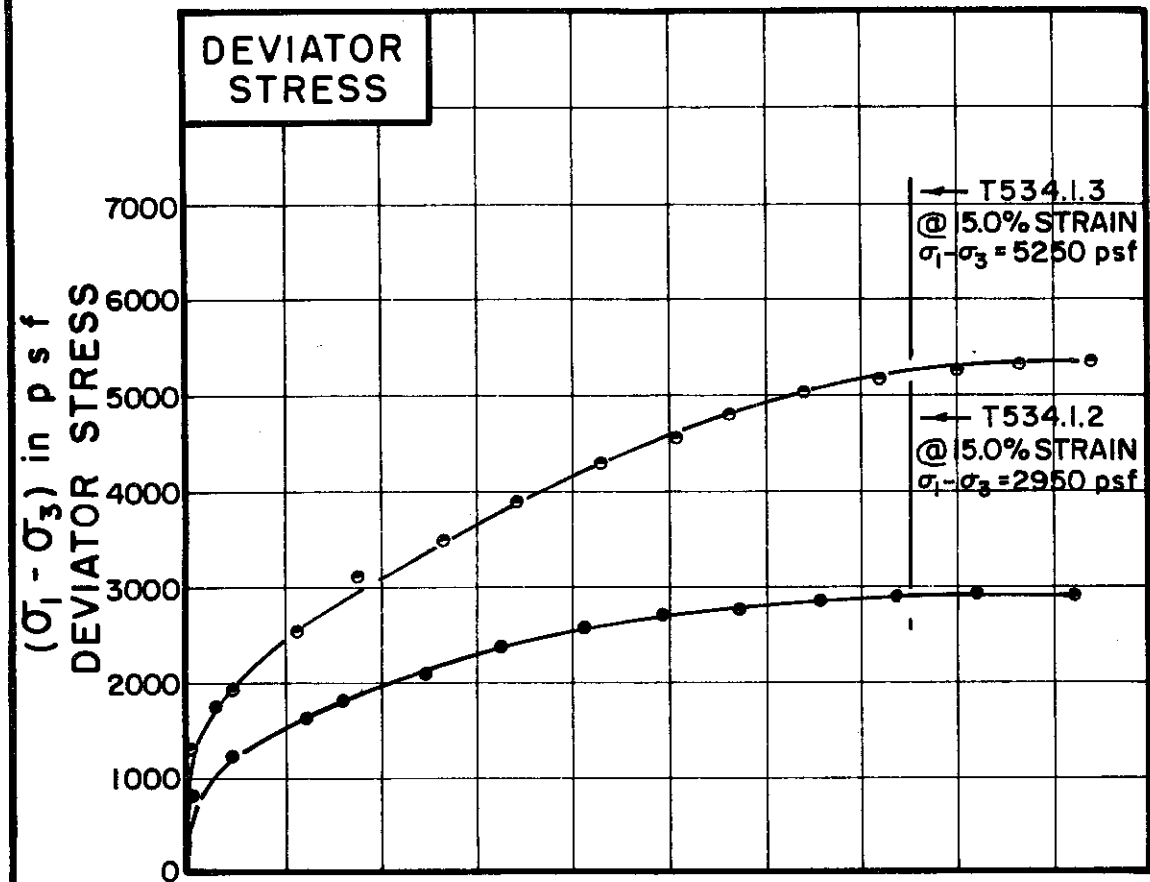

TEST NO. / SYMBOL	T534.1.2	T534.1.3
-------------------	----------	----------

INITIAL CONDITIONS		T534.1.2	T534.1.3	UNIT
WATER CONTENT	w_0	15.3%	15.1%	%
DRY DENSITY	γ_d	105	105	lb/cu ft
SAMPLE DIAMETER	D_0	1.385	1.37	in.
SAMPLE HEIGHT	H_0	3.05	3.31	in.
CONDITIONS BEFORE SHEAR				
FINAL BACK PRESSURE	u_0	20160	23155	psf
INITIAL EFFECTIVE STRESS	σ_1, σ_3	1872	3600	psf
VOLUMETRIC STRAIN	ϵ_{vol}	0.13%	0.13%	%
PORE PRESSURE RESPONSE		97%	94%	
FINAL CONDITIONS				
WATER CONTENT	w_f	29.0%	24.1%	%
SKETCH OF SAMPLE AT END OF TEST				

RATE OF STRAIN PERCENT / MINUTE	.0078	.0072
---------------------------------	-------	-------

BORING NO. 142
 SAMPLE NO. 3
 DEPTH 14.0' TO 16.1'
 SOIL DESCRIPTION SILTY CLAY (CL)
 LIQUID LIMIT 47 PLASTIC LIMIT 22

CONSOLIDATED UNDRAINED
 TRIAXIAL COMPRESSION
 TESTS

THE DETROIT EDISON COMPANY
 BELLE RIVER PLANT UNITS I & II

FILE 1255

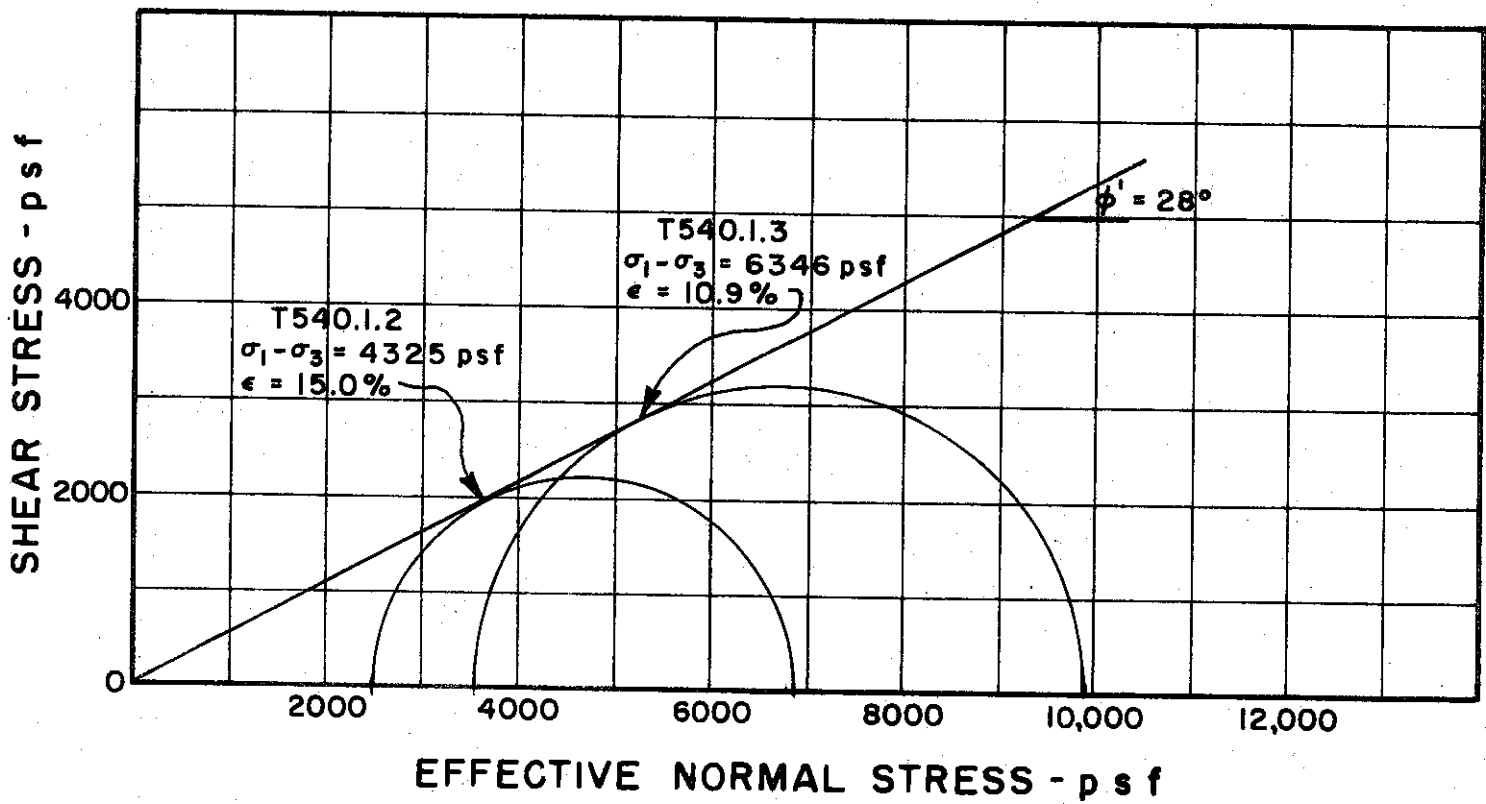
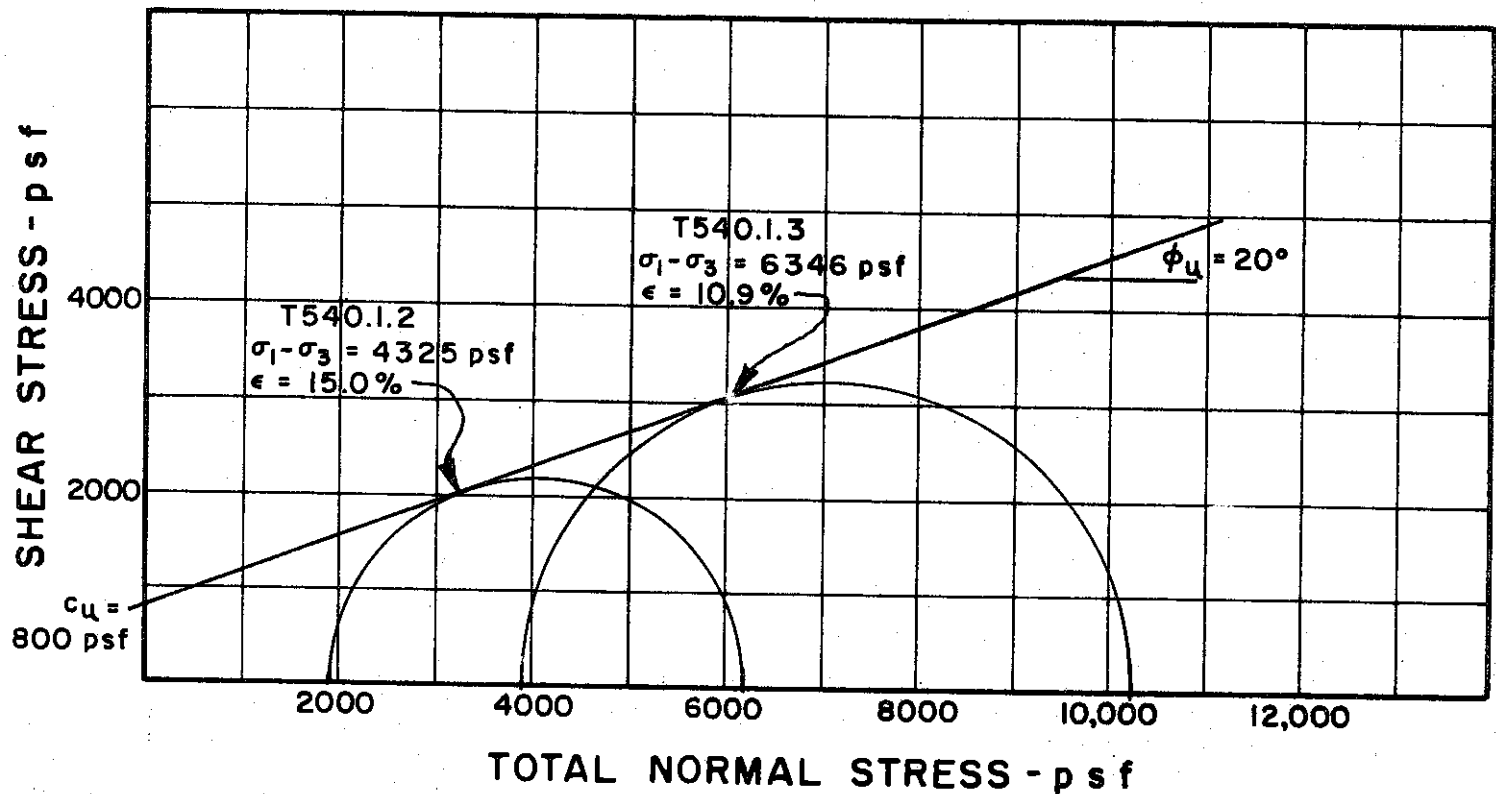

BORING NO. 146

SAMPLE NO. ST 3

DEPTH 6.0' TO 7.8'

REMARKS ENVELOPE IS INTERPRETIVE,
BASED ON LIMITED DATA POINTS
AVAILABLE

GOLDBERG-ZOINO AND ASSOCIATES, INC.
 CONSULTANTS IN GEOTECHNICAL ENGINEERING

MOHR STRENGTH ENVELOPE
 TRIAXIAL COMPRESSION
 TESTS

THE DETROIT EDISON COMPANY
 BELLE RIVER PLANT UNITS I & II

FILE 1255

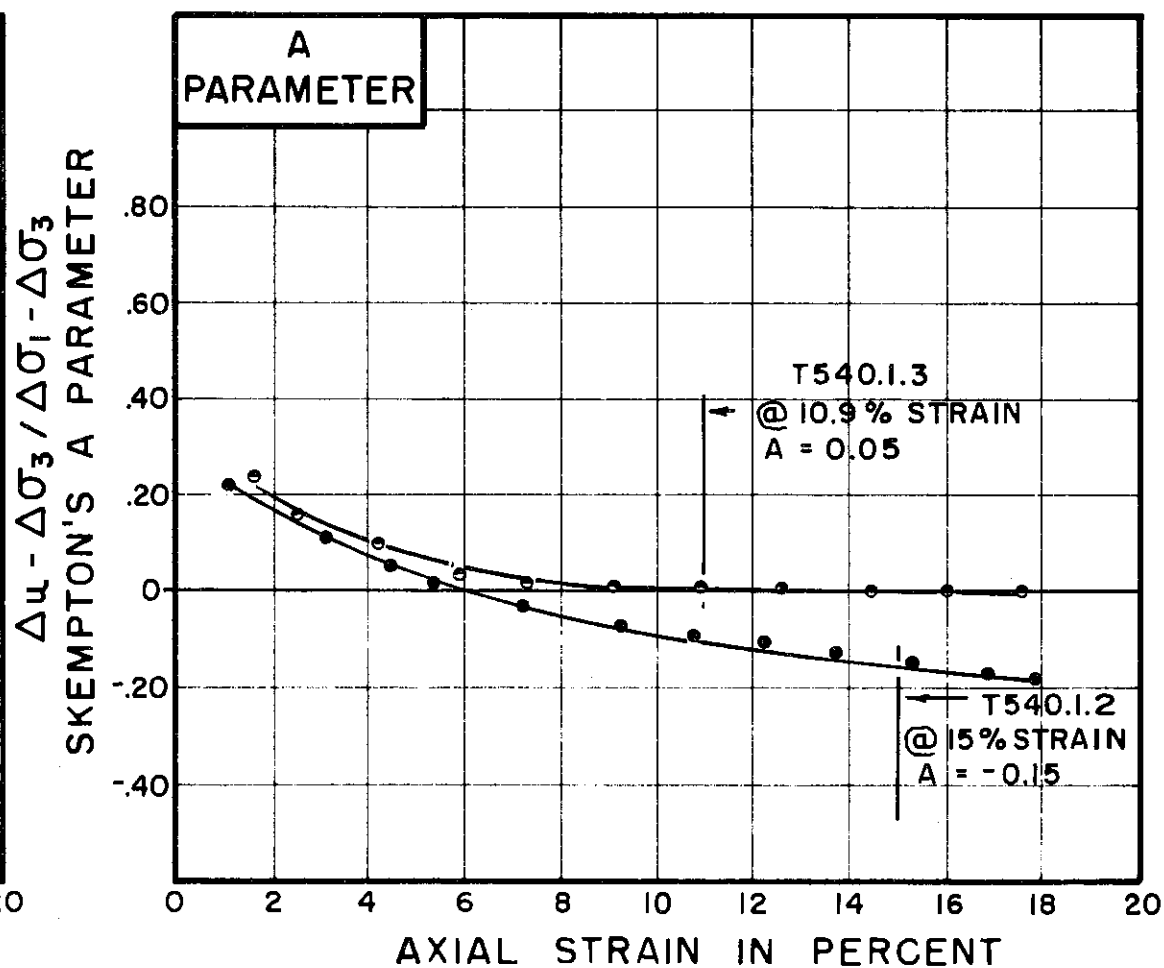
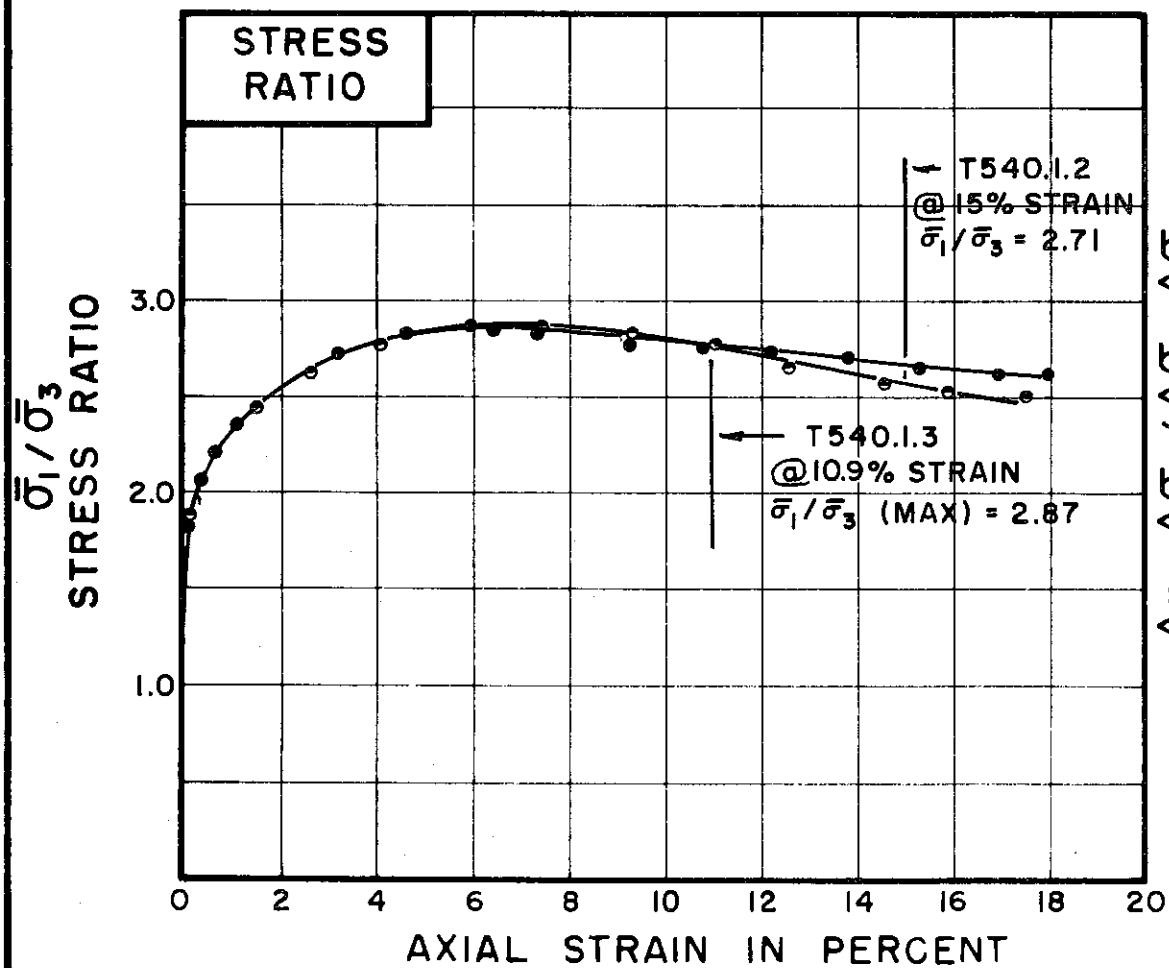
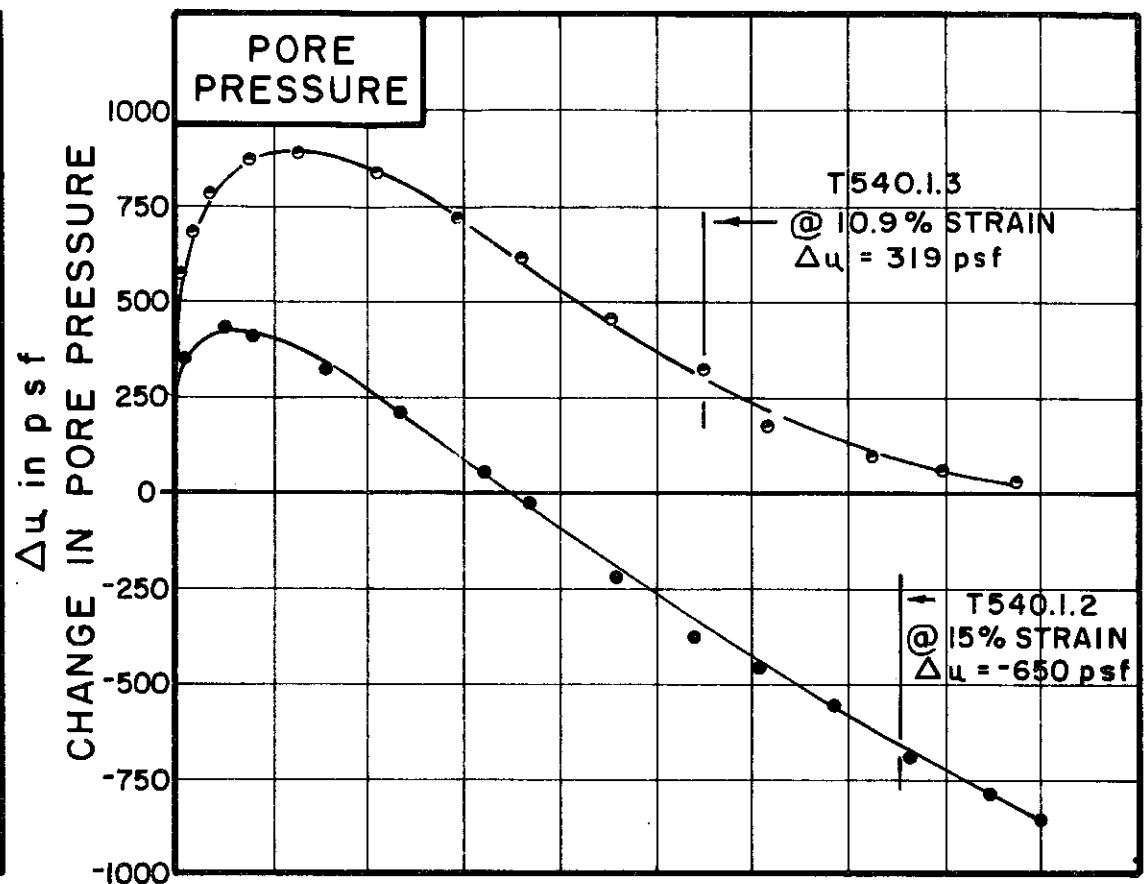
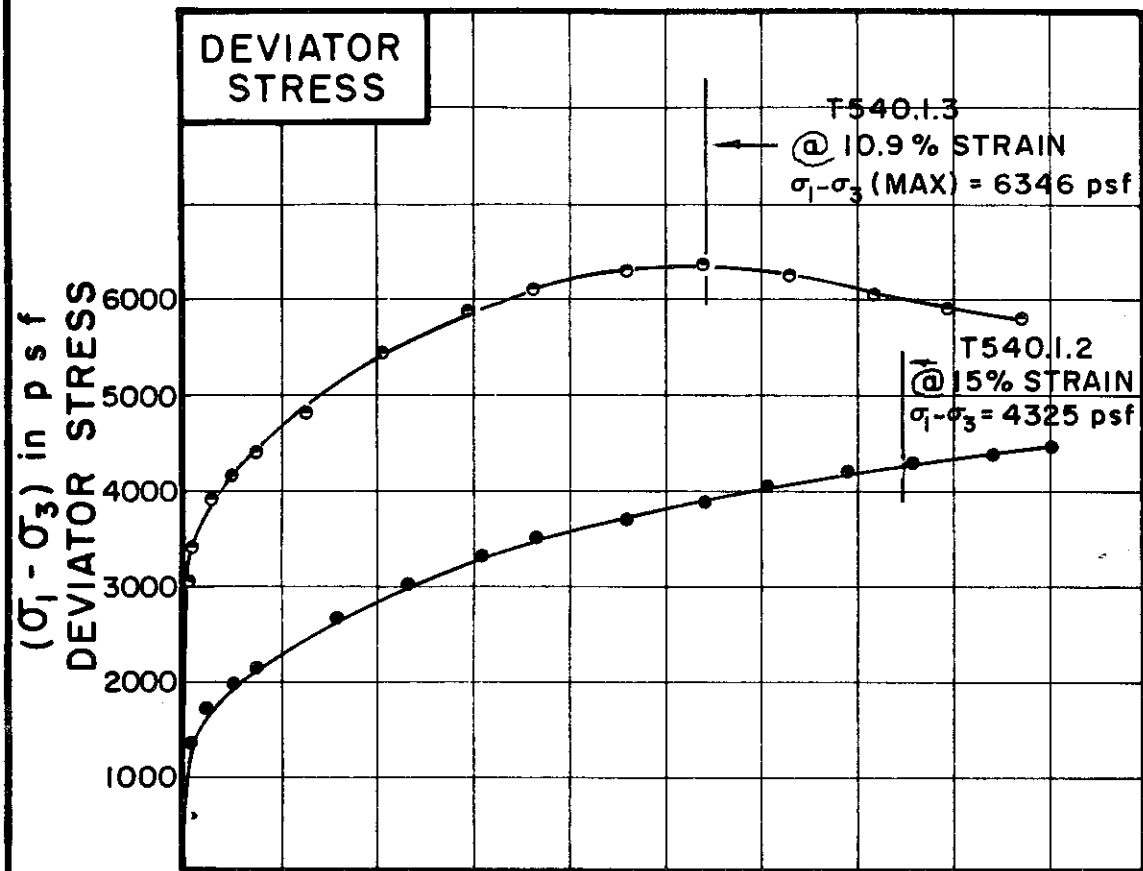

TEST NO. / SYMBOL	T540.1.2	T540.1.3
-------------------	----------	----------

INITIAL CONDITIONS		T540.1.2	T540.1.3	UNIT
WATER CONTENT	w_0	14.4%	14.2%	%
DRY DENSITY	γ_d	108	108	lb/cu ft
SAMPLE DIAMETER	D_0	1.35	1.37	in.
SAMPLE HEIGHT	H_0	3.27	3.02	in.
FINAL CONDITIONS BEFORE SHEAR				
FINAL BACK PRESSURE	u_0	25344	25344	psf
INITIAL EFFECTIVE STRESS	$\frac{\sigma_1}{\sigma_3}$	1872	3888	psf
VOLUMETRIC STRAIN	ϵ_{vol}	1.82%	4.12%	%
PORE PRESSURE RESPONSE		97%	96%	
FINAL CONDITIONS				
WATER CONTENT	w_f	24.4%	23.2%	%
SKETCH OF SAMPLE AT END OF TEST				

RATE OF STRAIN PERCENT/MINUTE	.0073	.0079
-------------------------------	-------	-------

BORING NO. 146
 SAMPLE NO. ST 3
 DEPTH 6.0' TO 7.8'
 SOIL DESCRIPTION SILTY CLAY (CL)
 LIQUID LIMIT 44 PLASTIC LIMIT 21

CONSOLIDATED UNDRAINED
 TRIAXIAL COMPRESSION
 TESTS

THE DETROIT EDISON COMPANY
 BELLE RIVER PLANT UNITS I & II

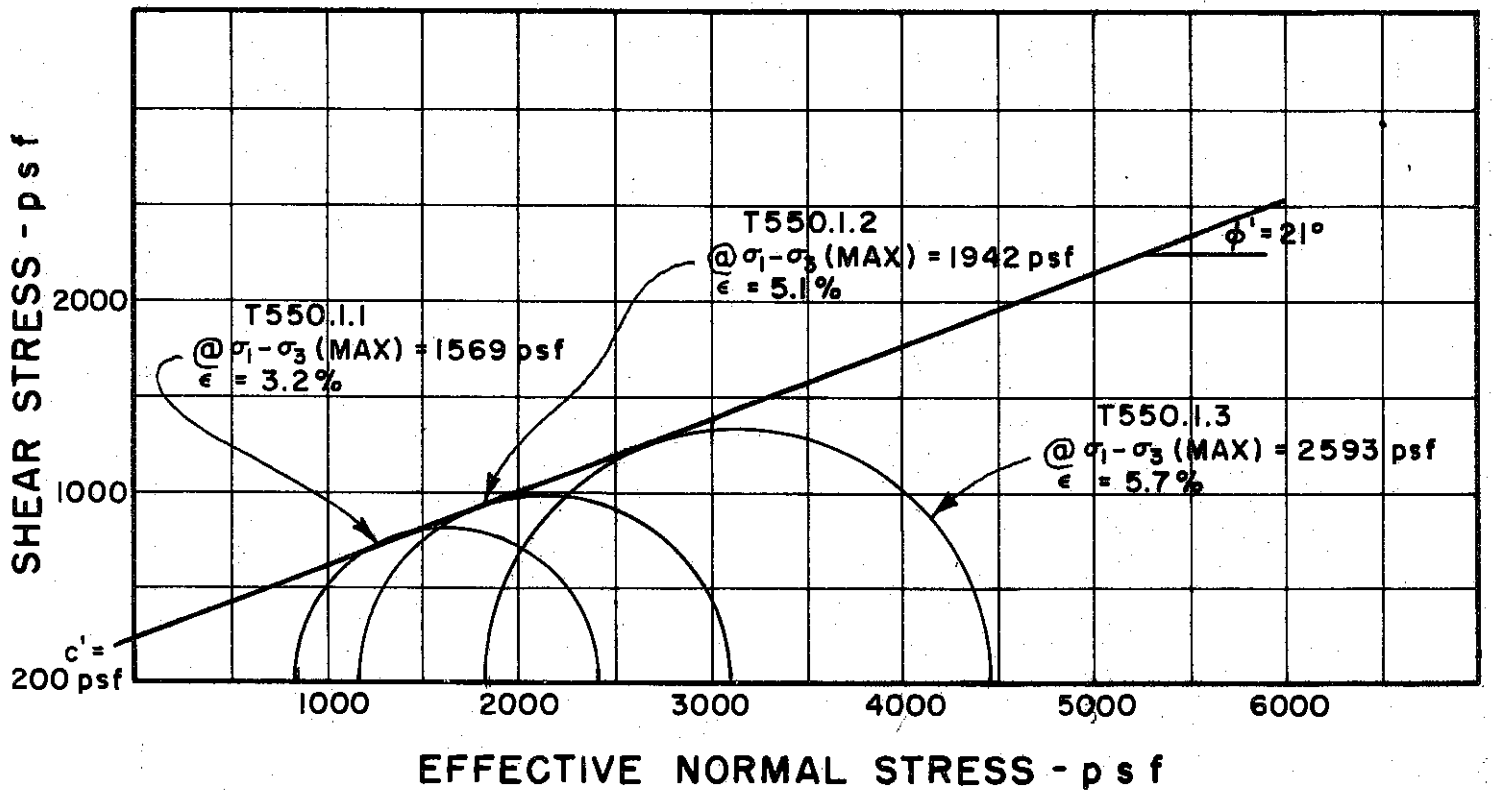
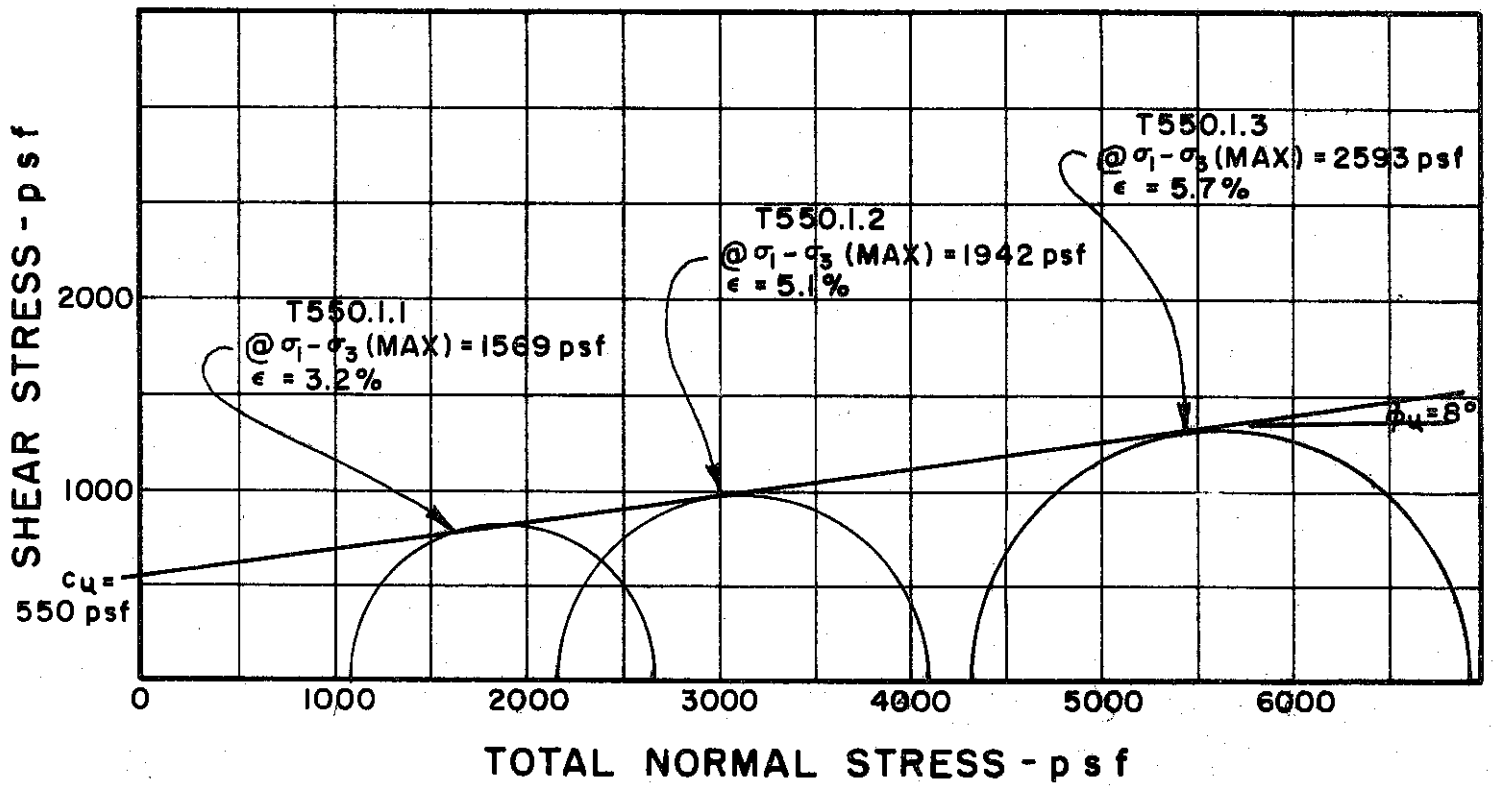

BORING NO. 158

SAMPLE NO. 4

DEPTH 17.5' TO 20.0'

REMARKS ENVELOPE IS INTERPRETIVE,
BASED ON LIMITED DATA POINTS
AVAILABLE

GOLDBERG-ZOINO AND ASSOCIATES, INC.
 CONSULTANTS IN GEOTECHNICAL ENGINEERING

MOHR STRENGTH ENVELOPE
 TRIAXIAL COMPRESSION
 TESTS

THE DETROIT EDISON COMPANY
 BELLE RIVER PLANT UNITS I & II

FILE 1255

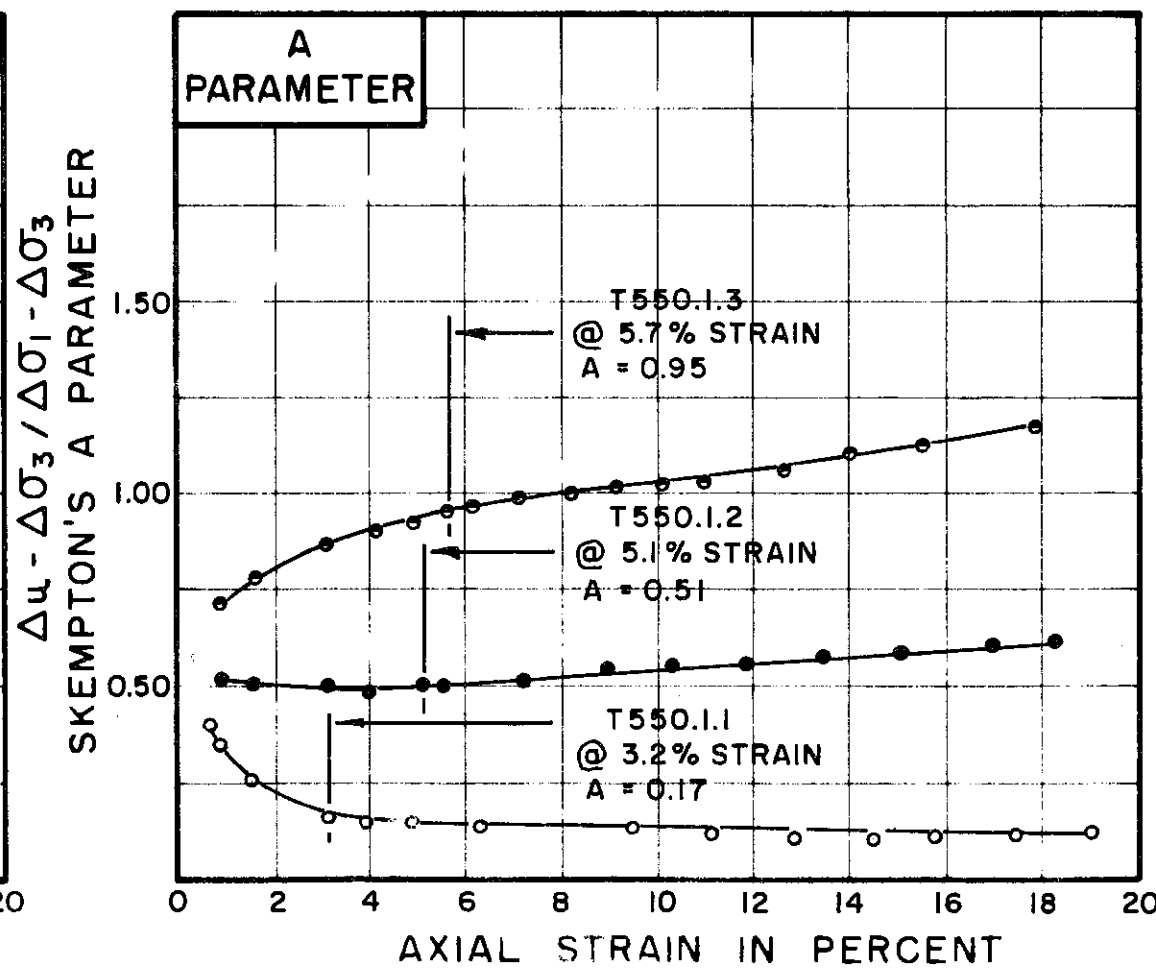
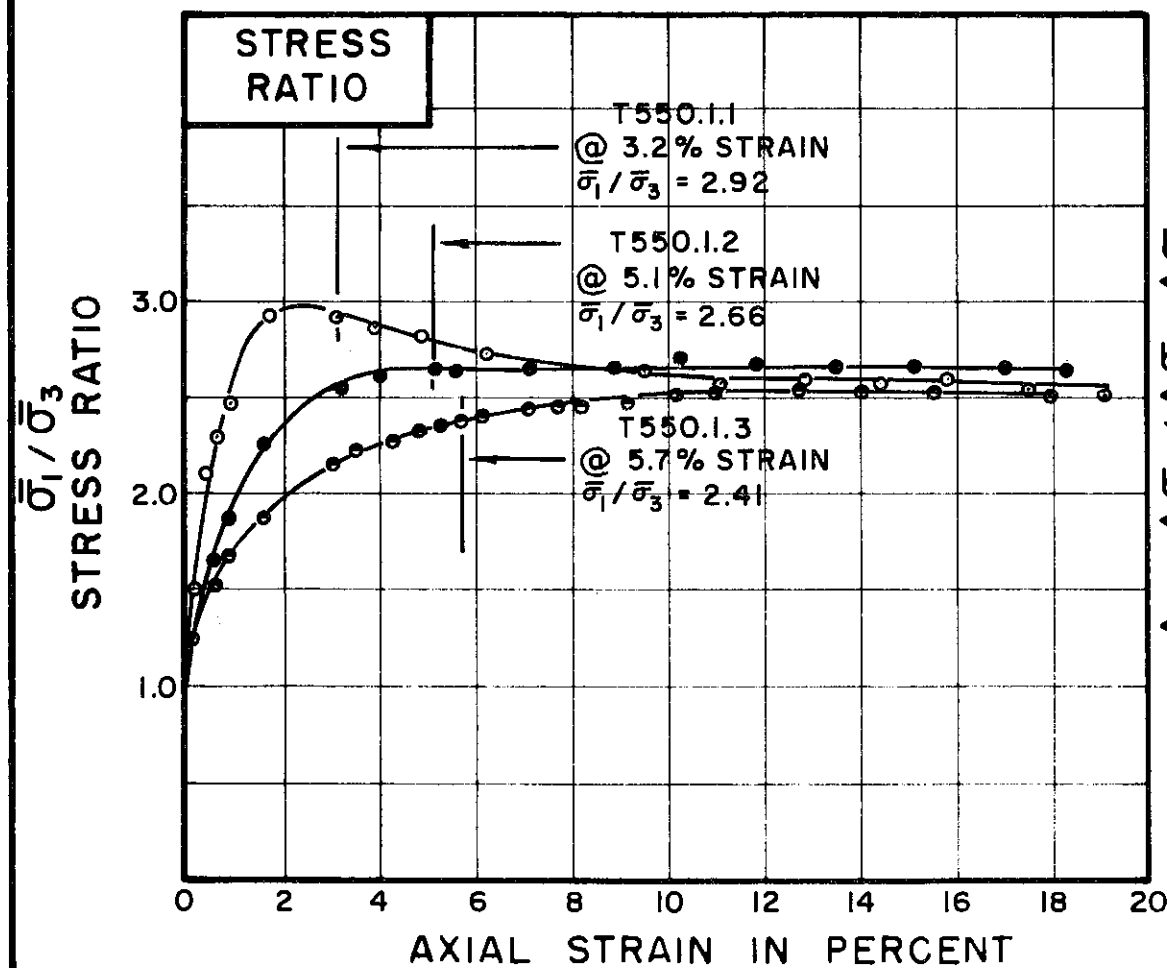
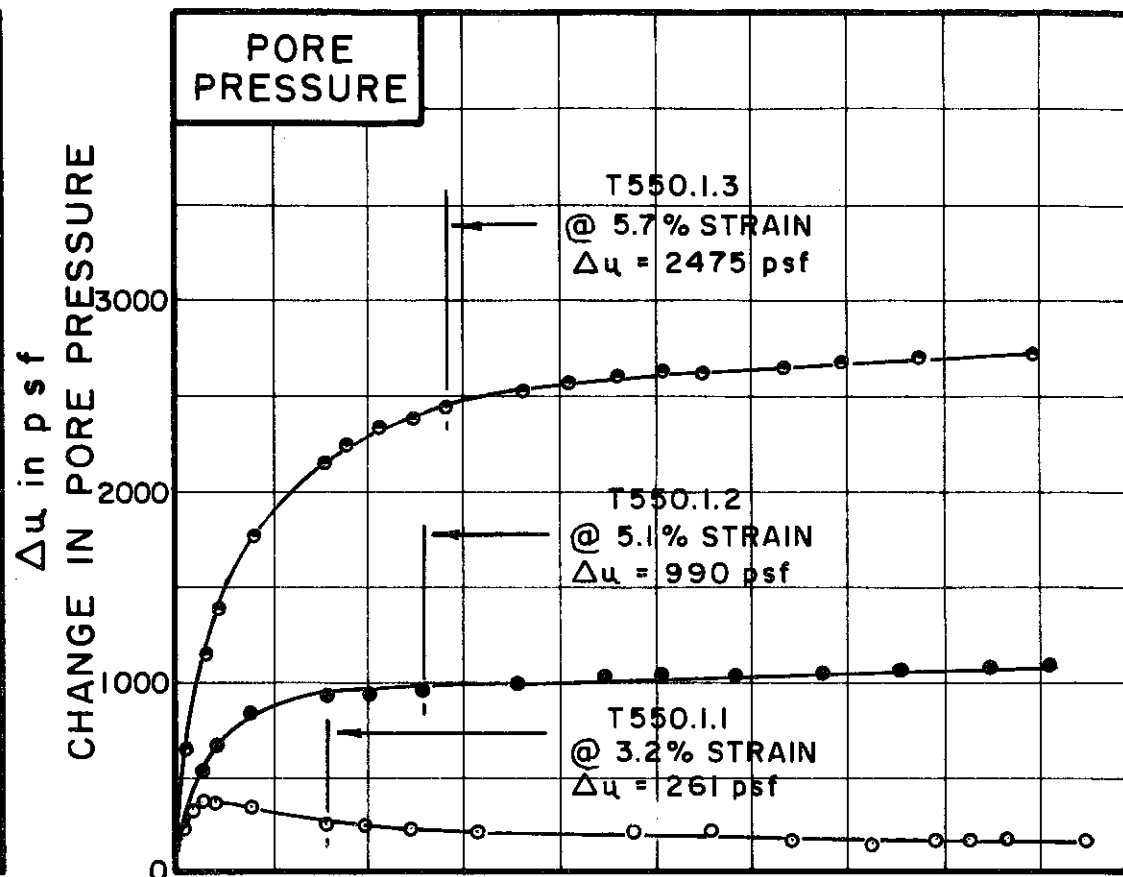
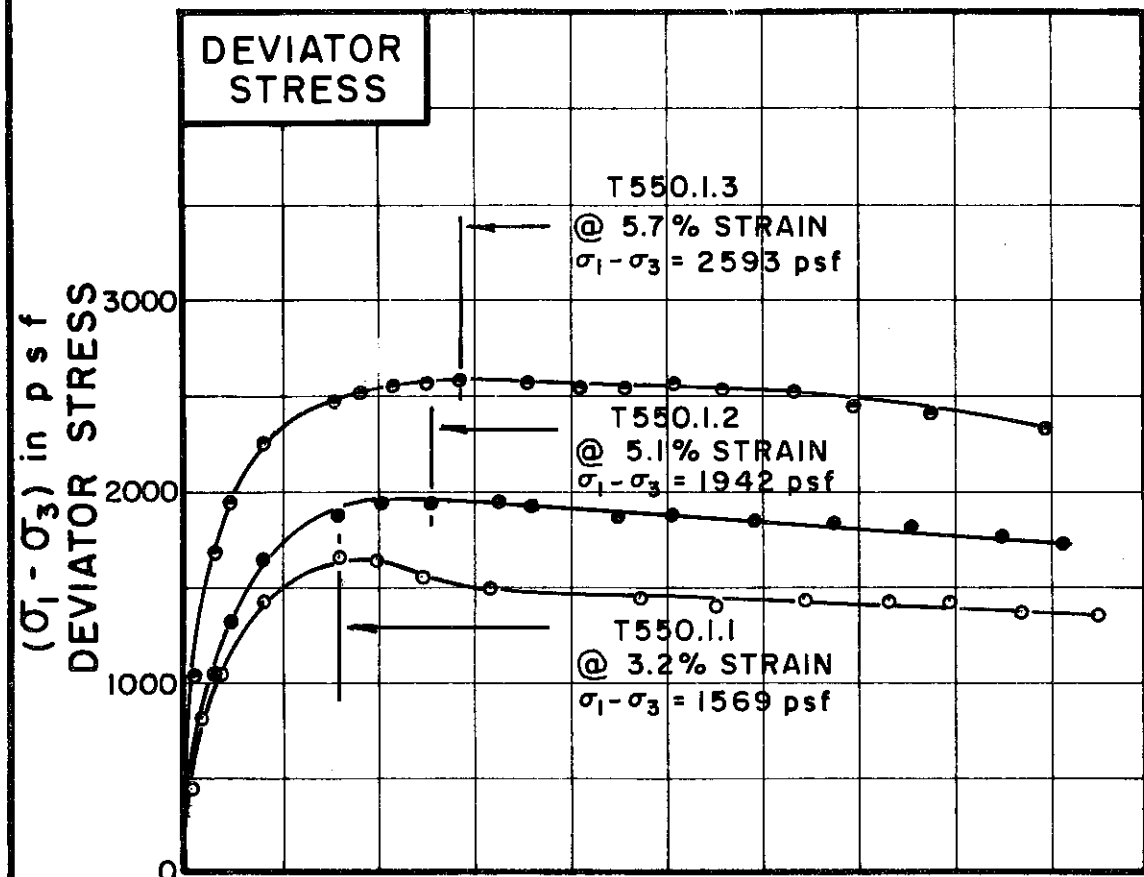

TEST NO. / SYMBOL	T550.1.1	T550.1.2	T550.1.3
	○	●	●

INITIAL CONDITIONS			T550.1.1	T550.1.2	T550.1.3
WATER CONTENT	w ₀		37.5%	33.5%	37.1%
DRY DENSITY	γ _d	lb/cu ft	83	87	83
SAMPLE DIAMETER	D ₀	in.	1.40	1.40	1.40
SAMPLE HEIGHT	H ₀	in.	3.16	3.18	3.19
FINAL CONDITIONS BEFORE SHEAR			T550.1.1	T550.1.2	T550.1.3
FINAL BACK PRESSURE	u ₀	psf	8640	10080	15840
INITIAL EFFECTIVE STRESS	σ̄ ₁ / σ̄ ₃	psf	1080	2160	4320
VOLUMETRIC STRAIN	ε _{vol}		1.4%	2.4%	4.2%
PORE PRESSURE RESPONSE			95%	95%	96%
FINAL CONDITIONS			T550.1.1	T550.1.2	T550.1.3
WATER CONTENT	w _f		37.4%	32.2%	33.4%
SKETCH OF SAMPLE AT END OF TEST					

RATE OF STRAIN PERCENT/MINUTE	.025	.025	.008
-------------------------------	------	------	------

BORING NO. 158
 SAMPLE NO. 4
 DEPTH 17.5' TO 20.0'
 SOIL DESCRIPTION SILTY CLAY (CL)
 LIQUID LIMIT 46 PLASTIC LIMIT 19

CONSOLIDATED UNDRAINED
 TRIAXIAL COMPRESSION
 TESTS
 THE DETROIT EDISON COMPANY
 BELLE RIVER PLANT UNITS I & II

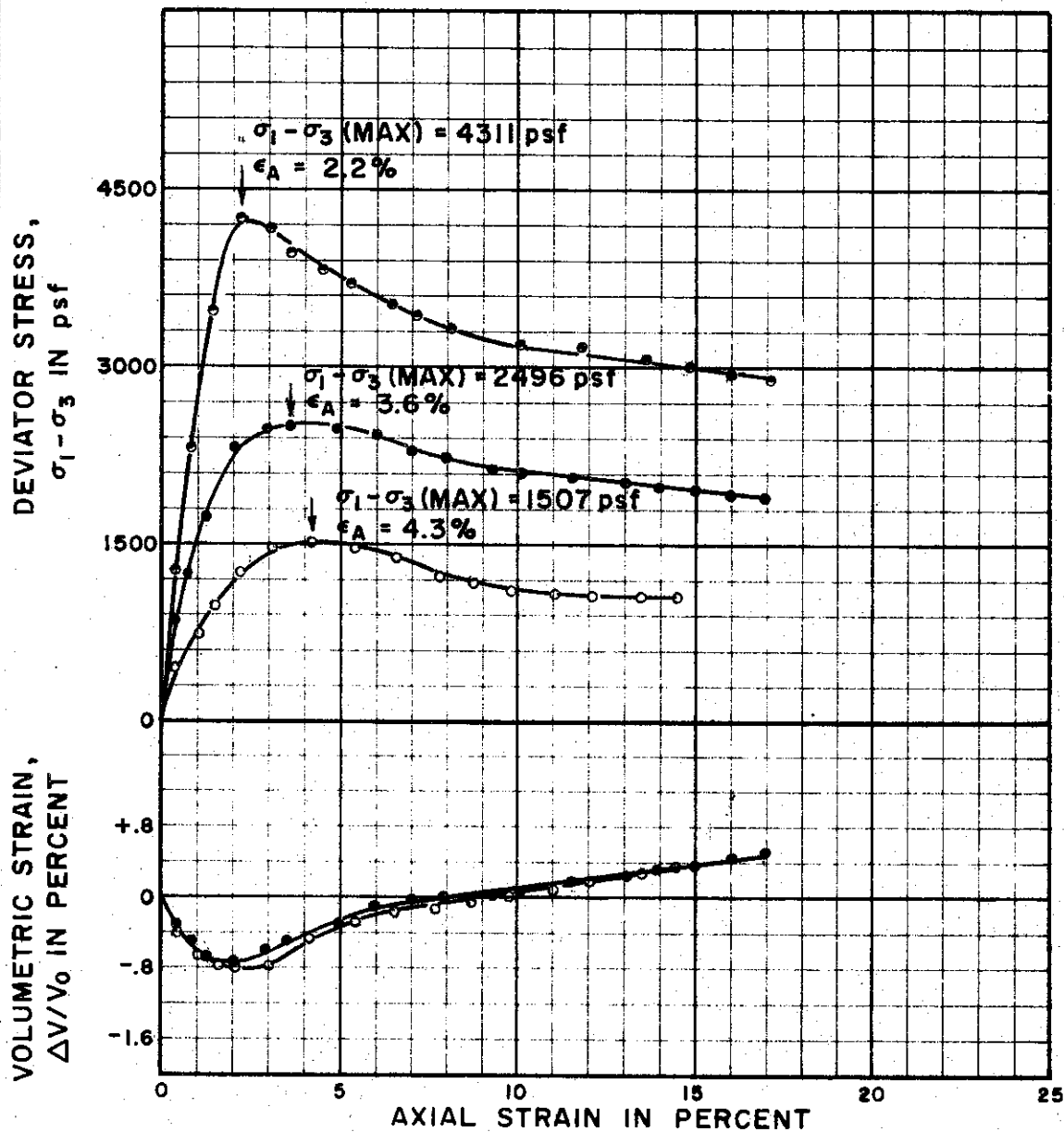

SKETCHES AT FAILURE



TEST NO. 253.23



TEST NO. 253.22



TEST NO. 253.21

TEST NO./SYMBOL		253.21	253.22	253.23
INITIAL CONDITIONS	INITIAL WATER CONTENT %	w_0 23.0	23.3	24.2
	INITIAL UNIT WEIGHT pcf	γ_d 107	105	103
	SAMPLE HEIGHT & DIAMETER in	D_0 1.39	1.39	1.41
		H_0 3.51	3.46	3.43
CONDITIONS BEFORE SHEAR	INITIAL EFFECTIVE STRESS psf	$\sigma_1 = \sigma_3$ 576	1152	2304
	FINAL BACK PRESSURE psf	u_0 7776	8352	7776
	VOLUMETRIC STRAIN %	ϵ_{vol} .94	1.28	2.74
	PORE PRESSURE RESPONSE %	99	97	96
	FINAL CONDITIONS	FINAL WATER CONTENT %	w_f 26.8	26.1
	FINAL UNIT WEIGHT pcf	γ_d 107	106	-
RATE OF STRAIN PERCENT PER MINUTE		.002	.002	.002

BORING NO. 118

SAMPLE NO. 2

DEPTH 8.2' TO 9.2'

SOIL DESCRIPTION SILTY CLAY
(CL-CH)

LIQUID LIMIT 49 PLASTIC LIMIT 23

CONSOLIDATED DRAINED TRIAXIAL COMPRESSION TESTS

THE DETROIT EDISON COMPANY
BELLE RIVER PLANT UNITS I & II

FILE 1255

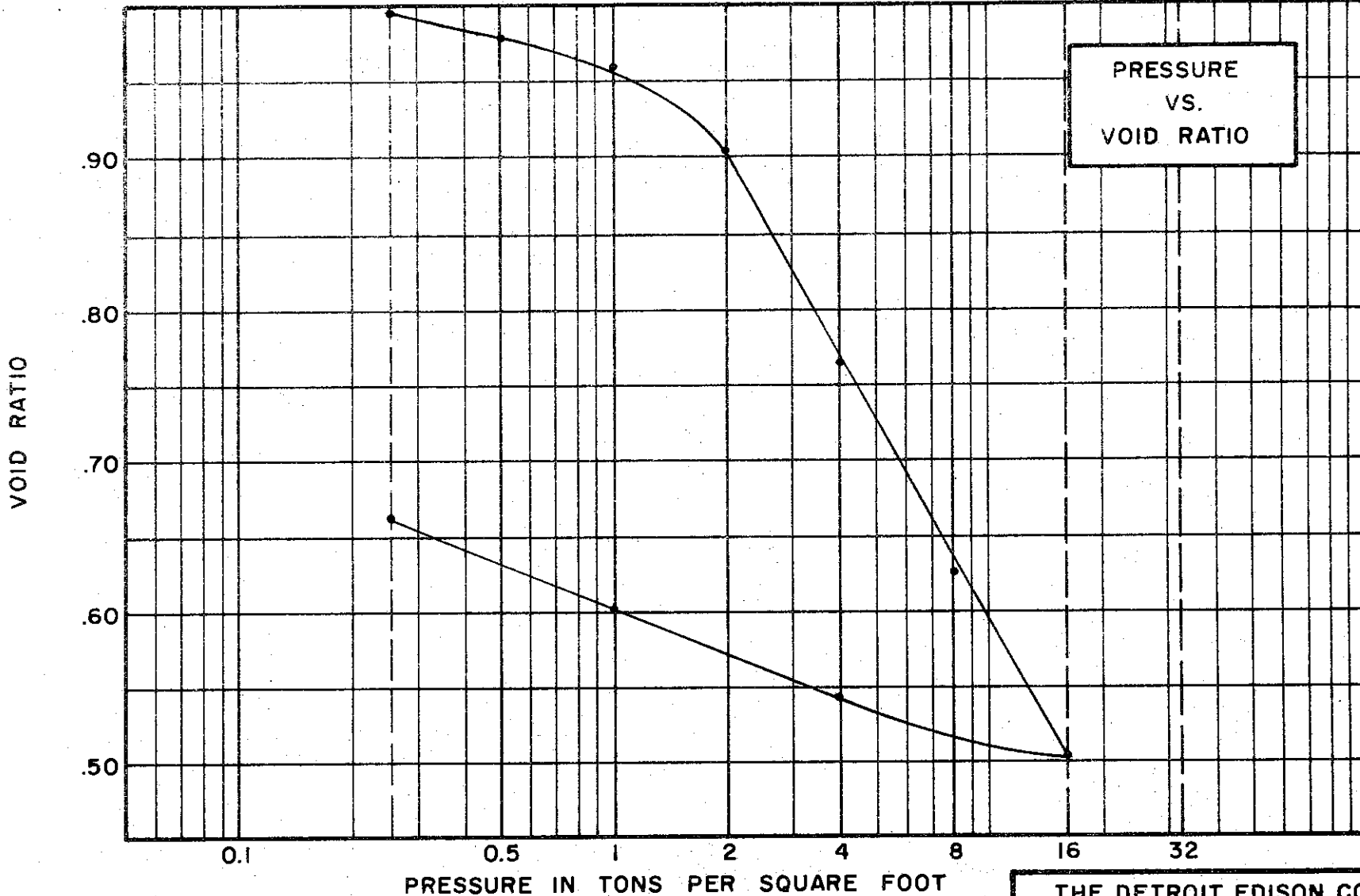

SOIL PROPERTIES

SOIL DESCRIPTION SILTY CLAY (CL)
 SPECIFIC GRAVITY 2.73
 WATER CONTENT, INITIAL 38.6% FINAL 27.9%
 ATTERBERG LIMITS:
 LIQUID LIMIT 41% PLASTIC LIMIT 22%

TEST DATA

INITIAL SAMPLE HEIGHT 0.80"
 INITIAL SAMPLE DIAMETER 2.50"
 INITIAL VOID RATIO 1.016

THE DETROIT EDISON COMPANY
 BELLE RIVER PLANT UNITS I & II

CONSOLIDATION TEST
 VOID RATIO VS. LOG PRESSURE

BORING NO. 27 TEST NO. C306.1
 SAMPLE NO. 10 DATE APRIL 74
 DEPTH 34.0' TO 34.3'

C-455

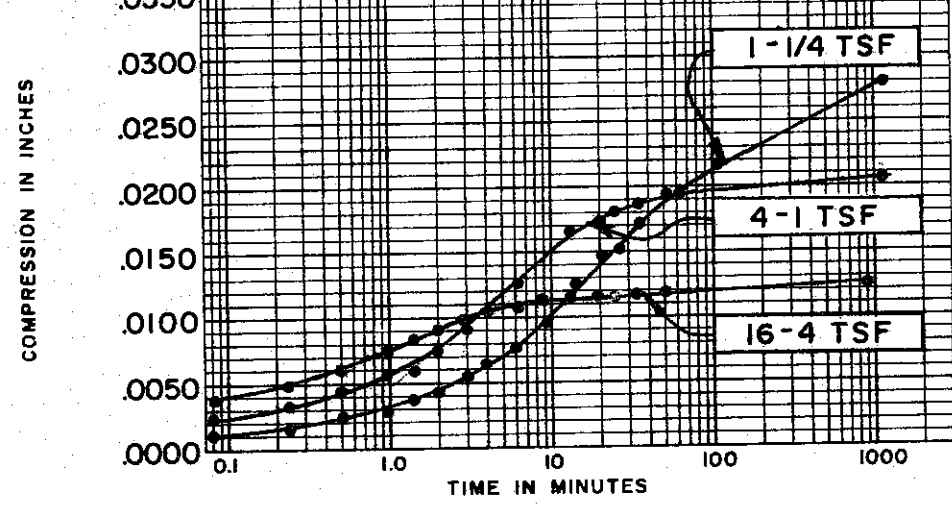
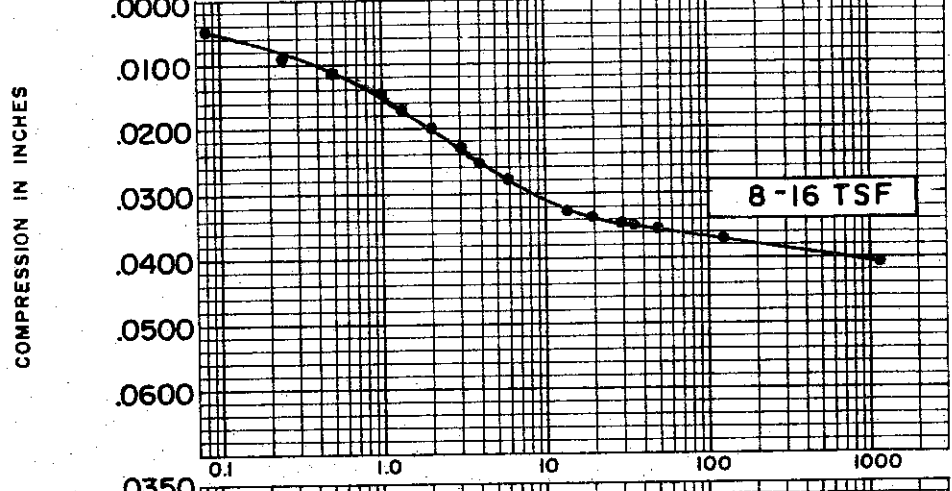
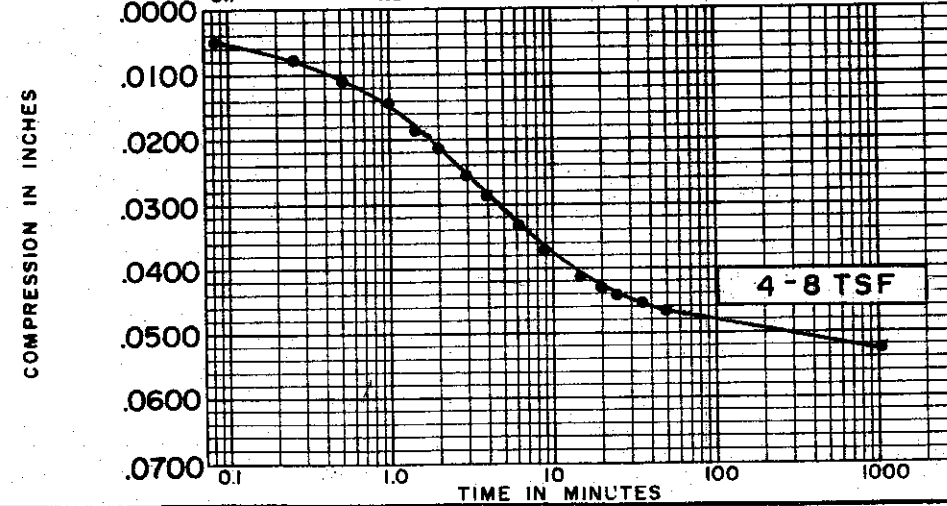
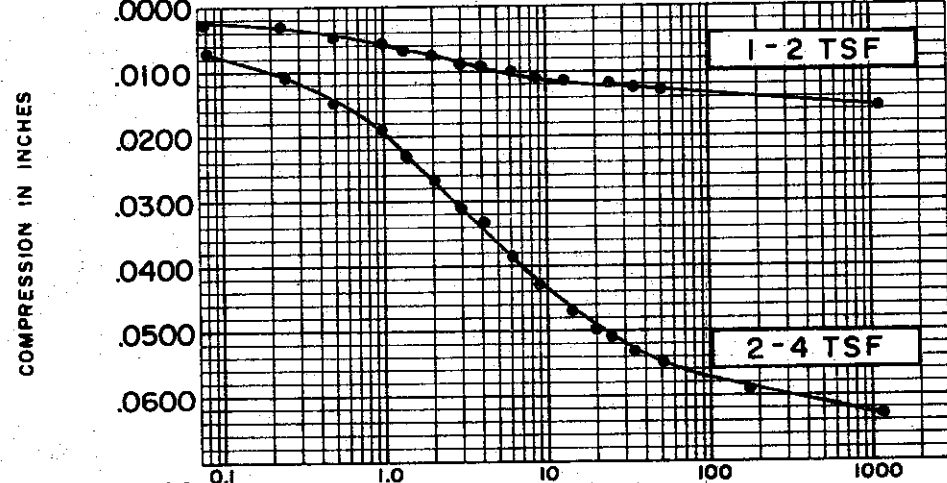
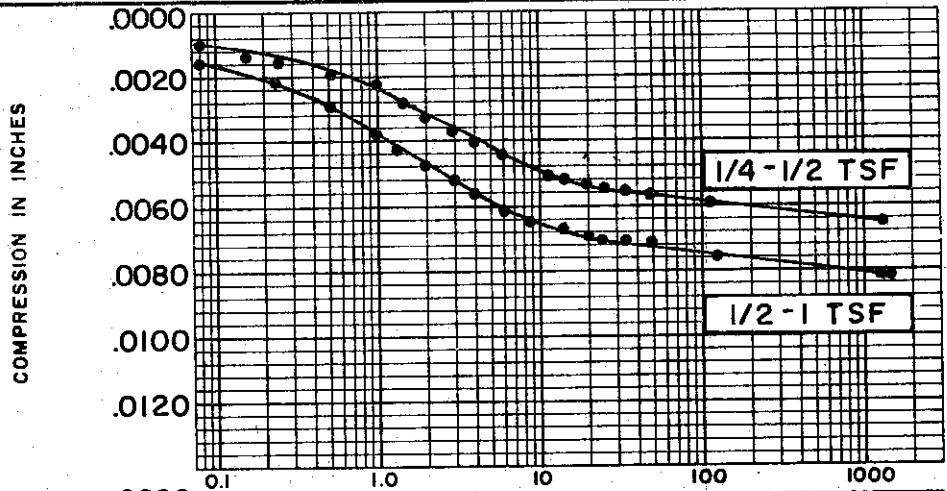

SOIL PROPERTIES

SOIL DESCRIPTION: SILTY
CLAY (CL)
SPECIFIC GRAVITY 2.73
INITIAL WATER CONTENT 38.6%
FINAL WATER CONTENT 27.9%

BORING NO. 27
SAMPLE NO. 10
DEPTH 34.0' TO 34.3'

TEST DATA

INITIAL SAMPLE HEIGHT 0.80"
INITIAL SAMPLE DIAMETER 2.50"
INITIAL VOID RATIO 1.016

**CONSOLIDATION TEST
TIME VS. COMPRESSION CURVES**

THE DETROIT EDISON COMPANY
BELLE RIVER PLANT UNITS I & II

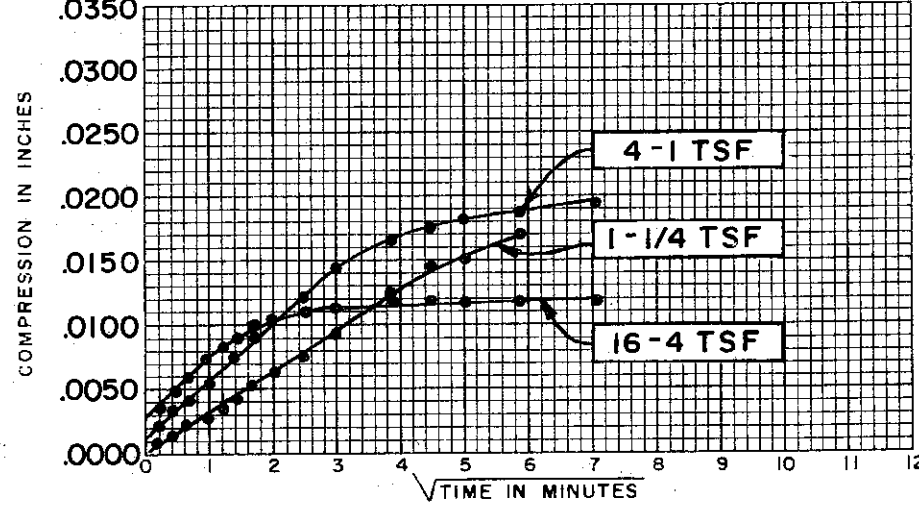
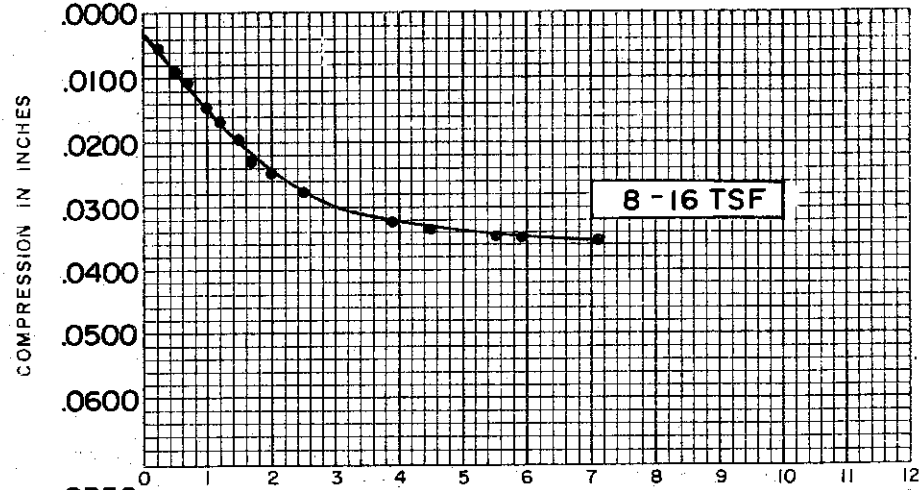
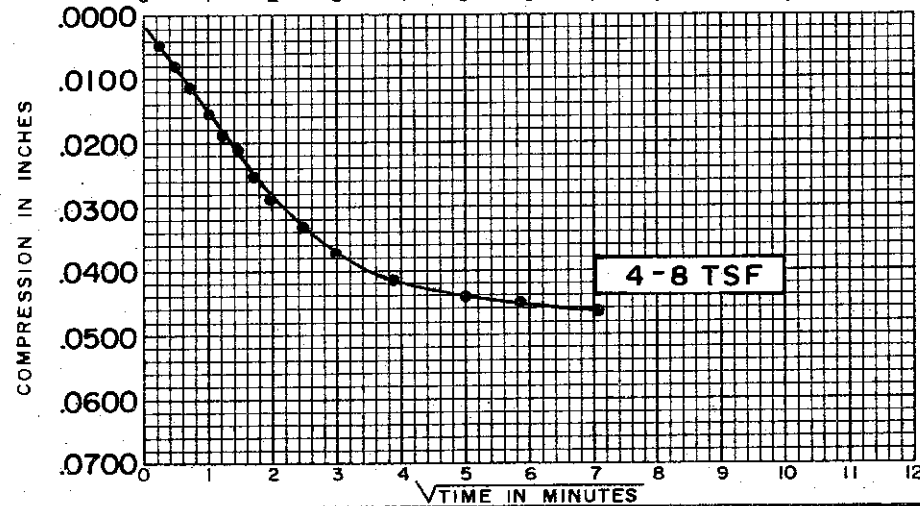
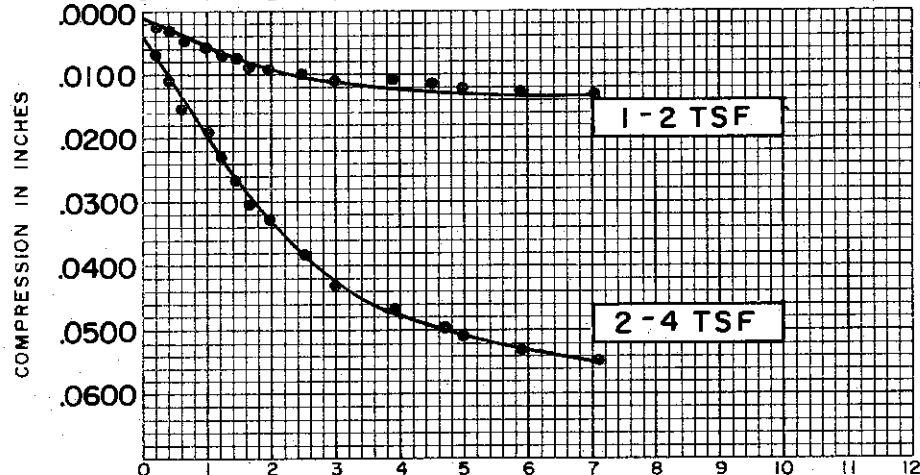
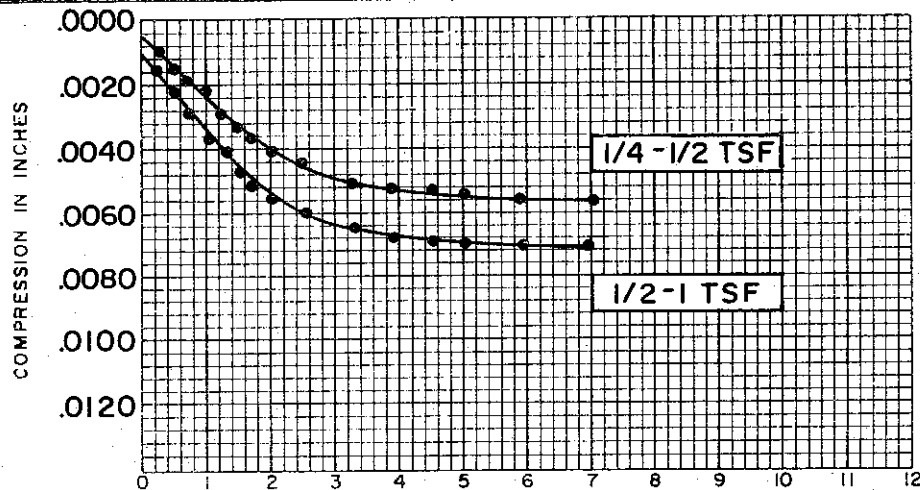

SOIL PROPERTIES	
SOIL DESCRIPTION:	SILTY CLAY (CL)
SPECIFIC GRAVITY	2.73
INITIAL WATER CONTENT	38.6%
FINAL WATER CONTENT	27.9%

BORING NO. 27
 SAMPLE NO. 10
 DEPTH 34.0' TO 34.3'

TEST DATA	
INITIAL SAMPLE HEIGHT	0.80"
INITIAL SAMPLE DIAMETER	2.50"
INITIAL VOID RATIO	1.016

**CONSOLIDATION TEST
 TIME VS. COMPRESSION CURVES**

THE DETROIT EDISON COMPANY
 BELLE RIVER PLANT UNITS I & II

C-457

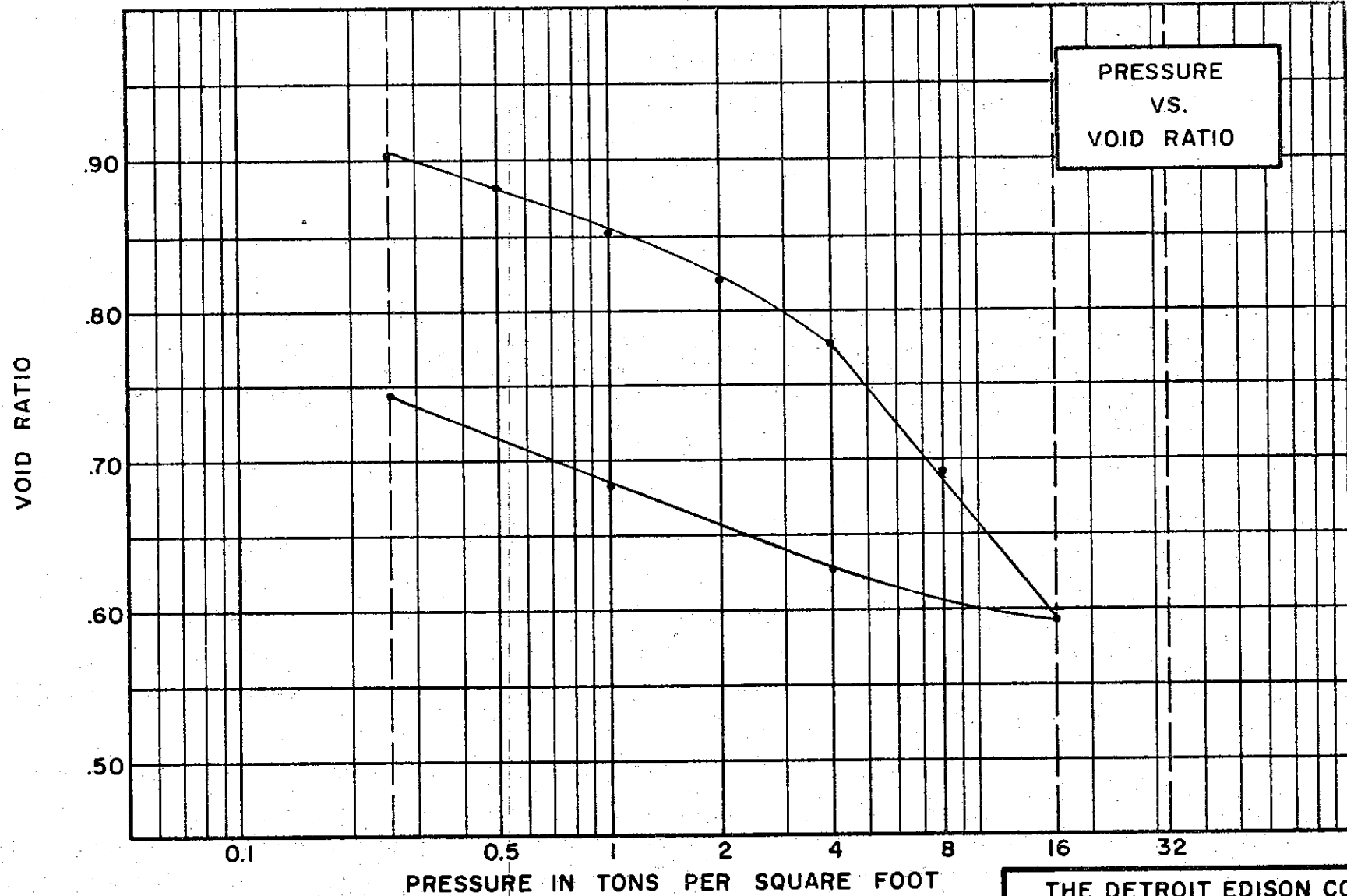

SOIL PROPERTIES

SOIL DESCRIPTION SILTY
CLAY; SANDY (CL)
 SPECIFIC GRAVITY 2.74
 WATER CONTENT, INITIAL 33% FINAL 30%
 ATTERBERG LIMITS:
 LIQUID LIMIT 43 % PLASTIC LIMIT 25 %

TEST DATA

INITIAL SAMPLE HEIGHT 0.75"
 INITIAL SAMPLE DIAMETER 2.50"
 INITIAL VOID RATIO 0.910

THE DETROIT EDISON COMPANY
 BELLE RIVER PLANT UNITS I & II

CONSOLIDATION TEST
VOID RATIO VS. LOG PRESSURE

BORING NO. 27 TEST NO. C313.1
 SAMPLE NO. 24 DATE APRIL 74
 DEPTH 104.2' TO 104.5'

COMPRESSION IN INCHES

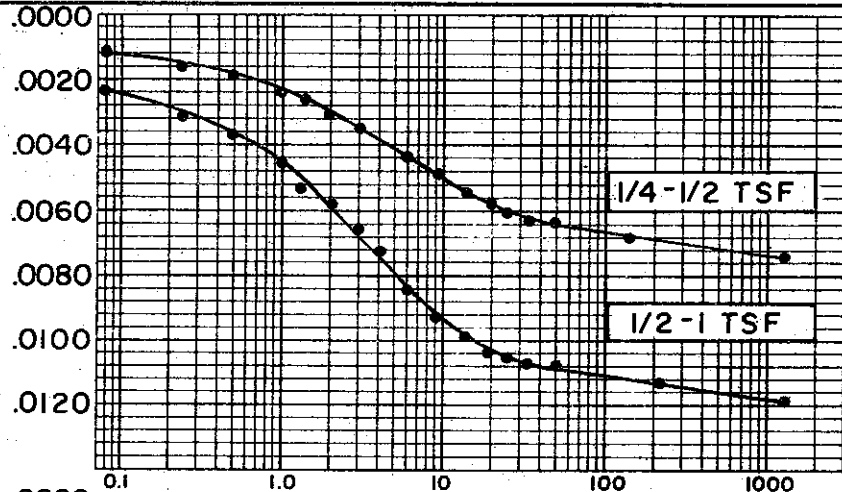

COMPRESSION IN INCHES

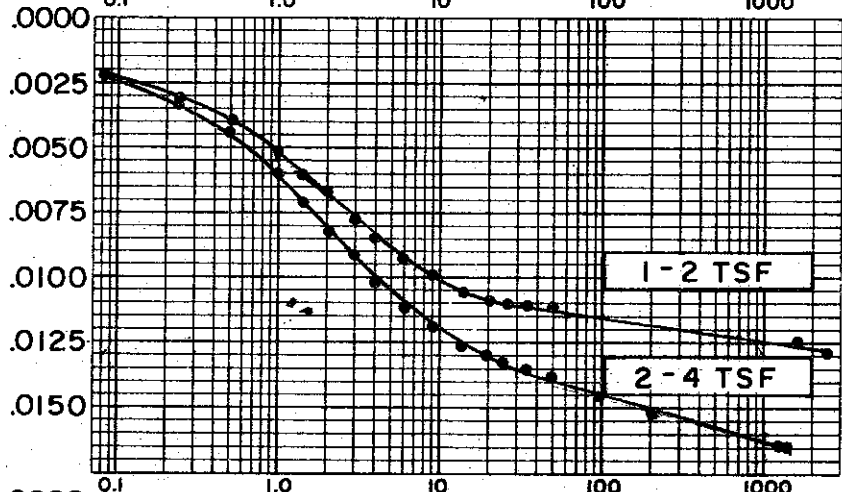

COMPRESSION IN INCHES

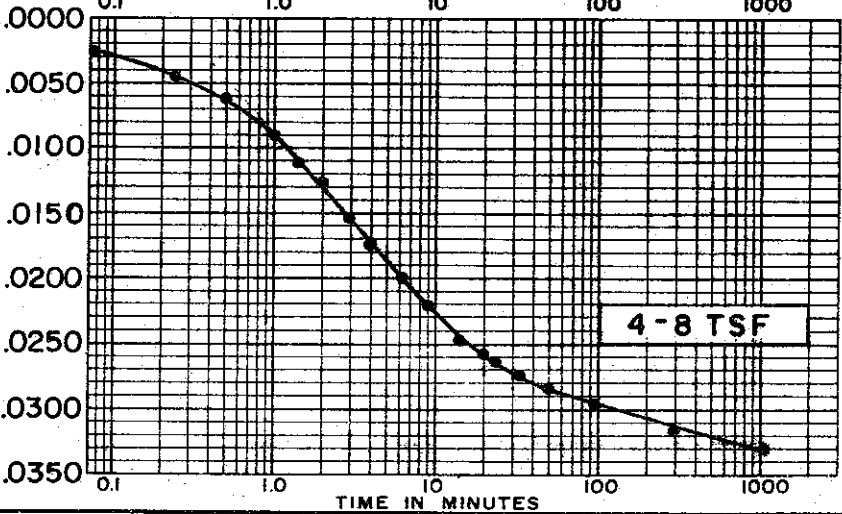

COMPRESSION IN INCHES

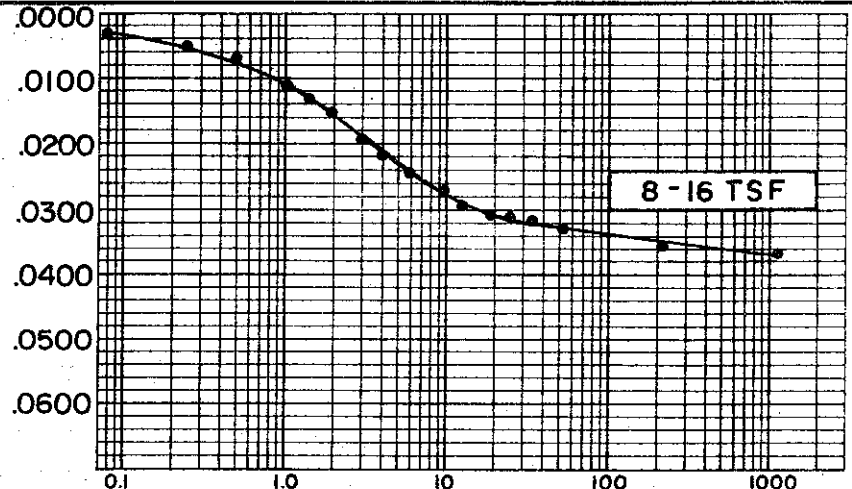

COMPRESSION IN INCHES

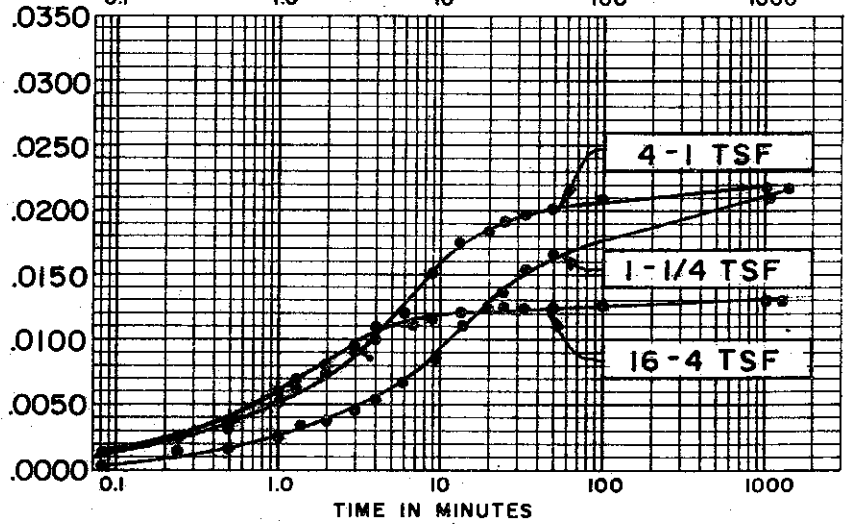

SOIL PROPERTIES

SOIL DESCRIPTION: SILTY CLAY; SANDY (CL)
 SPECIFIC GRAVITY 2.74
 INITIAL WATER CONTENT 33.9%
 FINAL WATER CONTENT 30.0%

BORING NO. 27
 SAMPLE NO. 24
 DEPTH 104.2' TO 104.5'

TEST DATA

INITIAL SAMPLE HEIGHT 0.75"
 INITIAL SAMPLE DIAMETER 2.50"
 INITIAL VOID RATIO 0.910

**CONSOLIDATION TEST
TIME VS. COMPRESSION CURVE**

THE DETROIT EDISON COMPANY
 BELLE RIVER PLANT UNITS I & II

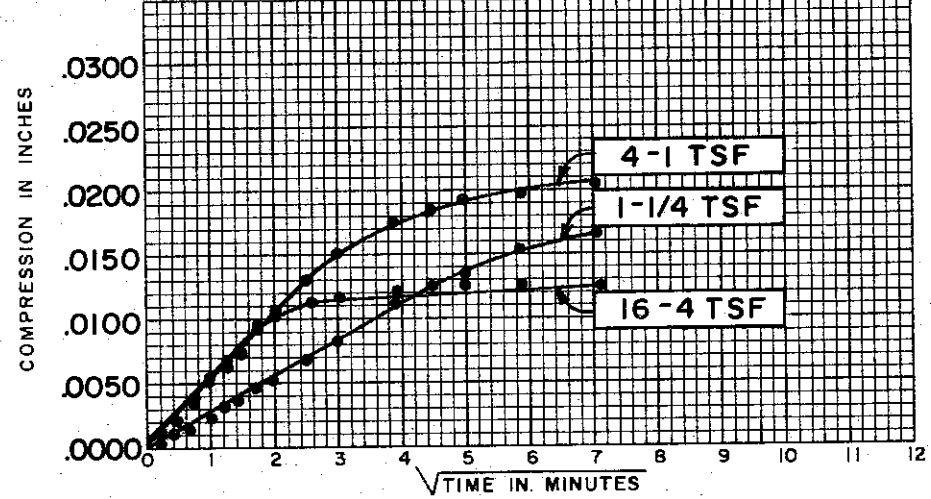
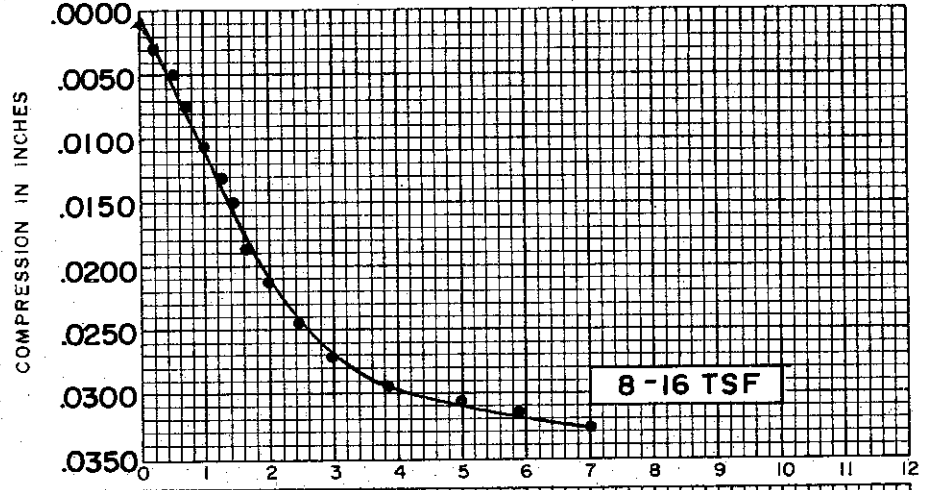
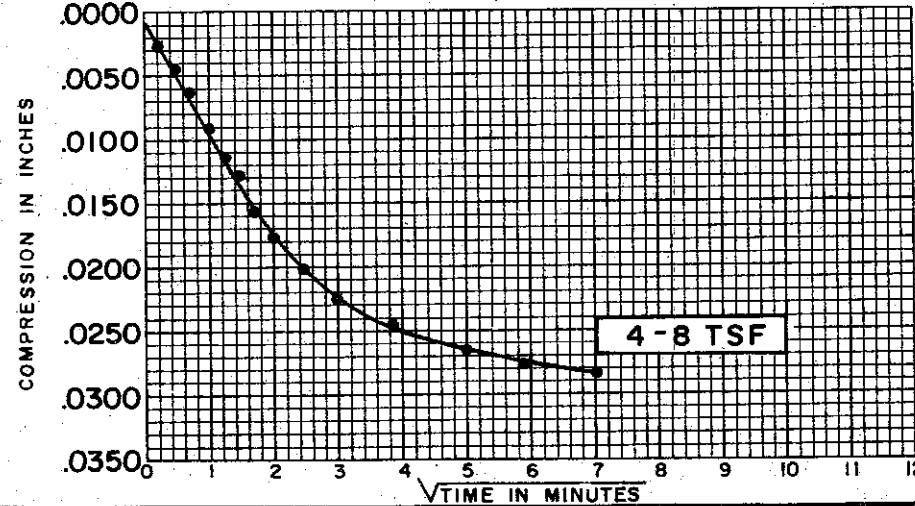
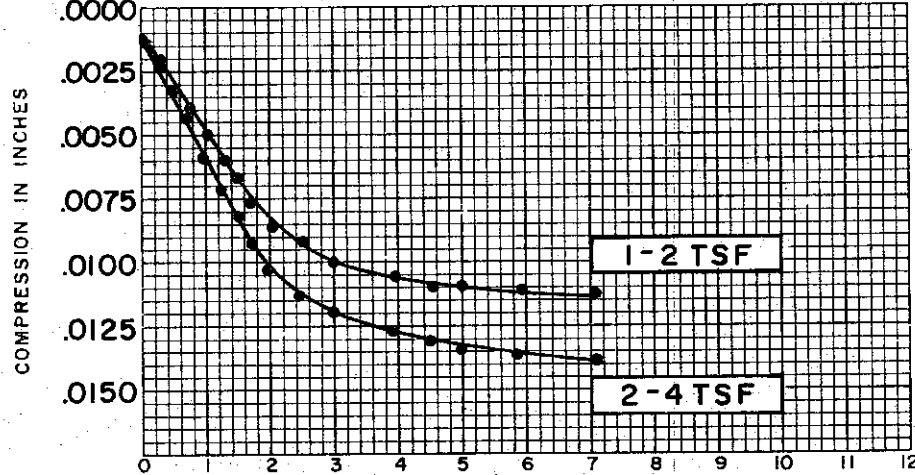
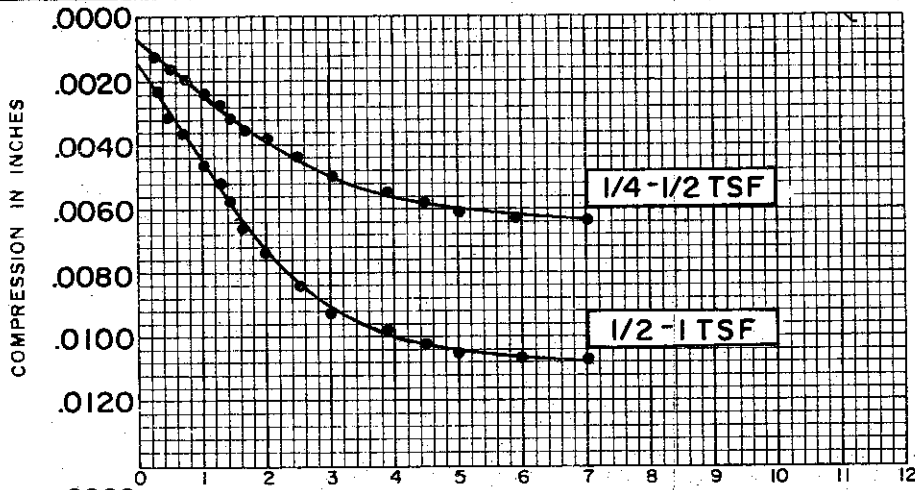

SOIL PROPERTIES	
SOIL DESCRIPTION:	SILTY CLAY; SANDY (CL)
SPECIFIC GRAVITY	2.74
INITIAL WATER CONTENT	33.9%
FINAL WATER CONTENT	30.0%
BORING NO.	27
SAMPLE NO.	24
DEPTH	104.2' TO 104.5'

TEST DATA	
INITIAL SAMPLE HEIGHT	0.75"
INITIAL SAMPLE DIAMETER	2.50"
INITIAL VOID RATIO	0.910

CONSOLIDATION TEST
 TIME VS. COMPRESSION CURVES
 THE DETROIT EDISON COMPANY
 BELLE RIVER PLANT UNITS I & II

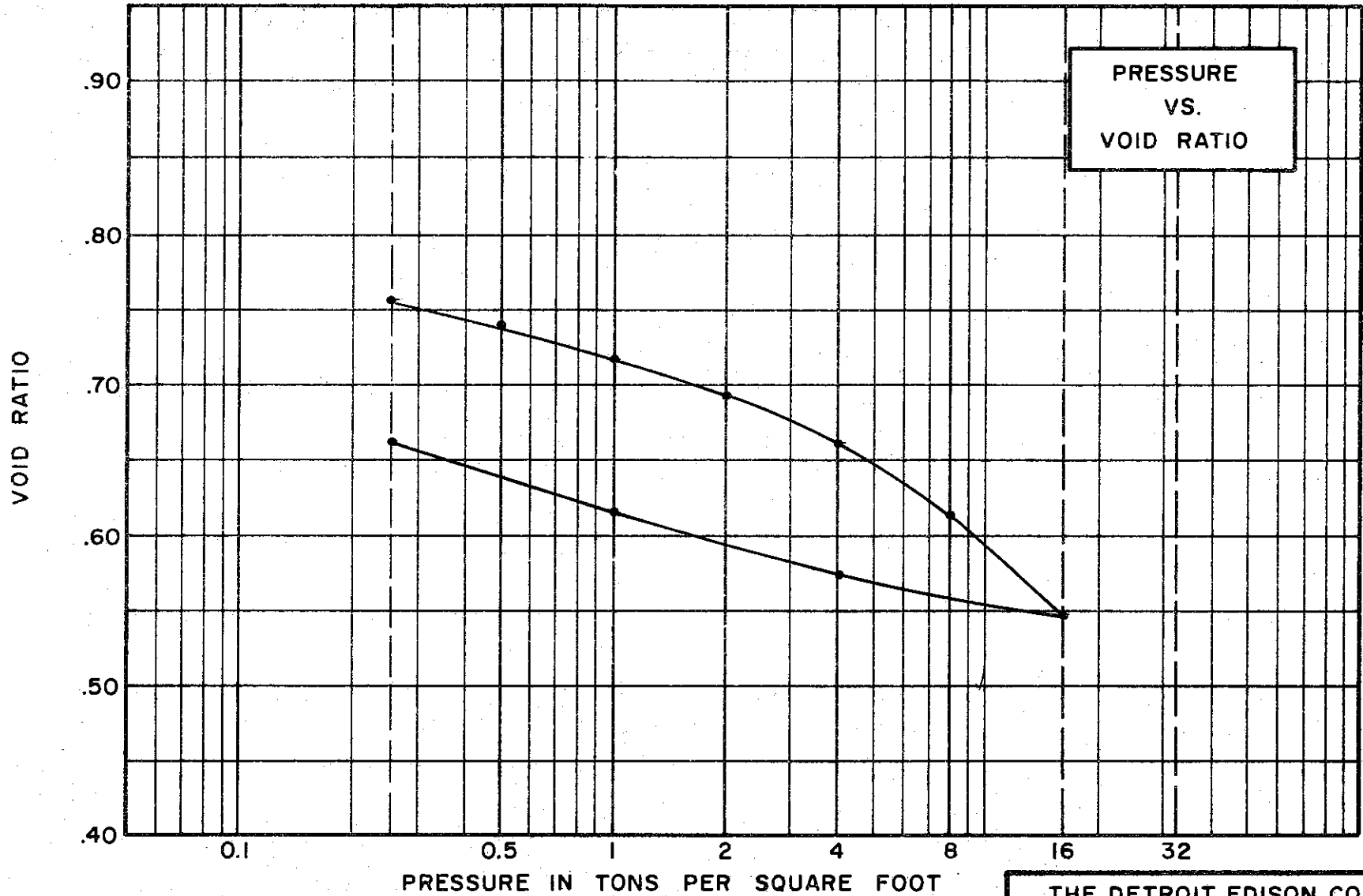

SOIL PROPERTIES

SOIL DESCRIPTION SILTY CLAY (CL-CH)
 SPECIFIC GRAVITY 2.71
 WATER CONTENT, INITIAL 29.0% FINAL 28.0%
 ATTERBERG LIMITS:
 LIQUID LIMIT 46% PLASTIC LIMIT 22%

TEST DATA

INITIAL SAMPLE HEIGHT 0.80"
 INITIAL SAMPLE DIAMETER 2.50"
 INITIAL VOID RATIO 0.770

THE DETROIT EDISON COMPANY
 BELLE RIVER PLANT UNITS I & II

**CONSOLIDATION TEST
 VOID RATIO VS. LOG PRESSURE**

BORING NO. 38 TEST NO. C18.1
 SAMPLE NO. 4 DATE JAN. 1974
 DEPTH 14.6' TO 14.7'

T94-C-461

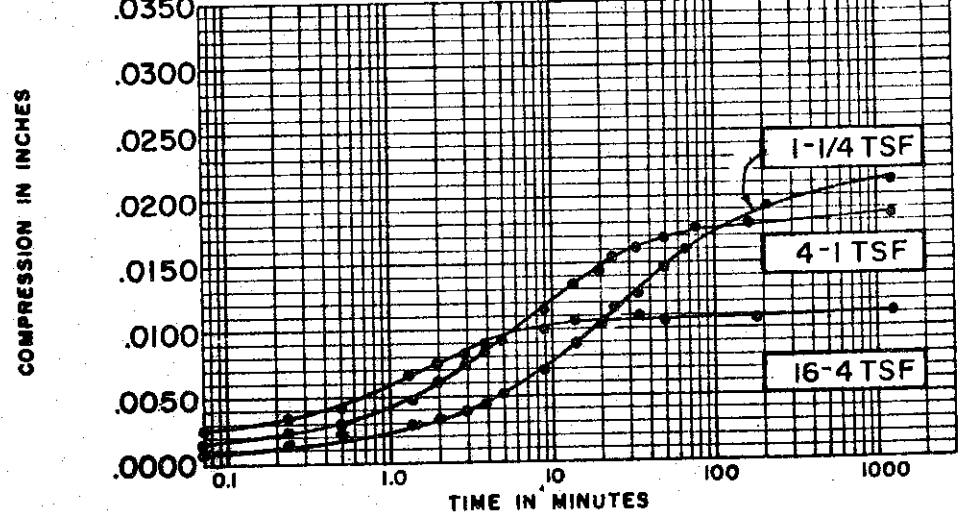
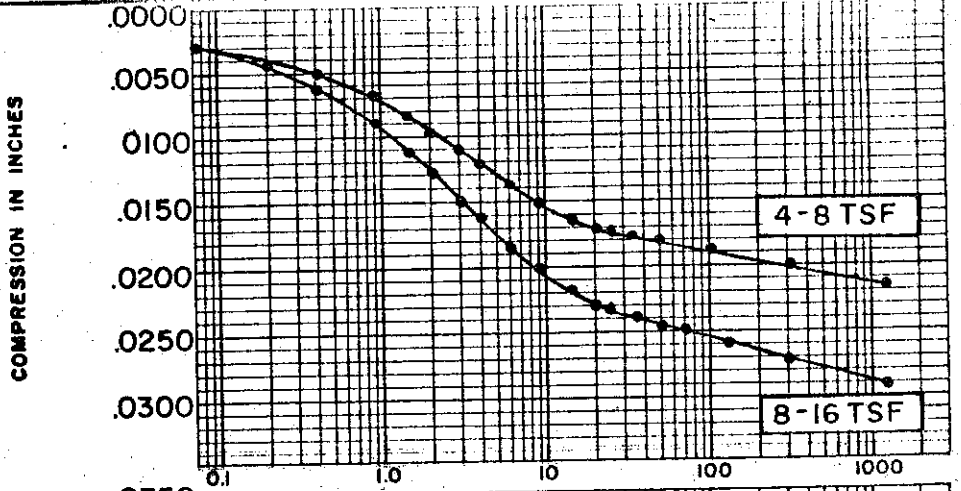
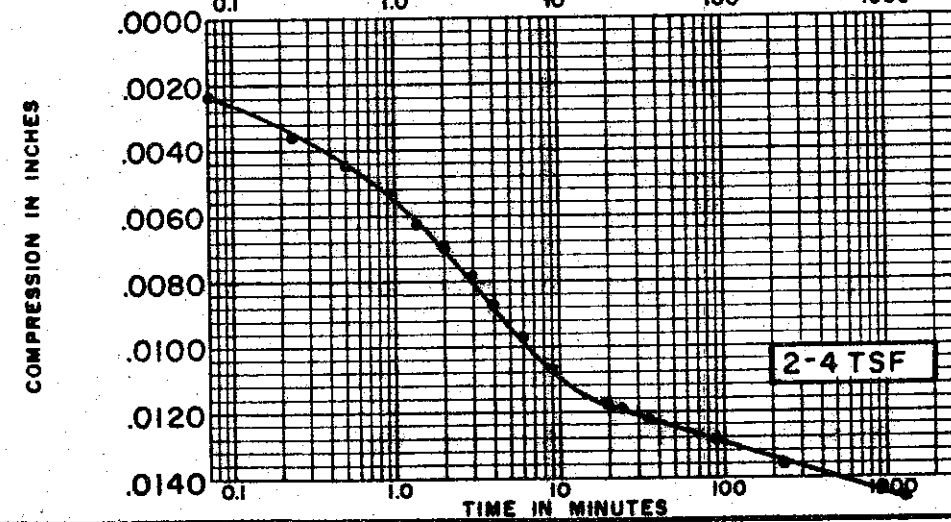
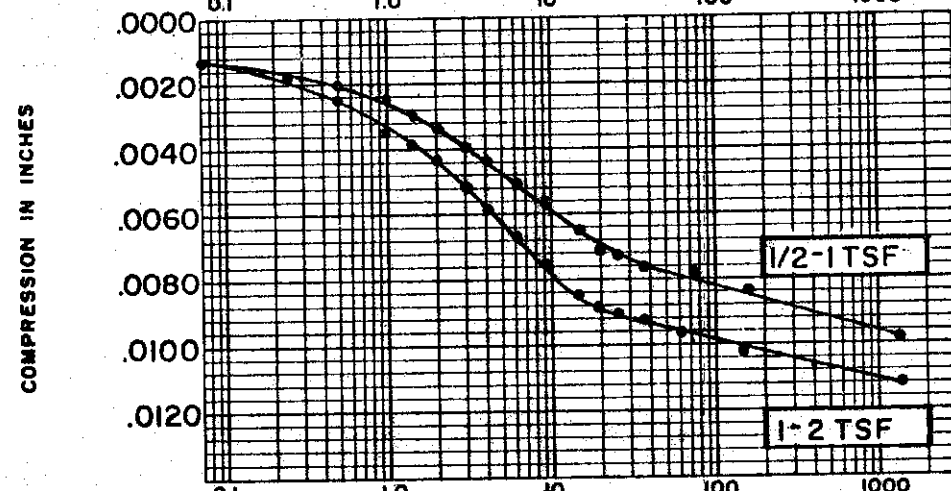
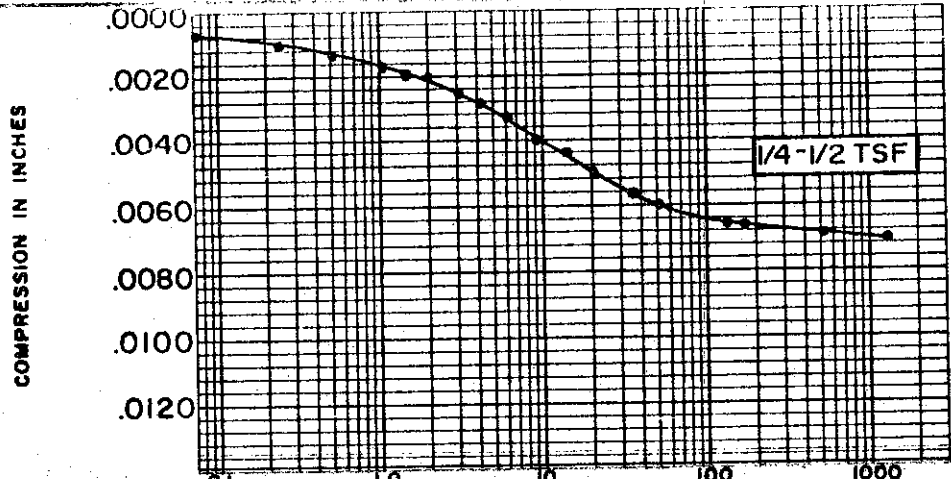

SOIL PROPERTIES		BORING NO. <u>38</u>
SOIL DESCRIPTION: <u>SILTY</u>		SAMPLE NO. <u>4</u>
<u>CLAY (CL-CH)</u>		DEPTH <u>14.6' TO 14.7'</u>
SPECIFIC GRAVITY <u>2.71</u>		
INITIAL WATER CONTENT <u>29.0%</u>		
FINAL WATER CONTENT <u>28.0%</u>		
TEST DATA		
INITIAL SAMPLE HEIGHT <u>0.800"</u>	CONSOLIDATION TEST TIME VS. COMPRESSION CURVE	
INITIAL SAMPLE DIAMETER <u>2.50"</u>		
INITIAL VOID RATIO <u>0.770</u>		
THE DETROIT EDISON COMPANY BELLE RIVER PLANT UNITS I & II		FILE 1255

C-463

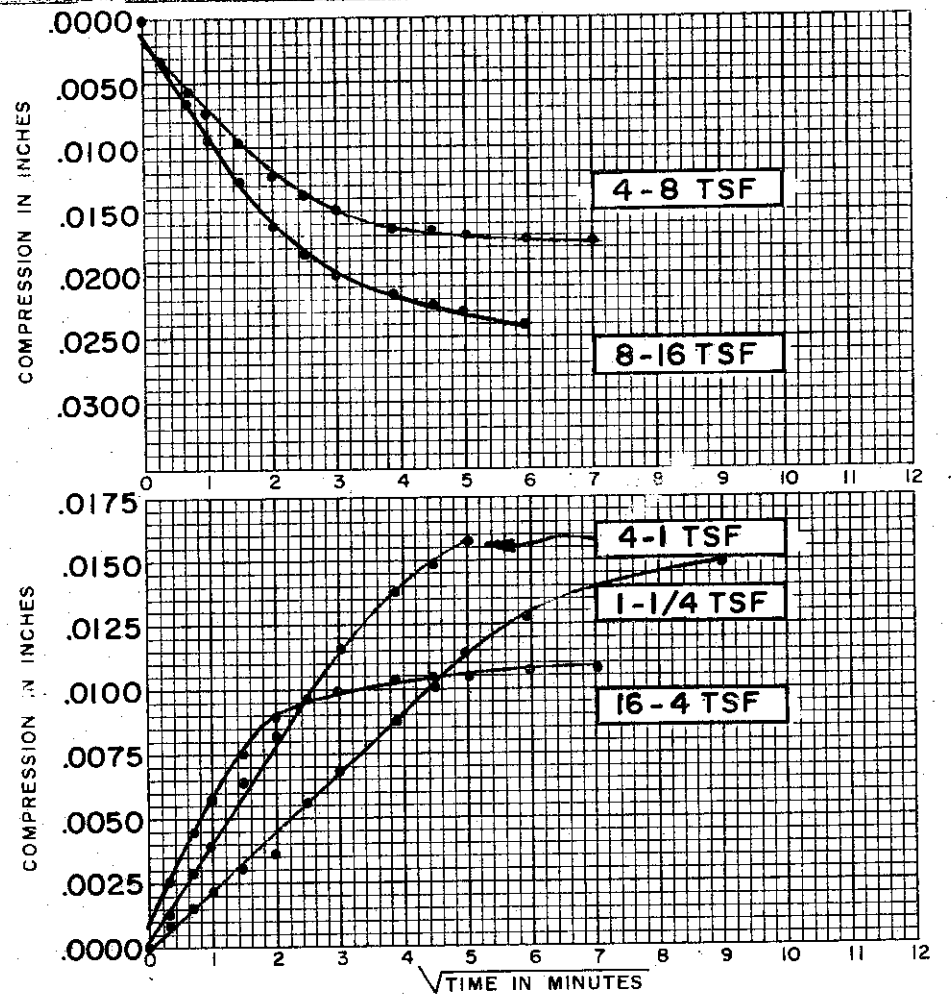
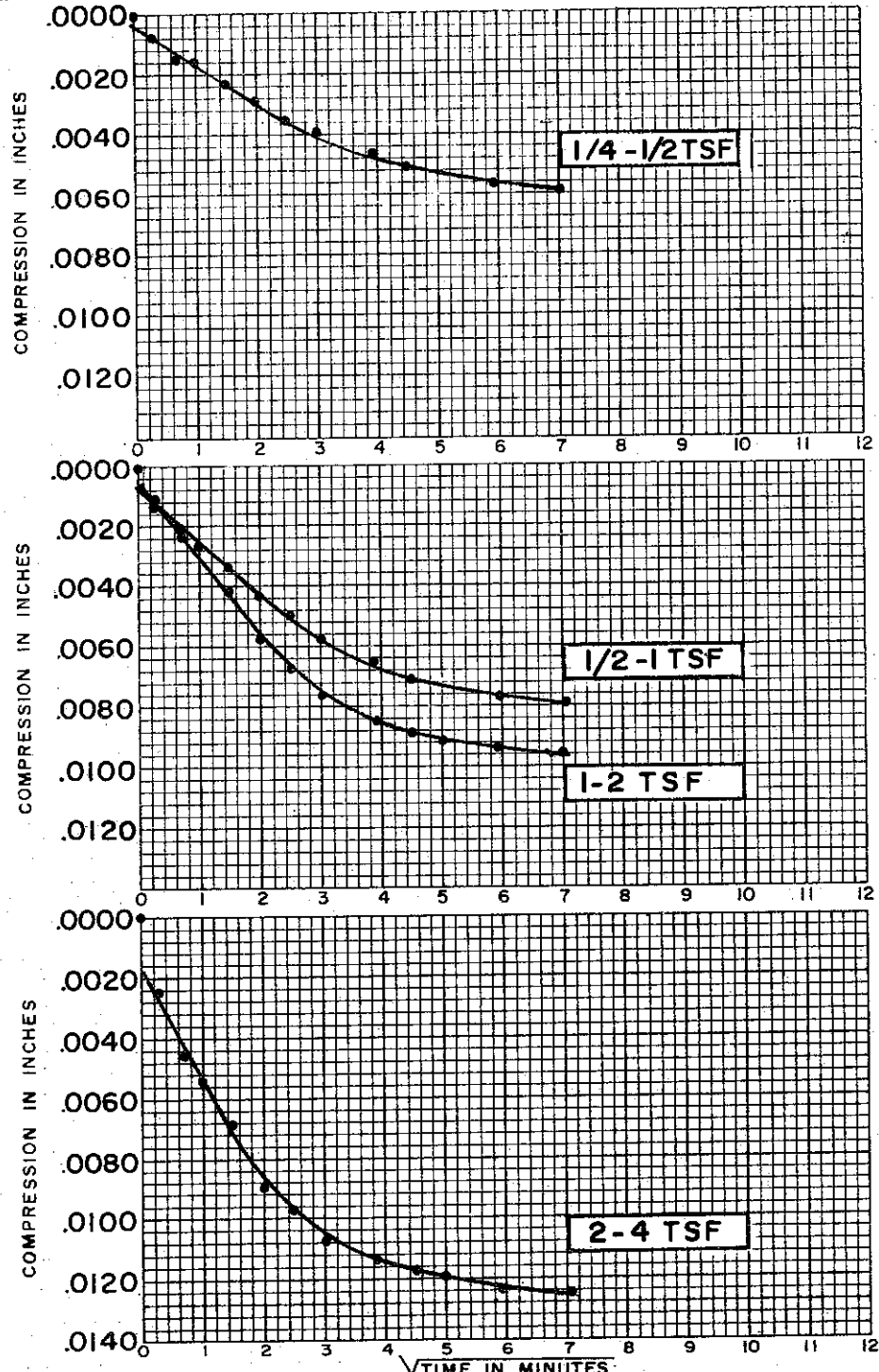

SOIL PROPERTIES		BORING NO.	38
SOIL DESCRIPTION:	SILTY CLAY (CL-CH)	SAMPLE NO.	4
SPECIFIC GRAVITY	2.71	DEPTH	14.6' TO 14.7'
INITIAL WATER CONTENT	29.0 %		
FINAL WATER CONTENT	28.0 %		

TEST DATA	
INITIAL SAMPLE HEIGHT	0.80"
INITIAL SAMPLE DIAMETER	2.50"
INITIAL VOID RATIO	0.770

**CONSOLIDATION TEST
TIME VS. COMPRESSION CURVES**

THE DETROIT EDISON COMPANY
BELLE RIVER PLANT UNITS I & II

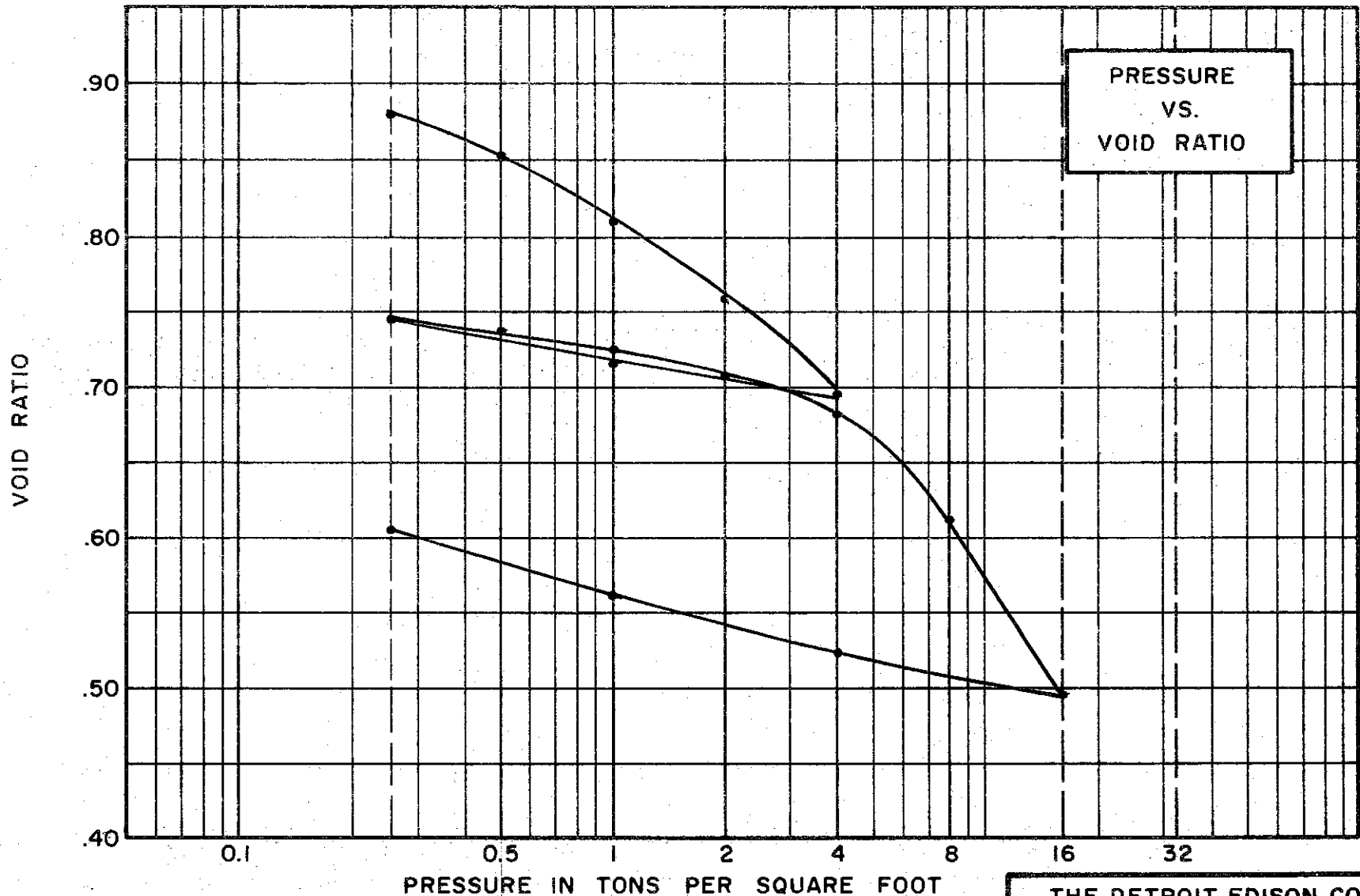

SOIL PROPERTIES

SOIL DESCRIPTION SILTY
CLAY (CH)
 SPECIFIC GRAVITY 2.72
 WATER CONTENT, INITIAL 36.0% FINAL 27.7%
 ATTERBERG LIMITS:
 LIQUID LIMIT 55% PLASTIC LIMIT 24%

TEST DATA

INITIAL SAMPLE HEIGHT 0.80"
 INITIAL SAMPLE DIAMETER 2.50"
 INITIAL VOID RATIO 0.935

THE DETROIT EDISON COMPANY
 BELLE RIVER PLANT UNITS I & II

**CONSOLIDATION TEST
 VOID RATIO VS. LOG PRESSURE**

BORING NO. 38 TEST NO. C24.1
 SAMPLE NO. 16 DATE JAN. 1974
 DEPTH 74.0' TO 74.1'

COMPRESSION IN INCHES

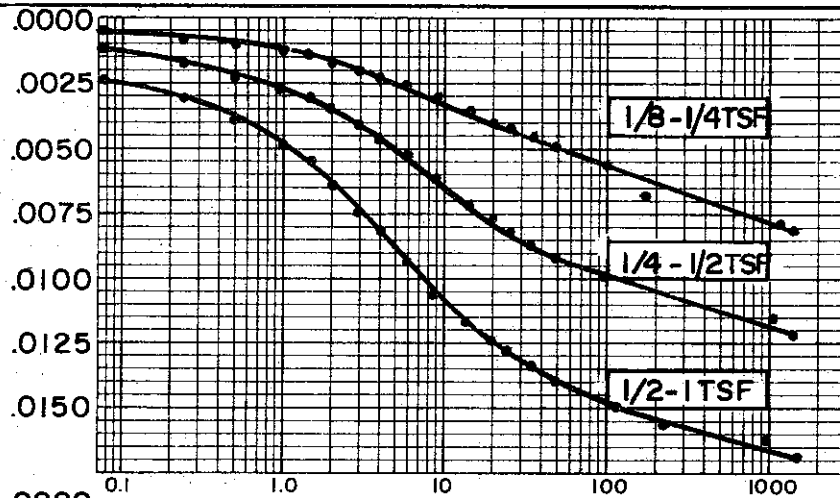

COMPRESSION IN INCHES

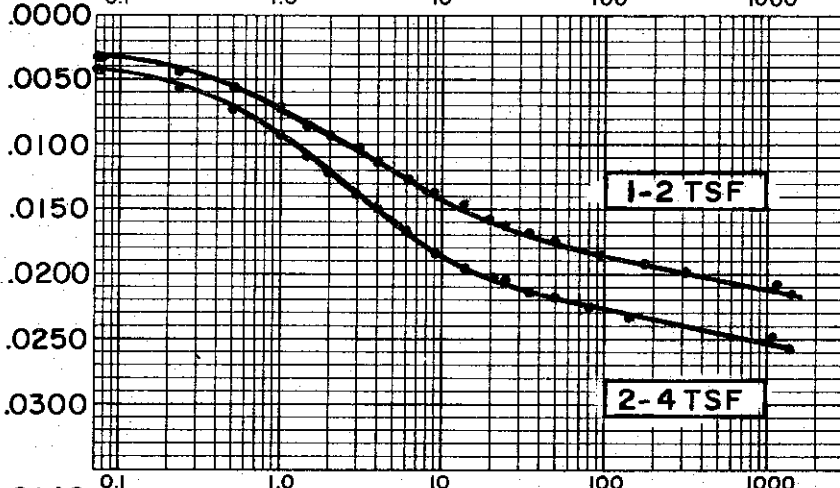

COMPRESSION IN INCHES

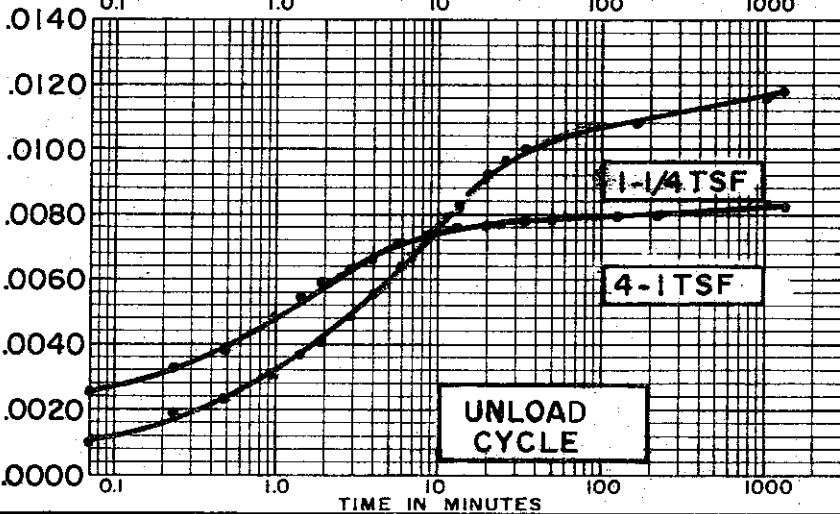

COMPRESSION IN INCHES

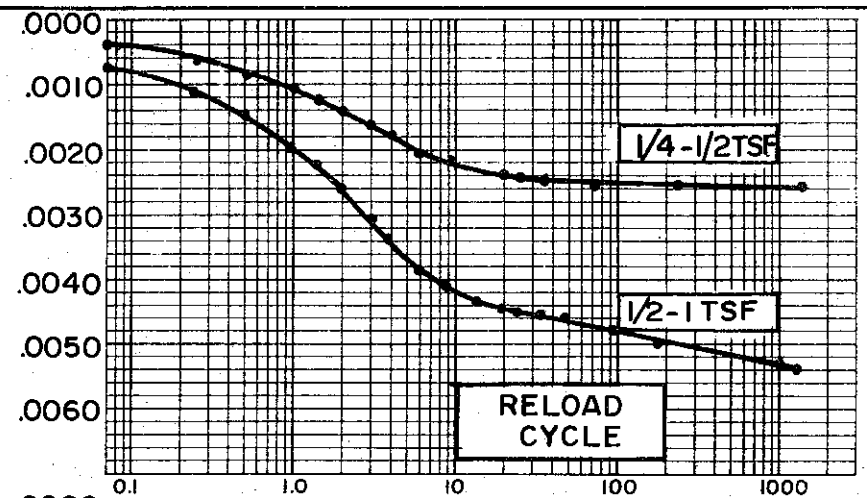

COMPRESSION IN INCHES

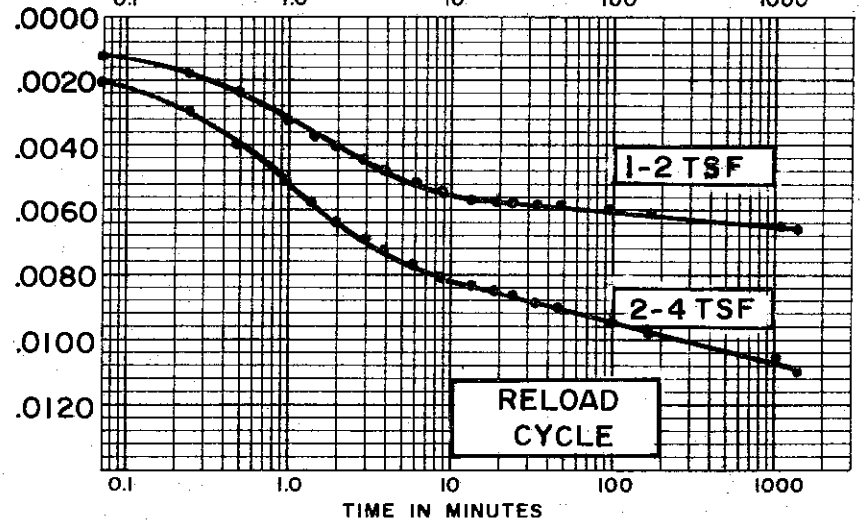

TIME IN MINUTES

SOIL PROPERTIES

SOIL DESCRIPTION: SILTY
CLAY (CH)
 SPECIFIC GRAVITY 2.72
 INITIAL WATER CONTENT 36.0 %
 FINAL WATER CONTENT 27.0 %

BORING NO. 38
 SAMPLE NO. 16
 DEPTH 74.0' TO 74.1'

TEST DATA

INITIAL SAMPLE HEIGHT 0.90"
 INITIAL SAMPLE DIAMETER 2.50"
 INITIAL VOID RATIO 0.935

**CONSOLIDATION TEST
TIME VS. COMPRESSION CURVES**

THE DETROIT EDISON COMPANY
 BELLE RIVER PLANT UNITS I & II

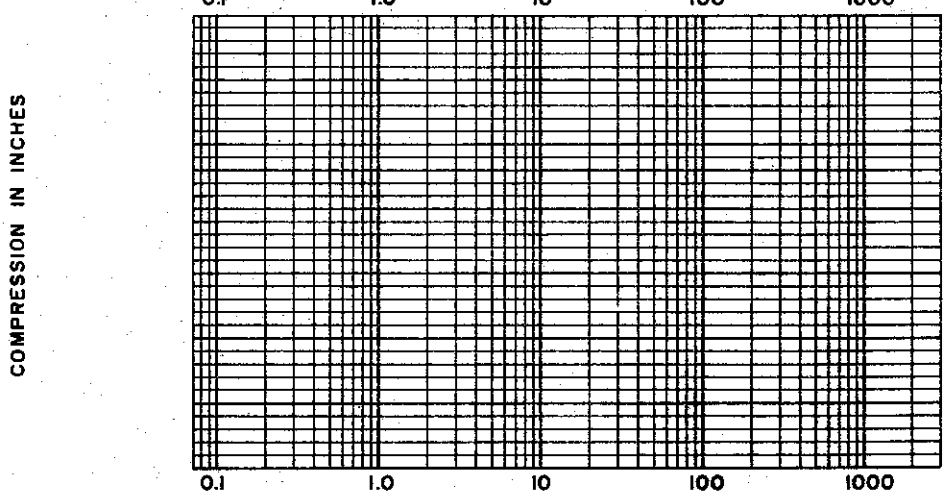
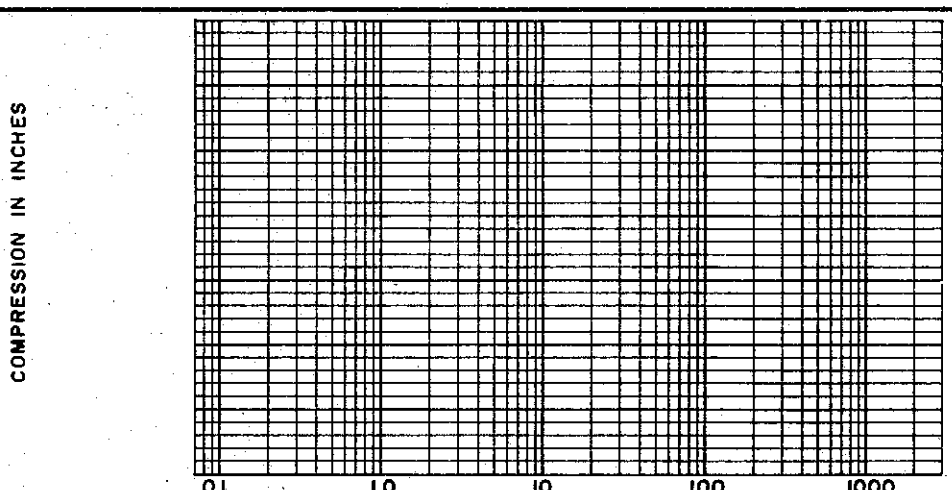
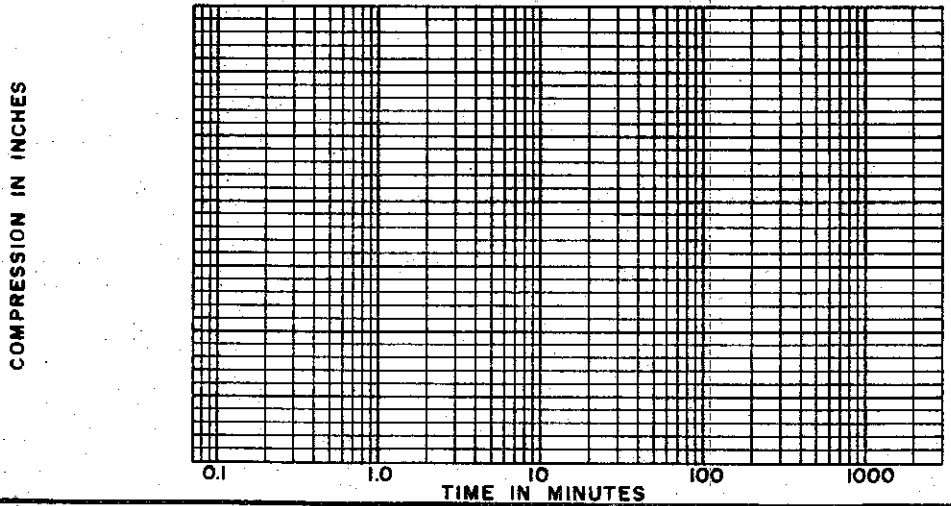
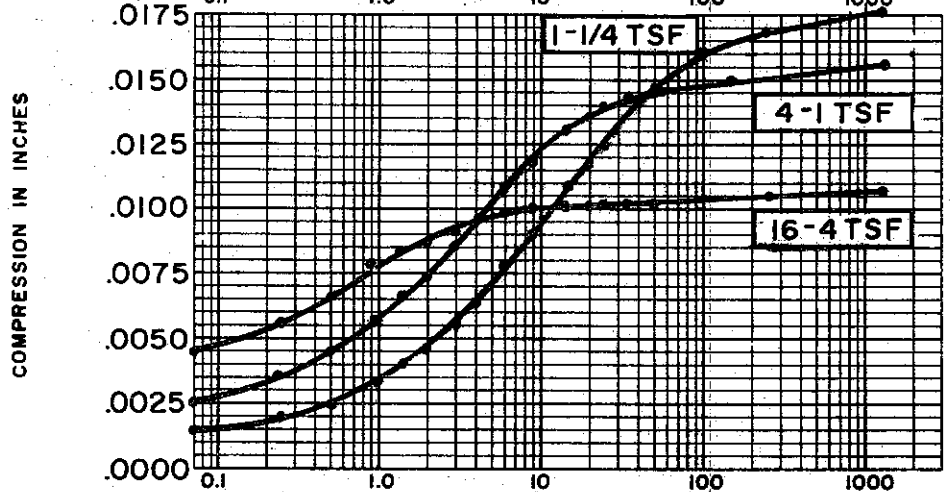
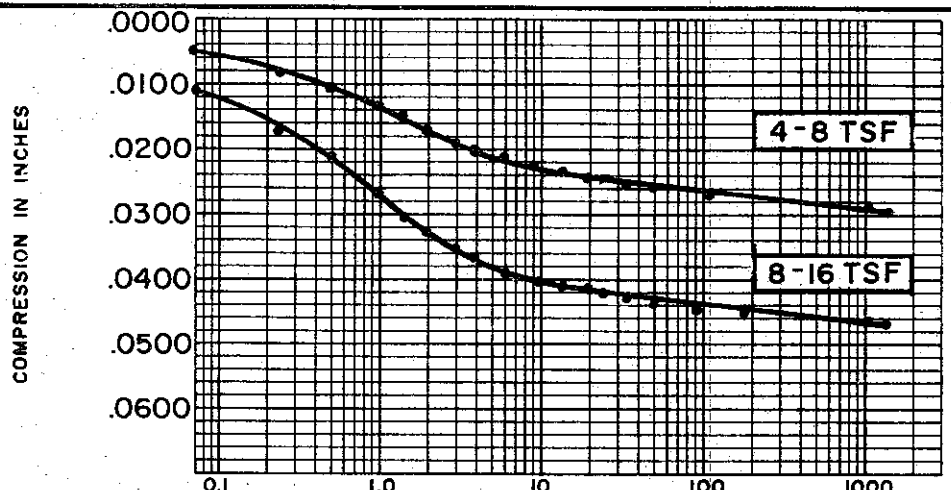

TIME IN MINUTES

SOIL PROPERTIES	
SOIL DESCRIPTION:	SILTY CLAY (CH)
SPECIFIC GRAVITY	2.72
INITIAL WATER CONTENT	36.0%
FINAL WATER CONTENT	27.7%
BORING NO.	38
SAMPLE NO.	16
DEPTH	74.0 TO 74.1

TEST DATA	
INITIAL SAMPLE HEIGHT	0.80"
INITIAL SAMPLE DIAMETER	2.50"
INITIAL VOID RATIO	0.935

CONSOLIDATION TEST
 TIME VS. COMPRESSION CURVES
 THE DETROIT EDISON COMPANY
 BELLE RIVER PLANT UNITS I & II

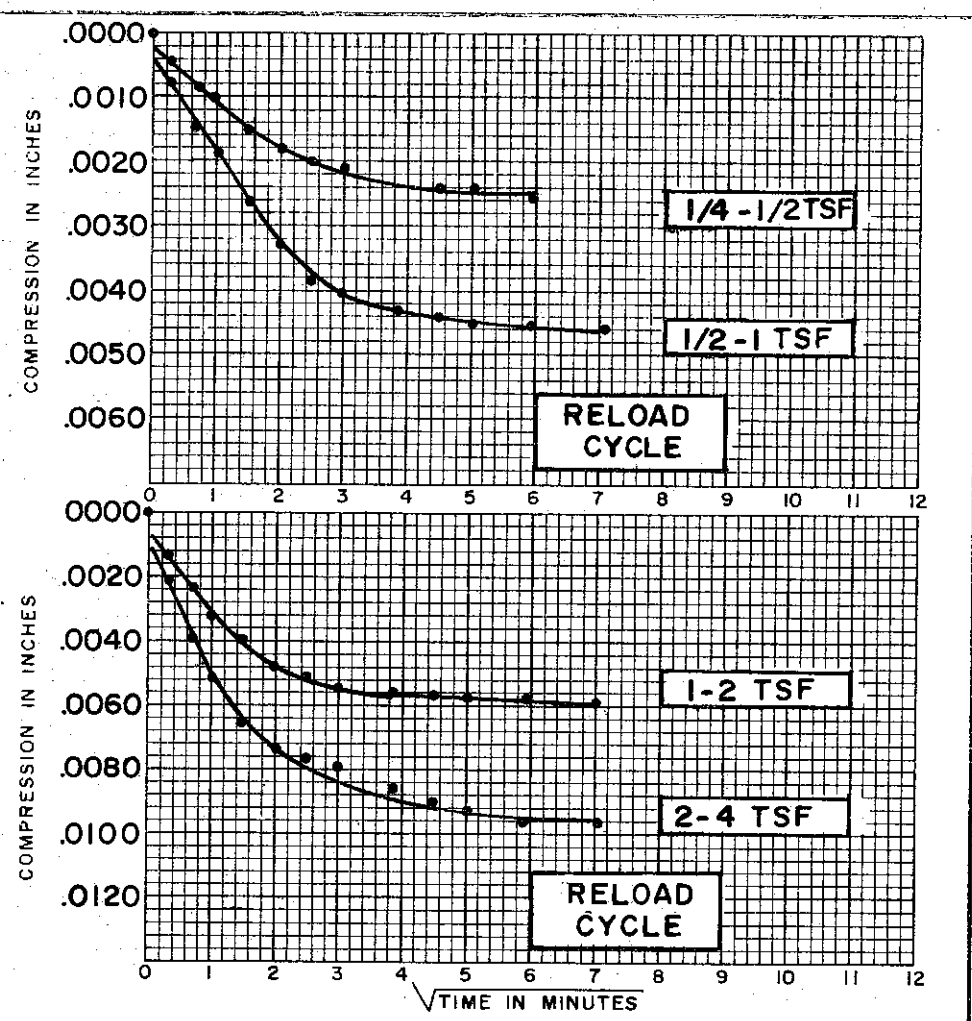
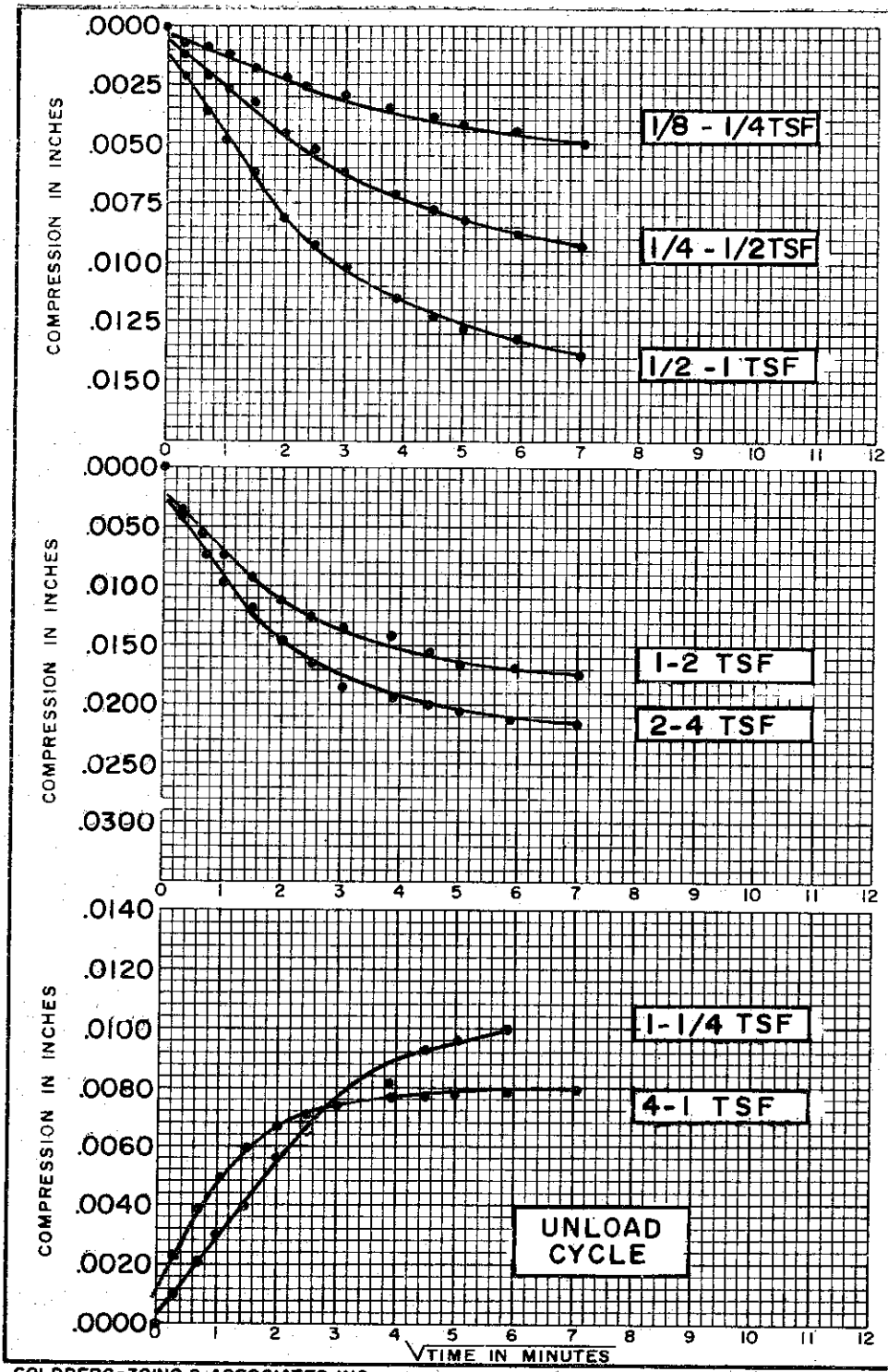

SOIL PROPERTIES		BORING NO. <u>38</u>
SOIL DESCRIPTION:	SILTY CLAY (CH)	SAMPLE NO. <u>16</u>
SPECIFIC GRAVITY	<u>2.72</u>	DEPTH <u>74.0' TO 74.1'</u>
INITIAL WATER CONTENT	<u>36.0%</u>	
FINAL WATER CONTENT	<u>27.7%</u>	
TEST DATA		
INITIAL SAMPLE HEIGHT	<u>0.80"</u>	
INITIAL SAMPLE DIAMETER	<u>2.50"</u>	
INITIAL VOID RATIO	<u>0.935</u>	
CONSOLIDATION TEST		
TIME VS. COMPRESSION CURVES		
THE DETROIT EDISON COMPANY BELLE RIVER PLANT UNITS I & II		

C-467

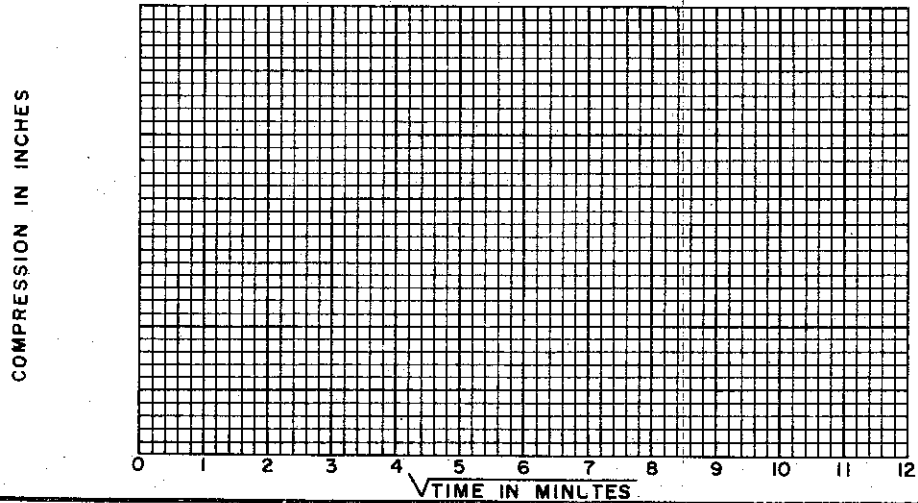
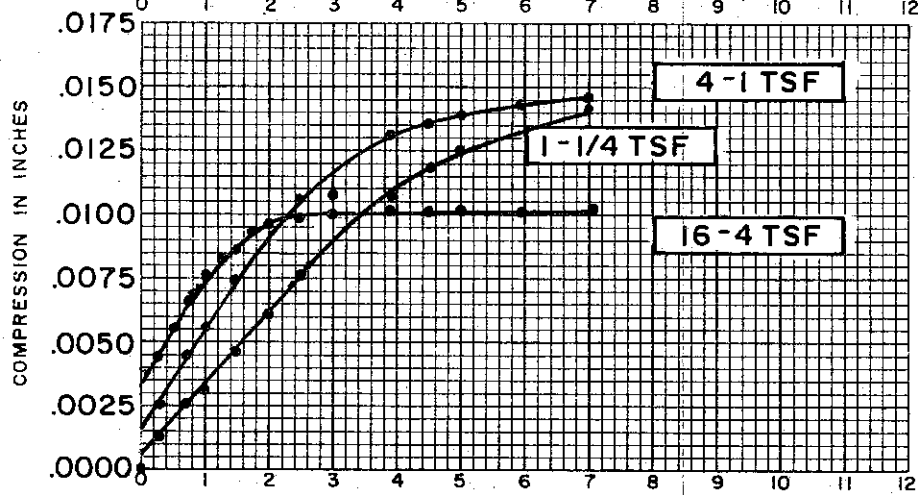
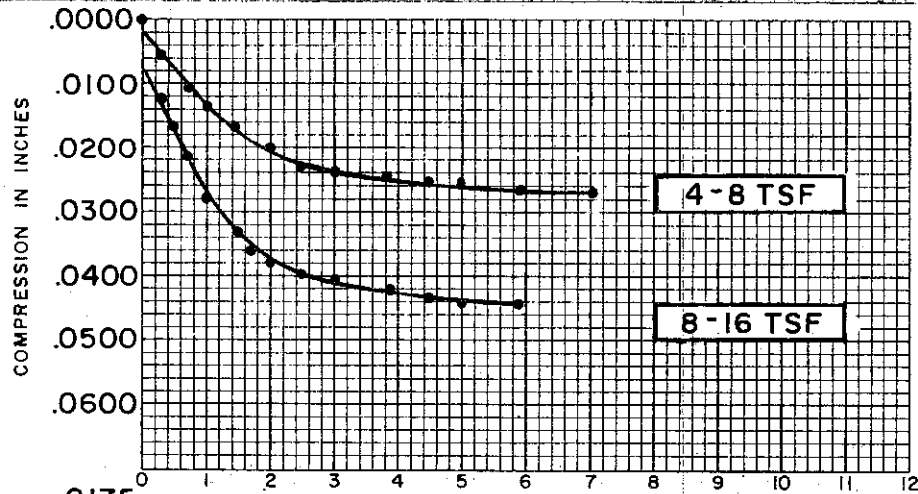

COMPRESSION IN INCHES

COMPRESSION IN INCHES

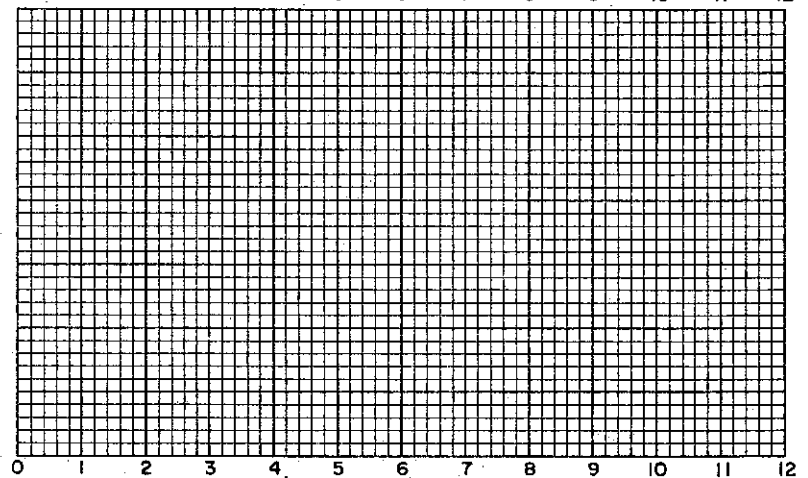
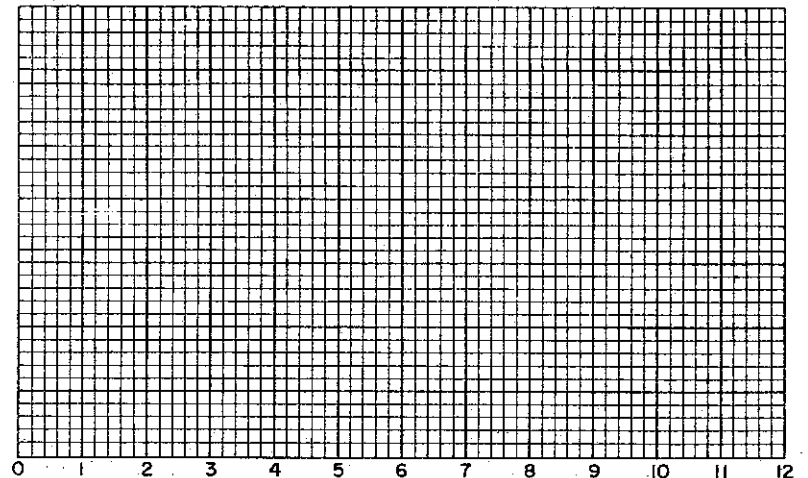

√TIME IN MINUTES

SOIL PROPERTIES

SOIL DESCRIPTION: SILTY
CLAY (CH)
 SPECIFIC GRAVITY 2.72
 INITIAL WATER CONTENT 36.0 %
 FINAL WATER CONTENT 27.7 %

BORING NO. 38
 SAMPLE NO. 16
 DEPTH 74.0 TO 74.1

TEST DATA

INITIAL SAMPLE HEIGHT 0.80"
 INITIAL SAMPLE DIAMETER 2.50"
 INITIAL VOID RATIO 0.935

**CONSOLIDATION TEST
 TIME VS. COMPRESSION CURVES**

THE DETROIT EDISON COMPANY
 BELLE RIVER PLANT UNITS I & II

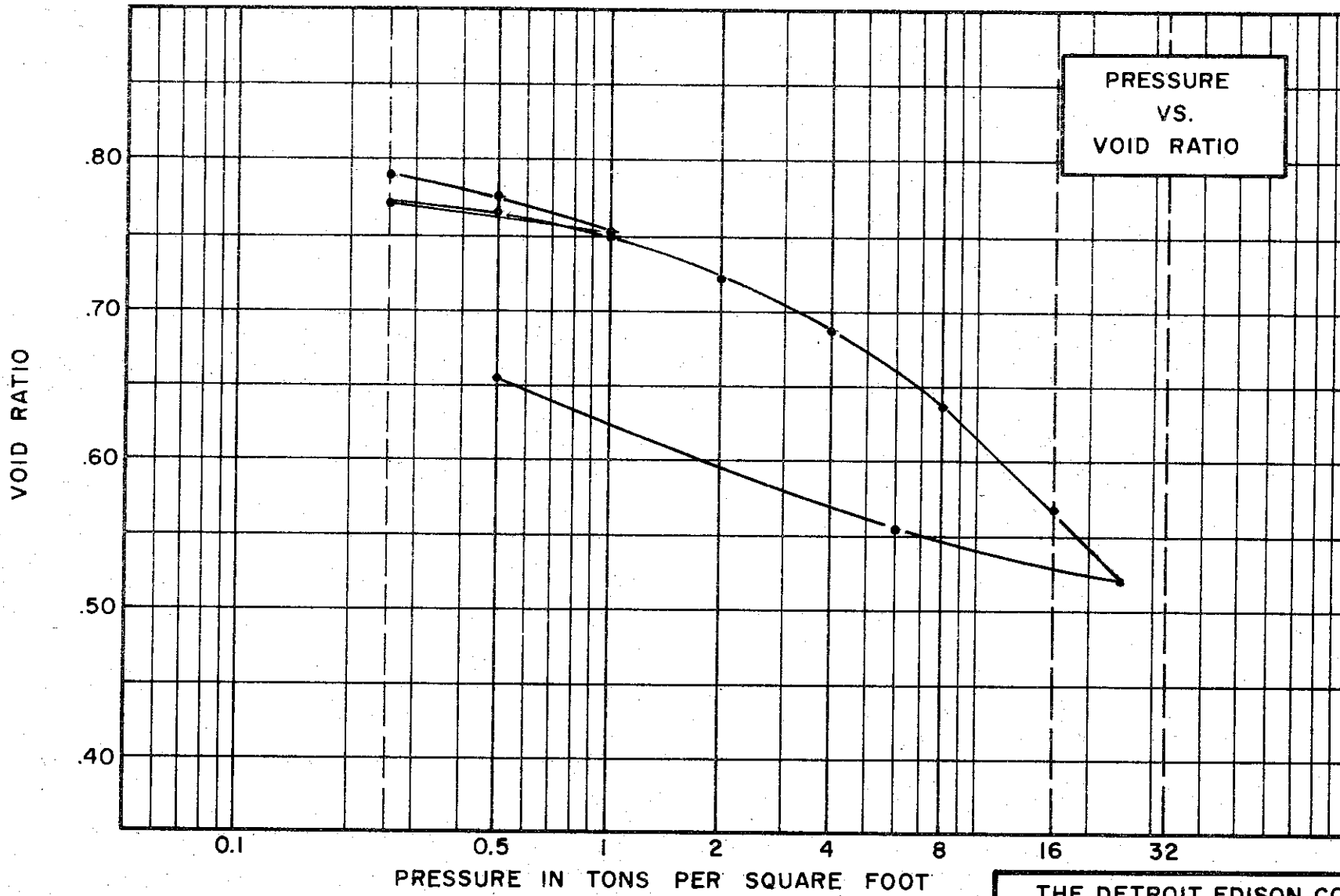

SOIL PROPERTIES

SOIL DESCRIPTION SILTY CLAY
(CL-CH)
 SPECIFIC GRAVITY 2.72
 WATER CONTENT, INITIAL 29.5% FINAL 27.7%
 ATTERBERG LIMITS:
 LIQUID LIMIT 46% PLASTIC LIMIT 23%

TEST DATA

INITIAL SAMPLE HEIGHT 0.80"
 INITIAL SAMPLE DIAMETER 2.50"
 INITIAL VOID RATIO 0.799

THE DETROIT EDISON COMPANY
 BELLE RIVER PLANT UNITS I & II

**CONSOLIDATION TEST
 VOID RATIO VS. LOG PRESSURE**

BORING NO. 41 TEST NO. C29.1
 SAMPLE NO. 5 DATE JAN 74
 DEPTH 10.8'

694-C-469

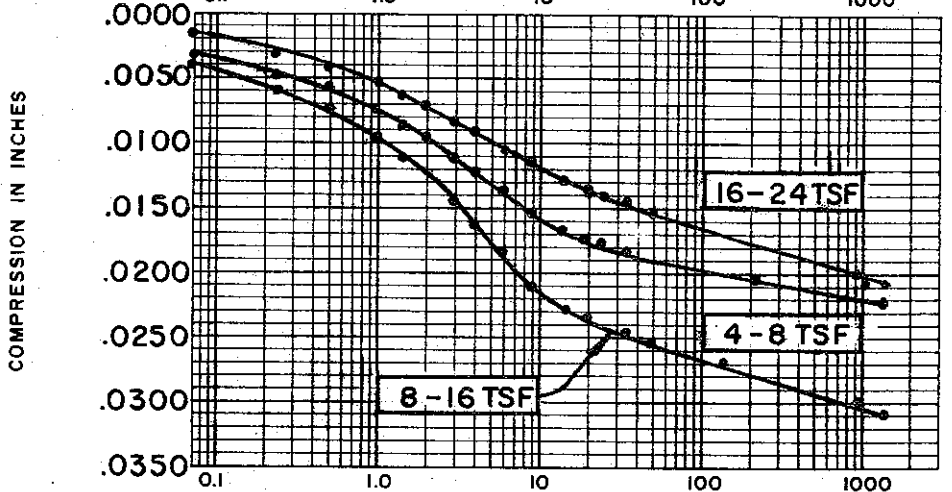
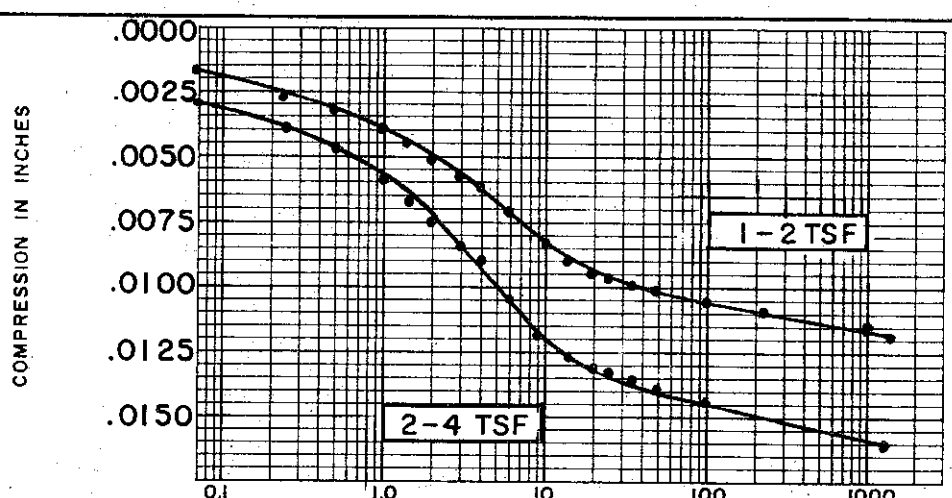
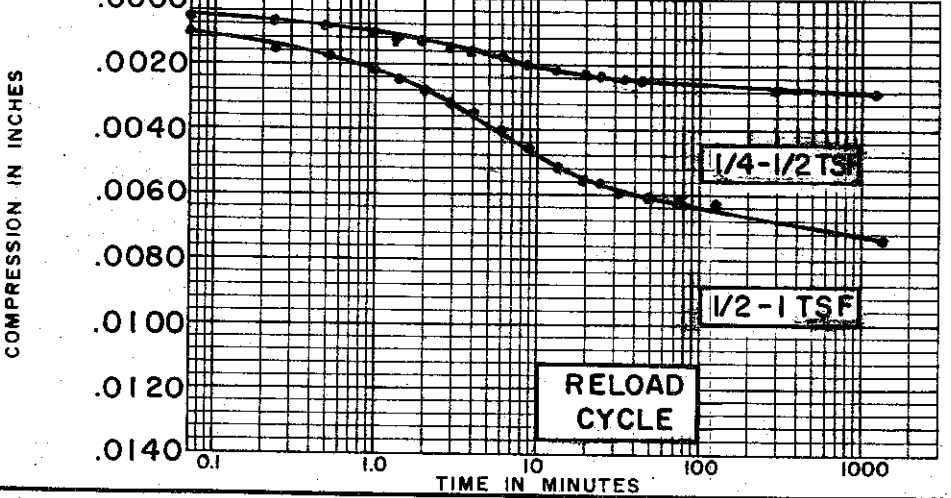
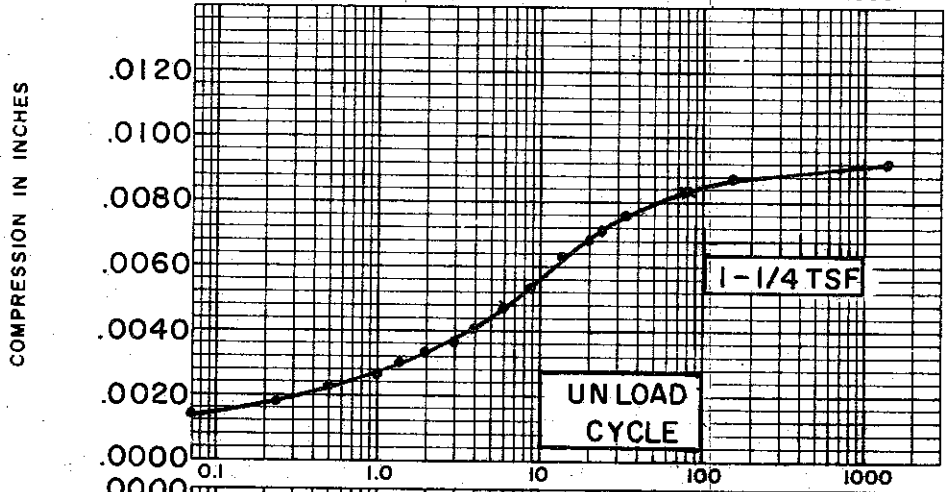
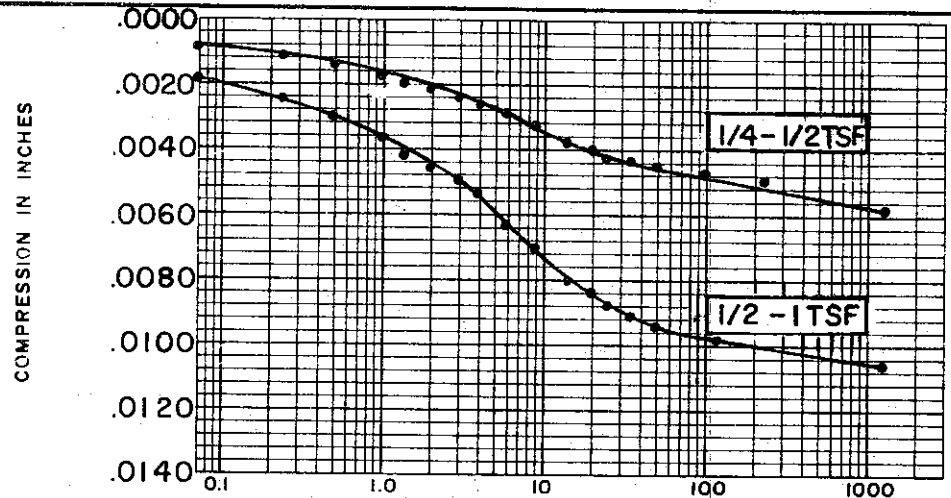

SOIL PROPERTIES	
SOIL DESCRIPTION:	SILTY CLAY (CL)
SPECIFIC GRAVITY	2.72
INITIAL WATER CONTENT	23.5 %
FINAL WATER CONTENT	27.7 %
BORING NO.	41
SAMPLE NO.	5
DEPTH	10.8'

TEST DATA	
INITIAL SAMPLE HEIGHT	0.80"
INITIAL SAMPLE DIAMETER	2.50"
INITIAL VOID RATIO	0.799

CONSOLIDATION TEST
 TIME VS. COMPRESSION CURVES
 THE DETROIT EDISON COMPANY
 BELLE RIVER PLANT UNITS I & II

COMPRESSION IN INCHES

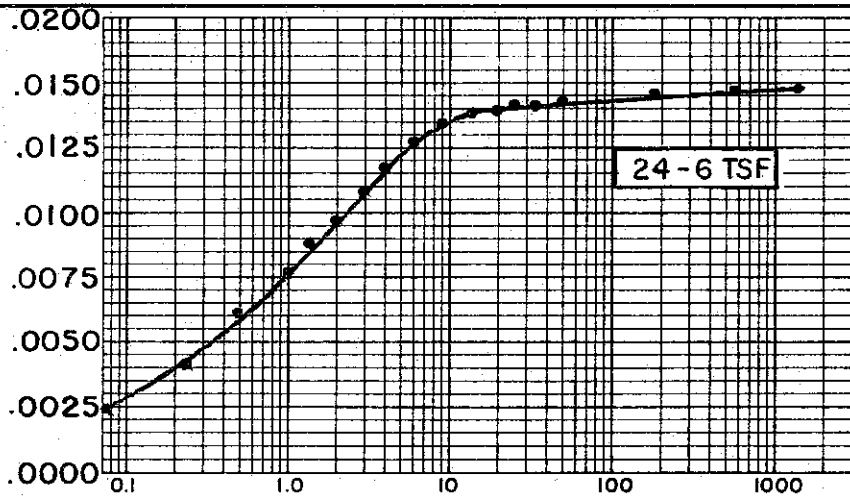

COMPRESSION IN INCHES

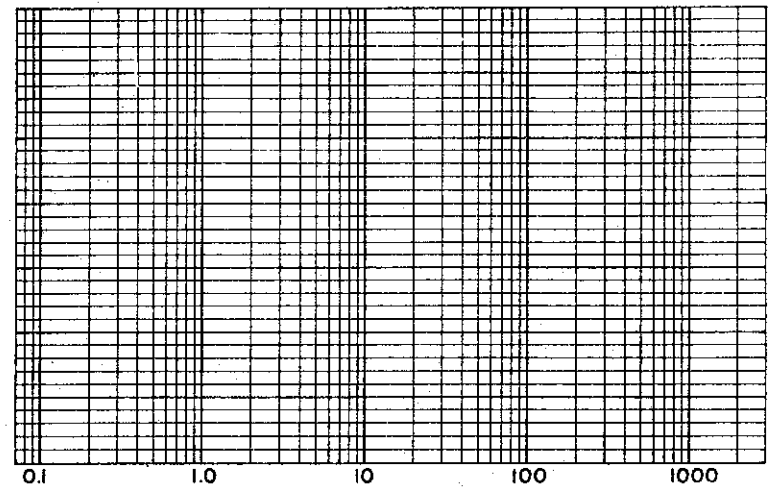

COMPRESSION IN INCHES

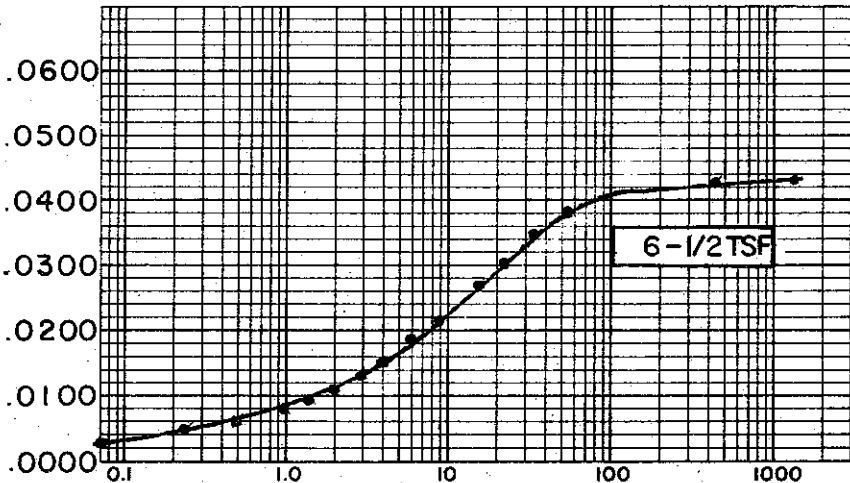

COMPRESSION IN INCHES

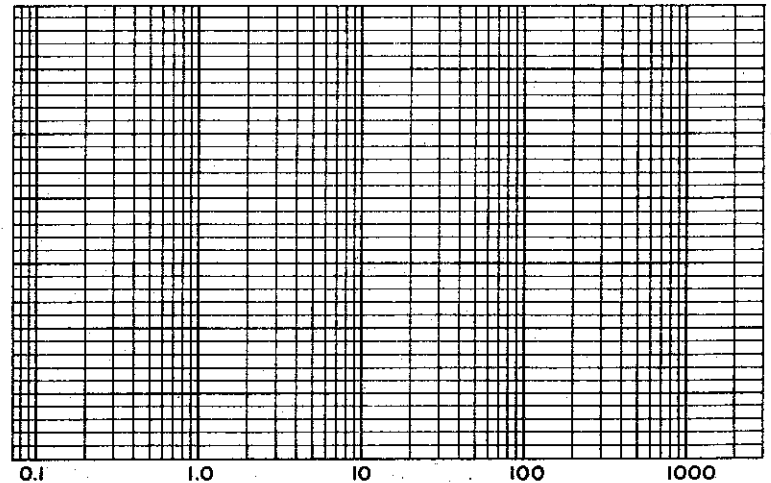

TIME IN MINUTES

COMPRESSION IN INCHES

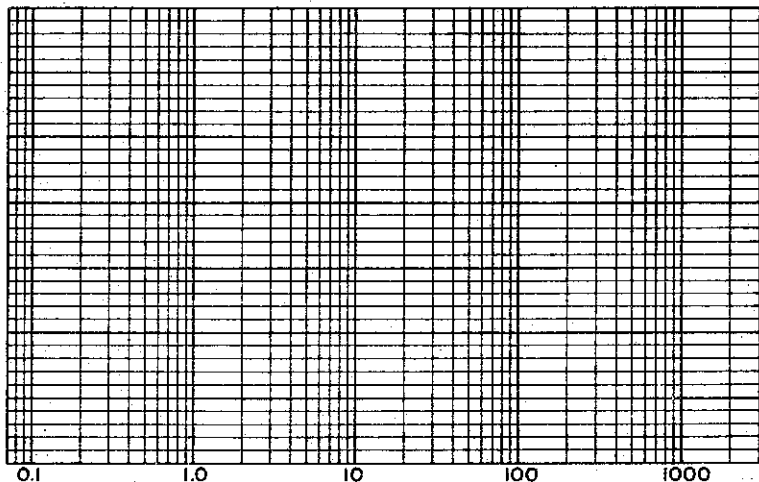

TIME IN MINUTES

SOIL PROPERTIES

SOIL DESCRIPTION: SILTY
CLAY (CL)
 SPECIFIC GRAVITY 2.72
 INITIAL WATER CONTENT 29.5 %
 FINAL WATER CONTENT 27.7 %

BORING NO. 41
 SAMPLE NO. 5
 DEPTH 10.6'

TEST DATA

INITIAL SAMPLE HEIGHT 0.80"
 INITIAL SAMPLE DIAMETER 2.50"
 INITIAL VOID RATIO 0.799

**CONSOLIDATION TEST
TIME VS. COMPRESSION CURVES**

THE DETROIT EDISON COMPANY
 BELLE RIVER PLANT UNITS I & II

FILE 1255

C-471

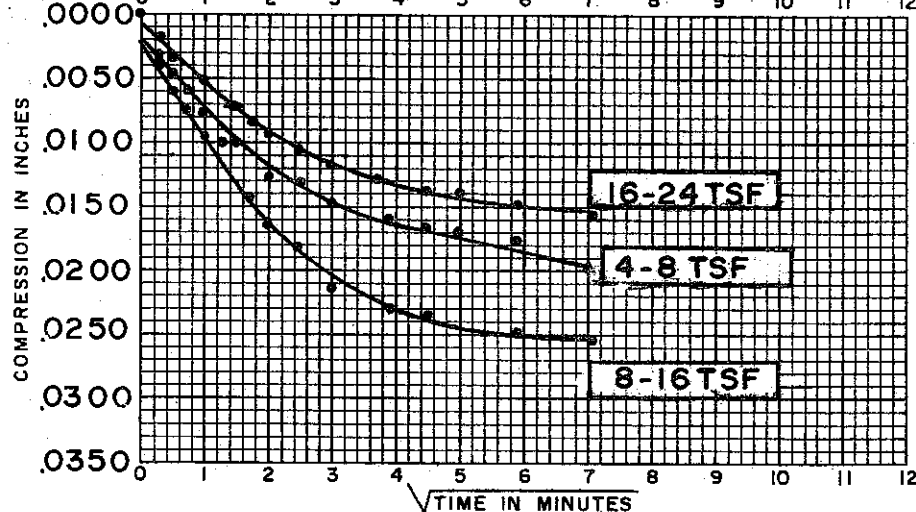
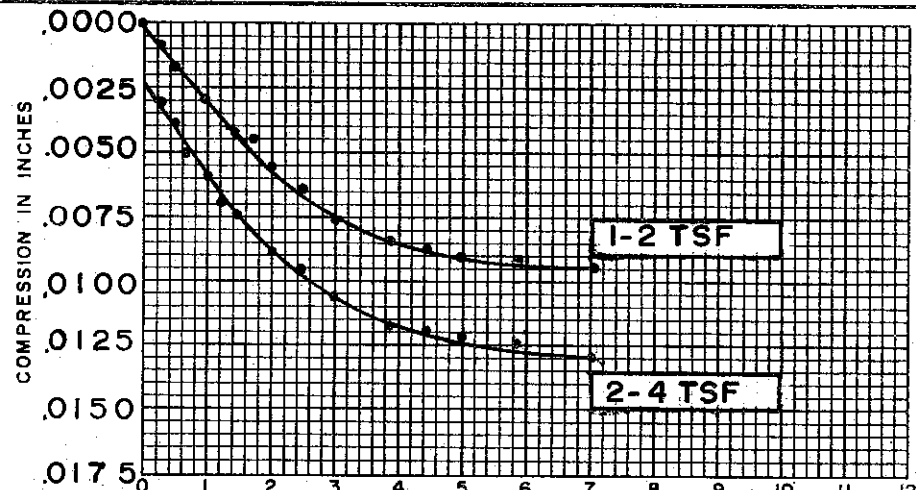
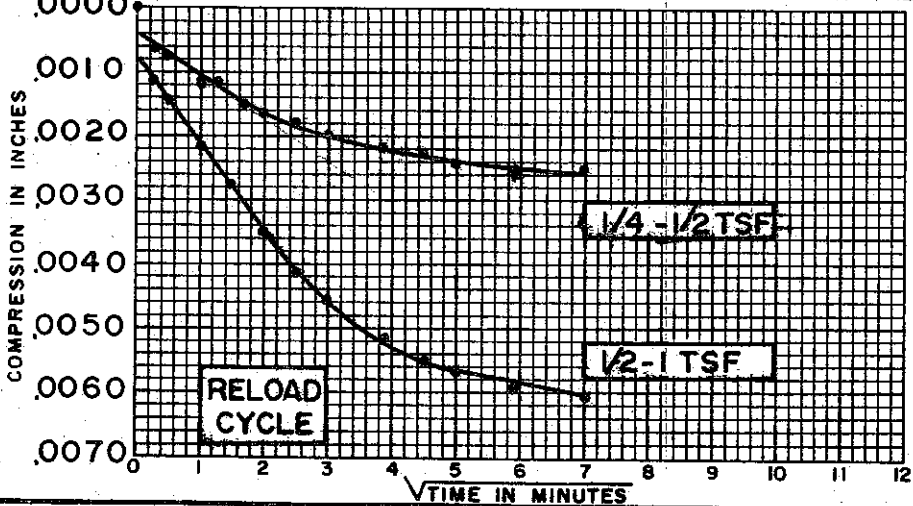
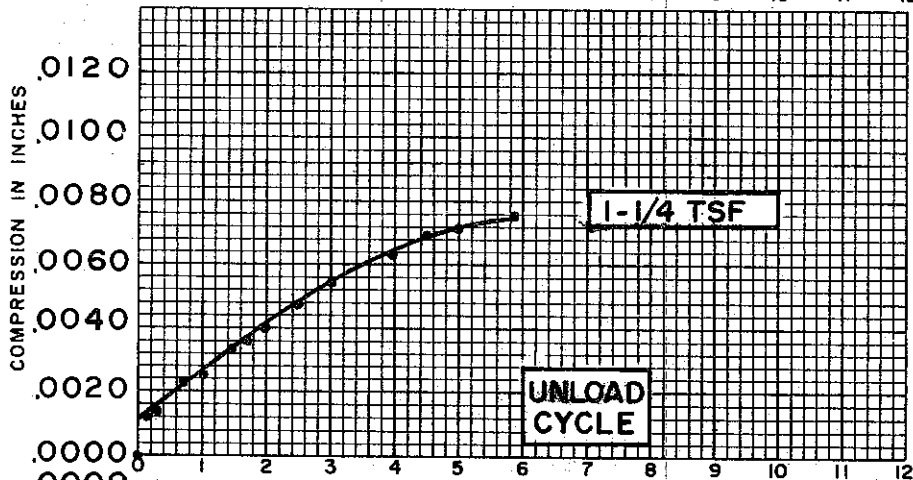
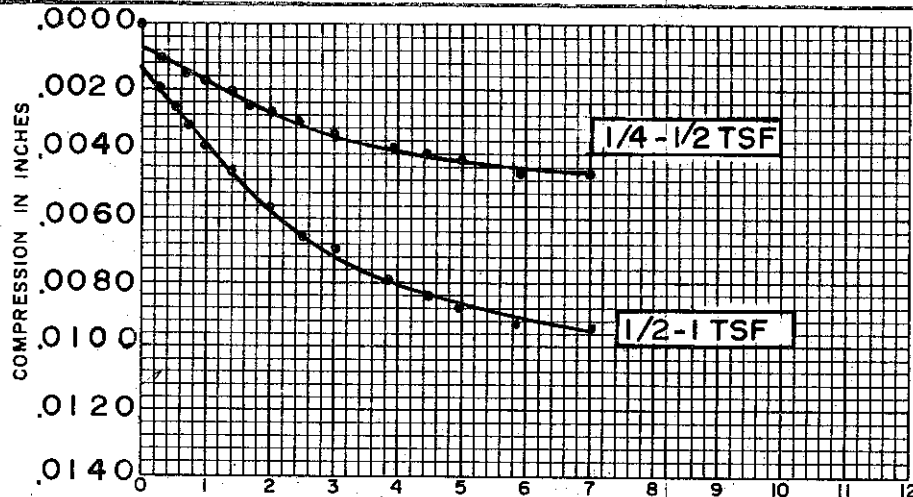

SOIL PROPERTIES	
SOIL DESCRIPTION:	SILTY CLAY (CL-CH)
SPECIFIC GRAVITY	2.72
INITIAL WATER CONTENT	29.5%
FINAL WATER CONTENT	27.7%
BORING NO.	41
SAMPLE NO.	5
DEPTH	10.8'

TEST DATA	
INITIAL SAMPLE HEIGHT	0.80"
INITIAL SAMPLE DIAMETER	2.50"
INITIAL VOID RATIO	.789

CONSOLIDATION TEST
TIME VS. COMPRESSION CURVES
 THE DETROIT EDISON COMPANY
 BELLE RIVER PLANT UNITS I & II

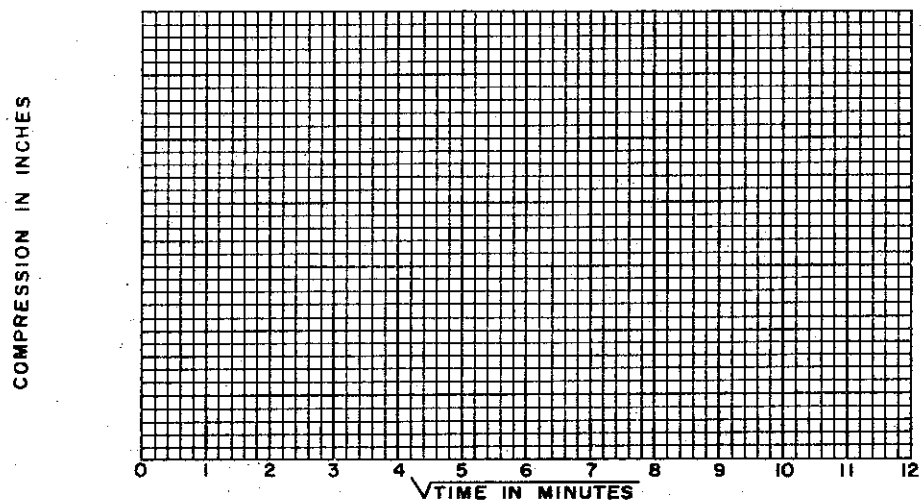
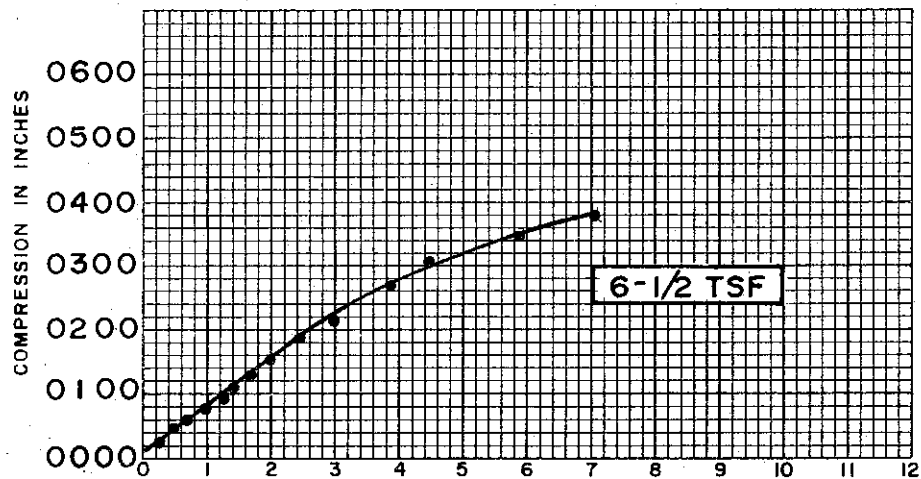
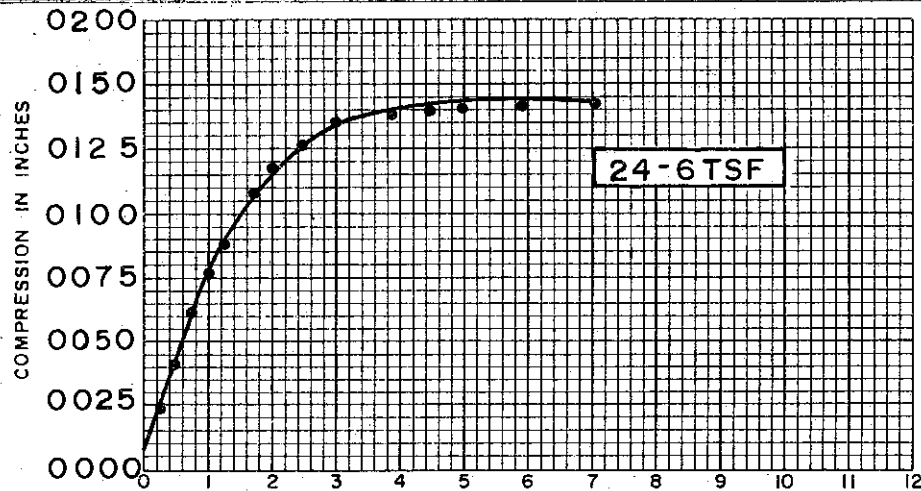

COMPRESSION IN INCHES

COMPRESSION IN INCHES

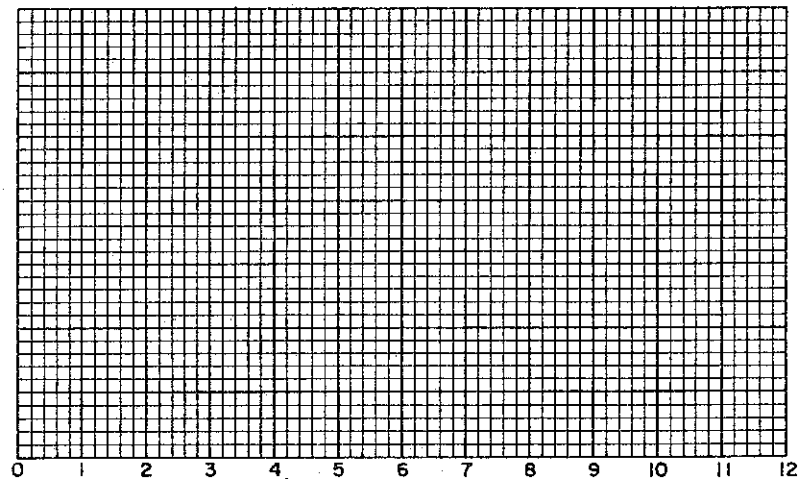
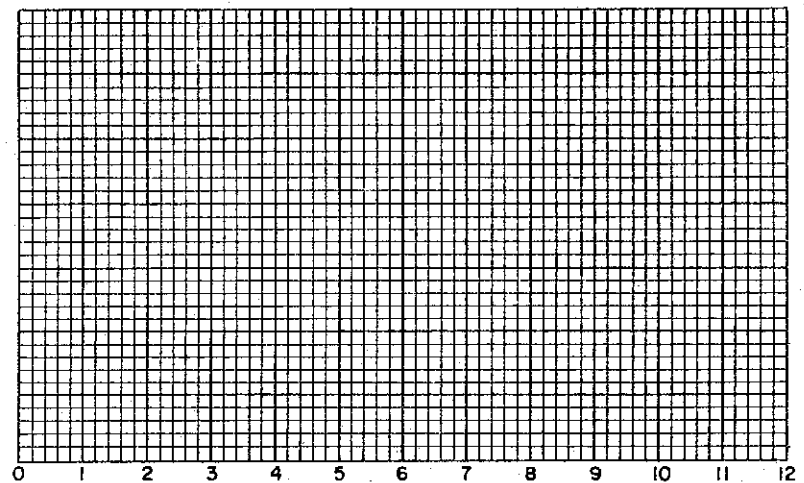

√TIME IN MINUTES

SOIL PROPERTIES

SOIL DESCRIPTION: SILTY CLAY (CL-CH)
 SPECIFIC GRAVITY 2.72
 INITIAL WATER CONTENT 29.5 %
 FINAL WATER CONTENT 27.7 %

BORING NO. 41
 SAMPLE NO. 5
 DEPTH 10.8'

TEST DATA

INITIAL SAMPLE HEIGHT 0.80"
 INITIAL SAMPLE DIAMETER 2.50"
 INITIAL VOID RATIO .799

**CONSOLIDATION TEST
 TIME VS. COMPRESSION CURVES**

THE DETROIT EDISON COMPANY
 BELLE RIVER PLANT UNITS I & II

C-473

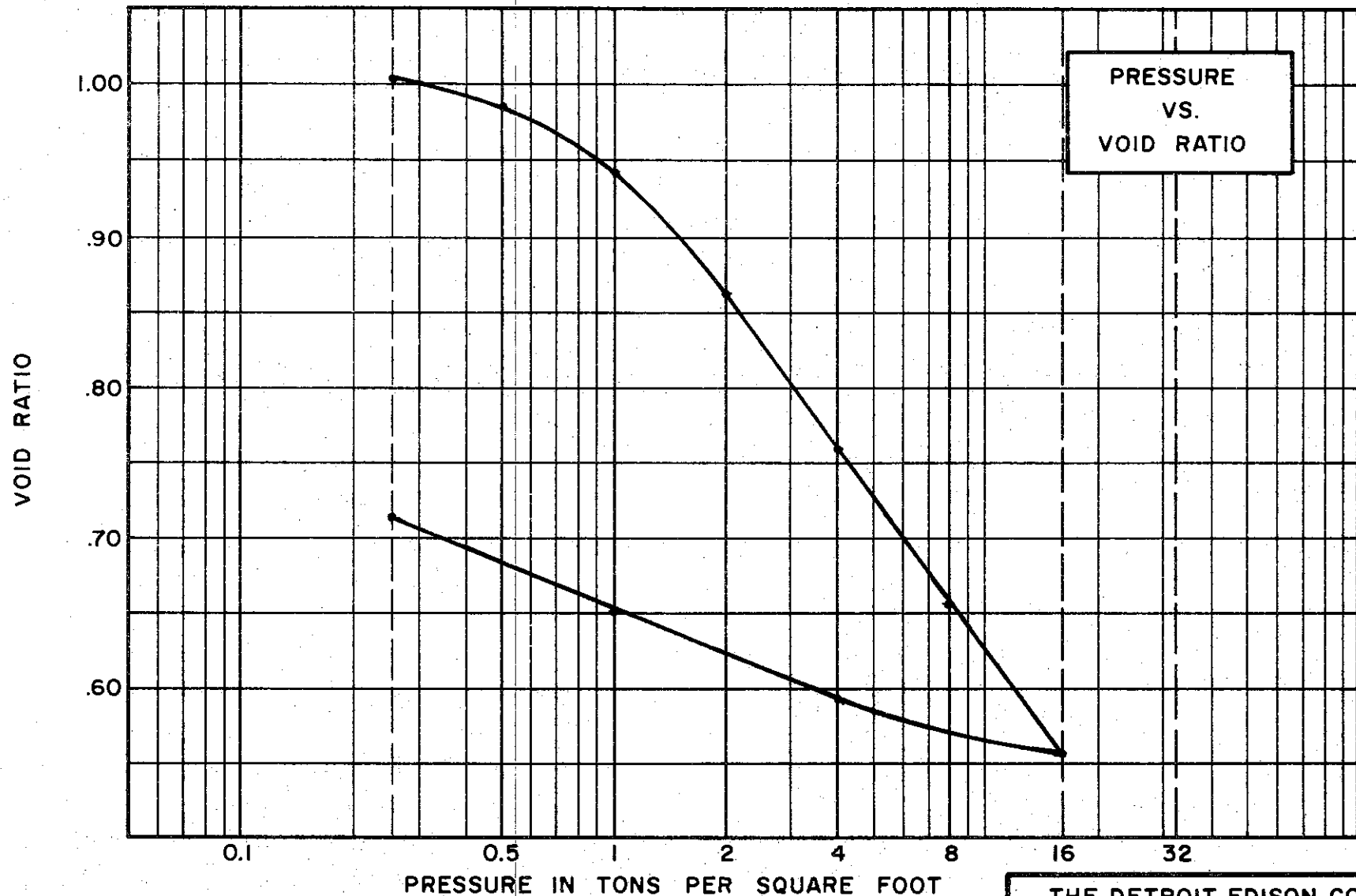

SOIL PROPERTIES

SOIL DESCRIPTION SILTY CLAY
(CL-CH)
 SPECIFIC GRAVITY 2.70
 WATER CONTENT, INITIAL 38.1% FINAL 30.1%
 ATTERBERG LIMITS:
 LIQUID LIMIT 47% PLASTIC LIMIT 24%

TEST DATA

INITIAL SAMPLE HEIGHT 0.80"
 INITIAL SAMPLE DIAMETER 2.50"
 INITIAL VOID RATIO 1.055

THE DETROIT EDISON COMPANY
 BELLE RIVER PLANT UNITS I & II

CONSOLIDATION TEST
VOID RATIO VS. LOG PRESSURE

BORING NO. 41 TEST NO. C 30.1
 SAMPLE NO. 7 DATE FEB 74
 DEPTH 21.0' TO 21.1'

C-475

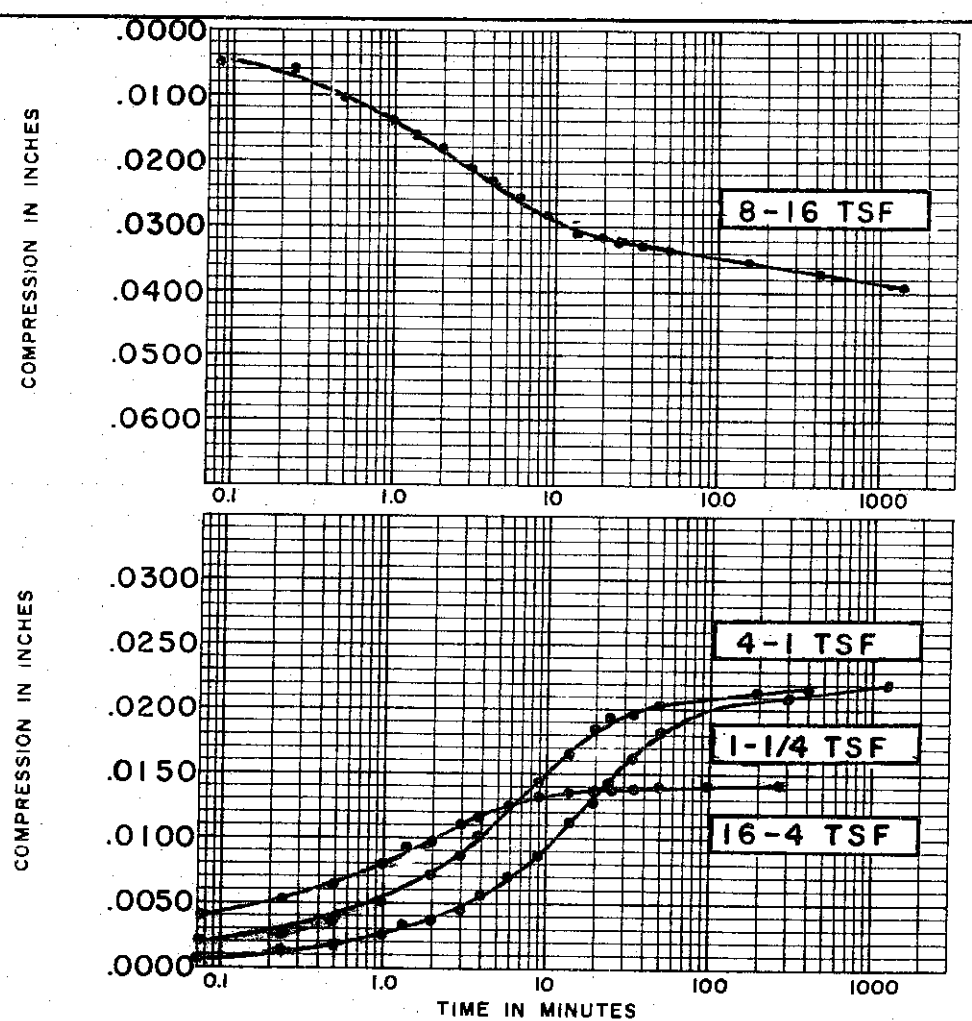
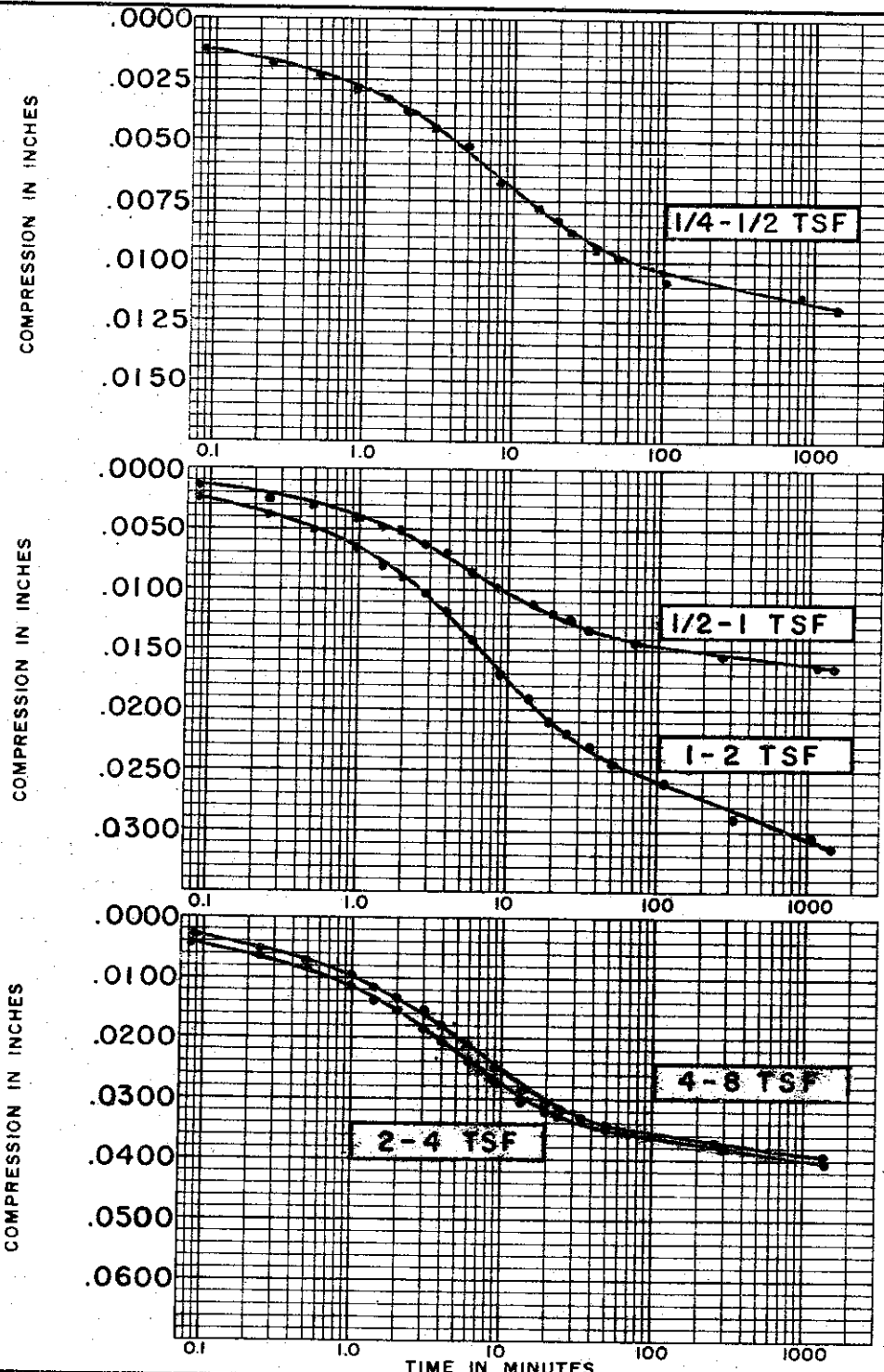

SOIL PROPERTIES	
SOIL DESCRIPTION:	SILTY CLAY (CL)
SPECIFIC GRAVITY	2.70
INITIAL WATER CONTENT	38.1 %
FINAL WATER CONTENT	30.1 %

BORING NO.	41
SAMPLE NO.	7
DEPTH	21.1

TEST DATA	
INITIAL SAMPLE HEIGHT	0.80"
INITIAL SAMPLE DIAMETER	2.50"
INITIAL VOID RATIO	1.055

CONSOLIDATION TEST
 TIME VS. COMPRESSION CURVES

THE DETROIT EDISON COMPANY
 BELLE RIVER PLANT UNITS I & II

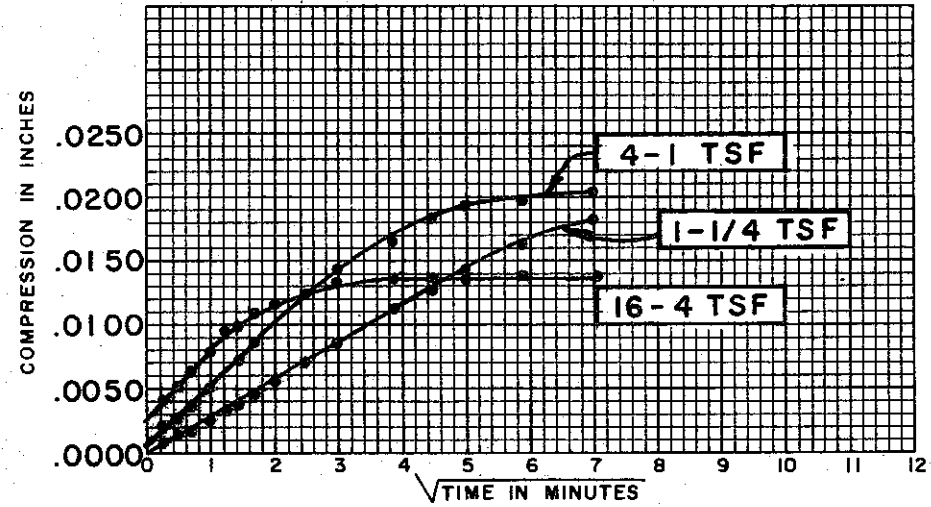
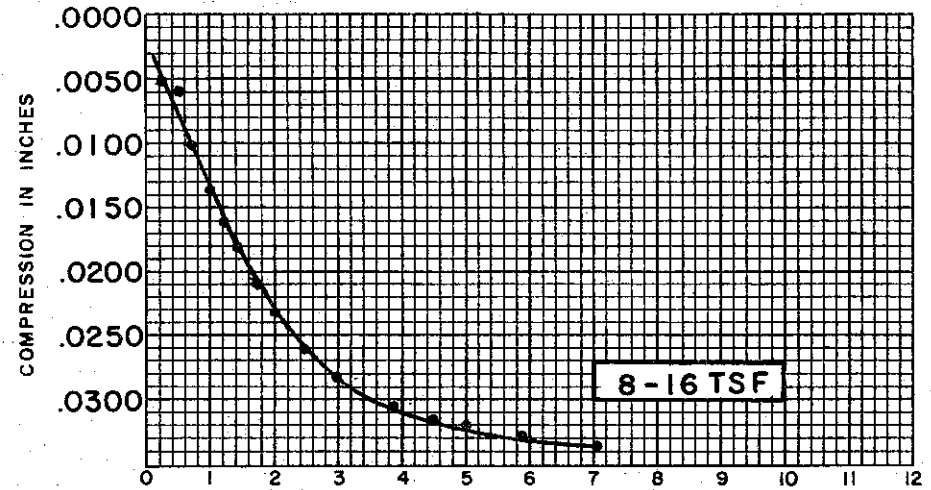
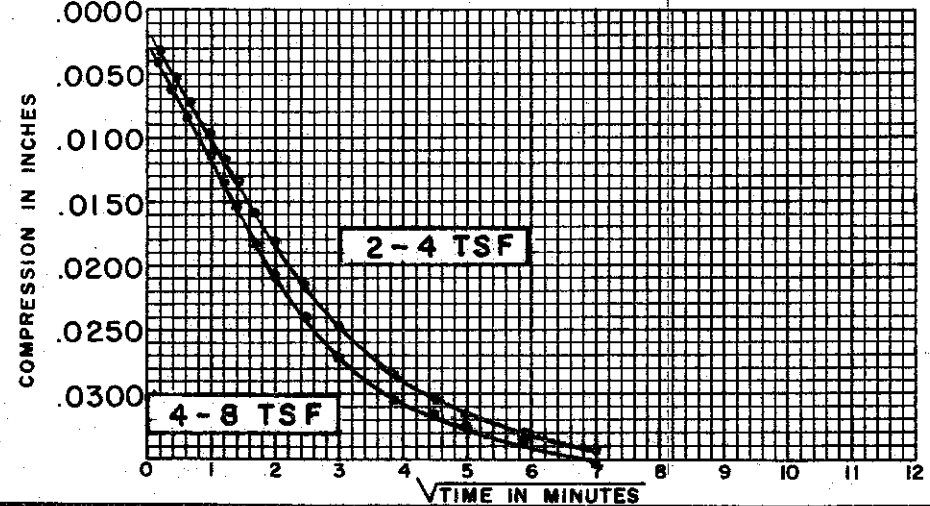
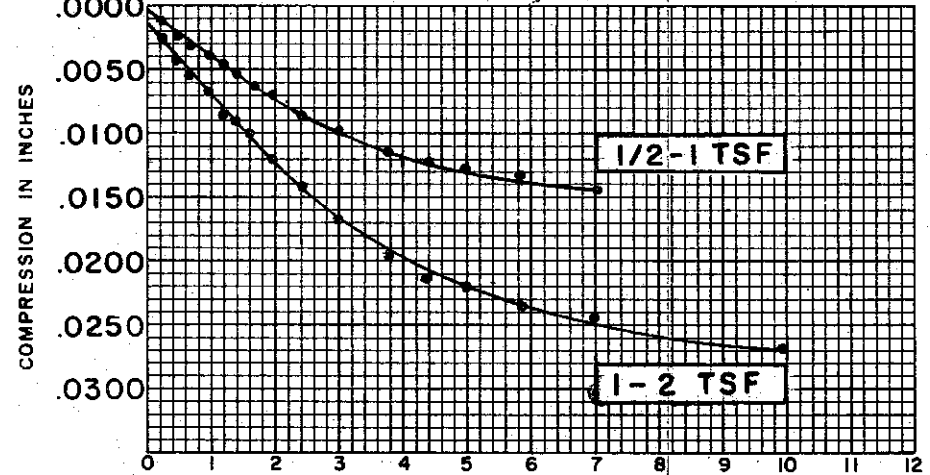
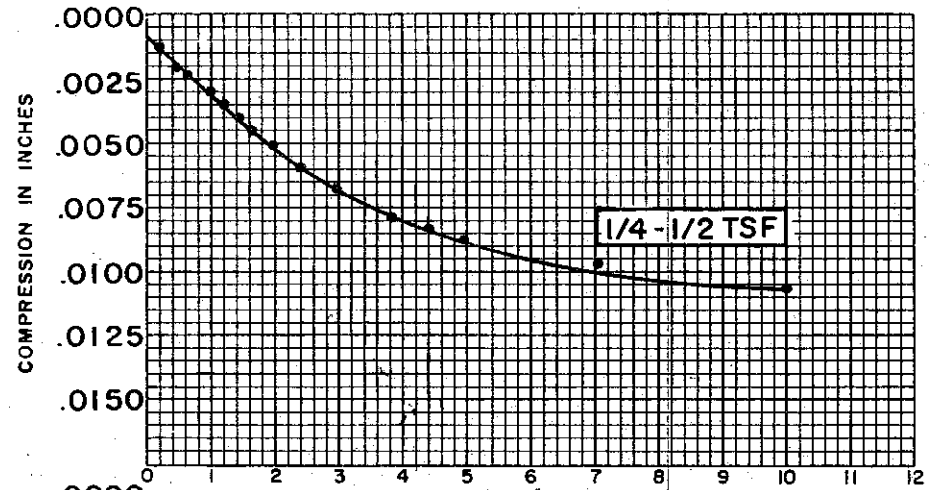

SOIL PROPERTIES

SOIL DESCRIPTION: SILTY
CLAY (CL)
 SPECIFIC GRAVITY 2.70
 INITIAL WATER CONTENT 38.1 %
 FINAL WATER CONTENT 30.1 %

BORING NO. 41
 SAMPLE NO. 7
 DEPTH 21.0

TEST DATA

INITIAL SAMPLE HEIGHT 0.80"
 INITIAL SAMPLE DIAMETER 2.50"
 INITIAL VOID RATIO 1.055

**CONSOLIDATION TEST
 TIME VS. COMPRESSION CURVES**

THE DETROIT EDISON COMPANY
 BELLE RIVER PLANT UNITS I & II

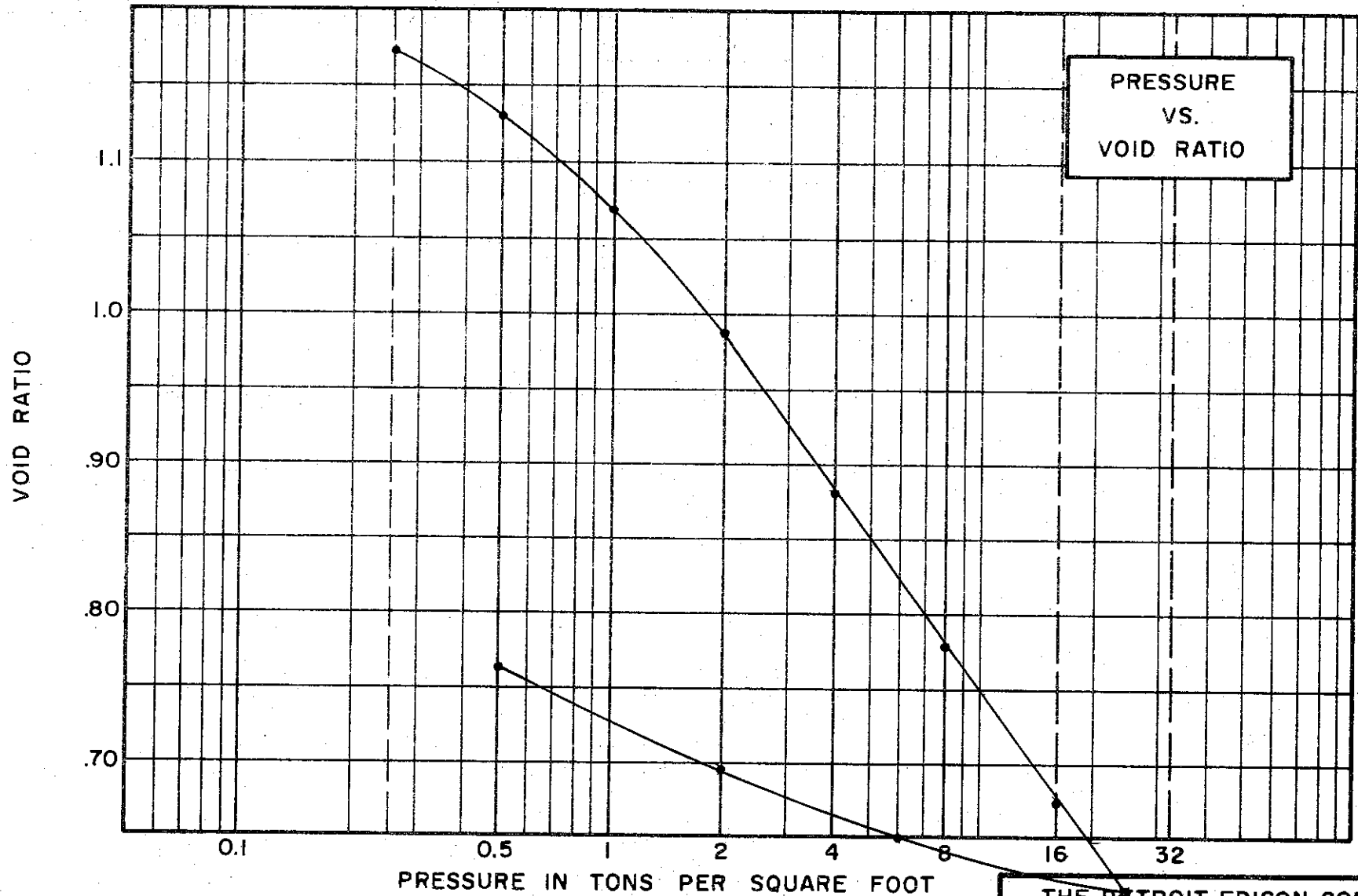

SOIL PROPERTIES

SOIL DESCRIPTION SILTY
CLAY (CL-CH)
 SPECIFIC GRAVITY 2.75
 WATER CONTENT, INITIAL 46.5% FINAL 31.9%
 ATTERBERG LIMITS:
 LIQUID LIMIT 52% PLASTIC LIMIT 25%

TEST DATA

INITIAL SAMPLE HEIGHT 0.75"
 INITIAL SAMPLE DIAMETER 2.50"
 INITIAL VOID RATIO 1.235

THE DETROIT EDISON COMPANY
 BELLE RIVER PLANT UNITS I & II

CONSOLIDATION TEST
VOID RATIO VS. LOG PRESSURE

BORING NO. 41 TEST NO. C33.1
 SAMPLE NO. 13 DATE JAN. 1974
 DEPTH 53'

C-477

0-7-0

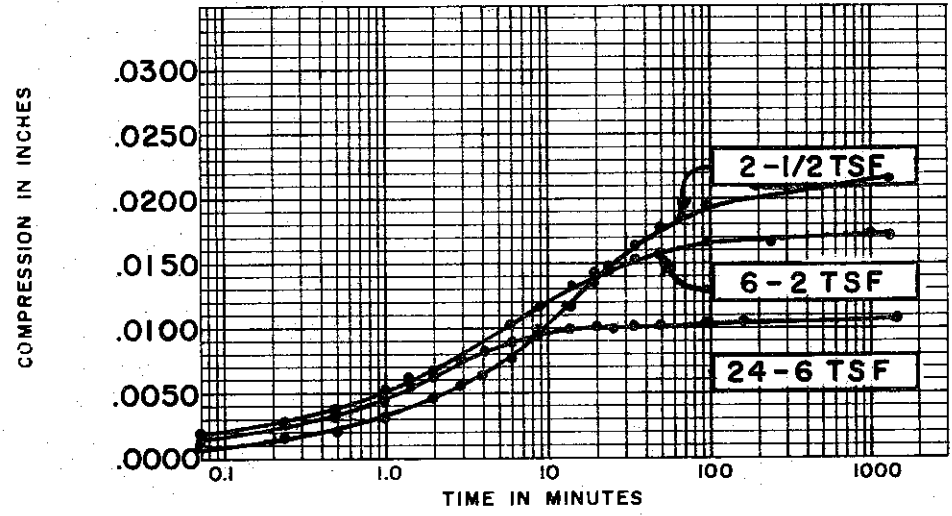
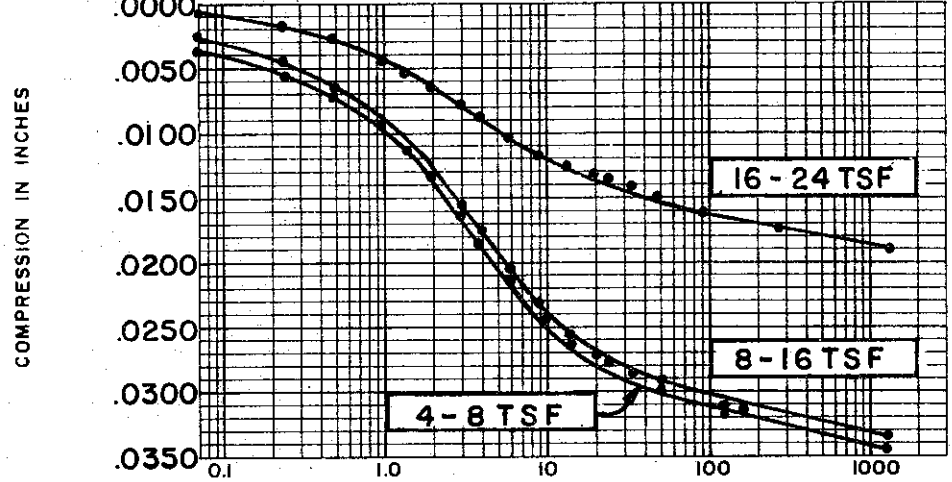
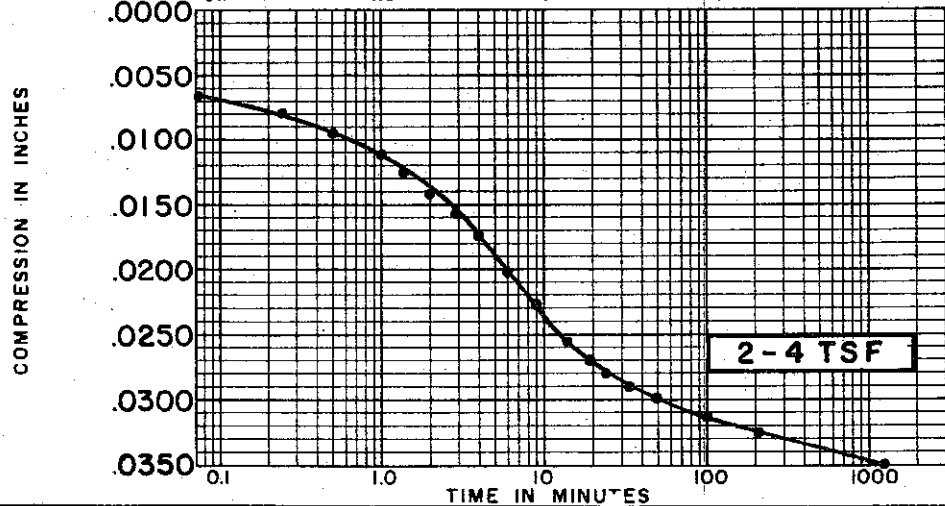
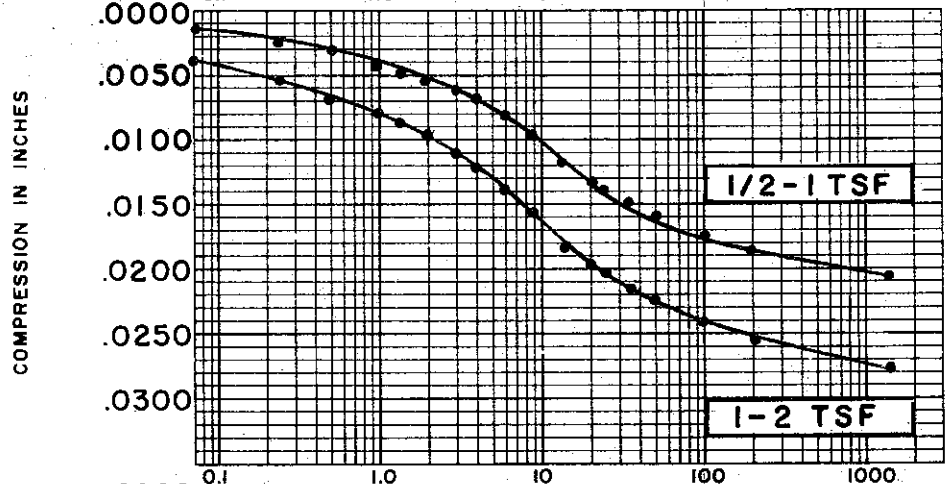
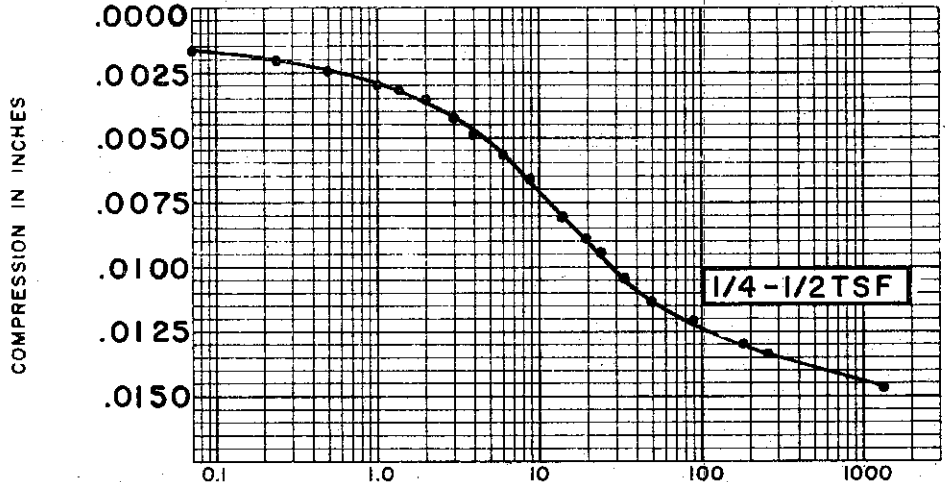

SOIL PROPERTIES

SOIL DESCRIPTION: SILTY CLAY (CL-CH)
 SPECIFIC GRAVITY 2.75
 INITIAL WATER CONTENT 43.5%
 FINAL WATER CONTENT 31.9%

BORING NO. 41
 SAMPLE NO. 13
 DEPTH 53.0'

TEST DATA

INITIAL SAMPLE HEIGHT 0.75"
 INITIAL SAMPLE DIAMETER 2.50"
 INITIAL VOID RATIO 1.235

**CONSOLIDATION TEST
 TIME VS. COMPRESSION CURVES**

THE DETROIT EDISON COMPANY
 BELLE RIVER PLANT UNITS I & II

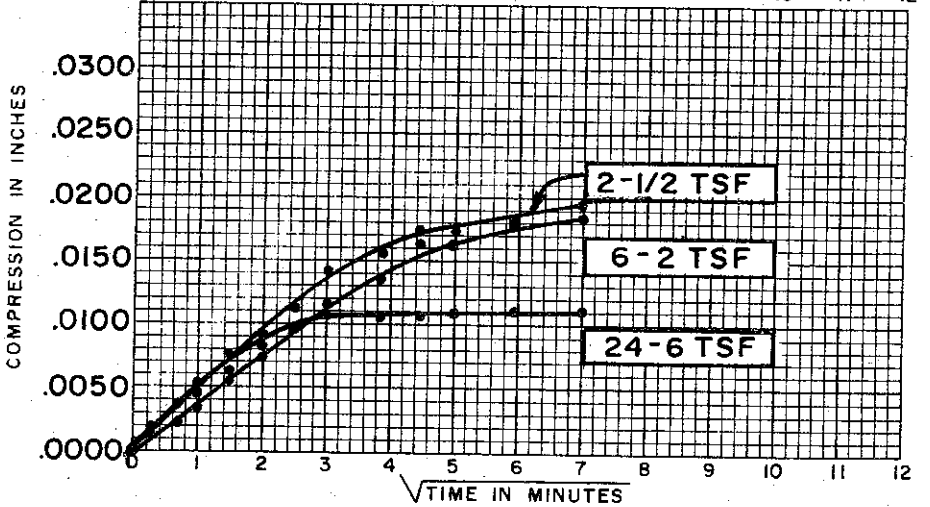
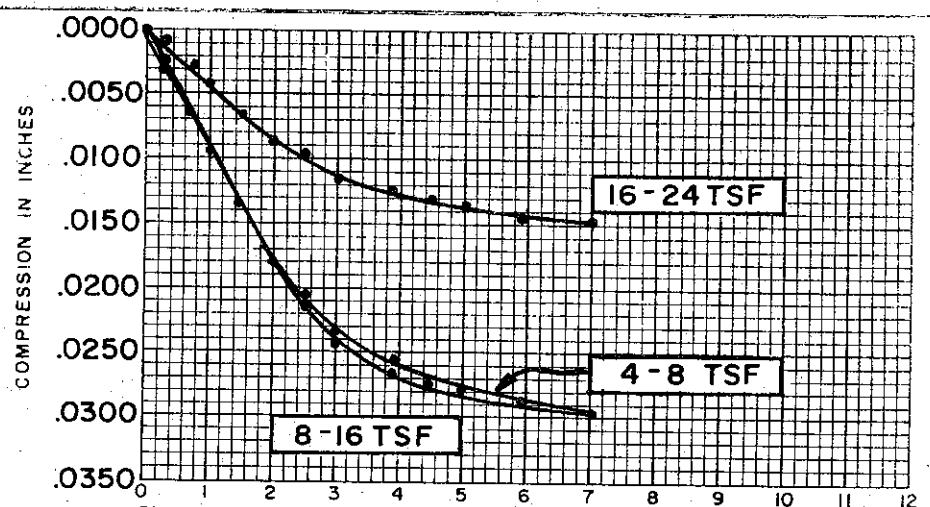
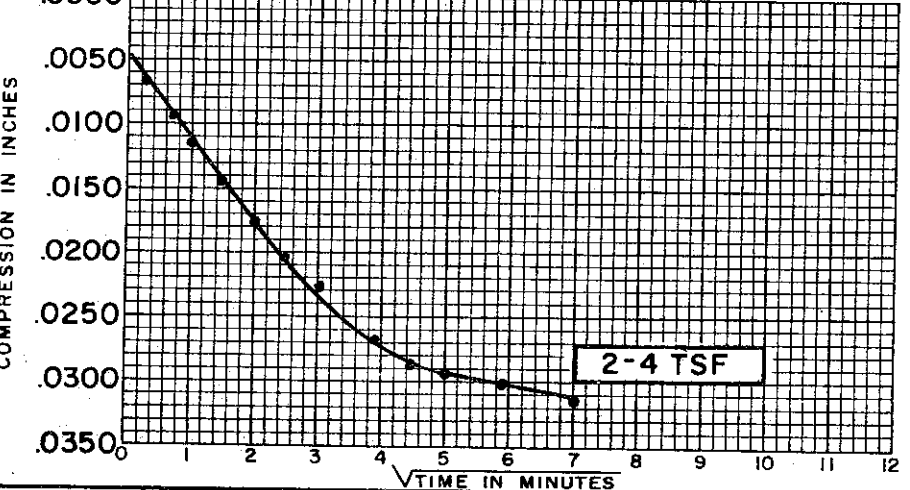
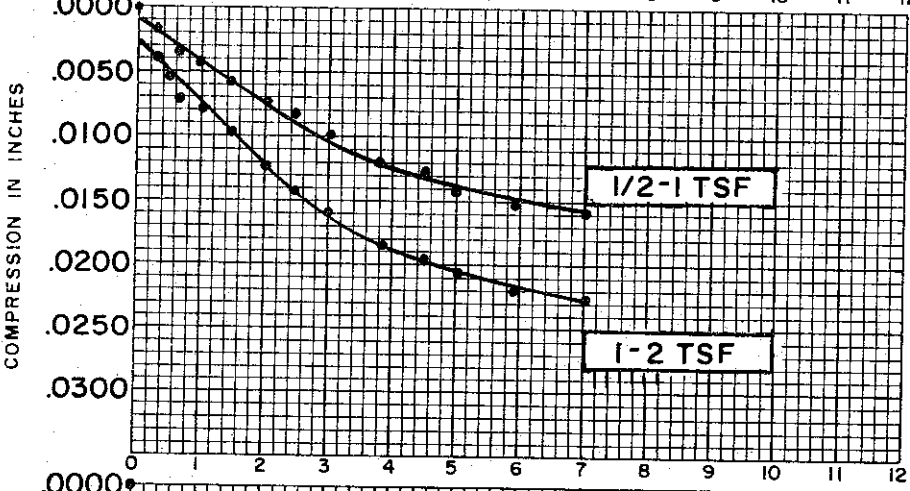
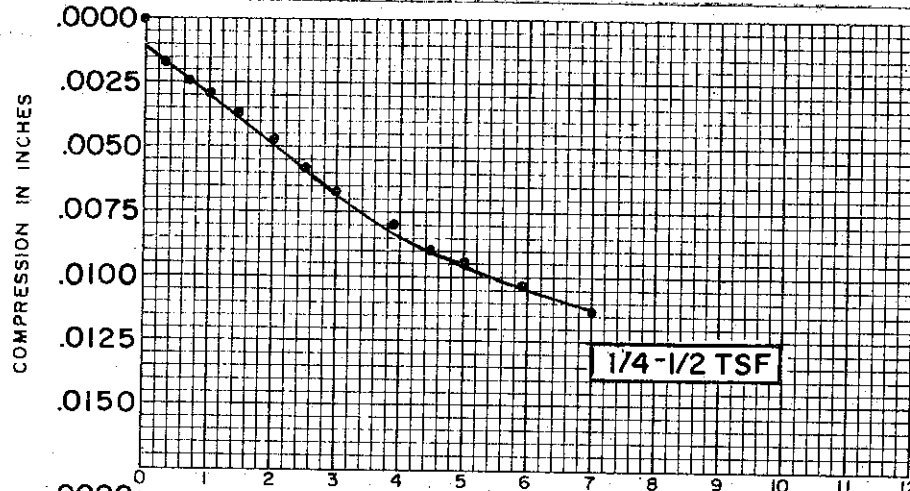

SOIL PROPERTIES

SOIL DESCRIPTION: SILTY
CLAY (CL-CH)
 SPECIFIC GRAVITY 2.75
 INITIAL WATER CONTENT 46.5%
 FINAL WATER CONTENT 31.9%

BORING NO. 41
 SAMPLE NO. 13
 DEPTH 53.0'

TEST DATA

INITIAL SAMPLE HEIGHT 0.75"
 INITIAL SAMPLE DIAMETER 2.50"
 INITIAL VOID RATIO 1.235

**CONSOLIDATION TEST
 TIME VS. COMPRESSION CURVES**

THE DETROIT EDISON COMPANY
 BELLE RIVER PLANT UNITS I & II

C-479

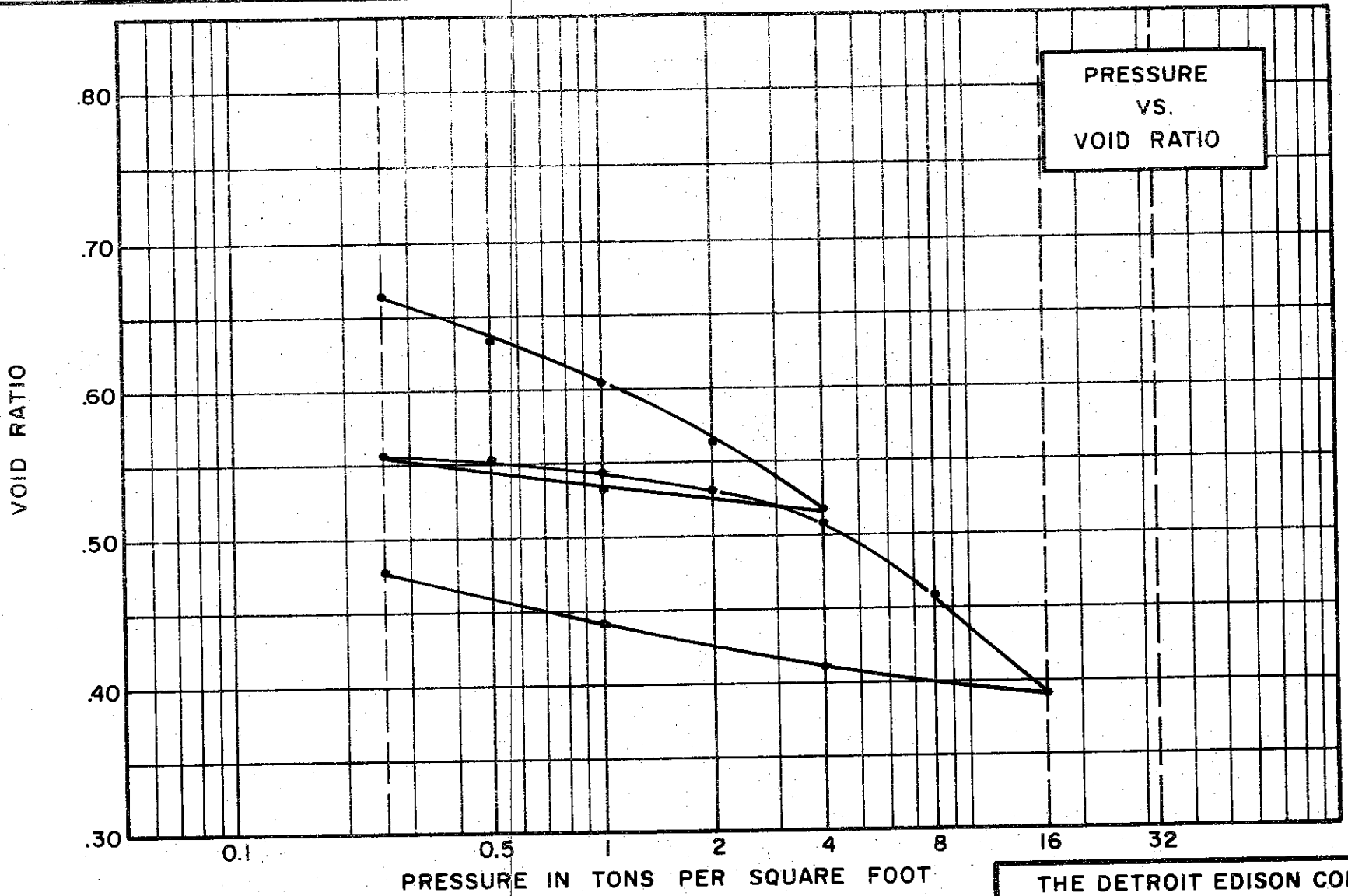

THE DETROIT EDISON COMPANY
 BELLE RIVER PLANT UNITS I & II

CONSOLIDATION TEST
 VOID RATIO VS. LOG PRESSURE

BORING NO. 41 TEST NO. C35.1
 SAMPLE NO. 17 DATE JAN. 1974
 DEPTH 73.5'

SOIL PROPERTIES

SOIL DESCRIPTION SILTY CLAY;
SANDY (CL)

SPECIFIC GRAVITY 2.68

WATER CONTENT, INITIAL 26.7% FINAL 19.7%

ATTERBERG LIMITS:
 LIQUID LIMIT 25% PLASTIC LIMIT 15%

TEST DATA

INITIAL SAMPLE HEIGHT 0.80"

INITIAL SAMPLE DIAMETER 2.50"

INITIAL VOID RATIO 0.697

COMPRESSION IN INCHES

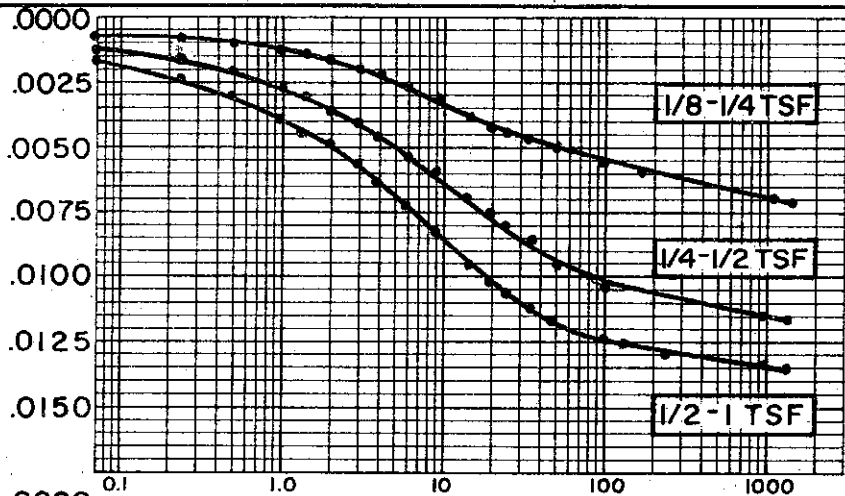

COMPRESSION IN INCHES

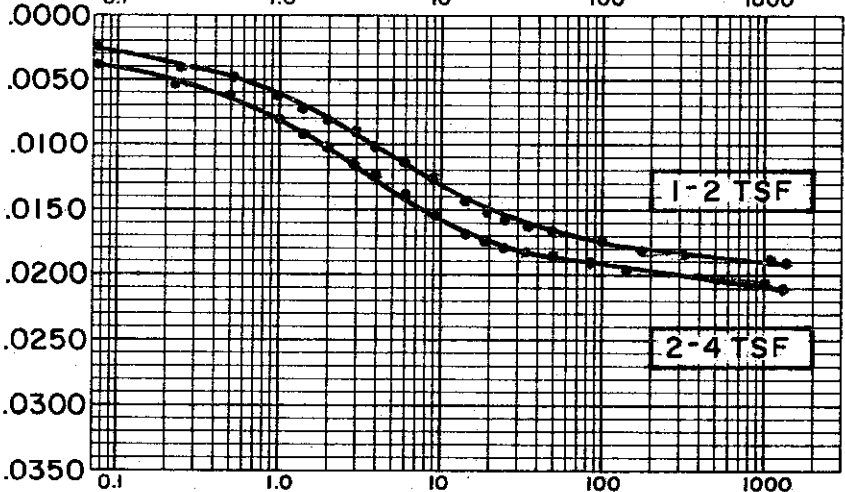

COMPRESSION IN INCHES

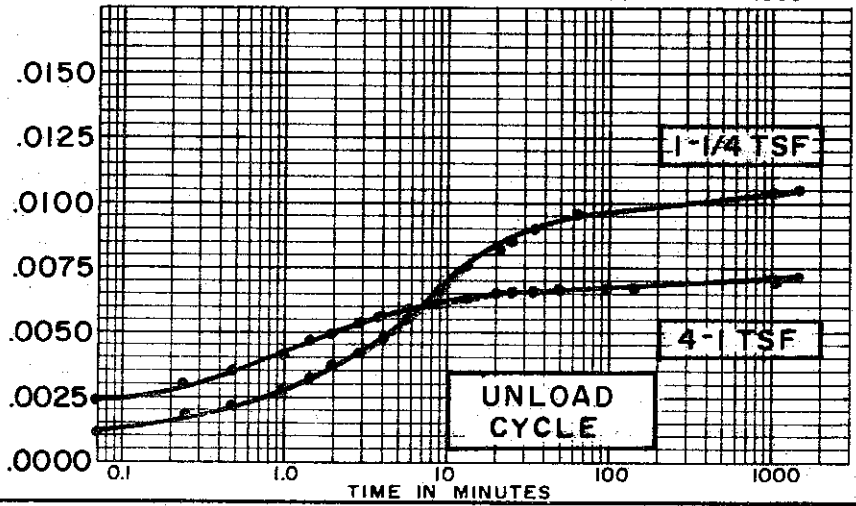

COMPRESSION IN INCHES

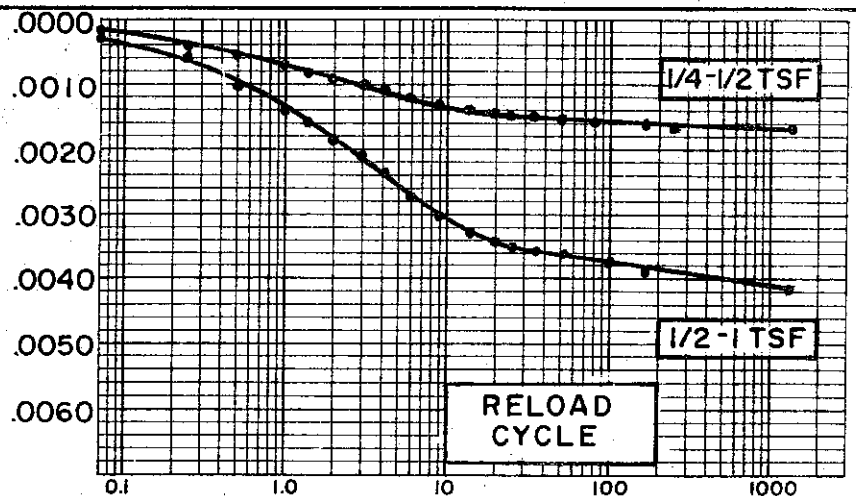

COMPRESSION IN INCHES

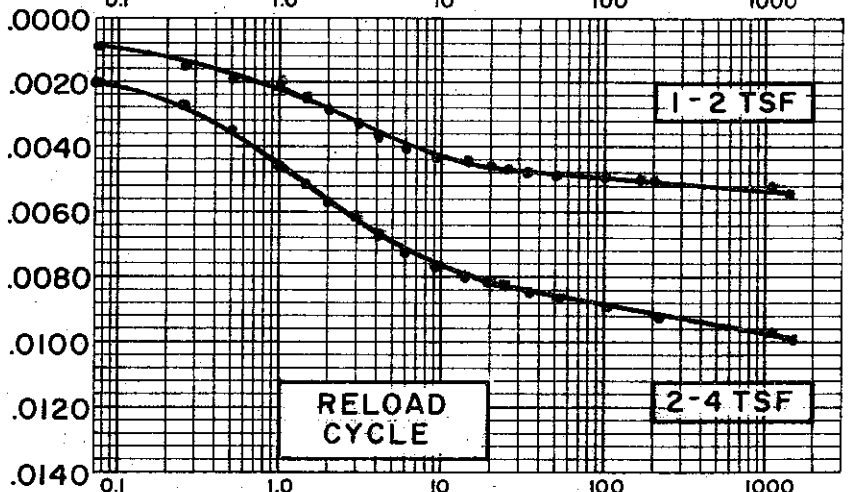

TIME IN MINUTES

SOIL PROPERTIES

SOIL DESCRIPTION: SILTY CLAY, SANDY (CL)
 SPECIFIC GRAVITY 2.68
 INITIAL WATER CONTENT 26.7%
 FINAL WATER CONTENT 19.7%

BORING NO. 41
 SAMPLE NO. 17
 DEPTH 73.5'

TEST DATA

INITIAL SAMPLE HEIGHT 0.80"
 INITIAL SAMPLE DI. METER 2.50"
 INITIAL VOID RATIO 0.697

**CONSOLIDATION TEST
TIME VS. COMPRESSION CURVES**

THE DETROIT EDISON COMPANY
 BELLE RIVER PLANT UNITS I & II

C-481

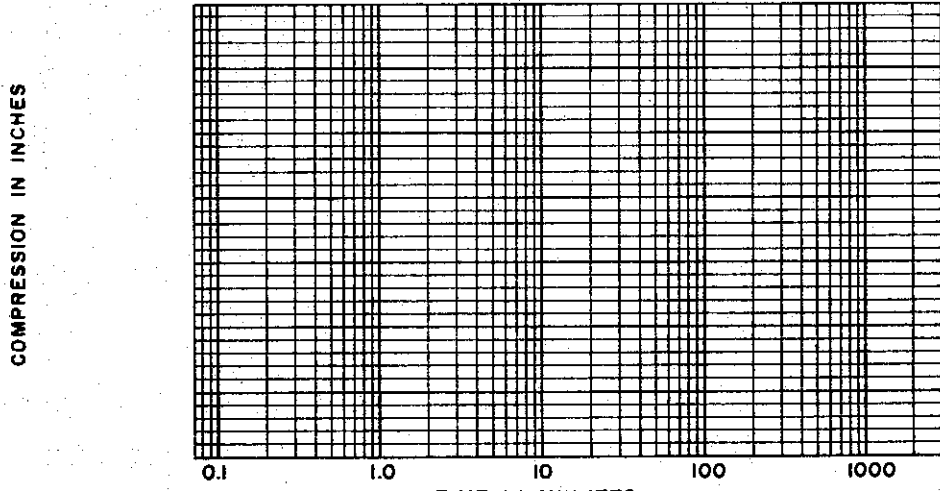
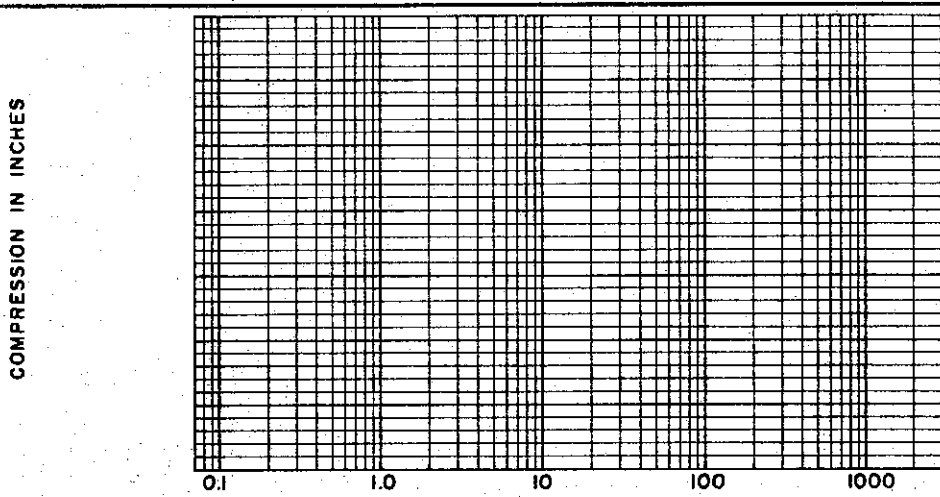
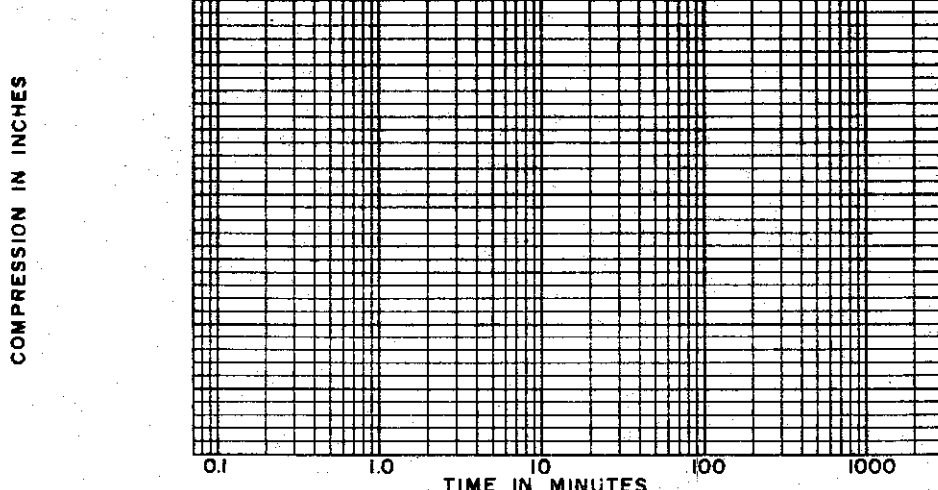
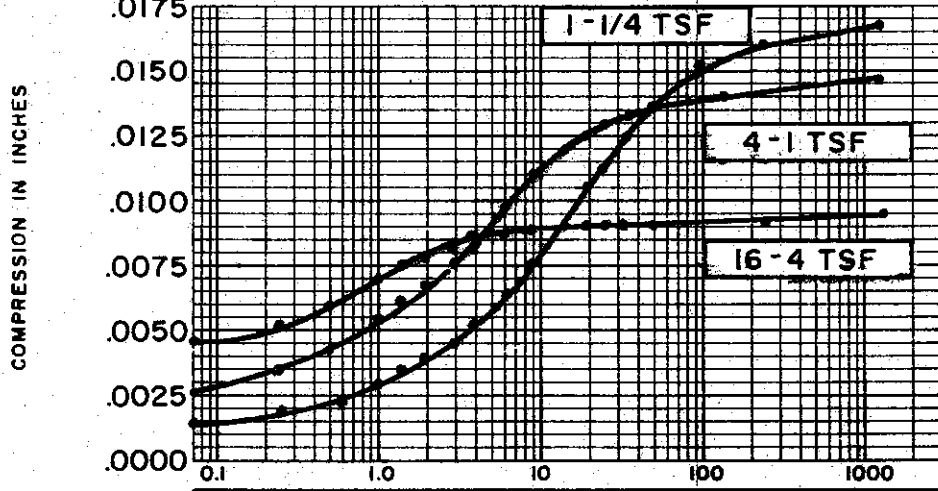
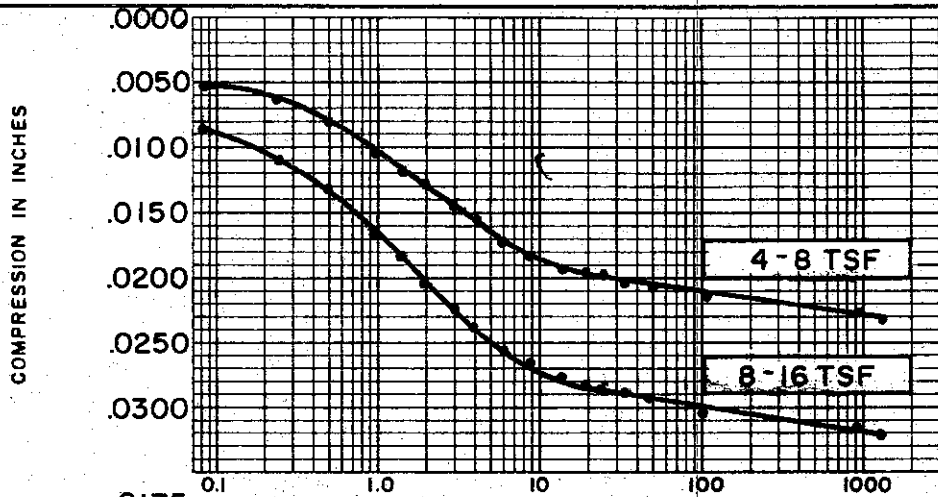

TIME IN MINUTES

SOIL PROPERTIES		BORING NO.	41
SOIL DESCRIPTION:	SILTY CLAY, SANDY (CL)	SAMPLE NO.	17
SPECIFIC GRAVITY	2.68	DEPTH	73.5
INITIAL WATER CONTENT	26.7%		
FINAL WATER CONTENT	19.7%		

TEST DATA	
INITIAL SAMPLE HEIGHT	0.80"
INITIAL SAMPLE DIAMETER	2.50"
INITIAL VOID RATIO	0.697

CONSOLIDATION TEST
 TIME VS. COMPRESSION CURVES
 THE DETROIT EDISON COMPANY
 BELLE RIVER PLANT UNITS I & II

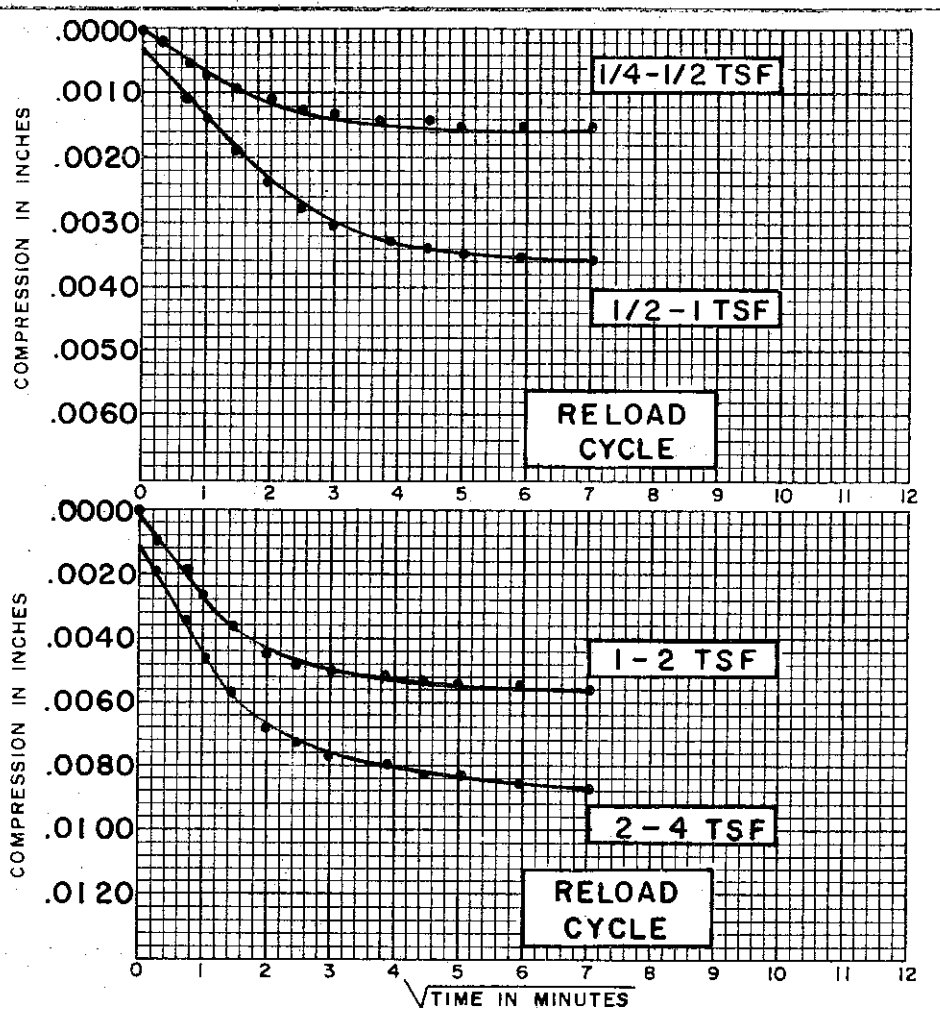
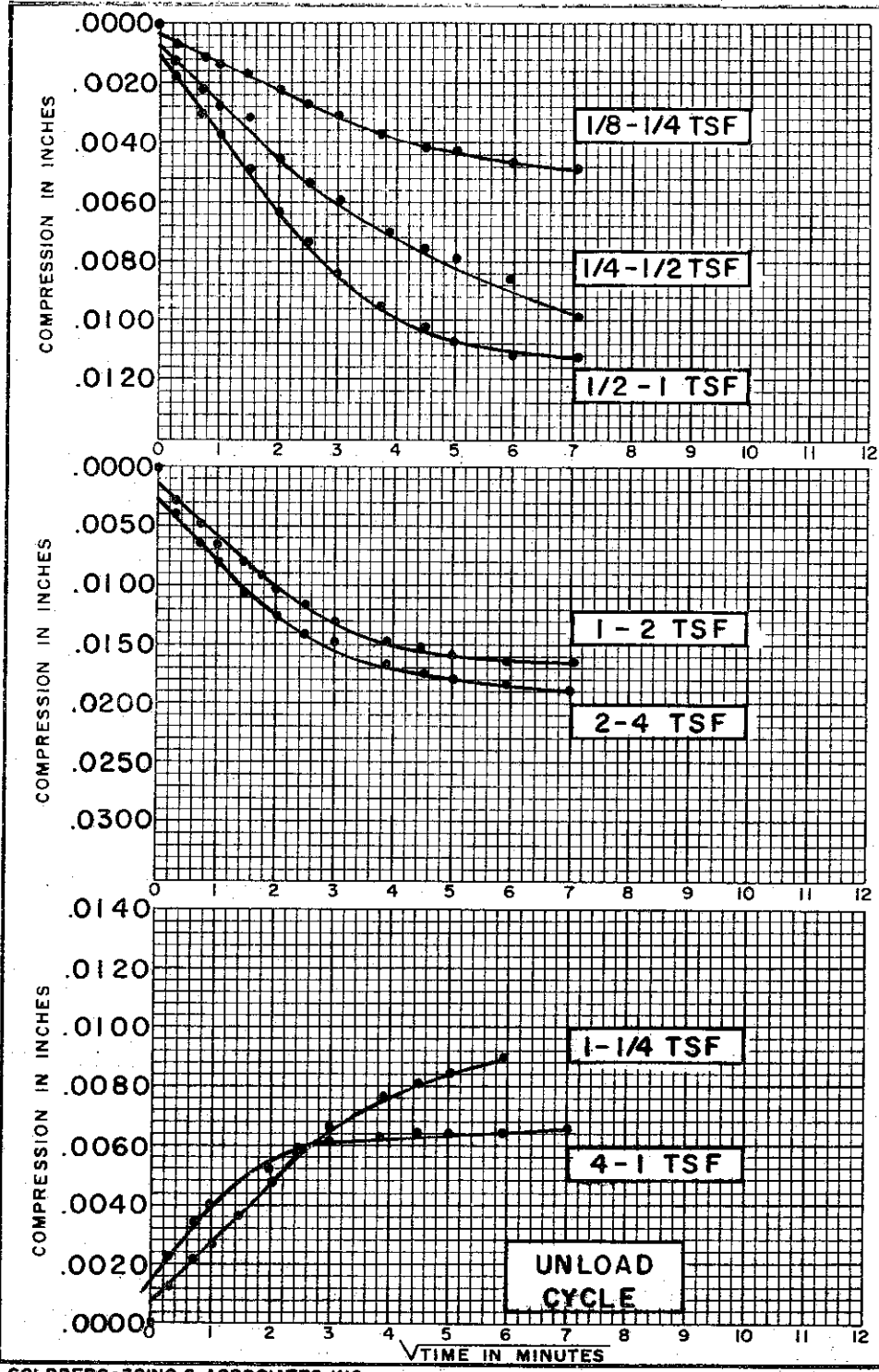

SOIL PROPERTIES	
SOIL DESCRIPTION:	SILTY CLAY, SANDY (CL)
SPECIFIC GRAVITY	2.68
INITIAL WATER CONTENT	26.7%
FINAL WATER CONTENT	19.7%
BORING NO.	41
SAMPLE NO.	17
DEPTH	73.5

TEST DATA	
INITIAL SAMPLE HEIGHT	0.80"
INITIAL SAMPLE DIAMETER	2.50"
INITIAL VOID RATIO	0.697

CONSOLIDATION TEST
 TIME VS. COMPRESSION CURVES
 THE DETROIT EDISON COMPANY
 BELLE RIVER PLANT UNITS I & II

C-483

787-484

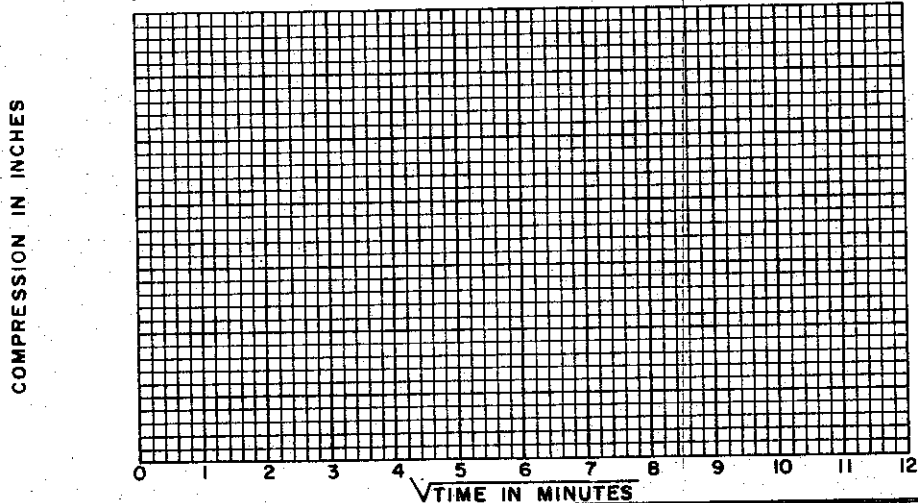
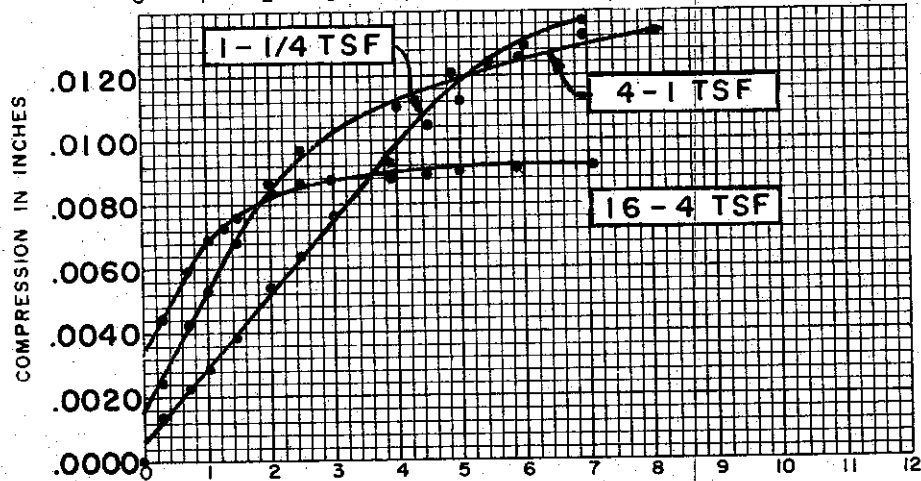
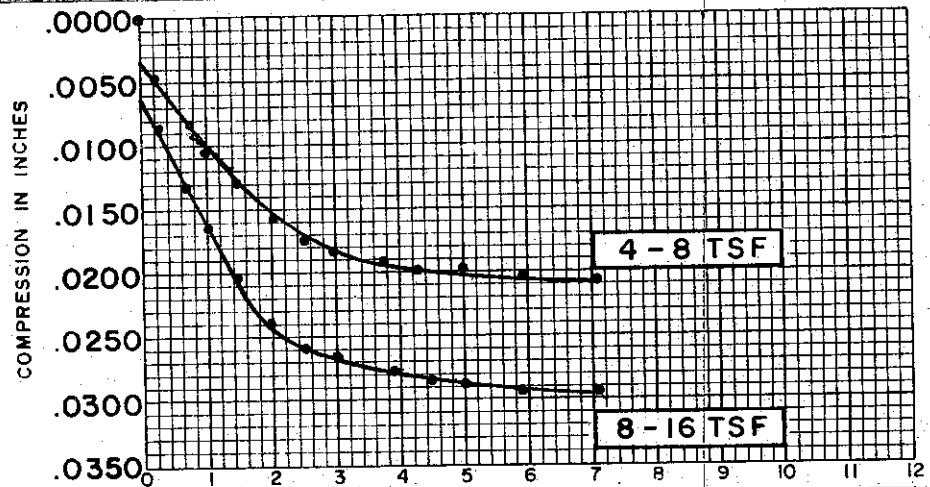

COMPRESSION IN INCHES

COMPRESSION IN INCHES

COMPRESSION IN INCHES

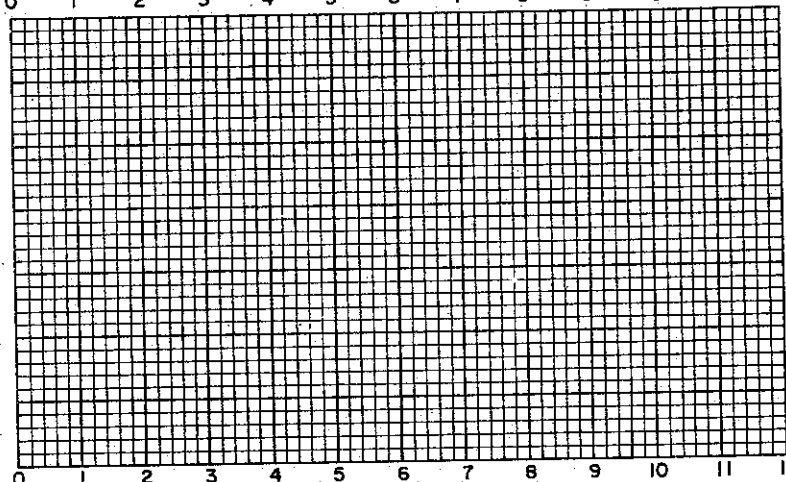
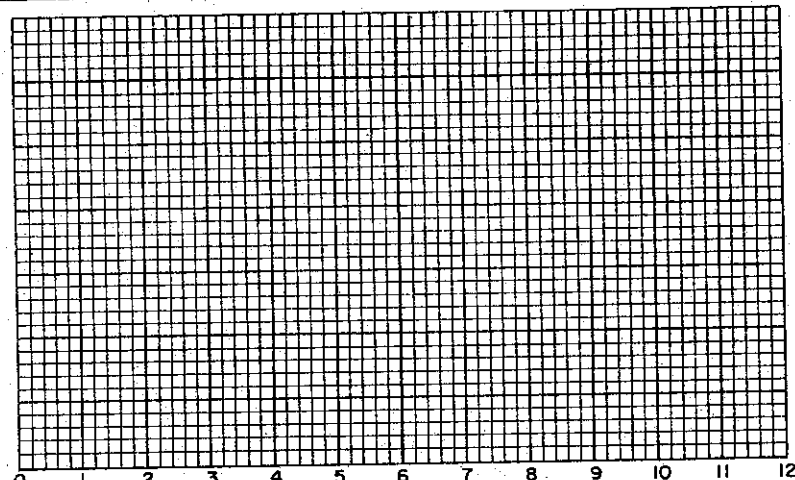

√TIME IN MINUTES

SOIL PROPERTIES

SOIL DESCRIPTION: SILTY CLAY, SANDY (CL)
 SPECIFIC GRAVITY 2.68
 INITIAL WATER CONTENT 26.7 %
 FINAL WATER CONTENT 19.7 %

BORING NO. 41
 SAMPLE NO. 17
 DEPTH 73.5

TEST DATA

INITIAL SAMPLE HEIGHT 0.80"
 INITIAL SAMPLE DIAMETER 2.50"
 INITIAL VOID RATIO 0.697

**CONSOLIDATION TEST
 TIME VS. COMPRESSION CURVES**

THE DETROIT EDISON COMPANY
 BELLE RIVER PLANT UNITS I & II

FILE 1255

PRESSURE
VS.
VOID RATIO

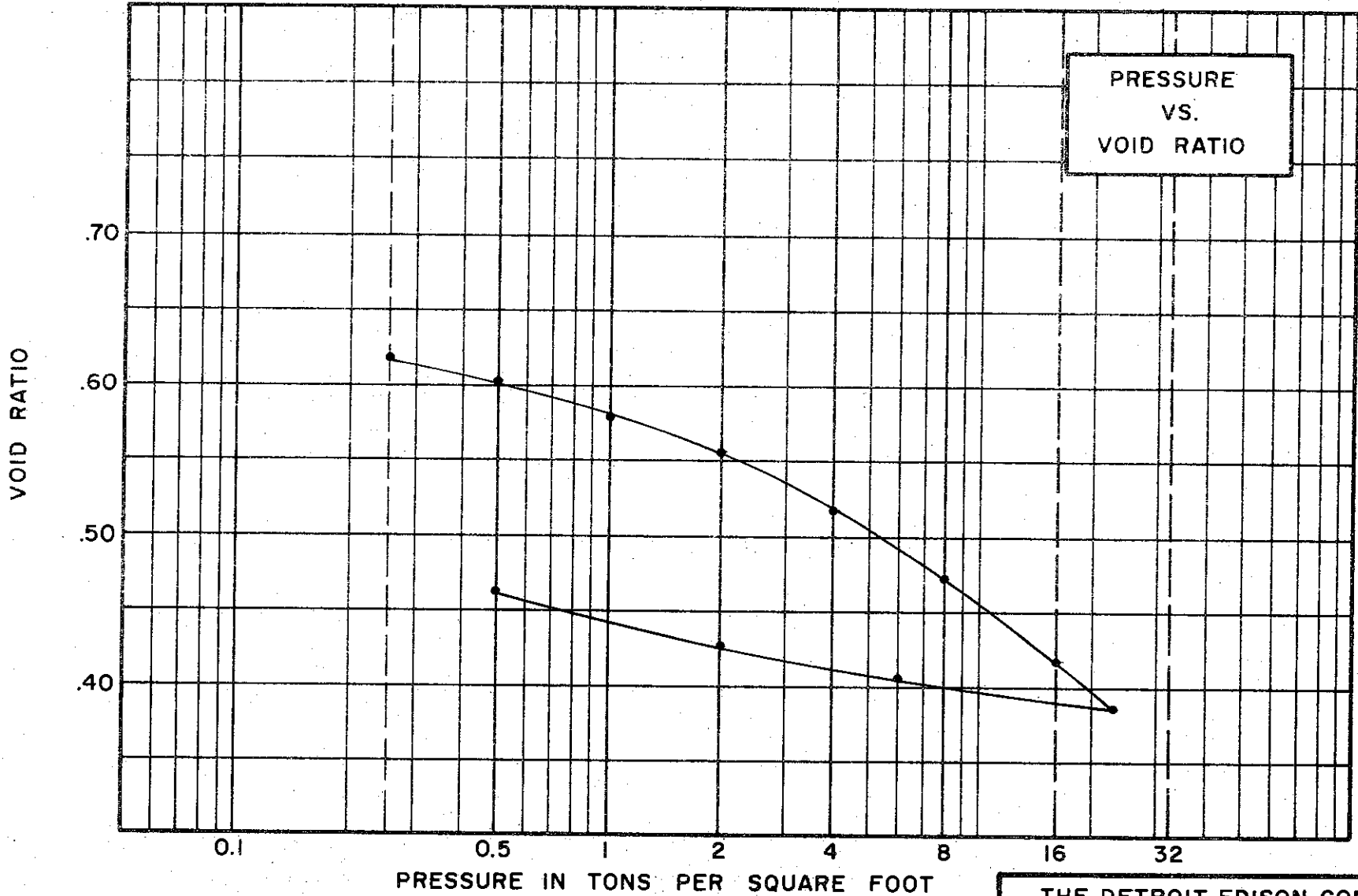

SOIL PROPERTIES

SOIL DESCRIPTION SILTY
CLAY, SANDY (CL)
SPECIFIC GRAVITY 2.71
WATER CONTENT, INITIAL 24.2% FINAL 19.4%
ATTERBERG LIMITS:
LIQUID LIMIT 29% PLASTIC LIMIT 19%

TEST DATA

INITIAL SAMPLE HEIGHT 0.75"
INITIAL SAMPLE DIAMETER 2.50"
INITIAL VOID RATIO 0.642

THE DETROIT EDISON COMPANY
BELLE RIVER PLANT UNITS I & II

CONSOLIDATION TEST
VOID RATIO VS. LOG PRESSURE

BORING NO. 41 TEST NO. C38.1
SAMPLE NO. 25 DATE JAN. 1974
DEPTH 113'

C-485

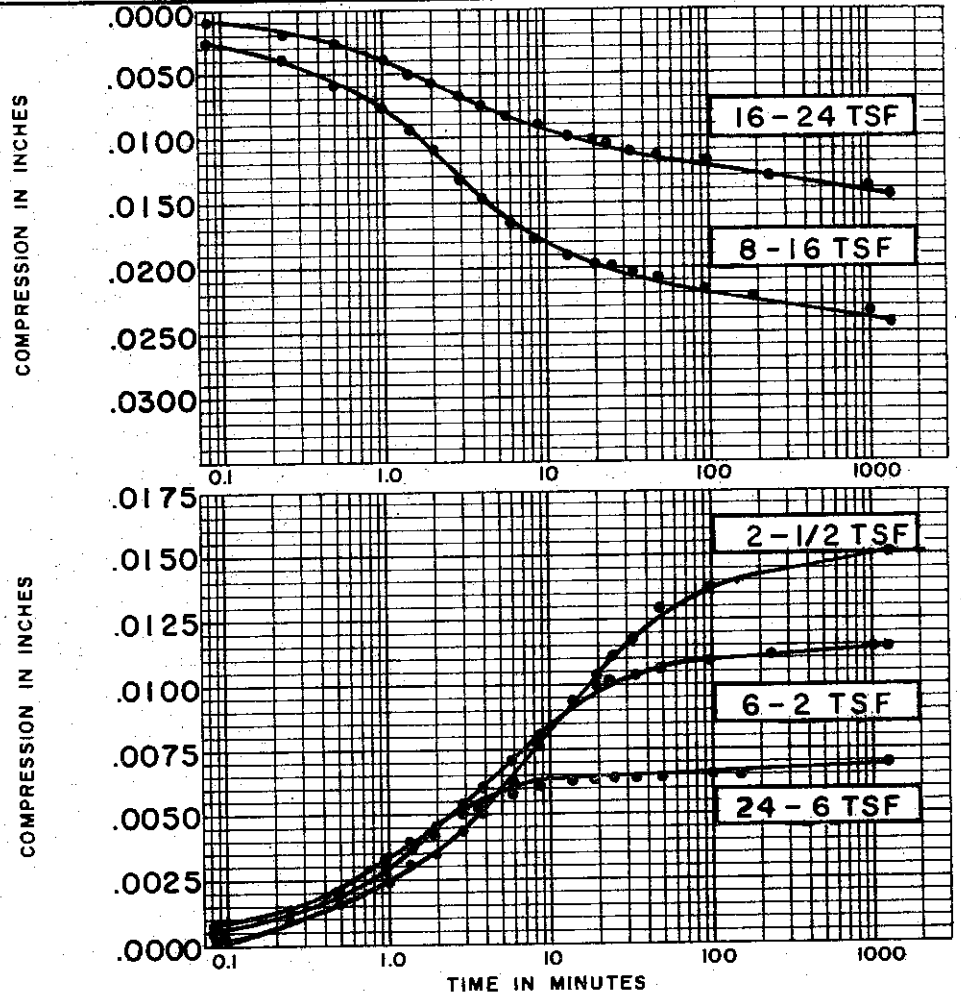
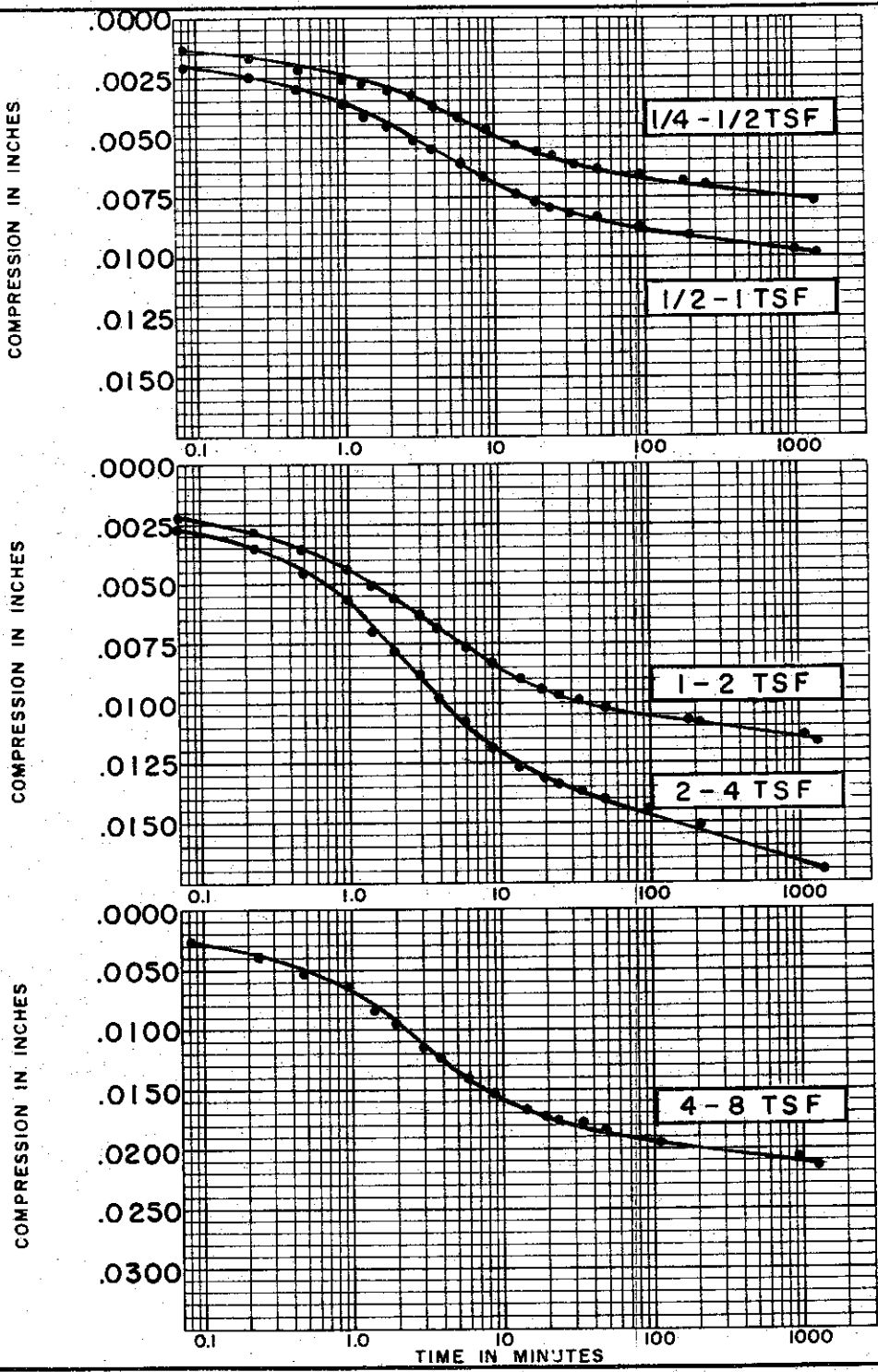

SOIL PROPERTIES

SOIL DESCRIPTION: SILTY CLAY, SANDY (CL)

SPECIFIC GRAVITY 2.71

INITIAL WATER CONTENT 24.2 %

FINAL WATER CONTENT 19.4 %

BORING NO. 41

SAMPLE NO. 25

DEPTH 113'

TEST DATA

INITIAL SAMPLE HEIGHT 0.75"

INITIAL SAMPLE DIAMETER 2.50"

INITIAL VOID RATIO 0.642

**CONSOLIDATION TEST
TIME VS. COMPRESSION CURVE**

THE DETROIT EDISON COMPANY
BELLE RIVER PLANT UNITS I & II

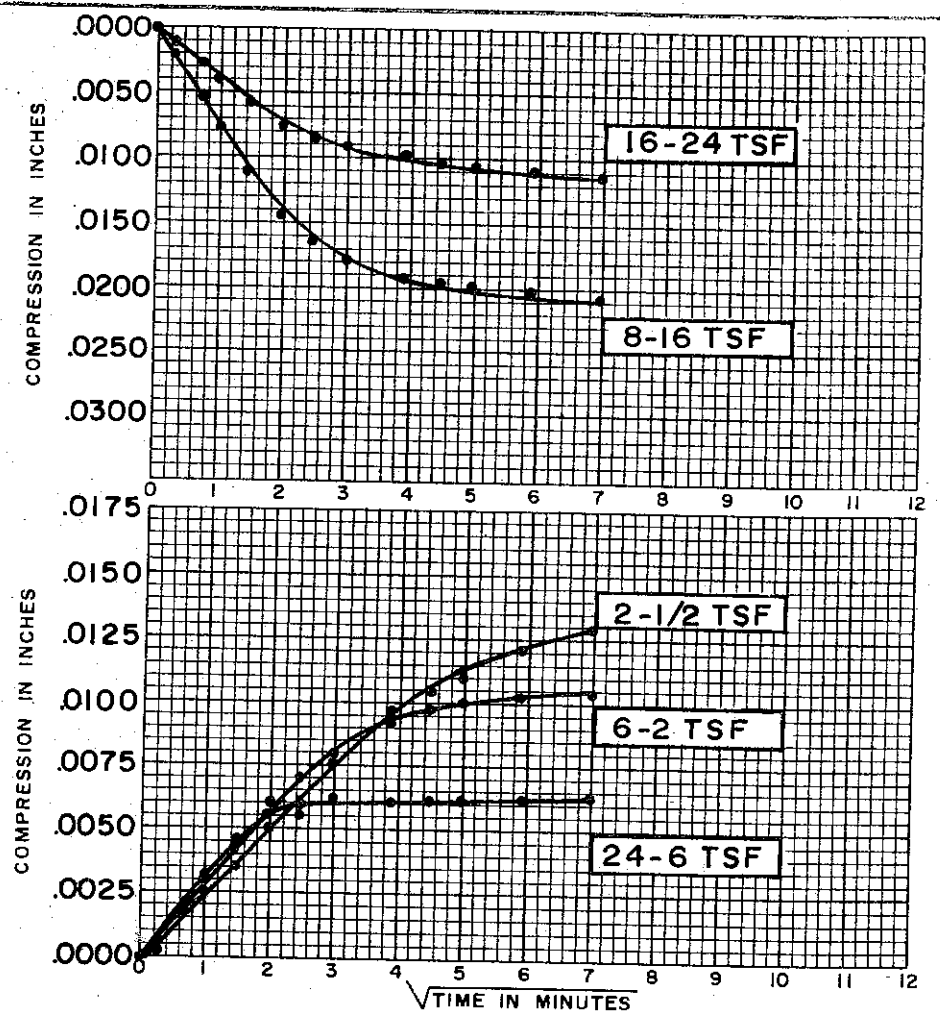
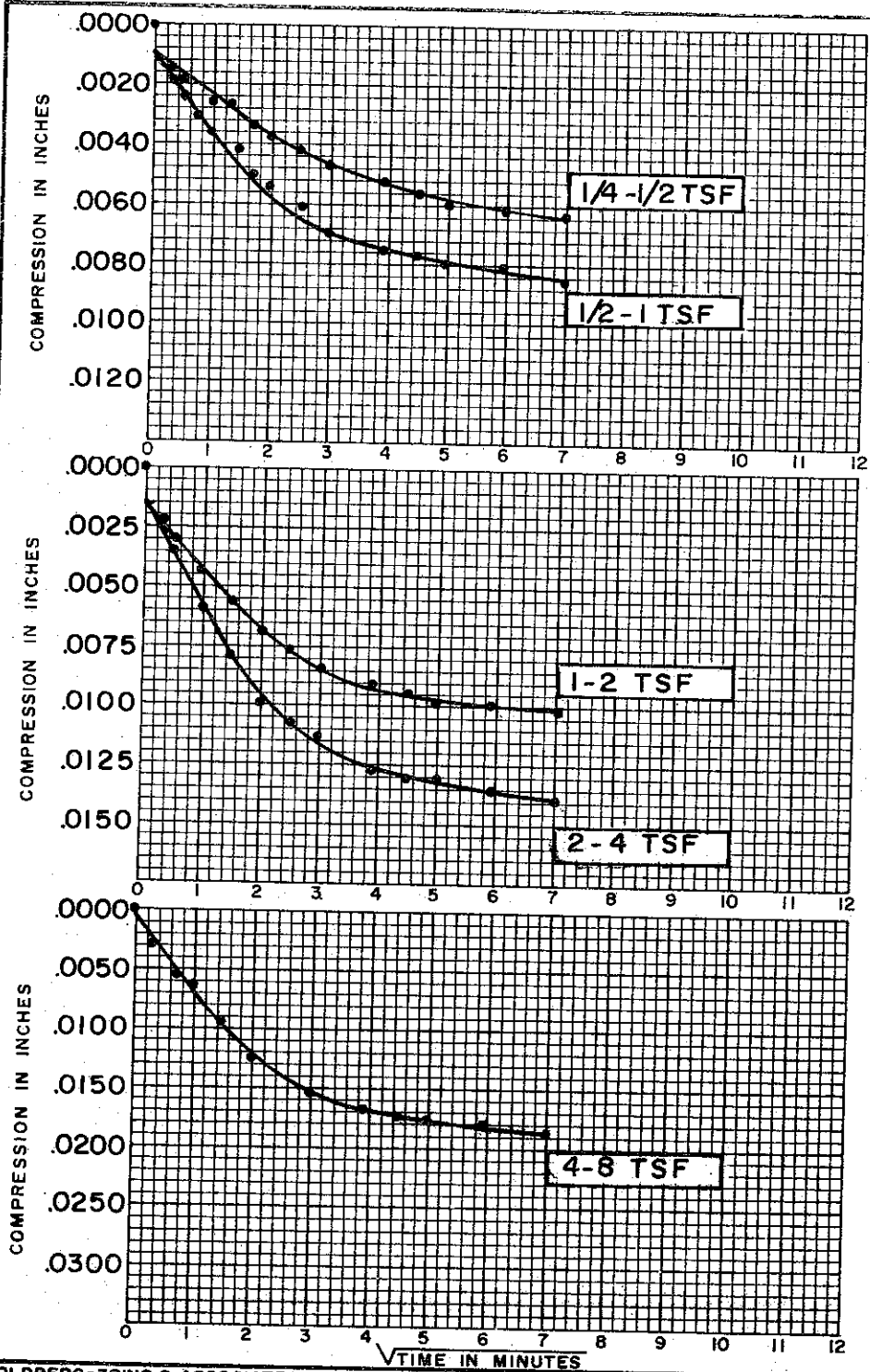

SOIL PROPERTIES

SOIL DESCRIPTION: SILTY
CLAY, SANDY (CL)
 SPECIFIC GRAVITY 2.71
 INITIAL WATER CONTENT 24.2%
 FINAL WATER CONTENT 19.4%

BORING NO. 41
 SAMPLE NO. 25
 DEPTH 113'

TEST DATA

INITIAL SAMPLE HEIGHT 0.75"
 INITIAL SAMPLE DIAMETER 2.50"
 INITIAL VOID RATIO 0.642

**CONSOLIDATION TEST
 TIME VS. COMPRESSION CURVES**

THE DETROIT EDISON COMPANY
 BELLE RIVER PLANT UNITS I & II

G-487

VOID RATIO

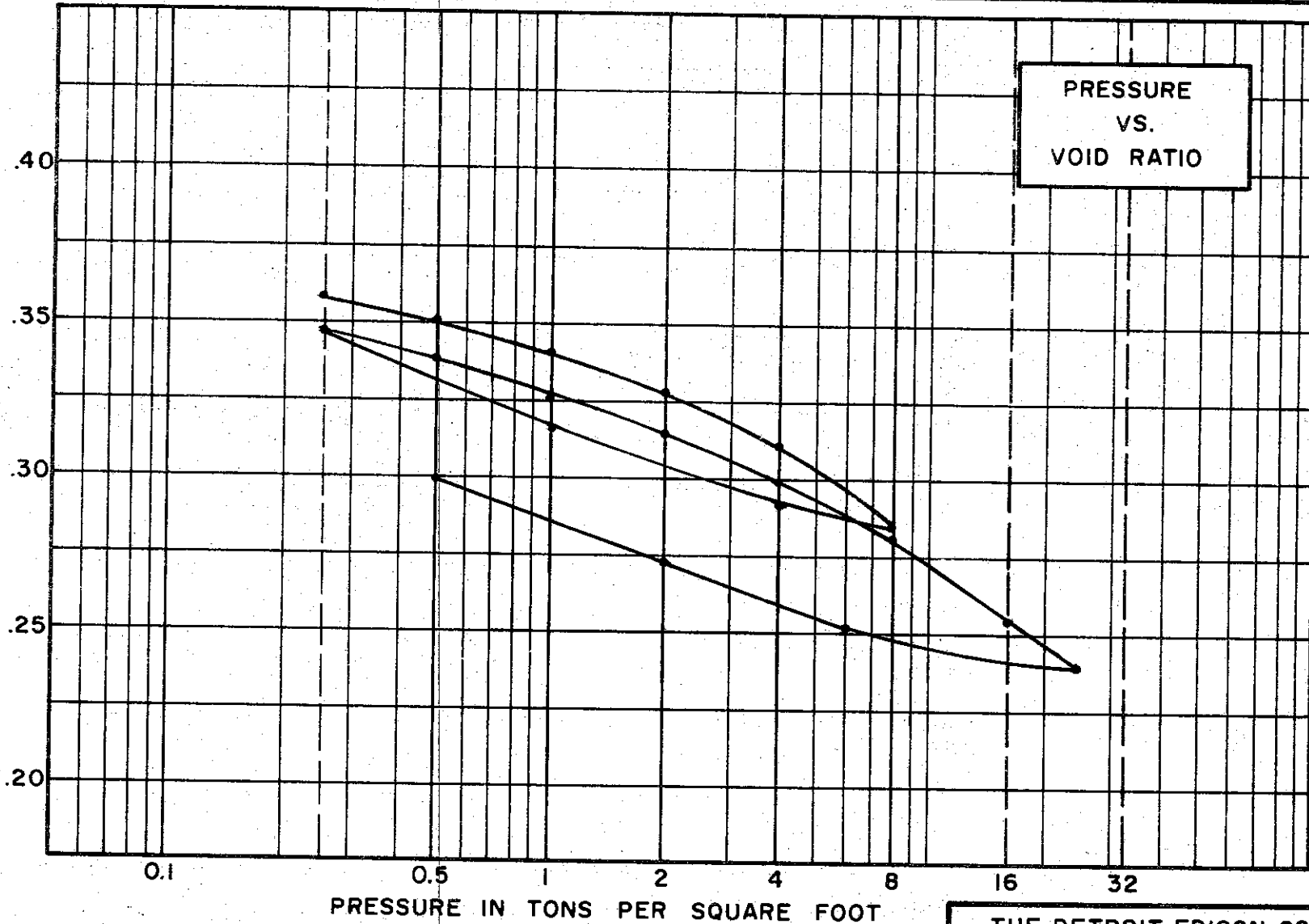

SOIL PROPERTIES

SOIL DESCRIPTION CLAYEY SAND, GRAVELLY (GC-SC)
 SPECIFIC GRAVITY 2.69
 WATER CONTENT, INITIAL 11.3% FINAL 12.0%
 ATTERBERG LIMITS:
 LIQUID LIMIT 25 % PLASTIC LIMIT 17 %

TEST DATA

INITIAL SAMPLE HEIGHT 0.80"
 INITIAL SAMPLE DIAMETER 2.50"
 INITIAL VOID RATIO 0.370

THE DETROIT EDISON COMPANY
 BELLE RIVER PLANT UNITS I & II

**CONSOLIDATION TEST
 VOID RATIO VS. LOG PRESSURE**

BORING NO. 41 TEST NO. C4C.1
 SAMPLE NO. 29 DATE FEB. 1974
 DEPTH 130.8'

COMPRESSION IN INCHES

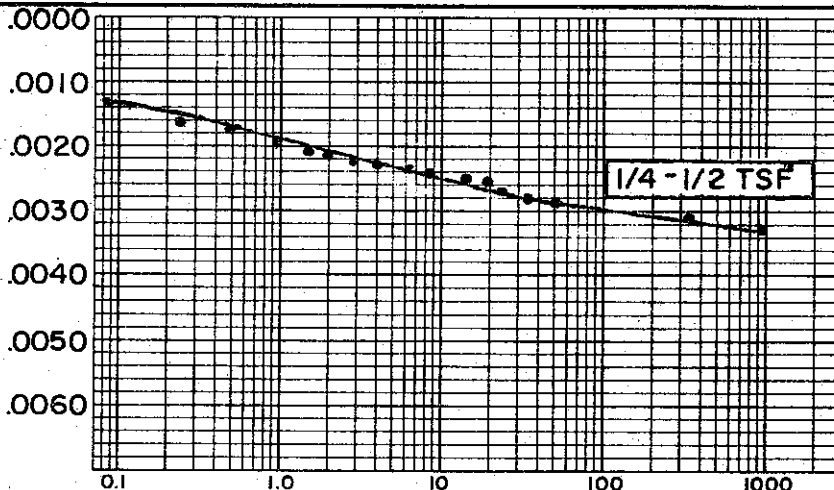

COMPRESSION IN INCHES

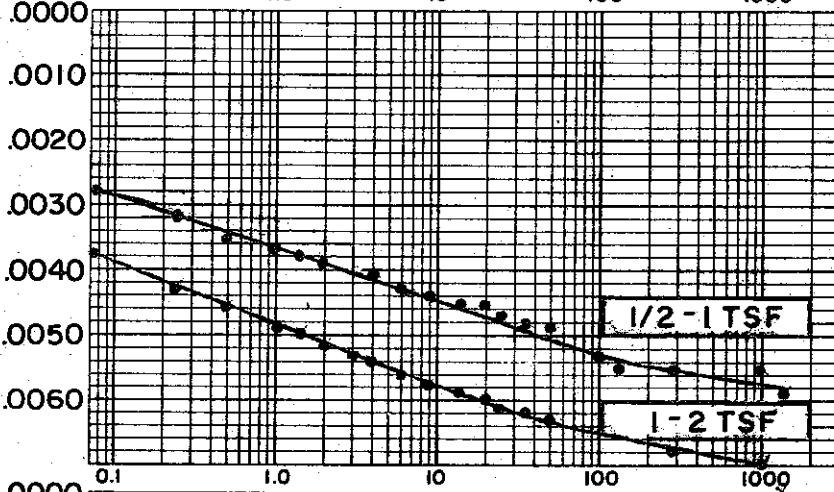

COMPRESSION IN INCHES

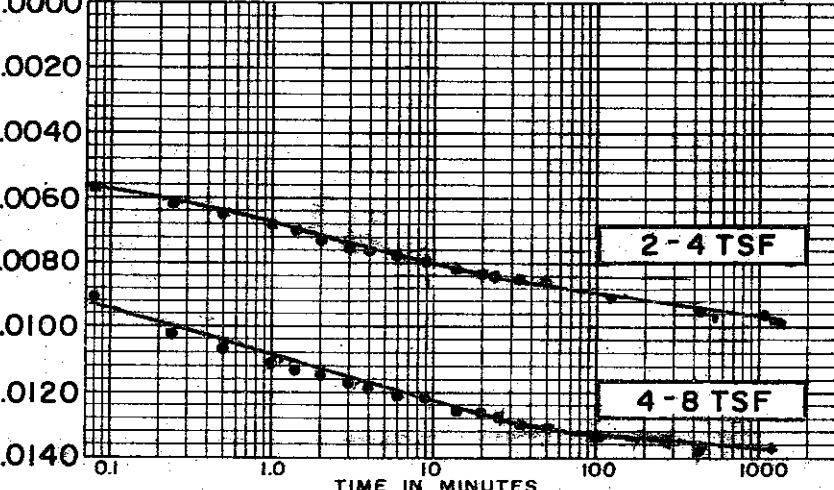

COMPRESSION IN INCHES

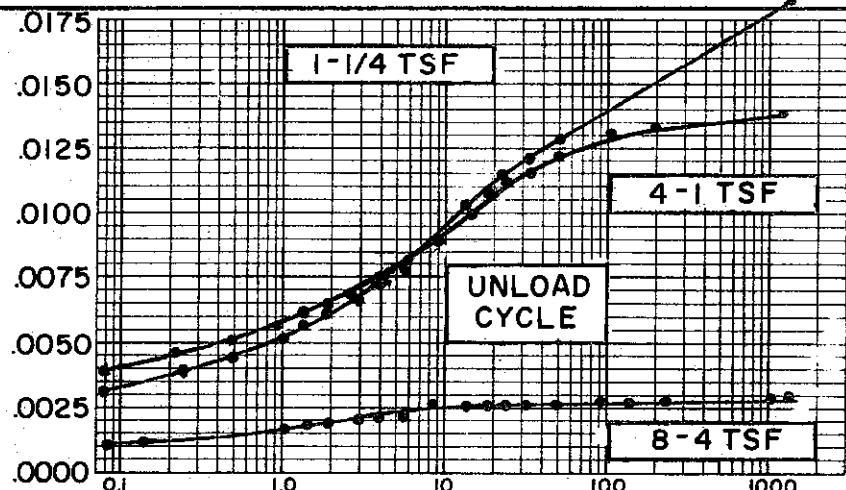

COMPRESSION IN INCHES

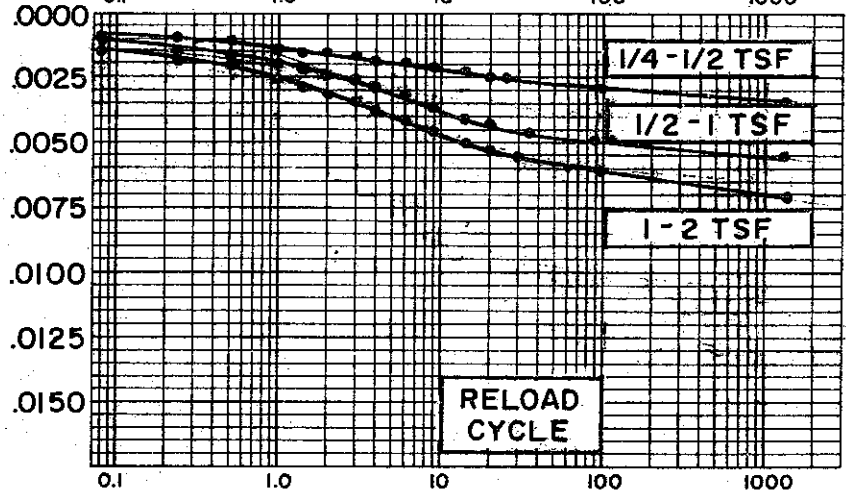

TIME IN MINUTES

SOIL PROPERTIES	
SOIL DESCRIPTION:	CLAYEY SAND, GRAVELLY (GC-SC)
SPECIFIC GRAVITY	2.69
INITIAL WATER CONTENT	11.3%
FINAL WATER CONTENT	12.0%
BORING NO.	41
SAMPLE NO.	29
DEPTH	130.8'

TEST DATA	
INITIAL SAMPLE HEIGHT	0.80"
INITIAL SAMPLE DIAMETER	2.50"
INITIAL VOID RATIO	.370

CONSOLIDATION TEST
TIME VS. COMPRESSION CURVES
THE DETROIT EDISON COMPANY
BELLE RIVER PLANT UNITS I & II

C-489

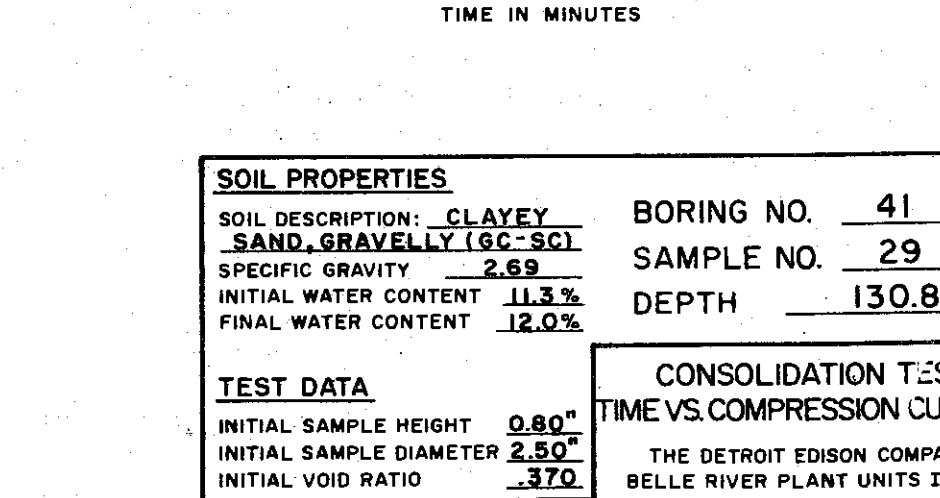
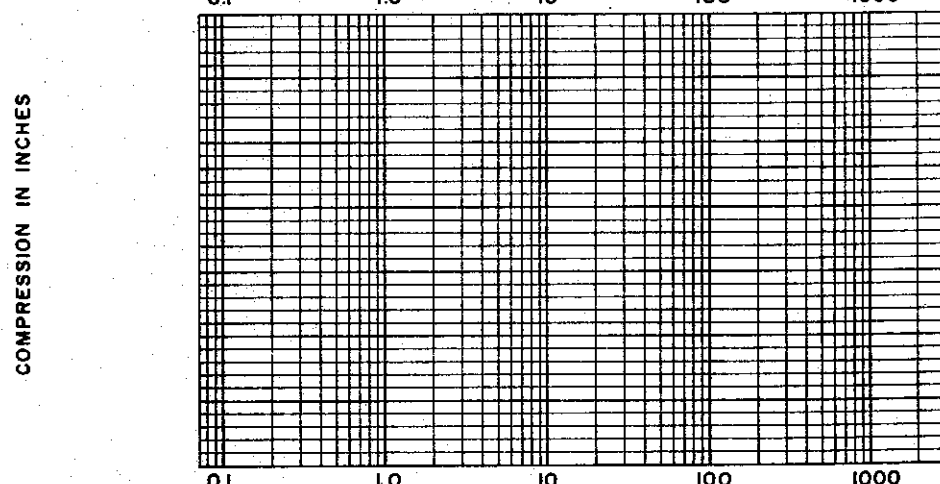
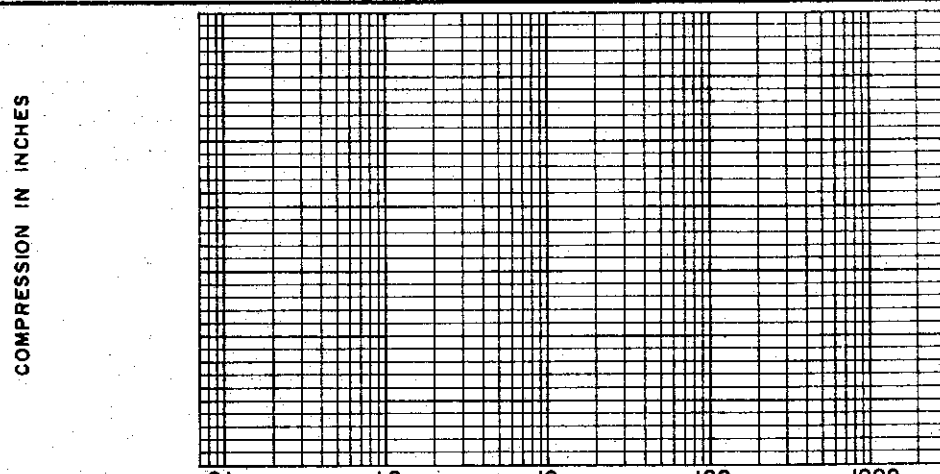
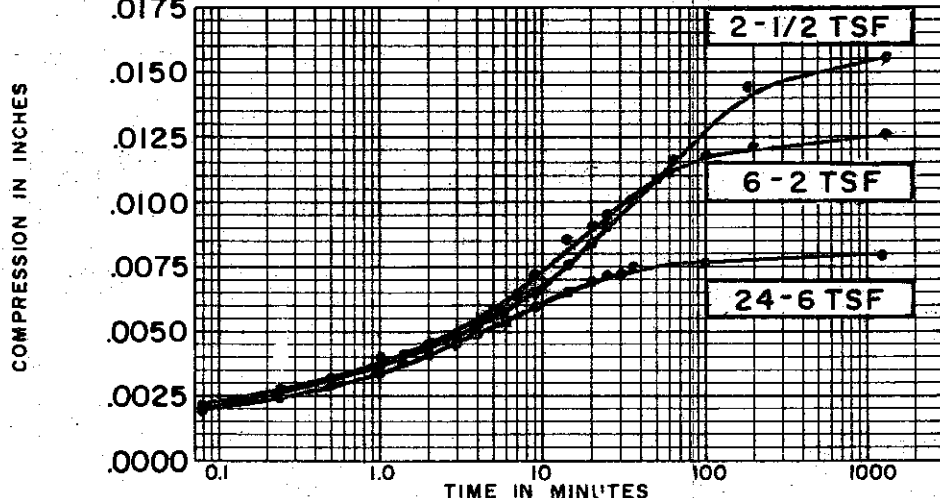
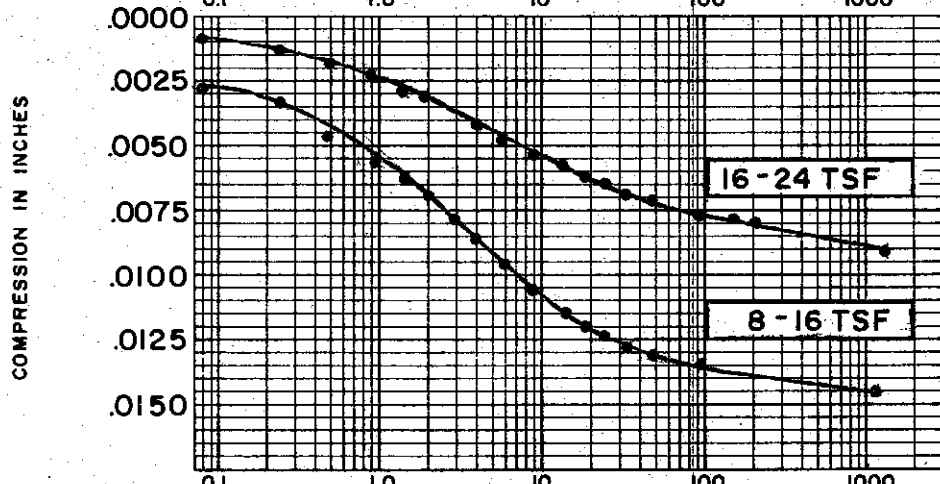
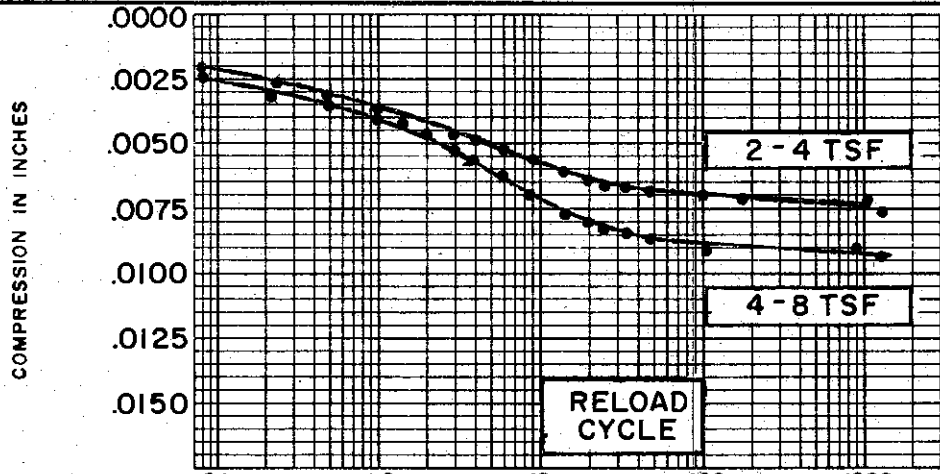

SOIL PROPERTIES	
SOIL DESCRIPTION:	CLAYEY SAND, GRAVELLY (GC-SC)
SPECIFIC GRAVITY	2.69
INITIAL WATER CONTENT	11.3%
FINAL WATER CONTENT	12.0%
BORING NO.	41
SAMPLE NO.	29
DEPTH	130.8'

TEST DATA	
INITIAL SAMPLE HEIGHT	0.80"
INITIAL SAMPLE DIAMETER	2.50"
INITIAL VOID RATIO	.370

CONSOLIDATION TEST
 TIME VS. COMPRESSION CURVES
 THE DETROIT EDISON COMPANY
 BELLE RIVER PLANT UNITS I & II
 FILE 1255

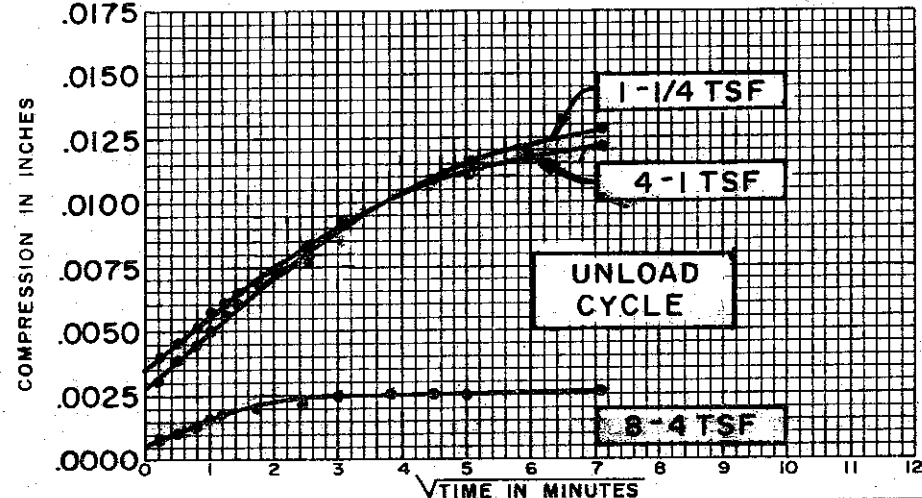
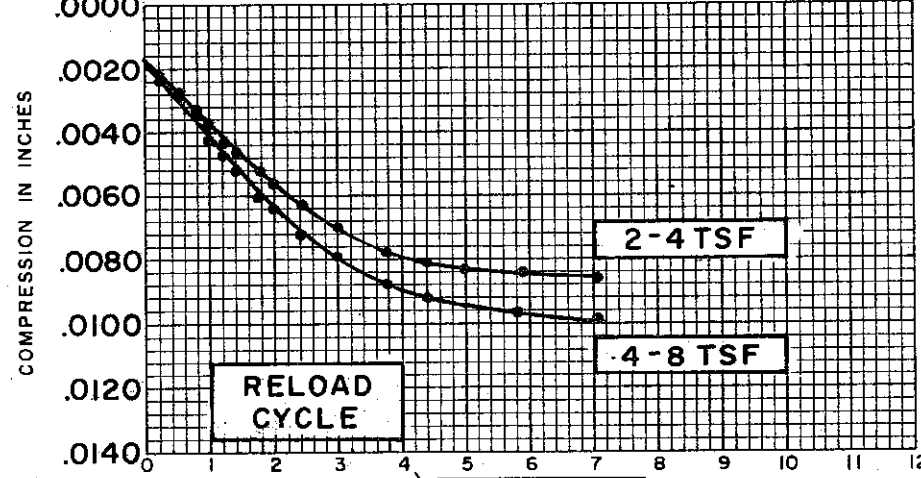
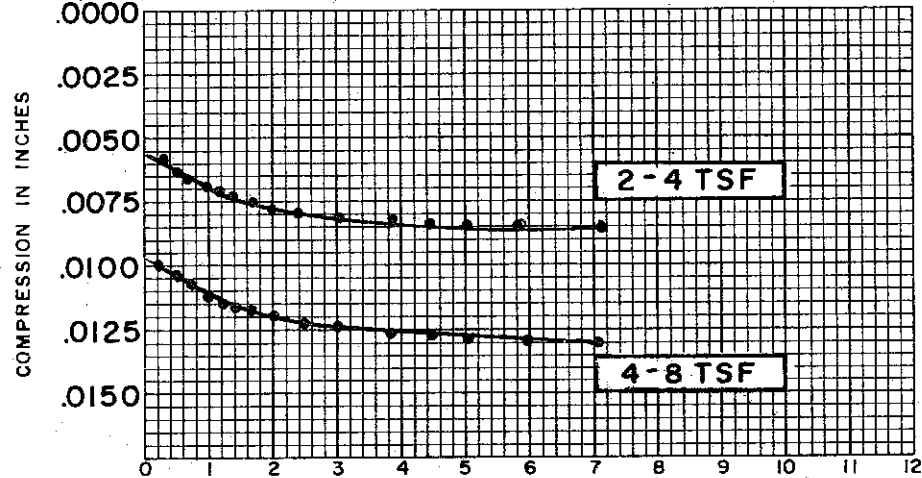
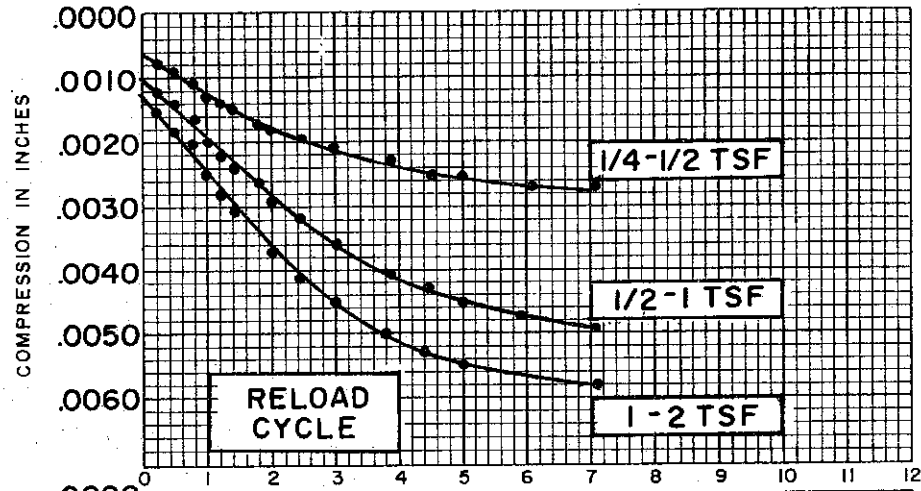
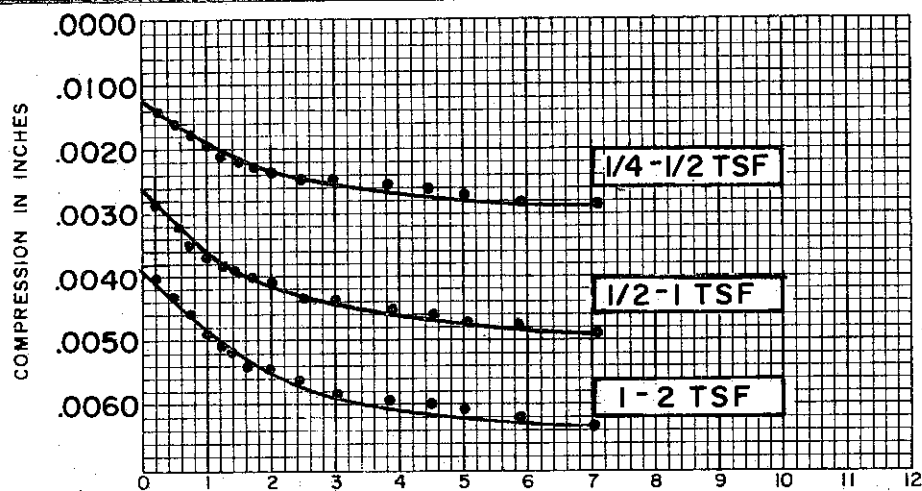

SOIL PROPERTIES	
SOIL DESCRIPTION:	CLAYEY SAND, GRAVELLY (GC-SC)
SPECIFIC GRAVITY	2.69
INITIAL WATER CONTENT	11.3%
FINAL WATER CONTENT	12.0%
BORING NO.	41
SAMPLE NO.	29
DEPTH	130.8'
TEST DATA	
INITIAL SAMPLE HEIGHT	0.80"
INITIAL SAMPLE DIAMETER	2.50"
INITIAL VOID RATIO	.370
CONSOLIDATION TEST TIME VS. COMPRESSION CURVES	
THE DETROIT EDISON COMPANY BELLE RIVER PLANT UNITS I & II	

C-491

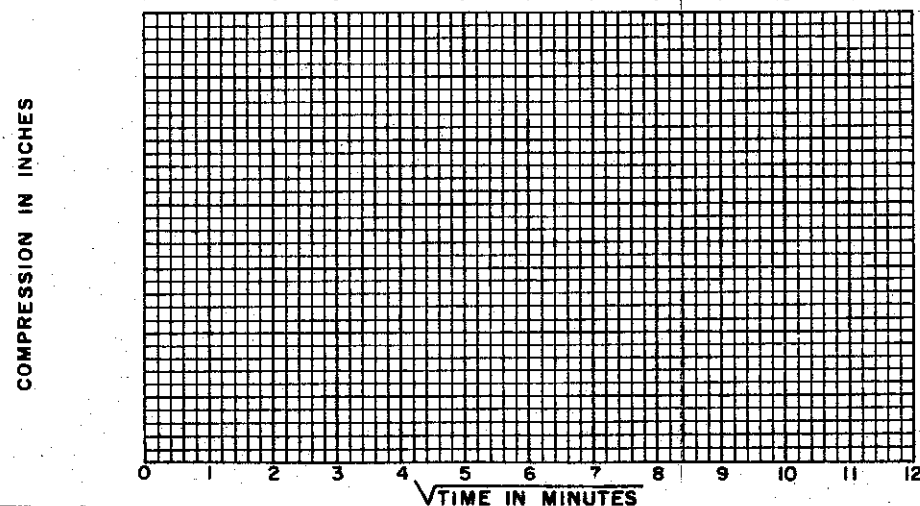
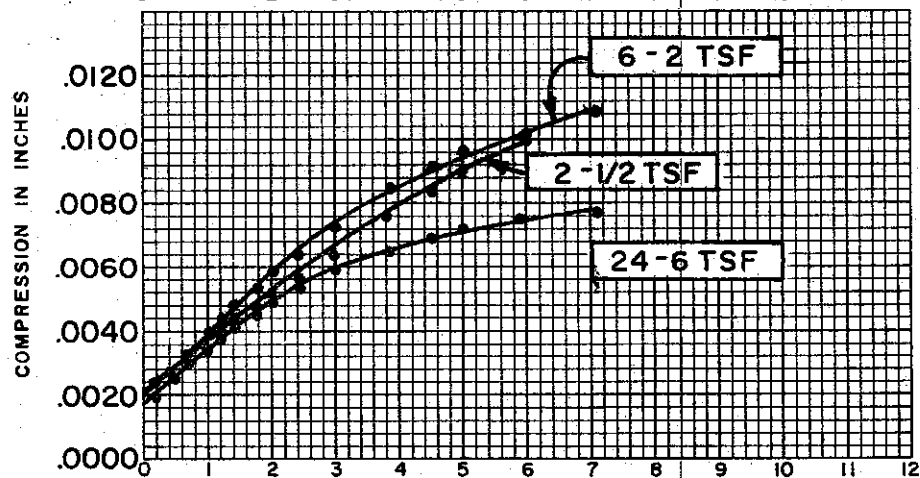
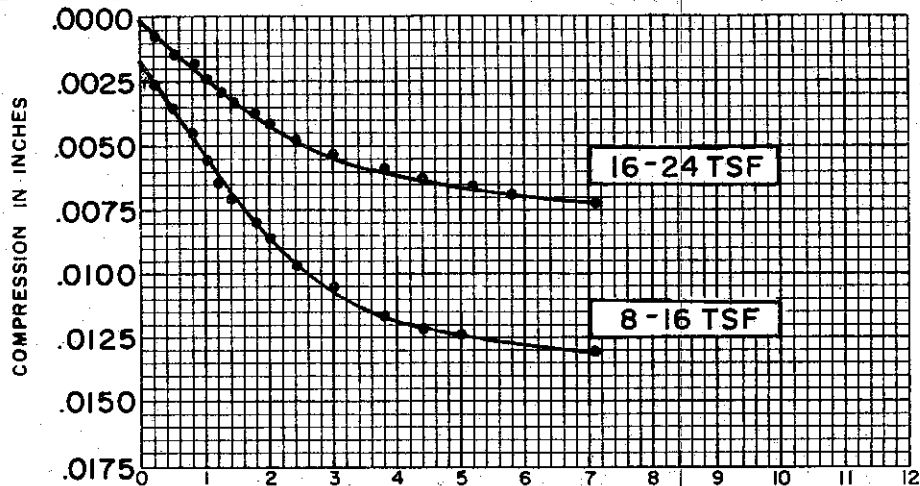

COMPRESSION IN INCHES

COMPRESSION IN INCHES

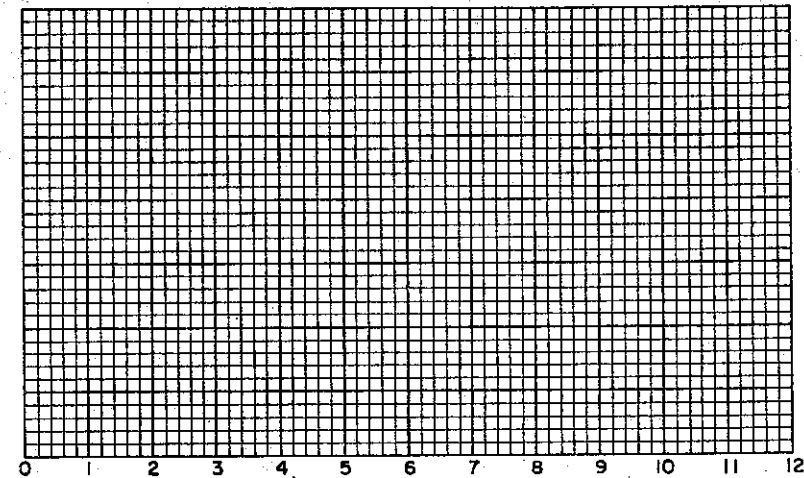
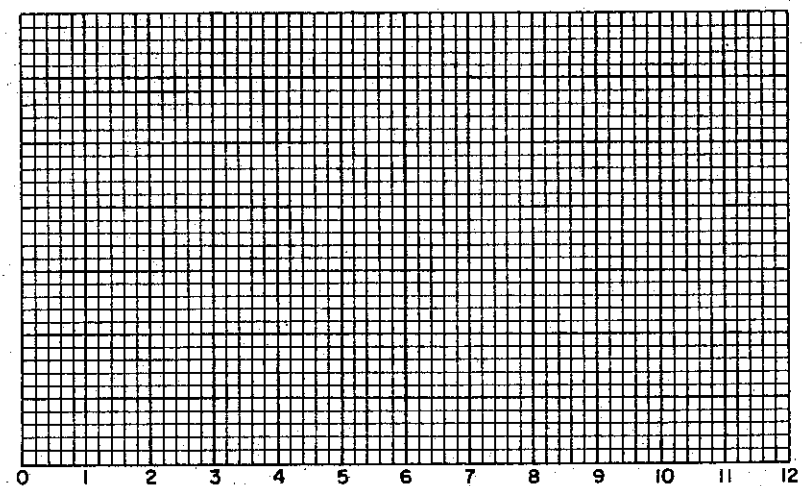

SOIL PROPERTIES

SOIL DESCRIPTION: CLAYEY SAND, GRAVELLY (GC-SC)
 SPECIFIC GRAVITY 2.69
 INITIAL WATER CONTENT 11.5%
 FINAL WATER CONTENT 12.0%

BORING NO. 41
 SAMPLE NO. 29
 DEPTH 130.8'

TEST DATA

INITIAL SAMPLE HEIGHT 0.80"
 INITIAL SAMPLE DIAMETER 2.50"
 INITIAL VOID RATIO .370

**CONSOLIDATION TEST
 TIME VS. COMPRESSION CURVES**

THE DETROIT EDISON COMPANY
 BELLE RIVER PLANT UNITS I & II

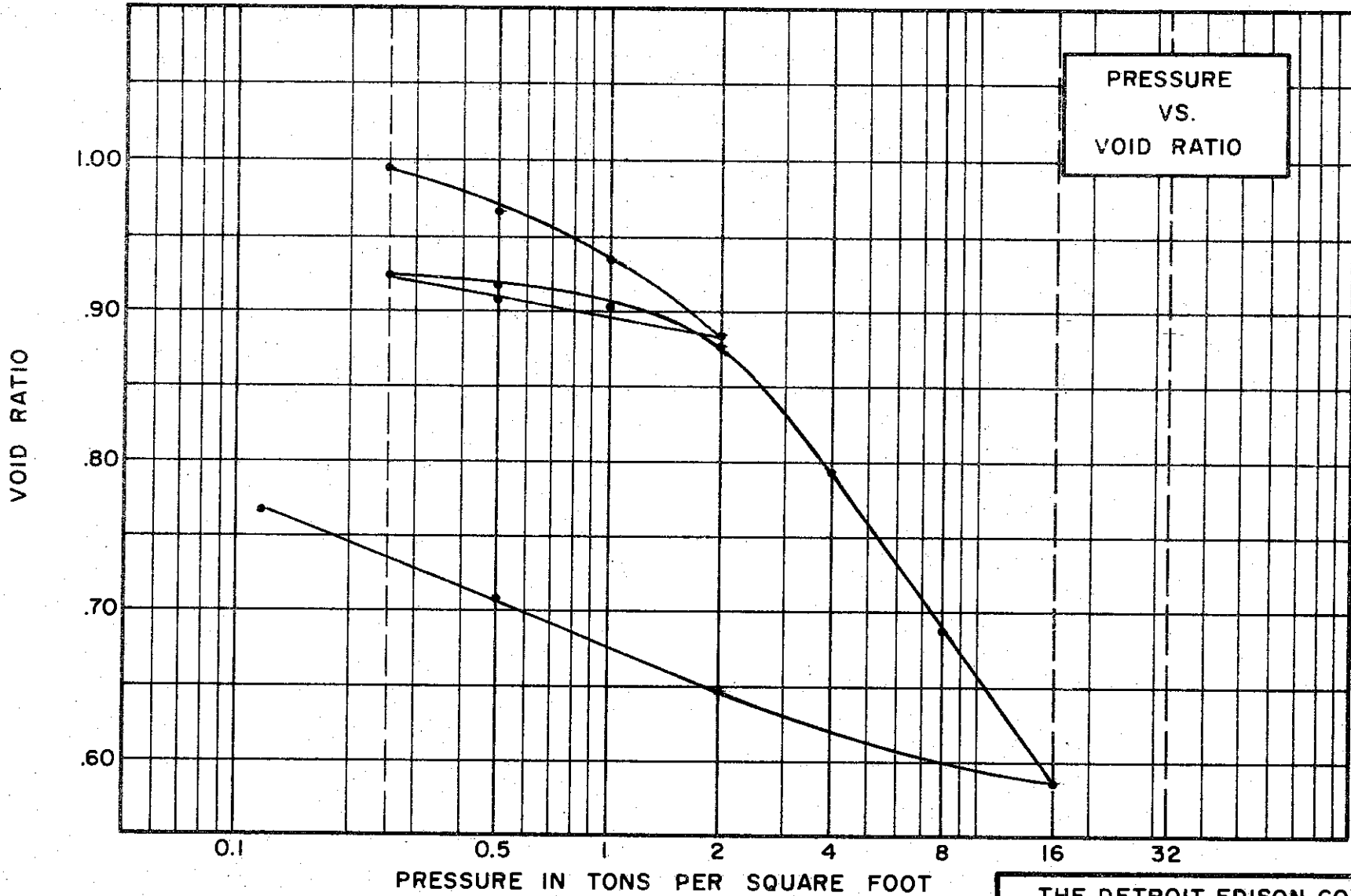

SOIL PROPERTIES

SOIL DESCRIPTION SILTY
CLAY (CL-CH)
 SPECIFIC GRAVITY 2.73
 WATER CONTENT, INITIAL 38.8% FINAL 31.5%
 ATTERBERG LIMITS:
 LIQUID LIMIT 47% PLASTIC LIMIT 24%

TEST DATA

INITIAL SAMPLE HEIGHT 0.80"
 INITIAL SAMPLE DIAMETER 2.50"
 INITIAL VOID RATIO 1.027

THE DETROIT EDISON COMPANY
 BELLE RIVER PLANT UNITS I & II

**CONSOLIDATION TEST
 VOID RATIO VS. LOG PRESSURE**

BORING NO. 48 TEST NO. C202.1
 SAMPLE NO. 10 DATE MARCH 74
 DEPTH 39.2' TO 39.4'

C-493

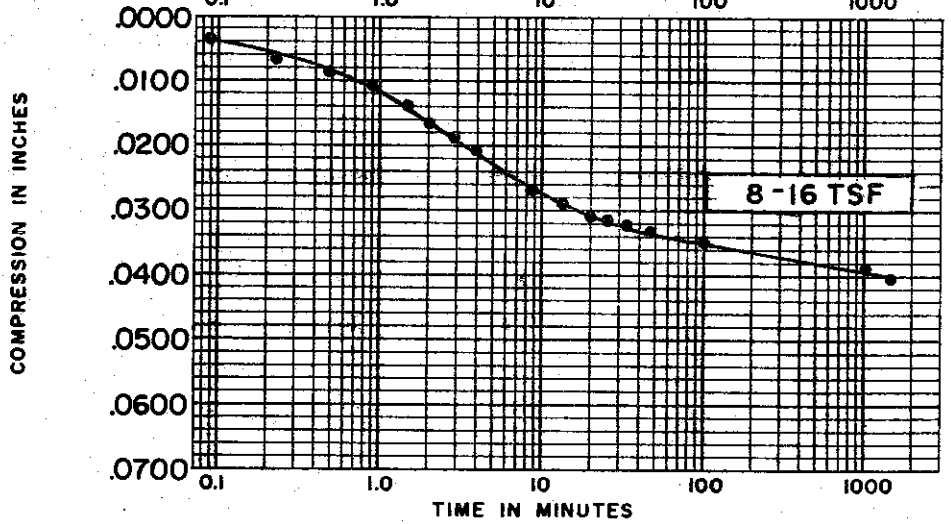
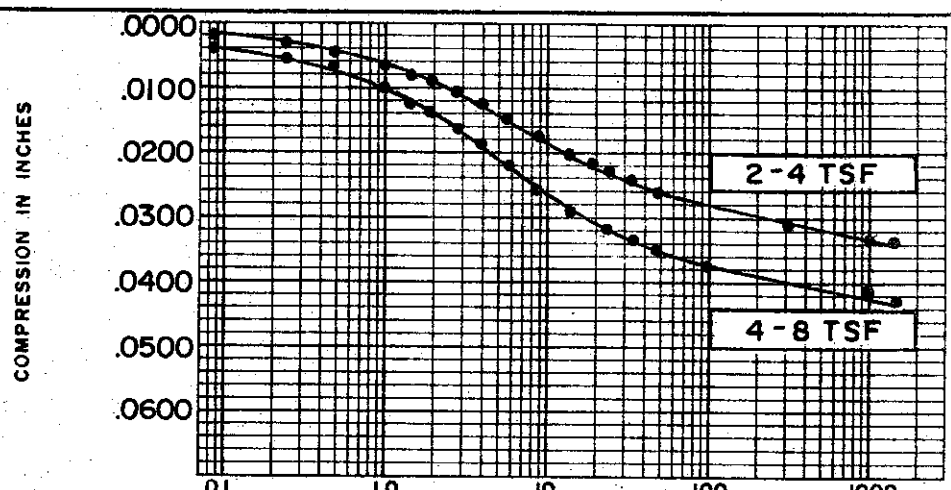
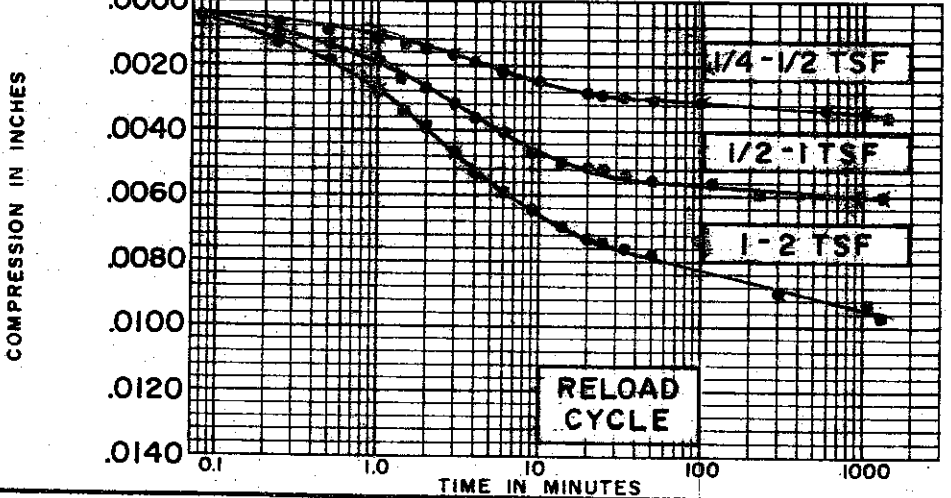
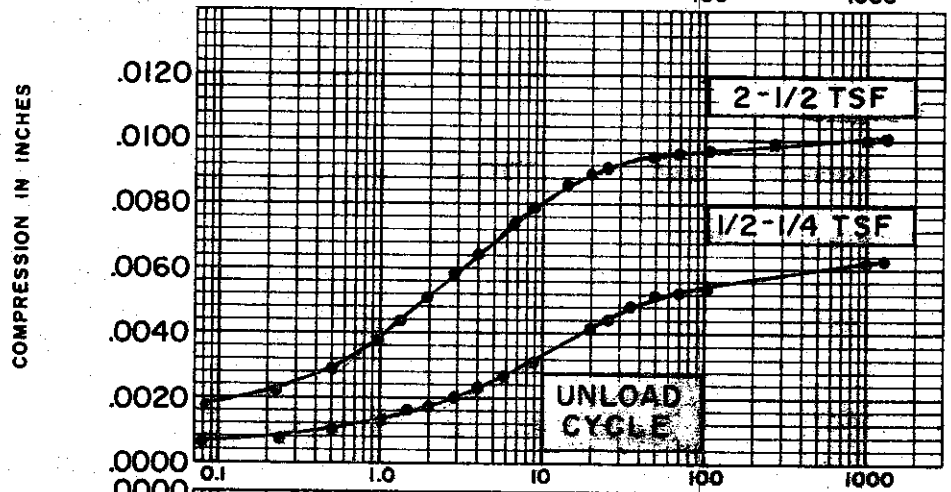
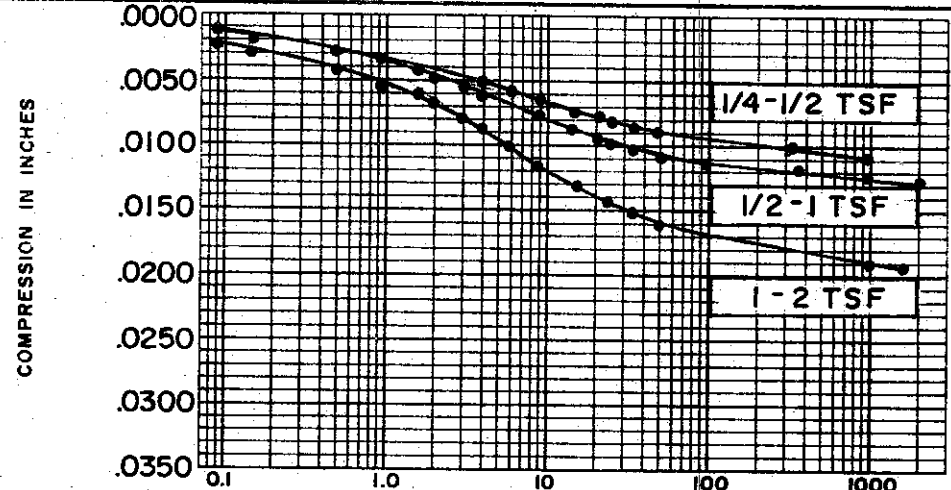

SOIL PROPERTIES	
SOIL DESCRIPTION:	SILTY CLAY (CL-CH)
SPECIFIC GRAVITY	2.73
INITIAL WATER CONTENT	29.8%
FINAL WATER CONTENT	31.5%
BORING NO.	48
SAMPLE NO.	10
DEPTH	39.2' TO 39.4'

TEST DATA	
INITIAL SAMPLE HEIGHT	0.80"
INITIAL SAMPLE DIAMETER	2.50"
INITIAL VOID RATIO	1.027

CONSOLIDATION TEST
 TIME VS. COMPRESSION CURVES
 THE DETROIT EDISON COMPANY
 BELLE RIVER PLANT UNITS I & II

C-495

COMPRESSION IN INCHES

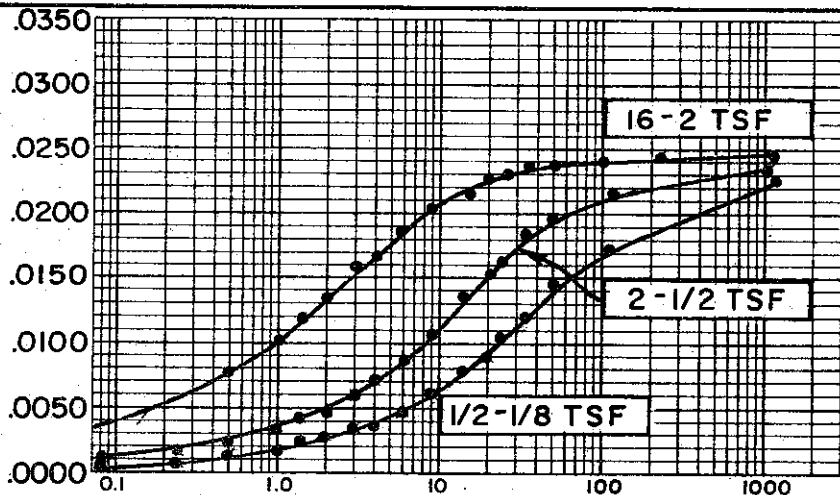

COMPRESSION IN INCHES

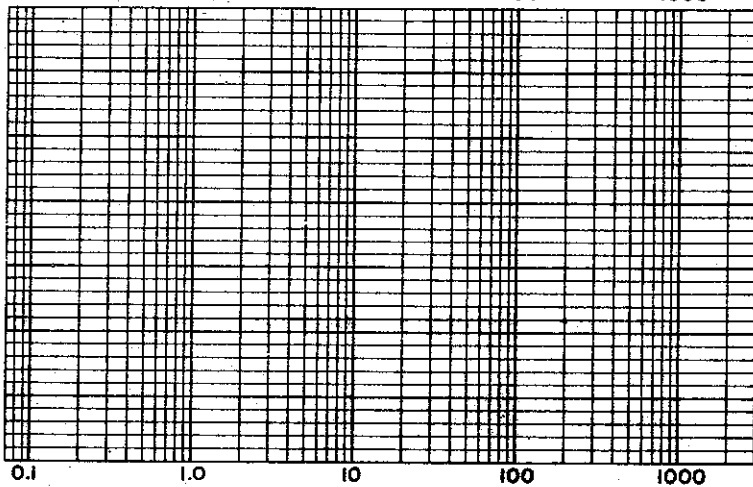

COMPRESSION IN INCHES

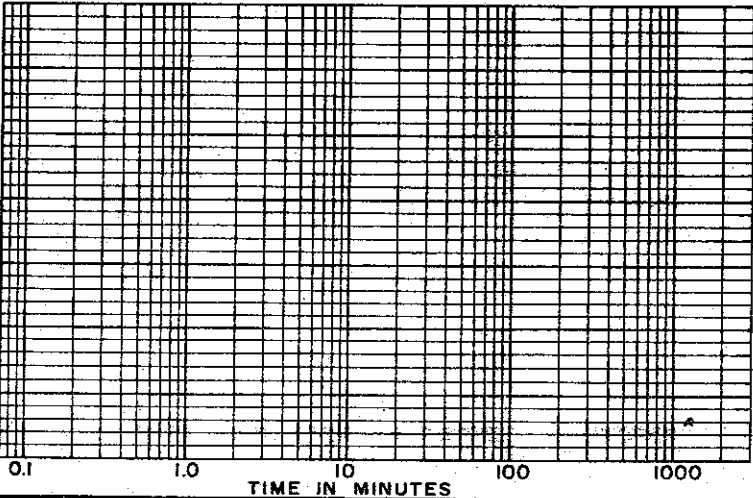

COMPRESSION IN INCHES

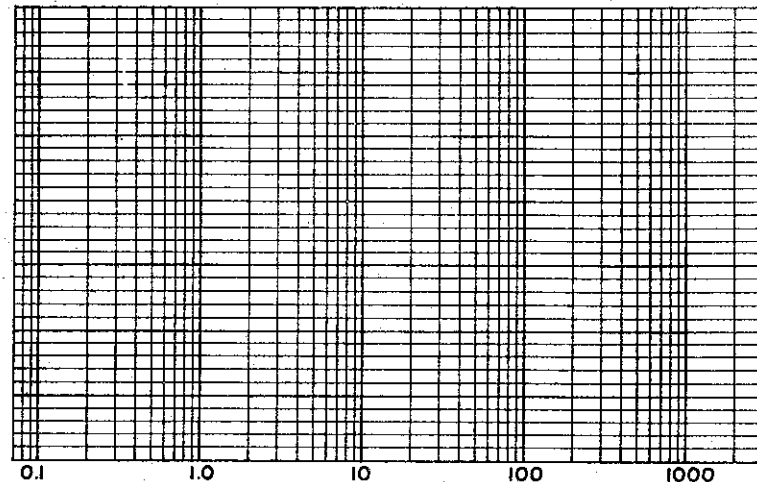

COMPRESSION IN INCHES

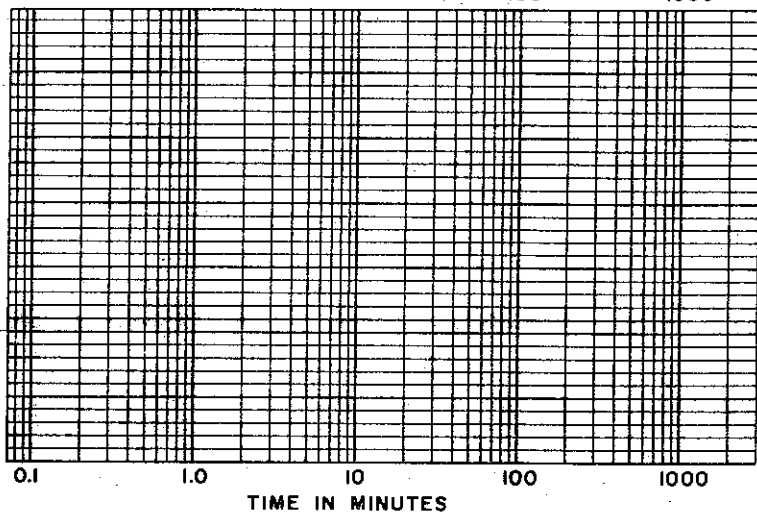

TIME IN MINUTES

SOIL PROPERTIES

SOIL DESCRIPTION: SILTY CLAY (CL-CH)
 SPECIFIC GRAVITY 2.73
 INITIAL WATER CONTENT 38.8%
 FINAL WATER CONTENT 31.5%

BORING NO. 48
 SAMPLE NO. 10
 DEPTH 39.2' TO 39.7'

TEST DATA

INITIAL SAMPLE HEIGHT 0.80"
 INITIAL SAMPLE DIAMETER 2.50"
 INITIAL VOID RATIO 1.027

**CONSOLIDATION TEST
 TIME VS. COMPRESSION CURVE**

THE DETROIT EDISON COMPANY
 BELLE RIVER PLANT UNITS I & II

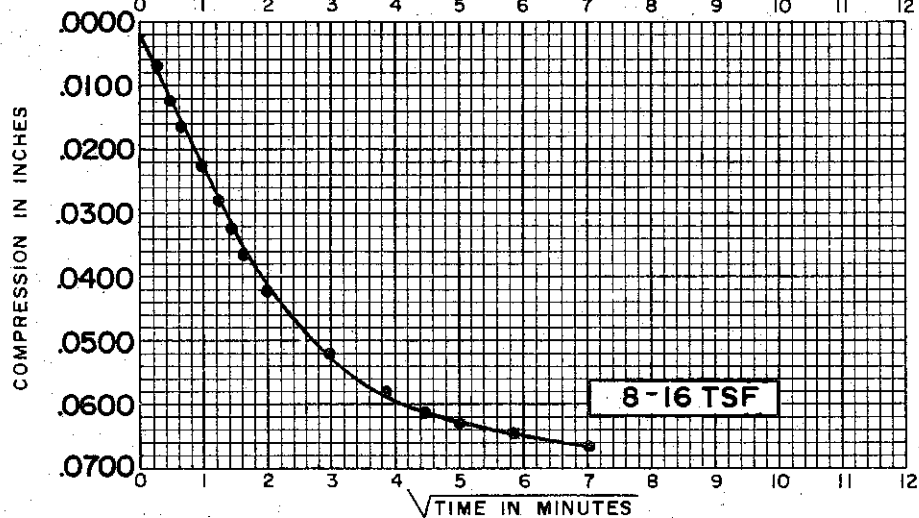
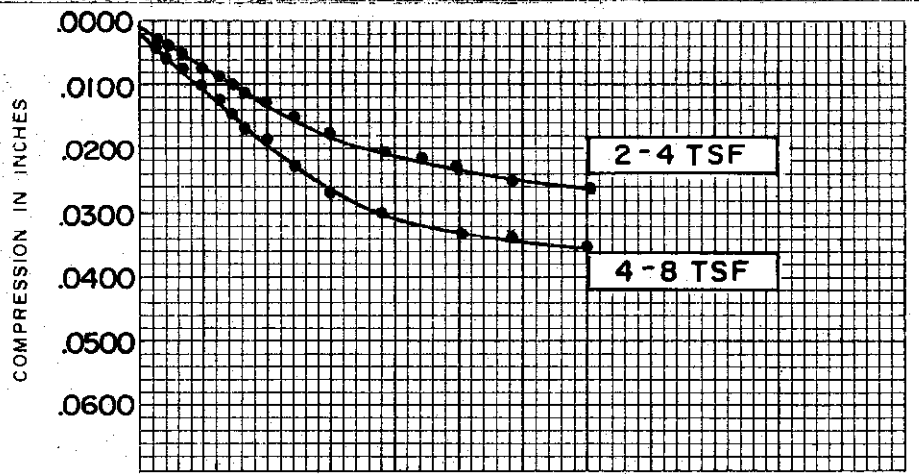
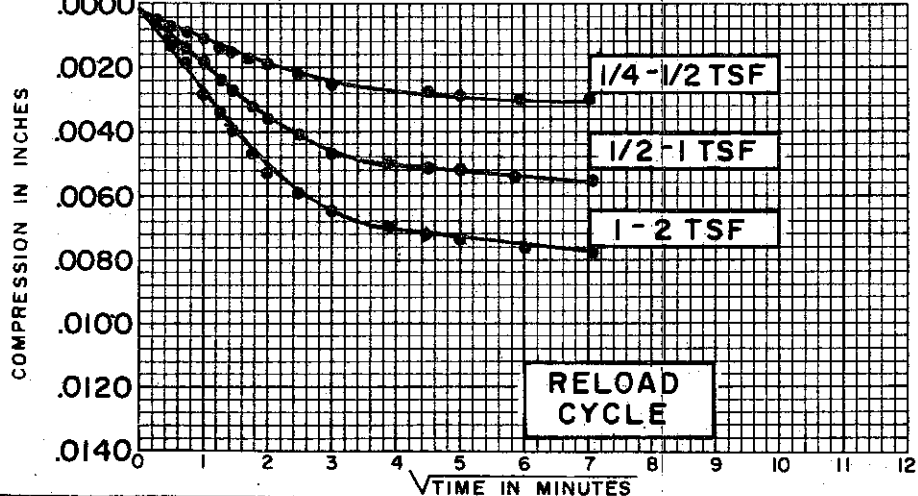
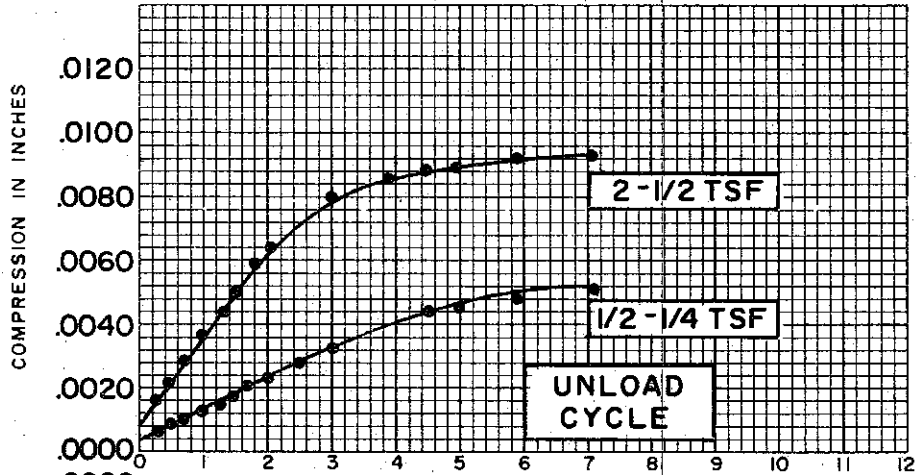
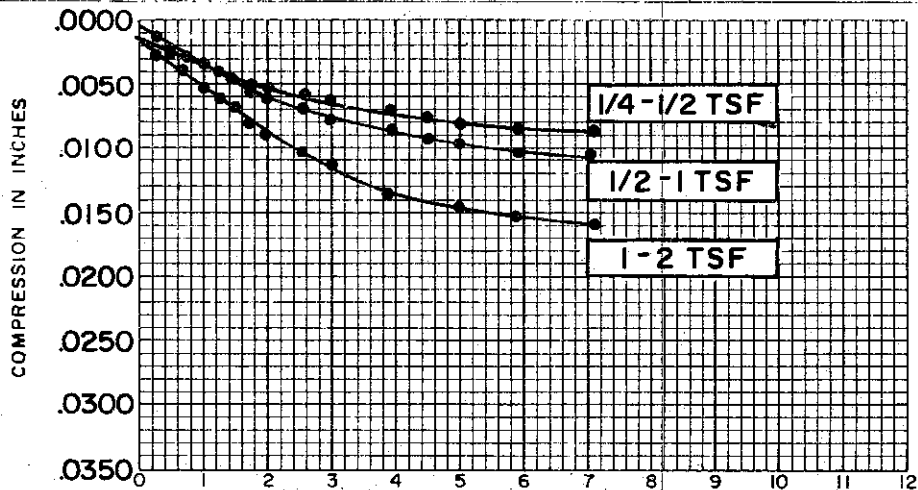

SOIL PROPERTIES

SOIL DESCRIPTION: SILTY
CLAY (CL-CH)
 SPECIFIC GRAVITY 2.73
 INITIAL WATER CONTENT 38.8%
 FINAL WATER CONTENT 31.5%

BORING NO. 48
 SAMPLE NO. 10
 DEPTH 39.2' TO 39.4'

TEST DATA

INITIAL SAMPLE HEIGHT 0.80"
 INITIAL SAMPLE DIAMETER 2.50"
 INITIAL VOID RATIO 1.027

CONSOLIDATION TEST TIME VS. COMPRESSION CURVES

THE DETROIT EDISON COMPANY
 BELLE RIVER PLANT UNITS I & II

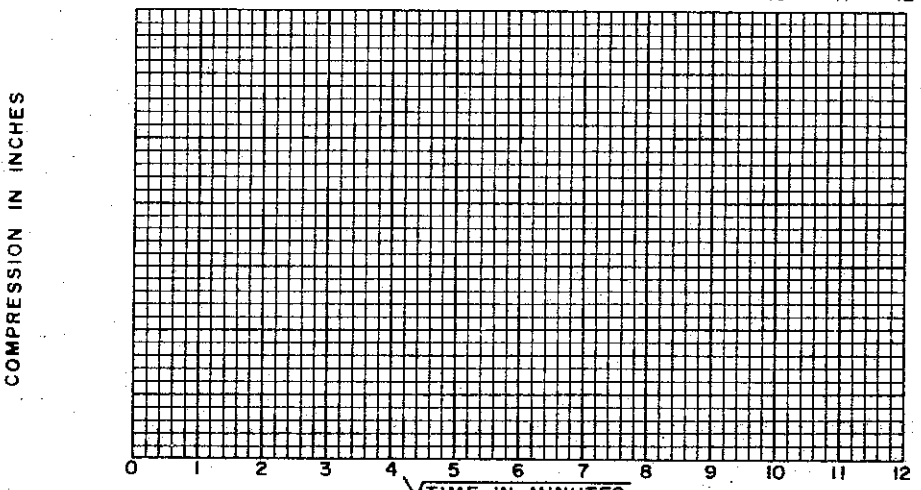
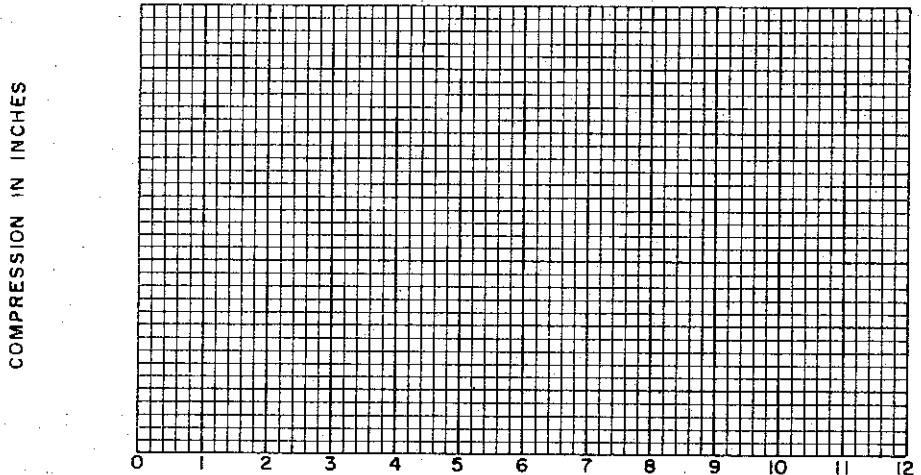
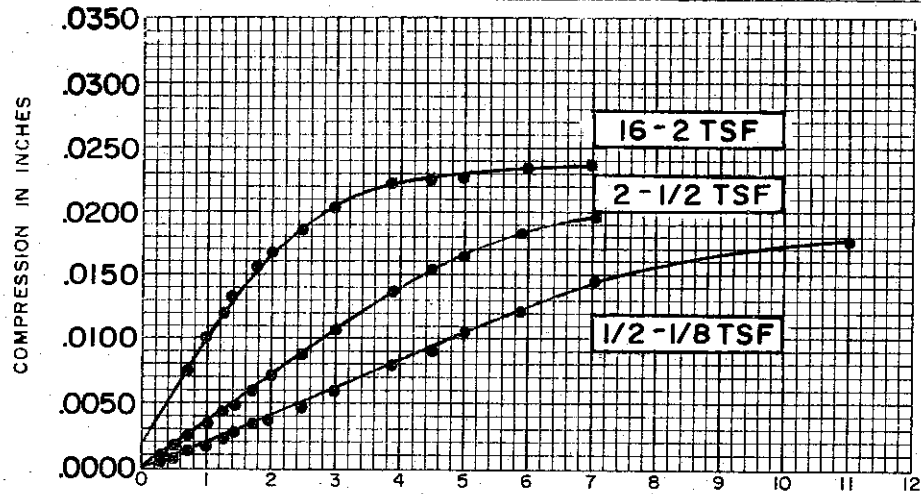

COMPRESSION IN INCHES

COMPRESSION IN INCHES

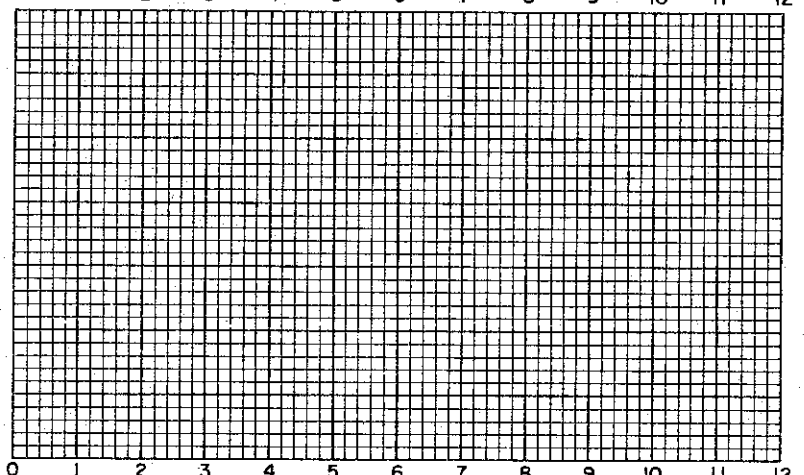
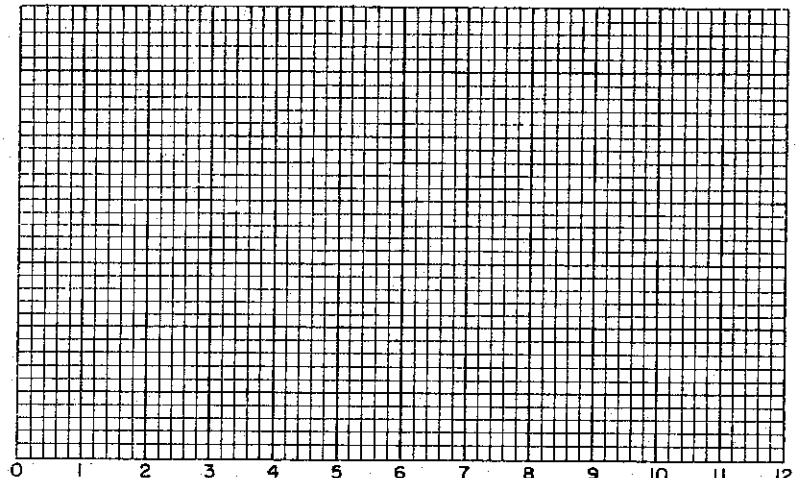

$\sqrt{\text{TIME IN MINUTES}}$

SOIL PROPERTIES	
SOIL DESCRIPTION:	<u>SILTY CLAY (CL-CH)</u>
SPECIFIC GRAVITY	<u>2.73</u>
INITIAL WATER CONTENT	<u>38.8%</u>
FINAL WATER CONTENT	<u>31.5%</u>
BORING NO.	<u>48</u>
SAMPLE NO.	<u>10</u>
DEPTH	<u>39.2' TO 39.4'</u>

TEST DATA	
INITIAL SAMPLE HEIGHT	<u>0.80"</u>
INITIAL SAMPLE DIAMETER	<u>2.50"</u>
INITIAL VOID RATIO	<u>1.027</u>

**CONSOLIDATION TEST
TIME VS. COMPRESSION CURVES**

THE DETROIT EDISON COMPANY
BELLE RIVER PLANT UNITS I & II

C-497

PRESSURE
VS.
VOID RATIO

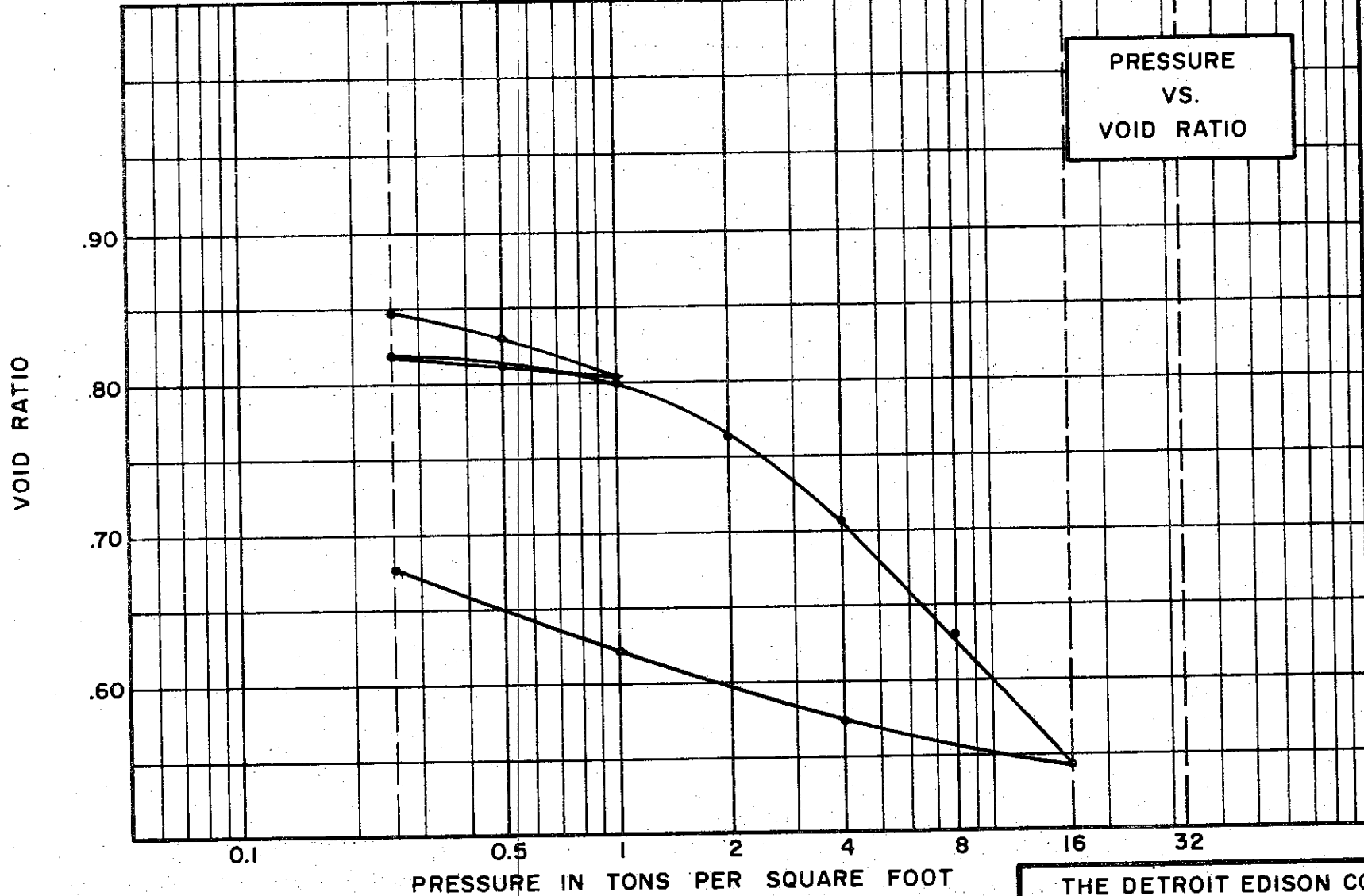

SOIL PROPERTIES

SOIL DESCRIPTION SILTY
CLAY (CL-CH)

SPECIFIC GRAVITY 2.72

WATER CONTENT, INITIAL 33.3% FINAL 28.5%

ATTERBERG LIMITS:
LIQUID LIMIT 47% PLASTIC LIMIT 23%

TEST DATA

INITIAL SAMPLE HEIGHT 0.80"

INITIAL SAMPLE DIAMETER 2.50"

INITIAL VOID RATIO 0.863

THE DETROIT EDISON COMPANY
BELLE RIVER PLANT UNITS I & II

**CONSOLIDATION TEST
VOID RATIO VS. LOG PRESSURE**

BORING NO. 49 TEST NO. C133.1

SAMPLE NO. 3 DATE FEB. 1974

DEPTH 13.7' TO 14.0'

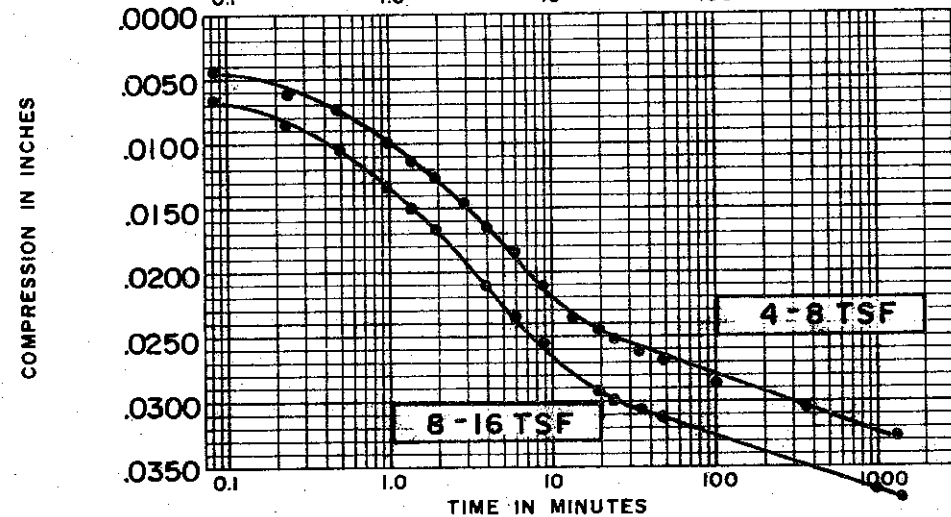
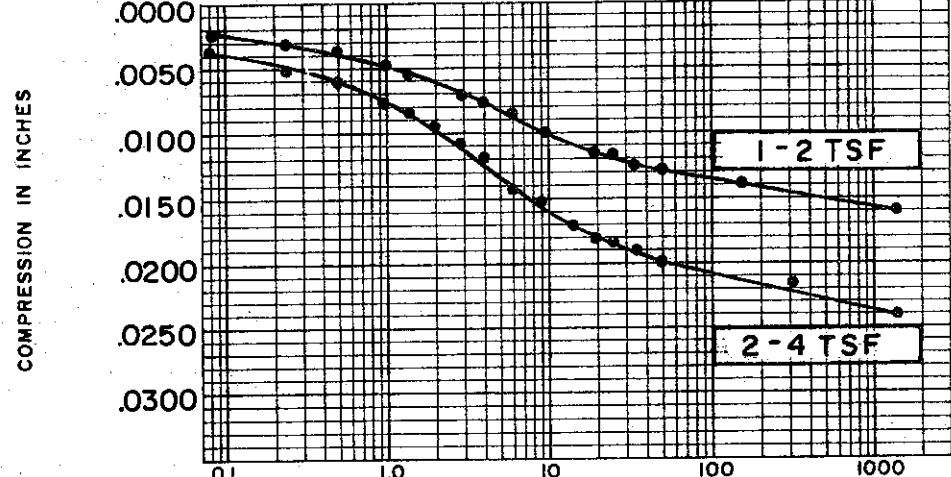
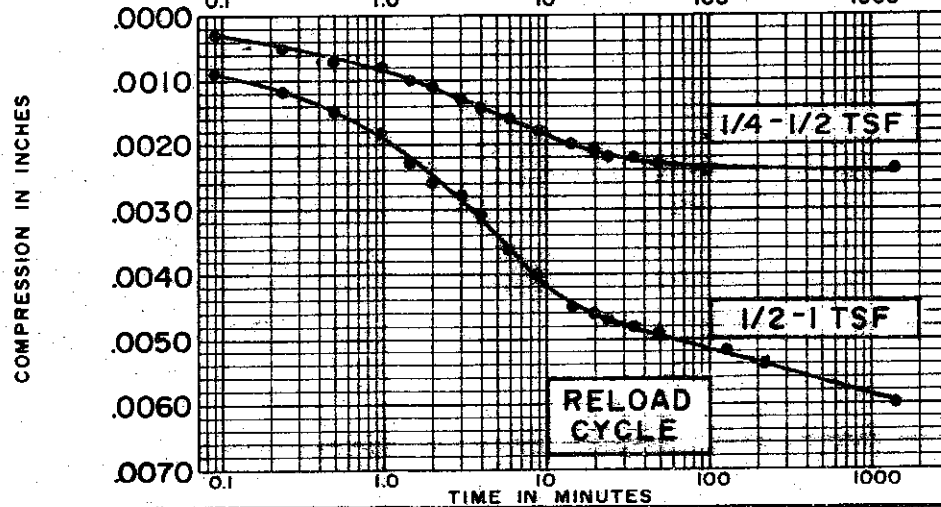
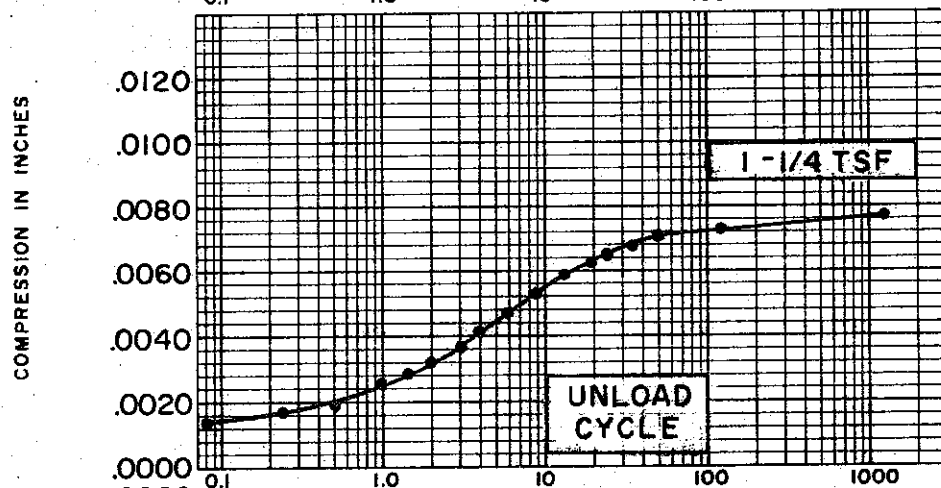
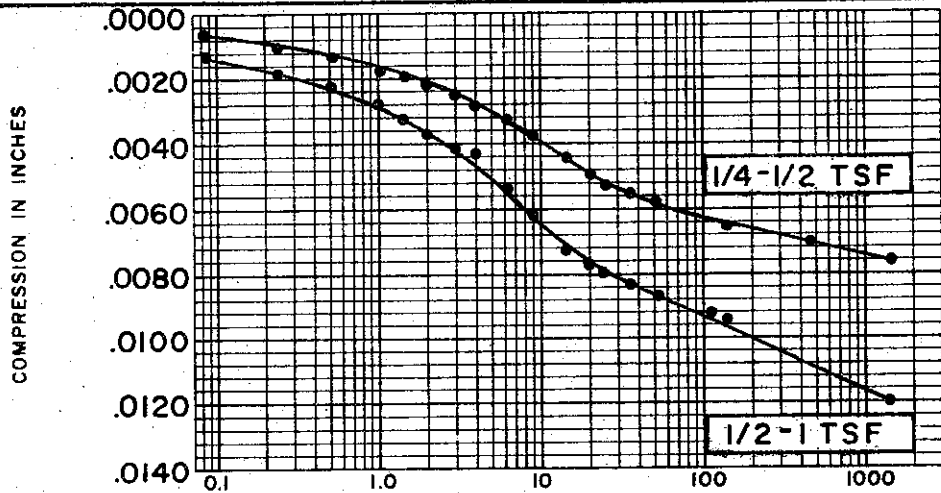

SOIL PROPERTIES

SOIL DESCRIPTION: SILTY CLAY (CL-CH)
 SPECIFIC GRAVITY 2.72
 INITIAL WATER CONTENT 33.3%
 FINAL WATER CONTENT 28.5%

BORING NO. 49
 SAMPLE NO. 3
 DEPTH 13.7' TO 14.0'

TEST DATA

INITIAL SAMPLE HEIGHT 0.80"
 INITIAL SAMPLE DIAMETER 2.50"
 INITIAL VOID RATIO 0.863

**CONSOLIDATION TEST
 TIME VS. COMPRESSION CURVE**

THE DETROIT EDISON COMPANY
 BELLE RIVER PLANT UNITS I & II

C-499

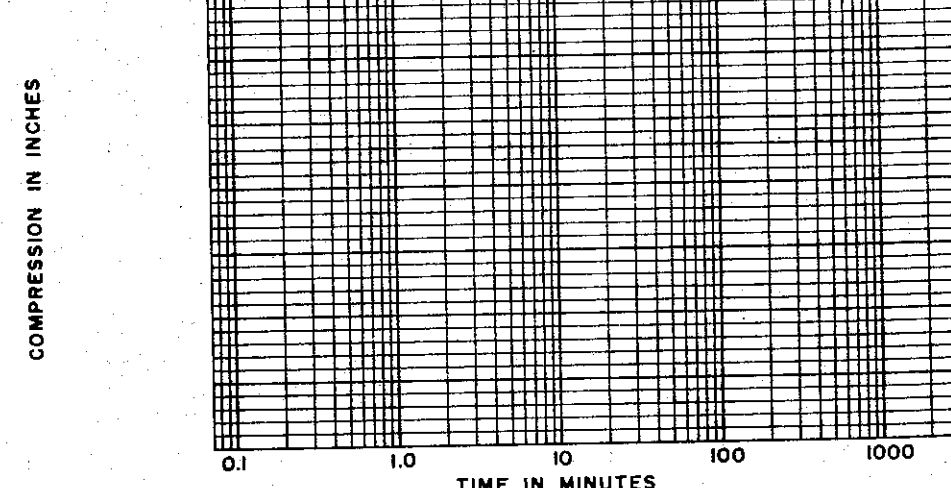
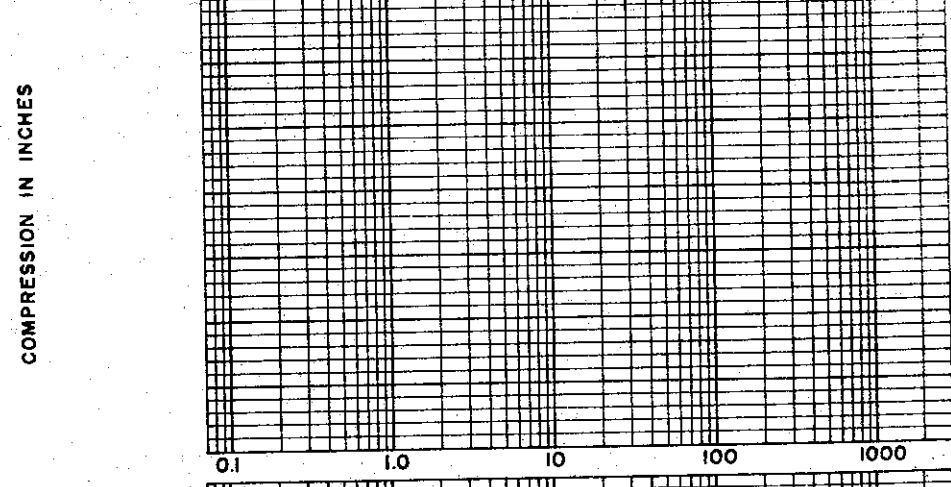
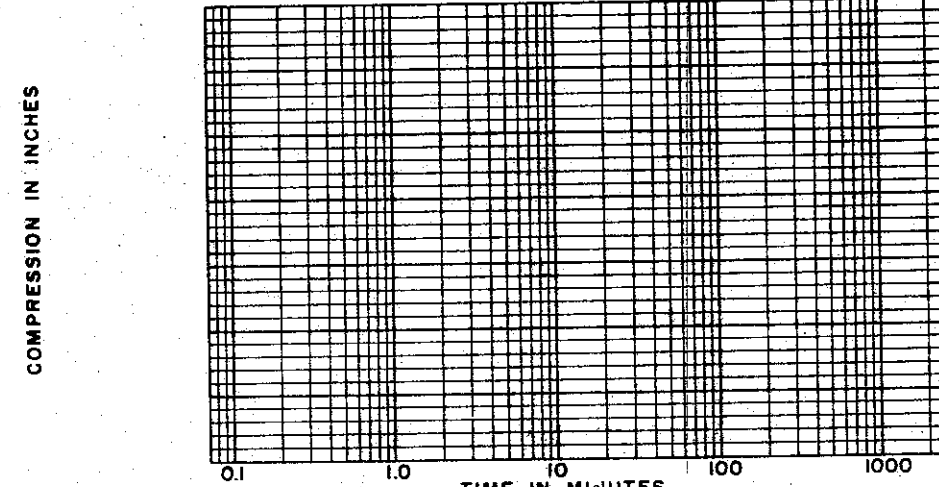
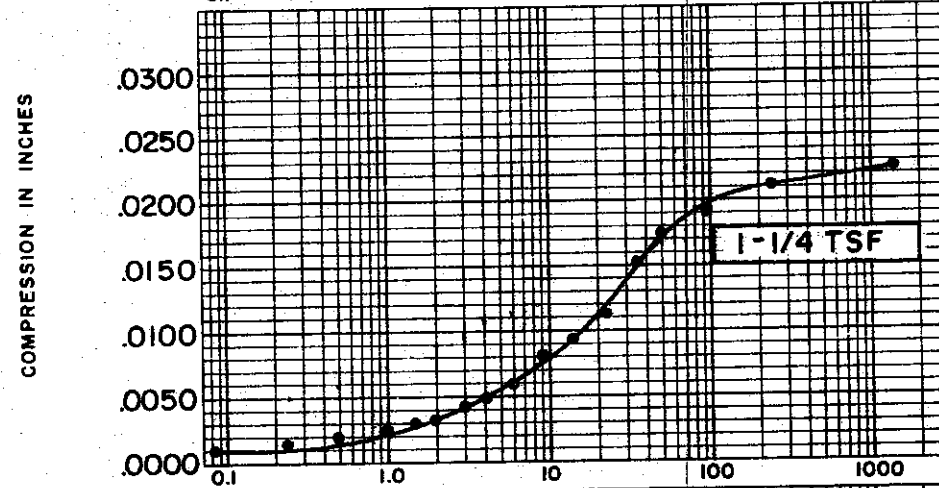
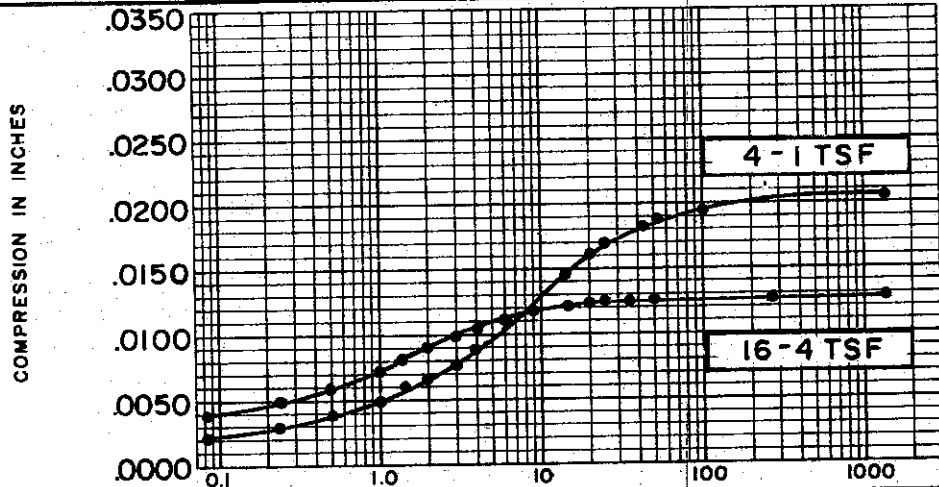

SOIL PROPERTIES		BORING NO. <u>49</u>
SOIL DESCRIPTION:	<u>SILTY CLAY (CL-CH)</u>	SAMPLE NO. <u>3</u>
SPECIFIC GRAVITY	<u>2.72</u>	DEPTH <u>13.7' TO 14.0'</u>
INITIAL WATER CONTENT	<u>33.3%</u>	
FINAL WATER CONTENT	<u>28.5%</u>	
TEST DATA		
INITIAL SAMPLE HEIGHT	<u>0.80"</u>	
INITIAL SAMPLE DIAMETER	<u>2.80"</u>	
INITIAL VOID RATIO	<u>0.863</u>	

CONSOLIDATION TEST
 TIME VS. COMPRESSION CURVE
 THE DETROIT EDISON COMPANY
 BELLE RIVER PLANT UNITS I & II
 FILE 1255

C-501

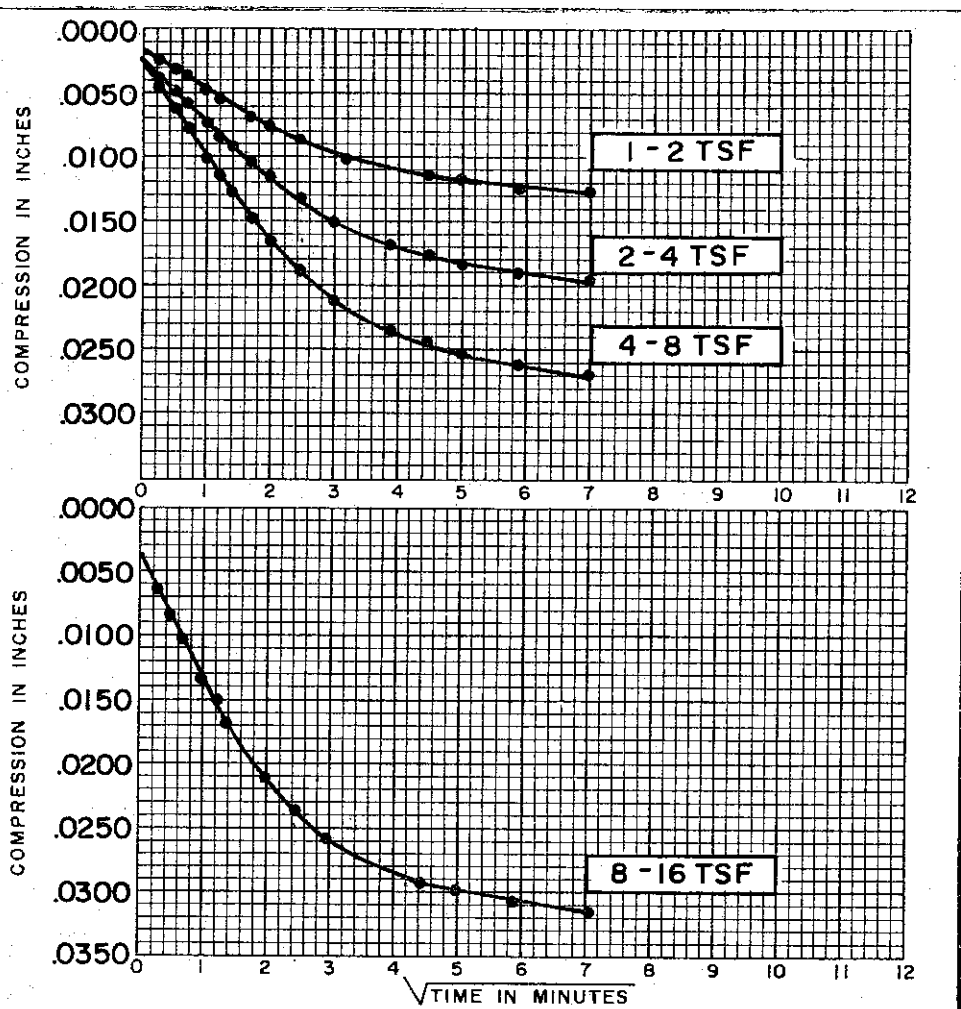
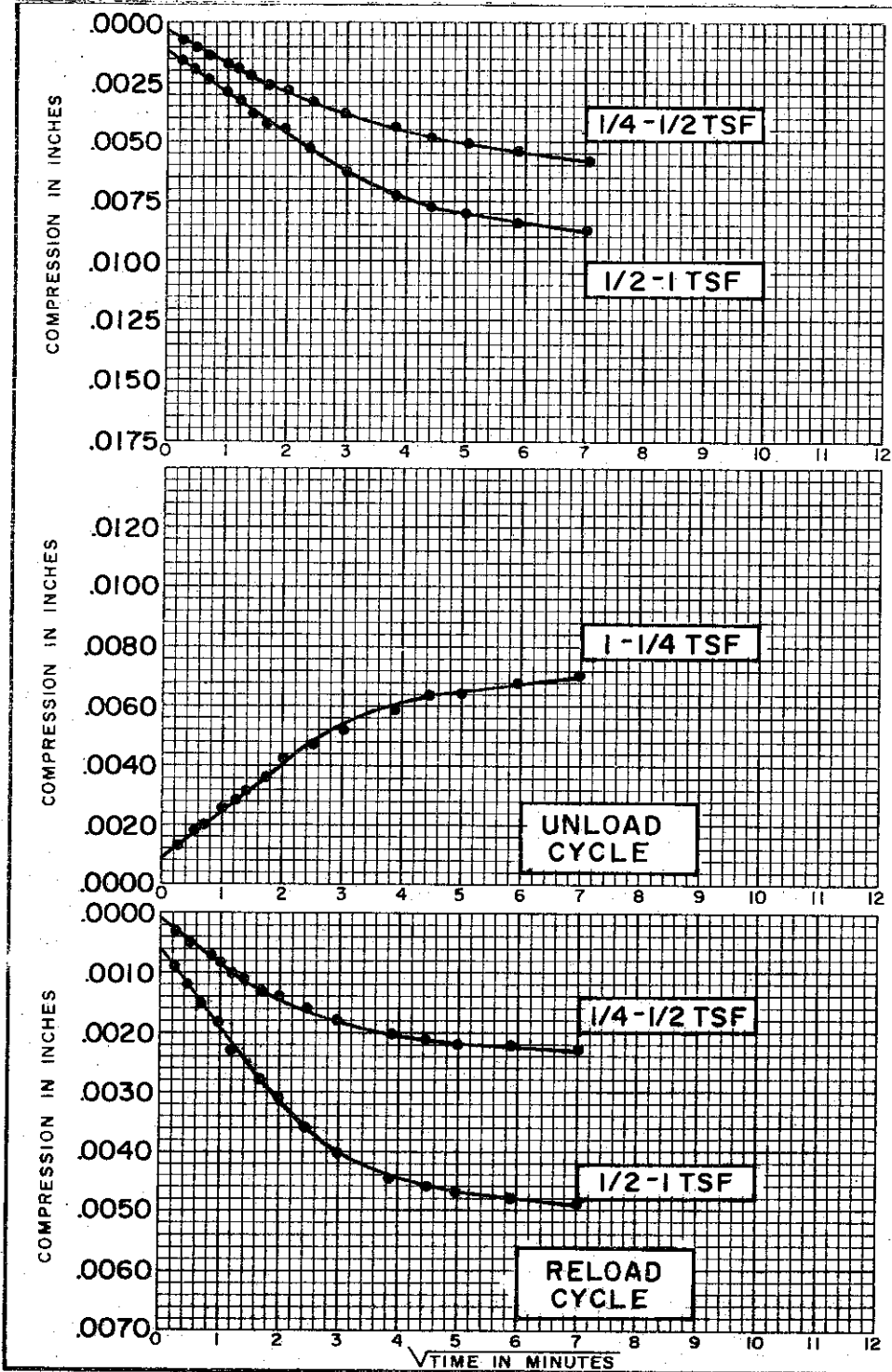

SOIL PROPERTIES		BORING NO. <u>49</u>
SOIL DESCRIPTION: <u>SILTY CLAY (CL-CH)</u>		SAMPLE NO. <u>3</u>
SPECIFIC GRAVITY	<u>2.72</u>	DEPTH <u>13.7' TO 14.0'</u>
INITIAL WATER CONTENT	<u>33.3%</u>	
FINAL WATER CONTENT	<u>28.5%</u>	
TEST DATA		
INITIAL SAMPLE HEIGHT	<u>0.60"</u>	
INITIAL SAMPLE DIAMETER	<u>2.50"</u>	
INITIAL VOID RATIO	<u>0.863</u>	
CONSOLIDATION TEST		
TIME VS. COMPRESSION CURVES		
THE DETROIT EDISON COMPANY		
BELLE RIVER PLANT UNITS I & II		

GOLDBERG-ZOINO & ASSOCIATES, INC.
SOIL AND FOUNDATION ENGINEERS

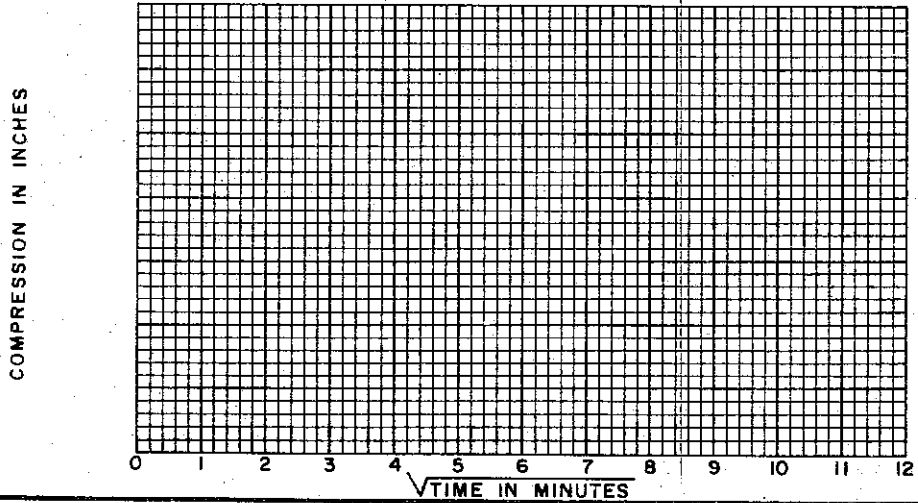
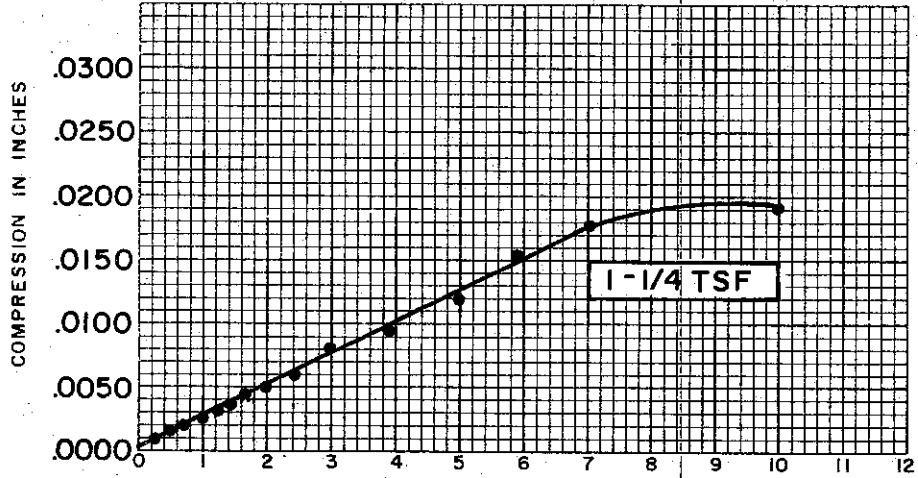
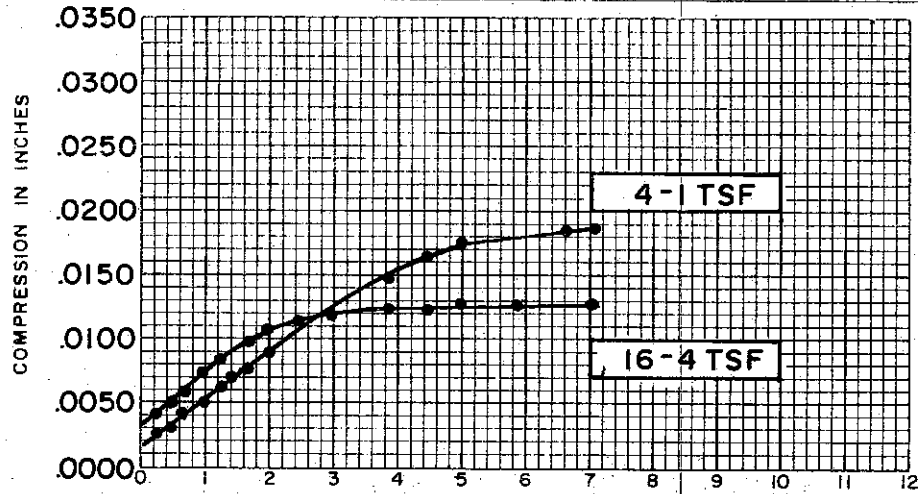

COMPRESSION IN INCHES

COMPRESSION IN INCHES

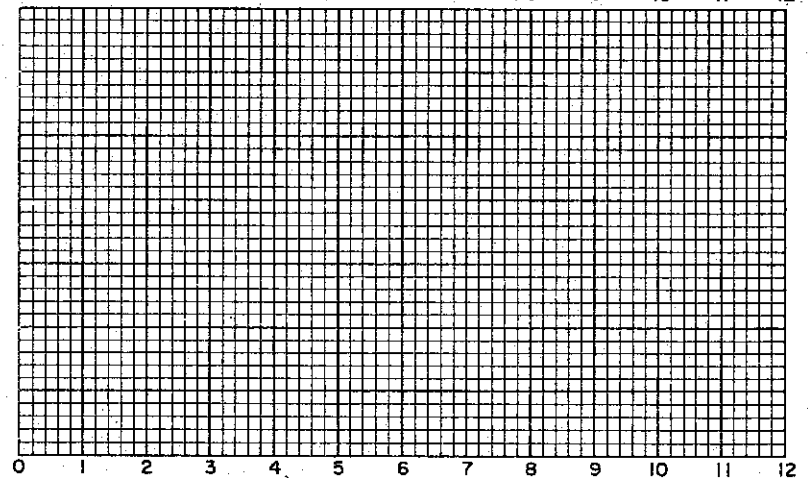
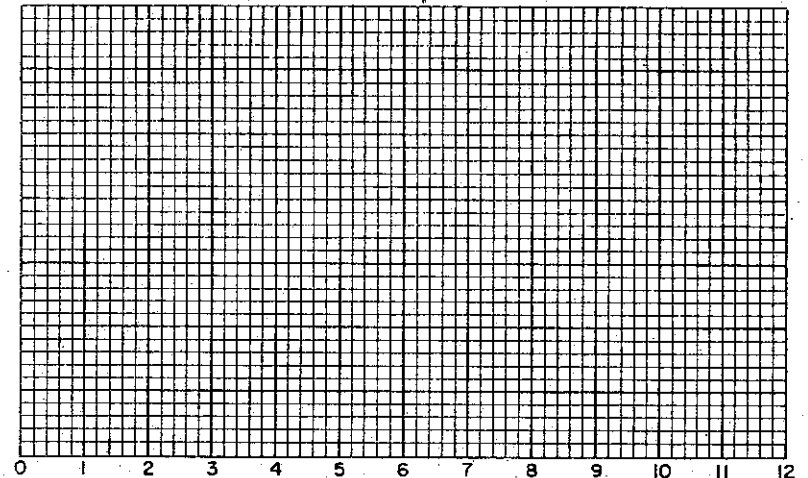

√TIME IN MINUTES

SOIL PROPERTIES

SOIL DESCRIPTION: SILTY
CLAY (CL-CH)
 SPECIFIC GRAVITY 2.72
 INITIAL WATER CONTENT 33.3%
 FINAL WATER CONTENT 28.5%

BORING NO. 49
 SAMPLE NO. 3
 DEPTH 13.7' TO 14.0'

TEST DATA

INITIAL SAMPLE HEIGHT 0.80"
 INITIAL SAMPLE DIAMETER 2.50"
 INITIAL VOID RATIO 0.863

**CONSOLIDATION TEST
 TIME VS. COMPRESSION CURVES**

THE DETROIT EDISON COMPANY
 BELLE RIVER PLANT UNITS I & II

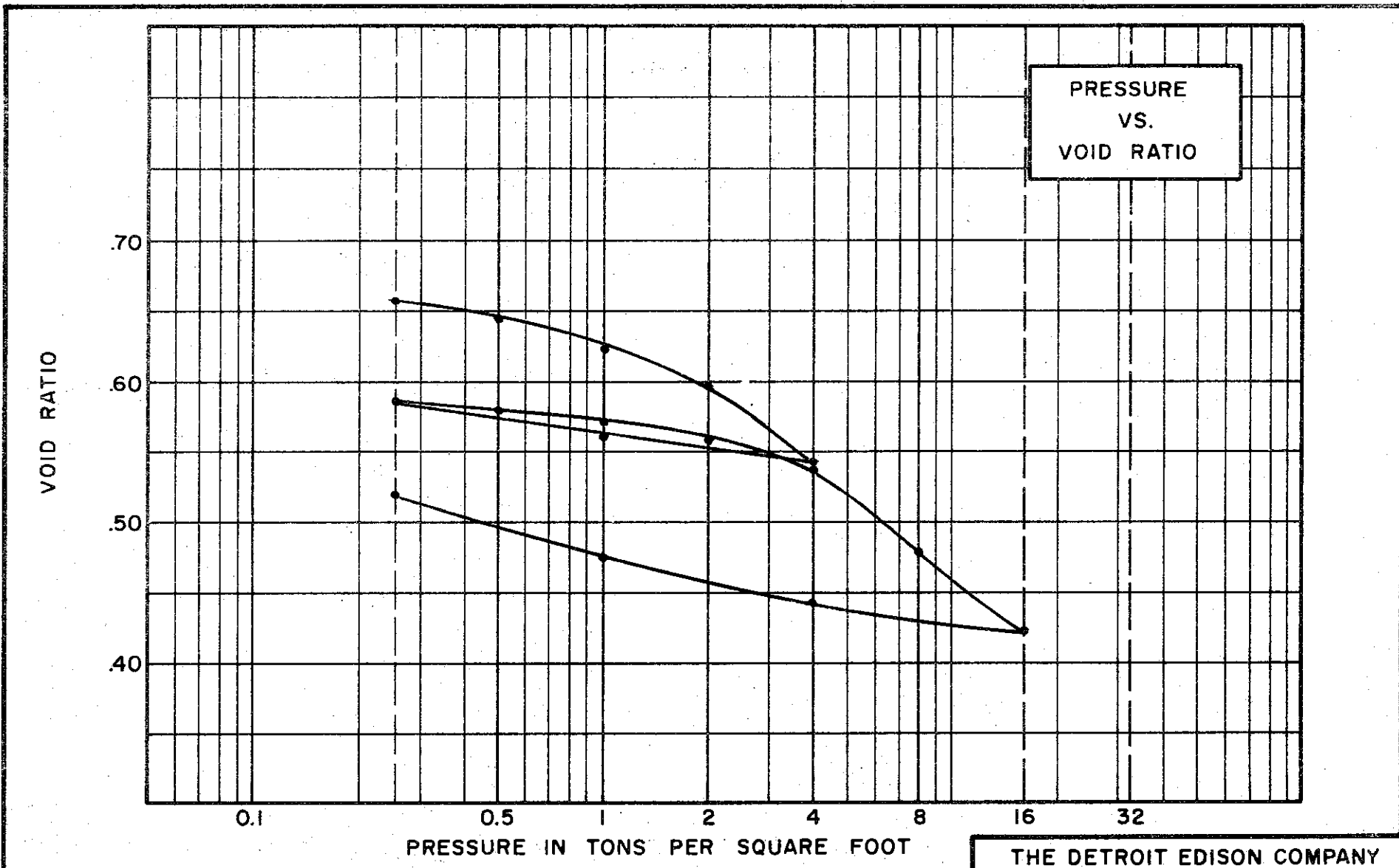

SOIL PROPERTIES

SOIL DESCRIPTION SILTY CLAY (CL)

SPECIFIC GRAVITY 2.68

WATER CONTENT, INITIAL 28.6% FINAL 24.4%

ATTERBERG LIMITS:
 LIQUID LIMIT 37% PLASTIC LIMIT 22%

TEST DATA

INITIAL SAMPLE HEIGHT 0.75"

INITIAL SAMPLE DIAMETER 2.50"

INITIAL VOID RATIO 0.701

THE DETROIT EDISON COMPANY
 BELLE RIVER PLANT UNITS I & II

CONSOLIDATION TEST
 VOID RATIO VS. LOG PRESSURE

BORING NO. 49 TEST NO. CI41.1
 SAMPLE NO. 11 DATE MARCH 74
 DEPTH 93.8' TO 94.0'

C-503

C-504

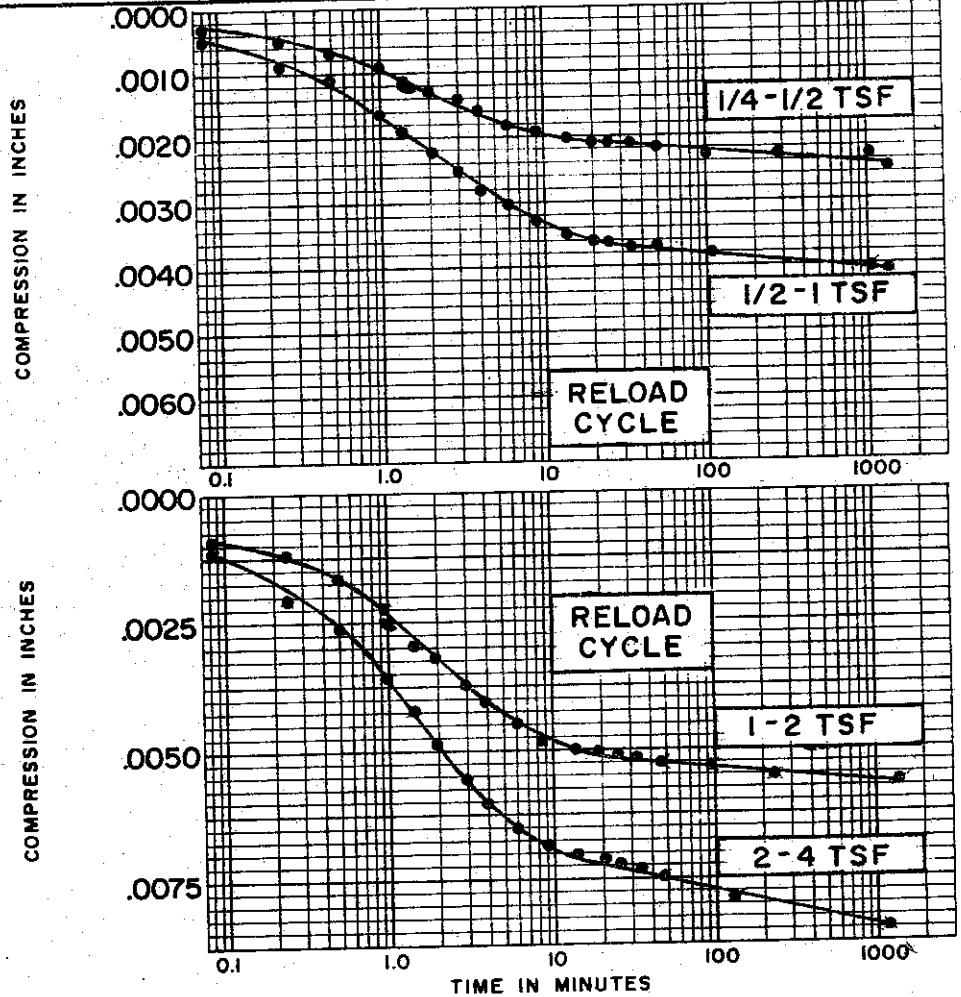
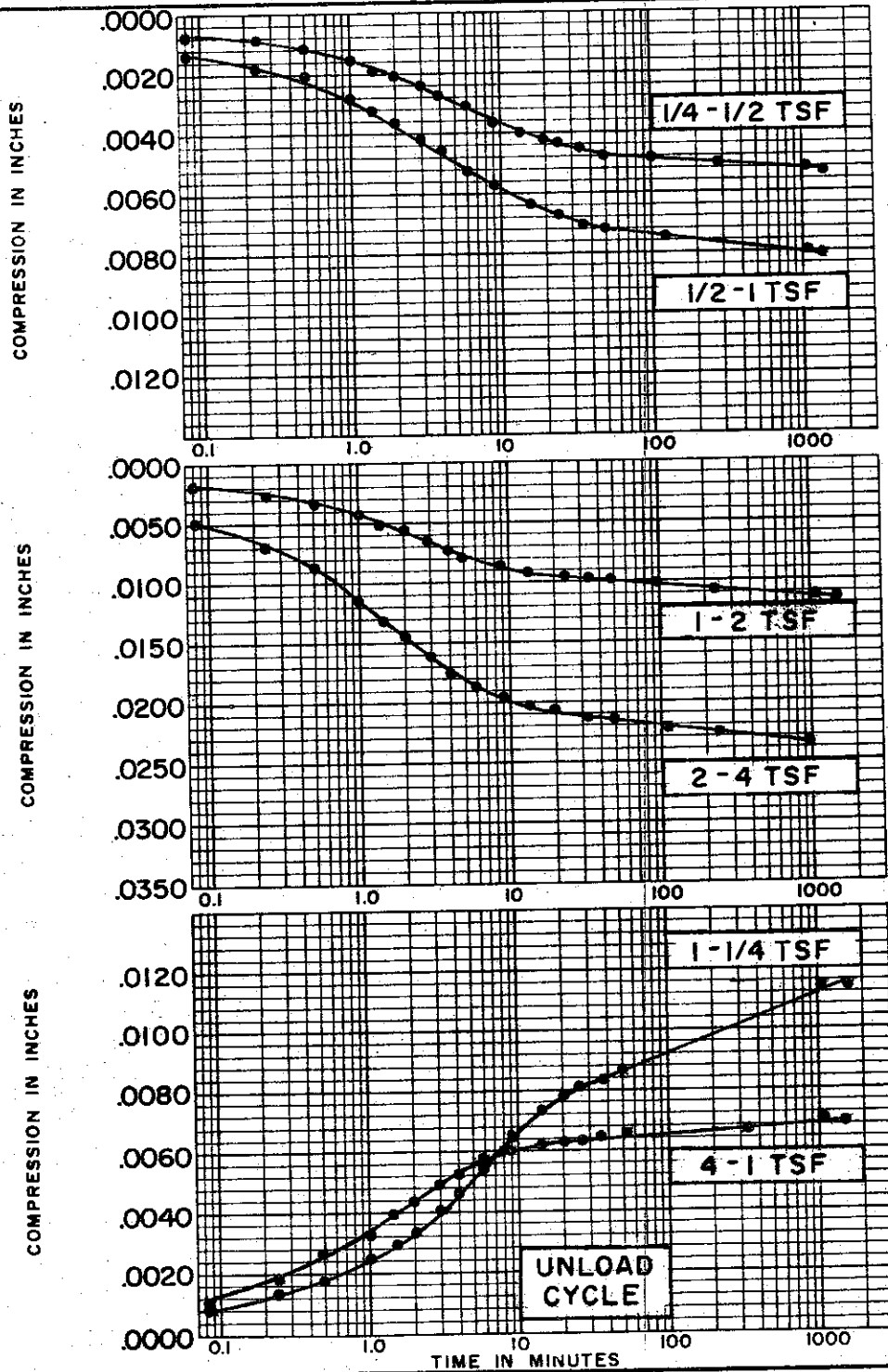

SOIL PROPERTIES	
SOIL DESCRIPTION:	SILTY CLAY (CL)
SPECIFIC GRAVITY	2.68
INITIAL WATER CONTENT	28.6%
FINAL WATER CONTENT	24.4%
TEST DATA	
INITIAL SAMPLE HEIGHT	0.75" ^u
INITIAL SAMPLE DIAMETER	2.50" ^u
INITIAL VOID RATIO	0.701

BORING NO. 49
 SAMPLE NO. 11
 DEPTH 93.8' TO 94.0'

CONSOLIDATION TEST
 TIME VS. COMPRESSION CURVE
 THE DETROIT EDISON COMPANY
 BELLE RIVER PLANT UNITS I & II

C-505

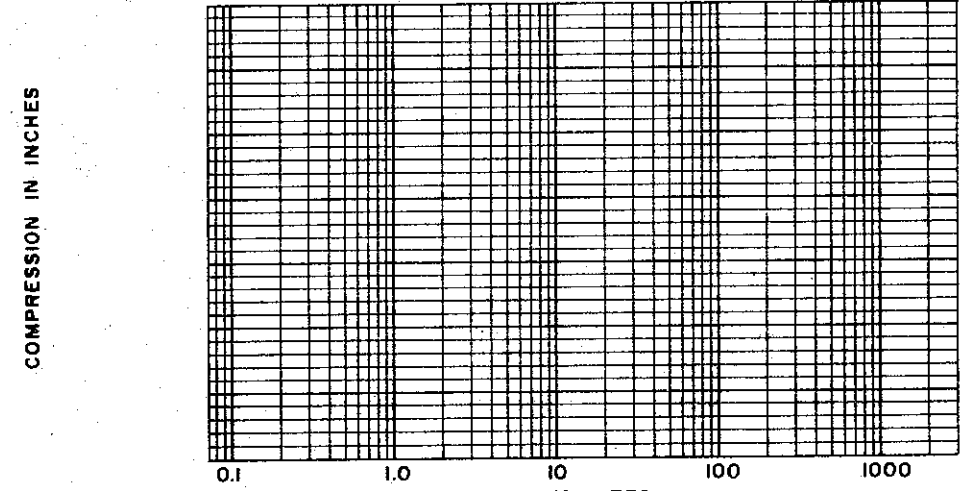
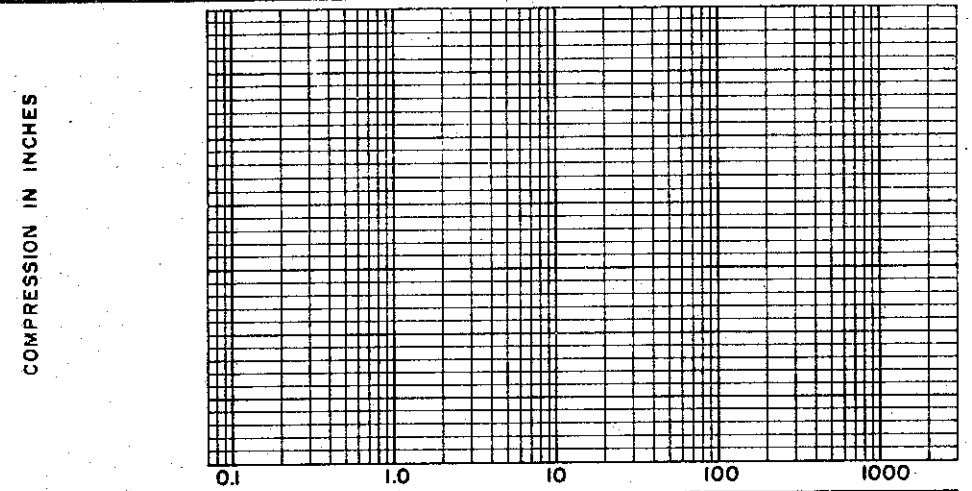
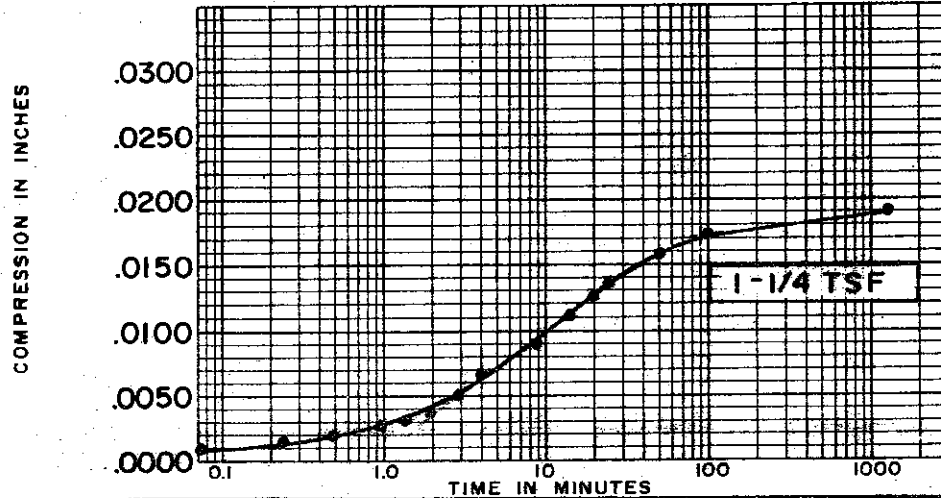
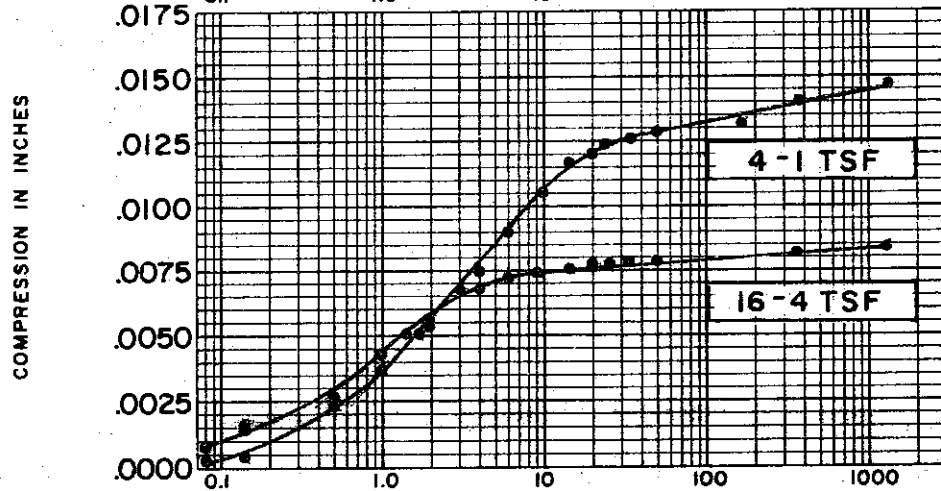
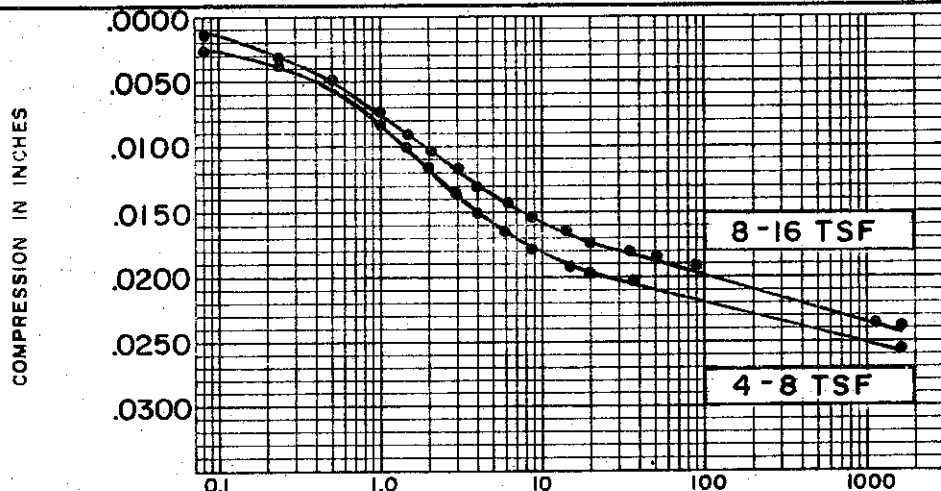

SOIL PROPERTIES		BORING NO. <u>49</u>
SOIL DESCRIPTION:	<u>SILTY CLAY (CL)</u>	SAMPLE NO. <u>11</u>
SPECIFIC GRAVITY	<u>2.68</u>	DEPTH <u>93.8' TO 94.0'</u>
INITIAL WATER CONTENT	<u>28.6%</u>	
FINAL WATER CONTENT	<u>24.4%</u>	
TEST DATA		
INITIAL SAMPLE HEIGHT	<u>0.75"</u>	CONSOLIDATION TEST TIME VS. COMPRESSION CURVE THE DETROIT EDISON COMPANY BELLE RIVER PLANT UNITS I & II
INITIAL SAMPLE DIAMETER	<u>2.50"</u>	
INITIAL VOID RATIO	<u>0.701</u>	

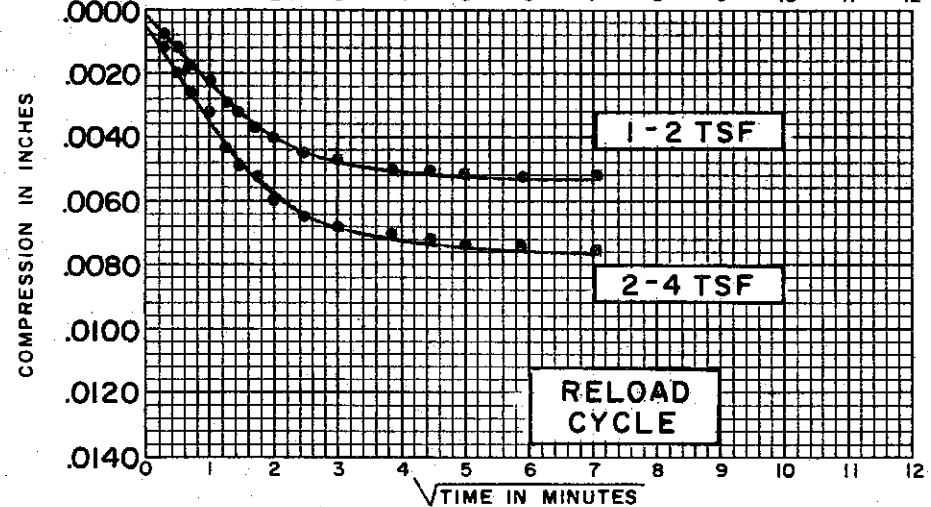
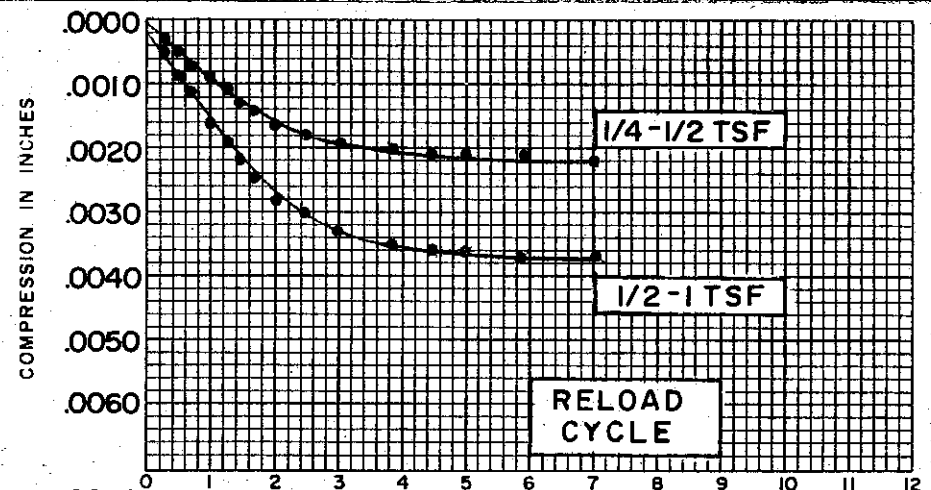
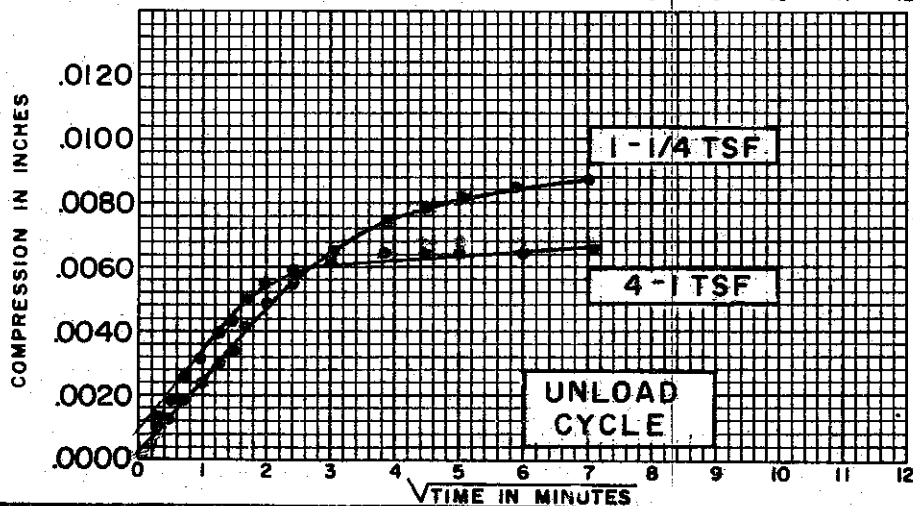
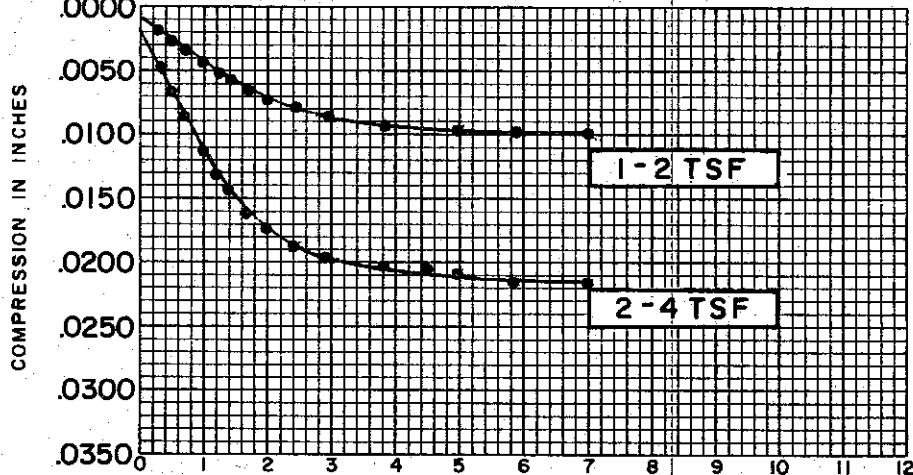
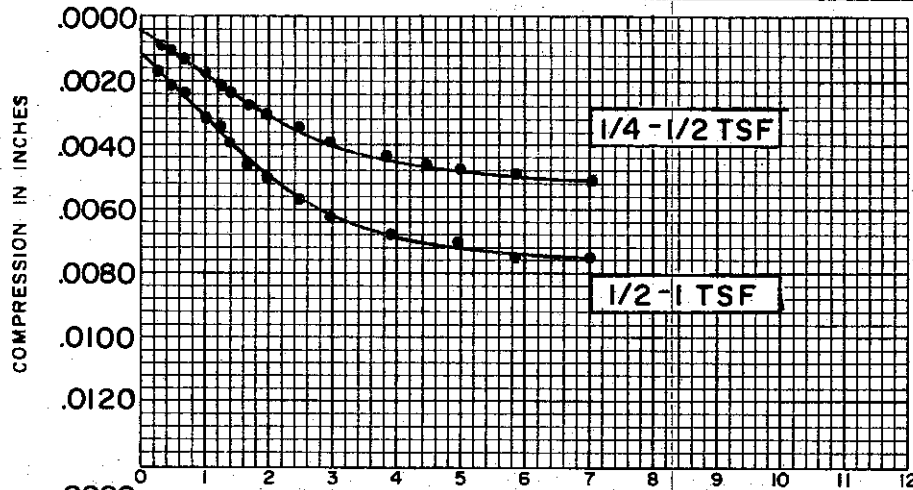

SOIL PROPERTIES		BORING NO. <u>49</u>
SOIL DESCRIPTION:	<u>SILTY CLAY (CL)</u>	SAMPLE NO. <u>11</u>
SPECIFIC GRAVITY	<u>2.68</u>	DEPTH <u>93.8' TO 94.0'</u>
INITIAL WATER CONTENT	<u>28.6%</u>	
FINAL WATER CONTENT	<u>24.4%</u>	

TEST DATA	
INITIAL SAMPLE HEIGHT	<u>0.75"</u>
INITIAL SAMPLE DIAMETER	<u>2.50"</u>
INITIAL VOID RATIO	<u>0.701</u>

CONSOLIDATION TEST
TIME VS. COMPRESSION CURVES
 THE DETROIT EDISON COMPANY
 BELLE RIVER PLANT UNITS I & II

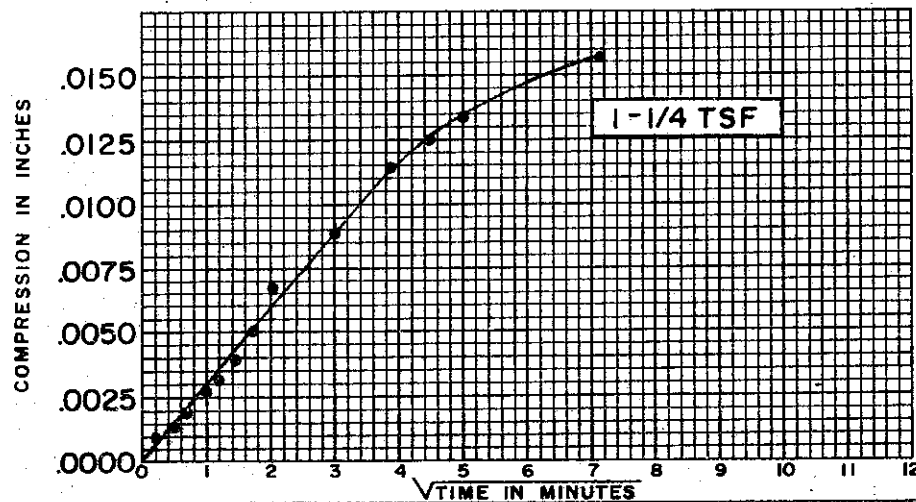
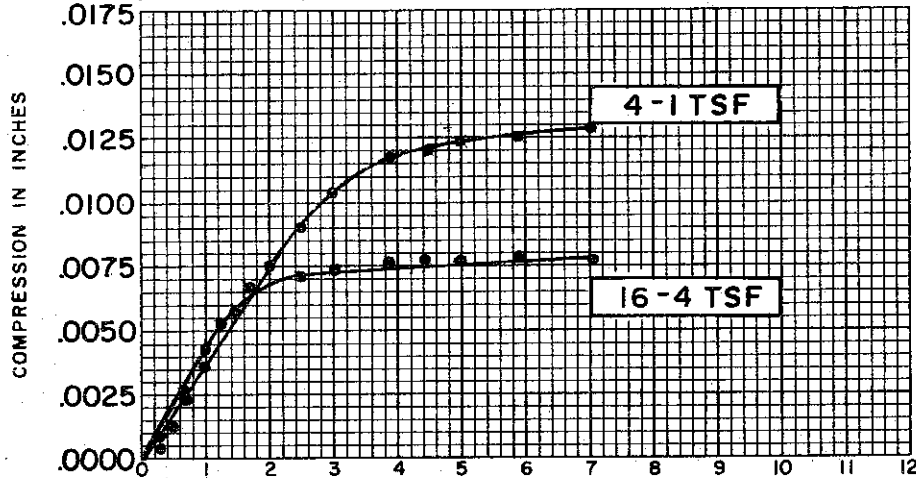
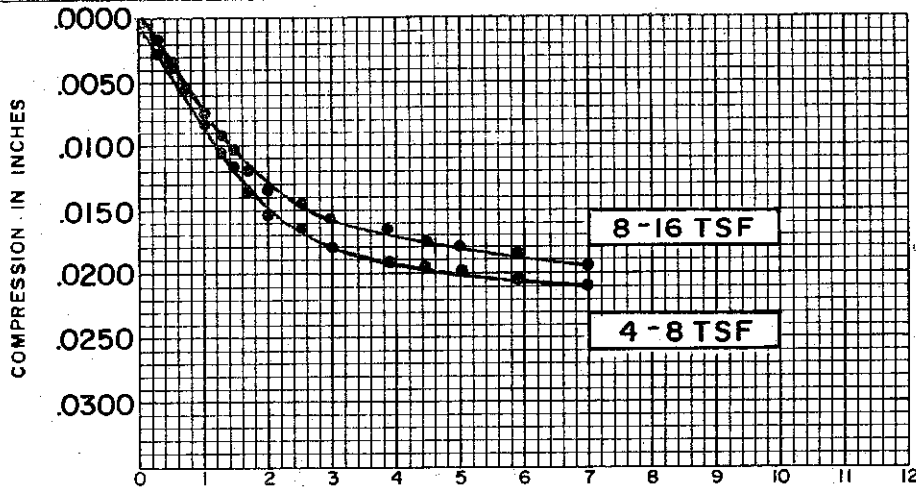

COMPRESSION IN INCHES

COMPRESSION IN INCHES

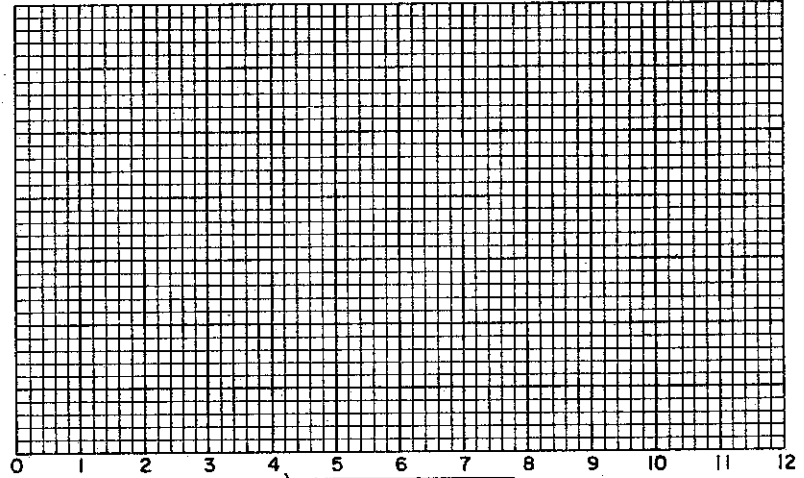
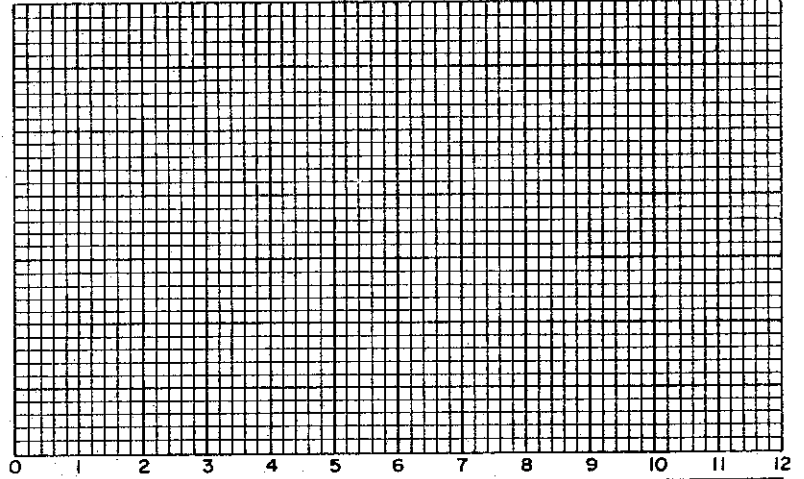

√TIME IN MINUTES

SOIL PROPERTIES		BORING NO. <u>49</u>
SOIL DESCRIPTION:	<u>SILTY CLAY (CL)</u>	SAMPLE NO. <u>11</u>
SPECIFIC GRAVITY	<u>2.68</u>	DEPTH <u>93.8' TO 94.0'</u>
INITIAL WATER CONTENT	<u>28.6%</u>	
FINAL WATER CONTENT	<u>24.4%</u>	

TEST DATA	
INITIAL SAMPLE HEIGHT	<u>0.75"</u>
INITIAL SAMPLE DIAMETER	<u>2.50"</u>
INITIAL VOID RATIO	<u>0.701</u>

CONSOLIDATION TEST
 TIME VS. COMPRESSION CURVES
 THE DETROIT EDISON COMPANY
 BELLE RIVER PLANT UNITS I & II

C-507

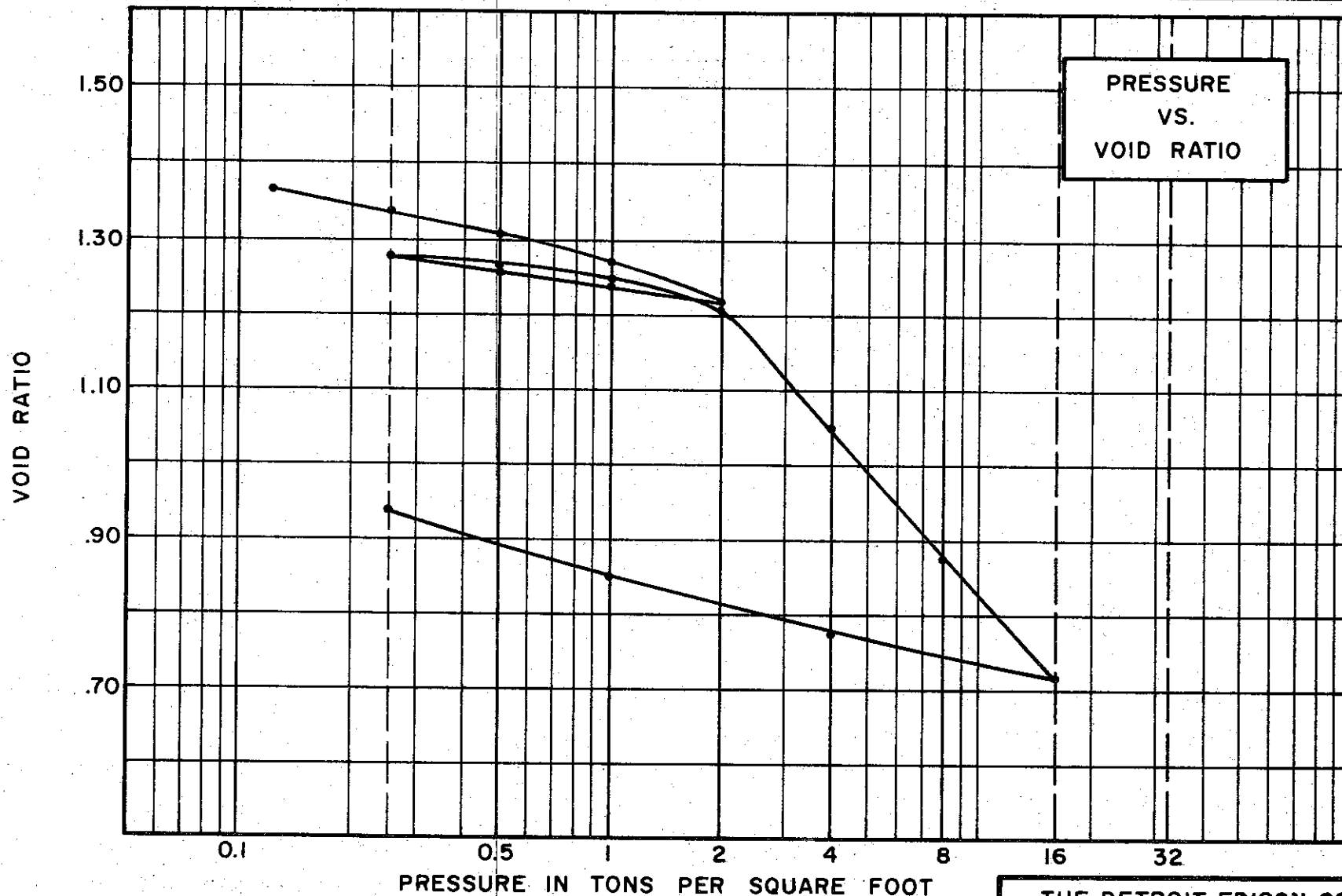

SOIL PROPERTIES

SOIL DESCRIPTION SILTY CLAY (CH)
 SPECIFIC GRAVITY 2.75
 WATER CONTENT, INITIAL 51.6% FINAL 39.9%
 ATTERBERG LIMITS:
 LIQUID LIMIT 55 % PLASTIC LIMIT 23 %

TEST DATA

INITIAL SAMPLE HEIGHT 0.80"
 INITIAL SAMPLE DIAMETER 2.50"
 INITIAL VOID RATIO 1.383

THE DETROIT EDISON COMPANY
 BELLE RIVER PLANT UNITS I & II

**CONSOLIDATION TEST
 VOID RATIO VS. LOG PRESSURE**

BORING NO. 50 TEST NO. C86.1
 SAMPLE NO. 8 DATE JULY 1974
 DEPTH 38.5' TO 38.9'

C-509

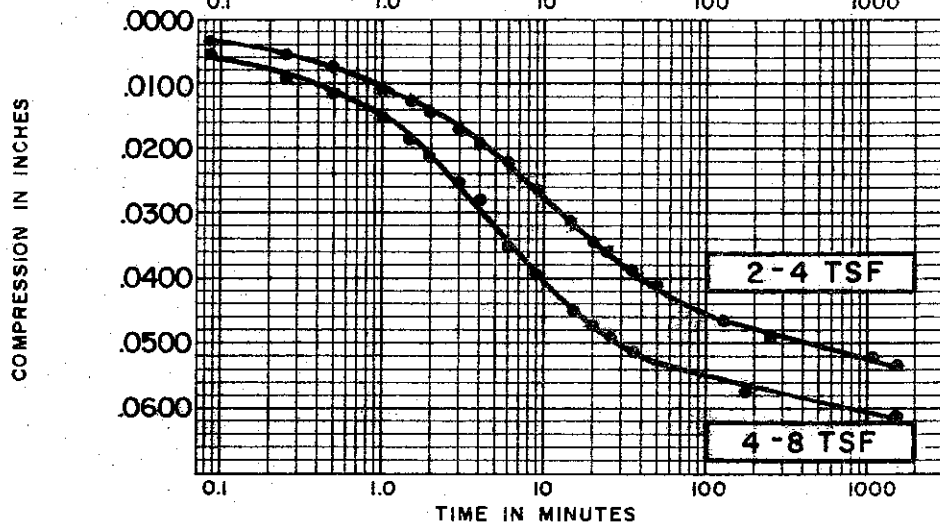
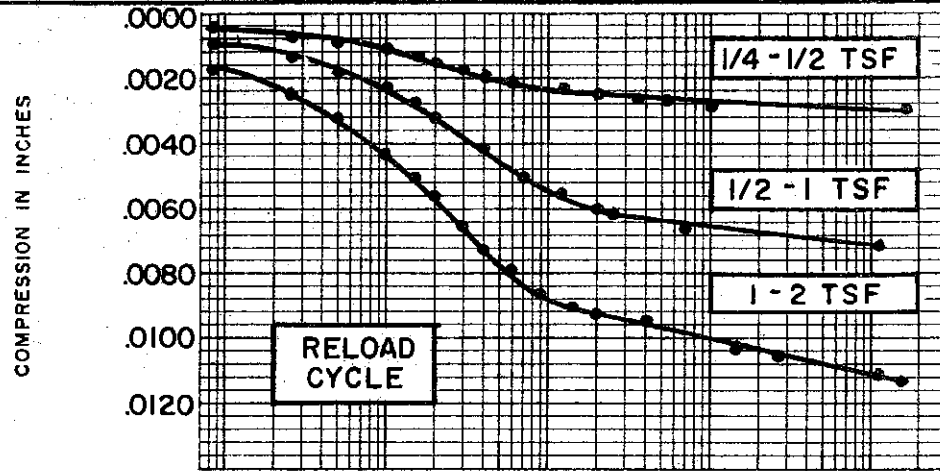
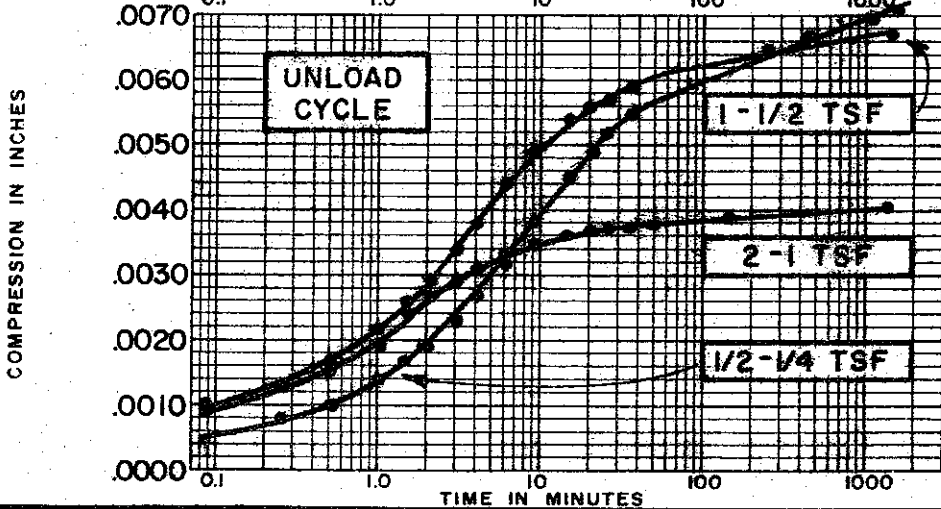
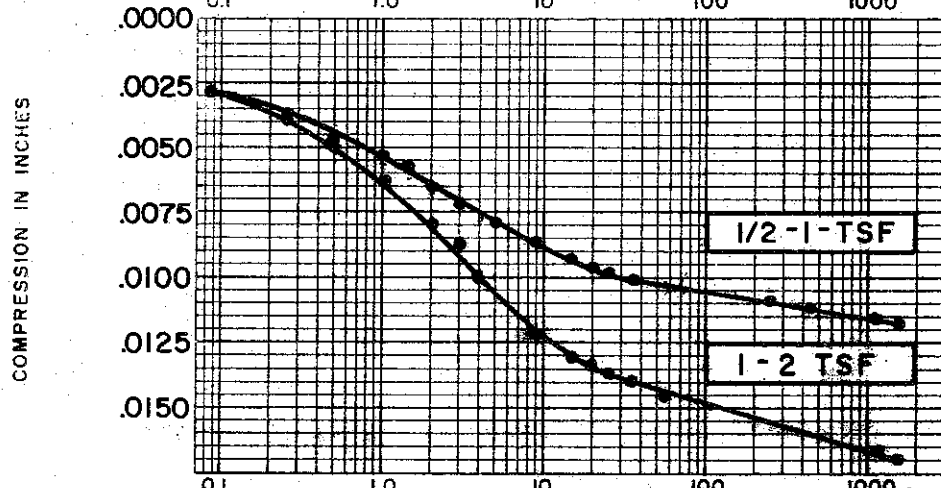
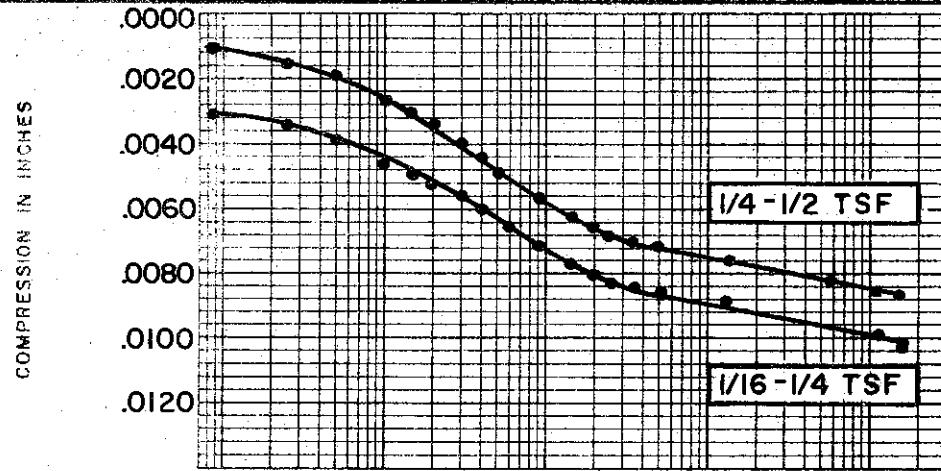

SOIL PROPERTIES

SOIL DESCRIPTION: SILTY CLAY (CH)
 SPECIFIC GRAVITY 2.75
 INITIAL WATER CONTENT 51.6 %
 FINAL WATER CONTENT 39.9 %

BORING NO. 50
 SAMPLE NO. 8
 DEPTH 38.5' - 38.9'

TEST DATA

INITIAL SAMPLE HEIGHT 0.80"
 INITIAL SAMPLE D. AMETER 2.50"
 INITIAL VOID RATIO 1.383

**CONSOLIDATION TEST
 TIME VS. COMPRESSION CURVES**

THE DETROIT EDISON COMPANY
 BELLE RIVER PLANT UNITS I & II

COMPRESSION IN INCHES

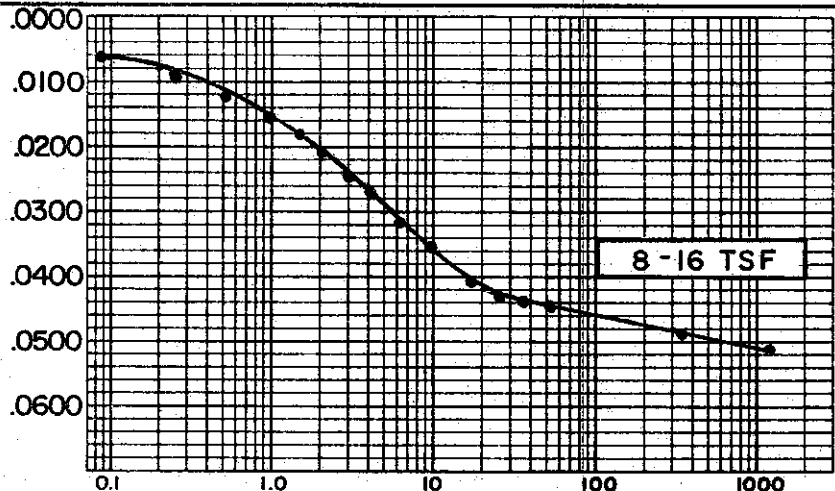

COMPRESSION IN INCHES

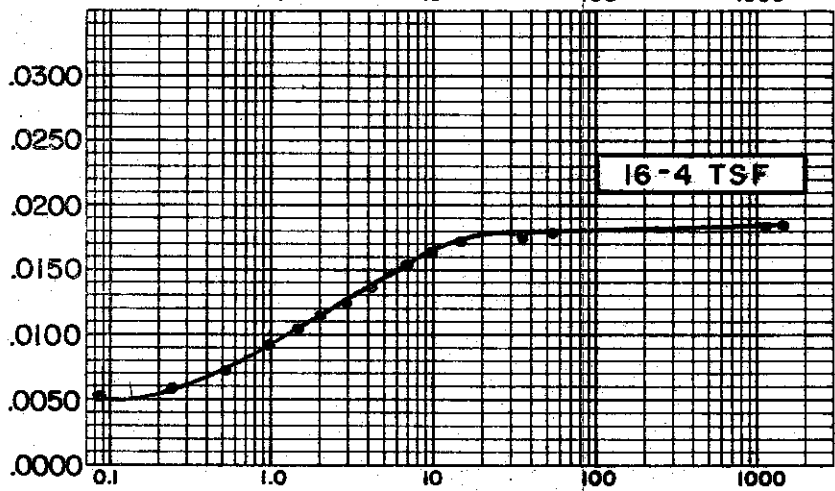

COMPRESSION IN INCHES

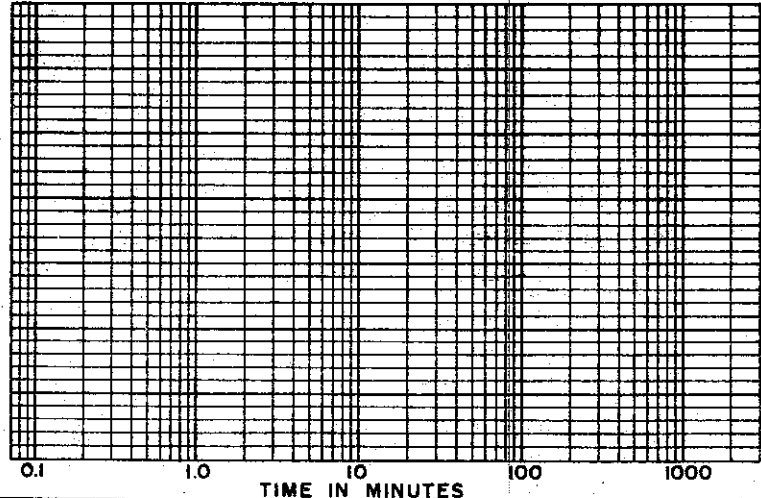

COMPRESSION IN INCHES

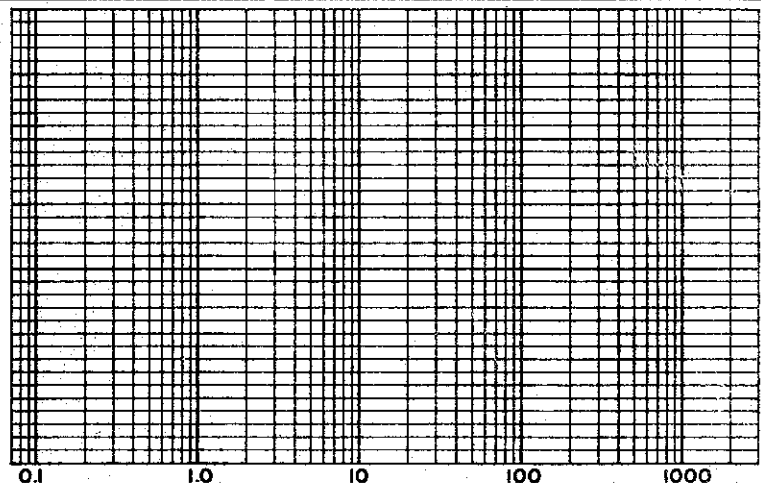

COMPRESSION IN INCHES

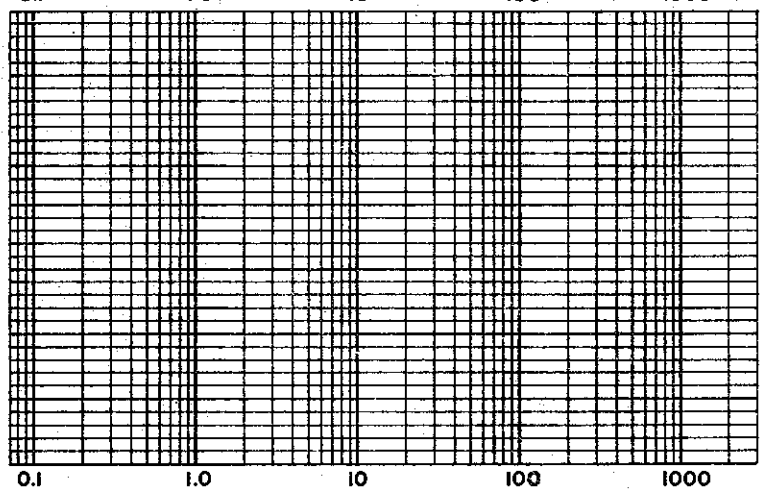

TIME IN MINUTES

SOIL PROPERTIES

SOIL DESCRIPTION: SILTY CLAY (CH)
 SPECIFIC GRAVITY 2.75
 INITIAL WATER CONTENT 51.6 %
 FINAL WATER CONTENT 39.9 %

BORING NO. 50
 SAMPLE NO. 8
 DEPTH 38.5'-38.9'

TEST DATA

INITIAL SAMPLE HEIGHT 0.80"
 INITIAL SAMPLE DIAMETER 2.50"
 INITIAL VOID RATIO 1.383

**CONSOLIDATION TEST
 TIME VS. COMPRESSION CURVES**

THE DETROIT EDISON COMPANY
 BELLE RIVER PLANT UNITS I & II

C-511

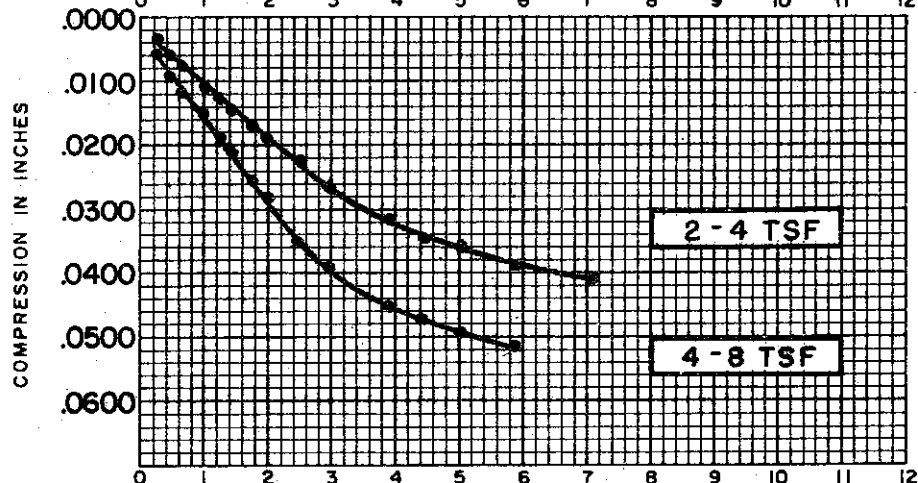
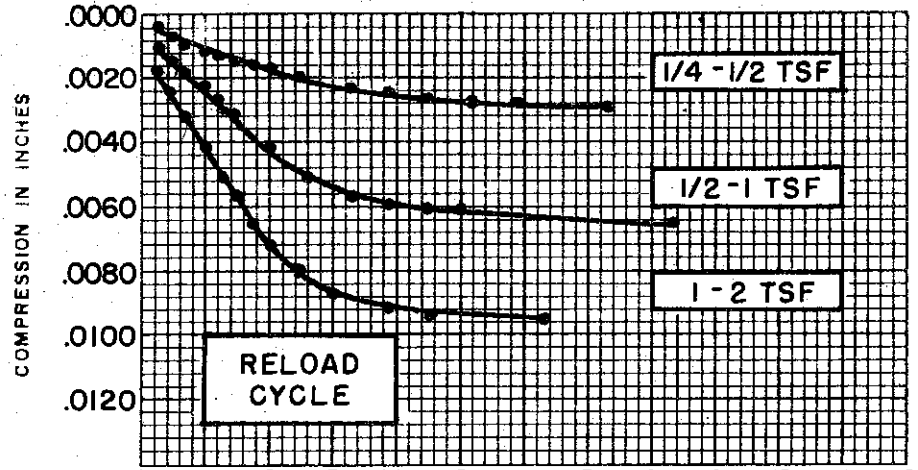
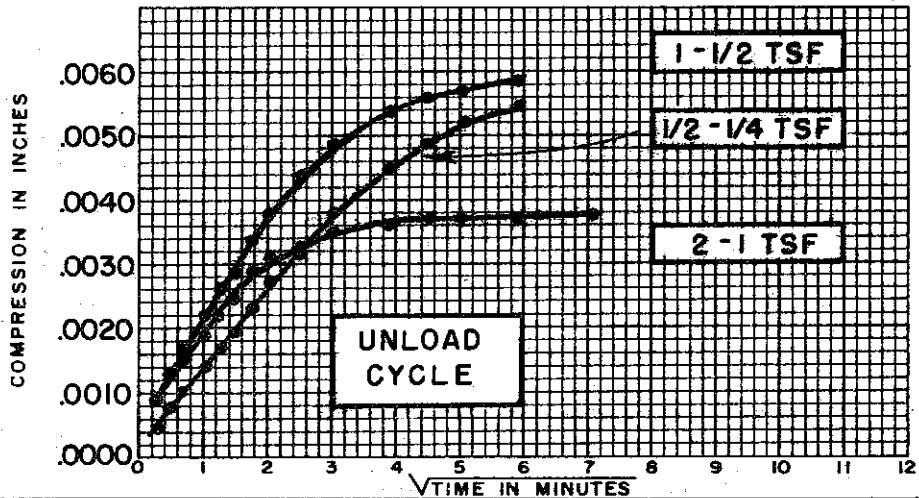
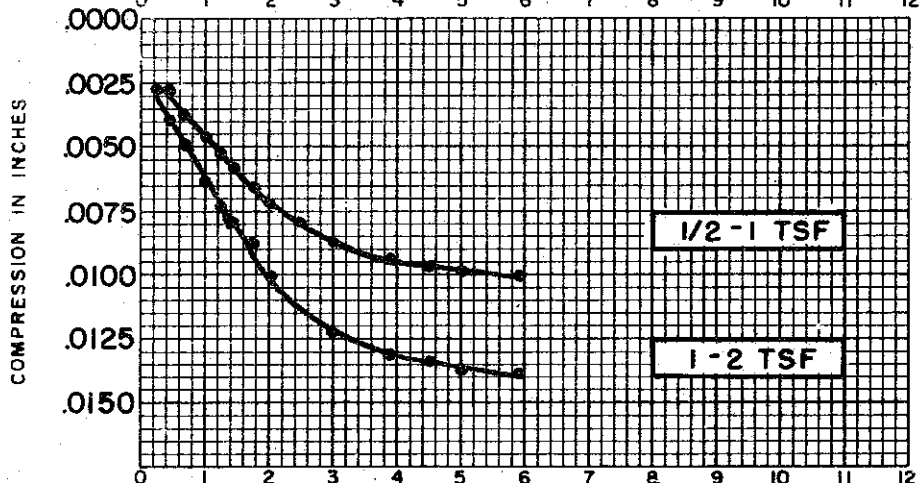
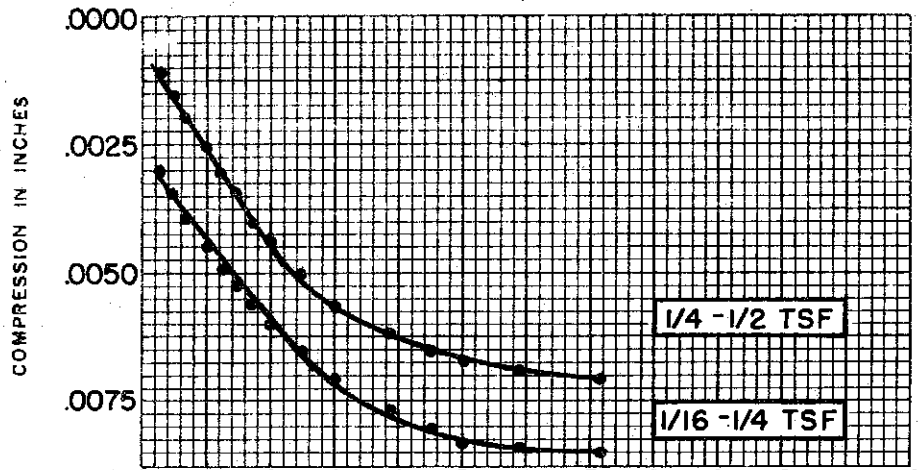

SOIL PROPERTIES
 SOIL DESCRIPTION: SILTY CLAY (CH)
 SPECIFIC GRAVITY 2.75
 INITIAL WATER CONTENT 51.6 %
 FINAL WATER CONTENT 39.9 %

BORING NO. 50
 SAMPLE NO. 8
 DEPTH 38.5' - 38.9'

TEST DATA
 INITIAL SAMPLE HEIGHT 0.80"
 INITIAL SAMPLE DIAMETER 2.50"
 INITIAL VOID RATIO 1.383

**CONSOLIDATION TEST
 TIME VS. COMPRESSION CURVES**

THE DETROIT EDISON COMPANY
 BELLE RIVER PLANT UNITS I & II

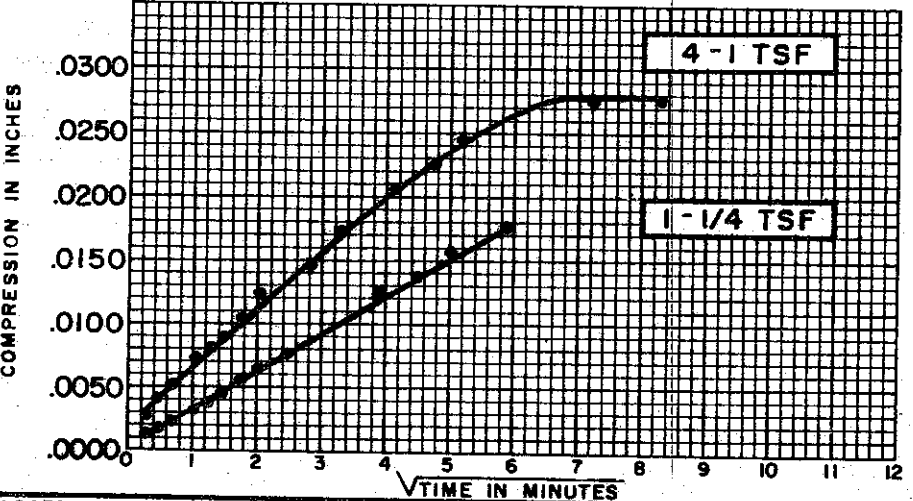
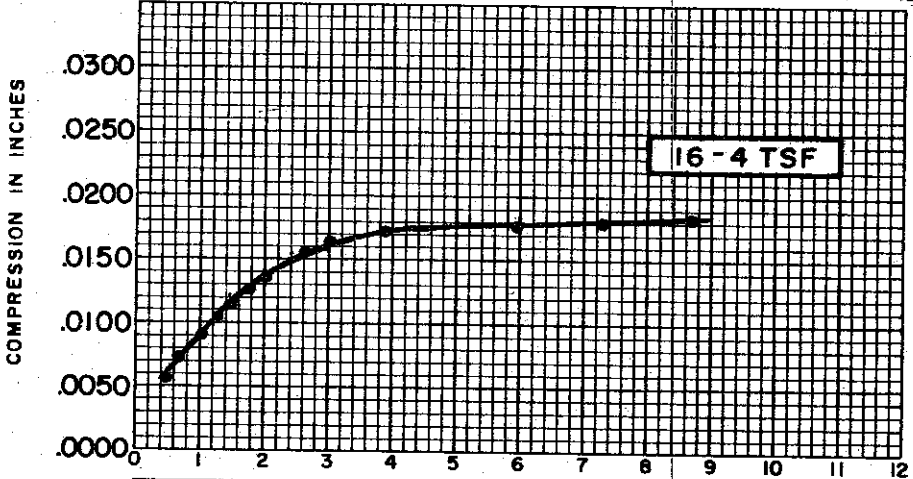
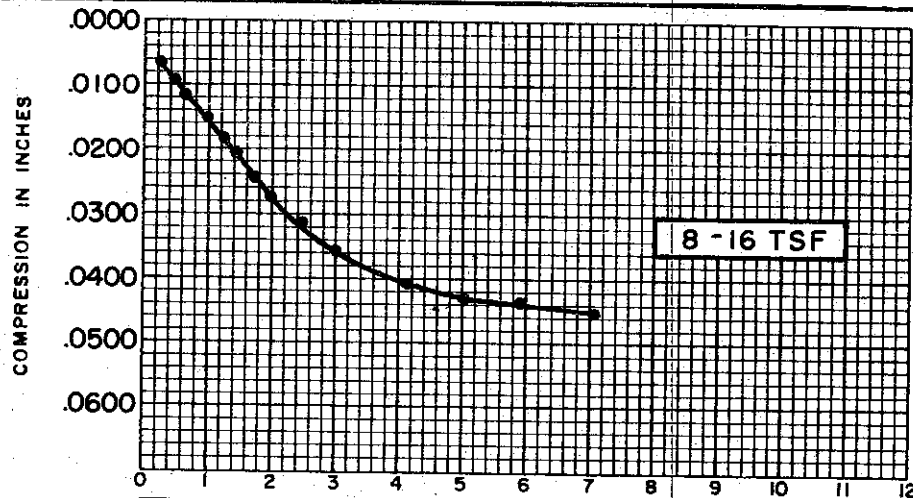

COMPRESSION IN INCHES

COMPRESSION IN INCHES

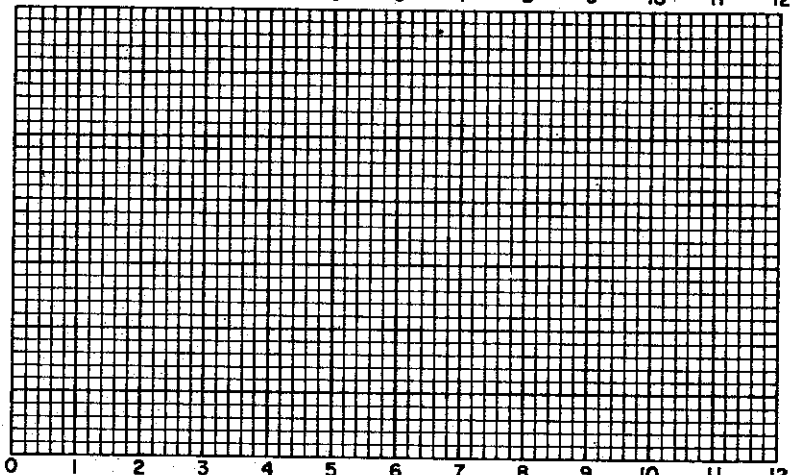
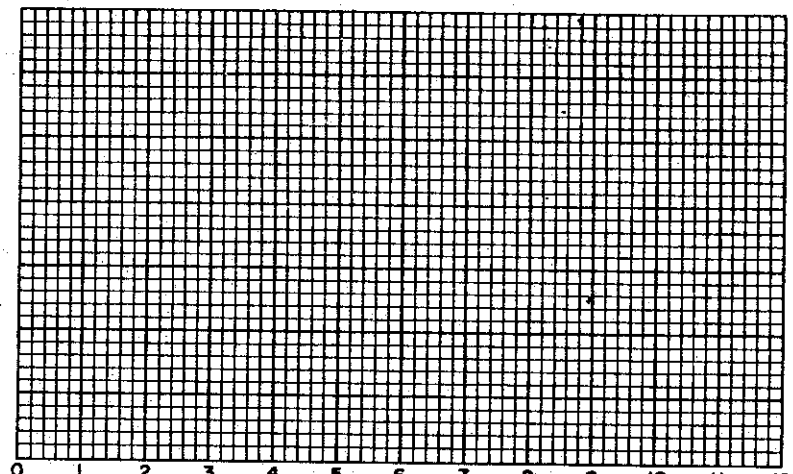

√TIME IN MINUTES

SOIL PROPERTIES		BORING NO. <u>50</u>
SOIL DESCRIPTION:	<u>SILTY CLAY (CH)</u>	SAMPLE NO. <u>8</u>
SPECIFIC GRAVITY	<u>2.75</u>	DEPTH <u>38.5'-38.9'</u>
INITIAL WATER CONTENT	<u>51.6 %</u>	
FINAL WATER CONTENT	<u>39.9 %</u>	

TEST DATA	
INITIAL SAMPLE HEIGHT	<u>0.80"</u>
INITIAL SAMPLE DIAMETER	<u>2.50"</u>
INITIAL VOID RATIO	<u>1.383</u>

**CONSOLIDATION TEST
TIME VS. COMPRESSION CURVES**

THE DETROIT EDISON COMPANY
BELLE RIVER PLANT UNITS I & II

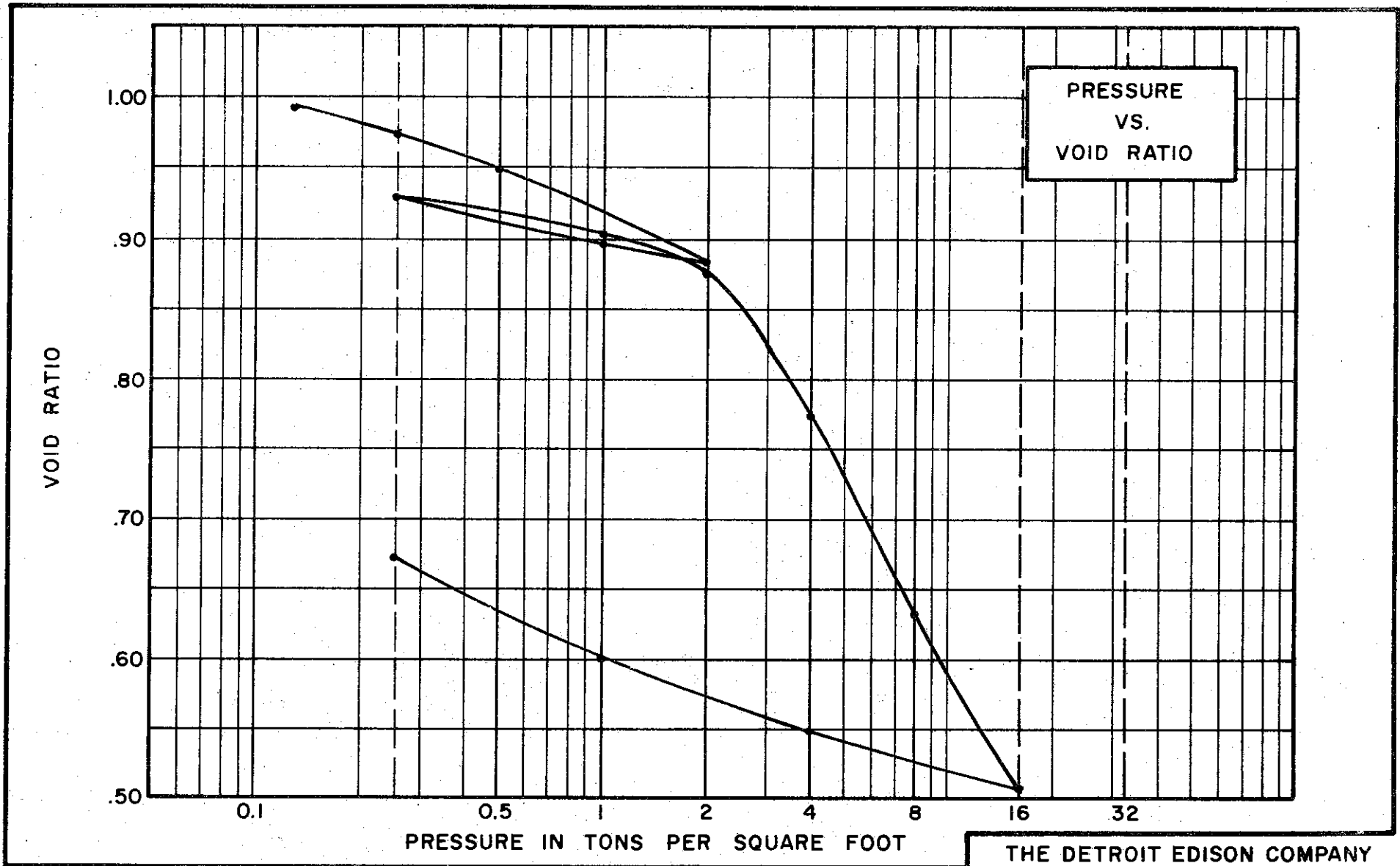

SOIL PROPERTIES

SOIL DESCRIPTION SILTY CLAY (CL-CH)
 SPECIFIC GRAVITY 2.70
 WATER CONTENT, INITIAL 40.5% FINAL 28.9%
 ATTERBERG LIMITS:
 LIQUID LIMIT 49 % PLASTIC LIMIT 20 %

TEST DATA

INITIAL SAMPLE HEIGHT 0.80"
 INITIAL SAMPLE DIAMETER 2.50"
 INITIAL VOID RATIO 1.013

THE DETROIT EDISON COMPANY
 BELLE RIVER PLANT UNITS I & II

**CONSOLIDATION TEST
 VOID RATIO VS. LOG PRESSURE**

BORING NO. 52 TEST NO. C109.1
 SAMPLE NO. 4 DATE JULY 1974
 DEPTH 29.9' TO 30.2'

C-513

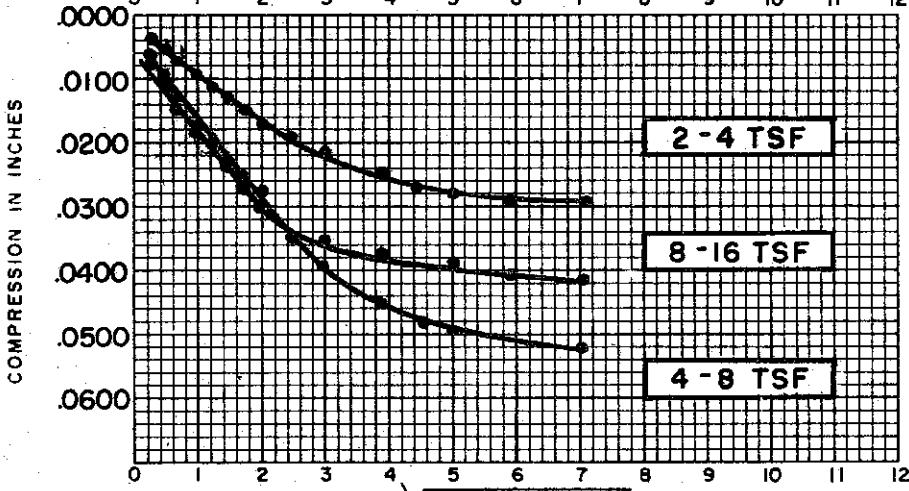
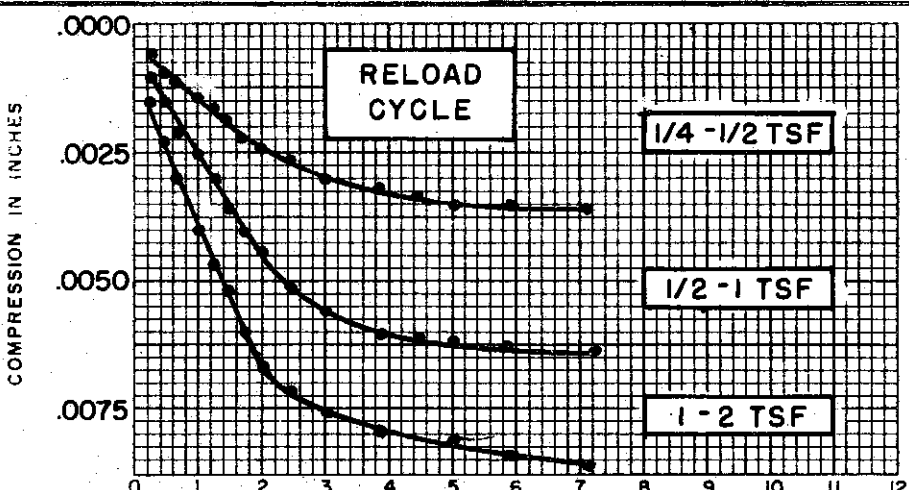
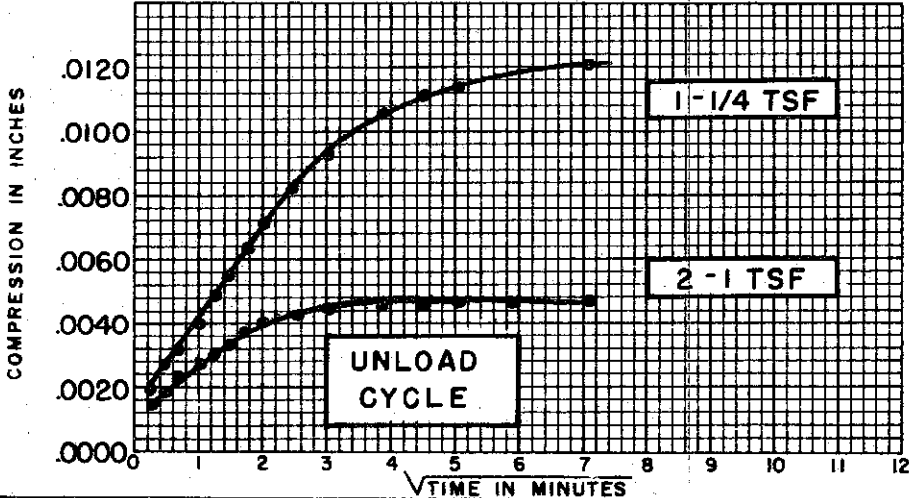
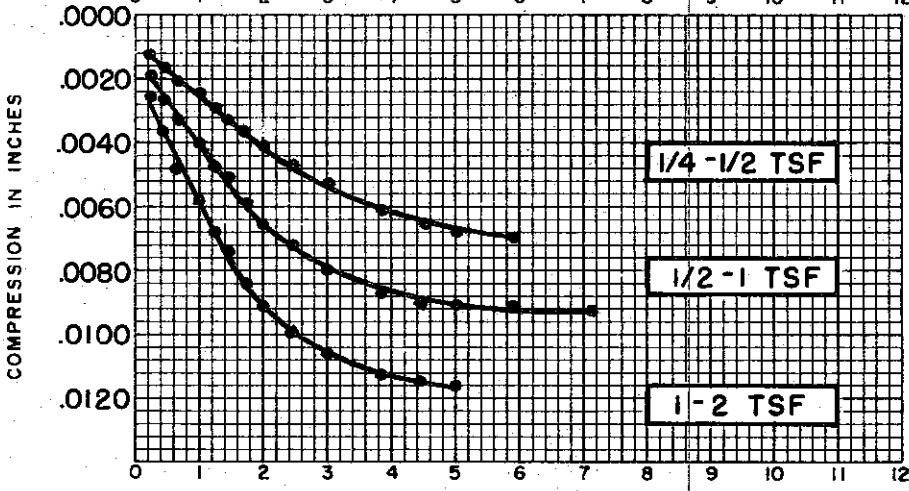
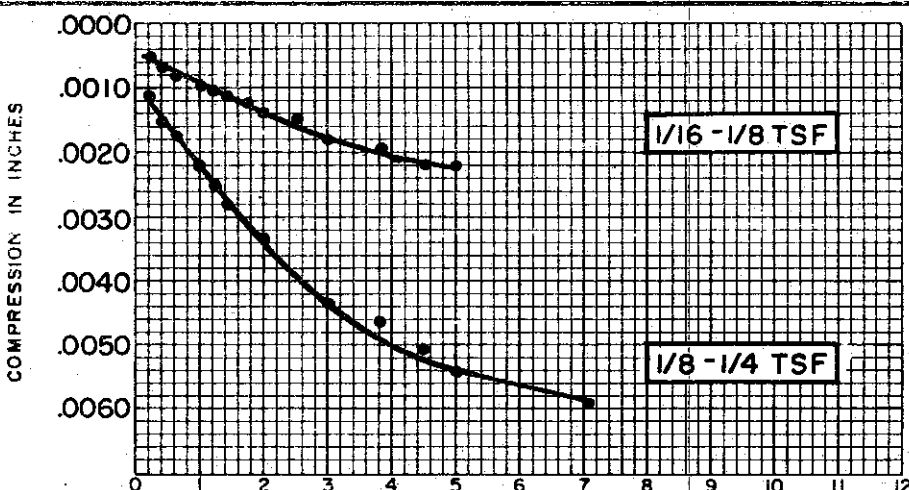

SOIL PROPERTIES	
SOIL DESCRIPTION:	SILTY CLAY (CL-CH)
SPECIFIC GRAVITY	2.70
INITIAL WATER CONTENT	40.5 %
FINAL WATER CONTENT	28.9 %
BORING NO.	52
SAMPLE NO.	4
DEPTH	29.9' - 30.2'

TEST DATA	
INITIAL SAMPLE HEIGHT	0.80"
INITIAL SAMPLE DIAMETER	2.50"
INITIAL VOID RATIO	1.013

CONSOLIDATION TEST
 TIME VS. COMPRESSION CURVES
 THE DETROIT EDISON COMPANY
 BELLE RIVER PLANT UNITS I & II

C-515

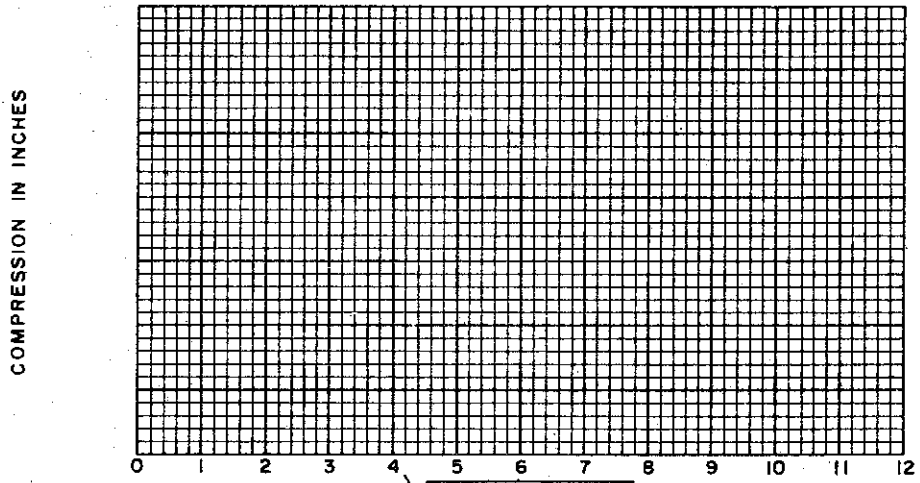
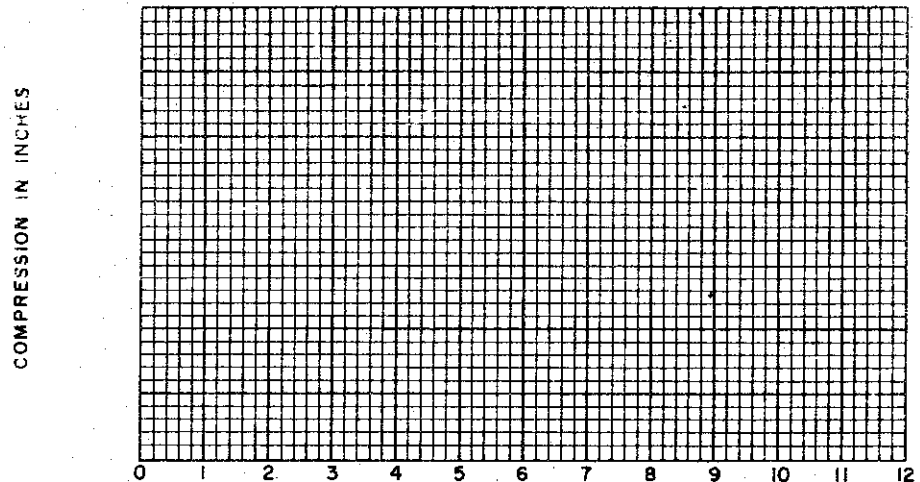
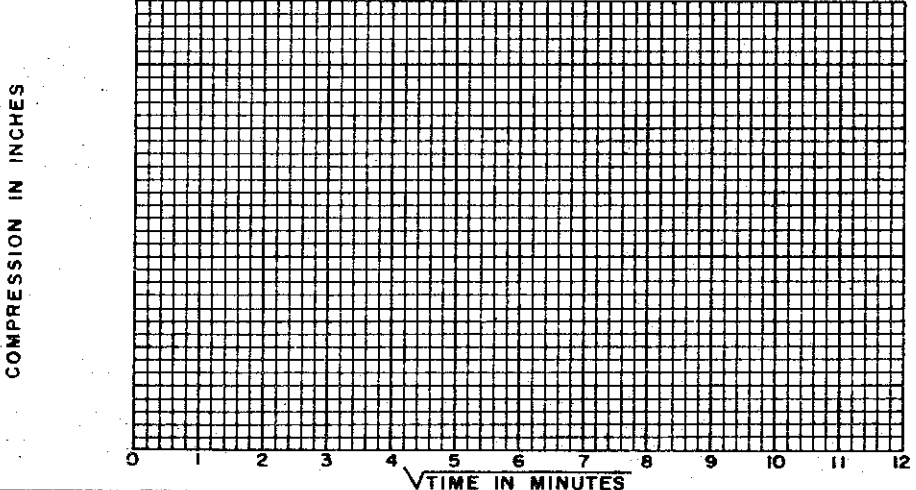
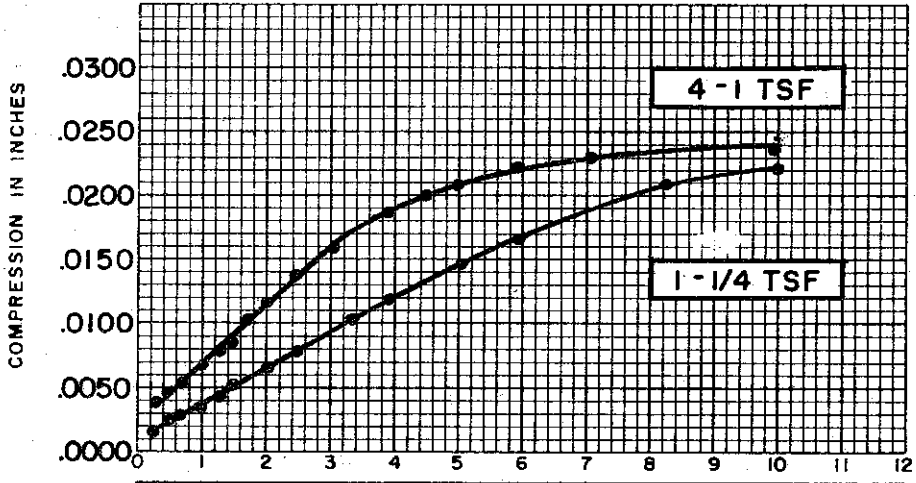
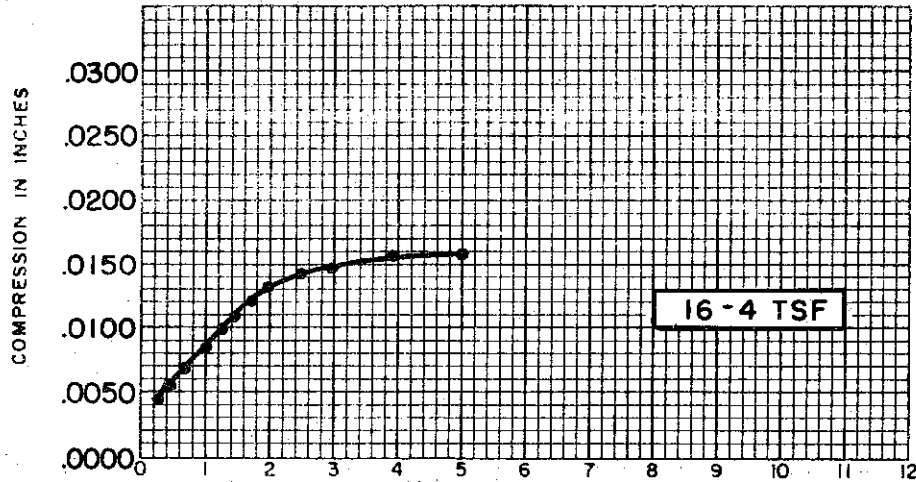

SOIL PROPERTIES		BORING NO.	52
SOIL DESCRIPTION:	SILTY CLAY (CL-CH)	SAMPLE NO.	4
SPECIFIC GRAVITY	2.70	DEPTH	29.9'-30.2'
INITIAL WATER CONTENT	40.5 %		
FINAL WATER CONTENT	28.9 %		

TEST DATA	
INITIAL SAMPLE HEIGHT	0.80"
INITIAL SAMPLE DIAMETER	2.50"
INITIAL VOID RATIO	1.013

CONSOLIDATION TEST
 TIME VS. COMPRESSION CURVES
 THE DETROIT EDISON COMPANY
 BELLE RIVER PLANT UNITS I & II

COMPRESSION IN INCHES

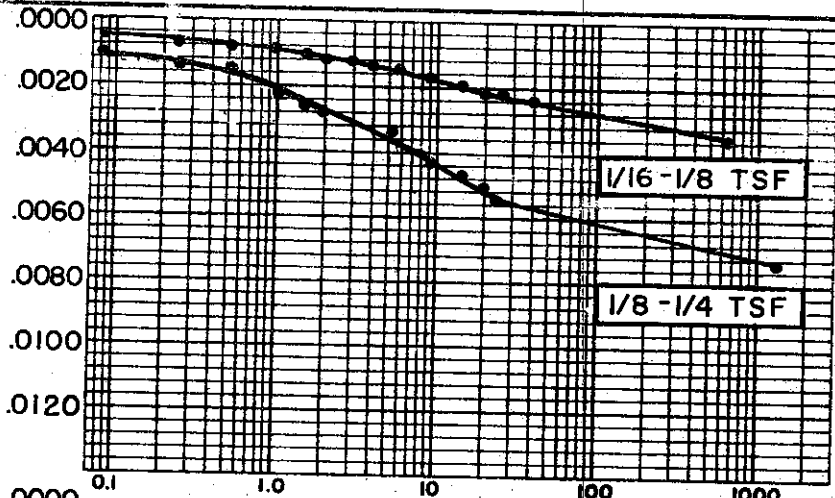

COMPRESSION IN INCHES

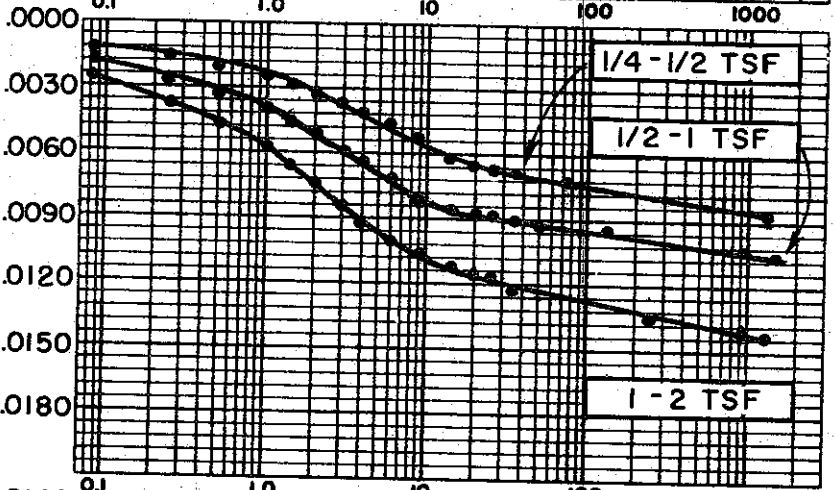

COMPRESSION IN INCHES

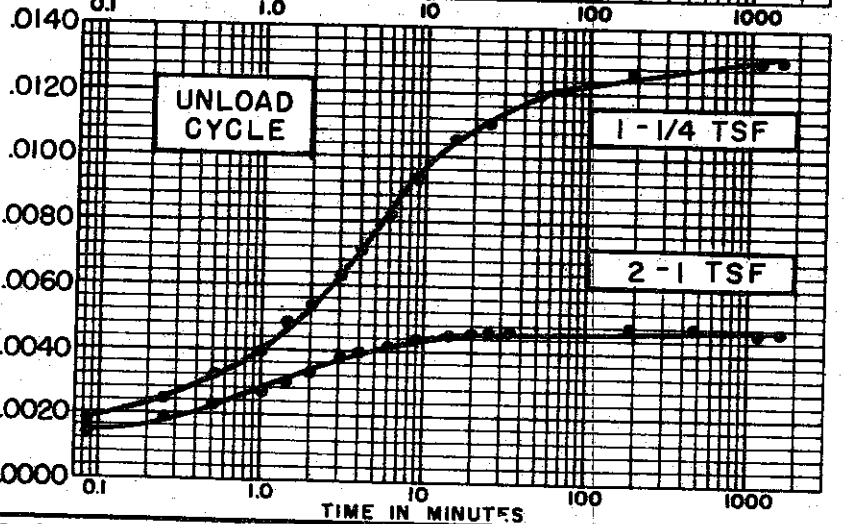

COMPRESSION IN INCHES

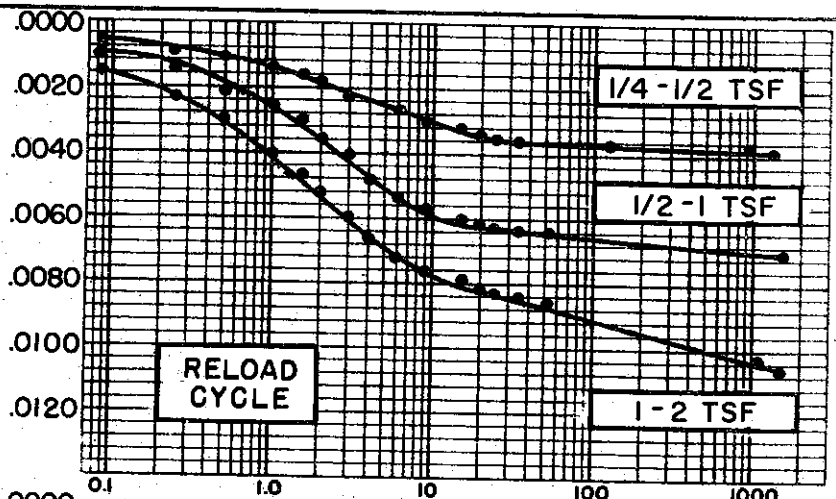

COMPRESSION IN INCHES

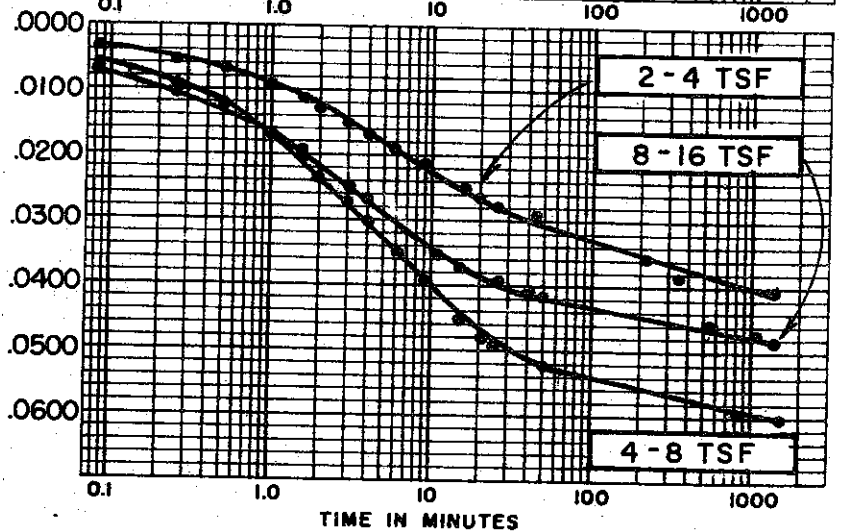

TIME IN MINUTES

SOIL PROPERTIES

SOIL DESCRIPTION: SILTY CLAY (CL-CH)
SPECIFIC GRAVITY 2.70
INITIAL WATER CONTENT 40.5 %
FINAL WATER CONTENT 28.9 %

BORING NO. 52
SAMPLE NO. 4
DEPTH 29.9'-30.2'

TEST DATA

INITIAL SAMPLE HEIGHT 0.80"
INITIAL SAMPLE DIAMETER 2.50"
INITIAL VOID RATIO 1.013

**CONSOLIDATION TEST
TIME VS. COMPRESSION CURVES**

THE DETROIT EDISON COMPANY
BELLE RIVER PLANT UNITS I & II

COMPRESSION IN INCHES

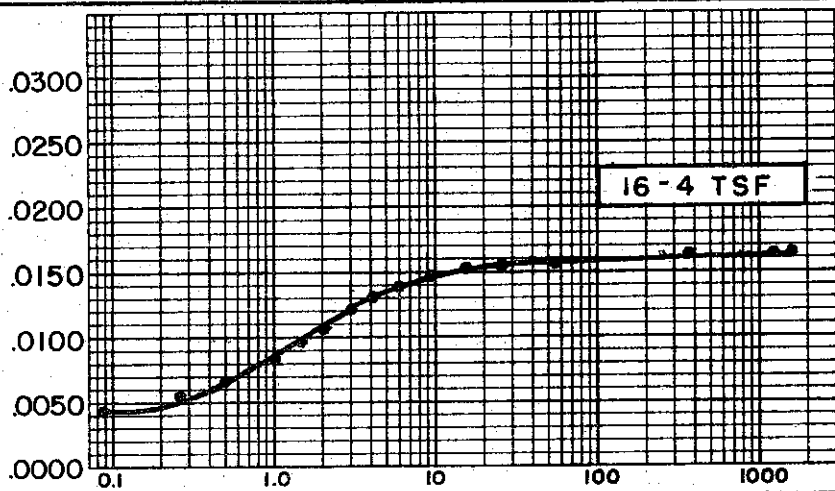

COMPRESSION IN INCHES

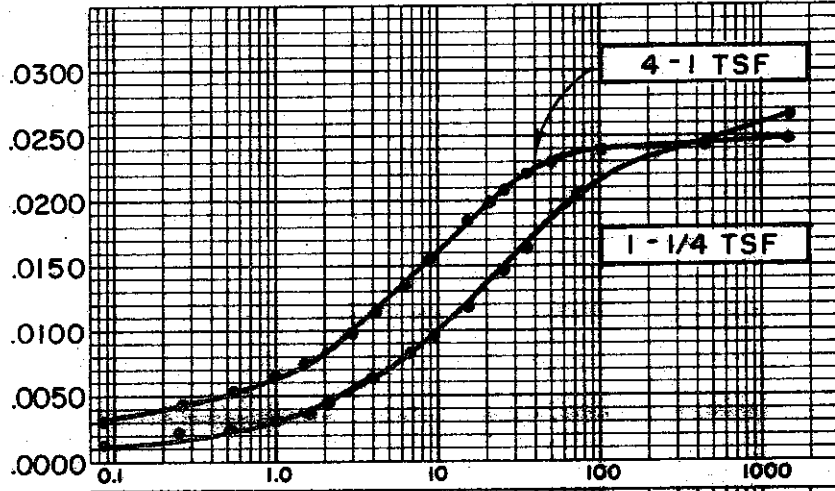

COMPRESSION IN INCHES

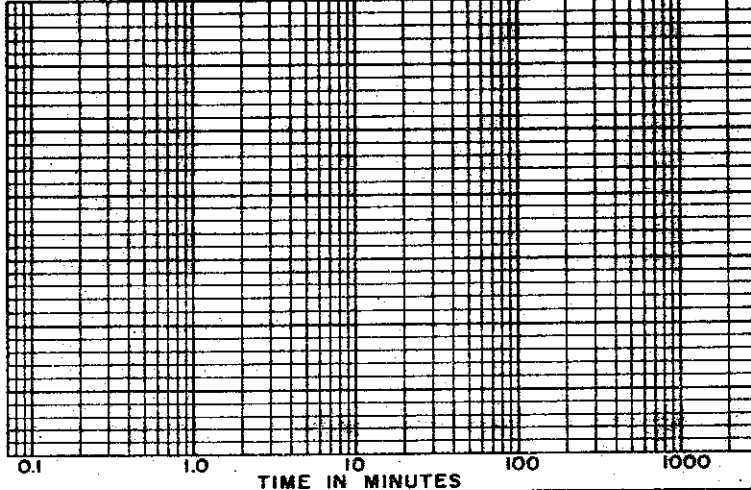

COMPRESSION IN INCHES

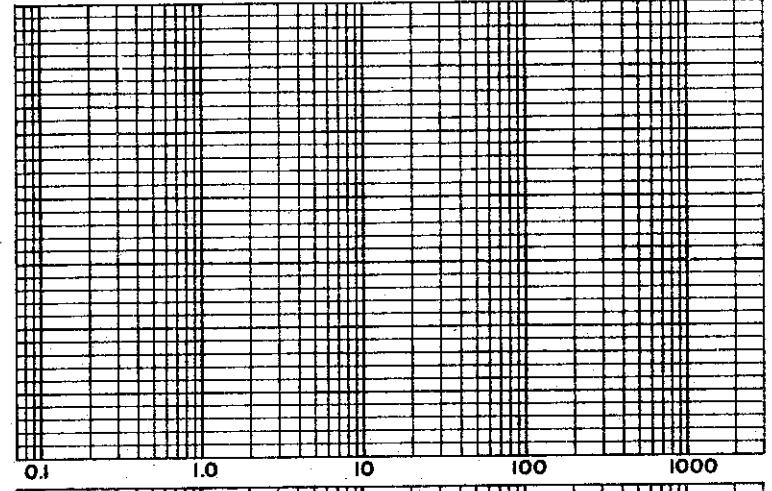

COMPRESSION IN INCHES

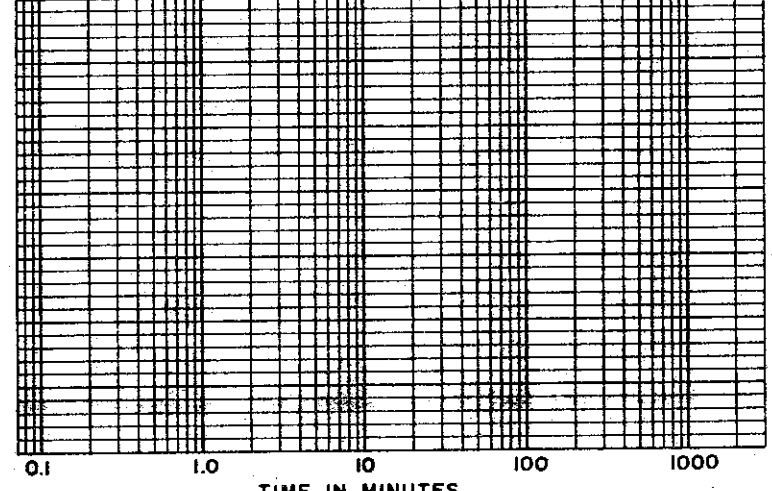

TIME IN MINUTES

SOIL PROPERTIES

SOIL DESCRIPTION: SILTY CLAY (CL-CH)
 SPECIFIC GRAVITY 2.70
 INITIAL WATER CONTENT 40.5 %
 FINAL WATER CONTENT 28.9 %

BORING NO. 52
 SAMPLE NO. 4
 DEPTH 29.9'-30.2'

TEST DATA

INITIAL SAMPLE HEIGHT 0.80"
 INITIAL SAMPLE DIAMETER 0.50"
 INITIAL VOID RATIO 1.013

**CONSOLIDATION TEST
TIME VS. COMPRESSION CURVE**

THE DETROIT EDISON COMPANY
 BELLE RIVER PLANT UNITS I & II

C-517

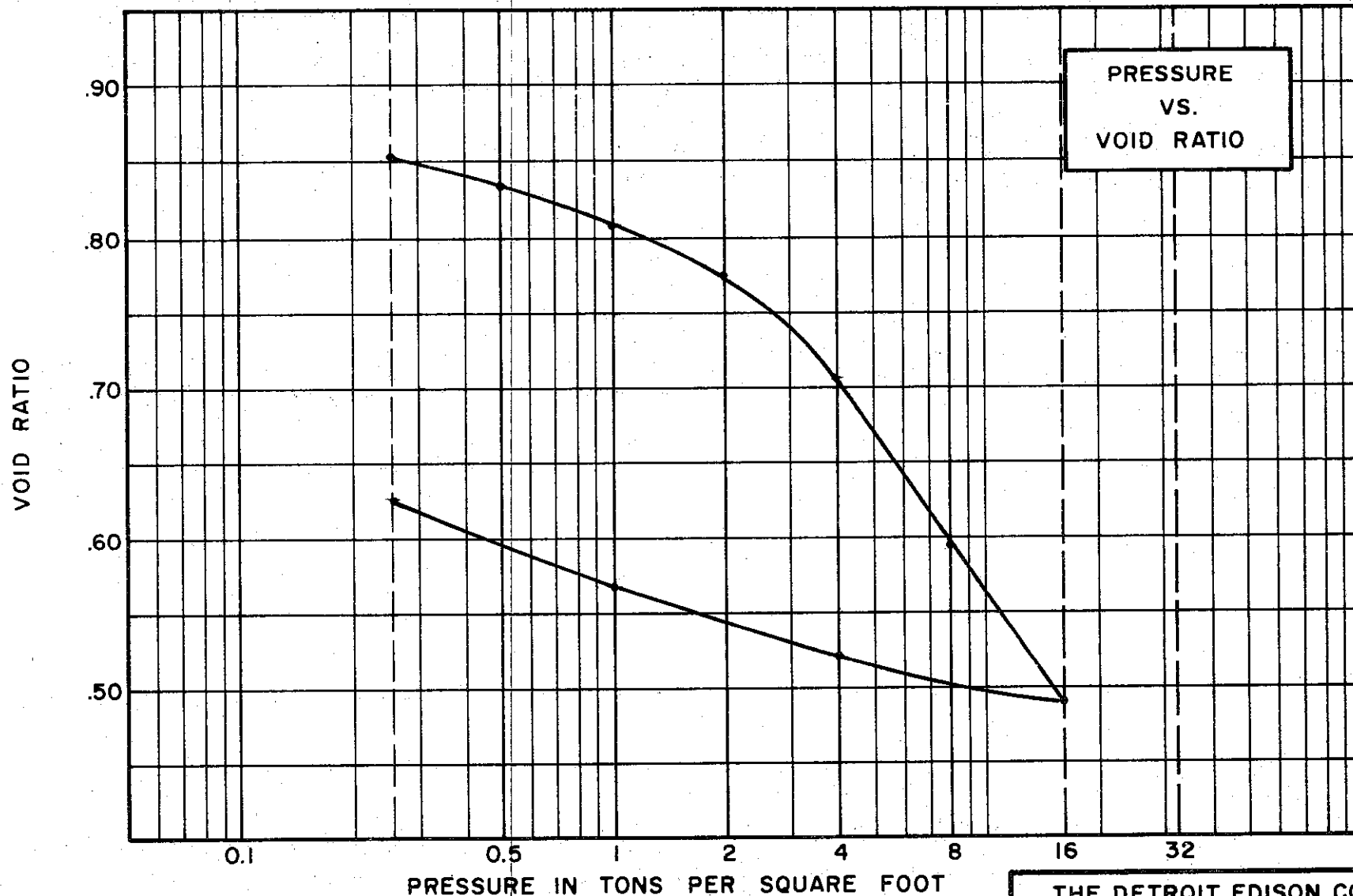

SOIL PROPERTIES

SOIL DESCRIPTION SILTY CLAY, SANDY (CL)
 SPECIFIC GRAVITY 2.72
 WATER CONTENT, INITIAL 30.9% FINAL 22.7%
 ATTERBERG LIMITS:
 LIQUID LIMIT 39 % PLASTIC LIMIT 20 %

TEST DATA

INITIAL SAMPLE HEIGHT 0.80"
 INITIAL SAMPLE DIAMETER 2.50"
 INITIAL VOID RATIO 0.872

THE DETROIT EDISON COMPANY
 BELLE RIVER PLANT UNITS I & II

**CONSOLIDATION TEST
 VOID RATIO VS. LOG PRESSURE**

BORING NO. 53 TEST NO. C98.1
 SAMPLE NO. 5 DATE JULY 1974
 DEPTH 39.5' TO 39.8'

C-519

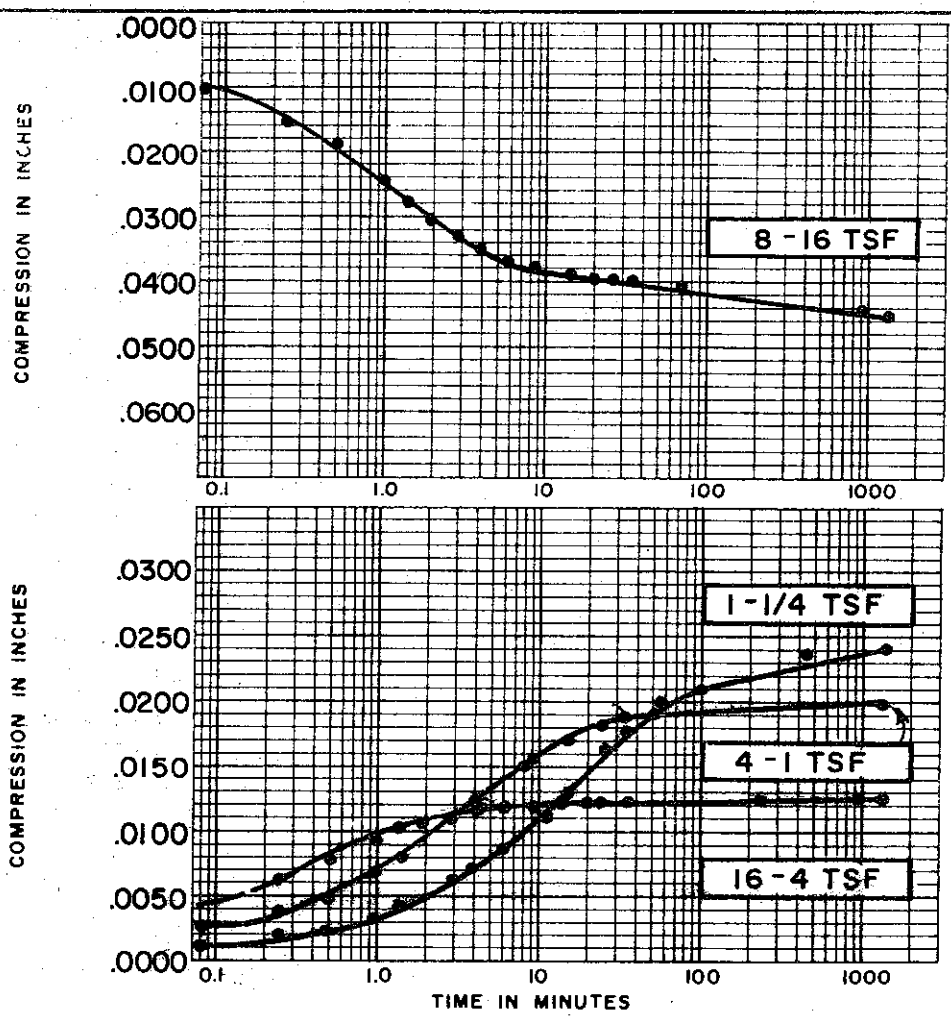
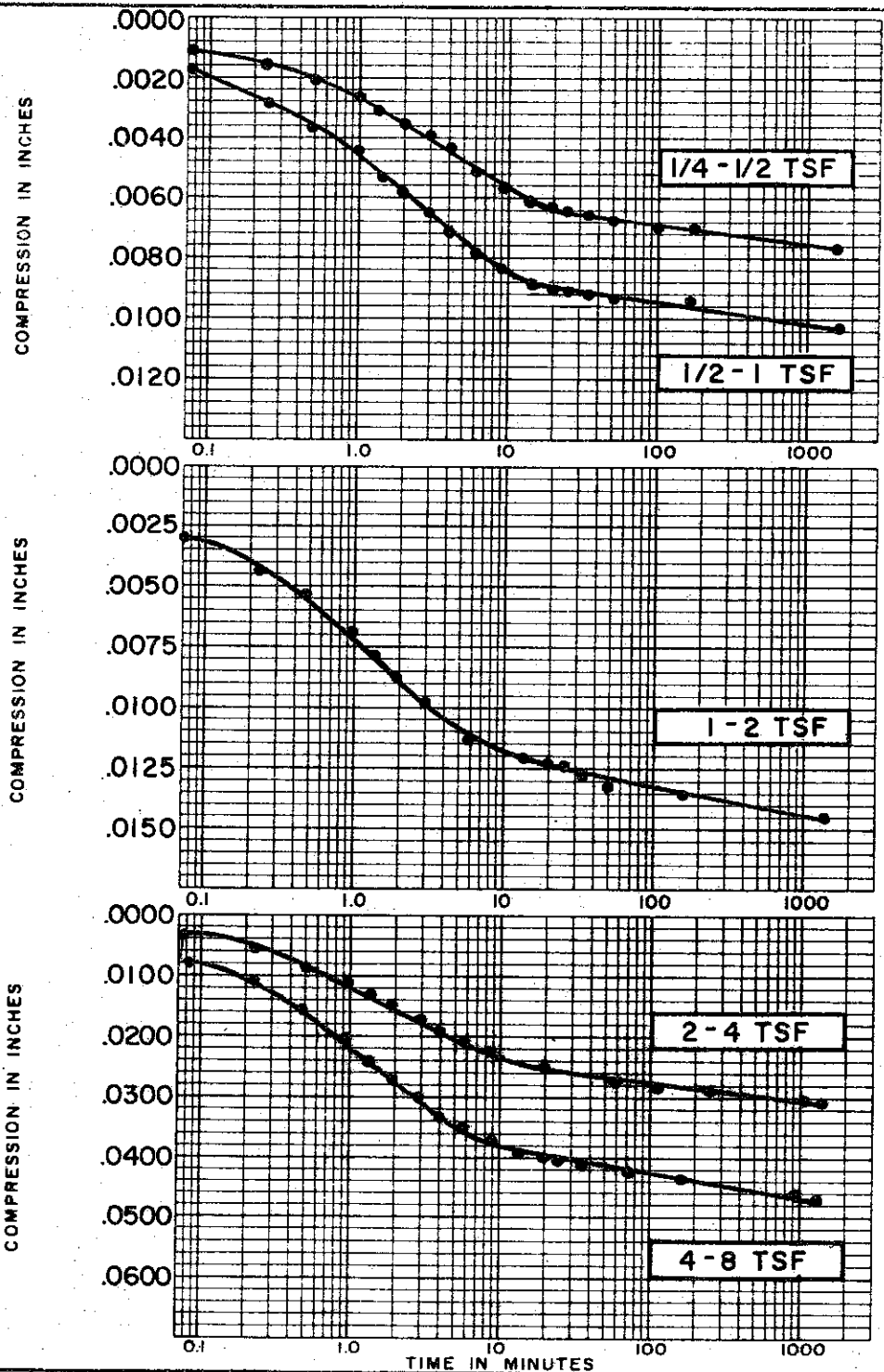

SOIL PROPERTIES	
SOIL DESCRIPTION:	<u>SILTY CLAY, SANDY (CL)</u>
SPECIFIC GRAVITY	<u>2.72</u>
INITIAL WATER CONTENT	<u>30.9 %</u>
FINAL WATER CONTENT	<u>22.7 %</u>
BORING NO.	<u>53</u>
SAMPLE NO.	<u>5</u>
DEPTH	<u>39.5' - 39.8'</u>
TEST DATA	
INITIAL SAMPLE HEIGHT	<u>0.80"</u>
INITIAL SAMPLE DIAMETER	<u>2.50"</u>
INITIAL VOID RATIO	<u>0.872</u>

CONSOLIDATION TEST
TIME VS. COMPRESSION CURVES
 THE DETROIT EDISON COMPANY
 BELLE RIVER PLANT UNITS I & II

C-520

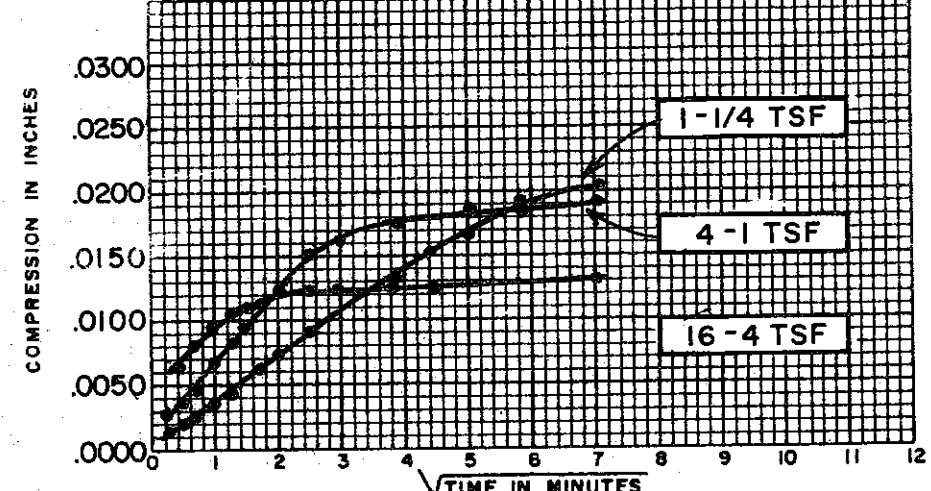
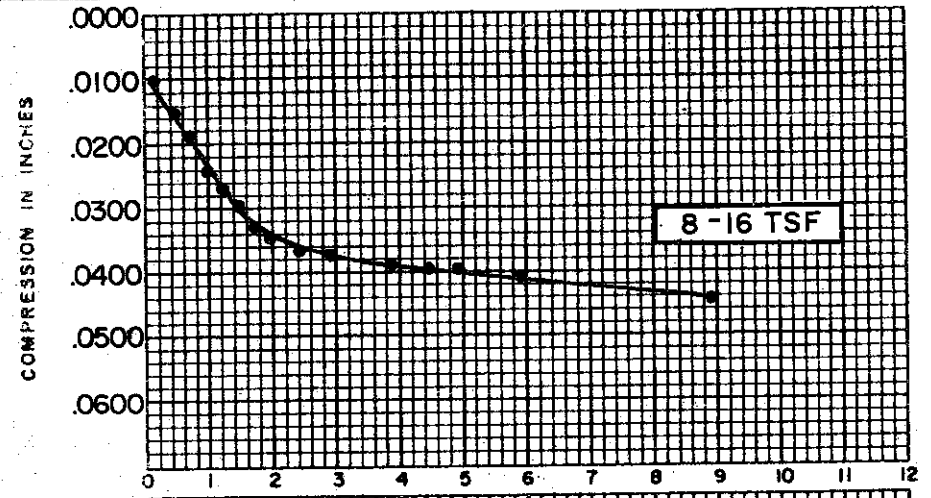
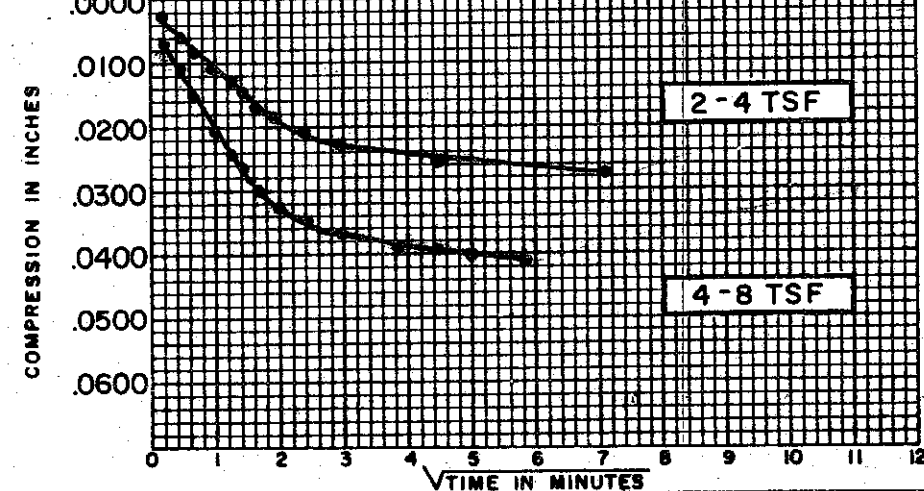
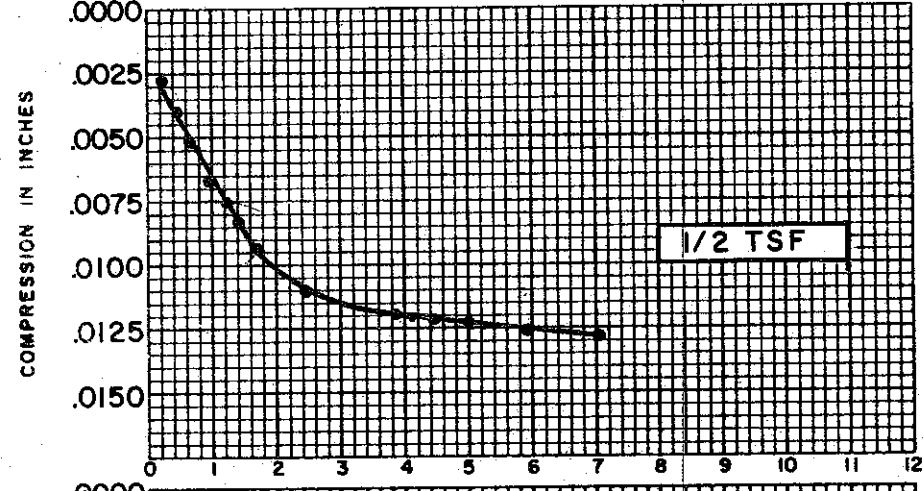
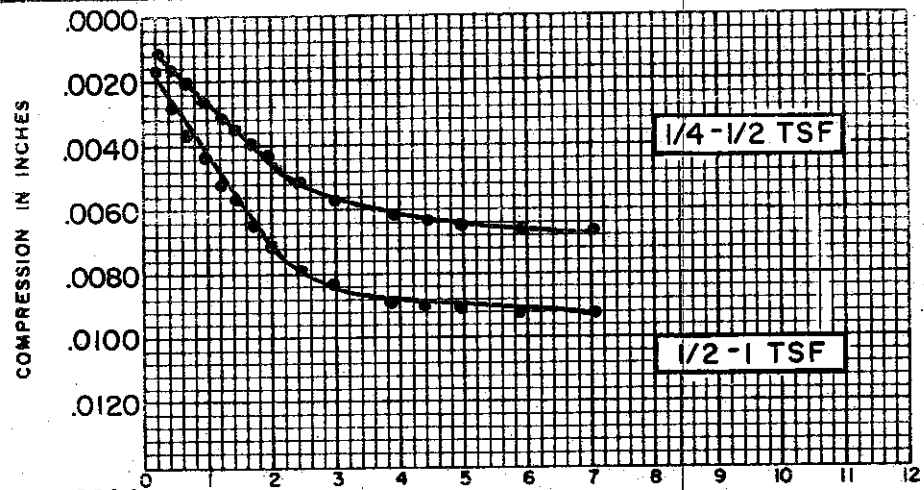

SOIL PROPERTIES	
SOIL DESCRIPTION:	SILTY CLAY, SANDY (CL)
SPECIFIC GRAVITY	2.72
INITIAL WATER CONTENT	30.9%
FINAL WATER CONTENT	22.7%
BORING NO.	53
SAMPLE NO.	5
DEPTH	39.5'-39.8'

TEST DATA	
INITIAL SAMPLE HEIGHT	0.80"
INITIAL SAMPLE DIAMETER	2.50"
INITIAL VOID RATIO	0.872

CONSOLIDATION TEST
 TIME VS. COMPRESSION CURVES
 THE DETROIT EDISON COMPANY
 BELLE RIVER PLANT UNITS I & II

**PRESSURE
VS.
VOID RATIO**

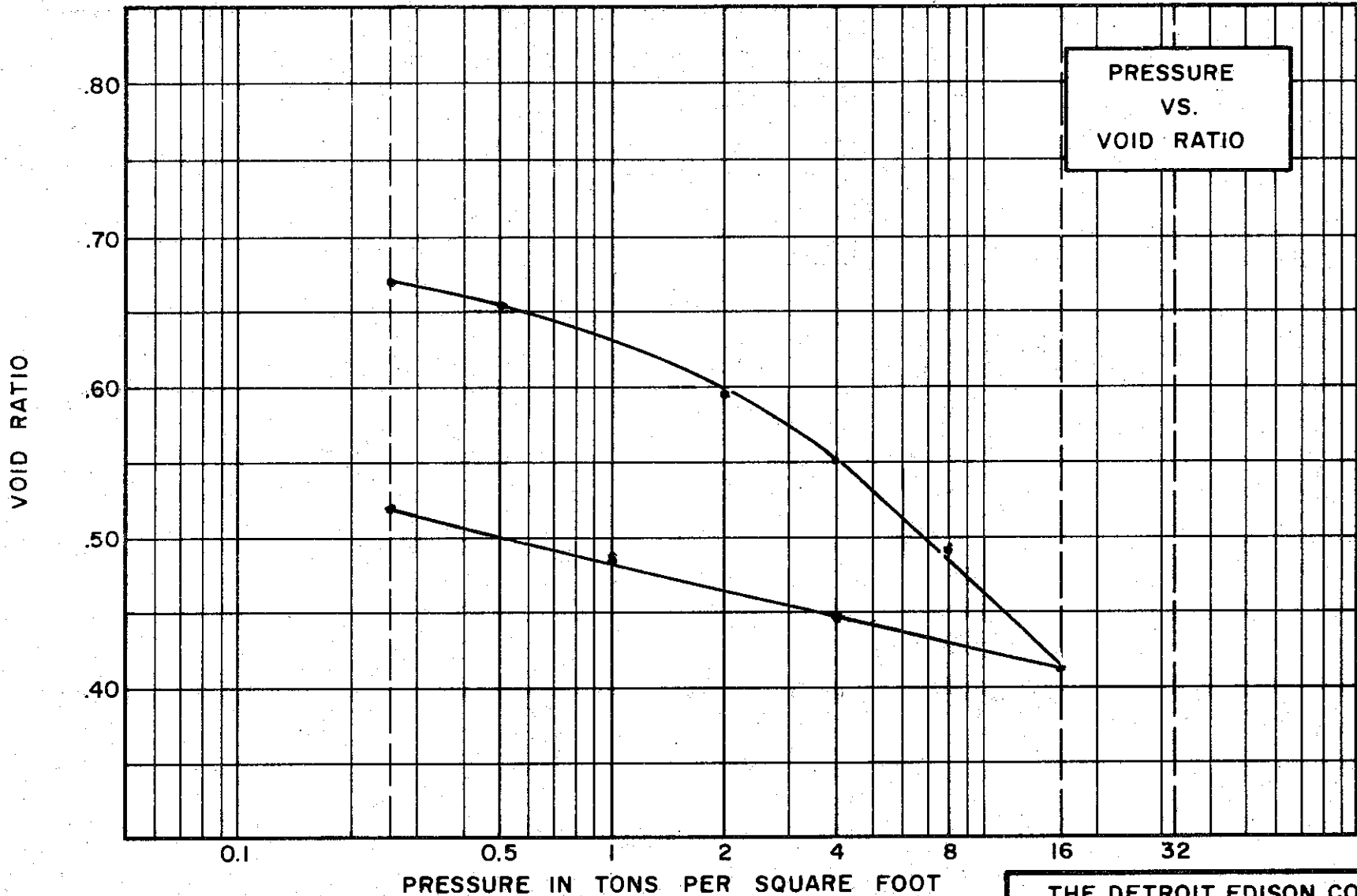

SOIL PROPERTIES

SOIL DESCRIPTION SILTY CLAY, SANDY
(CL)
SPECIFIC GRAVITY 2.71
WATER CONTENT, INITIAL 26.0% FINAL 22.0%
ATTERBERG LIMITS:
LIQUID LIMIT 36 % PLASTIC LIMIT 18 %

TEST DATA

INITIAL SAMPLE HEIGHT 0.80"
INITIAL SAMPLE DIAMETER 2.50"
INITIAL VOID RATIO 0.696

THE DETROIT EDISON COMPANY
BELLE RIVER PLANT UNITS I & II

**CONSOLIDATION TEST
VOID RATIO VS. LOG PRESSURE**

BORING NO. 54 TEST NO. C399.1
SAMPLE NO. 6 DATE JULY 1974
DEPTH 63.5' TO 63.8'

C-521

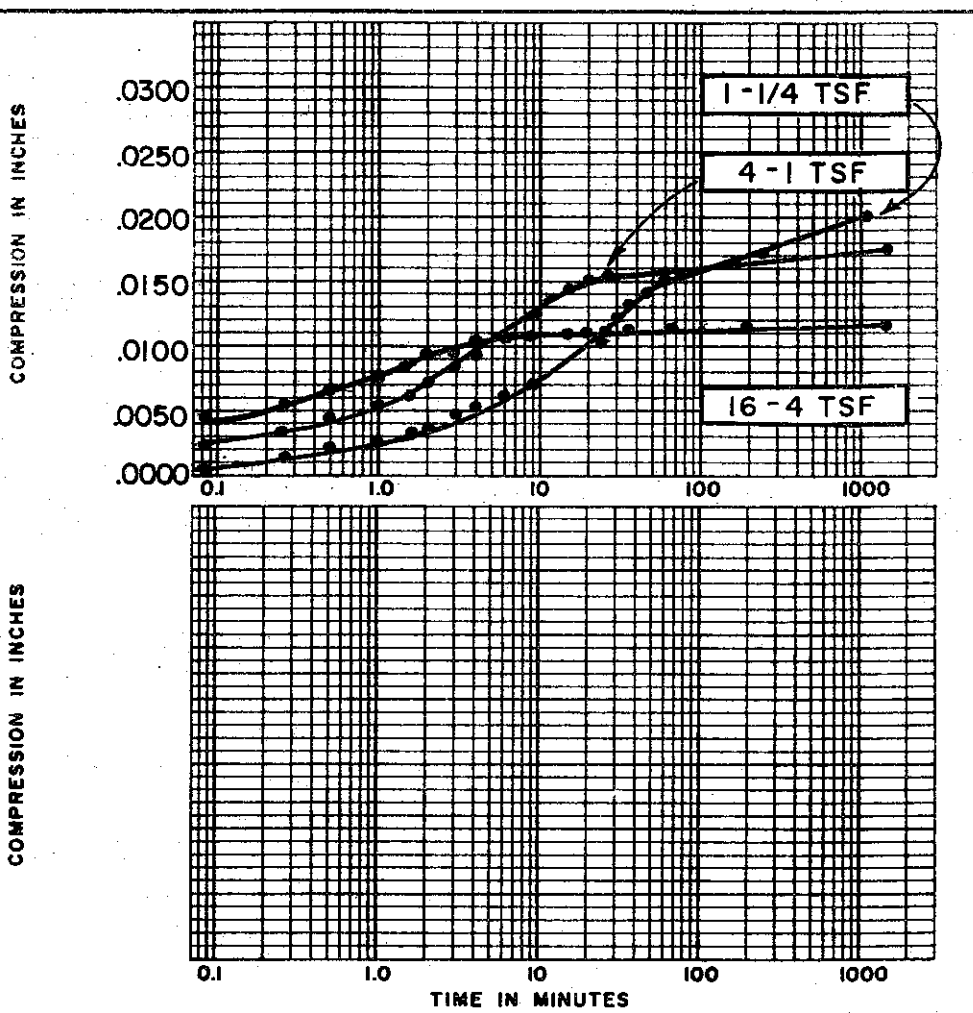
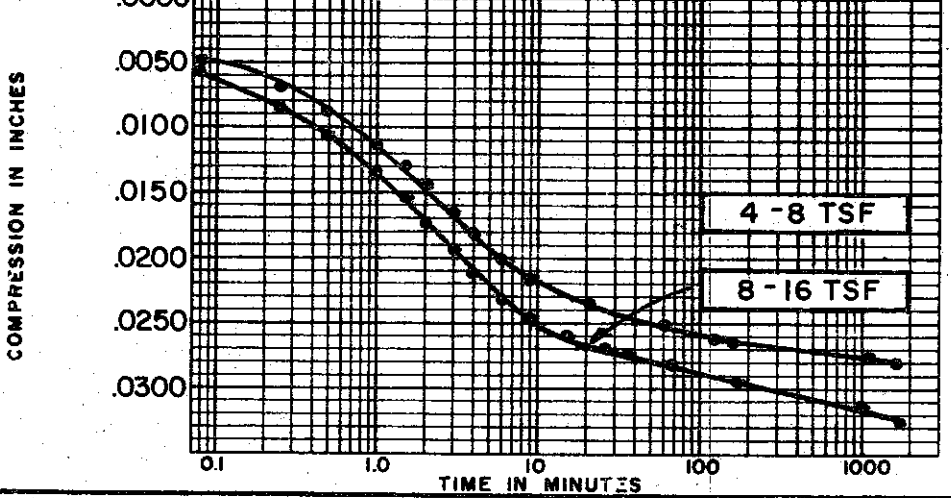
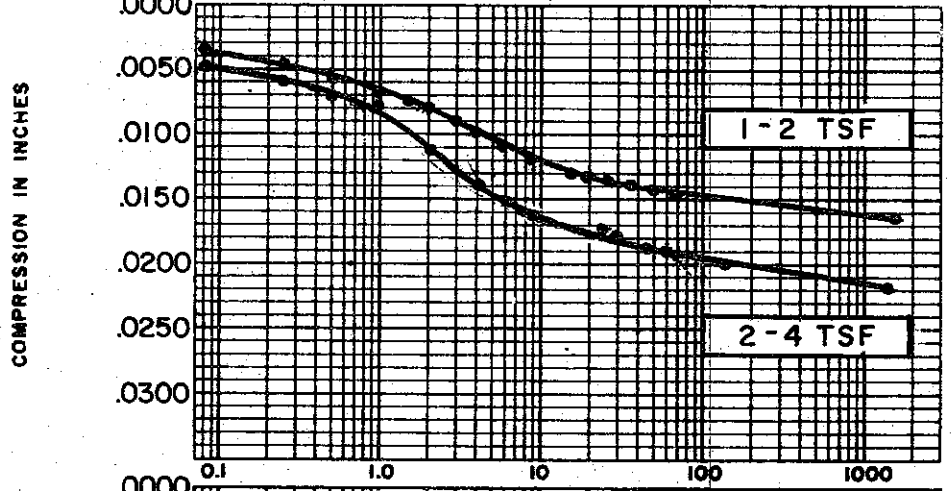
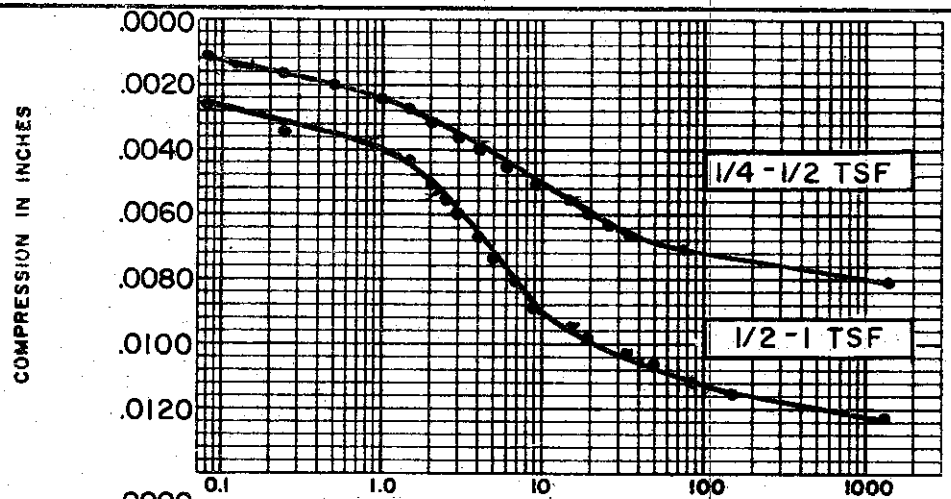

SOIL PROPERTIES	
SOIL DESCRIPTION:	SILTY CLAY, SANDY (CL)
SPECIFIC GRAVITY	2.71
INITIAL WATER CONTENT	20.0 %
FINAL WATER CONTENT	22.0 %

BORING NO.	54
SAMPLE NO.	6
DEPTH	63.5' - 63.8'

TEST DATA	
INITIAL SAMPLE HEIGHT	0.80"
INITIAL SAMPLE DIAMETER	2.50"
INITIAL VOID RATIO	0.696

**CONSOLIDATION TEST
TIME VS. COMPRESSION CURVES**

THE DETROIT EDISON COMPANY
BELLE RIVER PLANT UNITS I & II

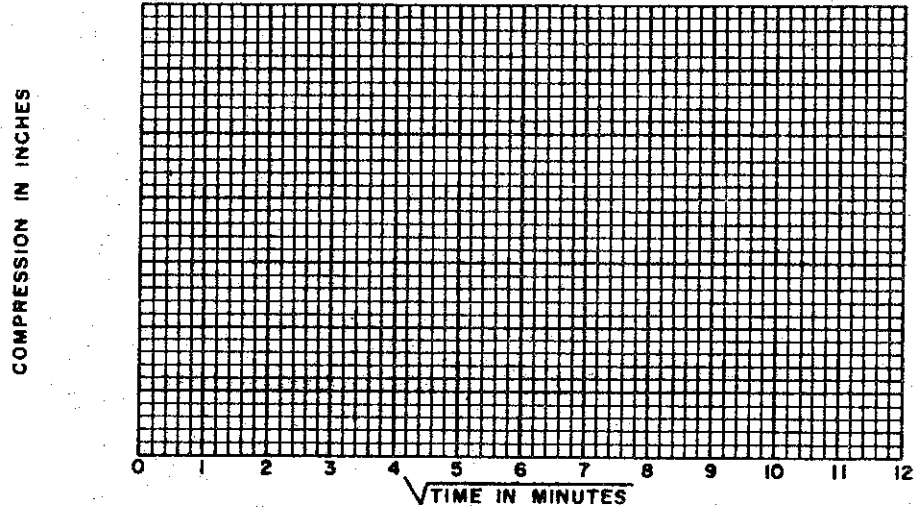
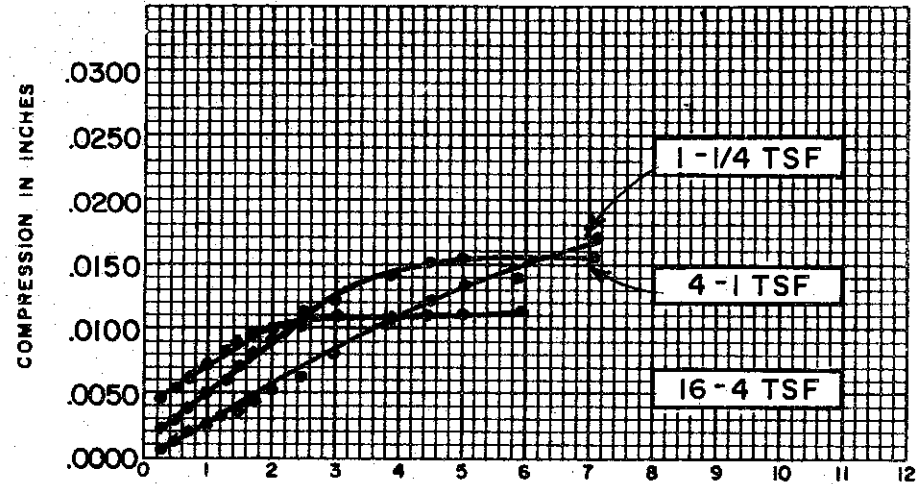
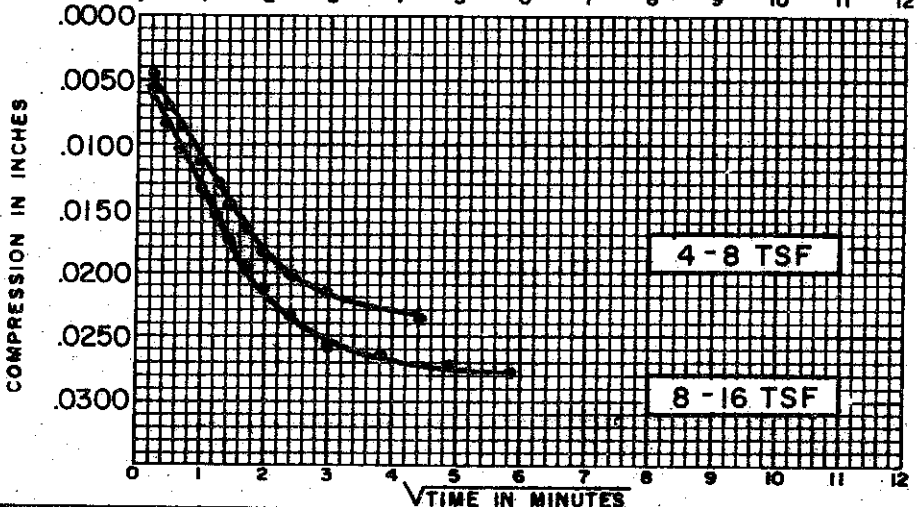
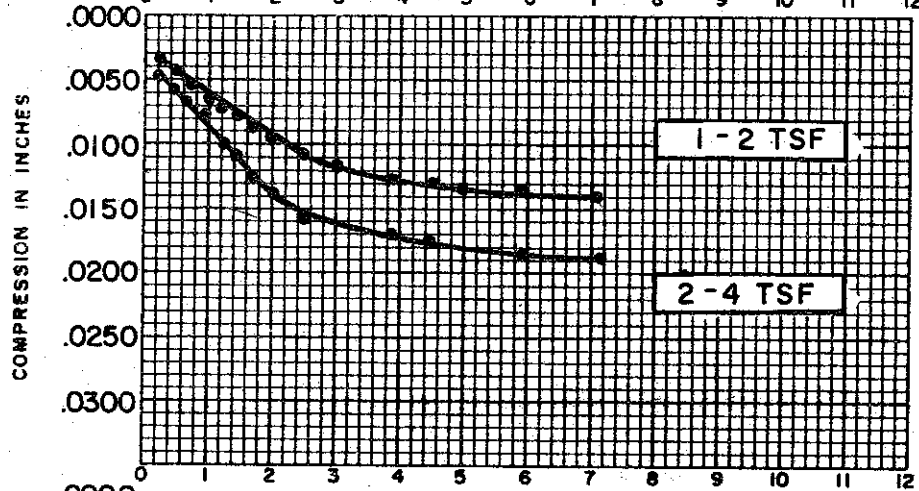
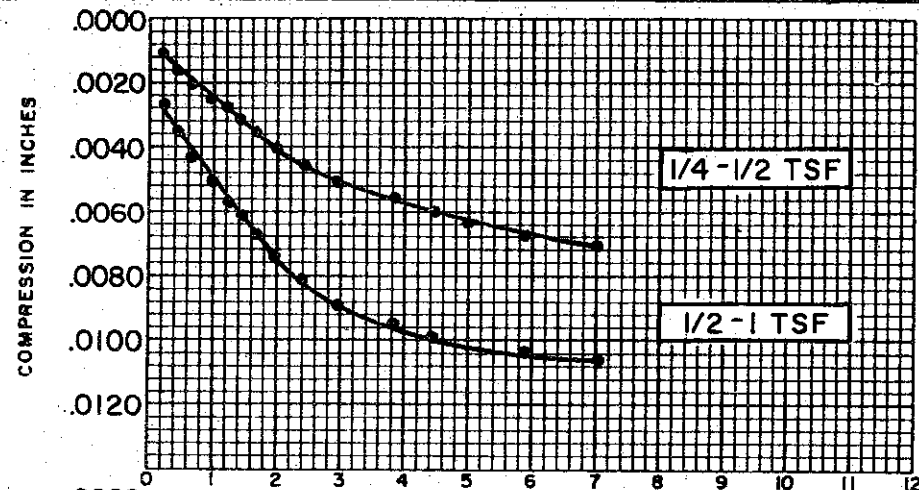

SOIL PROPERTIES

SOIL DESCRIPTION: SILTY CLAY, SANDY (CL)
 SPECIFIC GRAVITY 2.71
 INITIAL WATER CONTENT 26.0%
 FINAL WATER CONTENT 22.0%

BORING NO. 54
 SAMPLE NO. 6
 DEPTH 63.5'-63.8'

TEST DATA

INITIAL SAMPLE HEIGHT 0.80"
 INITIAL SAMPLE DIAMETER 2.50"
 INITIAL VOID RATIO 0.696

**CONSOLIDATION TEST
 TIME VS. COMPRESSION CURVES**

THE DETROIT EDISON COMPANY
 BELLE RIVER PLANT UNITS I & II

C-523

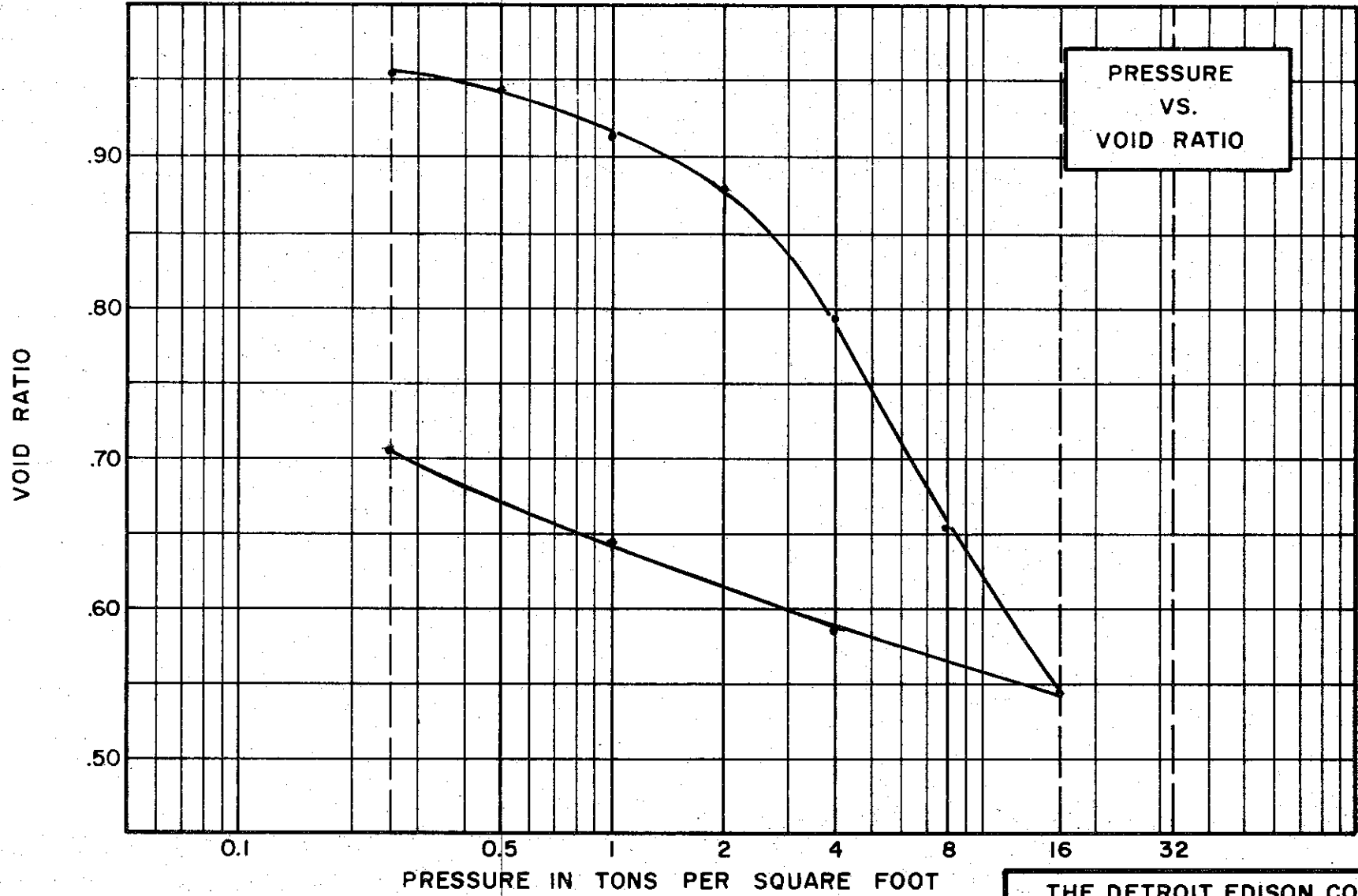

SOIL PROPERTIES

SOIL DESCRIPTION SILTY CLAY (CL)
 SPECIFIC GRAVITY 2.73
 WATER CONTENT, INITIAL 38.3% FINAL 30.6%
 ATTERBERG LIMITS:
 LIQUID LIMIT 45 % PLASTIC LIMIT 21 %

TEST DATA

INITIAL SAMPLE HEIGHT 0.80"
 INITIAL SAMPLE DIAMETER 2.50"
 INITIAL VOID RATIO 0.982

THE DETROIT EDISON COMPANY
 BELLE RIVER PLANT UNITS I & II

**CONSOLIDATION TEST
 VOID RATIO VS. LOG PRESSURE**

BORING NO. 54 TEST NO. C401.1
 SAMPLE NO. 8 DATE JULY 1974
 DEPTH 73.7' TO 74.0'

C-525

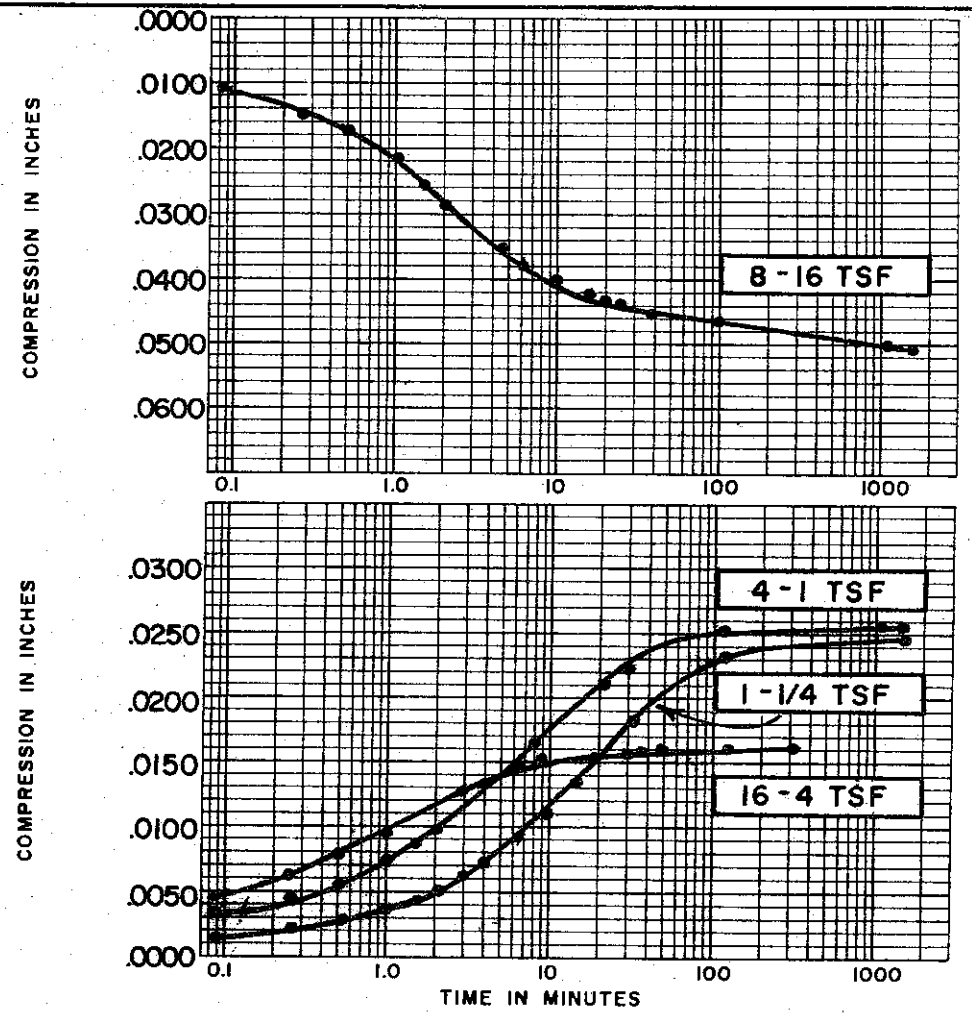
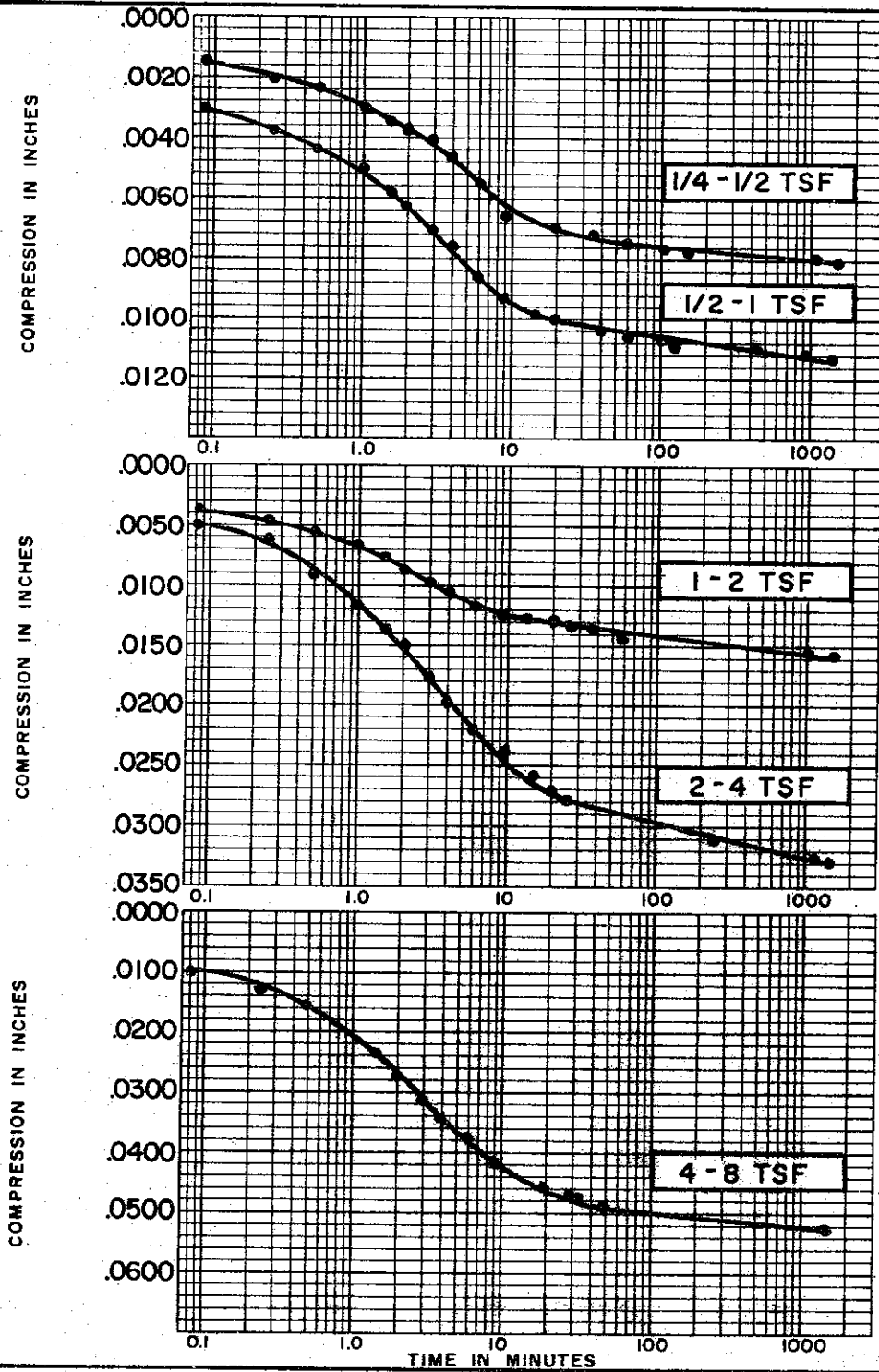

SOIL PROPERTIES		BORING NO. <u>54</u>
SOIL DESCRIPTION: <u>SILTY</u> <u>CLAY (CL)</u>		SAMPLE NO. <u>8</u>
SPECIFIC GRAVITY	<u>2.73</u>	DEPTH <u>73.7' - 74.0'</u>
INITIAL WATER CONTENT	<u>38.3 %</u>	
FINAL WATER CONTENT	<u>30.6 %</u>	
TEST DATA		
INITIAL SAMPLE HEIGHT	<u>0.80"</u>	CONSOLIDATION TEST TIME VS. COMPRESSION CURVE
INITIAL SAMPLE DIAMETER	<u>2.50"</u>	
INITIAL VOID RATIO	<u>0.962</u>	
GOLDBERG-ZOINO & ASSOCIATES, INC. SOIL AND FOUNDATION ENGINEERS		THE DETROIT EDISON COMPANY BELLE RIVER PLANT UNITS I & II

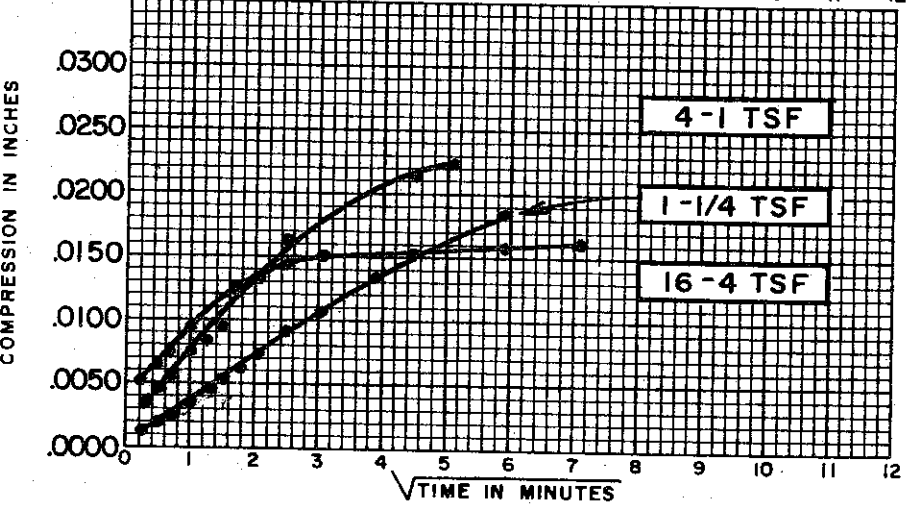
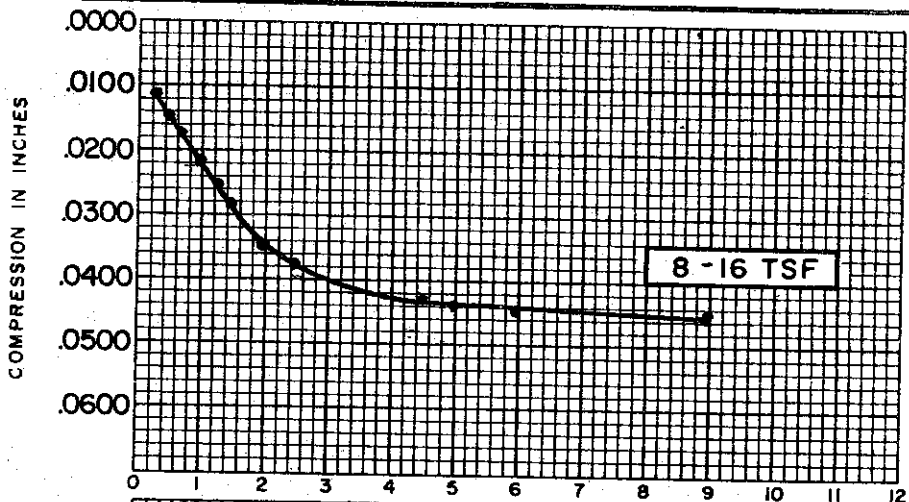
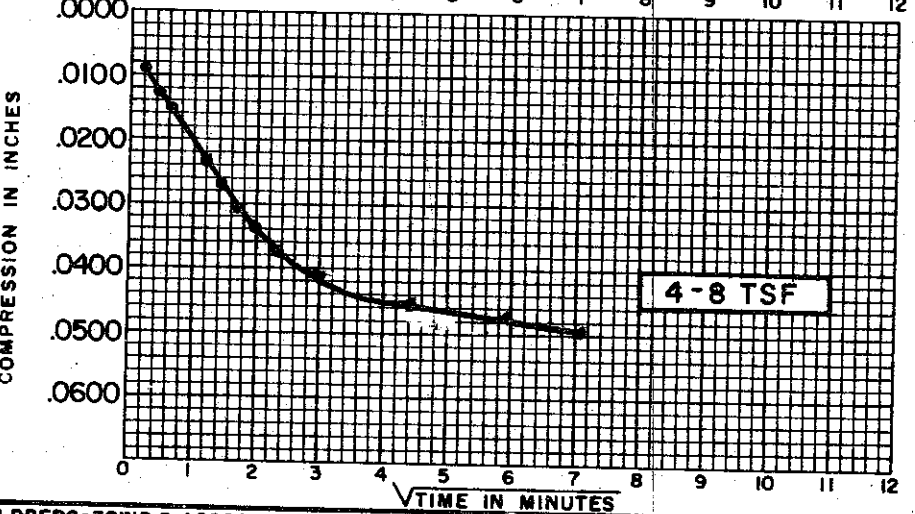
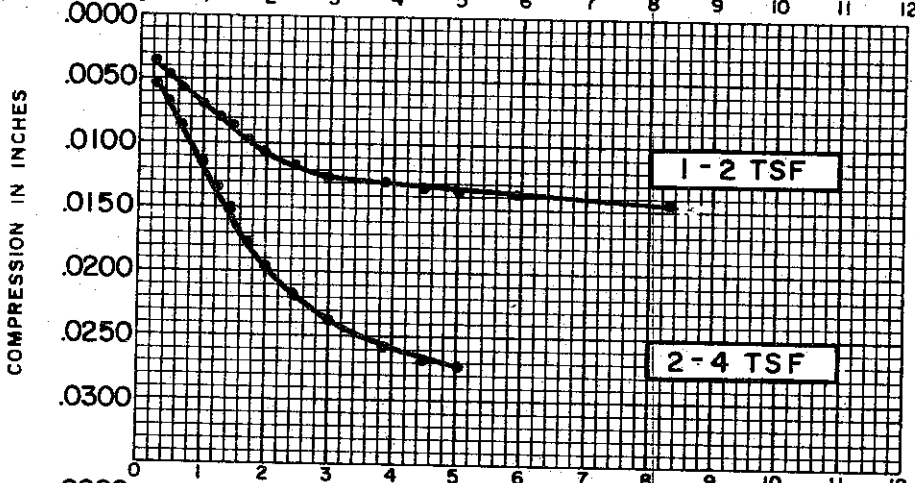
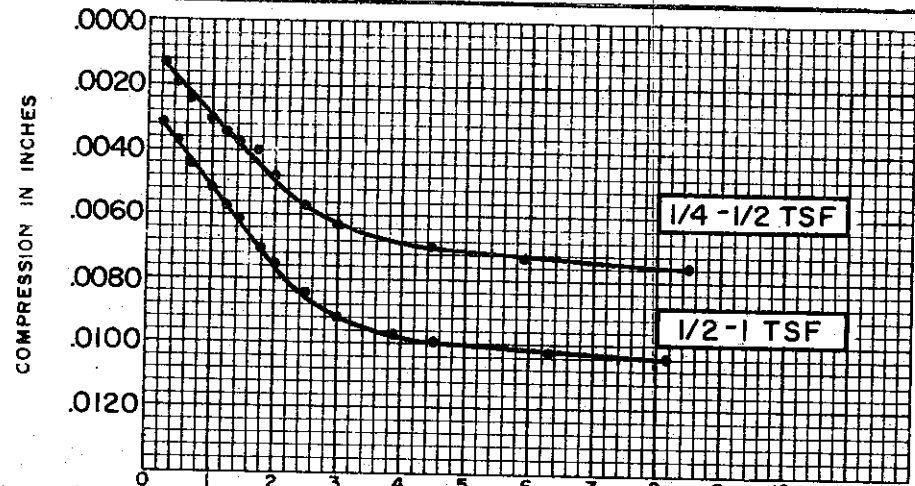

SOIL PROPERTIES
 SOIL DESCRIPTION: SILTY
CLAY (CL)
 BORING NO. 54
 SAMPLE NO. 8
 SPECIFIC GRAVITY 2.73
 INITIAL WATER CONTENT 38.3%
 FINAL WATER CONTENT 30.6%
 DEPTH 73.7'-74.0'

TEST DATA
 INITIAL SAMPLE HEIGHT 0.80"
 INITIAL SAMPLE DIAMETER 2.50"
 INITIAL VOID RATIO 0.982

CONSOLIDATION TEST
TIME VS. COMPRESSION CURVES
 THE DETROIT EDISON COMPANY
 BELLE RIVER PLANT UNITS I & II

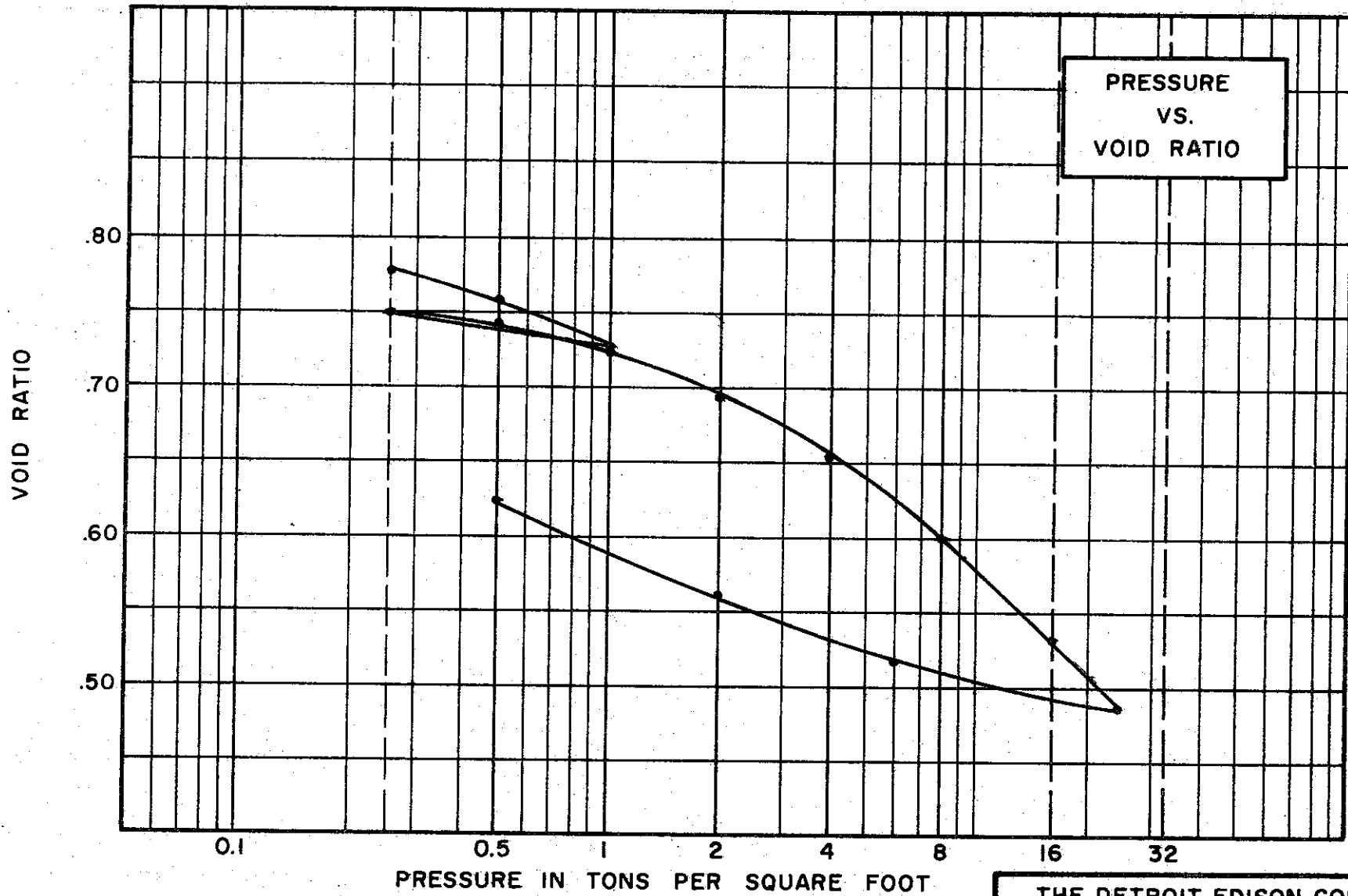

PRESSURE
VS.
VOID RATIO

SOIL PROPERTIES

SOIL DESCRIPTION SILTY
CLAY (CL-CH)
SPECIFIC GRAVITY 2.71
WATER CONTENT, INITIAL 30.0% FINAL 28.8%
ATTERBERG LIMITS:
LIQUID LIMIT 53 % PLASTIC LIMIT 26 %

TEST DATA

INITIAL SAMPLE HEIGHT 0.80"
INITIAL SAMPLE DIAMETER 2.50"
INITIAL VOID RATIO 0.787

THE DETROIT EDISON COMPANY
BELLE RIVER PLANT UNITS I & II

**CONSOLIDATION TEST
VOID RATIO VS. LOG PRESSURE**

BORING NO. 60 TEST NO. C42.1
SAMPLE NO. 2 DATE FEB. 1974
DEPTH 9.8' TO 10.0'

C-527

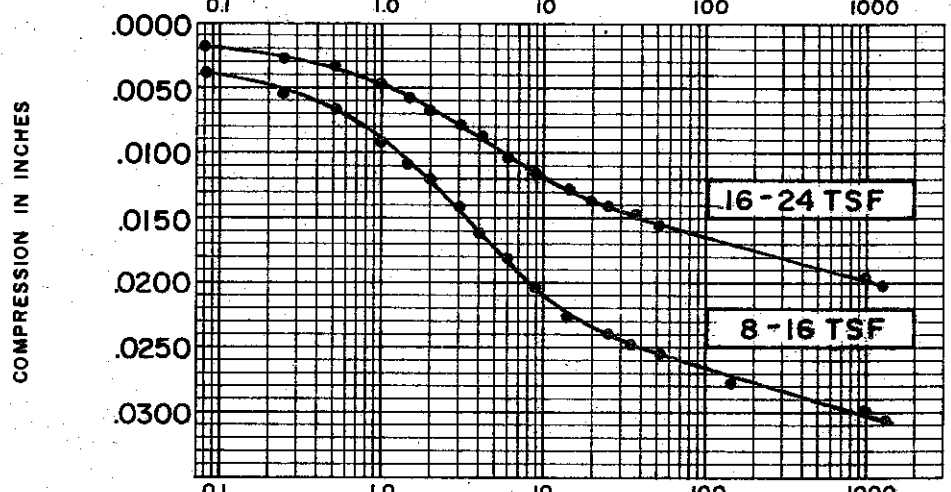
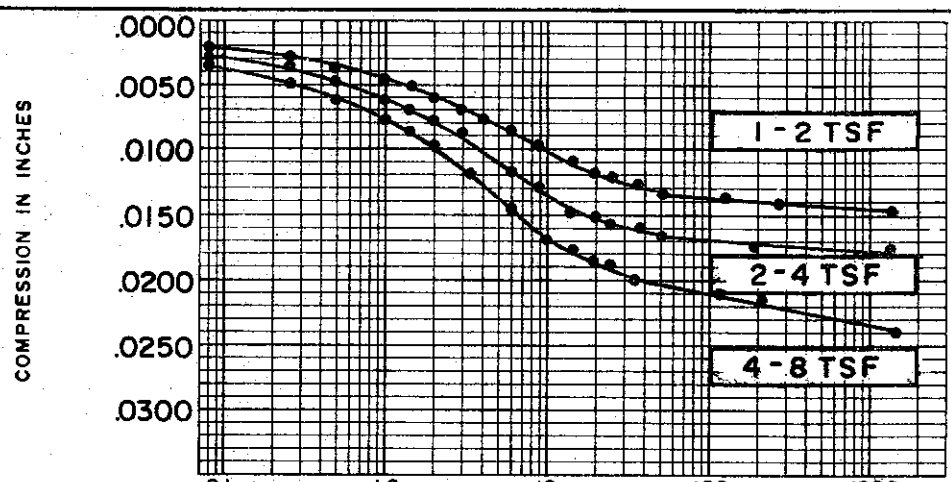
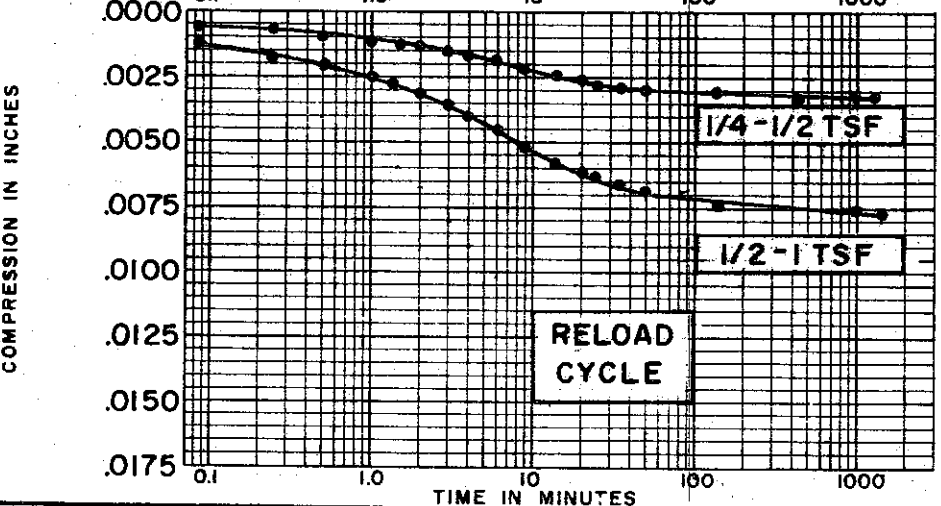
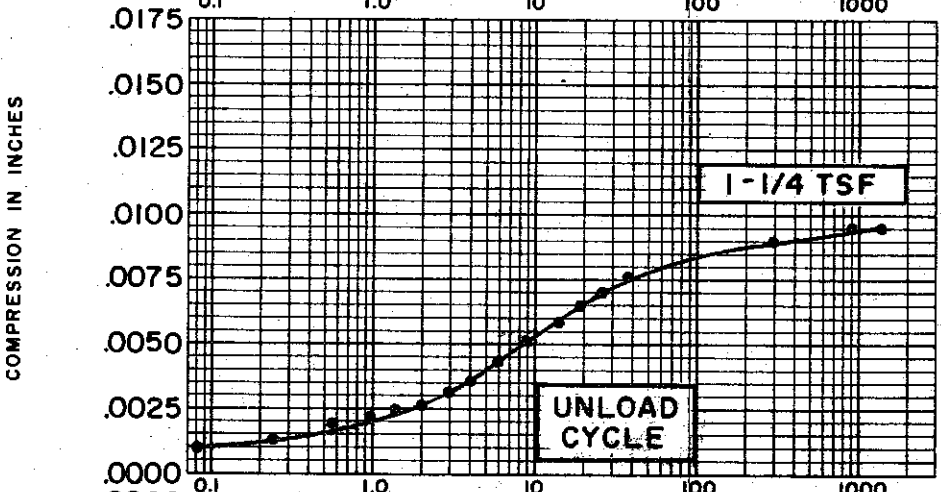
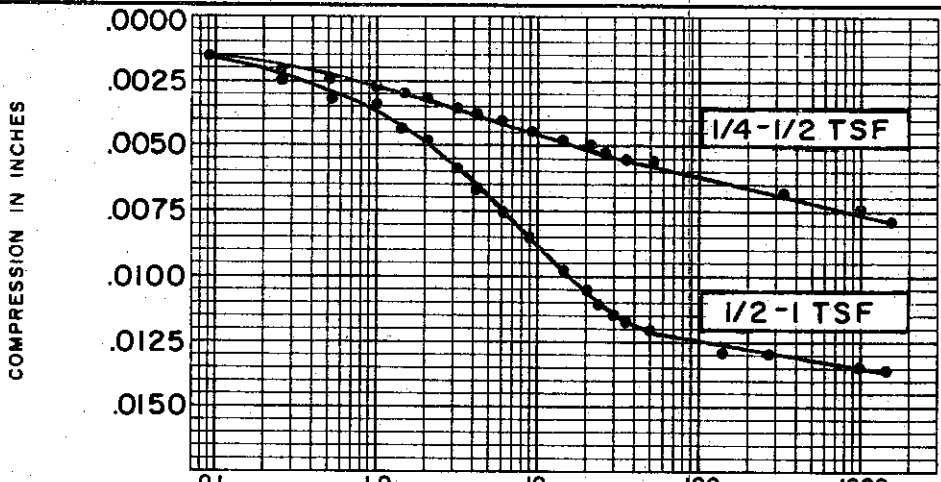

TIME IN MINUTES

SOIL PROPERTIES	
SOIL DESCRIPTION:	SILTY CLAY (CL-CH)
SPECIFIC GRAVITY	2.71
INITIAL WATER CONTENT	30.0%
FINAL WATER CONTENT	28.8%
BORING NO.	60
SAMPLE NO.	2
DEPTH	9.8' TO 10.0'

TEST DATA	
INITIAL SAMPLE HEIGHT	0.80"
INITIAL SAMPLE DIAMETER	2.50"
INITIAL VOID RATIO	0.787

CONSOLIDATION TEST
 TIME VS. COMPRESSION CURVES
 THE DETROIT EDISON COMPANY
 BELLE RIVER PLANT UNITS I & II

C-529

COMPRESSION IN INCHES

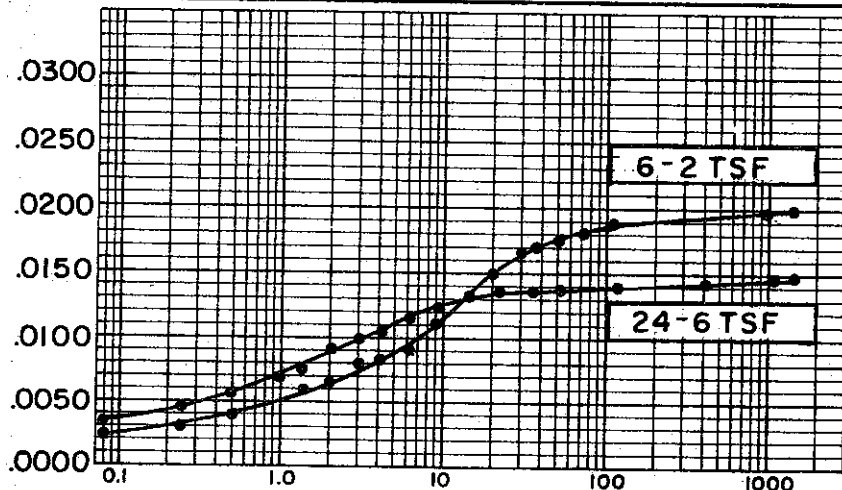

COMPRESSION IN INCHES

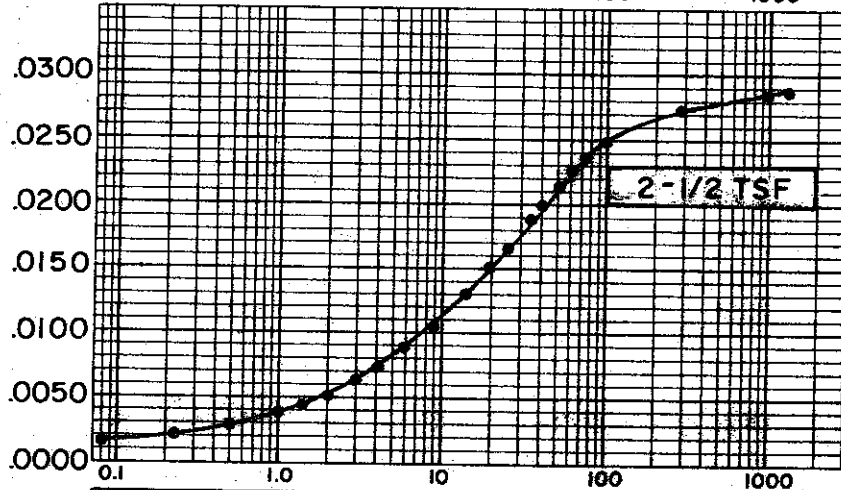

COMPRESSION IN INCHES

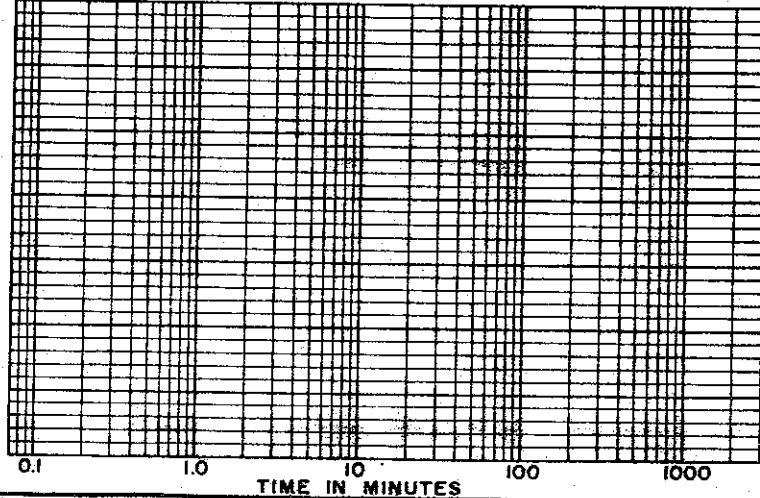

COMPRESSION IN INCHES

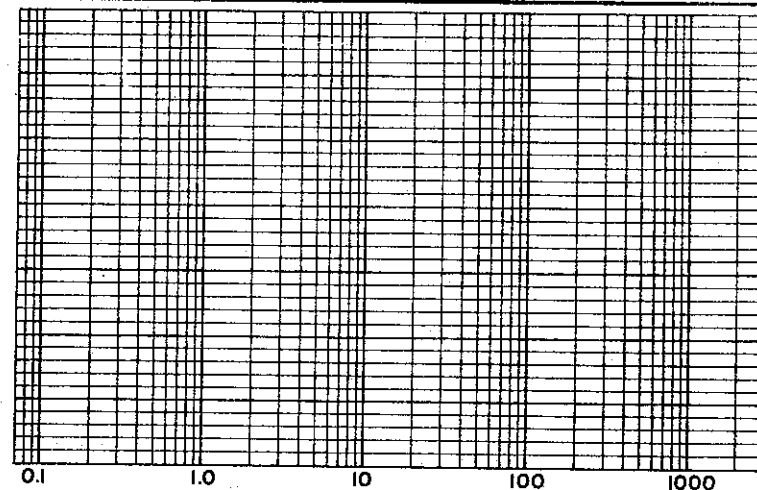

COMPRESSION IN INCHES

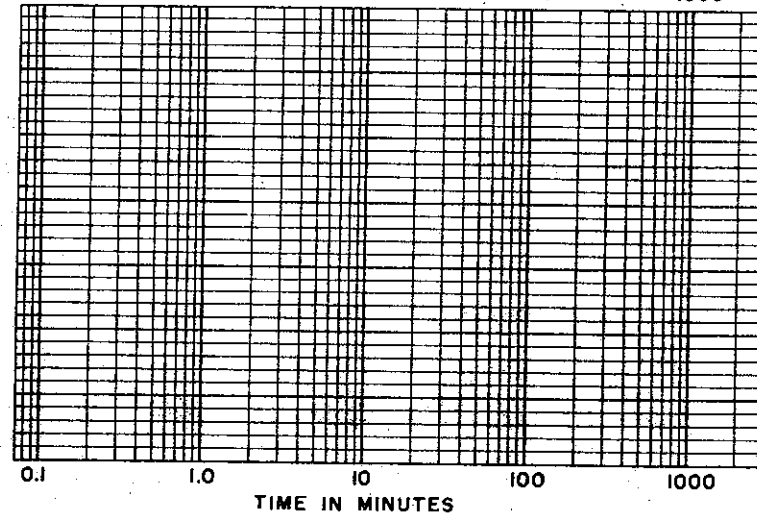

SOIL PROPERTIES

SOIL DESCRIPTION: SILTY CLAY (CL-CM)
 SPECIFIC GRAVITY 2.71
 INITIAL WATER CONTENT 30.0%
 FINAL WATER CONTENT 28.8%

BORING NO. 60
 SAMPLE NO. 2
 DEPTH 9.8' TO 10.0'

TEST DATA

INITIAL SAMPLE HEIGHT 0.60"
 INITIAL SAMPLE DIAMETER 2.50"
 INITIAL VOID RATIO 0.787

**CONSOLIDATION TEST
TIME VS. COMPRESSION CURVE**

THE DETROIT EDISON COMPANY
 BELLE RIVER PLANT UNITS I & II

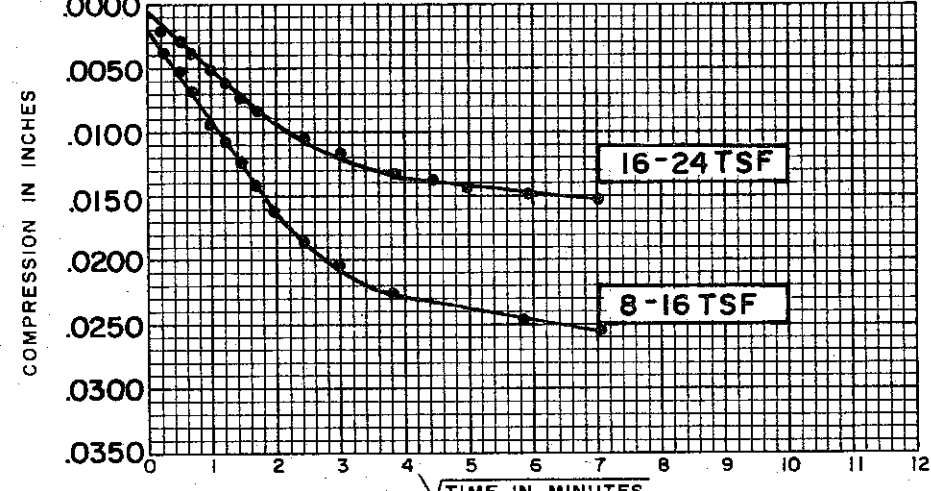
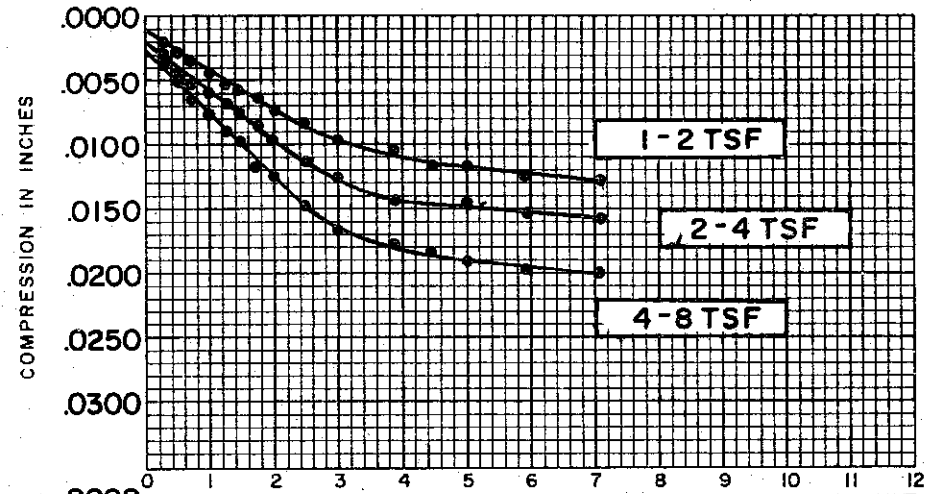
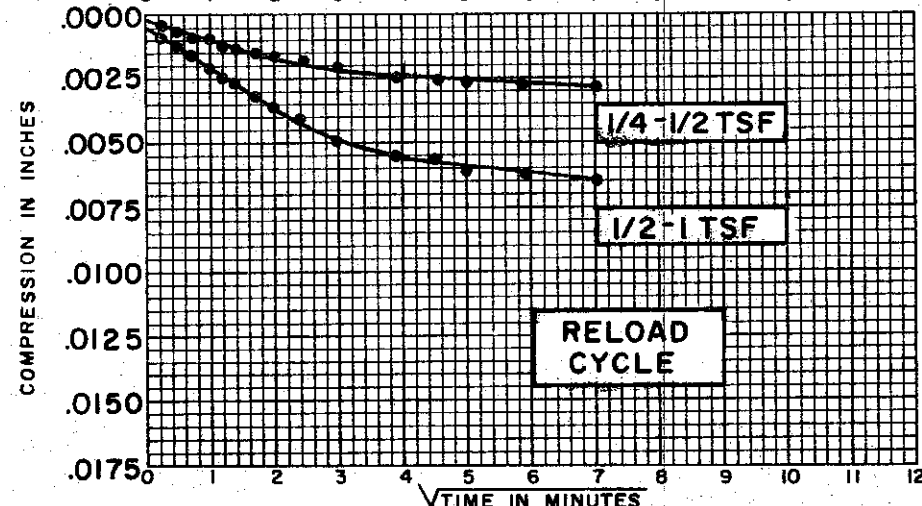
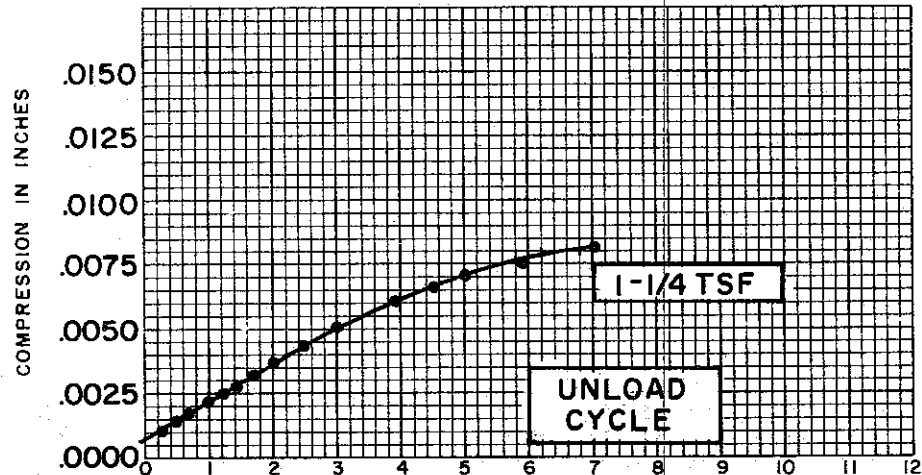
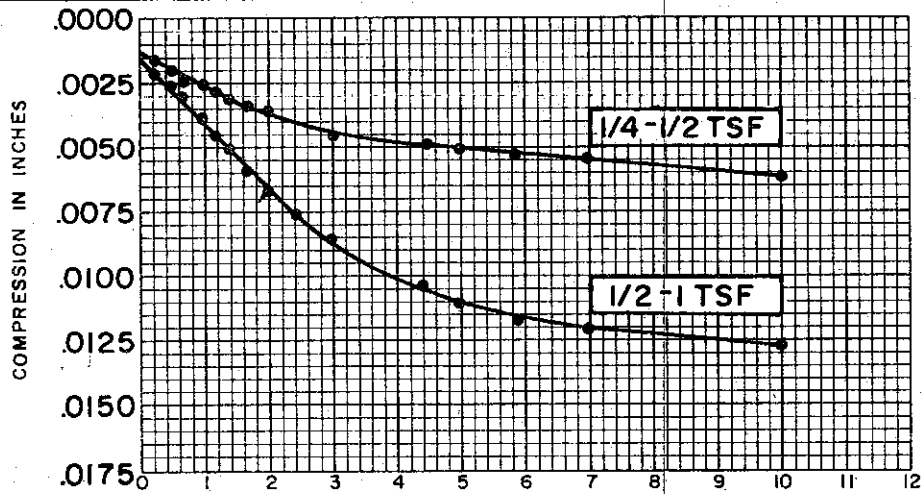

SOIL PROPERTIES	
SOIL DESCRIPTION:	SILTY CLAY (CL-CH)
SPECIFIC GRAVITY	2.71
INITIAL WATER CONTENT	30.0%
FINAL WATER CONTENT	28.8%
BORING NO.	60
SAMPLE NO.	2
DEPTH	9.8' TO 10.0'

TEST DATA	
INITIAL SAMPLE HEIGHT	0.80"
INITIAL SAMPLE DIAMETER	2.50"
INITIAL VOID RATIO	0.787

CONSOLIDATION TEST
TIME VS. COMPRESSION CURVES
 THE DETROIT EDISON COMPANY
 BELLE RIVER PLANT UNITS I & II

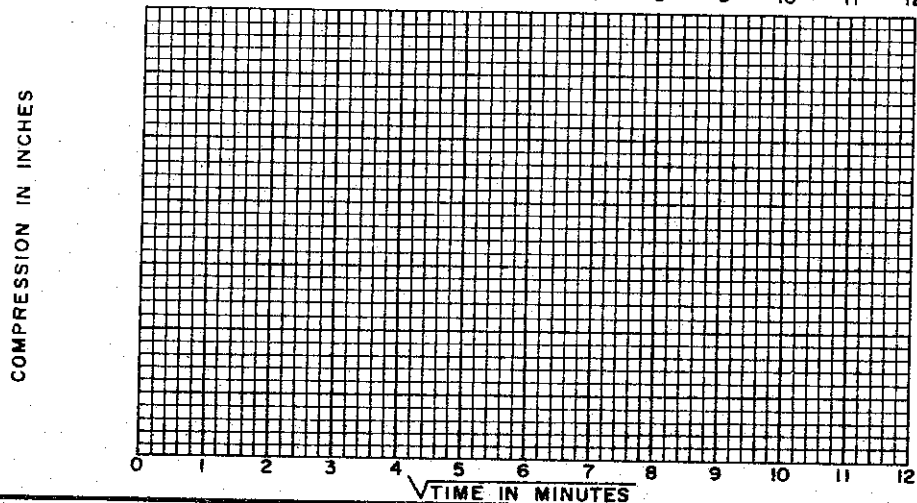
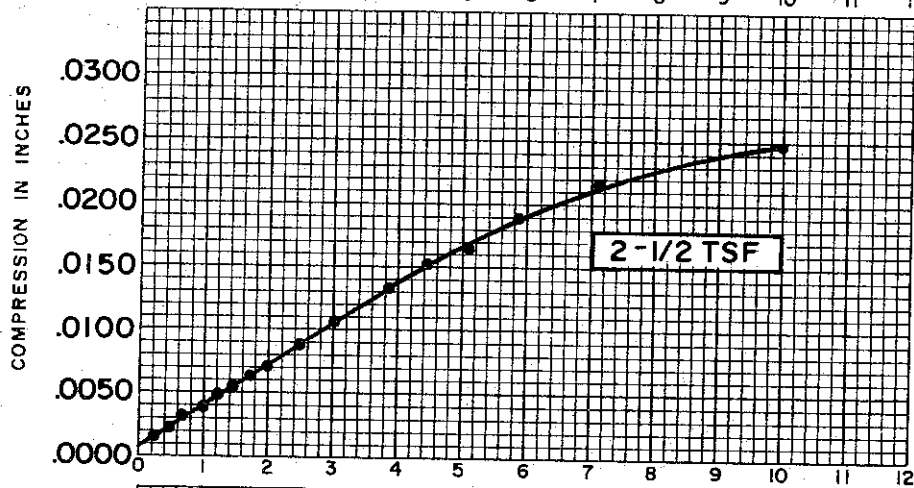
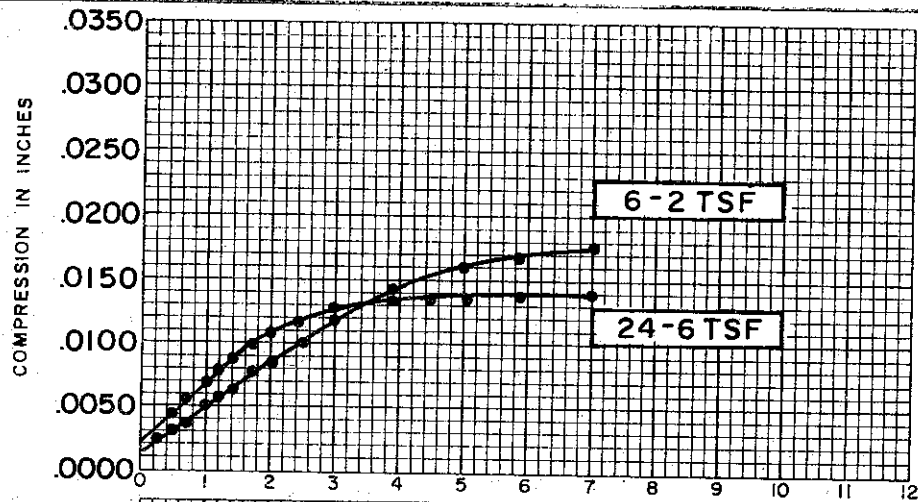

COMPRESSION IN INCHES

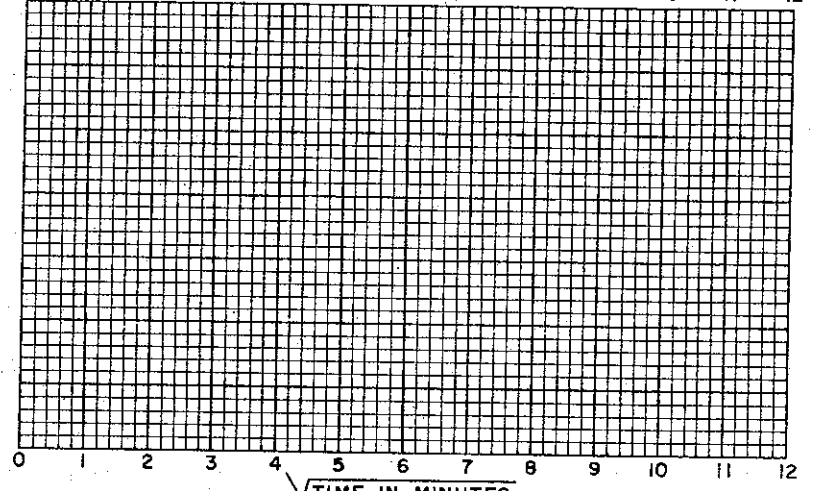
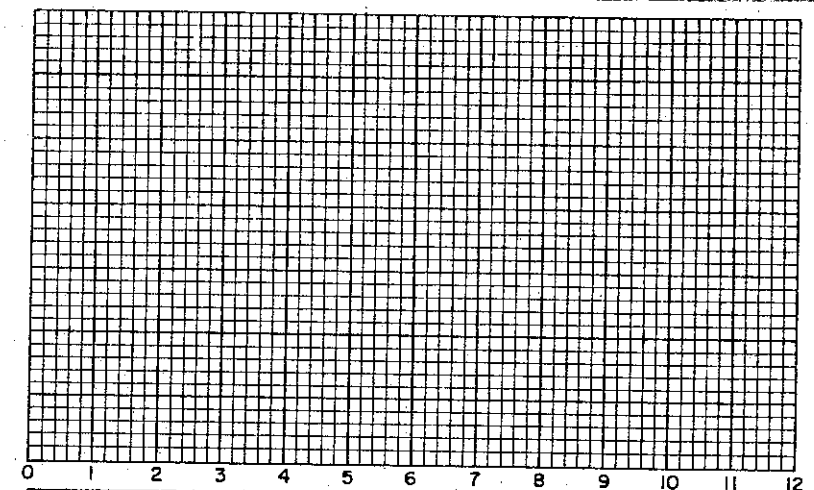

SOIL PROPERTIES		BORING NO. <u>60</u>
SOIL DESCRIPTION:	<u>SILTY CLAY (CL-CH)</u>	SAMPLE NO. <u>2</u>
SPECIFIC GRAVITY	<u>2.71</u>	DEPTH <u>9.8' TO 10.0'</u>
INITIAL WATER CONTENT	<u>30.0%</u>	
FINAL WATER CONTENT	<u>28.8%</u>	

TEST DATA	
INITIAL SAMPLE HEIGHT	<u>0.80"</u>
INITIAL SAMPLE DIAMETER	<u>2.50"</u>
INITIAL VOID RATIO	<u>0.787</u>

**CONSOLIDATION TEST
TIME VS. COMPRESSION CURVES**

THE DETROIT EDISON COMPANY
BELLE RIVER PLANT UNITS I & II

C-531

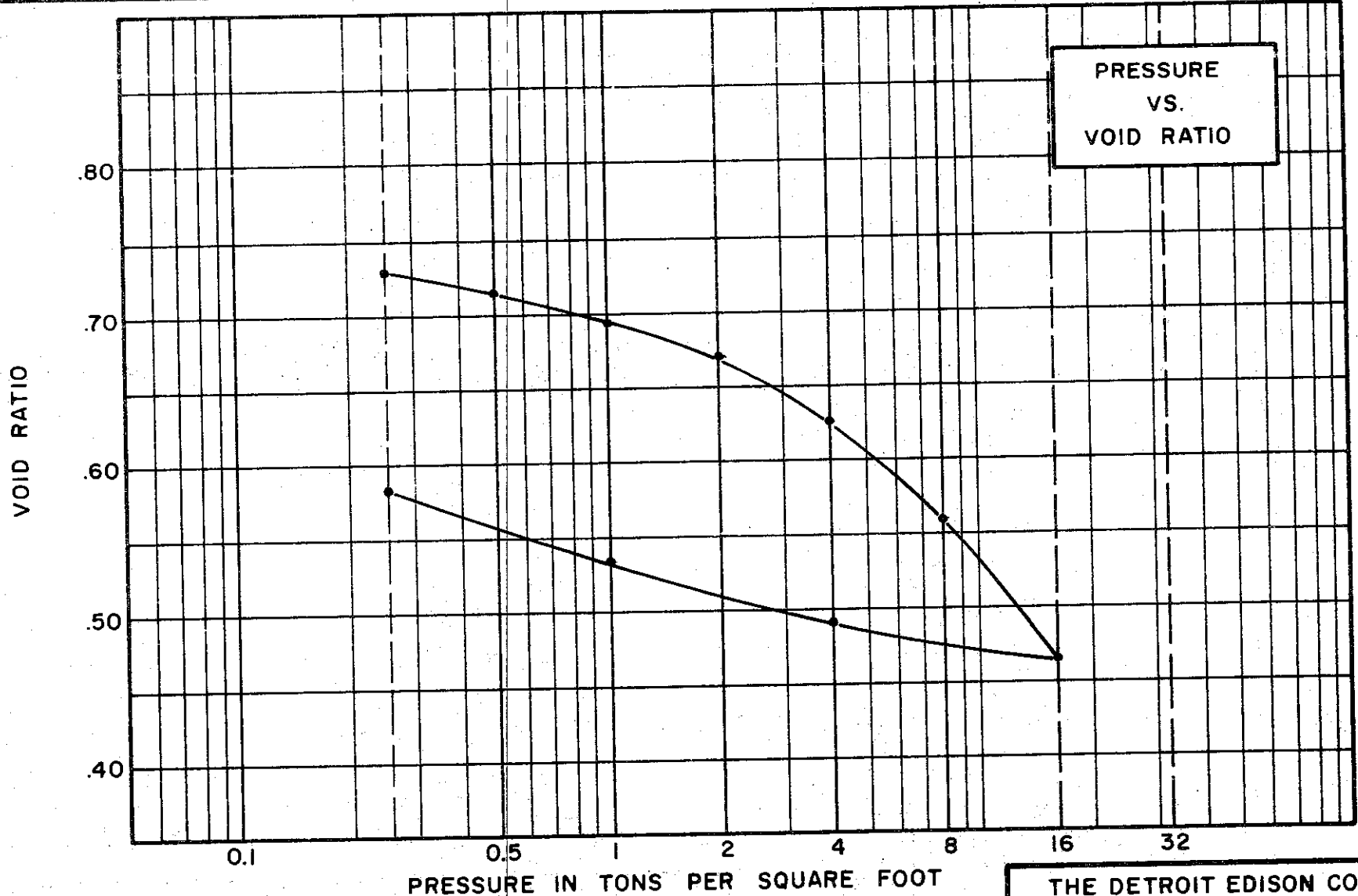

PRESSURE
VS.
VOID RATIO

SOIL PROPERTIES

SOIL DESCRIPTION SILTY CLAY
(CL)
SPECIFIC GRAVITY 2.73
WATER CONTENT, INITIAL 27.9% FINAL 25.5%
ATTERBERG LIMITS:
LIQUID LIMIT 40% PLASTIC LIMIT 19%

TEST DATA

INITIAL SAMPLE HEIGHT 0.80"
INITIAL SAMPLE DIAMETER 2.50"
INITIAL VOID RATIO 0.744

THE DETROIT EDISON COMPANY
BELLE RIVER PLANT UNITS I & II

**CONSOLIDATION TEST
VOID RATIO VS. LOG PRESSURE**

BORING NO. 60 TEST NO. C56.1
SAMPLE NO. 16 DATE JAN. 1974
DEPTH 85.5'

C-533

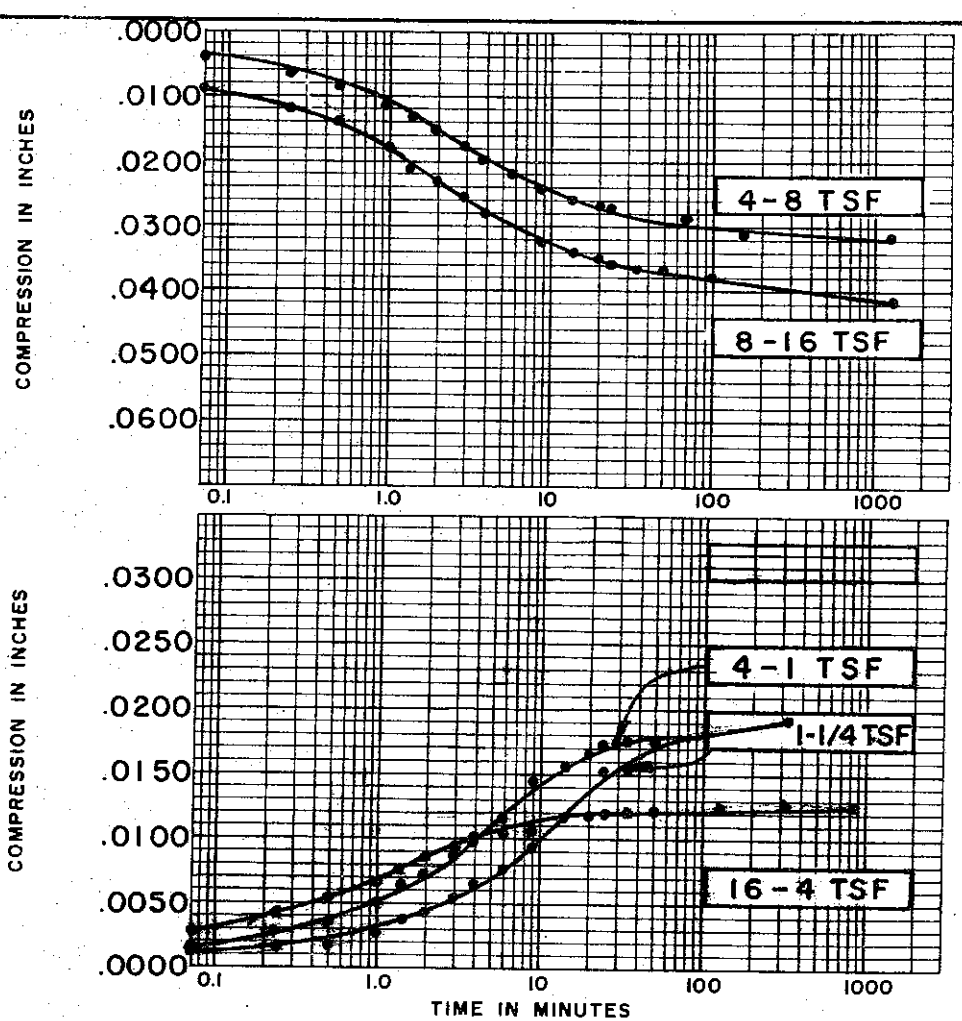
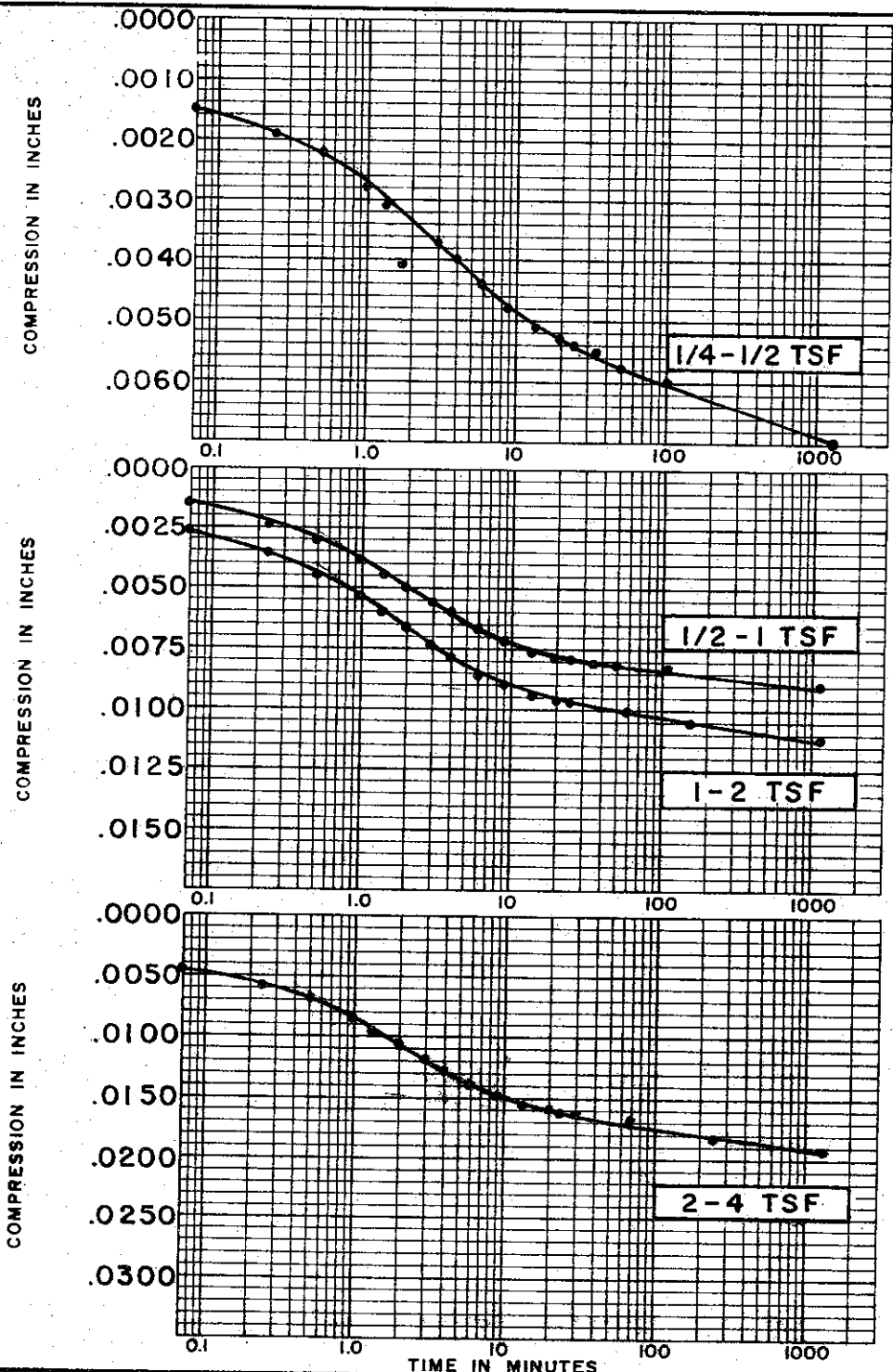

SOIL PROPERTIES	
SOIL DESCRIPTION:	SILTY CLAY (CL)
SPECIFIC GRAVITY	2.73
INITIAL WATER CONTENT	27.9 %
FINAL WATER CONTENT	25.5 %
BORING NO.	60
SAMPLE NO.	16
DEPTH	85.5'
TEST DATA	
INITIAL SAMPLE HEIGHT	0.80"
INITIAL SAMPLE DIAMETER	2.50"
INITIAL VOID RATIO	0.744

CONSOLIDATION TEST
 TIME VS. COMPRESSION CURVE
 THE DETROIT EDISON COMPANY
 BELLE RIVER PLANT UNITS I & II

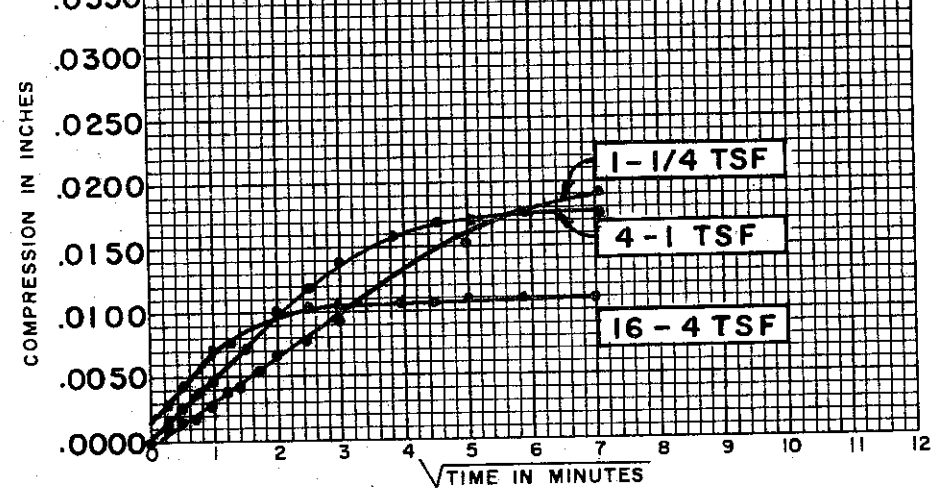
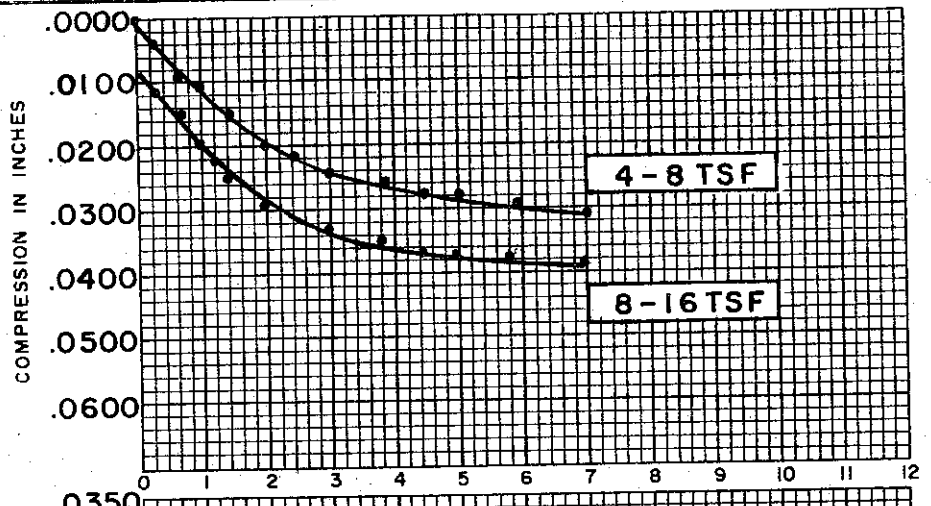
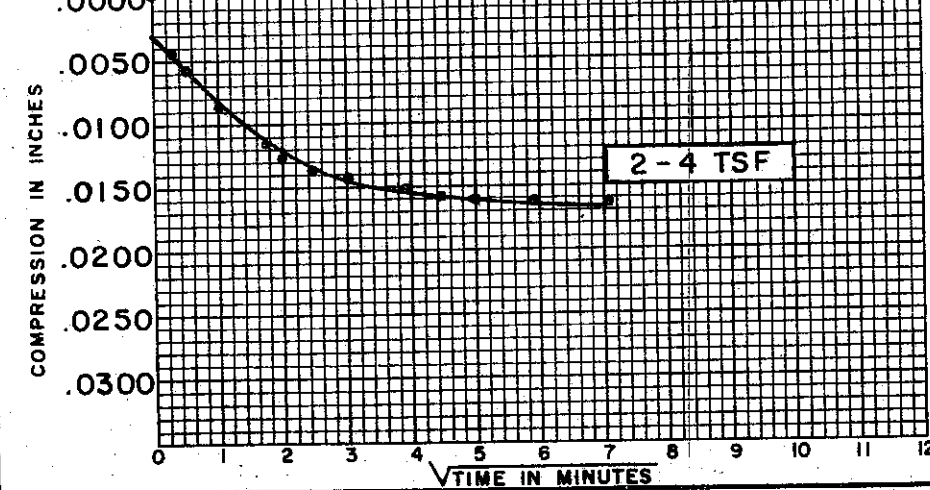
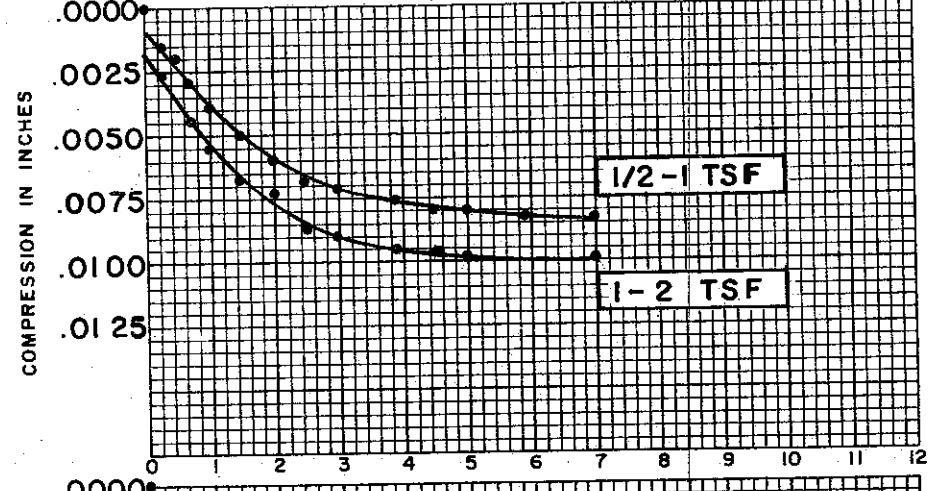
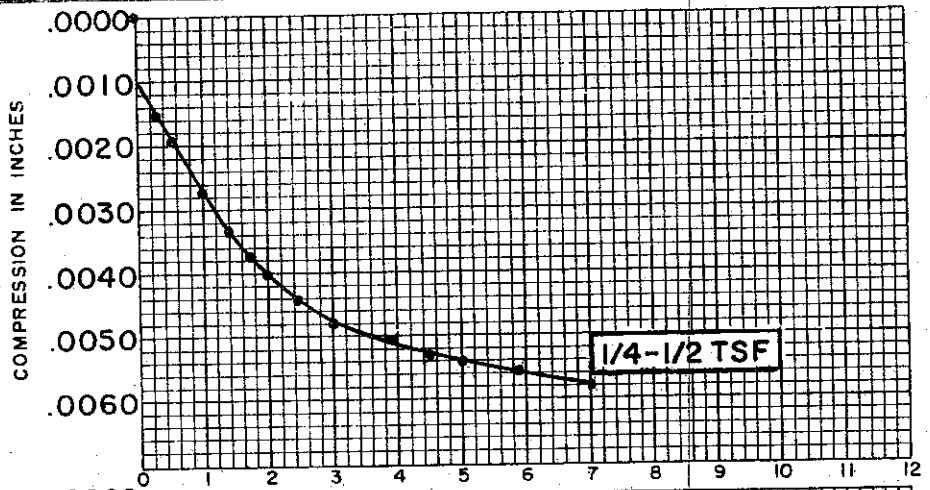

SOIL PROPERTIES	
SOIL DESCRIPTION:	SILTY CLAY (CL)
SPECIFIC GRAVITY	2.73
INITIAL WATER CONTENT	27.9 %
FINAL WATER CONTENT	25.5 %
BORING NO.	60
SAMPLE NO.	16
DEPTH	85.5'

TEST DATA	
INITIAL SAMPLE HEIGHT	0.80"
INITIAL SAMPLE DIAMETER	2.50"
INITIAL VOID RATIO	0.744

**CONSOLIDATION TEST
TIME VS. COMPRESSION CURVES**

THE DETROIT EDISON COMPANY
BELLE RIVER PLANT UNITS I & II

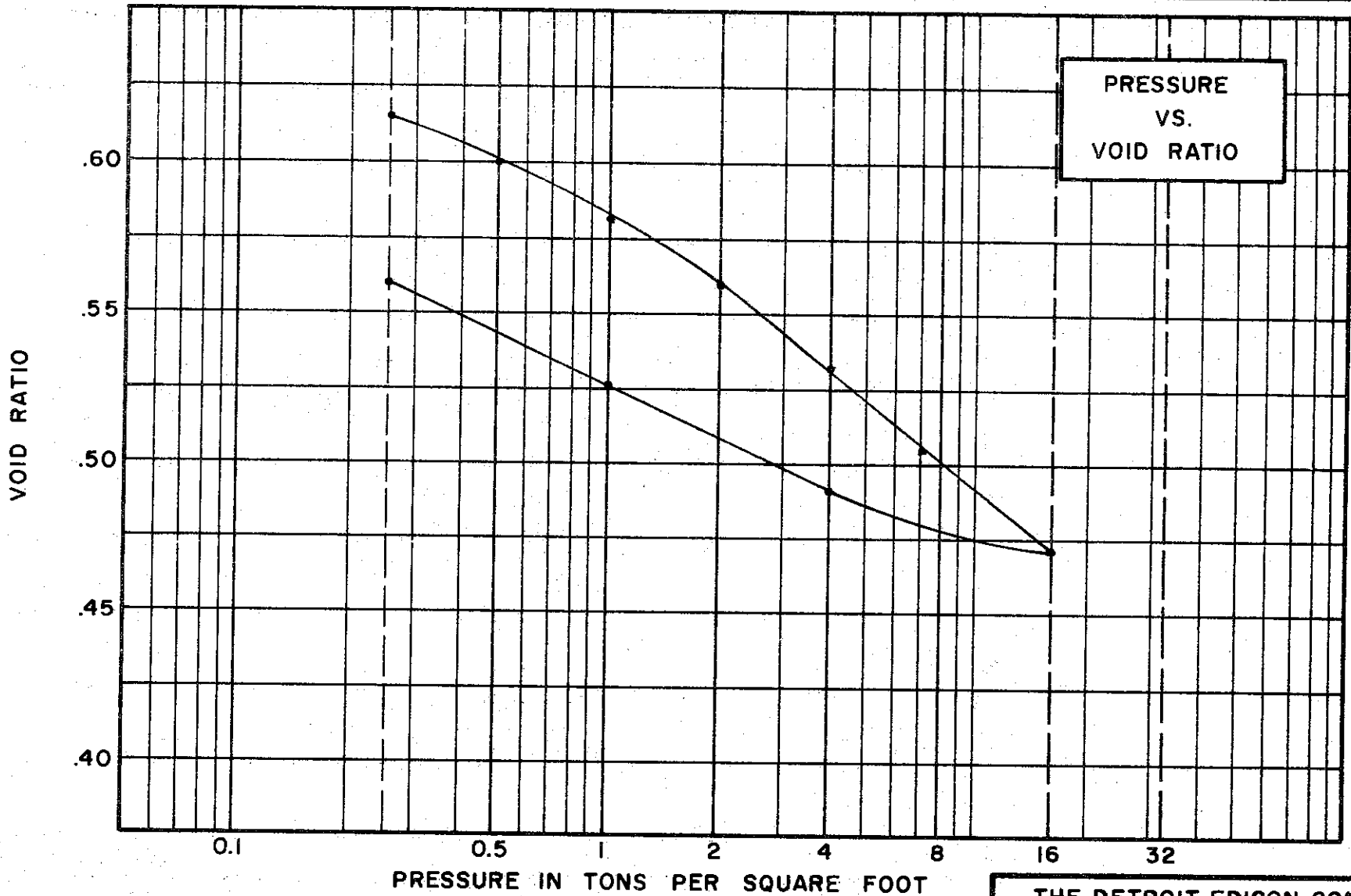

SOIL PROPERTIES

SOIL DESCRIPTION SILTY CLAY (CH)
 SPECIFIC GRAVITY 2.72
 WATER CONTENT, INITIAL 23.6% FINAL 23.4%
 ATTERBERG LIMITS:
 LIQUID LIMIT 53% PLASTIC LIMIT 24%

TEST DATA

INITIAL SAMPLE HEIGHT 0.75"
 INITIAL SAMPLE DIAMETER 2.50"
 INITIAL VOID RATIO 0.642

THE DETROIT EDISON COMPANY
 BELLE RIVER PLANT UNITS I & II

CONSOLIDATION TEST
 VOID RATIO VS. LOG PRESSURE

BORING NO. 105 TEST NO. C373.1
 SAMPLE NO. 1 DATE APRIL 74
 DEPTH 5.1' TO 5.4'

C-535

C-5336

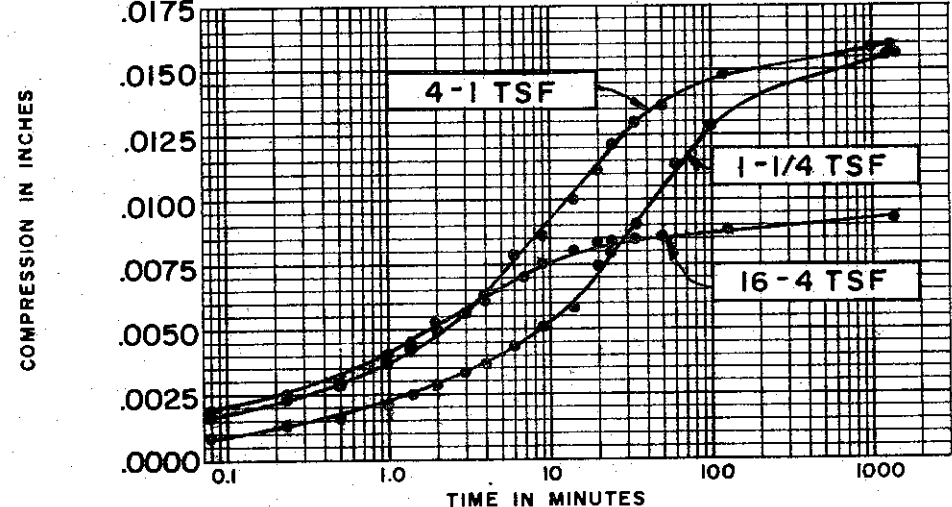
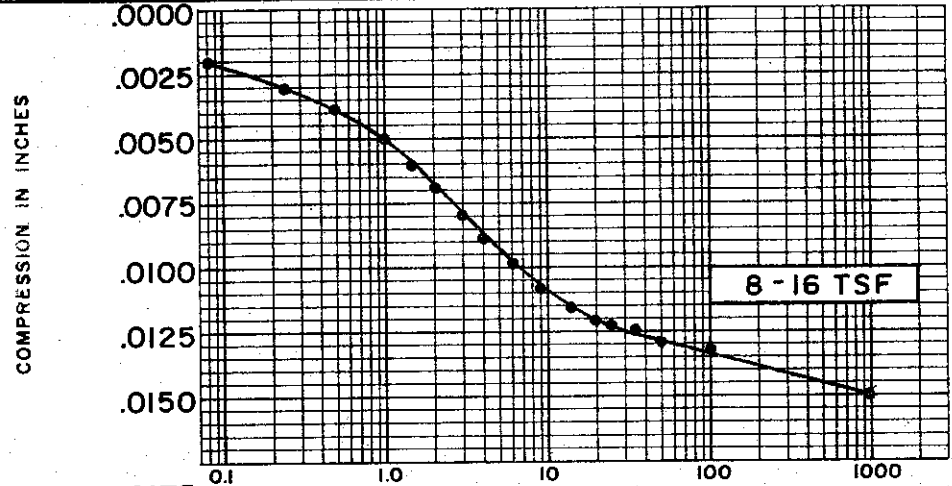
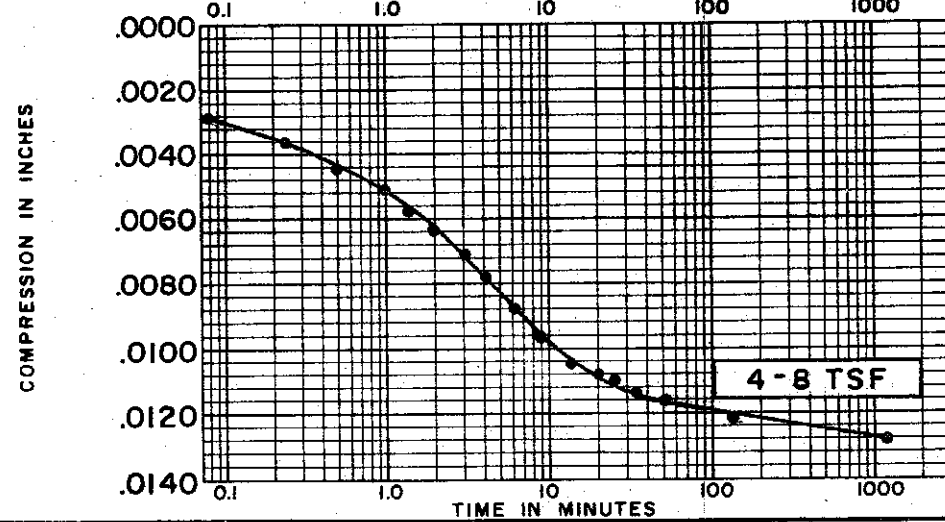
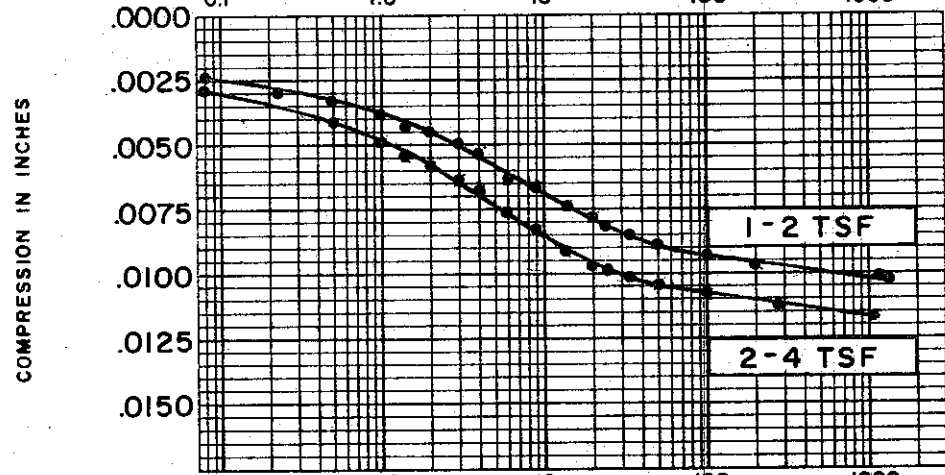
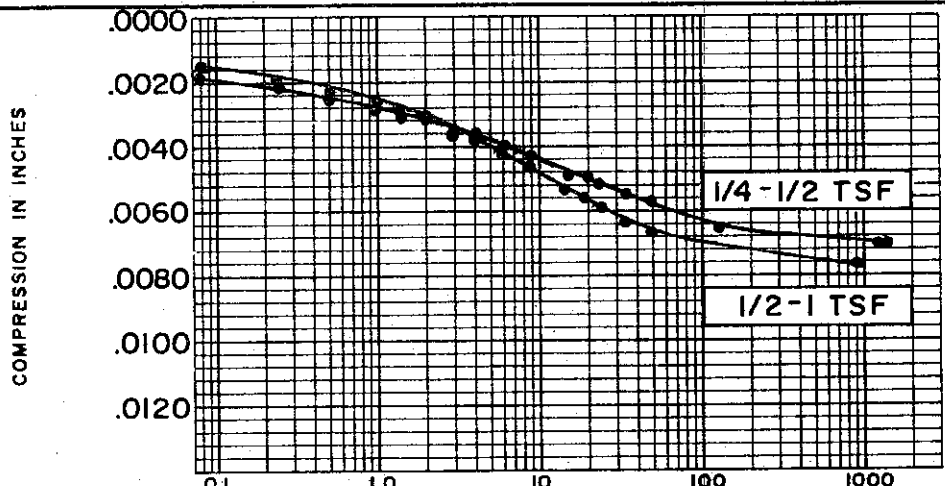

SOIL PROPERTIES

SOIL DESCRIPTION: SILTY CLAY (CL-CH)
 SPECIFIC GRAVITY 2.72
 INITIAL WATER CONTENT 23.6%
 FINAL WATER CONTENT 23.4%

BORING NO. 105
 SAMPLE NO. 1
 DEPTH 5.1' TO 5.4'

TEST DATA

INITIAL SAMPLE HEIGHT 0.75"
 INITIAL SAMPLE DIAMETER 2.50"
 INITIAL VOID RATIO 0.642

**CONSOLIDATION TEST
 TIME VS. COMPRESSION CURVES**

THE DETROIT EDISON COMPANY
 BELLE RIVER PLANT UNITS I & II

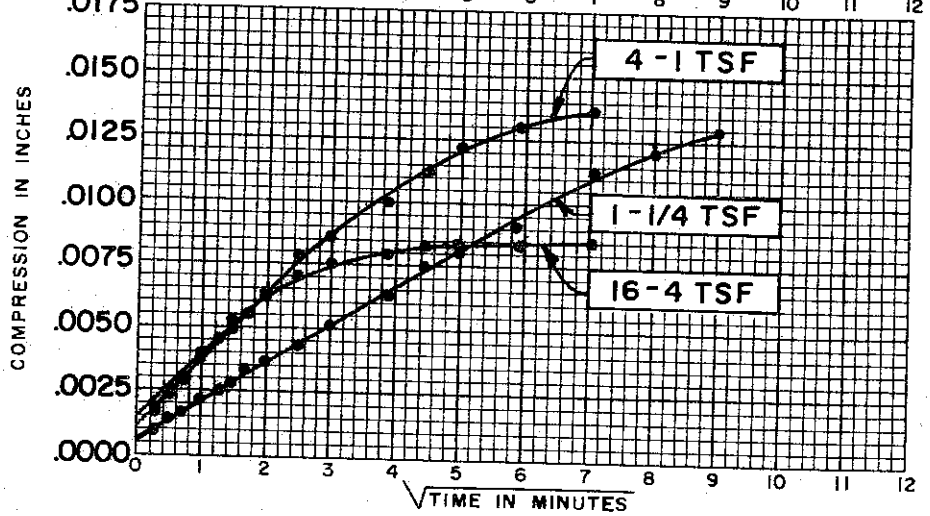
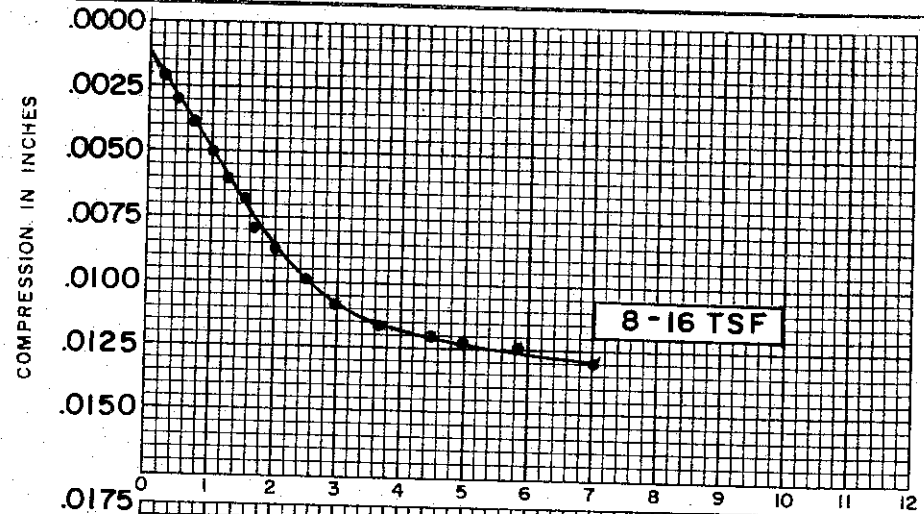
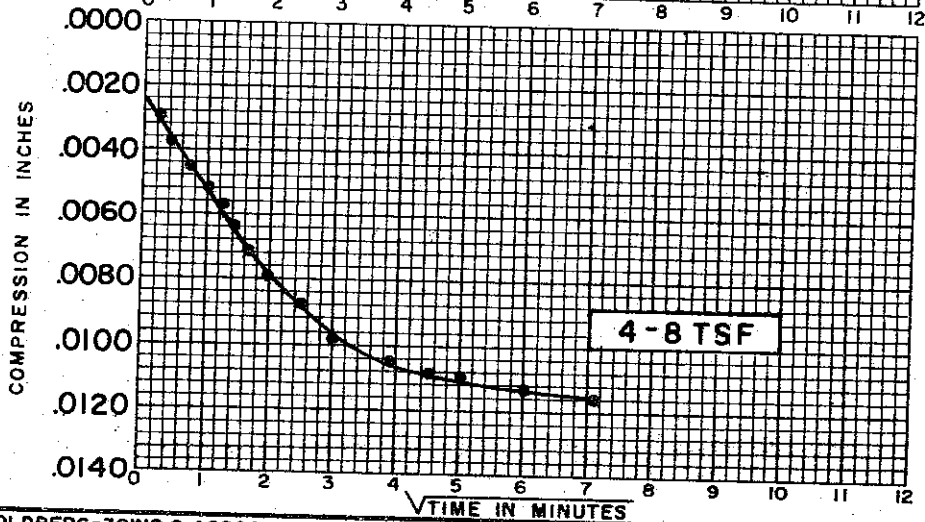
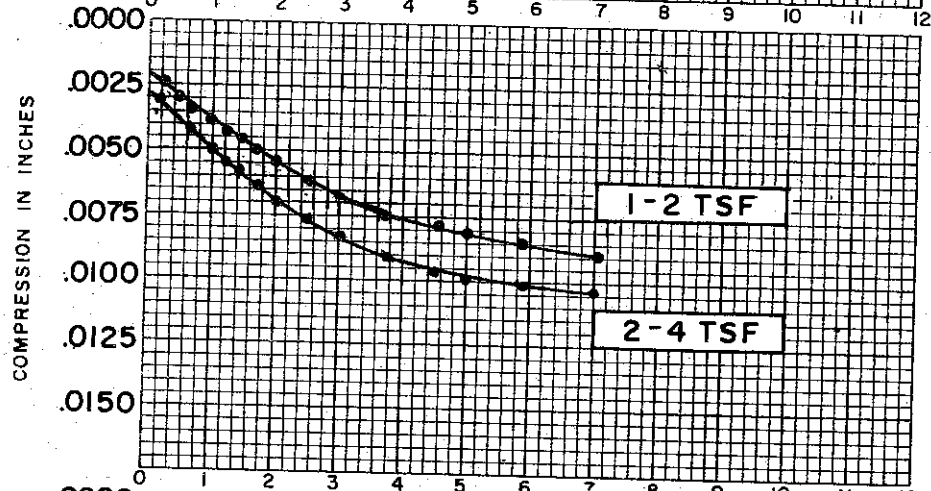
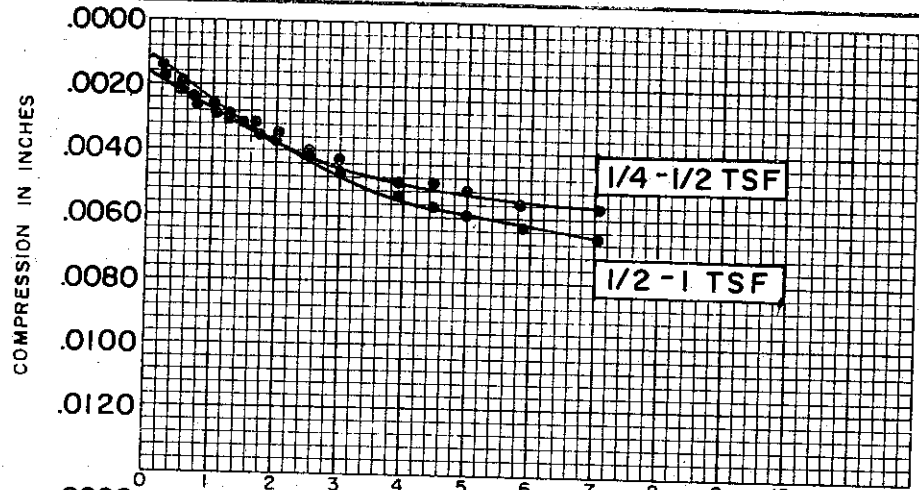

SOIL PROPERTIES

SOIL DESCRIPTION: SILTY CLAY (CL-CH)
 SPECIFIC GRAVITY 2.72
 INITIAL WATER CONTENT 23.6%
 FINAL WATER CONTENT 23.4%

BORING NO. 105
 SAMPLE NO. 1
 DEPTH 5.1' TO 5.4'

TEST DATA

INITIAL SAMPLE HEIGHT 0.75"
 INITIAL SAMPLE DIAMETER 2.50"
 INITIAL VOID RATIO 0.642

**CONSOLIDATION TEST
 TIME VS. COMPRESSION CURVES**

THE DETROIT EDISON COMPANY
 BELLE RIVER PLANT UNITS I & II

C-537

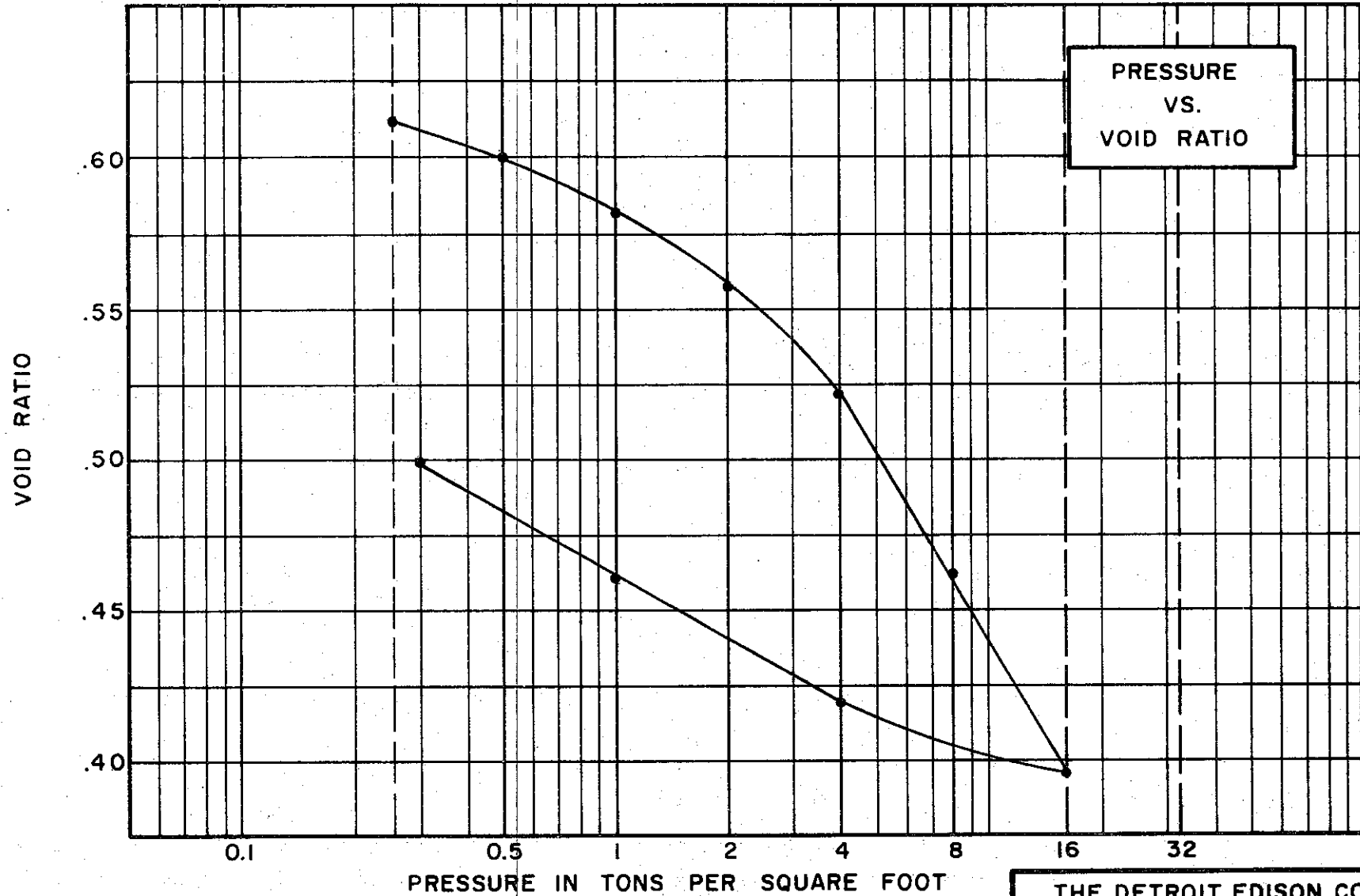

SOIL PROPERTIES

SOIL DESCRIPTION SILTY CLAY, (CL)
 SPECIFIC GRAVITY 2.70
 WATER CONTENT, INITIAL 23.7%
 ATTERBERG LIMITS:
 LIQUID LIMIT 37 % PLASTIC LIMIT 19 %

TEST DATA

INITIAL SAMPLE HEIGHT 0.80"
 INITIAL SAMPLE DIAMETER 2.50"
 INITIAL VOID RATIO 0.625

THE DETROIT EDISON COMPANY
 BELLE RIVER PLANT UNITS I & II

**CONSOLIDATION TEST
 VOID RATIO VS. LOG PRESSURE**

BORING NO. 105 TEST NO. C380.1
 SAMPLE NO. 8 DATE JULY 1974
 DEPTH 70.9' TO 71.2'

C-539

COMPRESSION IN INCHES

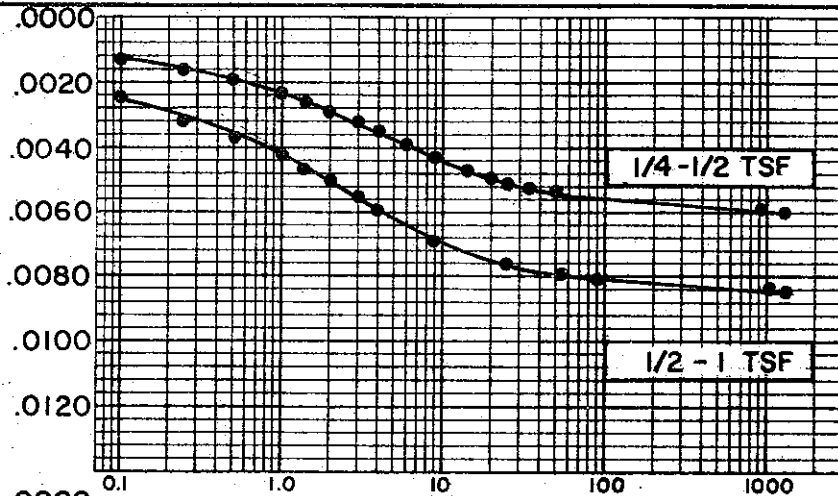

COMPRESSION IN INCHES

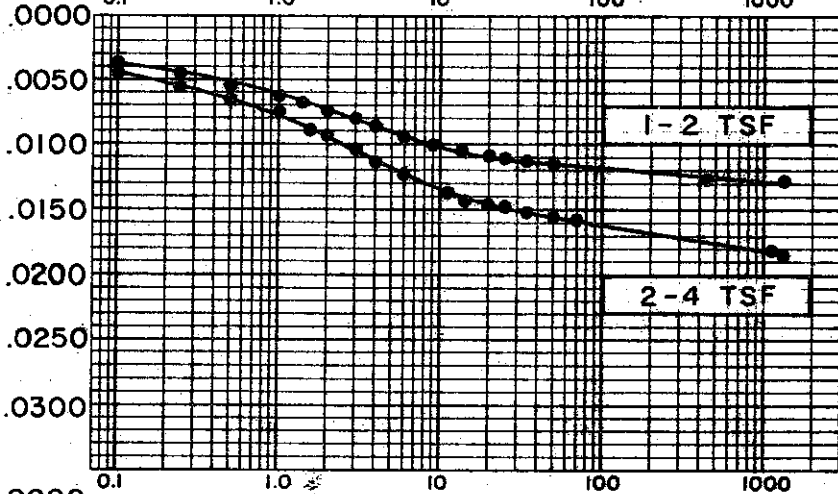

COMPRESSION IN INCHES

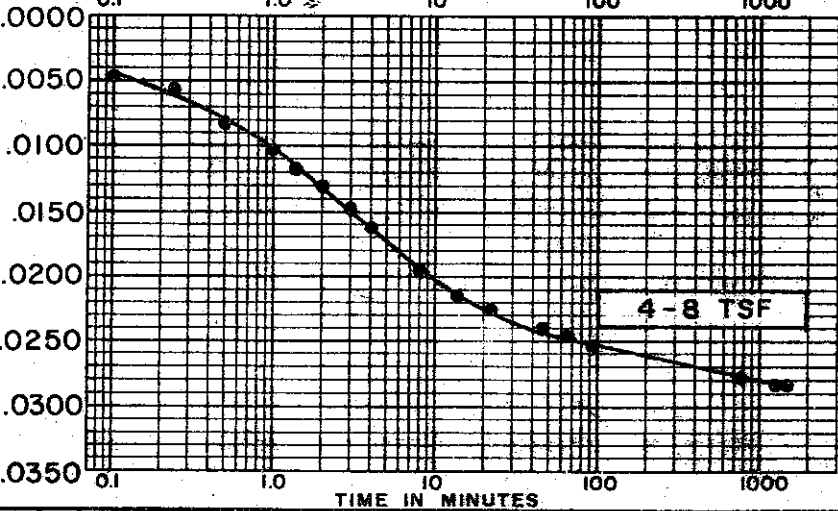

COMPRESSION IN INCHES

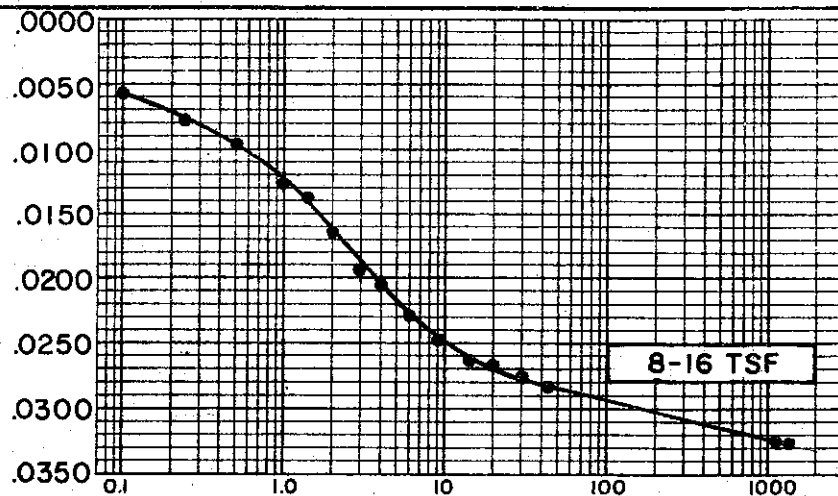

COMPRESSION IN INCHES

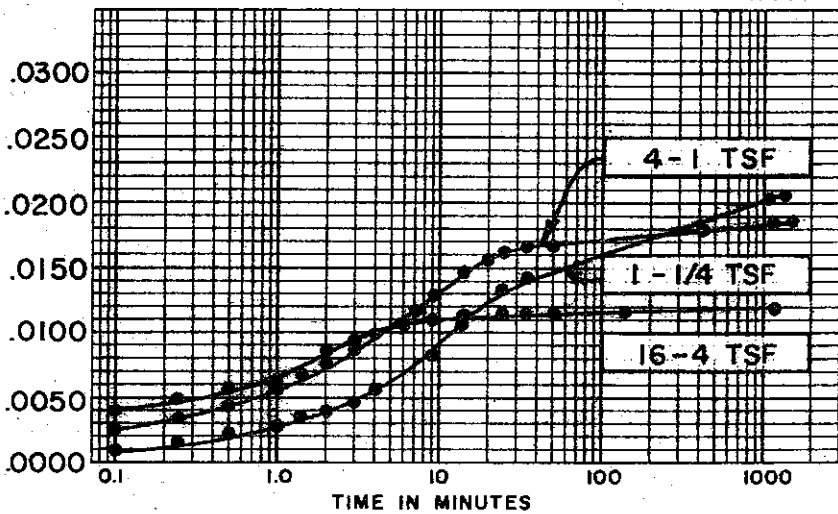

SOIL PROPERTIES

SOIL DESCRIPTION: SILTY CLAY (CL)
 SPECIFIC GRAVITY 2.70
 INITIAL WATER CONTENT 23.7 %
 FINAL WATER CONTENT 22.5 %

BORING NO. 105
 SAMPLE NO. 8
 DEPTH 70.9' TO 71.2'

TEST DATA

INITIAL SAMPLE HEIGHT 0.80"
 INITIAL SAMPLE DIAMETER 2.50"
 INITIAL VOID RATIO 0.625

**CONSOLIDATION TEST
 TIME VS. COMPRESSION CURVE**

THE DETROIT EDISON COMPANY
 BELLE RIVER PLANT UNITS I & II

C-540

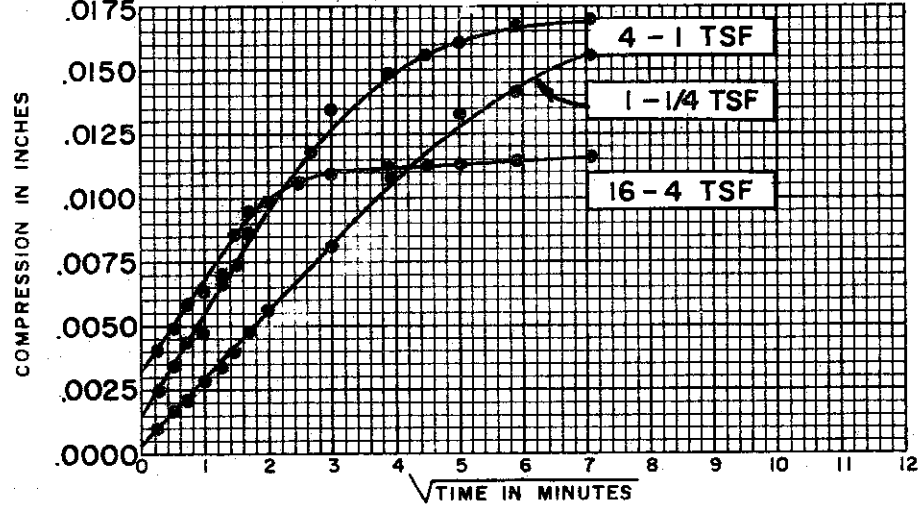
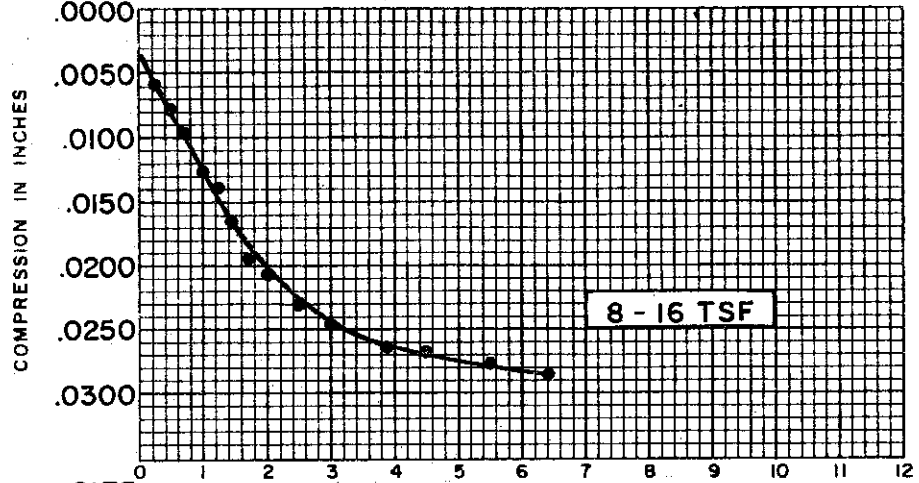
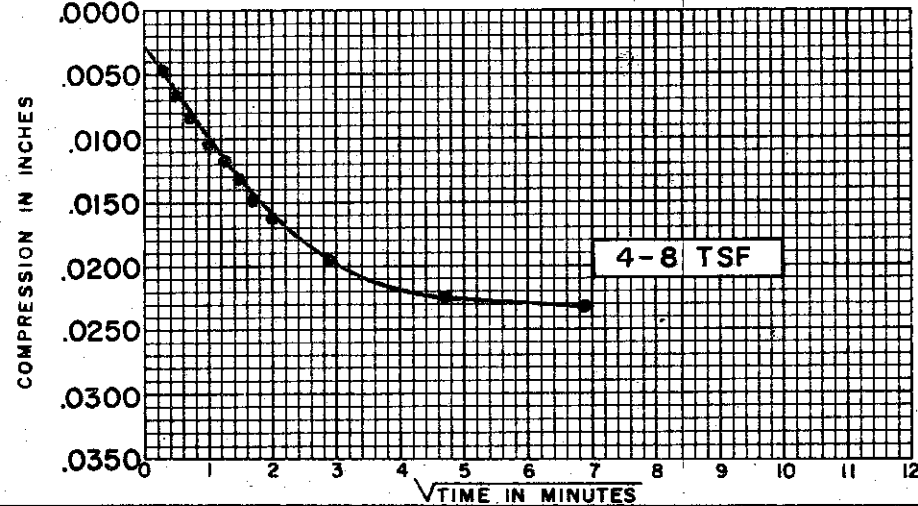
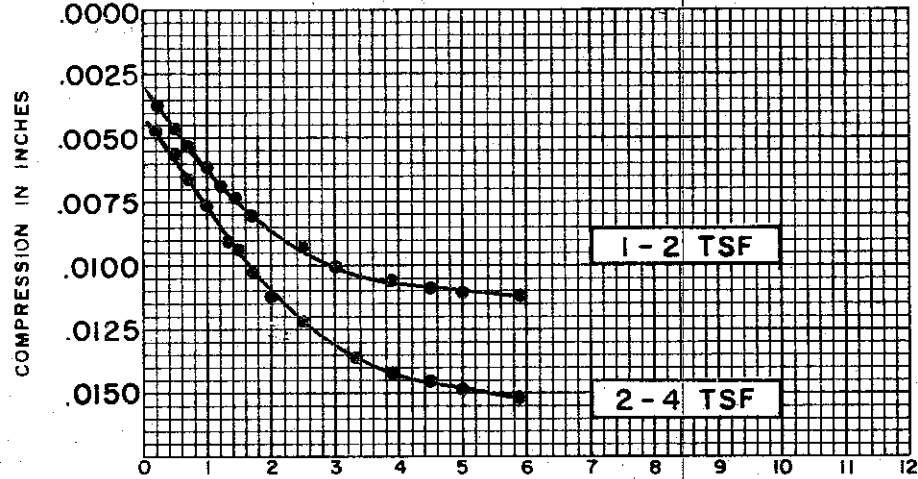
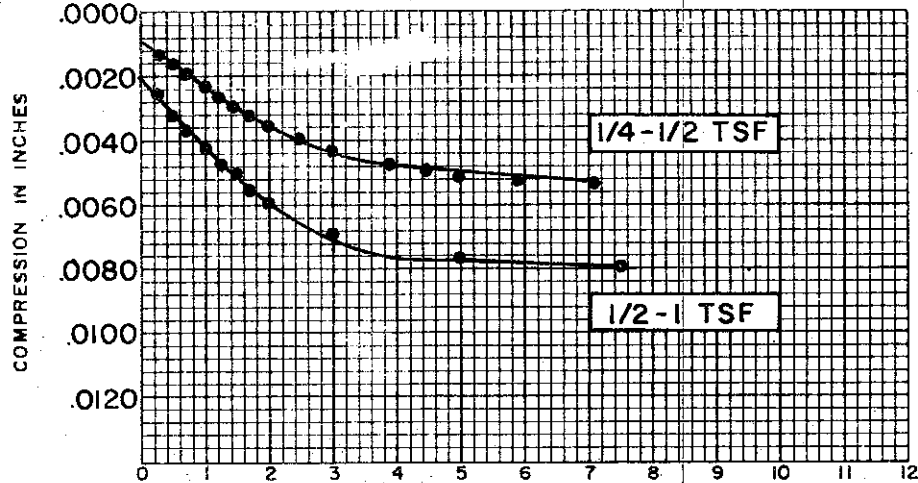

SOIL PROPERTIES

SOIL DESCRIPTION: SILTY
CLAY (CL)
 SPECIFIC GRAVITY 2.70
 INITIAL WATER CONTENT 23.7 %
 FINAL WATER CONTENT 22.5 %

BORING NO. 105
 SAMPLE NO. 8
 DEPTH 70.9' TO 71.2'

TEST DATA

INITIAL SAMPLE HEIGHT 0.80"
 INITIAL SAMPLE DIAMETER 2.50"
 INITIAL VOID RATIO 0.625

**CONSOLIDATION TEST
 TIME VS. COMPRESSION CURVES**

THE DETROIT EDISON COMPANY
 BELLE RIVER PLANT UNITS I & II

VOID RATIO

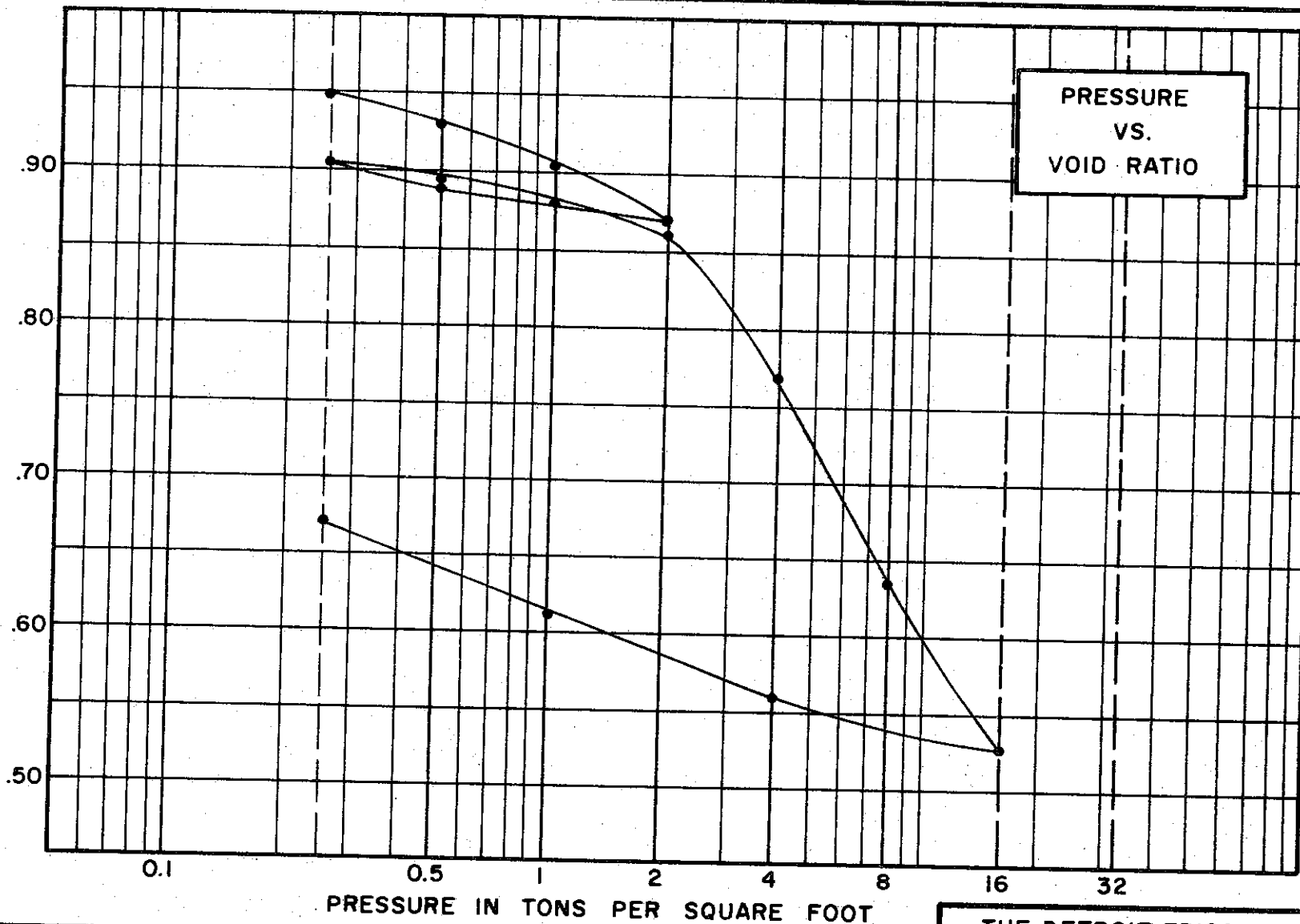

SOIL PROPERTIES

SOIL DESCRIPTION SILTY
CLAY (CL)
 SPECIFIC GRAVITY 2.70
 WATER CONTENT, INITIAL 36.9%
 ATTERBERG LIMITS:
 LIQUID LIMIT 41 % PLASTIC LIMIT 22 %

TEST DATA

INITIAL SAMPLE HEIGHT 0.80"
 INITIAL SAMPLE DIAMETER 2.50"
 INITIAL VOID RATIO 0.969

THE DETROIT EDISON COMPANY
 BELLE RIVER PLANT UNITS I & II

**CONSOLIDATION TEST
 VOID RATIO VS. LOG PRESSURE**

BORING NO. 118 TEST NO. C256.1
 SAMPLE NO. 5 DATE JULY 1974
 DEPTH 38.6' TO 38.9'

C-541

GOLDBERG-ZOINO & ASSOCIATES, INC.
 SOIL AND FOUNDATION ENGINEERS

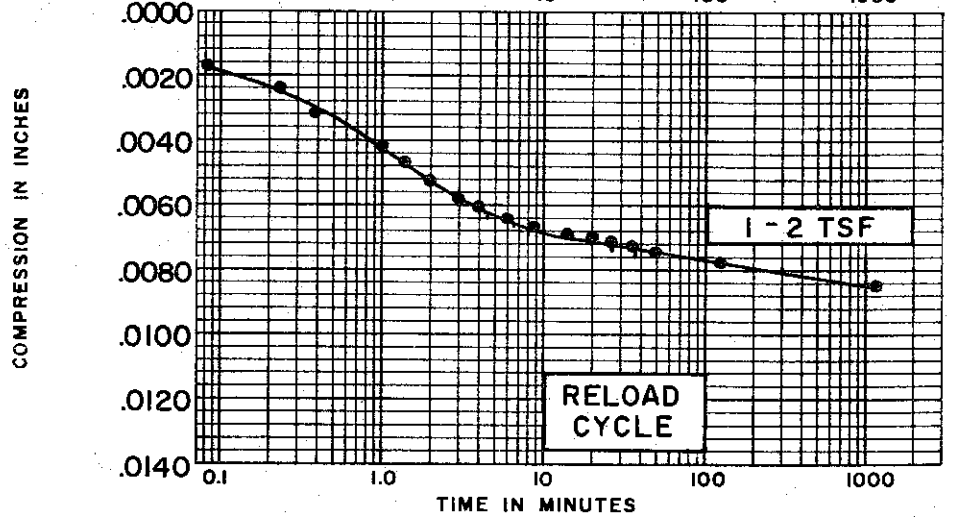
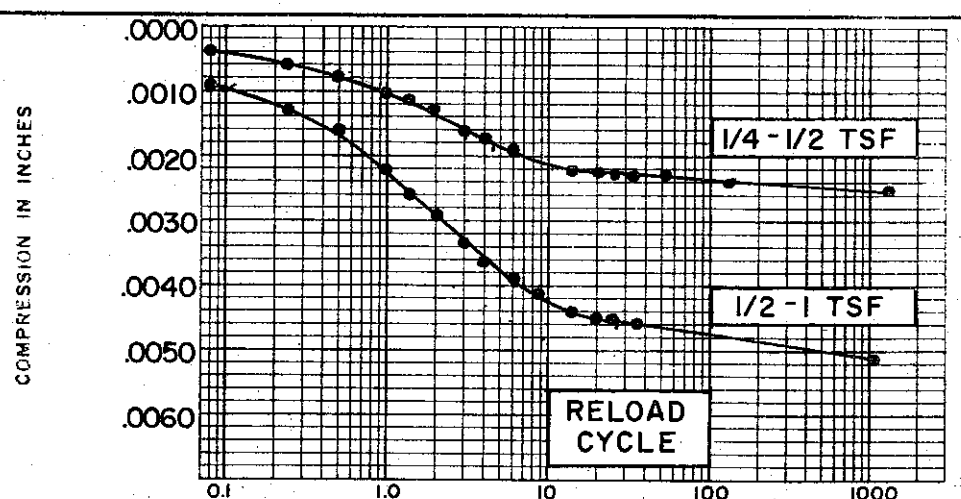
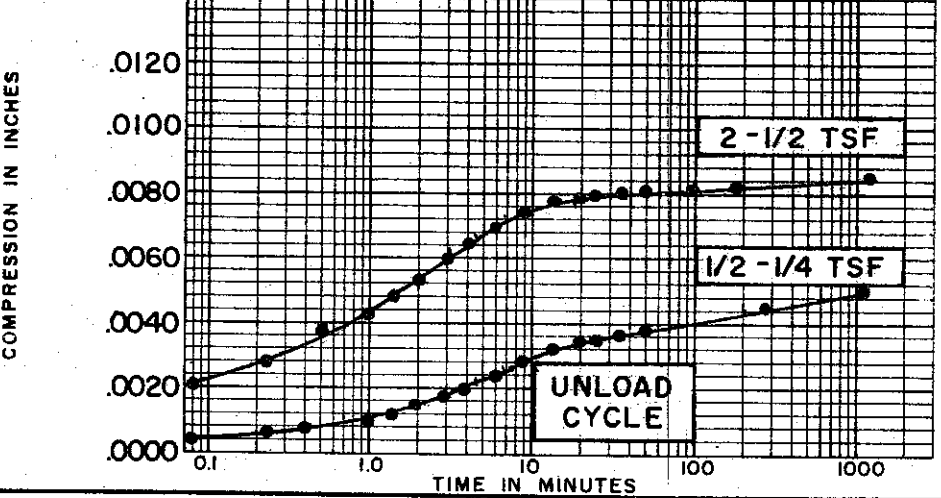
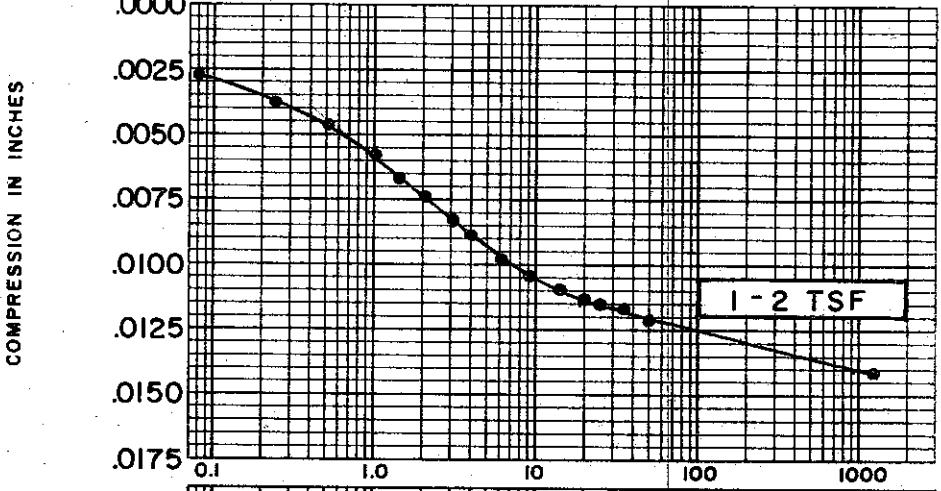
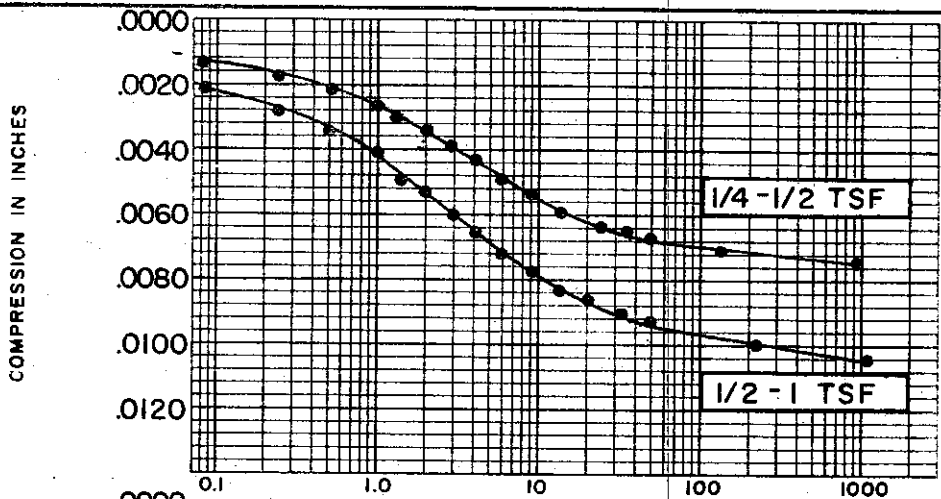

SOIL PROPERTIES		BORING NO.	118
SOIL DESCRIPTION:	SILTY CLAY (CL)	SAMPLE NO.	5
SPECIFIC GRAVITY	2.70	DEPTH	38.6' TO 38.9'
INITIAL WATER CONTENT	36.9 %		
FINAL WATER CONTENT	%		
TEST DATA			
INITIAL SAMPLE HEIGHT	0.80"		
INITIAL SAMPLE DIAMETER	2.50"		
INITIAL VOID RATIO	0.969		
		CONSOLIDATION TEST	
		TIME VS. COMPRESSION CURVE	
		THE DETROIT EDISON COMPANY	
		BELLE RIVER PLANT UNITS I & II	
		FILE 1255	

COMPRESSION IN INCHES

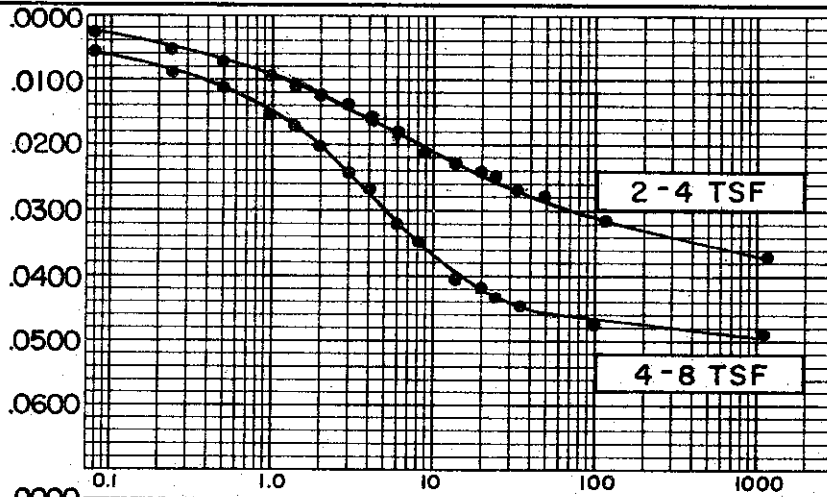

COMPRESSION IN INCHES

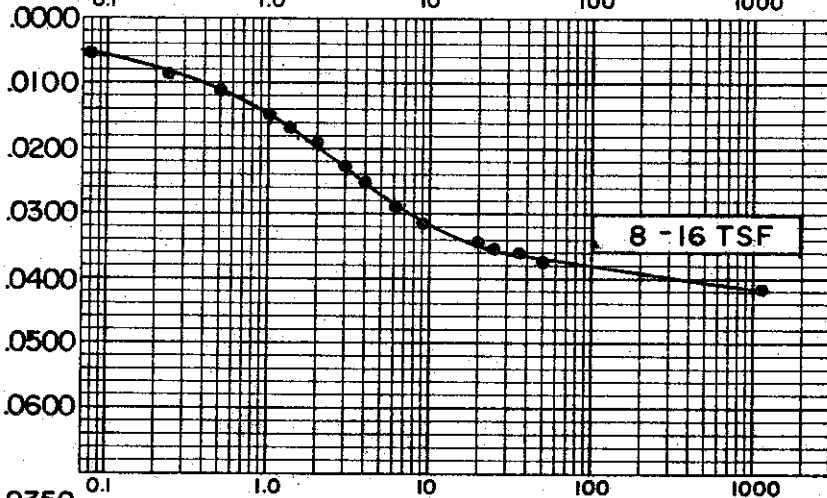

COMPRESSION IN INCHES

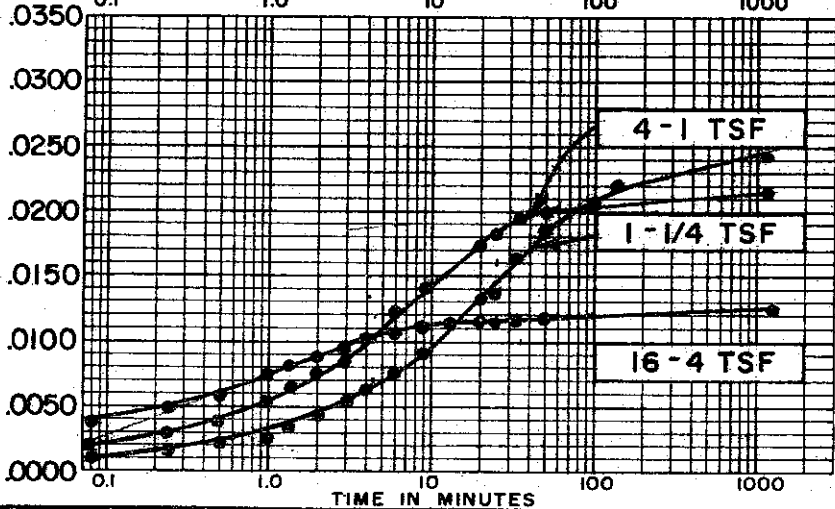

COMPRESSION IN INCHES

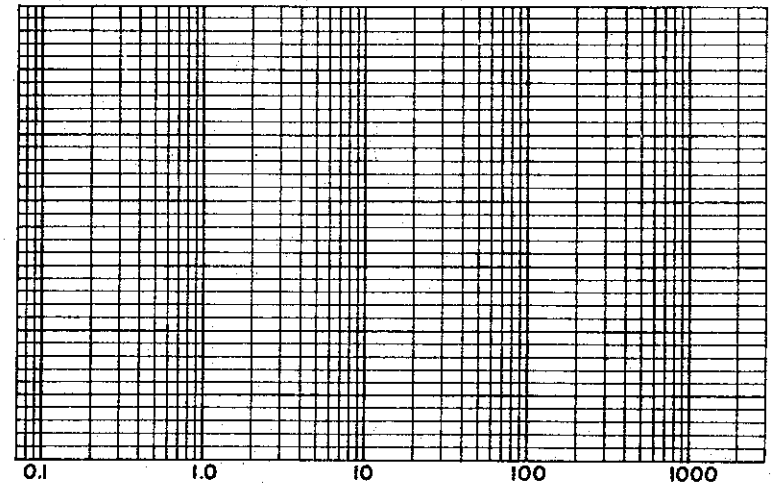

COMPRESSION IN INCHES

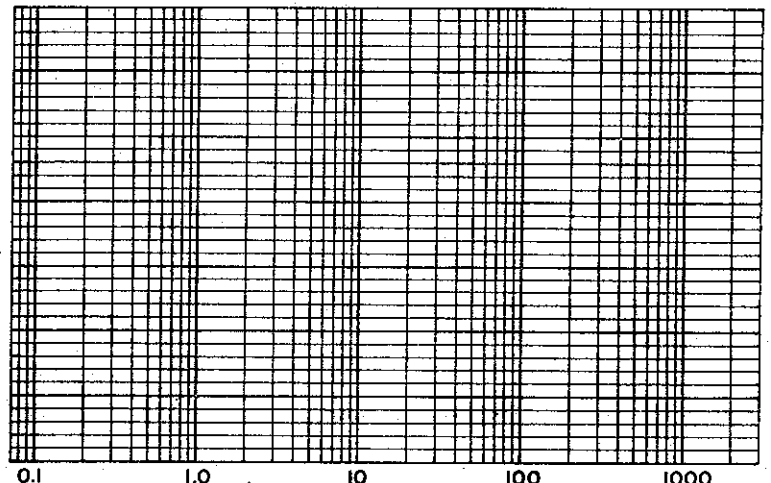

TIME IN MINUTES

SOIL PROPERTIES

SOIL DESCRIPTION: SILTY
CLAY (CL)
 SPECIFIC GRAVITY 2.70
 INITIAL WATER CONTENT 36.9 %
 FINAL WATER CONTENT %

BORING NO. 118
 SAMPLE NO. 5
 DEPTH 38.6' TO 38.9'

TEST DATA

INITIAL SAMPLE HEIGHT 0.80"
 INITIAL SAMPLE DIAMETER 2.50"
 INITIAL VOID RATIO 0.969

**CONSOLIDATION TEST
 TIME VS. COMPRESSION CURVE**

THE DETROIT EDISON COMPANY
 BELLE RIVER PLANT UNITS I & II

FILE 1255

C-543

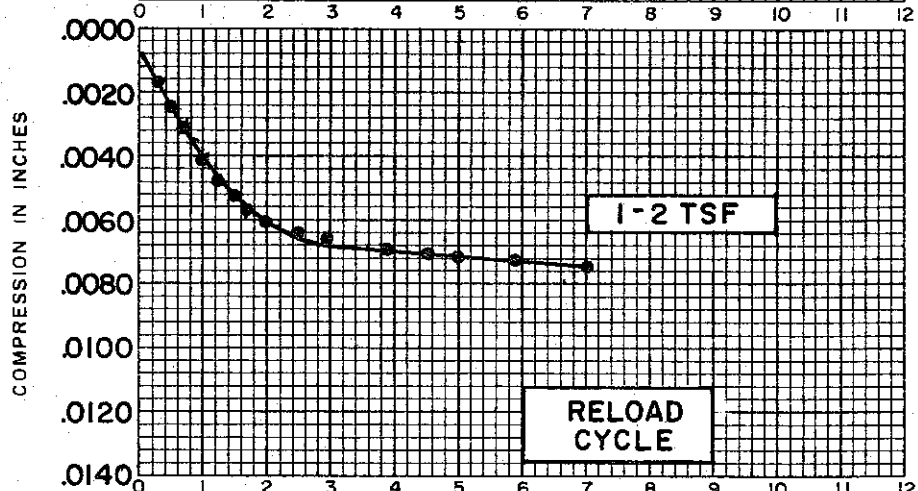
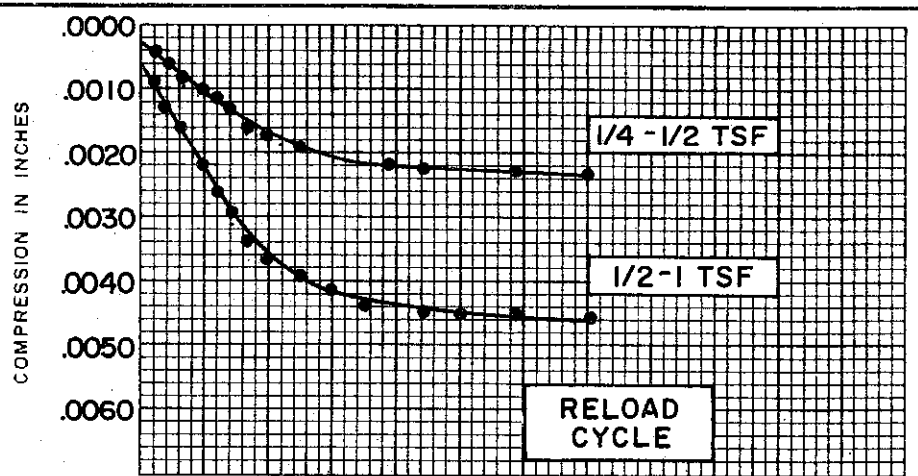
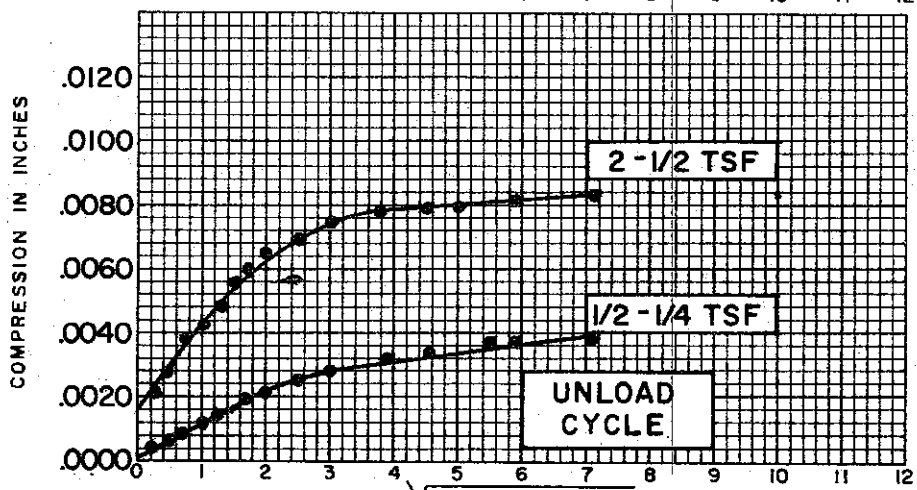
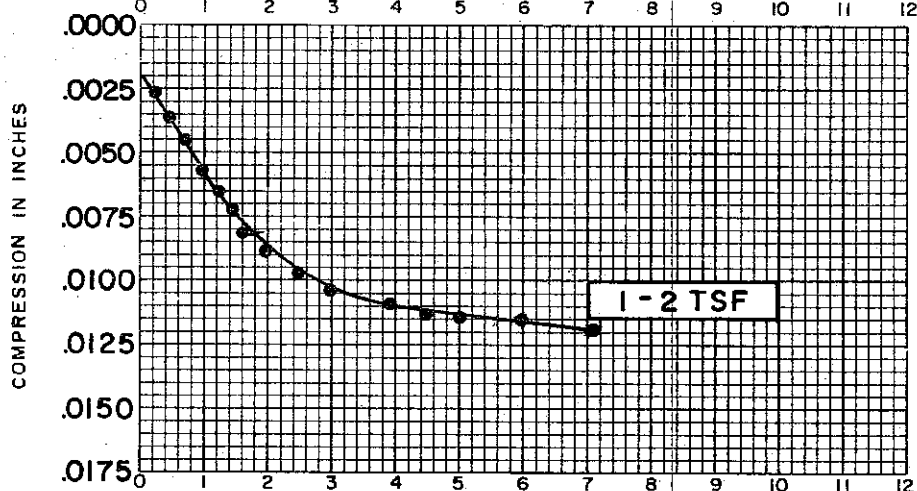
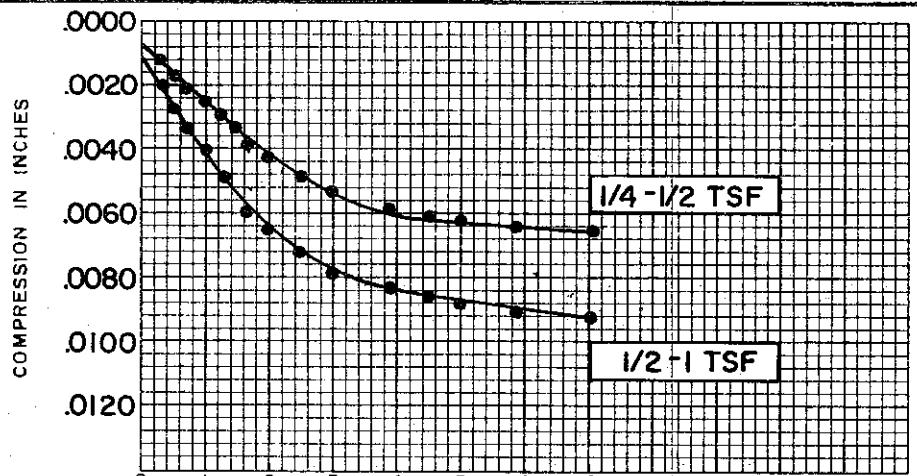

SOIL PROPERTIES	
SOIL DESCRIPTION:	SILTY CLAY (CL)
SPECIFIC GRAVITY	2.70
INITIAL WATER CONTENT	36.9 %
FINAL WATER CONTENT	%
BORING NO.	118
SAMPLE NO.	5
DEPTH	38.6' TO 38.9'

TEST DATA	
INITIAL SAMPLE HEIGHT	0.80"
INITIAL SAMPLE DIAMETER	2.50"
INITIAL VOID RATIO	0.969

CONSOLIDATION TEST
TIME VS. COMPRESSION CURVES
 THE DETROIT EDISON COMPANY
 BELLE RIVER PLANT UNITS I & II

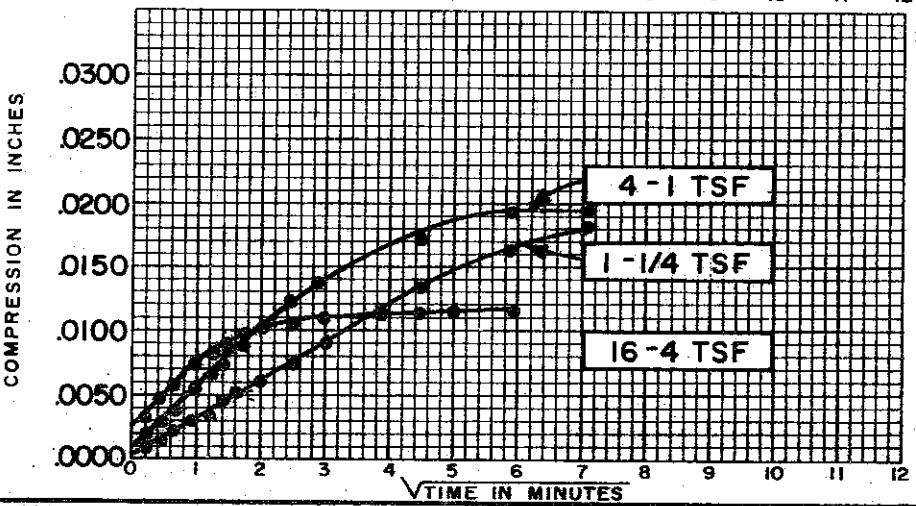
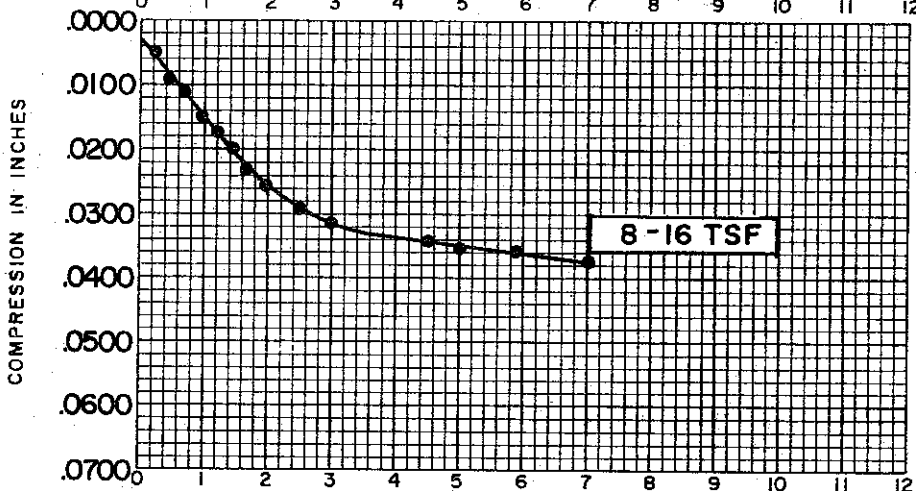
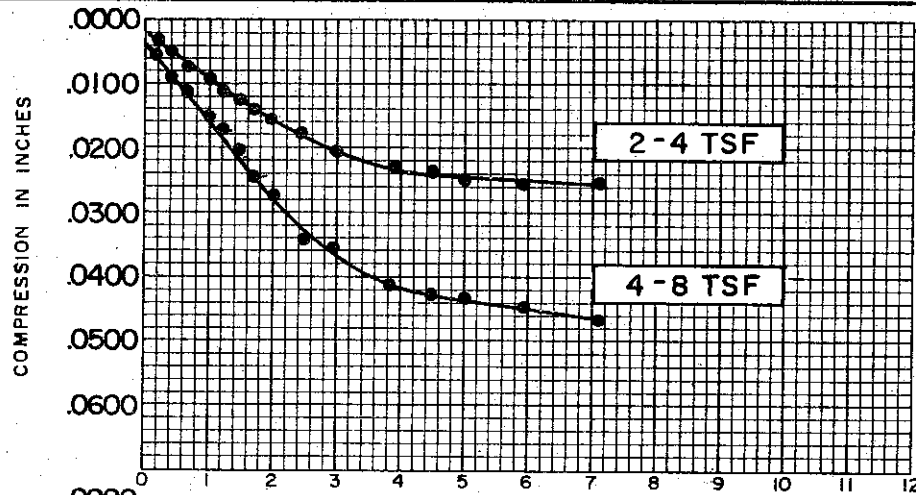

COMPRESSION IN INCHES

COMPRESSION IN INCHES

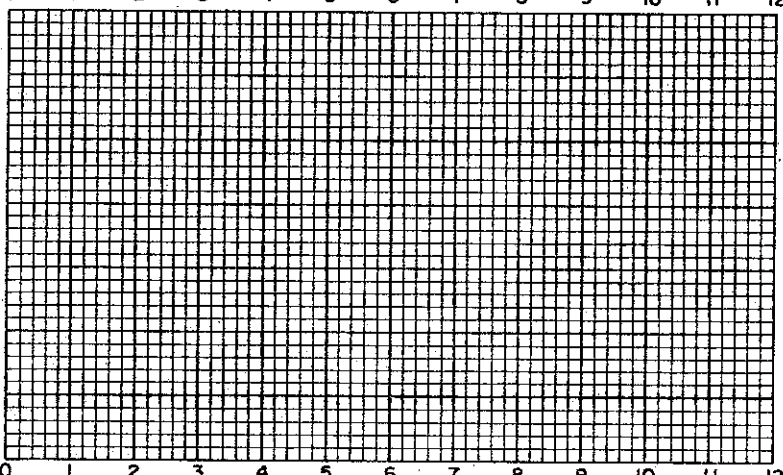
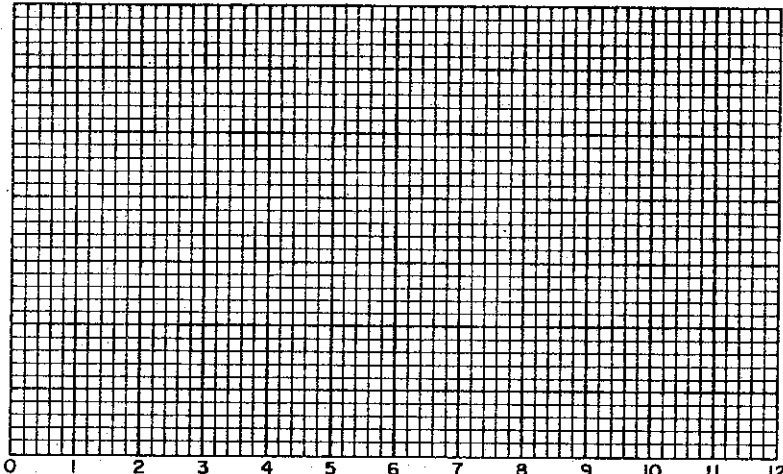

TIME IN MINUTES

SOIL PROPERTIES

SOIL DESCRIPTION: SILTY
CLAY (CL)
SPECIFIC GRAVITY 2.70
INITIAL WATER CONTENT 36.9 %
FINAL WATER CONTENT %

BORING NO. 118
SAMPLE NO. 5
DEPTH 38.6' TO 38.9'

TEST DATA

INITIAL SAMPLE HEIGHT 0.80"
INITIAL SAMPLE DIAMETER 2.50"
INITIAL VOID RATIO 0.969

**CONSOLIDATION TEST
TIME VS. COMPRESSION CURVES**

THE DETROIT EDISON COMPANY
BELLE RIVER PLANT UNITS I & II

C-545

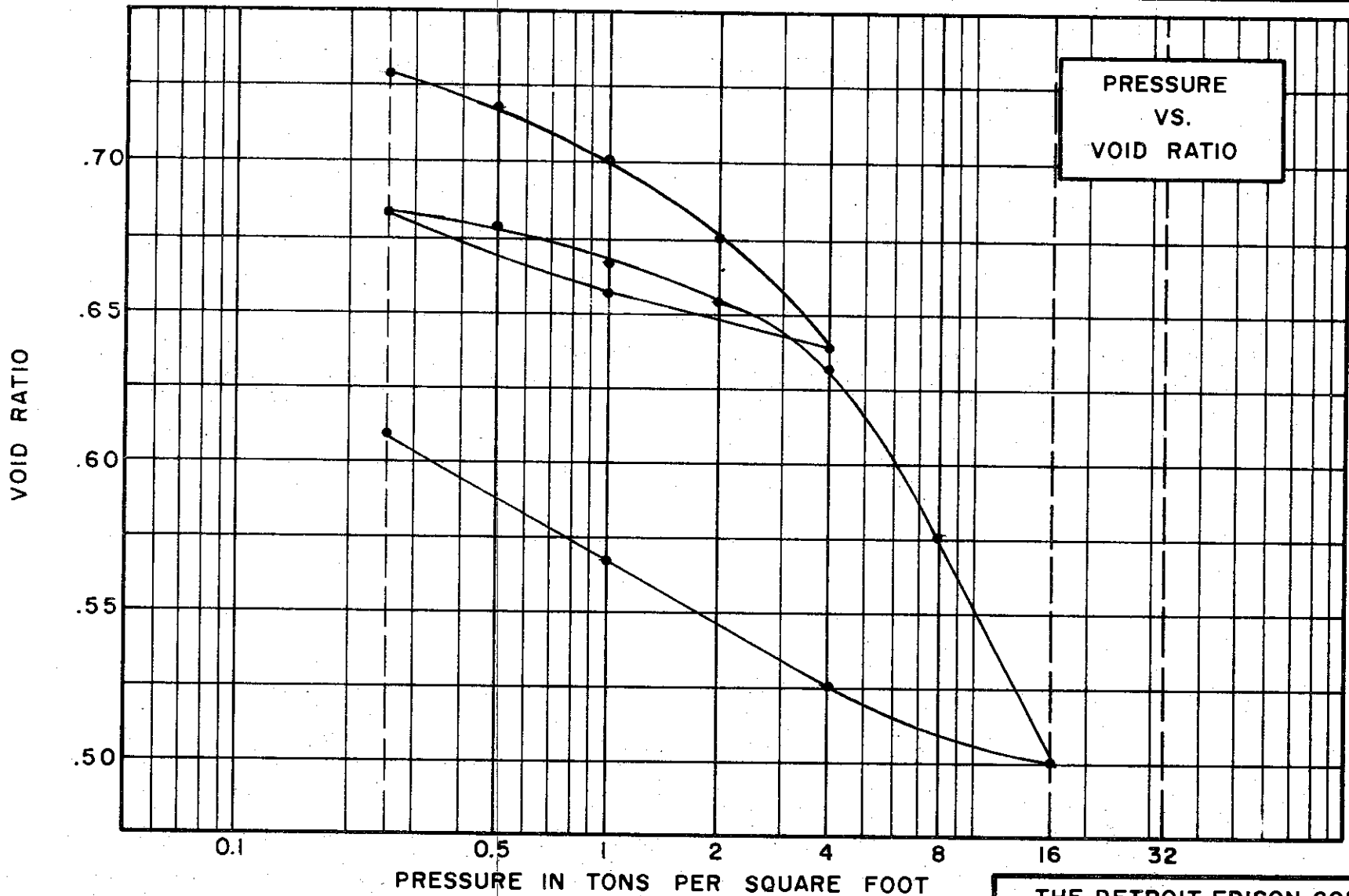

SOIL PROPERTIES

SOIL DESCRIPTION SILTY CLAY, (CL)
 SPECIFIC GRAVITY 2.70
 WATER CONTENT, INITIAL 27.8%
 ATTERBERG LIMITS:
 LIQUID LIMIT 42 % PLASTIC LIMIT 23 %

TEST DATA

INITIAL SAMPLE HEIGHT 0.80"
 INITIAL SAMPLE DIAMETER 2.50"
 INITIAL VOID RATIO 0.741

THE DETROIT EDISON COMPANY
 BELLE RIVER PLANT UNITS I & II

**CONSOLIDATION TEST
 VOID RATIO VS. LOG PRESSURE**

BORING NO. 118 TEST NO. C260.1
 SAMPLE NO. 9 DATE JULY 1974
 DEPTH 78.7' TO 79.0'

COMPRESSION IN INCHES

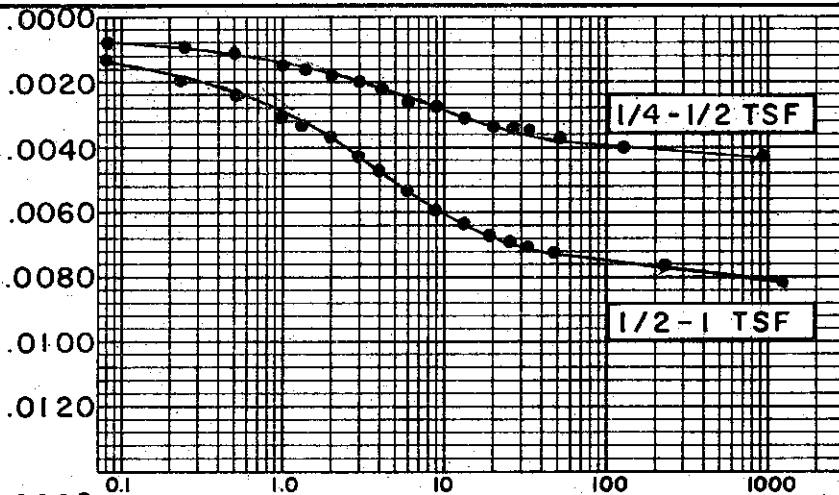

COMPRESSION IN INCHES

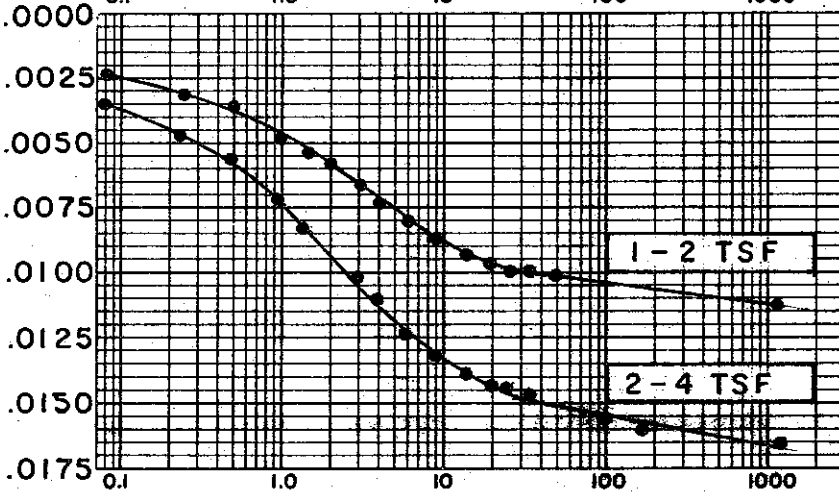

COMPRESSION IN INCHES

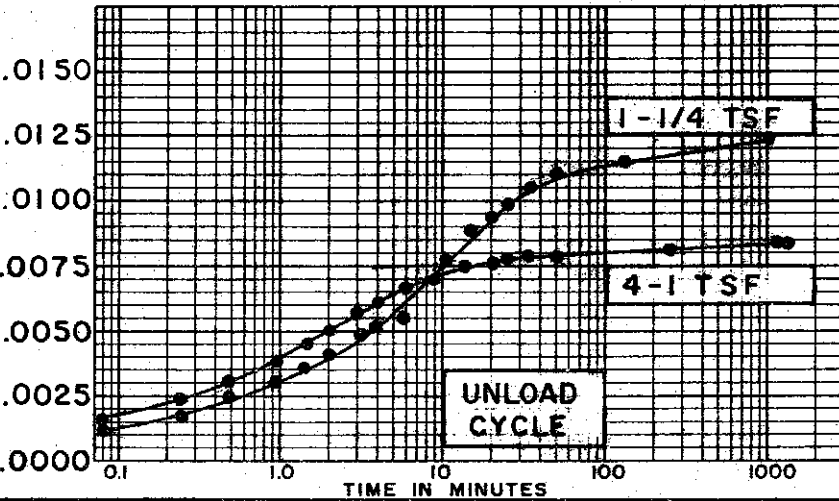

COMPRESSION IN INCHES

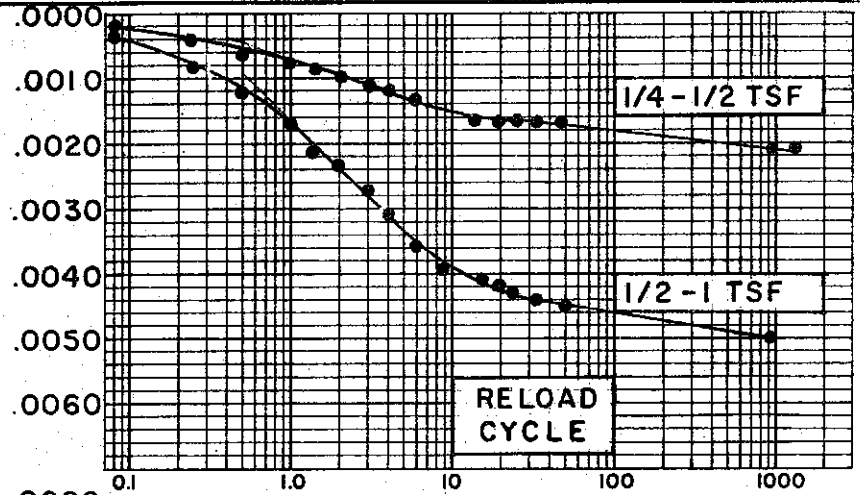

COMPRESSION IN INCHES

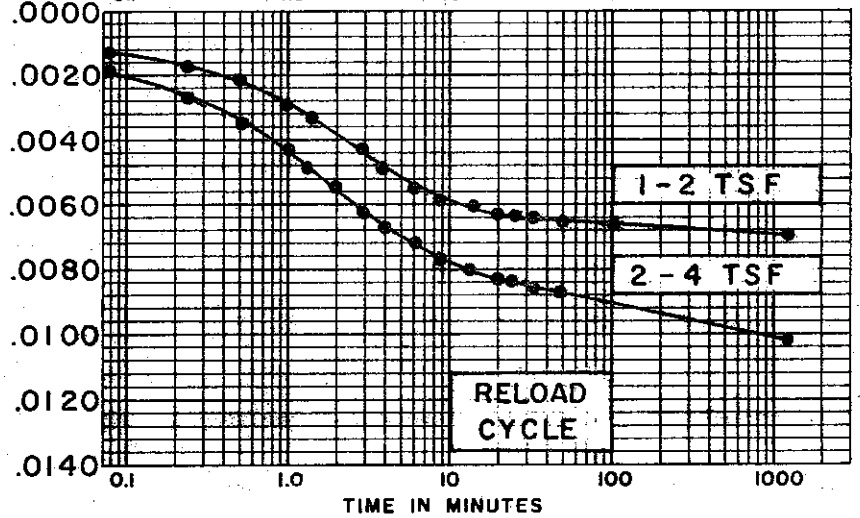

SOIL PROPERTIES

SOIL DESCRIPTION: SILTY CLAY, (CL)
 SPECIFIC GRAVITY 2.70
 INITIAL WATER CONTENT 27.8 %
 FINAL WATER CONTENT 25.6 %

BORING NO. 118
 SAMPLE NO. 9
 DEPTH 78.7' TO 79.0'

TEST DATA

INITIAL SAMPLE HEIGHT 0.80"
 INITIAL SAMPLE DIAMETER 2.50"
 INITIAL VOID RATIO 0.741

**CONSOLIDATION TEST
 TIME VS. COMPRESSION CURVES**

THE DETROIT EDISON COMPANY
 BELLE RIVER PLANT UNITS I & II

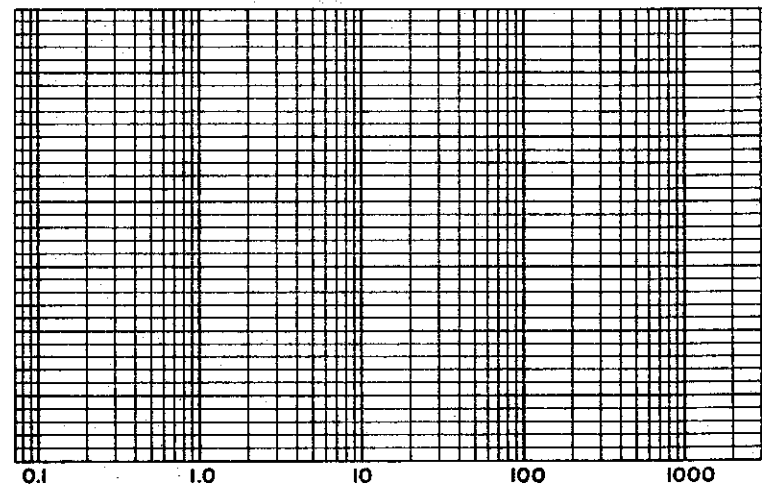
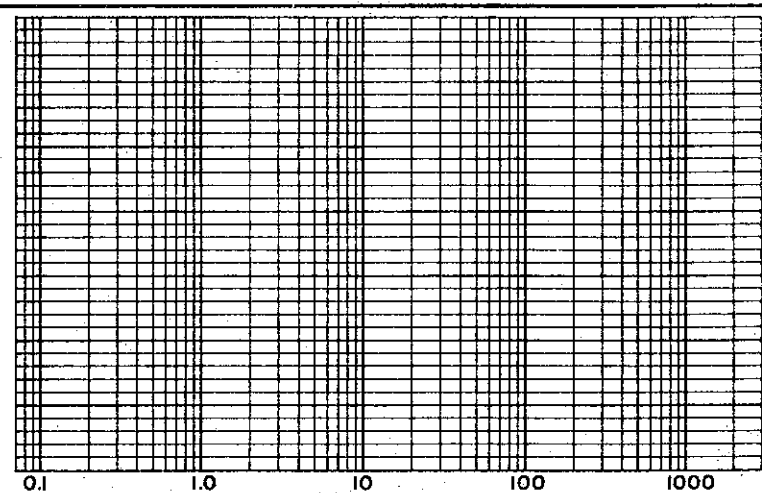
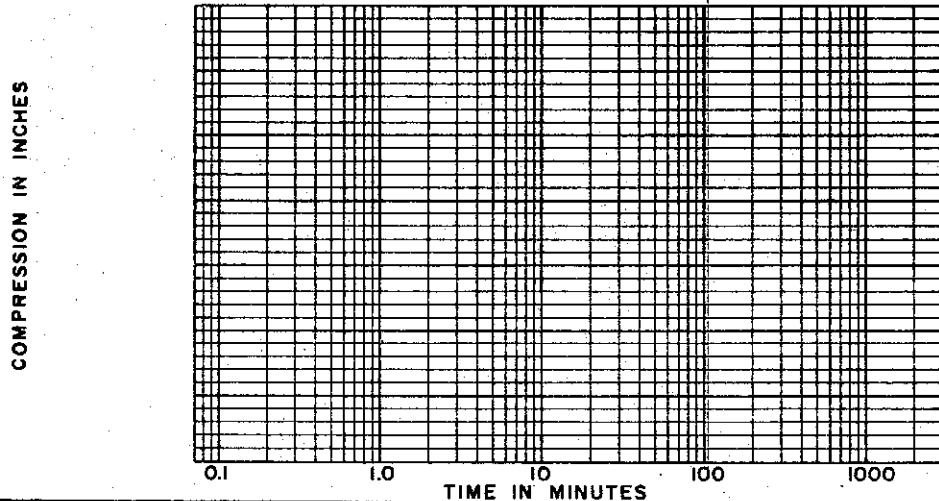
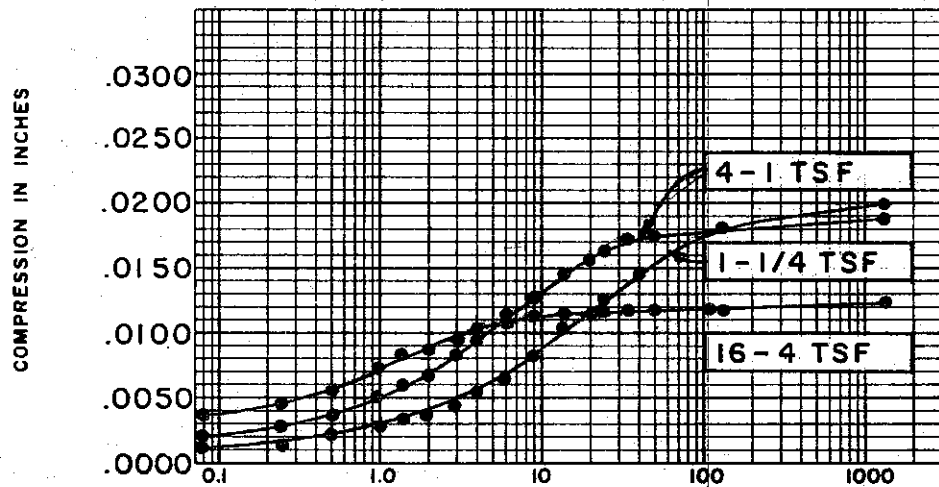
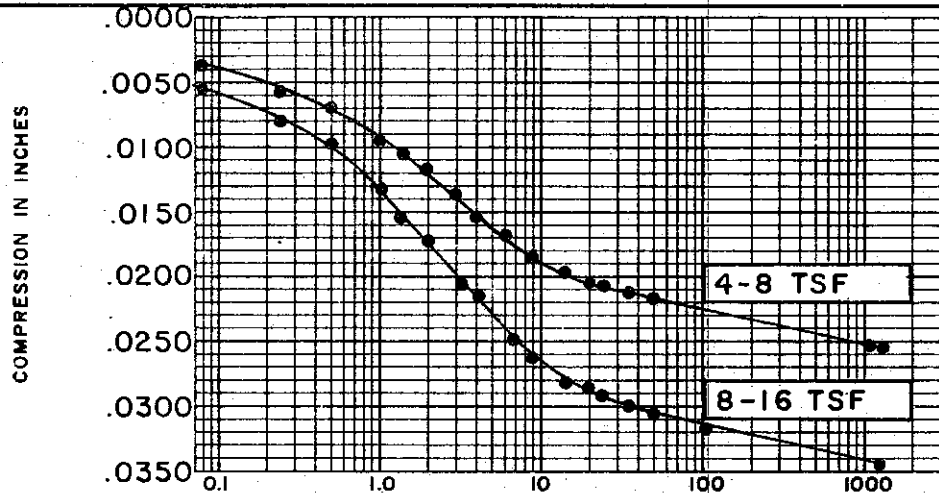

TIME IN MINUTES

SOIL PROPERTIES		BORING NO.	118
SOIL DESCRIPTION:	SILTY CLAY, (CE)	SAMPLE NO.	9
SPECIFIC GRAVITY	2.70	DEPTH	78.7' TO 79.0'
INITIAL WATER CONTENT	27.8 %		
FINAL WATER CONTENT	25.6 %		
TEST DATA		CONSOLIDATION TEST	
INITIAL SAMPLE HEIGHT	0.80"	TIME VS. COMPRESSION CURVES	
INITIAL SAMPLE DIAMETER	2.30"	THE DETROIT EDISON COMPANY	
INITIAL VOID RATIO	0.741	BELLE RIVER PLANT UNITS I & II	

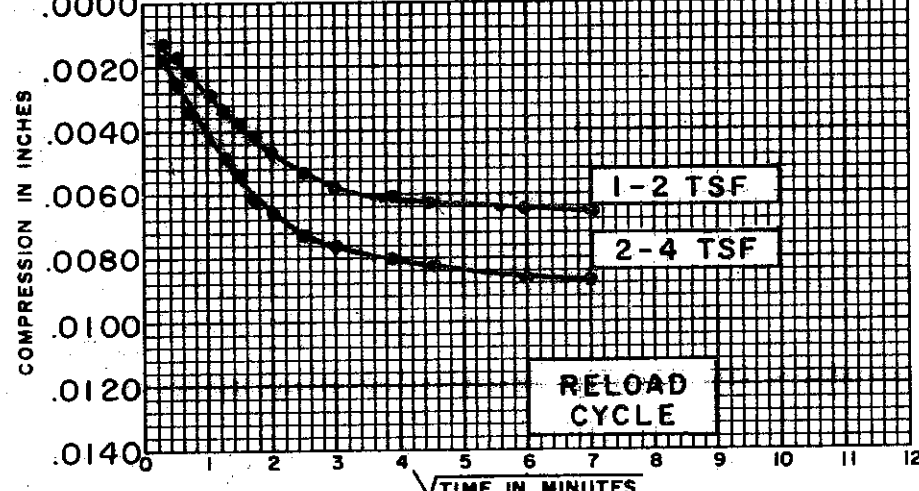
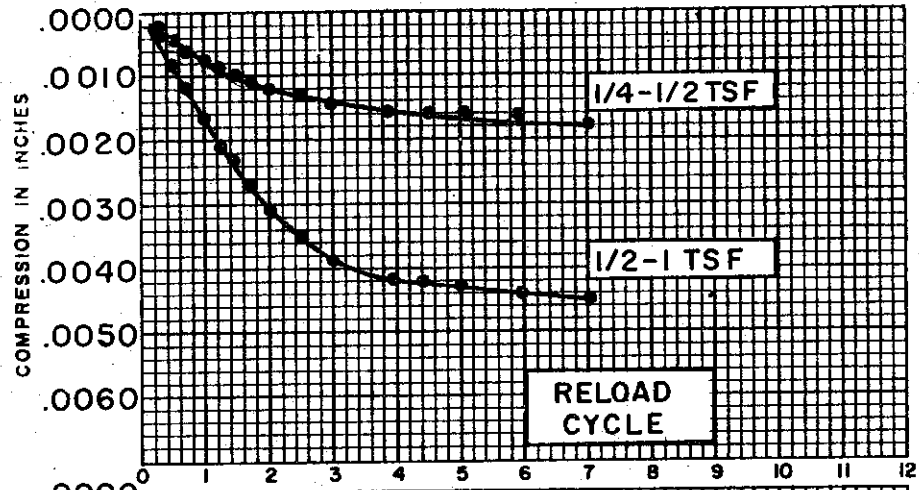
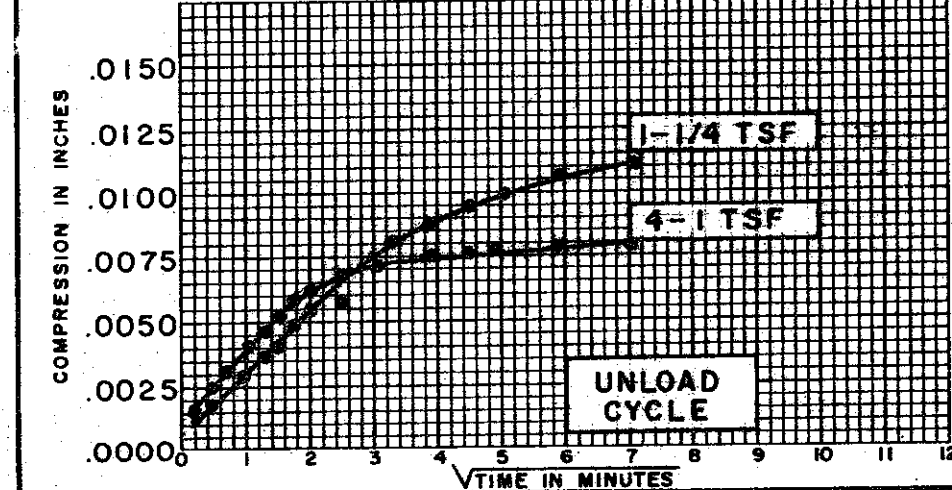
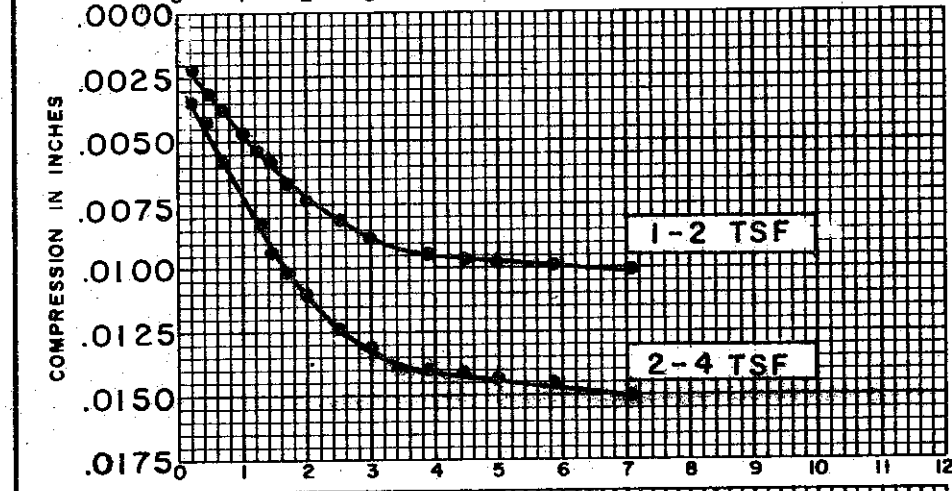
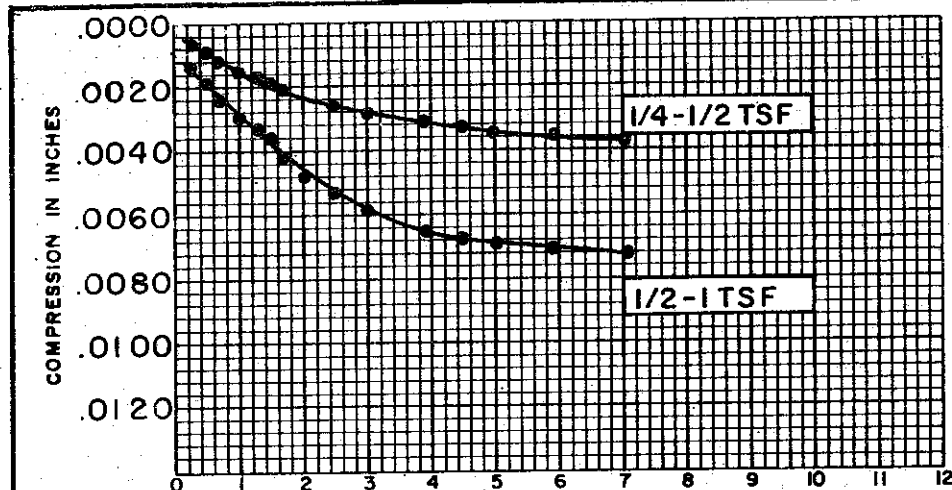

SOIL PROPERTIES		BORING NO. <u>118</u>
SOIL DESCRIPTION: <u>SILTY CLAY, (CL)</u>		SAMPLE NO. <u>9</u>
SPECIFIC GRAVITY	<u>2.70</u>	DEPTH <u>78.7' TO 79.0'</u>
INITIAL WATER CONTENT	<u>27.8 %</u>	
FINAL WATER CONTENT	<u>25.6 %</u>	
TEST DATA		
INITIAL SAMPLE HEIGHT	<u>0.80"</u>	
INITIAL SAMPLE DIAMETER	<u>2.50"</u>	
INITIAL VOID RATIO	<u>0.741</u>	
		CONSOLIDATION TEST
		TIME VS. COMPRESSION CURVES
		THE DETROIT EDISON COMPANY, BELLE RIVER PLANT UNITS I & II

C-549

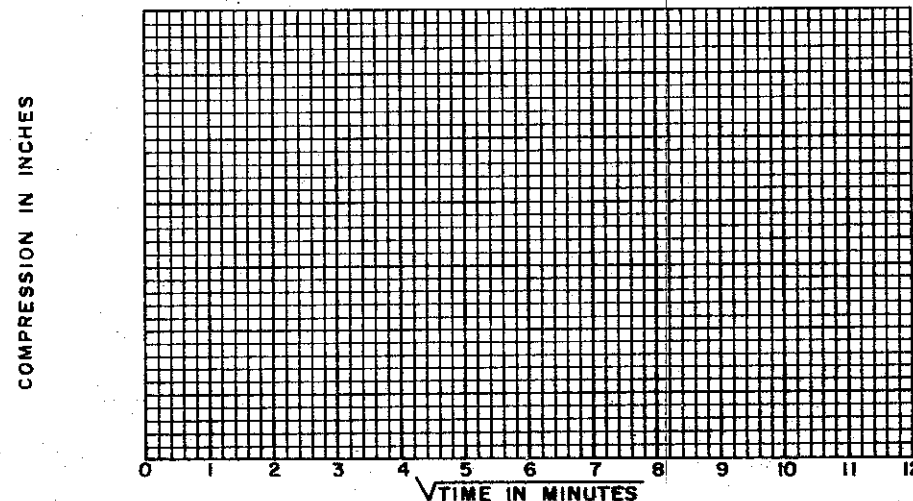
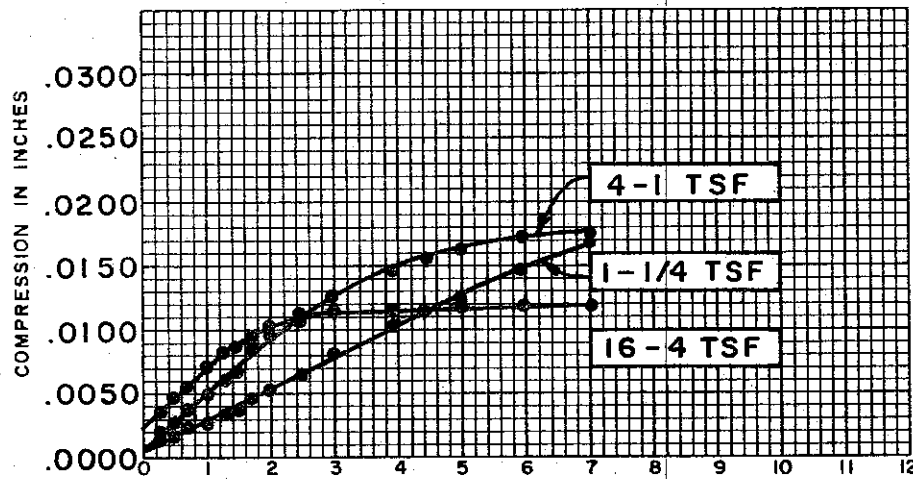
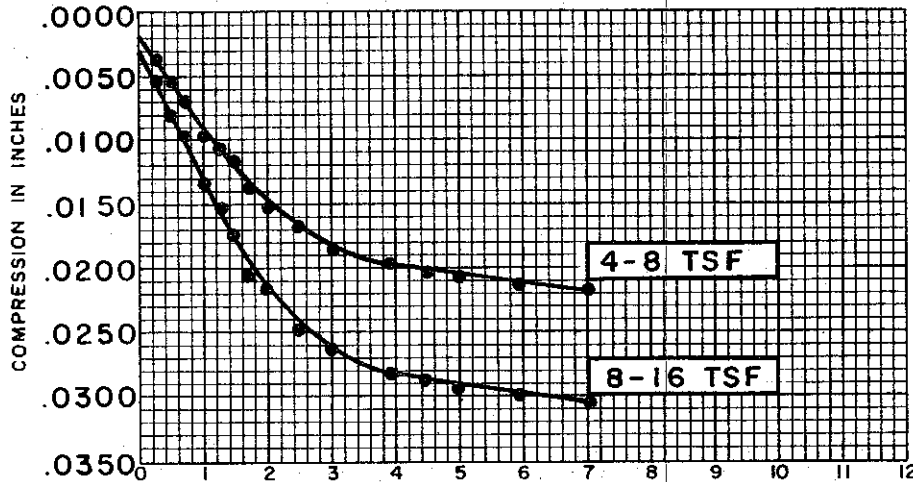

COMPRESSION IN INCHES

COMPRESSION IN INCHES

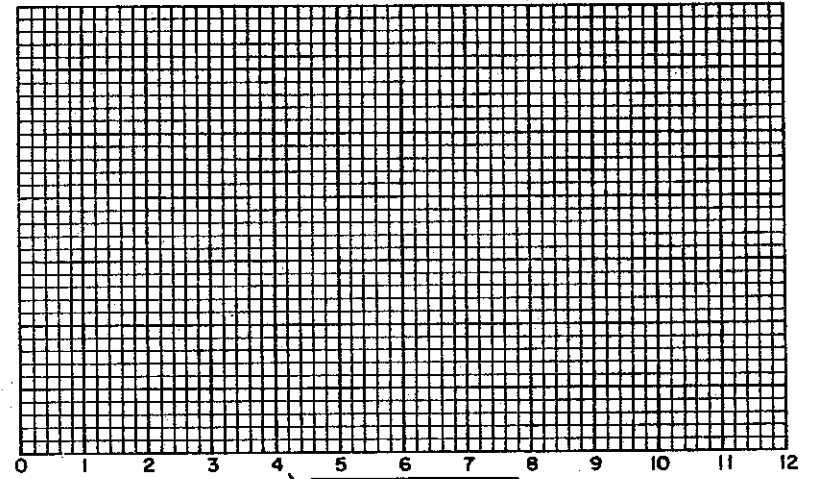
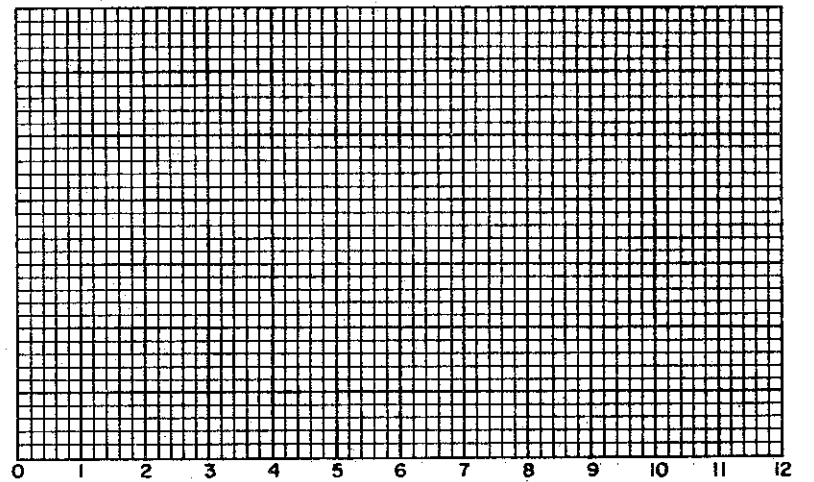

SOIL PROPERTIES

SOIL DESCRIPTION: SILTY CLAY (CL)
 SPECIFIC GRAVITY 2.70
 INITIAL WATER CONTENT 27.8 %
 FINAL WATER CONTENT 25.6 %

BORING NO. 118
 SAMPLE NO. 9
 DEPTH 78.7' TO 79.0'

TEST DATA

INITIAL SAMPLE HEIGHT 0.80"
 INITIAL SAMPLE DIAMETER 2.50"
 INITIAL VOID RATIO 0.741

**CONSOLIDATION TEST
 TIME VS. COMPRESSION CURVES**

THE DETROIT EDISON COMPANY
 BELLE RIVER PLANT UNITS I & II

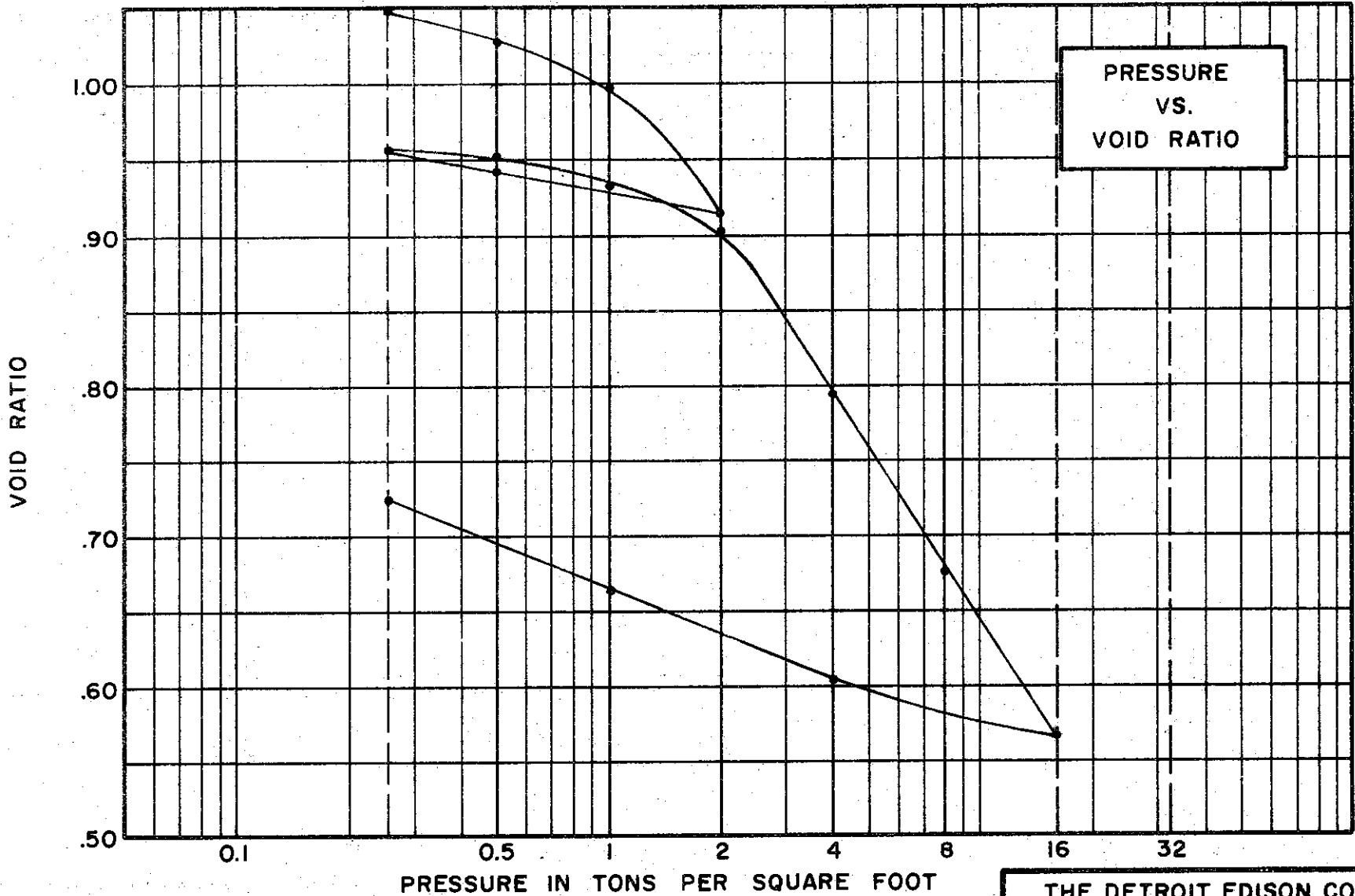

SOIL PROPERTIES

SOIL DESCRIPTION SILTY
CLAY (CL)
 SPECIFIC GRAVITY 2.73
 WATER CONTENT, INITIAL 40.2% FINAL 30.0%
 ATTERBERG LIMITS:
 LIQUID LIMIT 41% PLASTIC LIMIT 22%

TEST DATA

INITIAL SAMPLE HEIGHT 0.80"
 INITIAL SAMPLE DIAMETER 2.50"
 INITIAL VOID RATIO 1.075

THE DETROIT EDISON COMPANY
 BELLE RIVER PLANT UNITS I & II

CONSOLIDATION TEST
VOID RATIO VS. LOG PRESSURE

BORING NO. 129 TEST NO. C389.1
 SAMPLE NO. 9 DATE APRIL 74
 DEPTH 39.1' TO 39.3'

C-551

GOLDBERG-ZOINO & ASSOCIATES, INC.
 SOIL AND FOUNDATION ENGINEERS

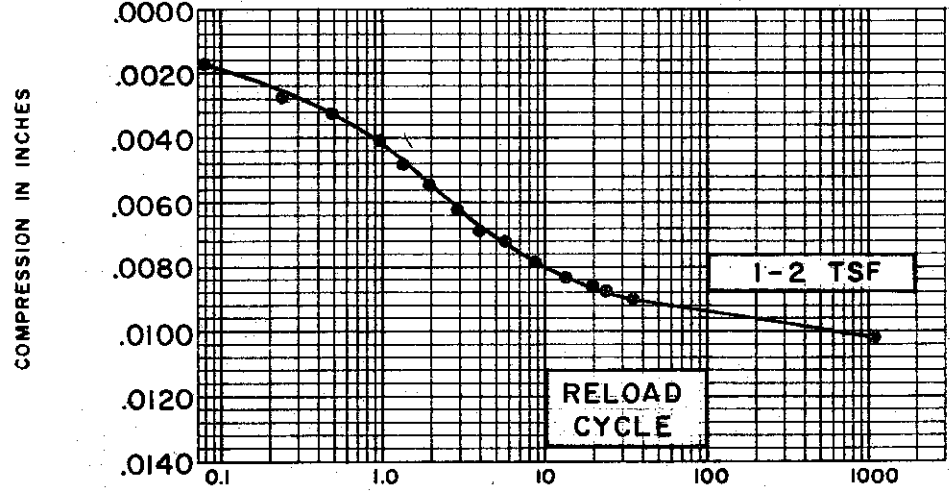
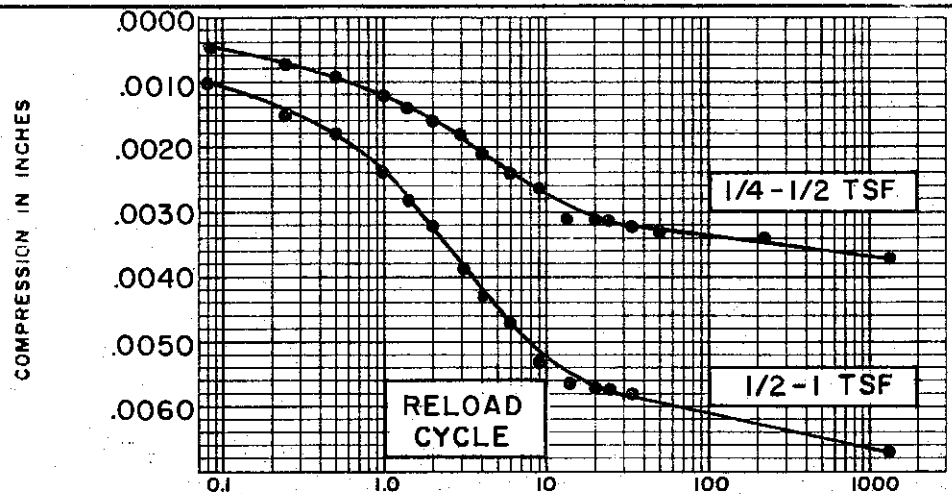
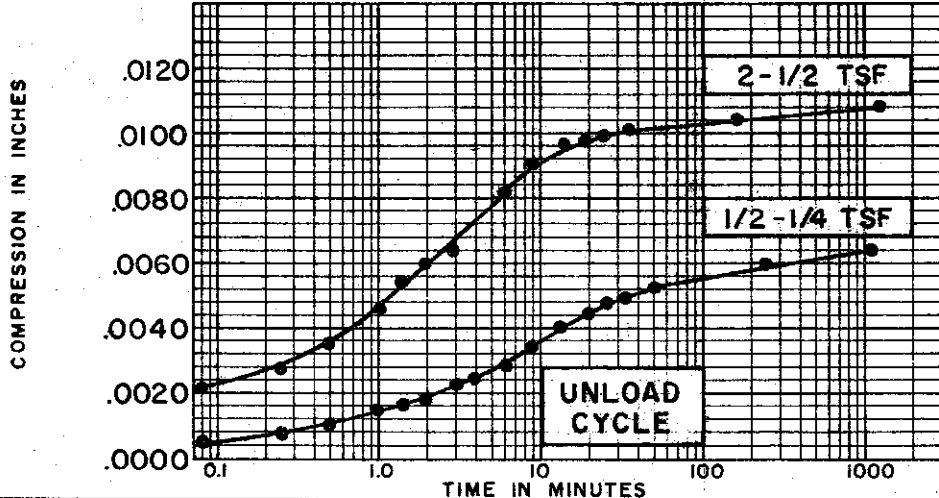
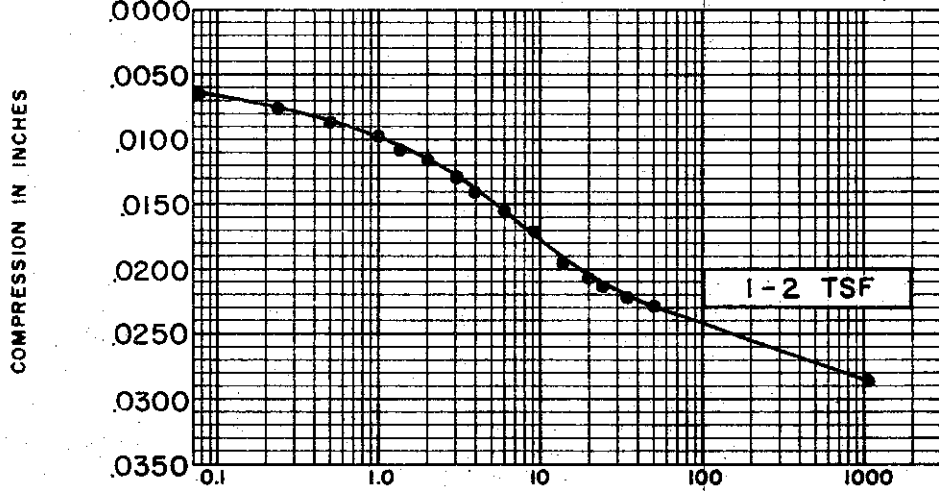
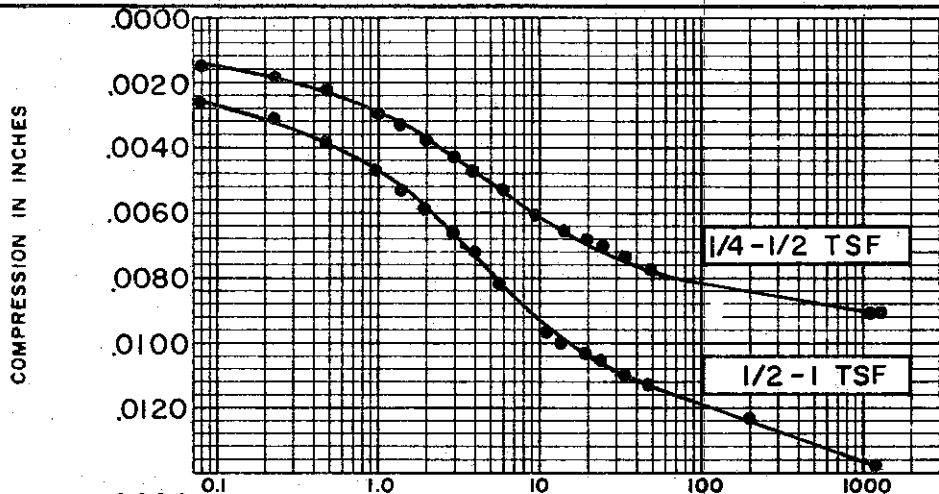

SOIL PROPERTIES		BORING NO. 129	
SOIL DESCRIPTION:	SILTY CLAY (CL)	SAMPLE NO.	9
SPECIFIC GRAVITY	2.73	DEPTH	39.1' TO 39.3'
INITIAL WATER CONTENT	40.2 %		
FINAL WATER CONTENT	30.0 %		
TEST DATA		CONSOLIDATION TEST	
INITIAL SAMPLE HEIGHT	0.80"	TIME VS. COMPRESSION CURVES	
INITIAL SAMPLE DIAMETER	2.50"	THE DETROIT EDISON COMPANY	
INITIAL VOID RATIO	1.075	BELLE RIVER PLANT UNITS I & II	

C-553

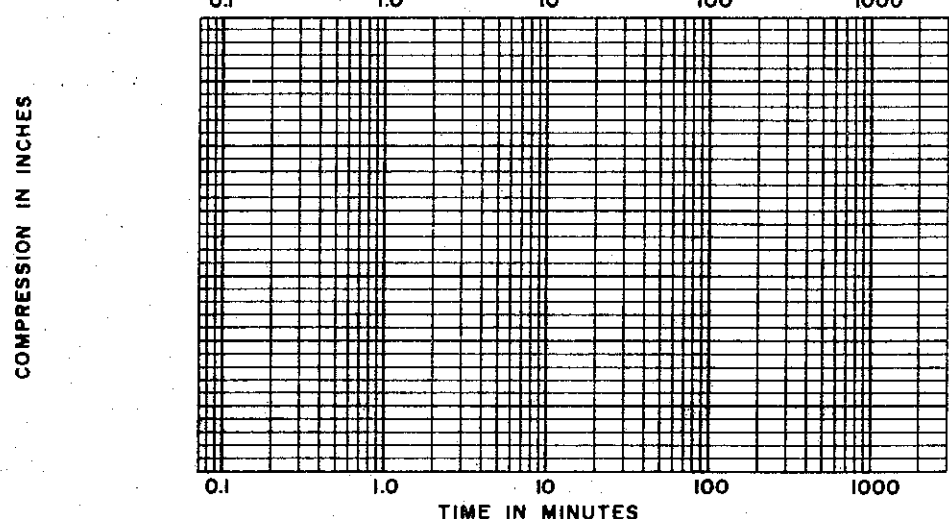
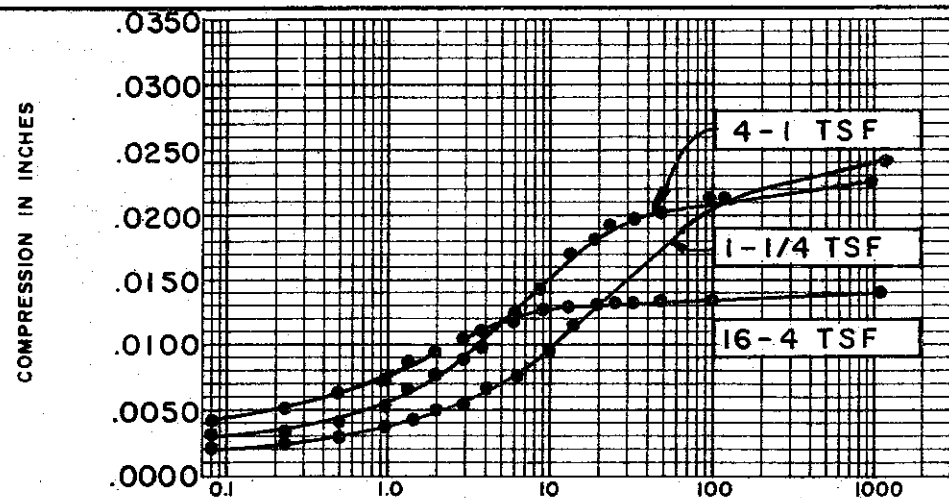
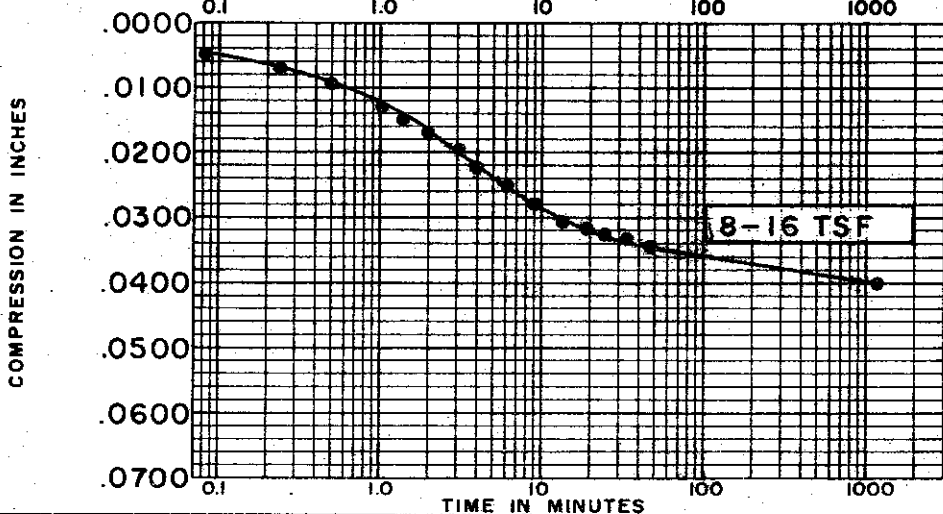
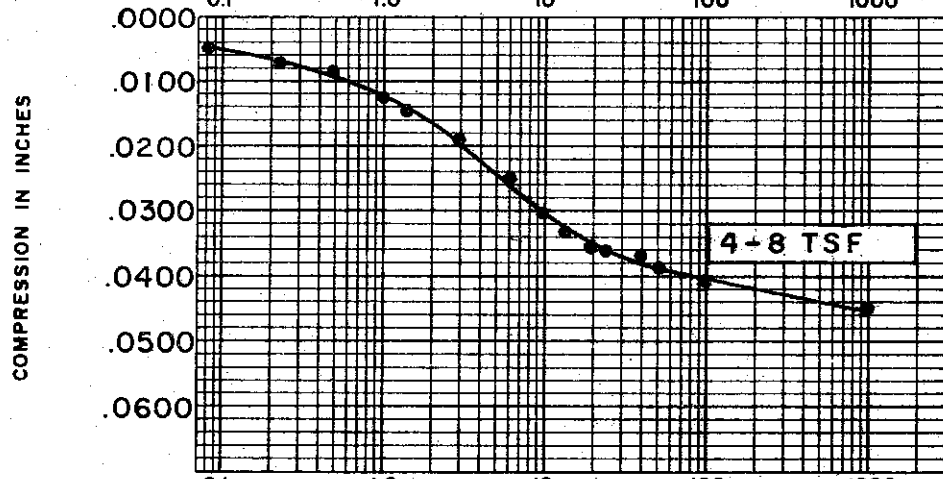
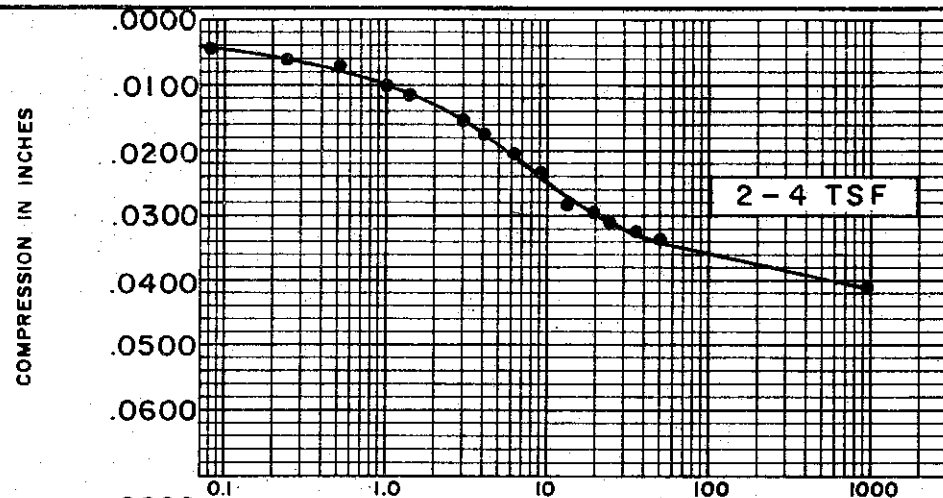

SOIL PROPERTIES

SOIL DESCRIPTION: SILTY CLAY (CL)
 SPECIFIC GRAVITY 2.73
 INITIAL WATER CONTENT 40.2 %
 FINAL WATER CONTENT 30.0 %

BORING NO. 129
 SAMPLE NO. 9
 DEPTH 39.1 TO 39.3'

TEST DATA

INITIAL SAMPLE HEIGHT 0.80"
 INITIAL SAMPLE DIAMETER 2.50"
 INITIAL VOID RATIO 1.075

**CONSOLIDATION TEST
 TIME VS. COMPRESSION CURVE**

THE DETROIT EDISON COMPANY
 BELLE RIVER PLANT UNITS I & II

C-554

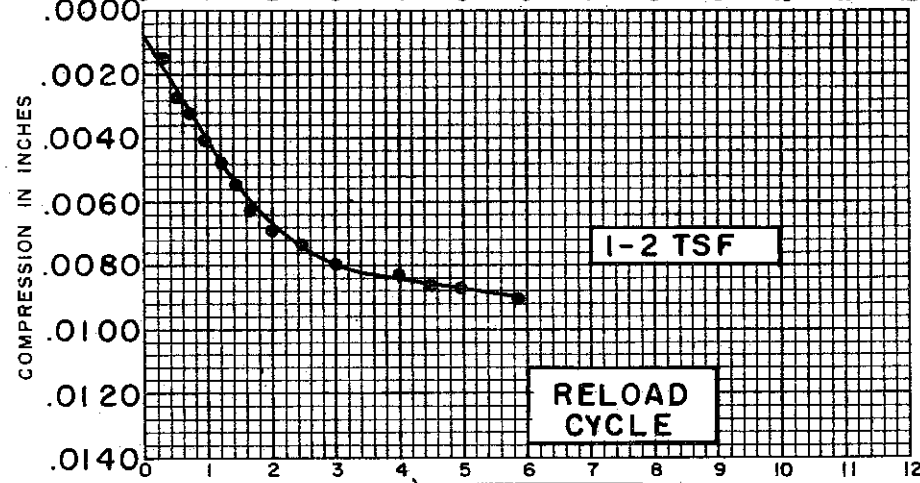
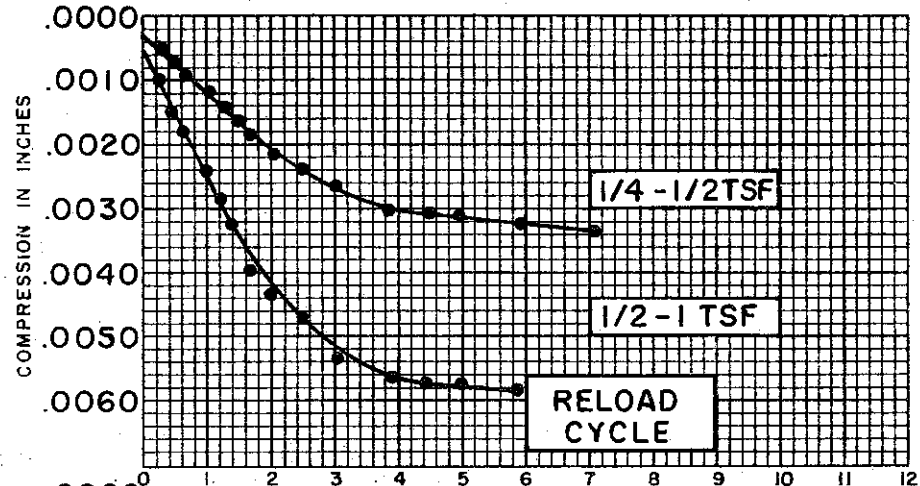
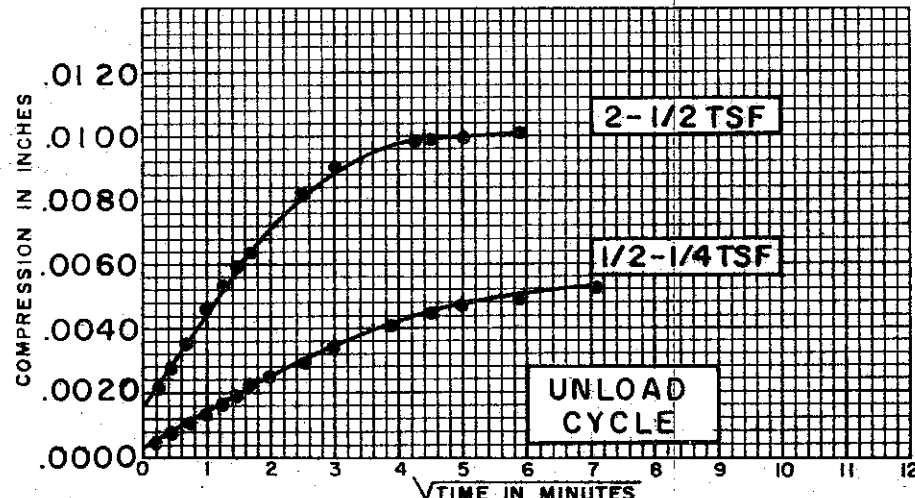
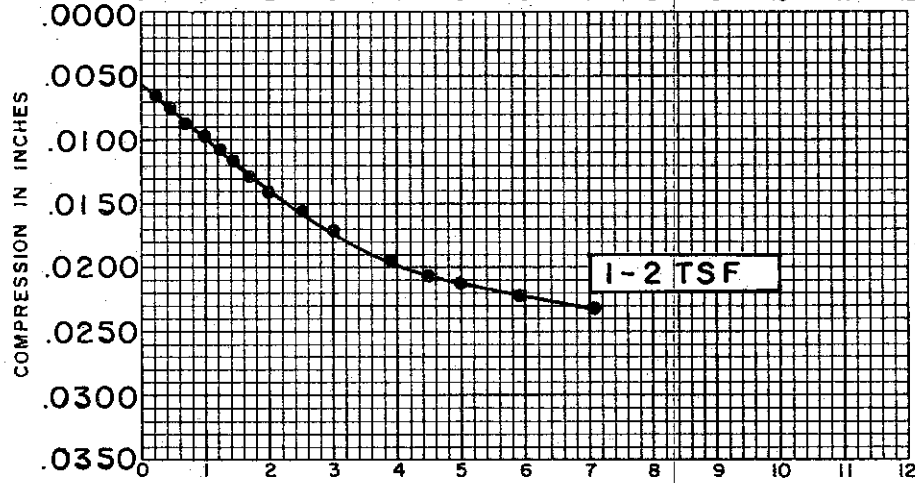
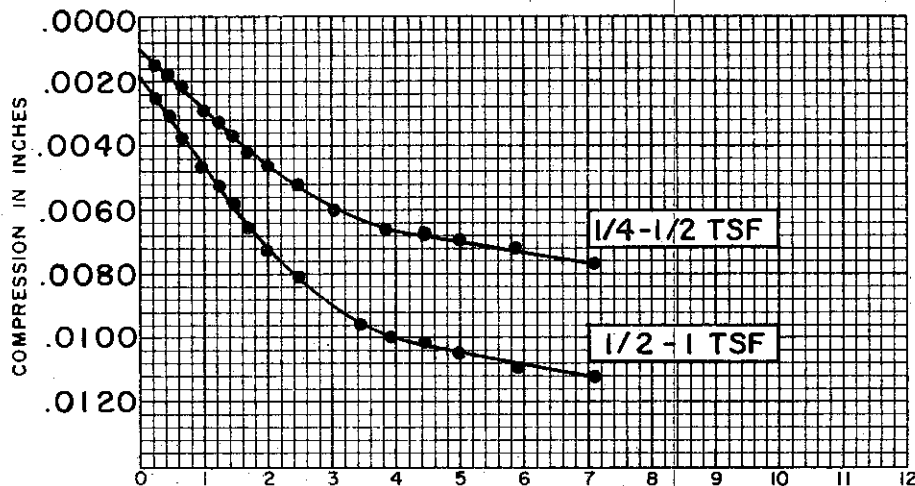

SOIL PROPERTIES		BORING NO. <u>129</u>	
SOIL DESCRIPTION: <u>SILTY CLAY (CL)</u>		SAMPLE NO. <u>9</u>	
SPECIFIC GRAVITY <u>2.73</u>		DEPTH <u>39.1' TO 39.3'</u>	
INITIAL WATER CONTENT <u>40.2 %</u>			
FINAL WATER CONTENT <u>30.0 %</u>			
TEST DATA		CONSOLIDATION TEST	
INITIAL SAMPLE HEIGHT <u>0.80"</u>		TIME VS. COMPRESSION CURVES	
INITIAL SAMPLE DIAMETER <u>2.50"</u>		THE DETROIT EDISON COMPANY	
INITIAL VOID RATIO <u>1.075</u>		BELLE RIVER PLANT UNITS I & II	

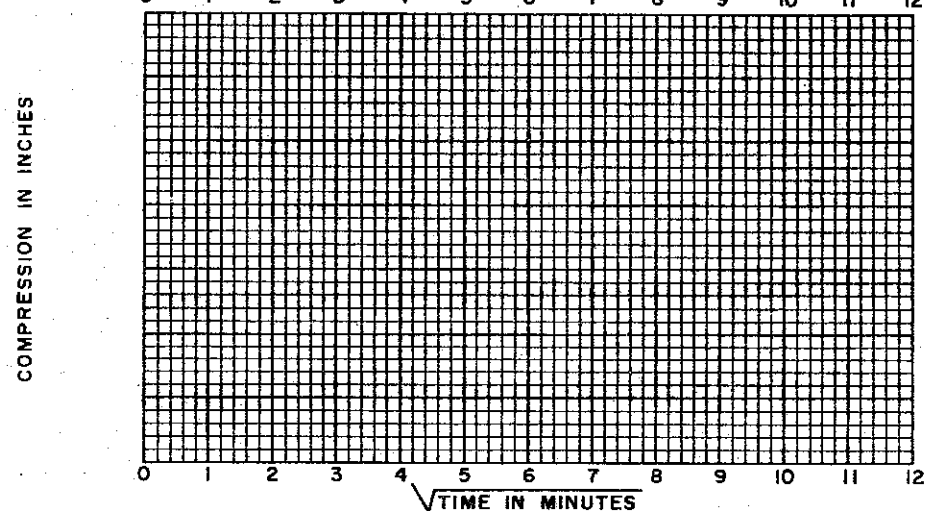
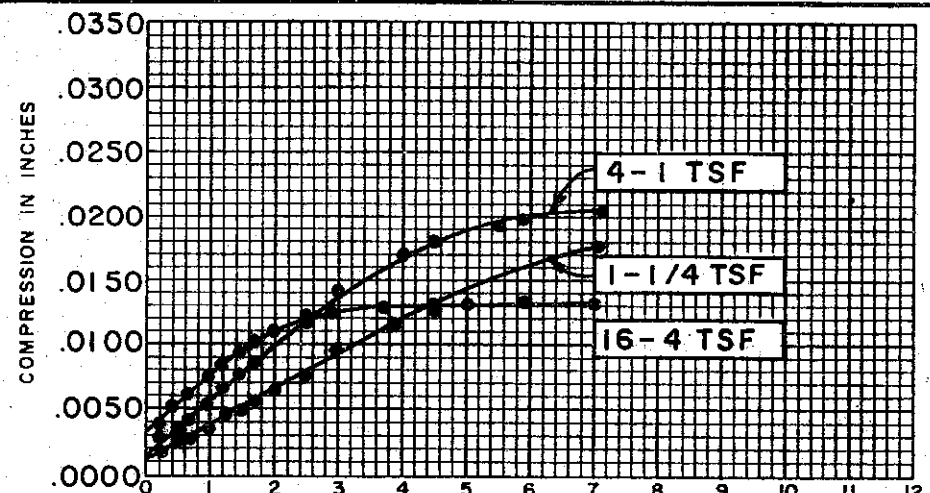
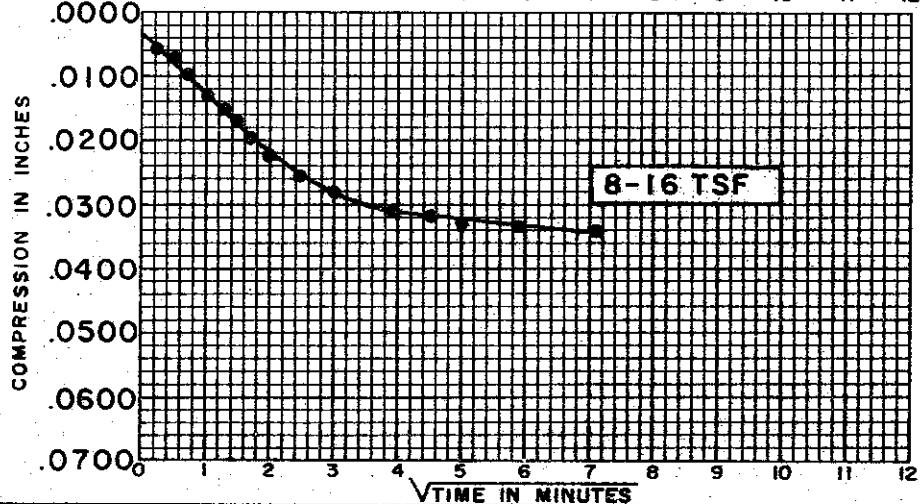
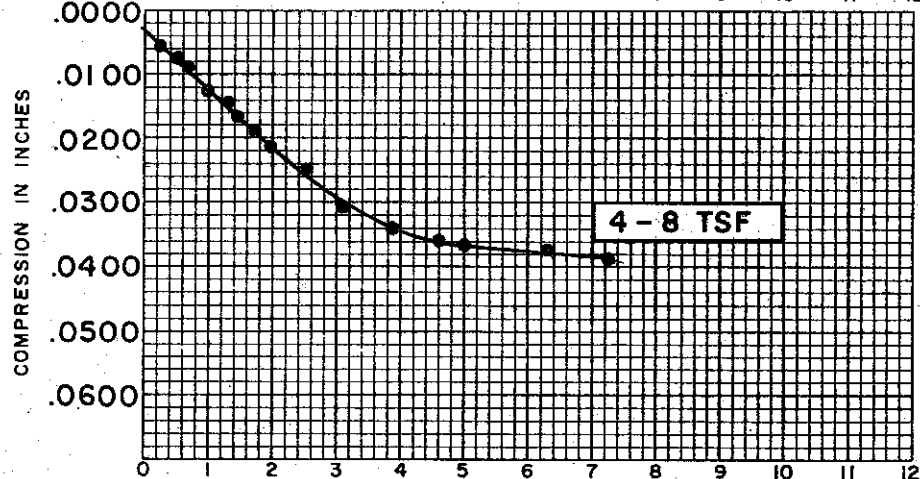
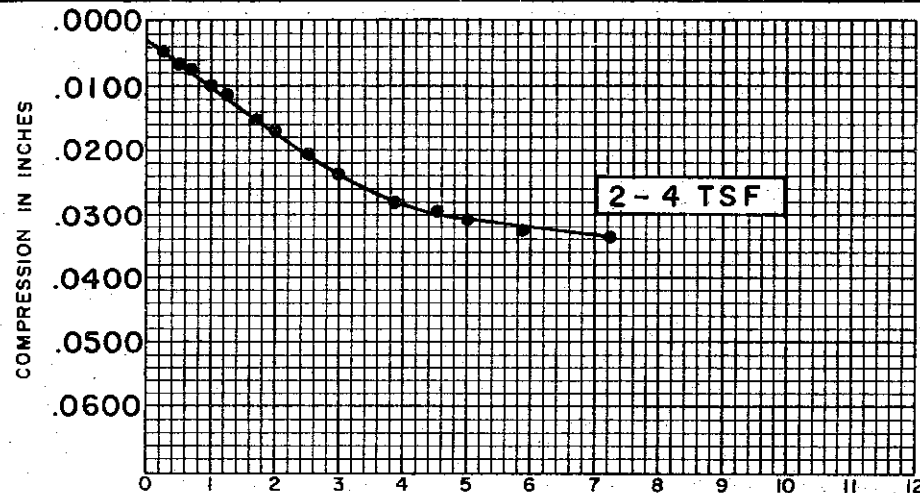

SOIL PROPERTIES	
SOIL DESCRIPTION:	SILTY CLAY (CL)
SPECIFIC GRAVITY	2.73
INITIAL WATER CONTENT	40.2 %
FINAL WATER CONTENT	30.0 %
BORING NO.	129
SAMPLE NO.	9
DEPTH	39.1' TO 39.3'
TEST DATA	
INITIAL SAMPLE HEIGHT	0.80"
INITIAL SAMPLE DIAMETER	2.50"
INITIAL VOID RATIO	1.075
CONSOLIDATION TEST	
TIME VS. COMPRESSION CURVES	
THE DETROIT EDISON COMPANY BELLE RIVER PLANT UNITS I & II	
FILE 1255	

C-555

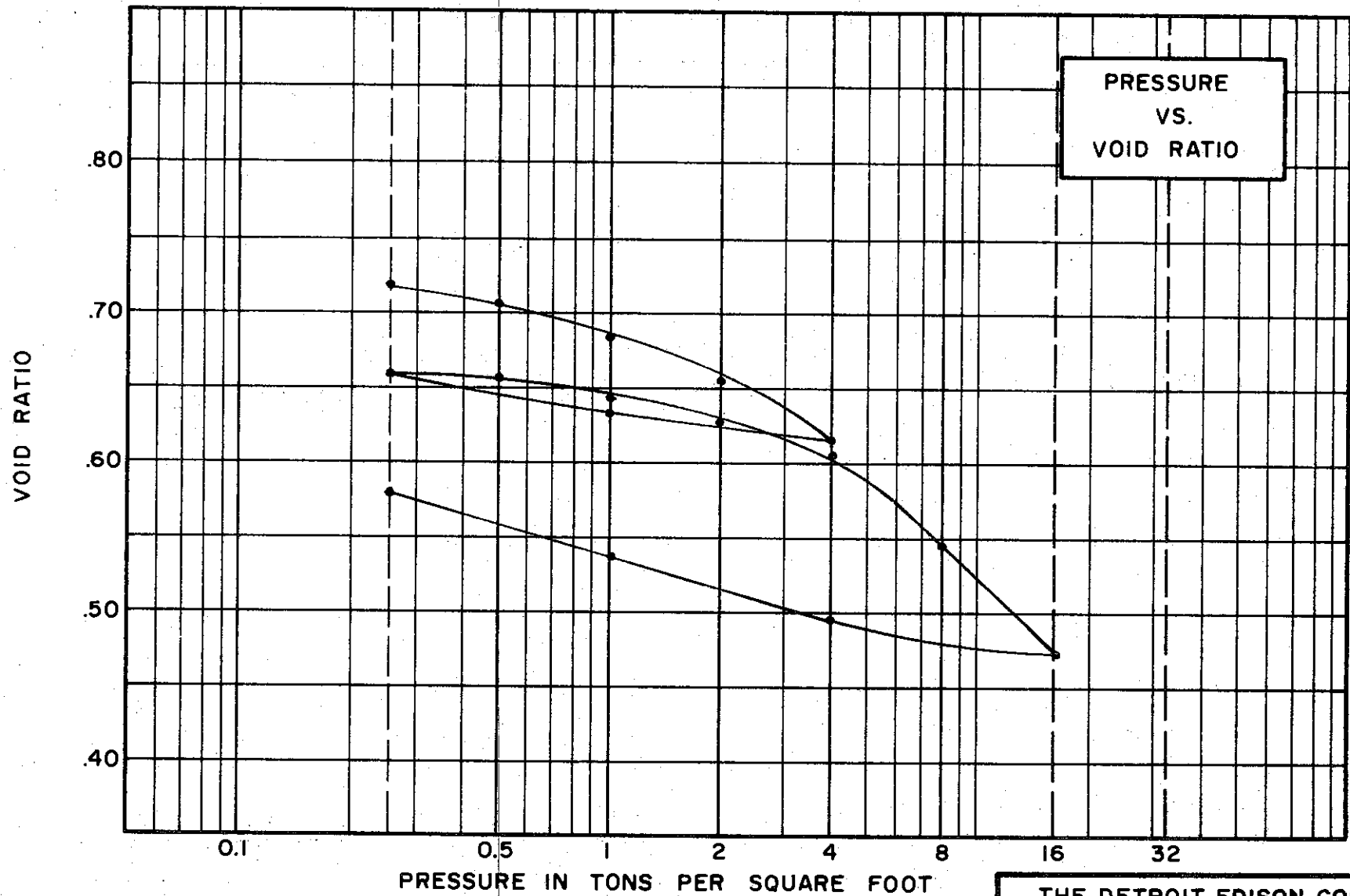

SOIL PROPERTIES

SOIL DESCRIPTION SILTY
CLAY; SANDY (CL)
 SPECIFIC GRAVITY 2.71
 WATER CONTENT, INITIAL 28.0% FINAL 24.5%
 ATTERBERG LIMITS:
 LIQUID LIMIT 39 % PLASTIC LIMIT 21 %

TEST DATA

INITIAL SAMPLE HEIGHT 0.80"
 INITIAL SAMPLE DIAMETER 2.50"
 INITIAL VOID RATIO 0.703

THE DETROIT EDISON COMPANY
 BELLE RIVER PLANT UNITS I & II

**CONSOLIDATION TEST
 VOID RATIO VS. LOG PRESSURE**

BORING NO. 129 TEST NO. C395.1
 SAMPLE NO. 21 DATE APRIL 74
 DEPTH 103.7' TO 104.0'

COMPRESSION IN INCHES

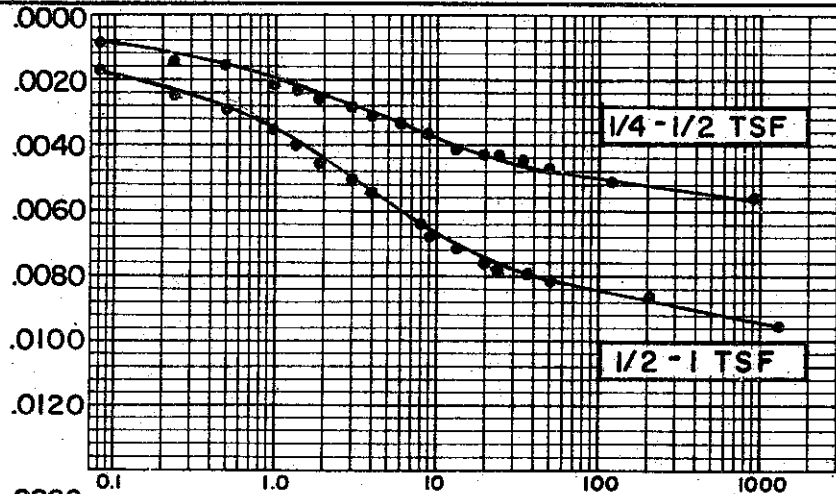

COMPRESSION IN INCHES

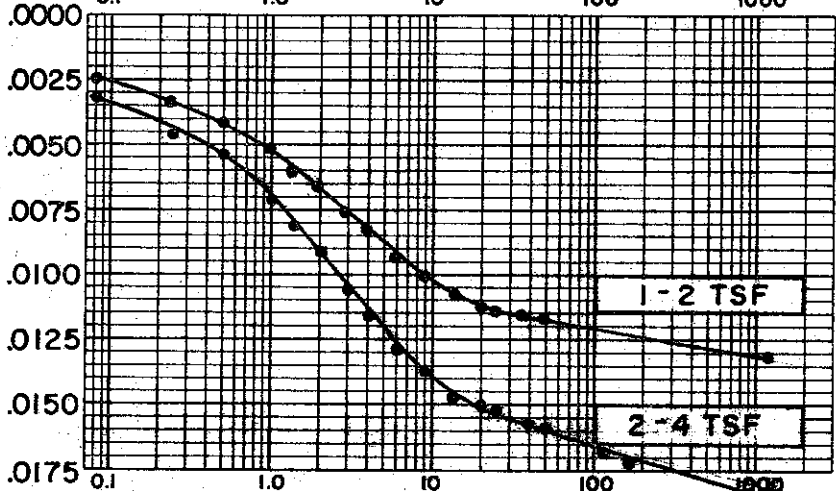

COMPRESSION IN INCHES

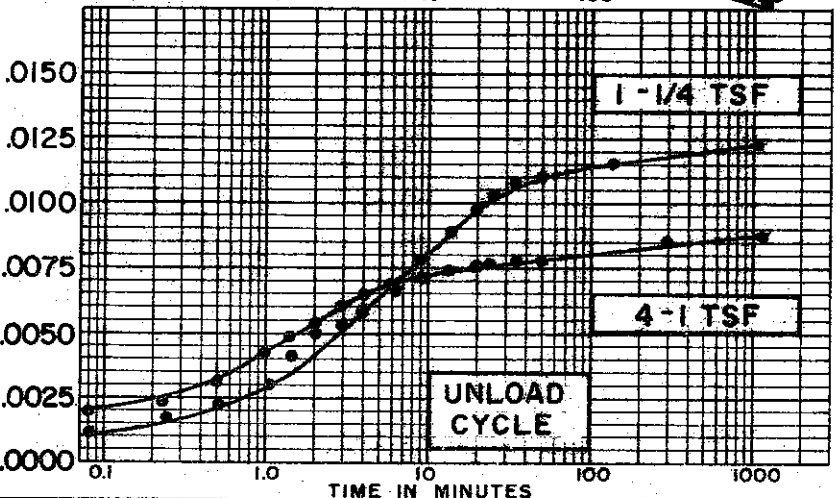

COMPRESSION IN INCHES

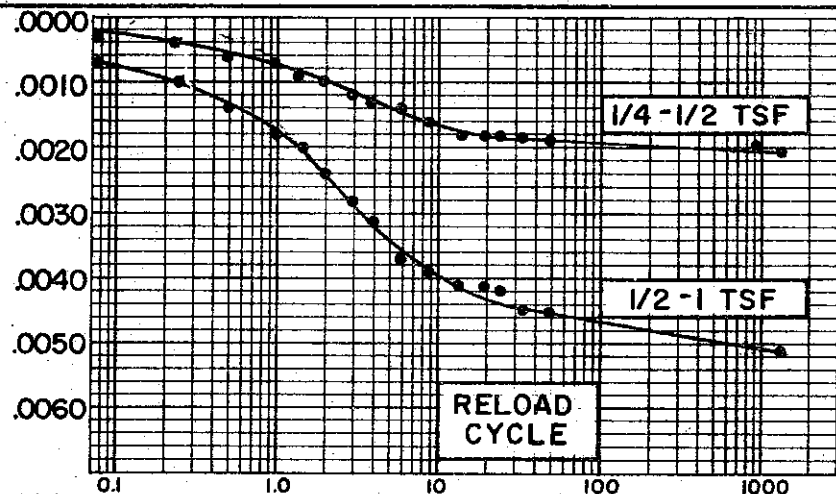

COMPRESSION IN INCHES

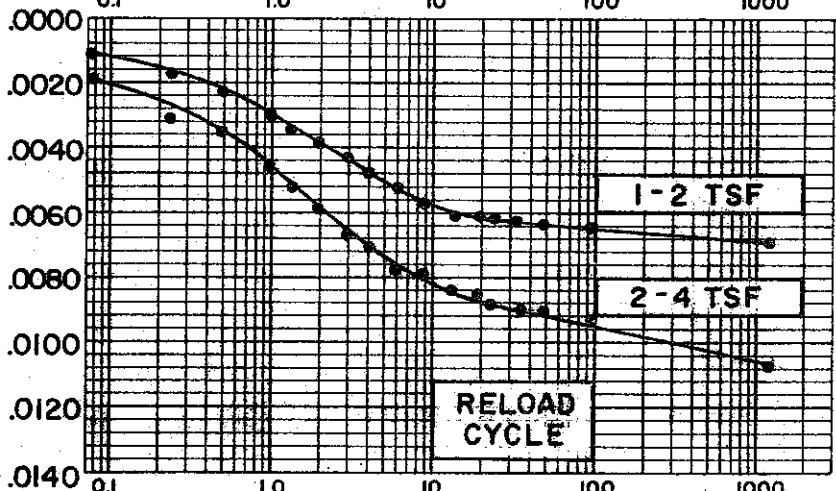

TIME IN MINUTES

SOIL PROPERTIES

SOIL DESCRIPTION: SILTY CLAY, SANDY (CL)
 SPECIFIC GRAVITY 2.71
 INITIAL WATER CONTENT 28.0 %
 FINAL WATER CONTENT 24.5 %

BORING NO. 129
 SAMPLE NO. 21
 DEPTH 103.7' TO 104.0'

TEST DATA

INITIAL SAMPLE HEIGHT 0.80"
 INITIAL SAMPLE DIAMETER 2.50"
 INITIAL VOID RATIO 0.730

**CONSOLIDATION TEST
 TIME VS. COMPRESSION CURVE.**

THE DETROIT EDISON COMPANY
 BELLE RIVER PLANT UNITS I & II

C-557

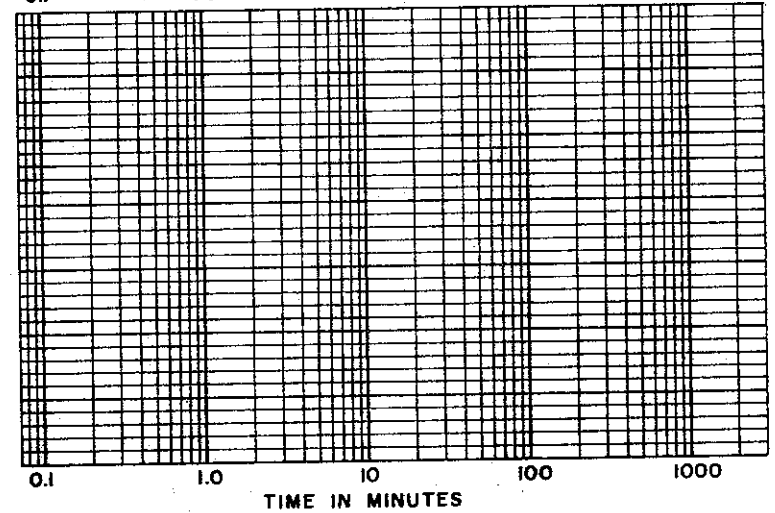
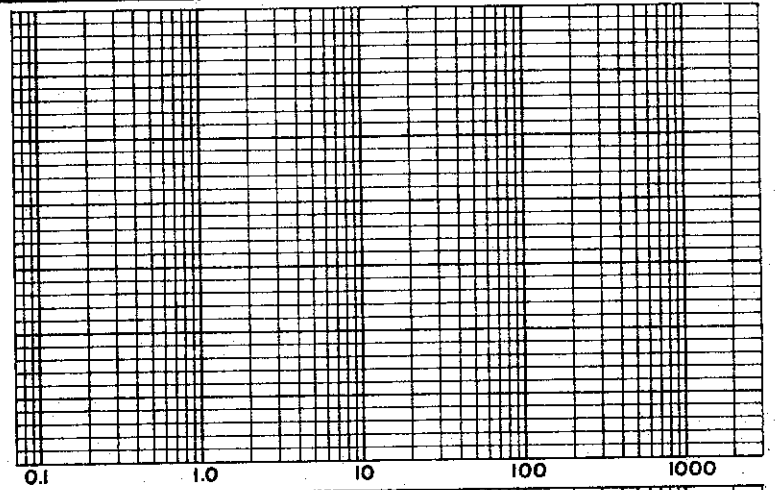
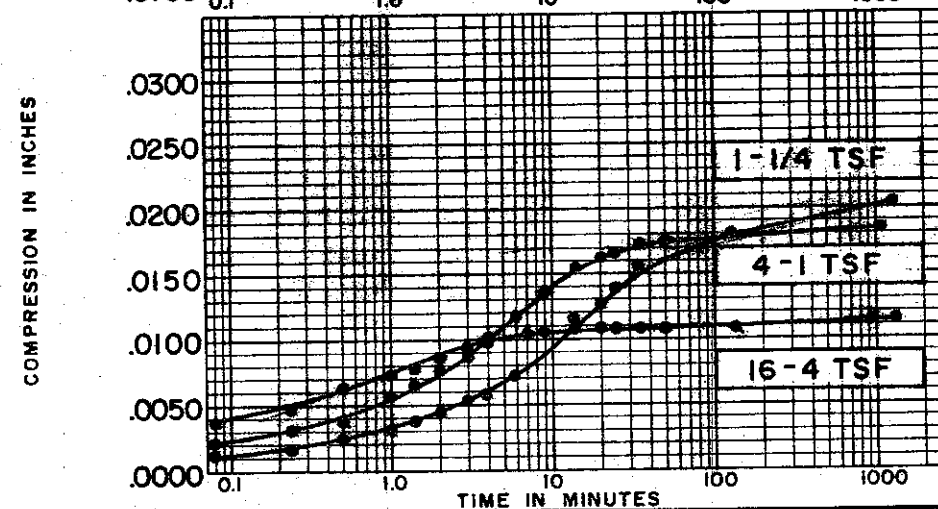
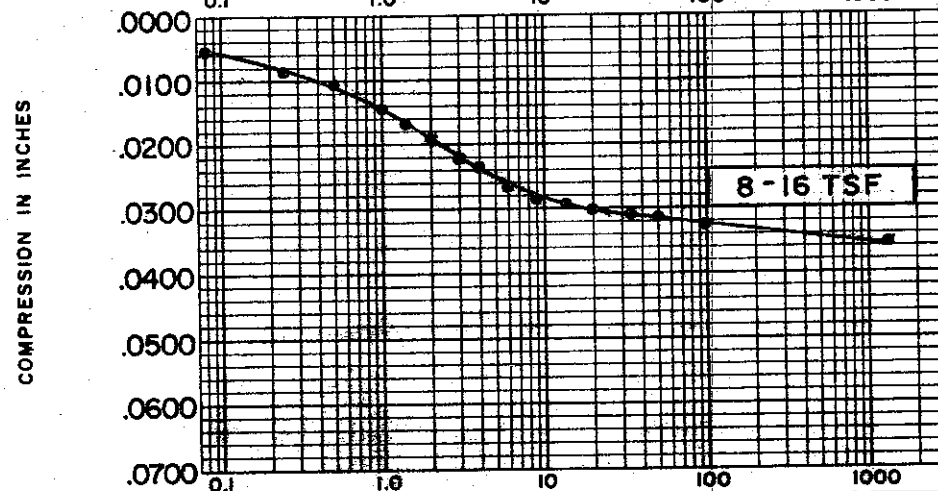
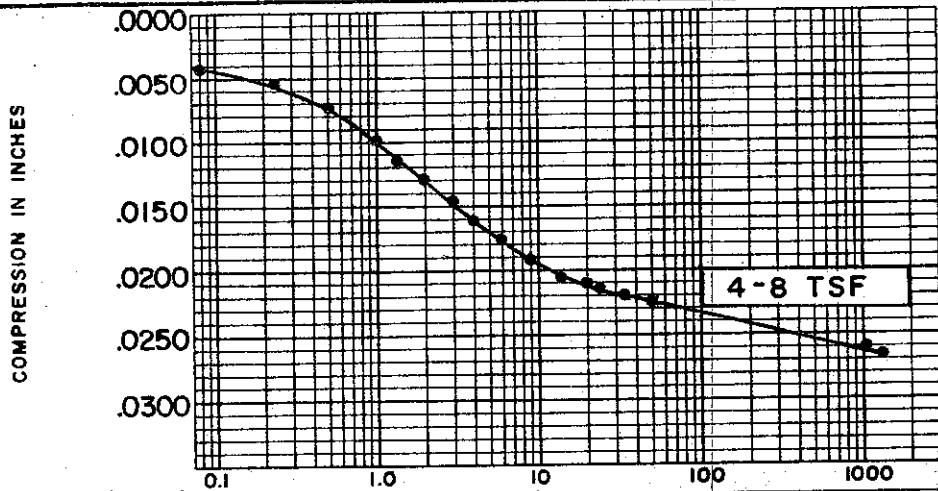

SOIL PROPERTIES

SOIL DESCRIPTION: SILTY
CLAY, SANDY (CL)
SPECIFIC GRAVITY 2.71
INITIAL WATER CONTENT 28.0 %
FINAL WATER CONTENT 24.5 %

BORING NO. 129
SAMPLE NO. 21
DEPTH 103.7' TO 104.0'

TEST DATA

INITIAL SAMPLE HEIGHT 0.80"
INITIAL SAMPLE DIAMETER 2.50"
INITIAL VOID RATIO 0.730

**CONSOLIDATION TEST
TIME VS. COMPRESSION CURVES**

THE DETROIT EDISON COMPANY
BELLE RIVER PLANT UNITS I & II

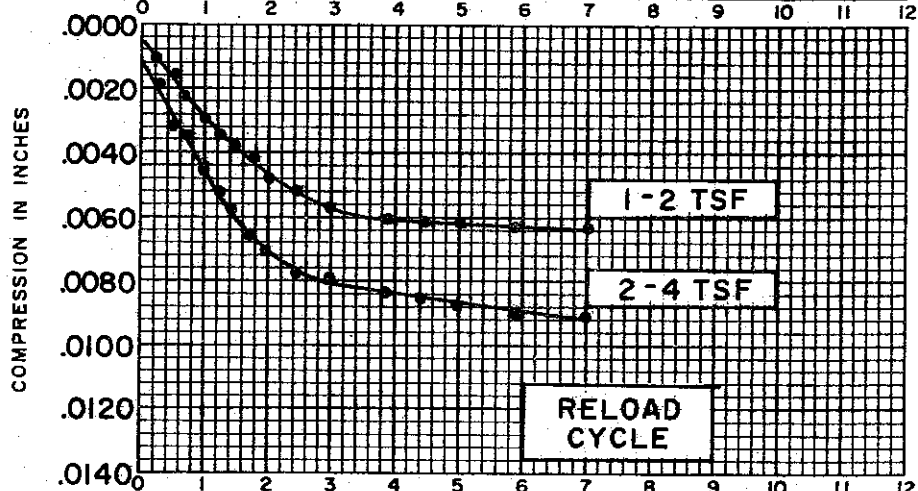
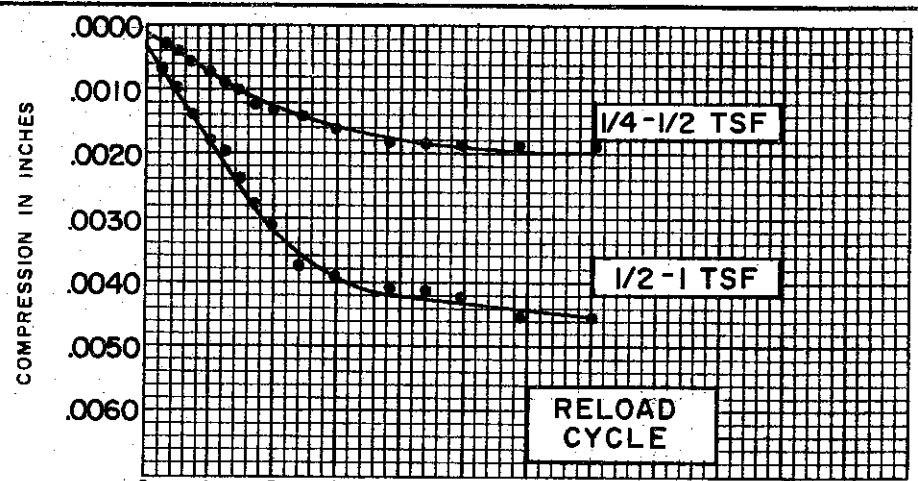
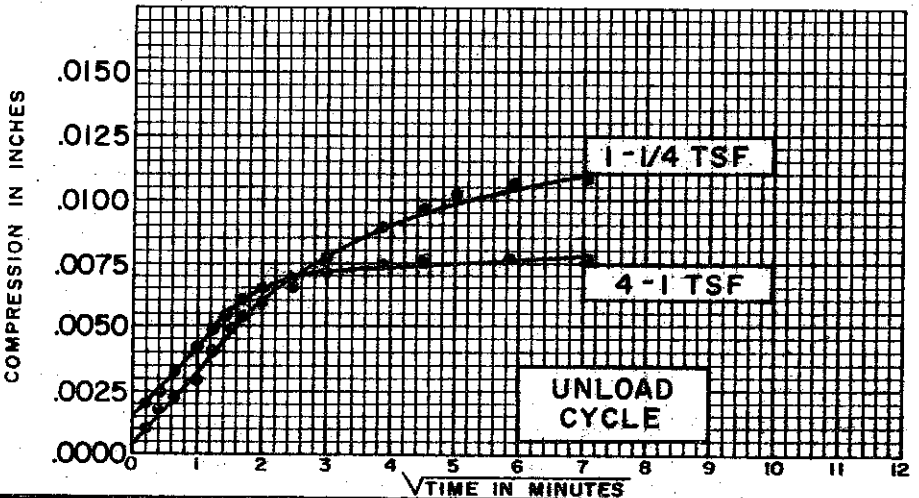
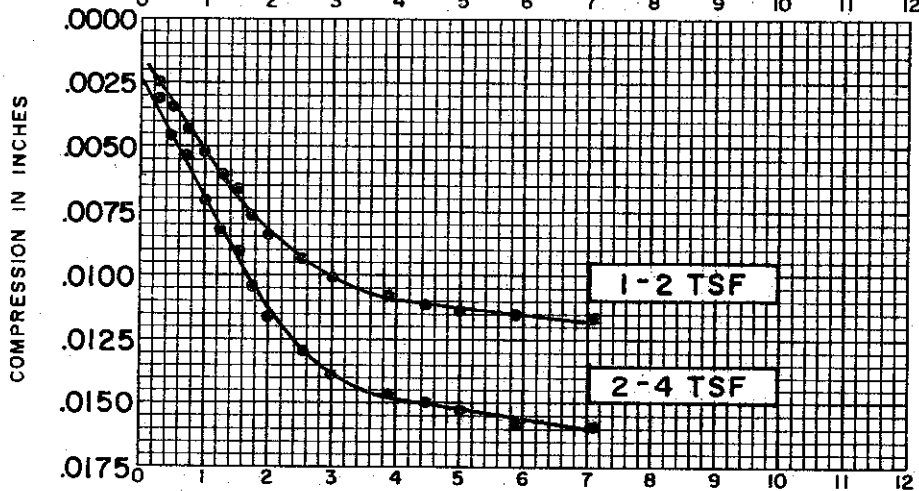
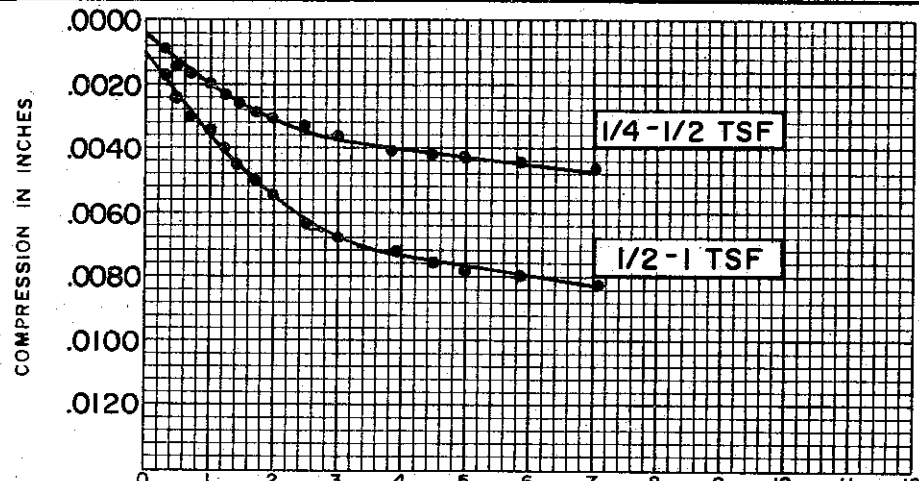

SOIL PROPERTIES	
SOIL DESCRIPTION:	SILTY CLAY, SANDY (CL)
SPECIFIC GRAVITY	2.71
INITIAL WATER CONTENT	28.0 %
FINAL WATER CONTENT	24.5 %
BORING NO.	129
SAMPLE NO.	21
DEPTH	103.7' TO 104.0'

TEST DATA	
INITIAL SAMPLE HEIGHT	0.80"
INITIAL SAMPLE DIAMETER	2.50"
INITIAL VOID RATIO	0.730

CONSOLIDATION TEST
TIME VS. COMPRESSION CURVES
 THE DETROIT EDISON COMPANY
 BELLE RIVER PLANT UNITS I & II

C-559

C-560

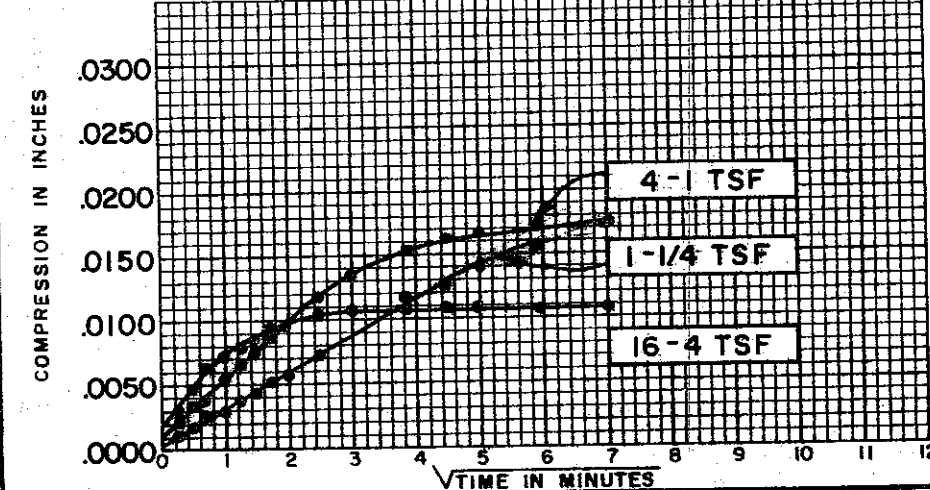
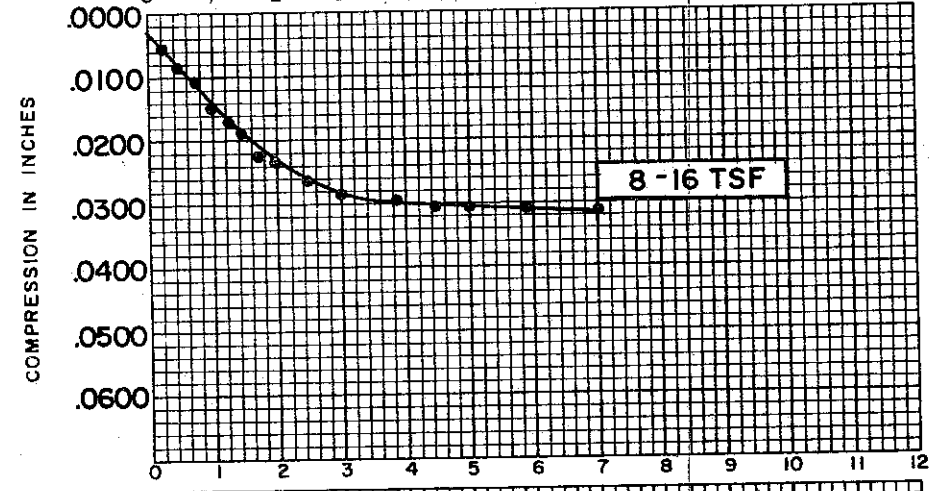
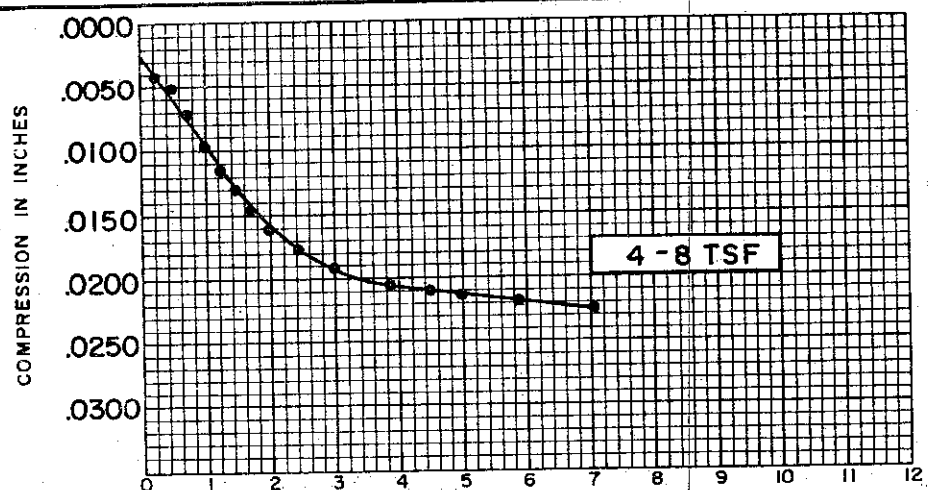

COMPRESSION IN INCHES

COMPRESSION IN INCHES

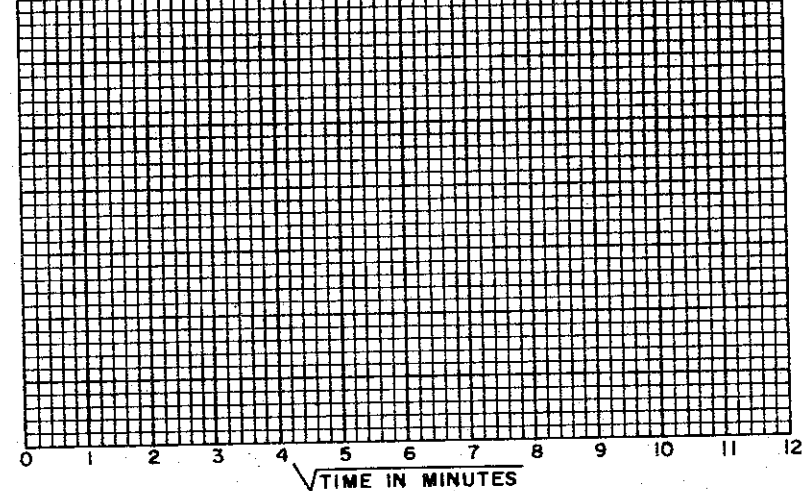
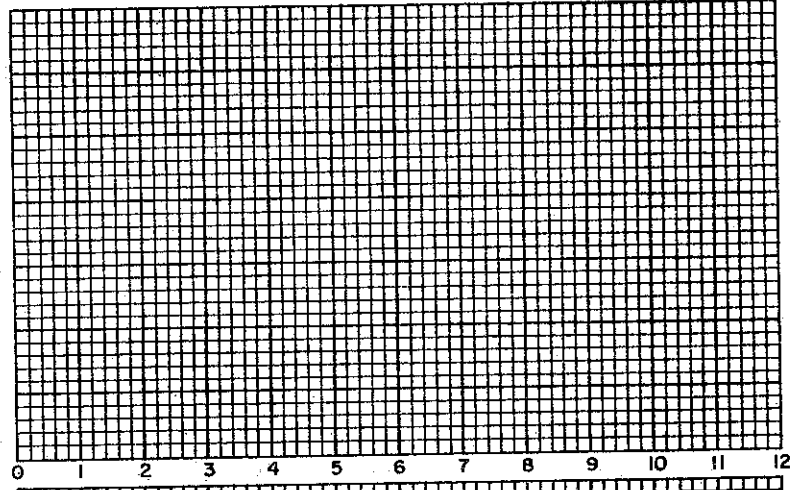

SOIL PROPERTIES

SOIL DESCRIPTION: SILTY CLAY, SANDY (CL)
 SPECIFIC GRAVITY 2.71
 INITIAL WATER CONTENT 28.0 %
 FINAL WATER CONTENT 24.5 %

BORING NO. 129
 SAMPLE NO. 21
 DEPTH 103.7' TO 104.0'

TEST DATA

INITIAL SAMPLE HEIGHT 0.80"
 INITIAL SAMPLE DIAMETER 2.50"
 INITIAL VOID RATIO 0.730

**CONSOLIDATION TEST
 TIME VS. COMPRESSION CURVES**

THE DETROIT EDISON COMPANY
 BELLE RIVER PLANT UNITS I & II

FILE 1255

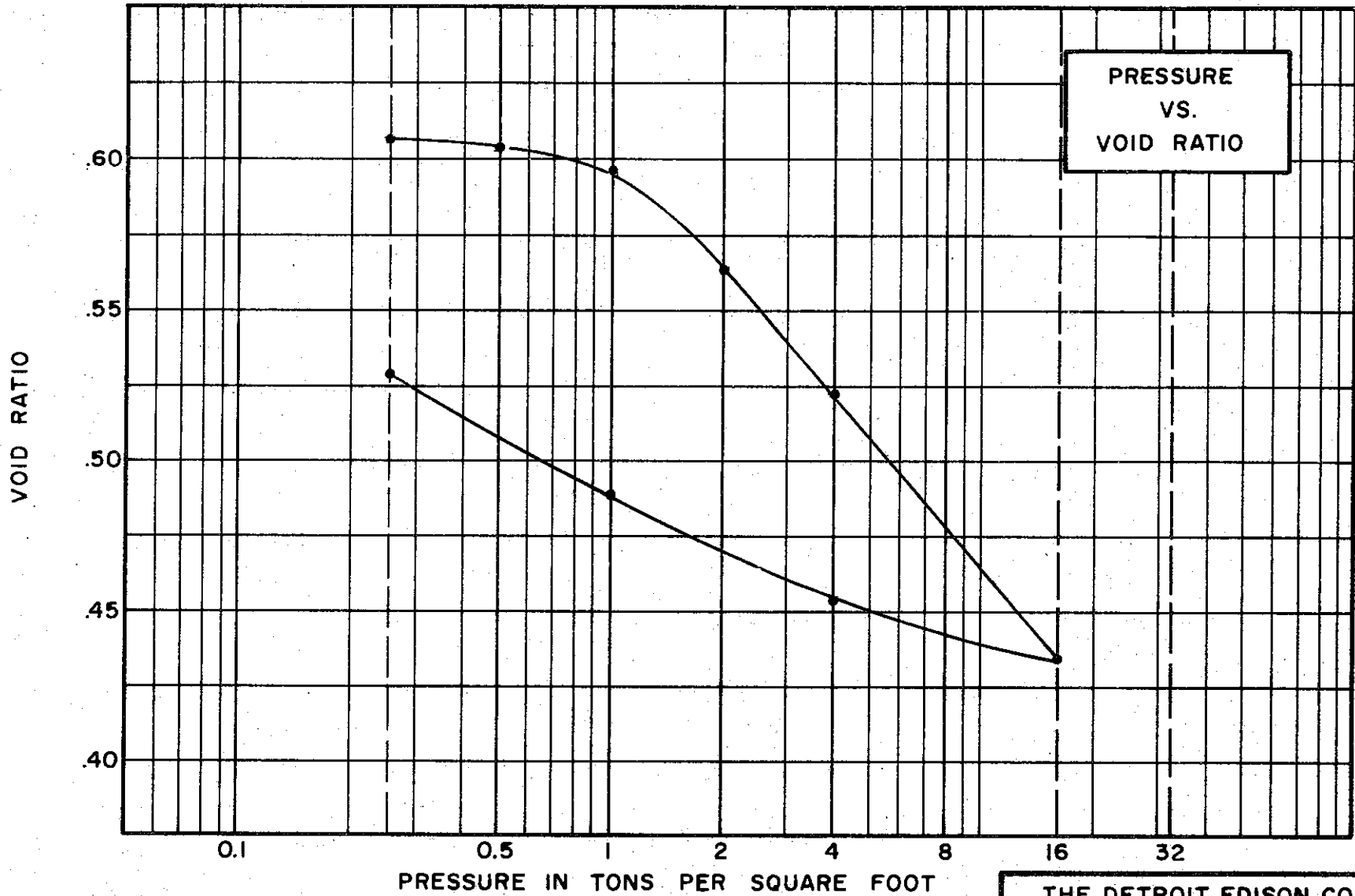

SOIL PROPERTIES

SOIL DESCRIPTION SILTY CLAY (CL)
 SPECIFIC GRAVITY 2.74
 WATER CONTENT, INITIAL 17.3% FINAL 21.3%
 ATTERBERG LIMITS:
 LIQUID LIMIT 43 % PLASTIC LIMIT 22 %

TEST DATA

INITIAL SAMPLE HEIGHT 0.750"
 INITIAL SAMPLE DIAMETER 2.500"
 INITIAL HEIGHT OF SOIL SOLIDS 0.448"
 INITIAL VOID RATIO (0.675) AS COMPACTED

THE DETROIT EDISON COMPANY
 BELLE RIVER PLANT UNITS I & II

**CONSOLIDATION TEST
 VOID RATIO VS. LOG PRESSURE**

BORING NO. 136 TEST NO. C527.1
 SAMPLE NO. ST6 DATE DEC. 1974
 DEPTH 13.0' TO 14.6'

C-561

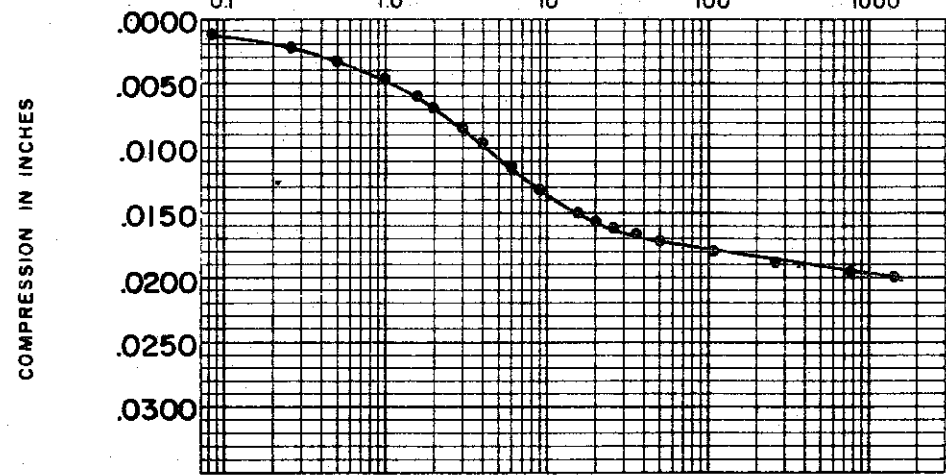
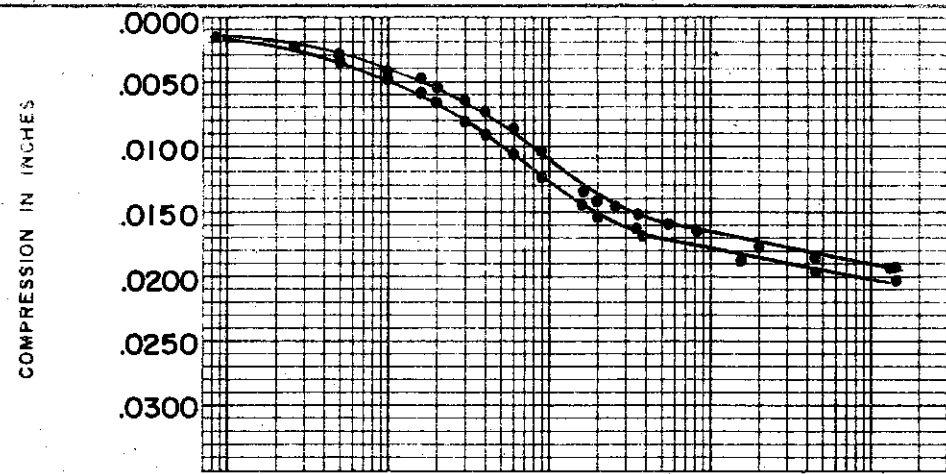
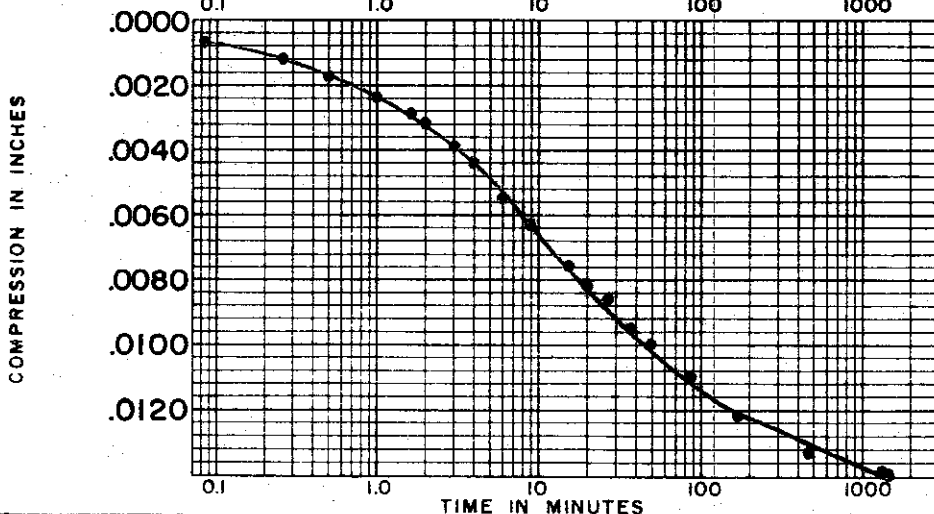
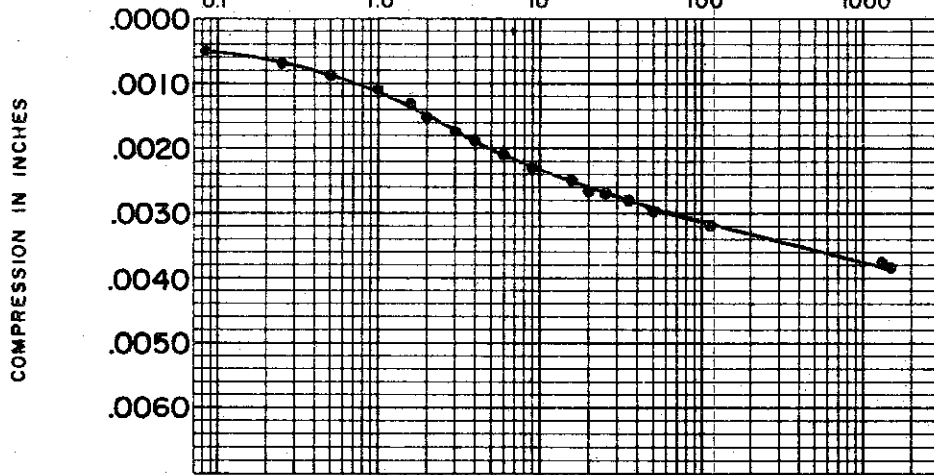
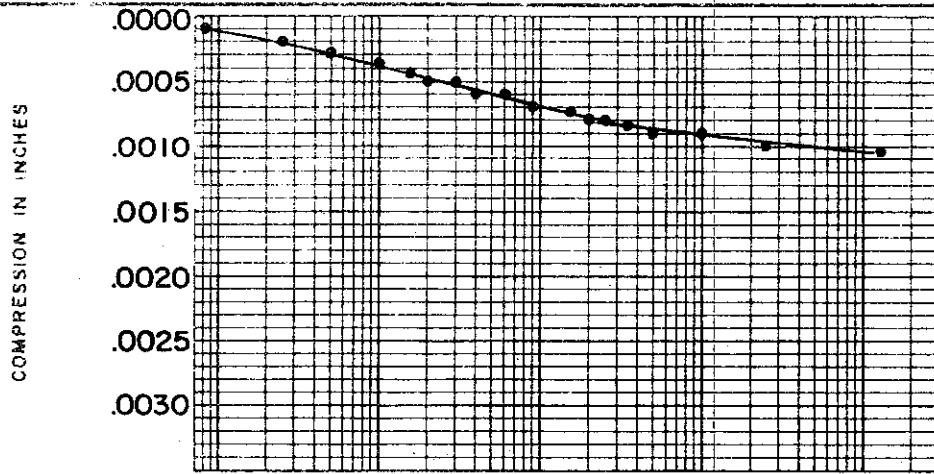

SOIL PROPERTIES		BORING NO. <u>136</u>
SOIL DESCRIPTION:	<u>SILTY CLAY (CL)</u>	SAMPLE NO. <u>ST 6</u>
SPECIFIC GRAVITY	<u>2.74</u>	DEPTH <u>13.0' TO 14.6'</u>
INITIAL WATER CONTENT	<u>(17.3) %</u>	
FINAL WATER CONTENT	<u>21.3 %</u>	

TEST DATA	
INITIAL SAMPLE HEIGHT	<u>0.75"</u>
INITIAL SAMPLE DIAMETER	<u>2.50"</u>
INITIAL VOID RATIO	<u>(0.675)</u>

CONSOLIDATION TEST
 TIME VS. COMPRESSION CURVES
 THE DETROIT EDISON COMPANY
 BELLE RIVER PLANT UNITS I & II

C-563

COMPRESSION IN INCHES

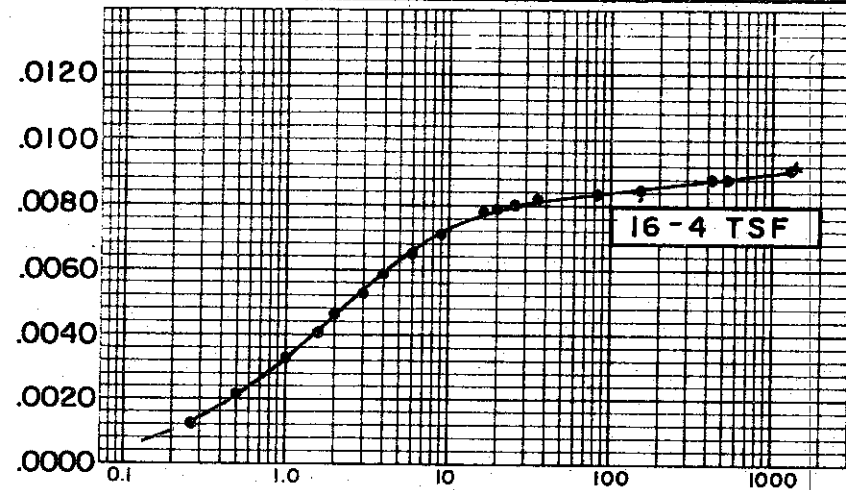

COMPRESSION IN INCHES

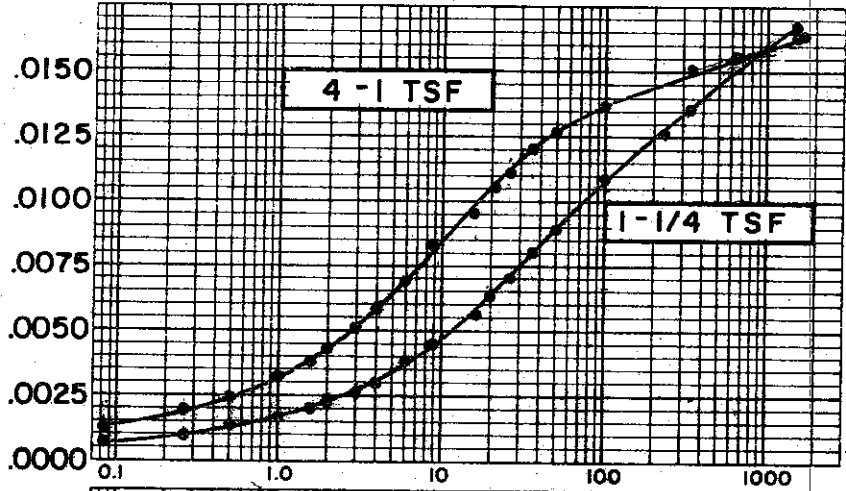

COMPRESSION IN INCHES

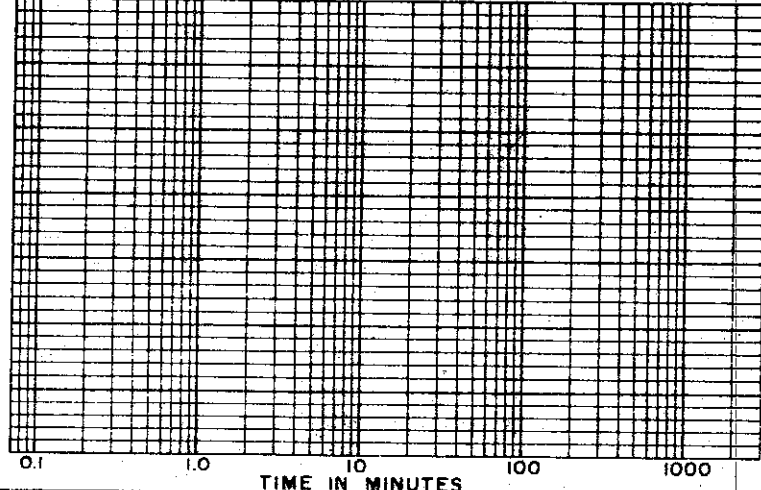

COMPRESSION IN INCHES

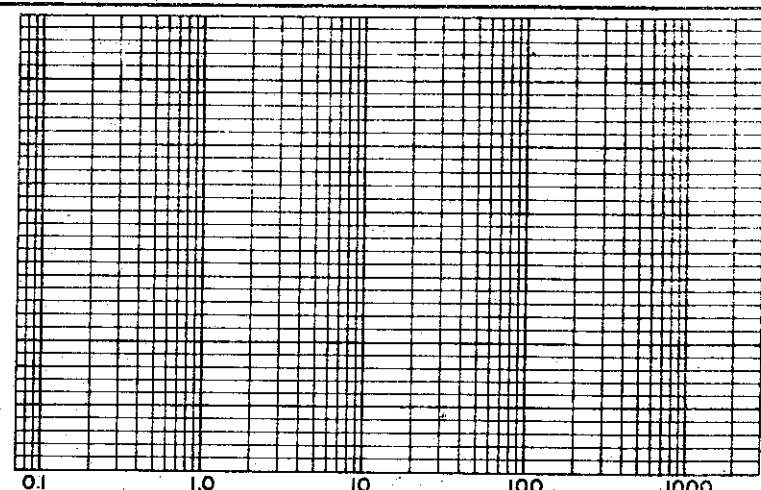

COMPRESSION IN INCHES

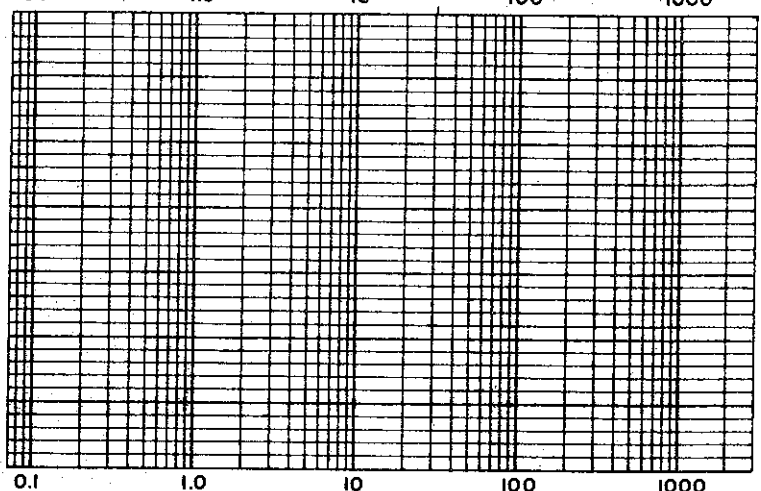

TIME IN MINUTES

SOIL PROPERTIES

SOIL DESCRIPTION: SILTY
CLAY (CL)
 SPECIFIC GRAVITY 2.74
 INITIAL WATER CONTENT (17.3) %
 FINAL WATER CONTENT 21.3 %

BORING NO. 136
 SAMPLE NO. ST 6
 DEPTH 13.0' TO 14.6'

TEST DATA

INITIAL SAMPLE HEIGHT 0.75"
 INITIAL SAMPLE DIAMETER 2.50"
 INITIAL VOID RATIO (0.675)

**CONSOLIDATION TEST
TIME VS. COMPRESSION CURVES**

THE DETROIT EDISON COMPANY
 BELLE RIVER PLANT UNITS I & II

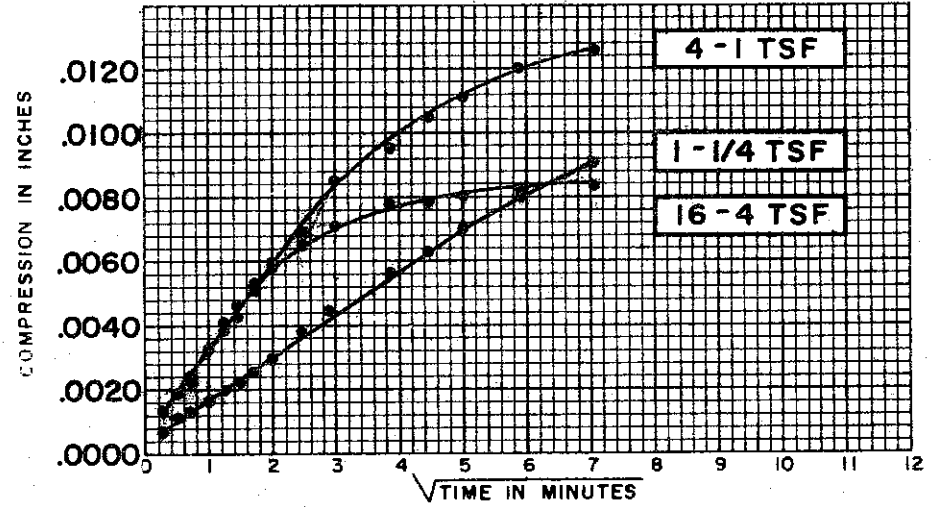
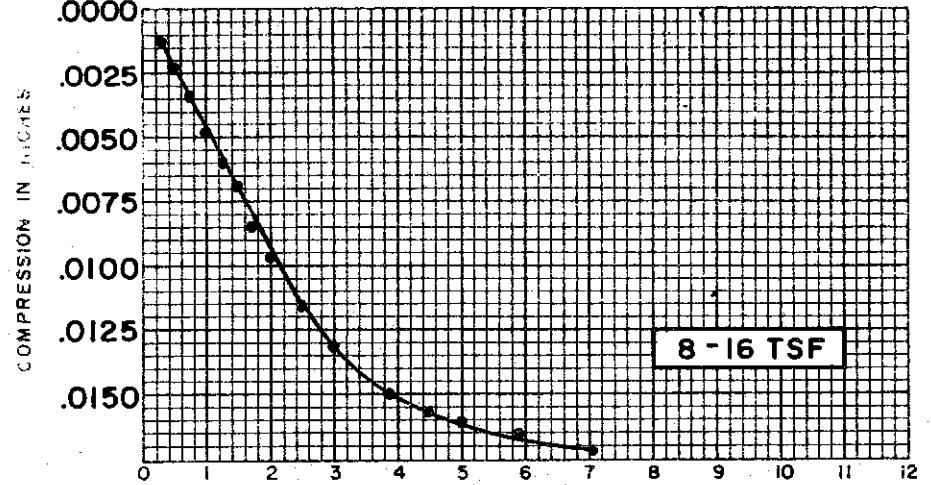
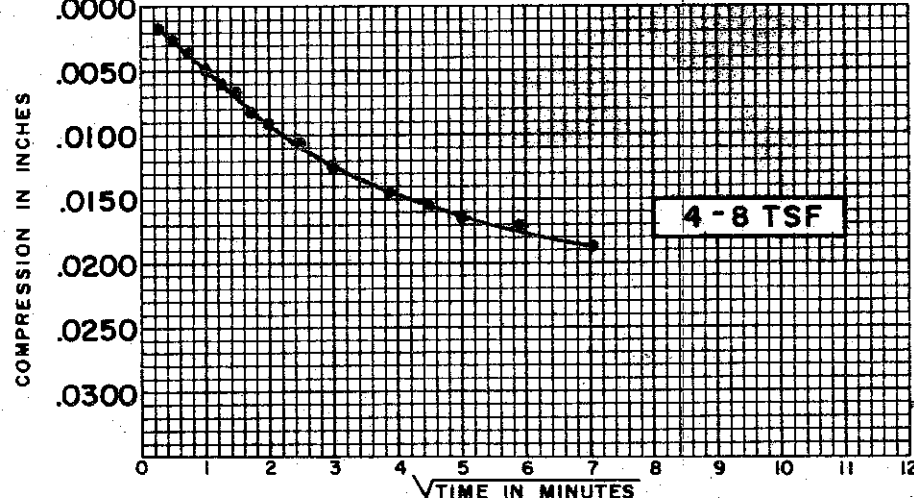
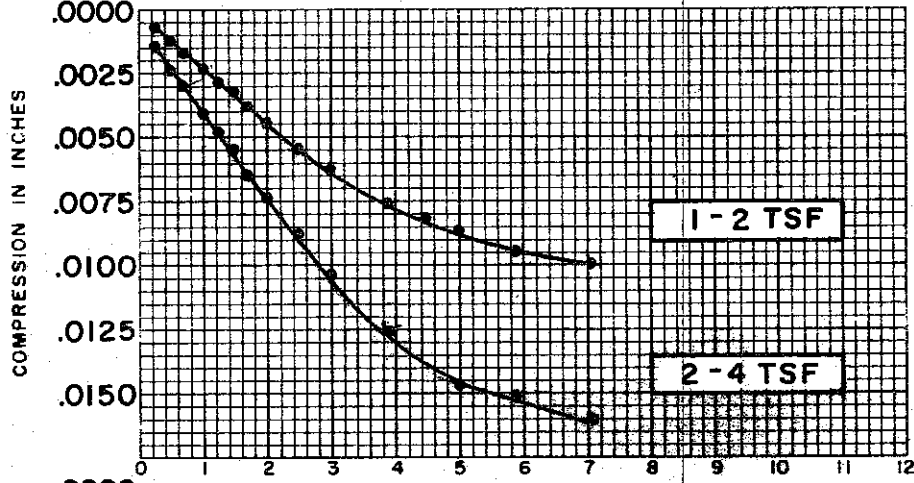
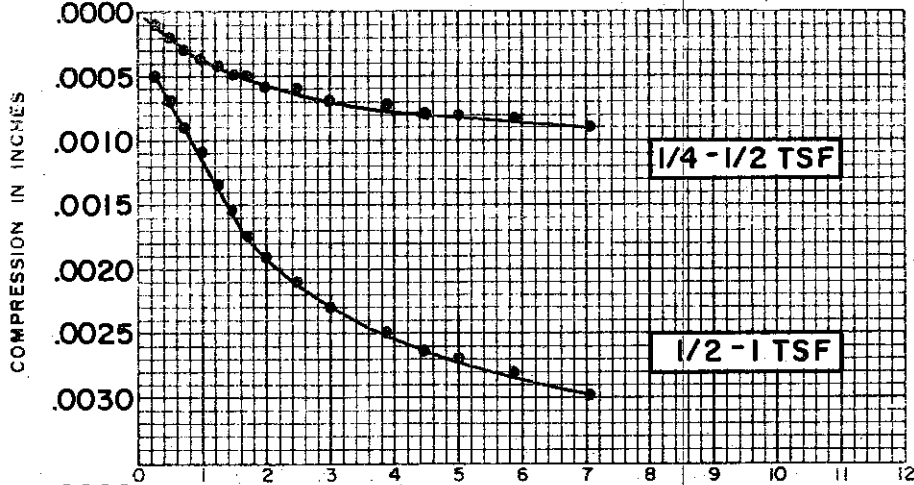

SOIL PROPERTIES

SOIL DESCRIPTION: SILTY
CLAY (CL)
 SPECIFIC GRAVITY 2.74
 INITIAL WATER CONTENT (17.3) %
 FINAL WATER CONTENT 21.3 %

BORING NO. 136
 SAMPLE NO. ST 6
 DEPTH 13.0' TO 14.6'

TEST DATA

INITIAL SAMPLE HEIGHT 0.75"
 INITIAL SAMPLE DIAMETER 2.50"
 INITIAL VOID RATIO (0.675)

**CONSOLIDATION TEST
 TIME VS. COMPRESSION CURVES**

THE DETROIT EDISON COMPANY
 BELLE RIVER PLANT UNITS I & II

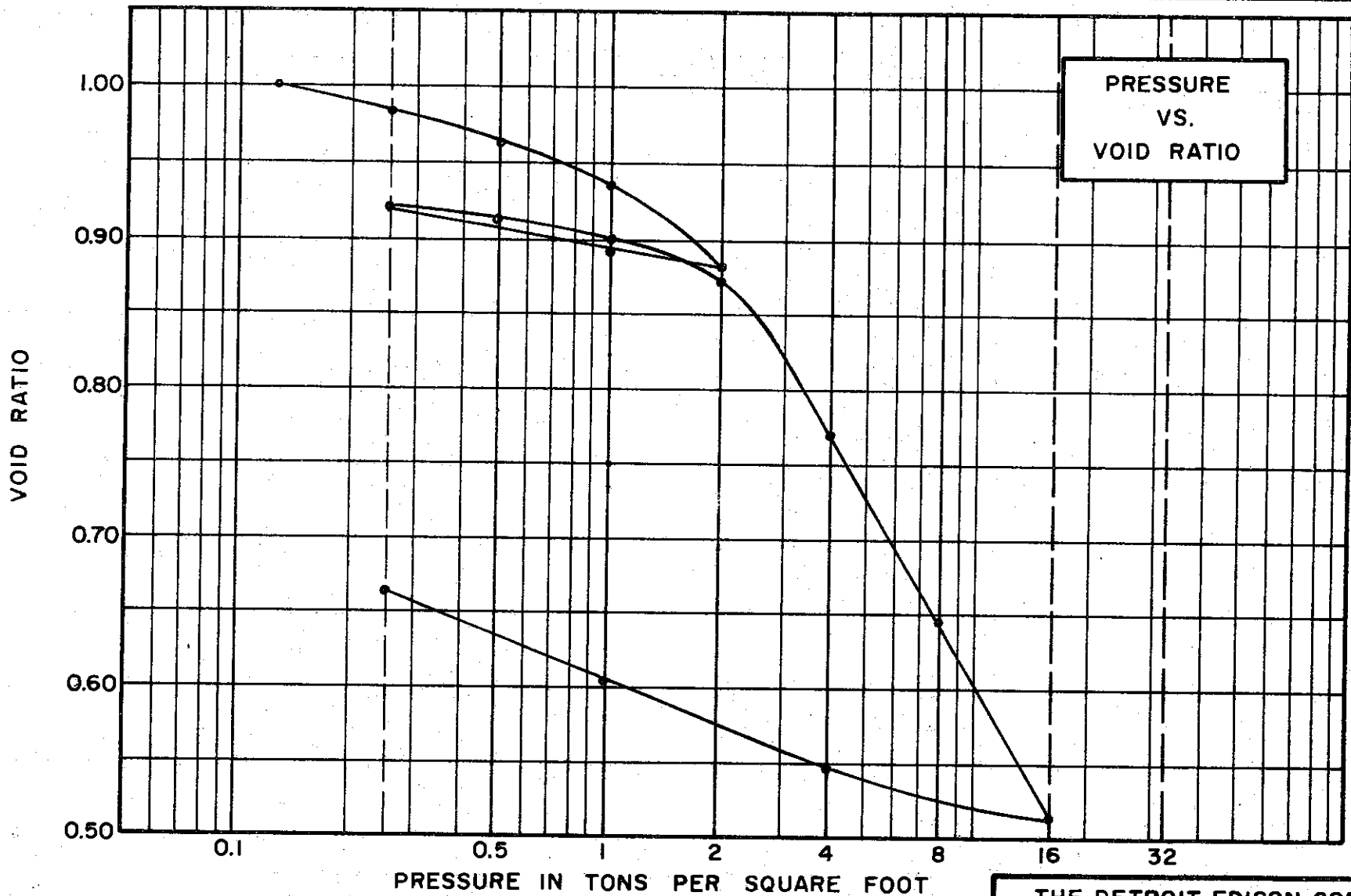

SOIL PROPERTIES

SOIL DESCRIPTION SILTY
CLAY (CL)

SPECIFIC GRAVITY 2.70

WATER CONTENT, INITIAL 38.2% FINAL 30.5%

ATTERBERG LIMITS:
LIQUID LIMIT 45 % PLASTIC LIMIT 22 %

TEST DATA

INITIAL SAMPLE HEIGHT 0.80"

INITIAL SAMPLE DIAMETER 2.50"

INITIAL VOID RATIO 1.019

THE DETROIT EDISON COMPANY
BELLE RIVER PLANT UNITS I & II

**CONSOLIDATION TEST
VOID RATIO VS. LOG PRESSURE**

BORING NO. 142 TEST NO. C535.1

SAMPLE NO. 6 DATE NOV. 1974

DEPTH 20.1' TO 20.5'

C-565

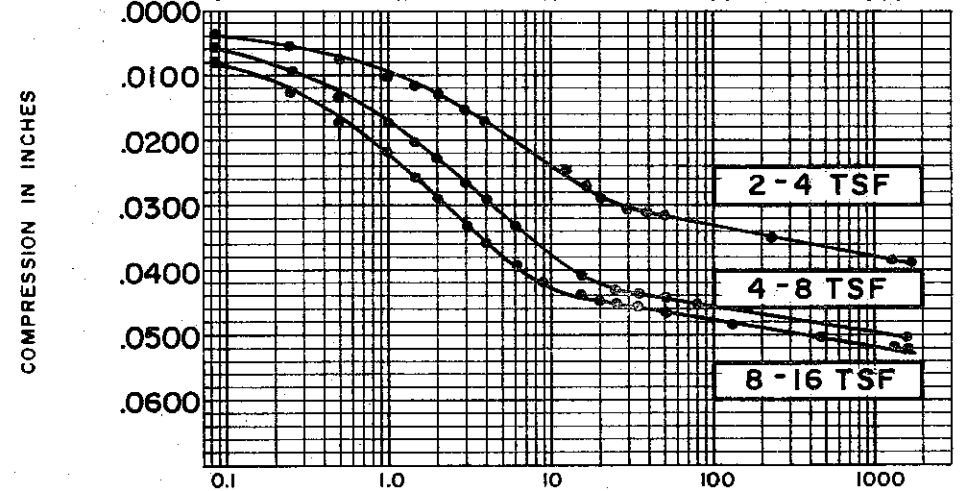
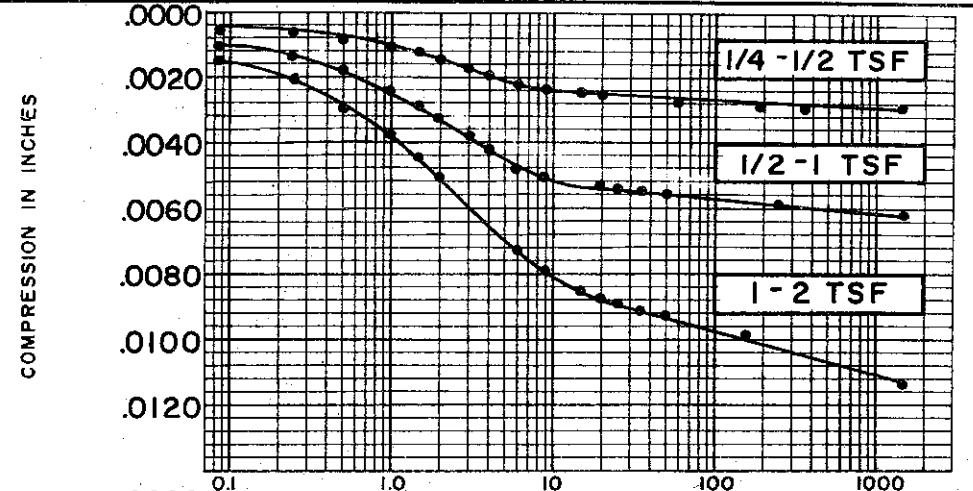
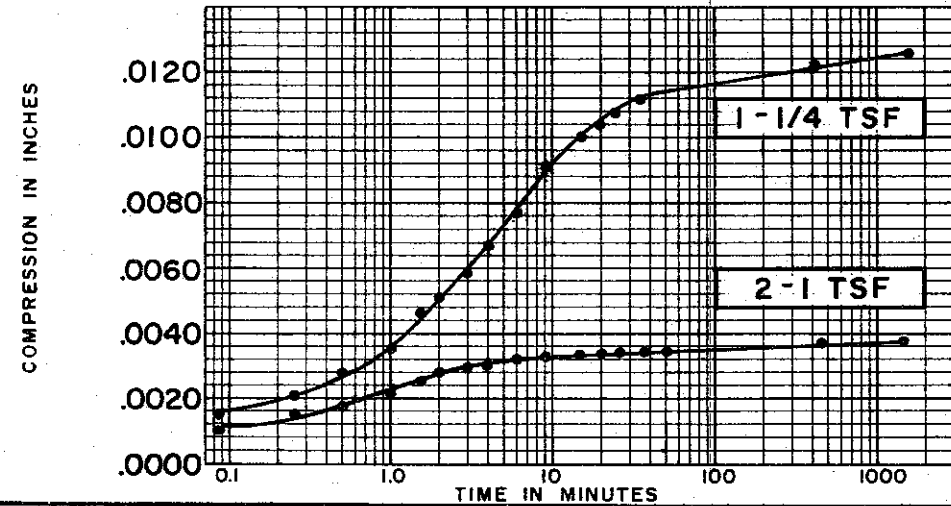
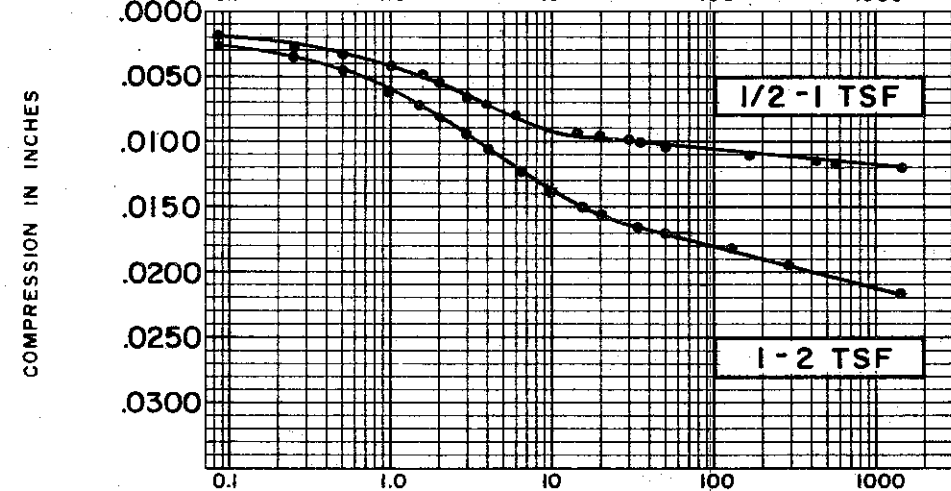
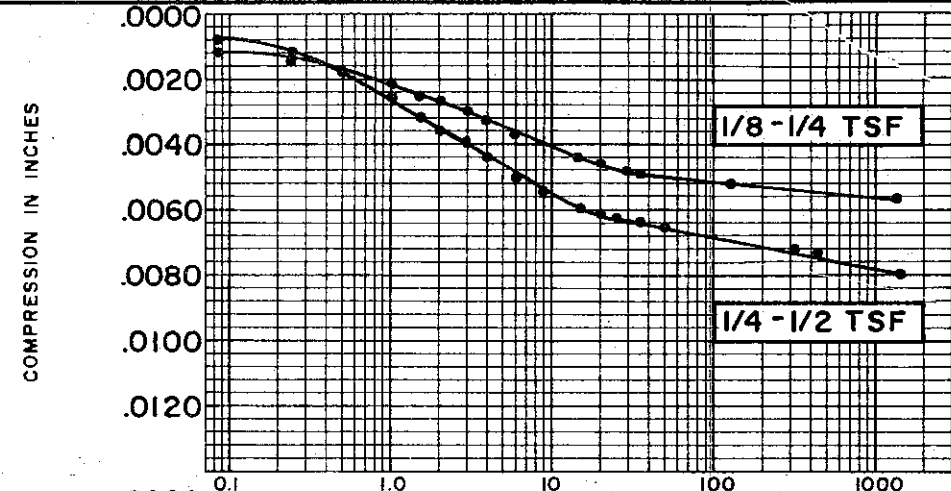

SOIL PROPERTIES
 SOIL DESCRIPTION: SILTY CLAY (CL)
 SPECIFIC GRAVITY 2.70
 INITIAL WATER CONTENT 38.2%
 FINAL WATER CONTENT 30.5%

BORING NO. 142
 SAMPLE NO. 6
 DEPTH 20.1' TO 20.5'

TEST DATA
 INITIAL SAMPLE HEIGHT 0.80"
 INITIAL SAMPLE DIAMETER 2.50"
 INITIAL VOID RATIO 1.019

**CONSOLIDATION TEST
 TIME VS. COMPRESSION CURVES**
 THE DETROIT EDISON COMPANY
 BELLE RIVER PLANT UNITS I & II

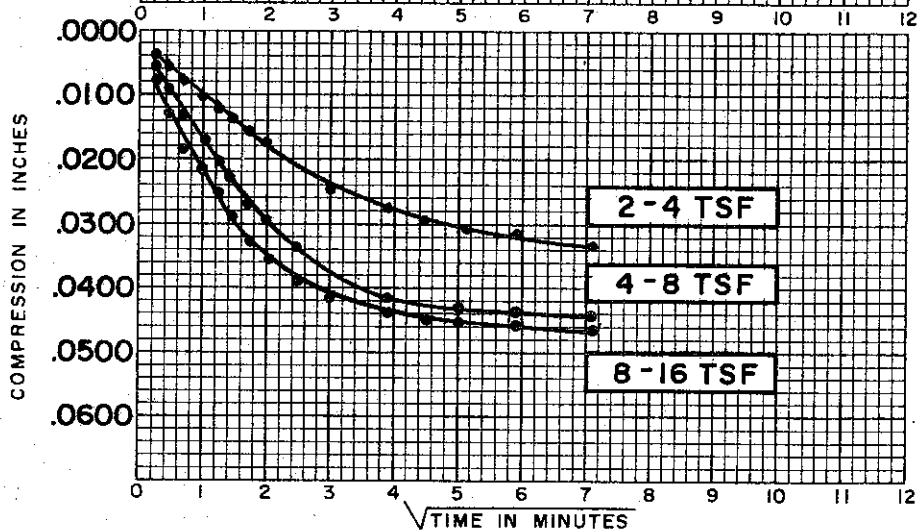
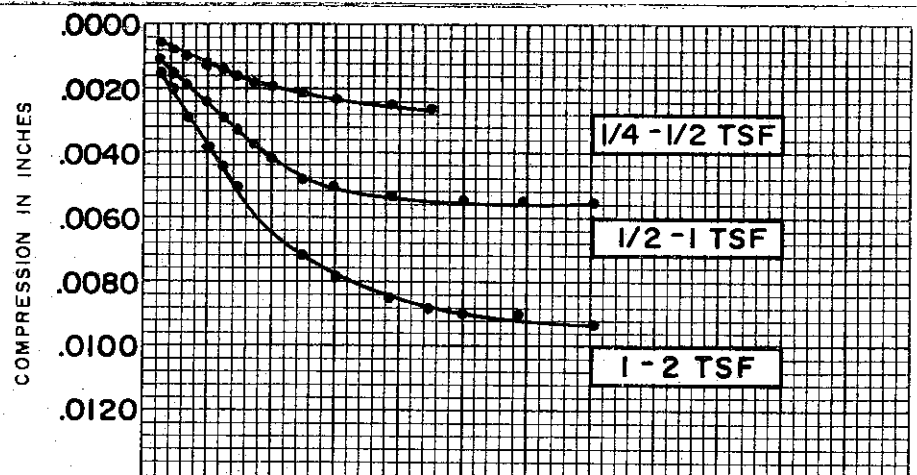
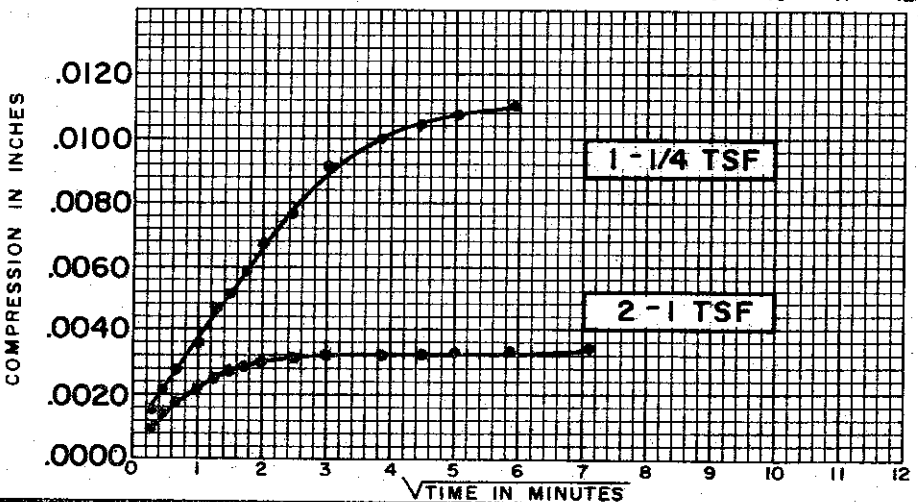
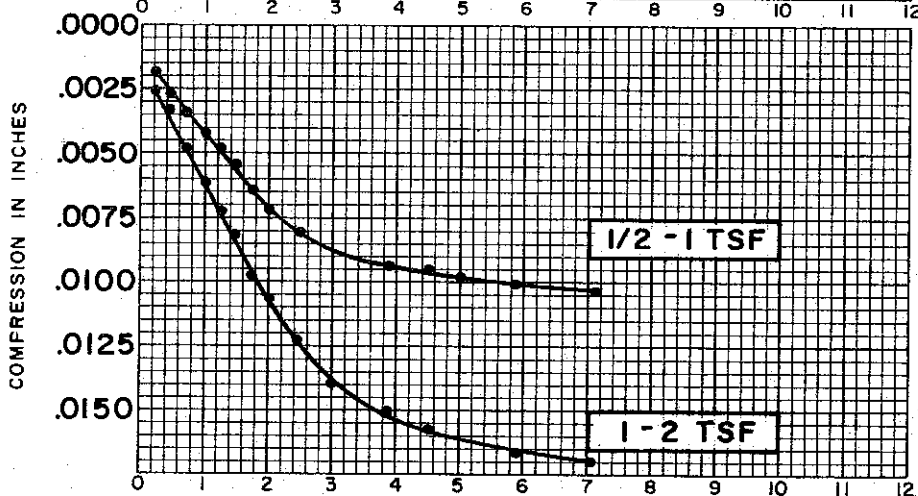
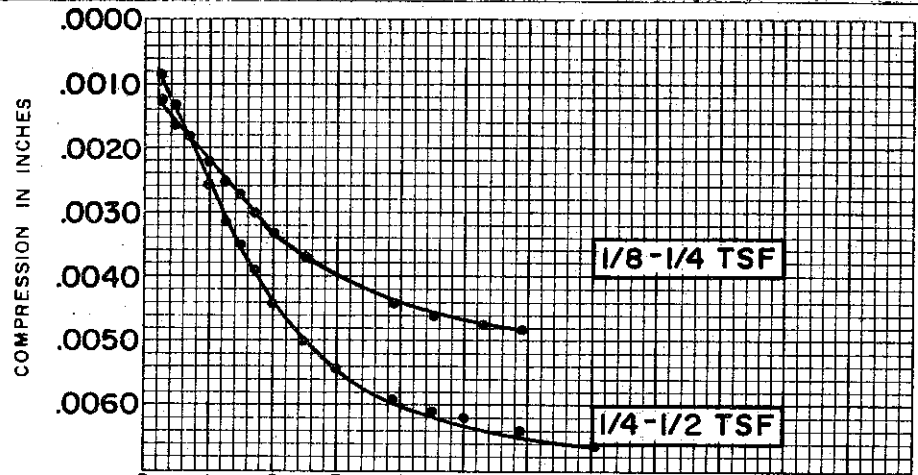

SOIL PROPERTIES

SOIL DESCRIPTION: SILTY CLAY (CL)
 SPECIFIC GRAVITY 2.70
 INITIAL WATER CONTENT 38.2 %
 FINAL WATER CONTENT 30.5 %

BORING NO. 142
 SAMPLE NO. 6
 DEPTH 20.1' TO 20.5'

TEST DATA

INITIAL SAMPLE HEIGHT 0.80"
 INITIAL SAMPLE DIAMETER 2.50"
 INITIAL VOID RATIO 1.019

**CONSOLIDATION TEST
 TIME VS. COMPRESSION CURVES**

THE DETROIT EDISON COMPANY
 BELLE RIVER PLANT UNITS I & II

C-567

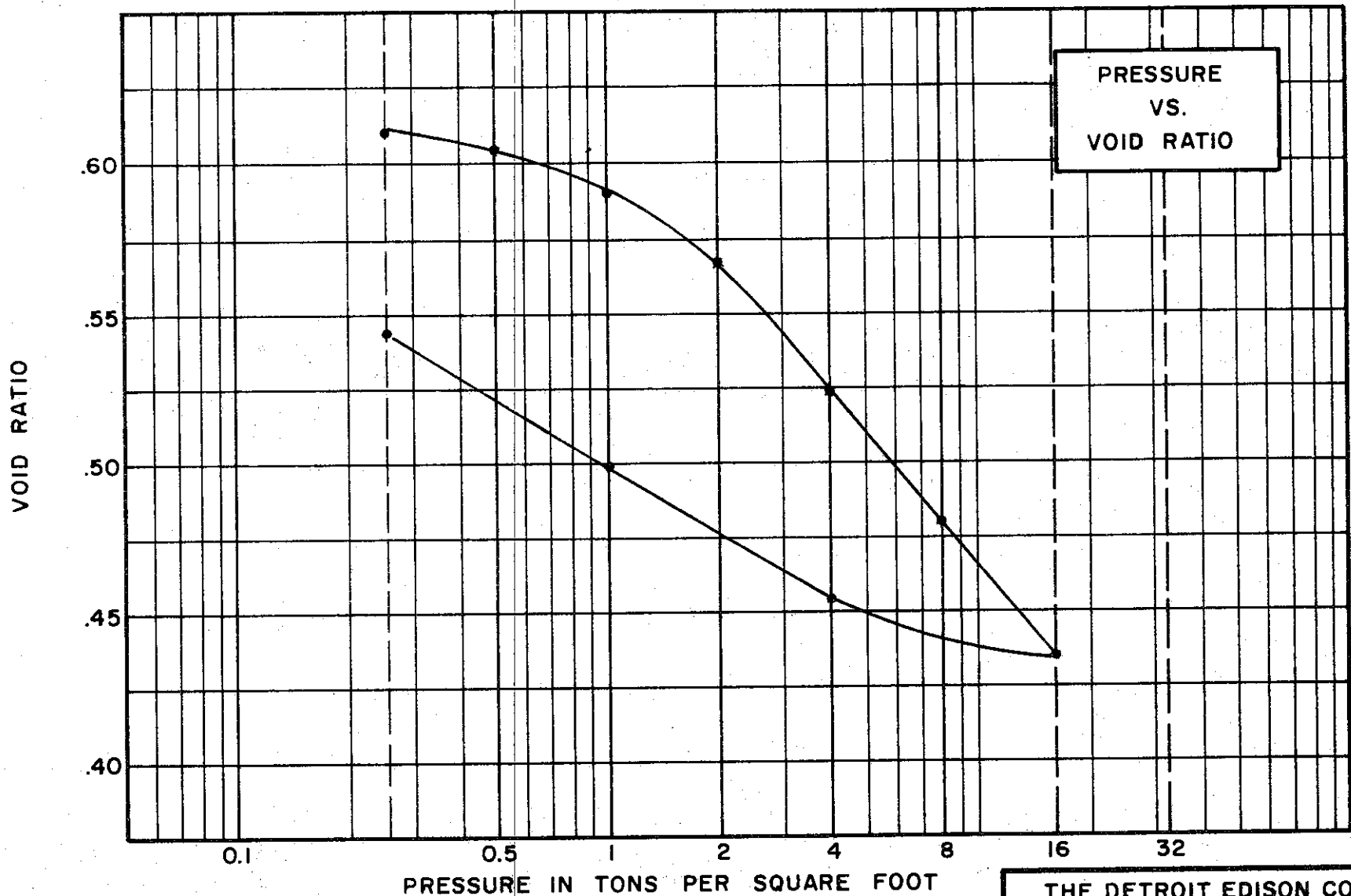

SOIL PROPERTIES

SOIL DESCRIPTION SILTY CLAY (CL)
 SPECIFIC GRAVITY 2.75
 WATER CONTENT, INITIAL 5.9% FINAL 22.2%
 ATTERBERG LIMITS:
 LIQUID LIMIT 46% PLASTIC LIMIT 22%

TEST DATA

INITIAL SAMPLE HEIGHT 0.750"
 INITIAL SAMPLE DIAMETER 2.500"
 INITIAL HEIGHT OF SOIL SOLIDS 0.447"
 INITIAL VOID RATIO (0.679) ^{AS} COMPACTED

THE DETROIT EDISON COMPANY
 BELLE RIVER PLANT UNITS I & II

**CONSOLIDATION TEST
 VOID RATIO VS. LOG PRESSURE**

BORING NO. 146 TEST NO. C542.1
 SAMPLE NO. 7 DATE DEC. 1974
 DEPTH 14.0' TO 16.1'

COMPRESSION IN INCHES

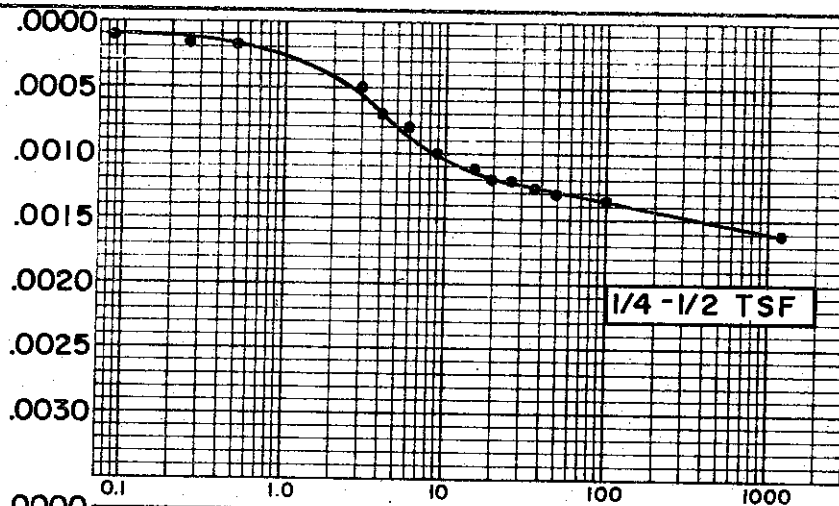

COMPRESSION IN INCHES

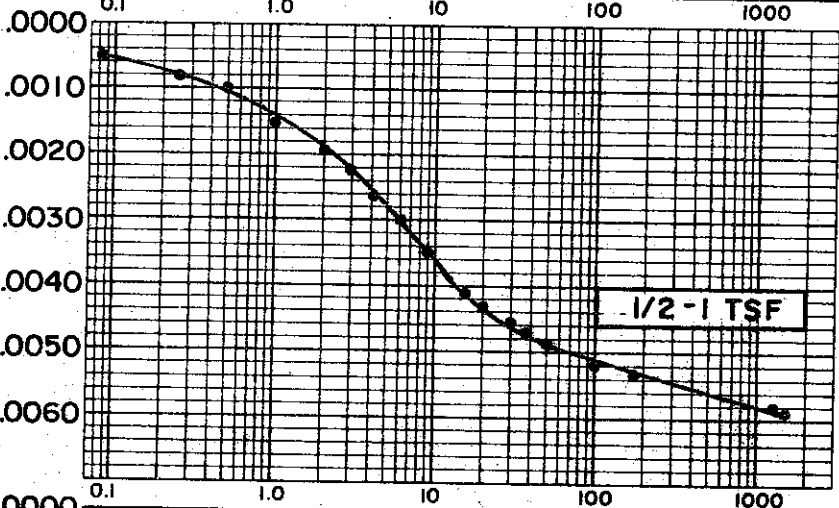

COMPRESSION IN INCHES

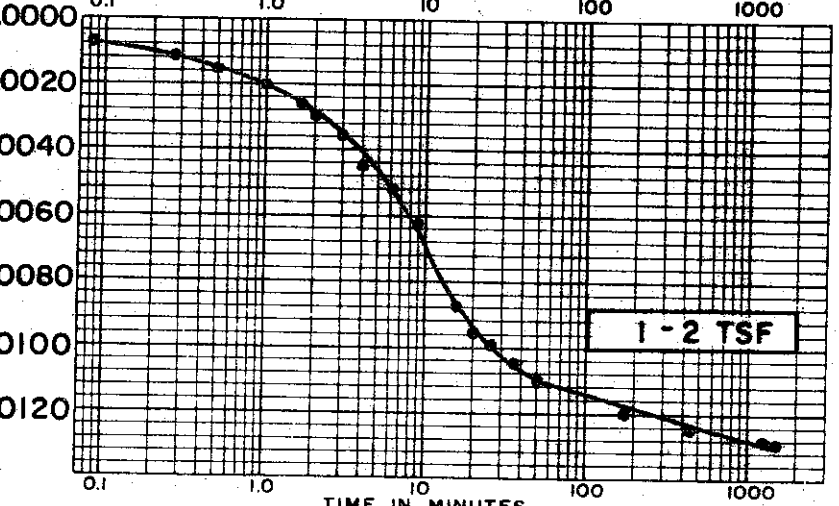

COMPRESSION IN INCHES

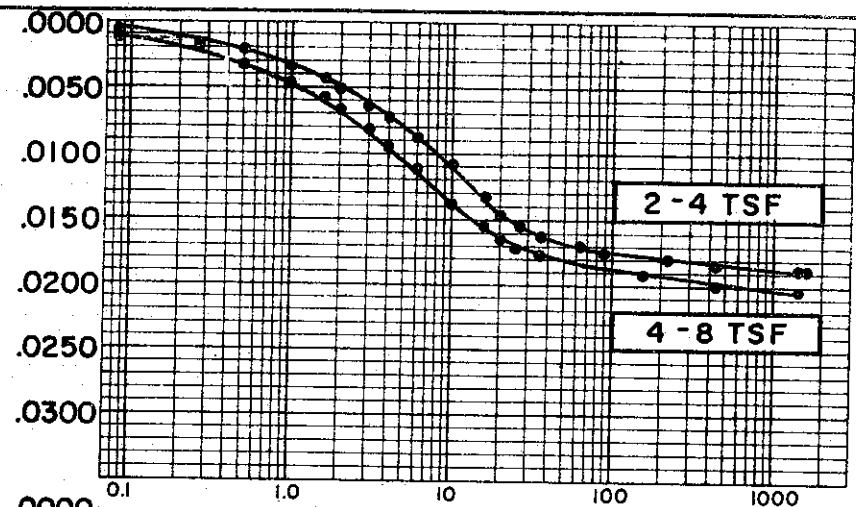

COMPRESSION IN INCHES

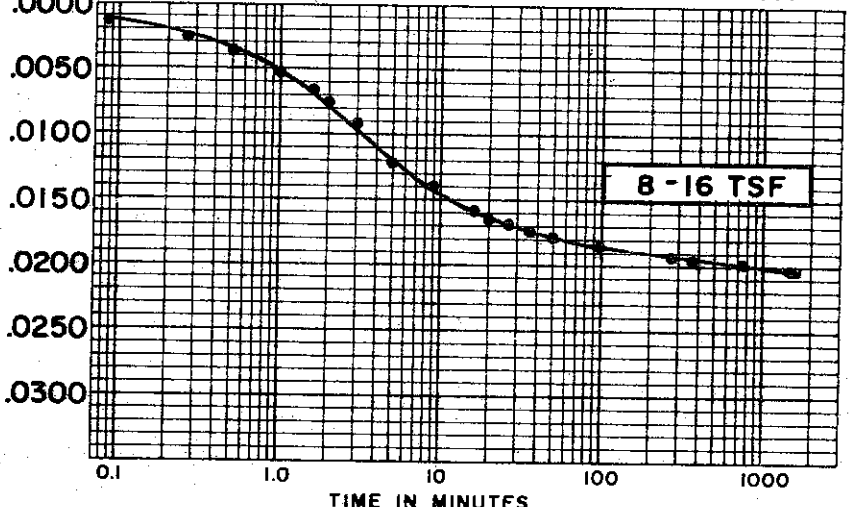

TIME IN MINUTES

SOIL PROPERTIES

SOIL DESCRIPTION: SILTY CLAY (CL)
 SPECIFIC GRAVITY 2.75
 INITIAL WATER CONTENT (15.9)%
 FINAL WATER CONTENT 22.2%

BORING NO. 146
 SAMPLE NO. ST 7
 DEPTH 14.0' TO 16.1'

TEST DATA

INITIAL SAMPLE HEIGHT 0.75"
 INITIAL SAMPLE DIAMETER 2.50"
 INITIAL VOID RATIO (0.679)

CONSOLIDATION TEST TIME VS. COMPRESSION CURVES

THE DETROIT EDISON COMPANY
 BELLE RIVER PLANT UNITS I & II

C-569

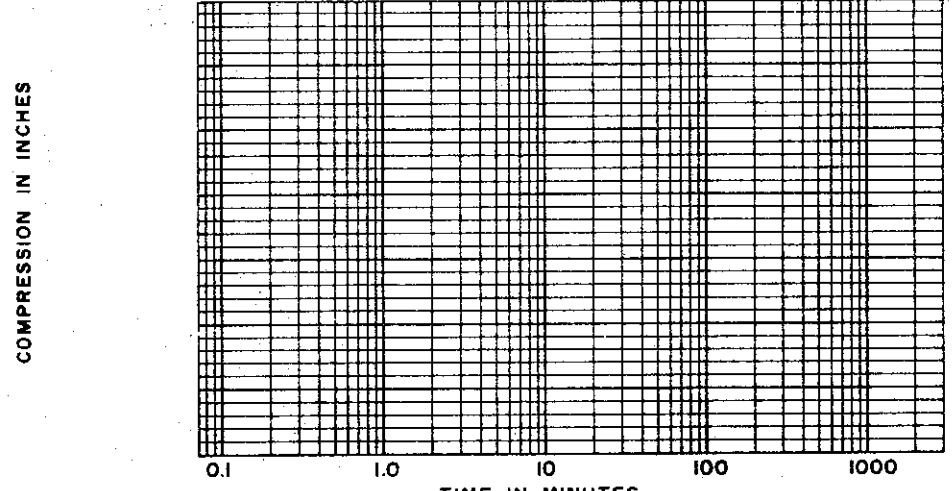
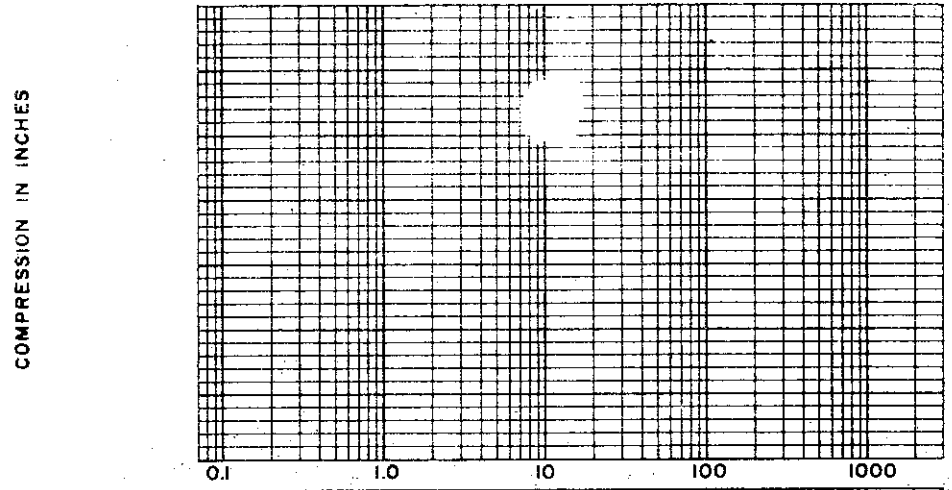
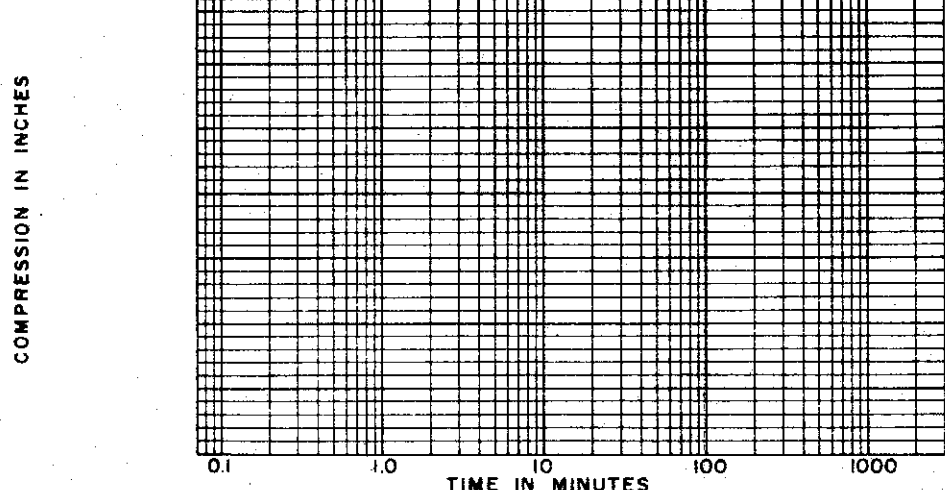
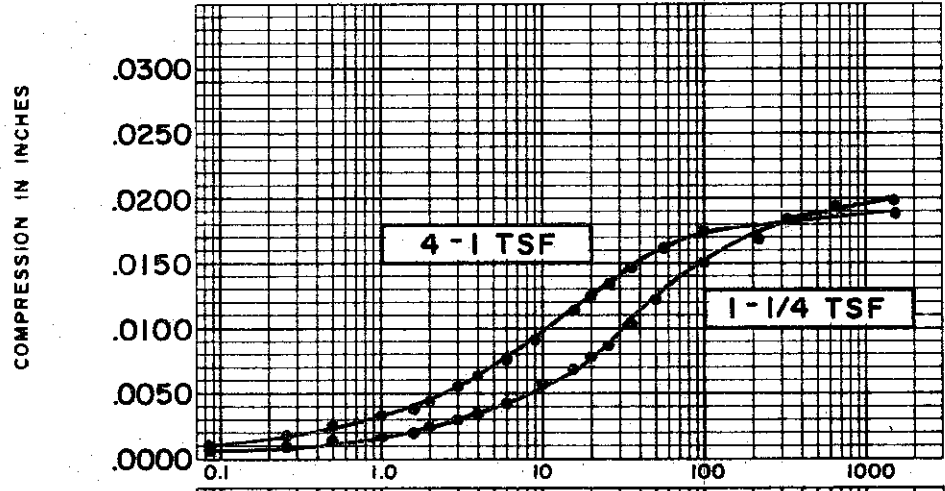
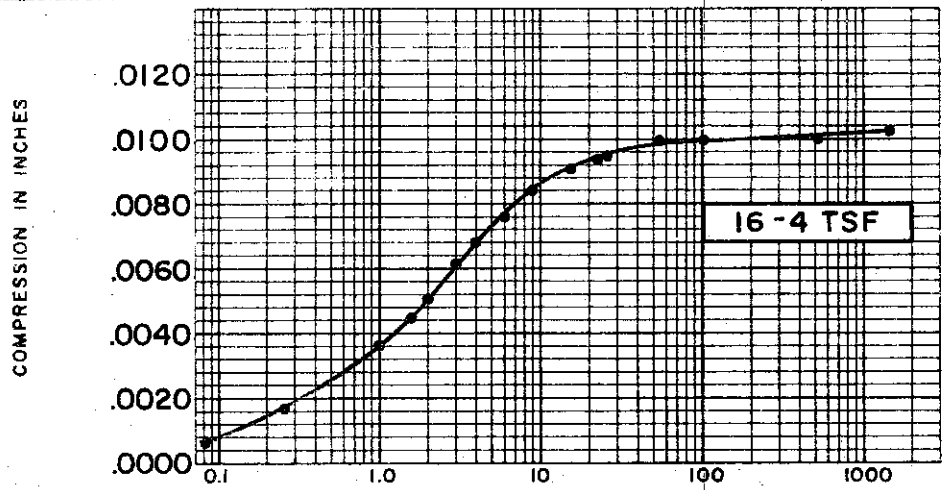

SOIL PROPERTIES		BORING NO. <u>146</u>
SOIL DESCRIPTION: <u>SILTY</u>		SAMPLE NO. <u>ST 7</u>
<u>CLAY (CL)</u>		DEPTH <u>14.0' TO 16.1'</u>
SPECIFIC GRAVITY <u>2.75</u>		
INITIAL WATER CONTENT <u>(15.9)%</u>		
FINAL WATER CONTENT <u>22.2%</u>		
TEST DATA		
INITIAL SAMPLE HEIGHT	<u>0.75"</u>	
INITIAL SAMPLE DIAMETER	<u>2.50"</u>	
INITIAL VOID RATIO	<u>(0.679)</u>	
CONSOLIDATION TEST		
TIME VS. COMPRESSION CURVES		
THE DETROIT EDISON COMPANY BELLE RIVER PLANT UNITS I & II		

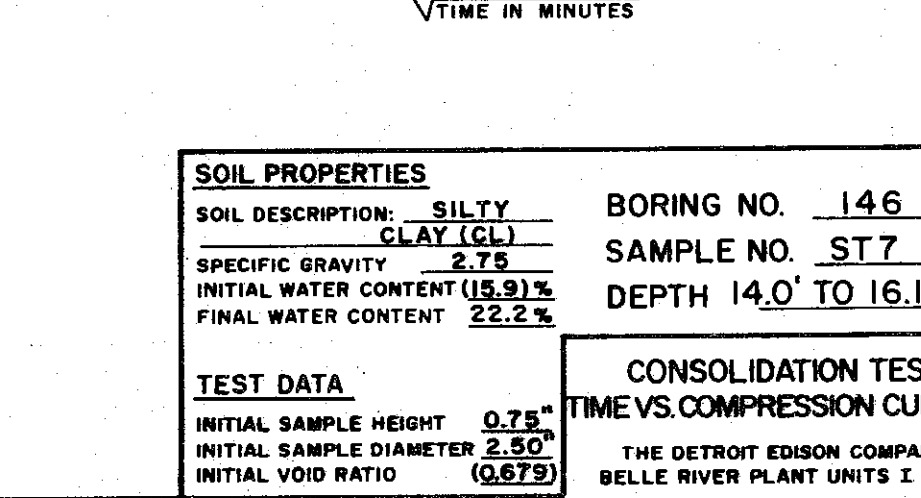
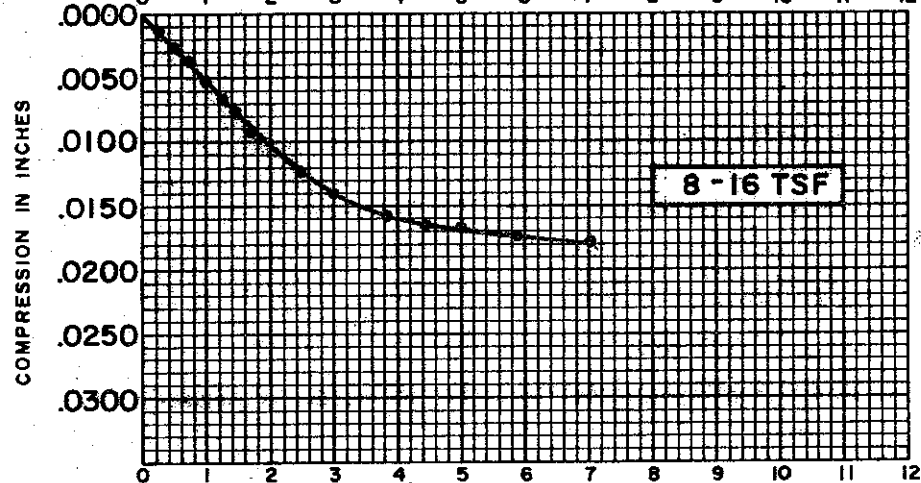
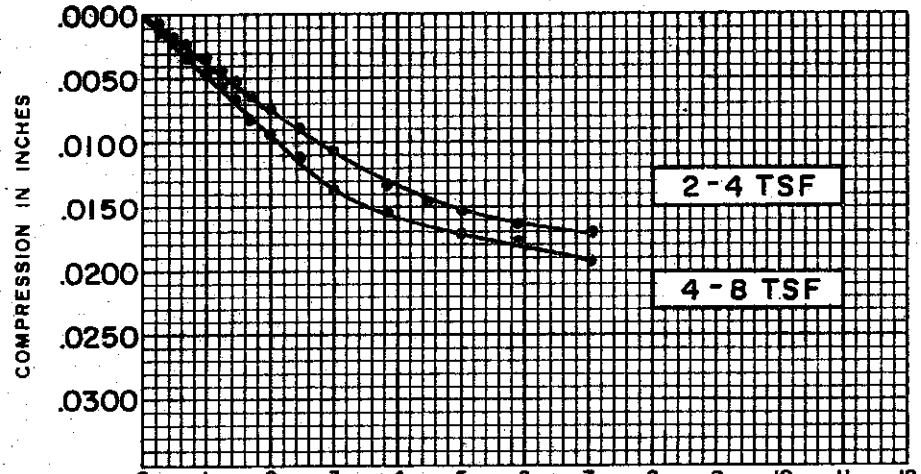
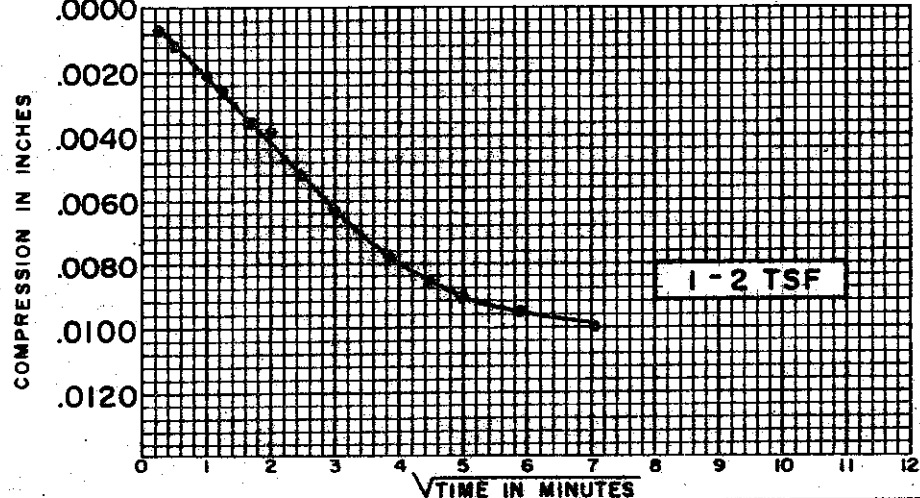
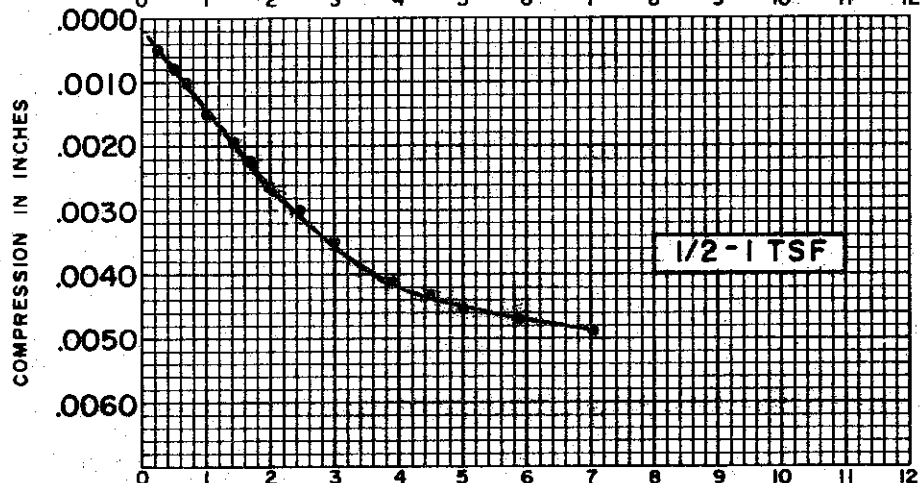
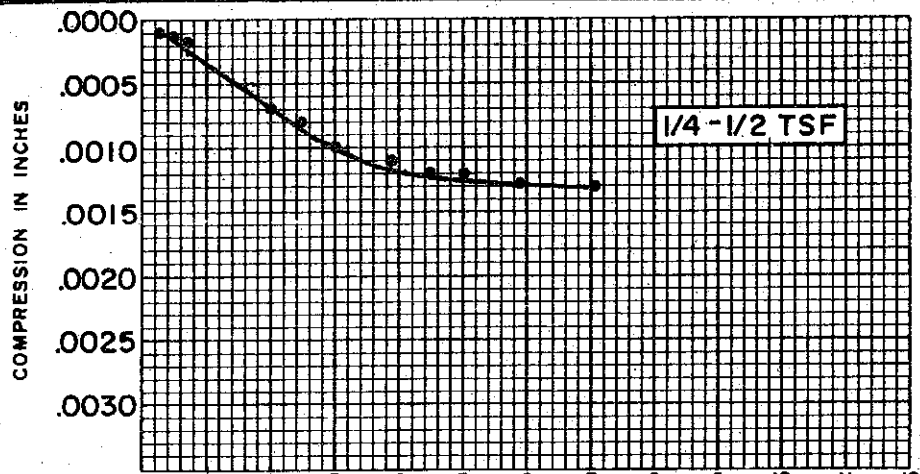

SOIL PROPERTIES

SOIL DESCRIPTION: SILTY CLAY (CL)
 SPECIFIC GRAVITY 2.75
 INITIAL WATER CONTENT (15.9) %
 FINAL WATER CONTENT 22.2 %

BORING NO. 146
 SAMPLE NO. ST 7
 DEPTH 14.0' TO 16.1'

TEST DATA

INITIAL SAMPLE HEIGHT 0.75"
 INITIAL SAMPLE DIAMETER 2.50"
 INITIAL VOID RATIO (0.679)

**CONSOLIDATION TEST
 TIME VS. COMPRESSION CURVES**

THE DETROIT EDISON COMPANY
 BELLE RIVER PLANT UNITS I & II

C-571

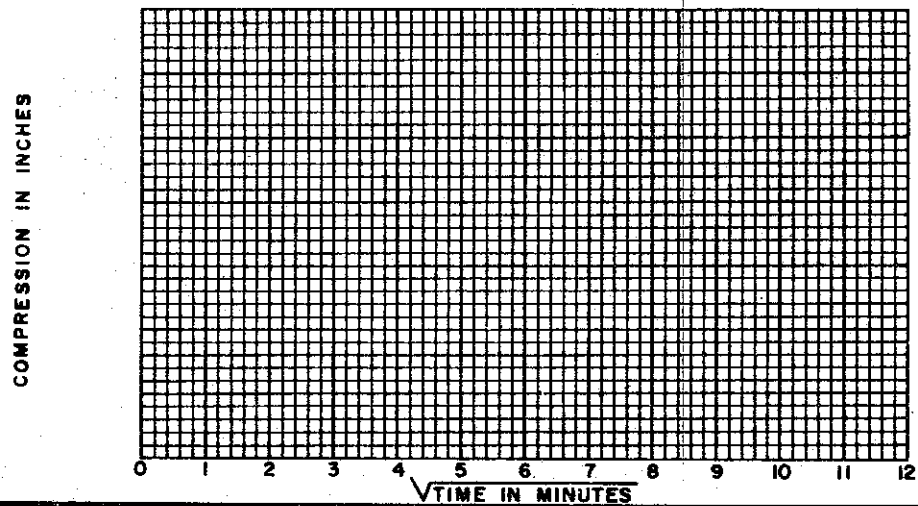
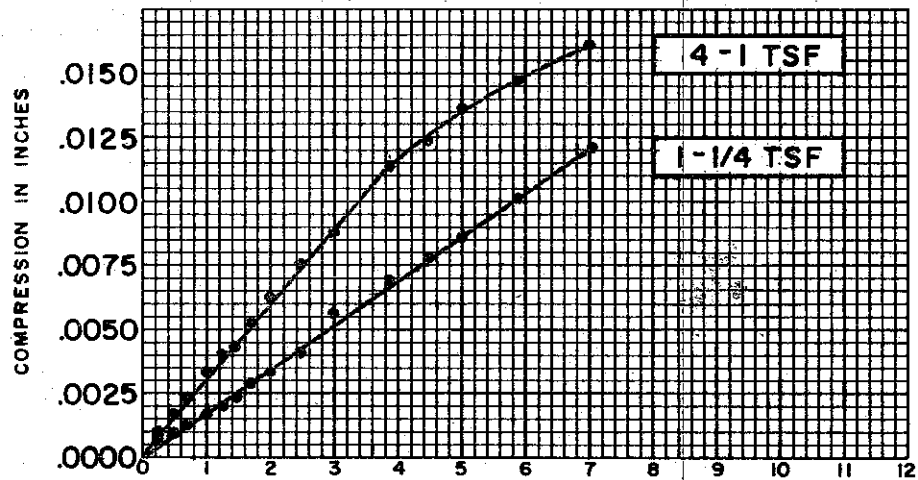
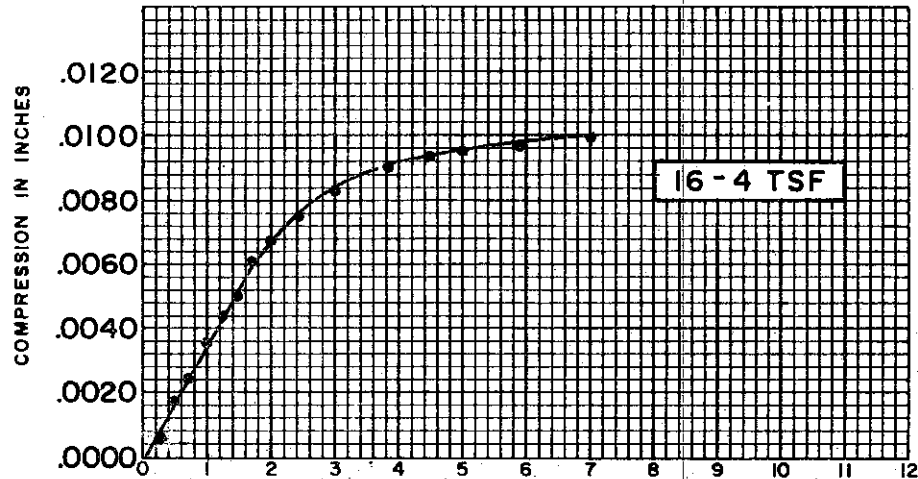

COMPRESSION IN INCHES

COMPRESSION IN INCHES

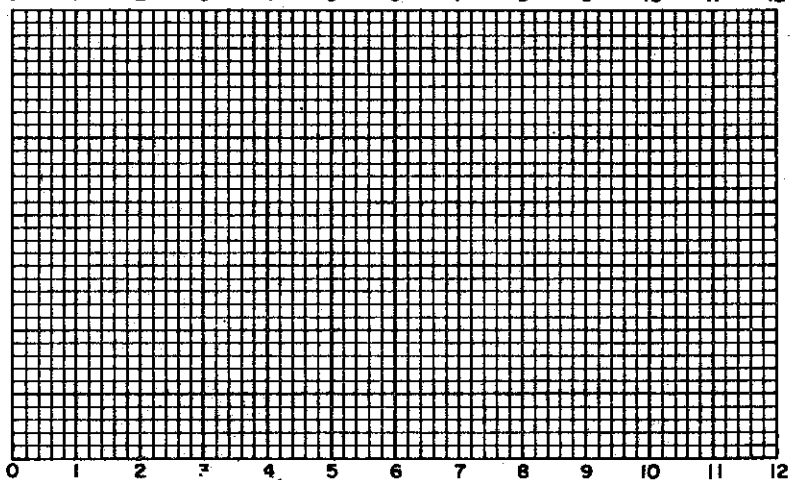
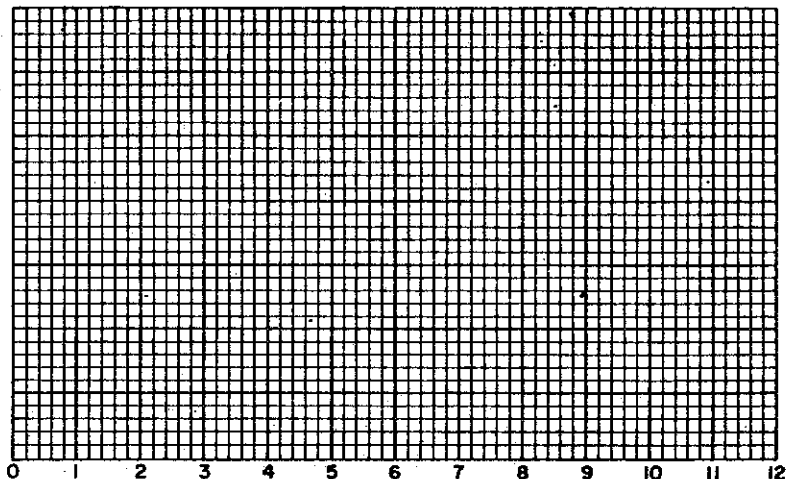

√TIME IN MINUTES

SOIL PROPERTIES

SOIL DESCRIPTION: SILTY CLAY (CL)
 SPECIFIC GRAVITY 2.75
 INITIAL WATER CONTENT 15.9%
 FINAL WATER CONTENT 22.2%

BORING NO. 146
 SAMPLE NO. ST 7
 DEPTH 14.0' TO 16.1'

TEST DATA

INITIAL SAMPLE HEIGHT 0.75"
 INITIAL SAMPLE DIAMETER 2.50"
 INITIAL VOID RATIO (0.679)

**CONSOLIDATION TEST
 TIME VS. COMPRESSION CURVES**

THE DETROIT EDISON COMPANY
 BELLE RIVER PLANT UNITS I & II

C-454

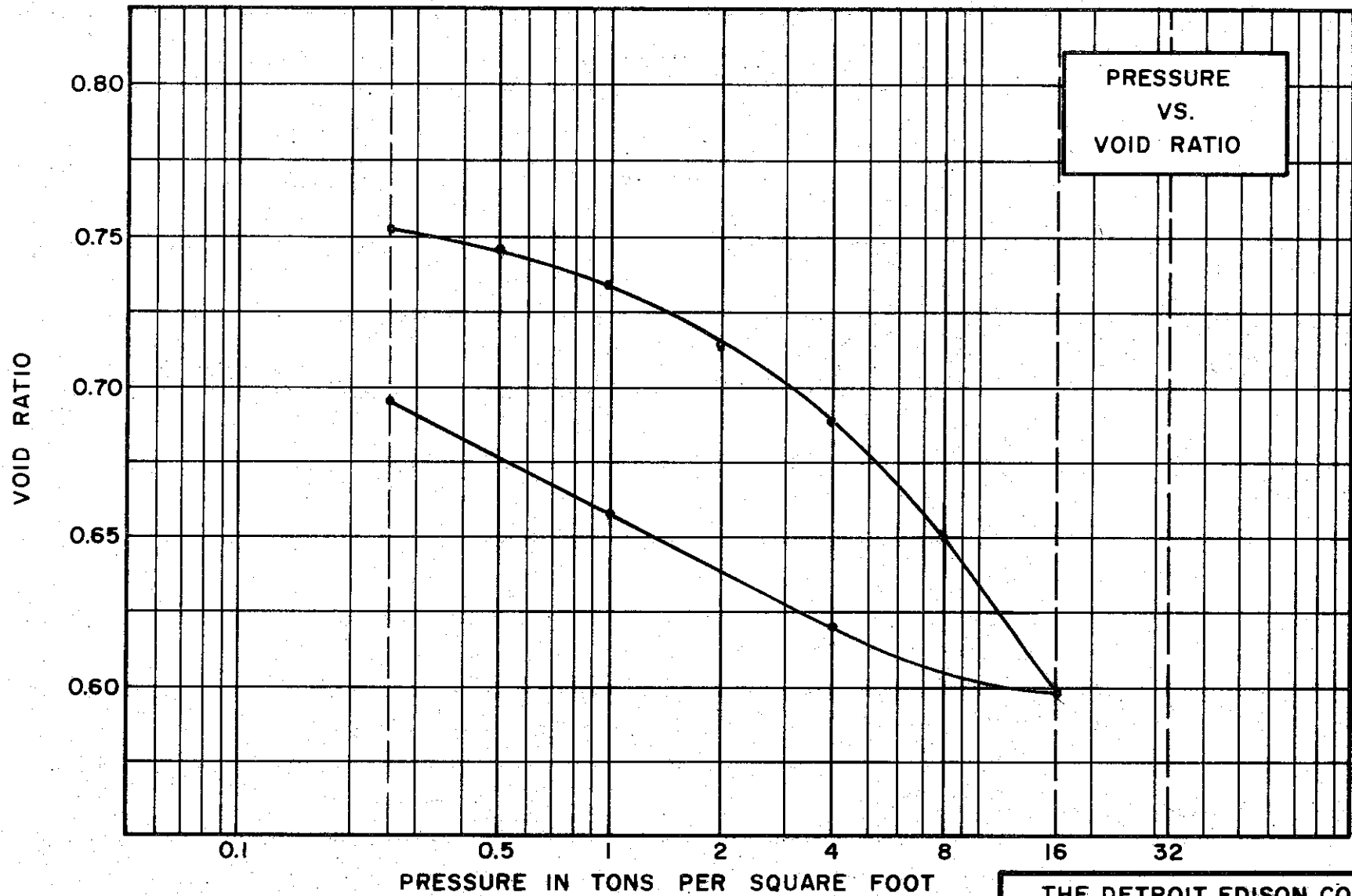

SOIL PROPERTIES

SOIL DESCRIPTION SILTY CLAY (CL-CH)
 SPECIFIC GRAVITY 2.72
 WATER CONTENT, INITIAL 29.1% FINAL 28.9%
 ATTERBERG LIMITS:
 LIQUID LIMIT 50 % PLASTIC LIMIT 23 %

TEST DATA

INITIAL SAMPLE HEIGHT 0.80"
 INITIAL SAMPLE DIAMETER 2.50"
 INITIAL VOID RATIO 0.757

THE DETROIT EDISON COMPANY
 BELLE RIVER PLANT UNITS I & II

**CONSOLIDATION TEST
 VOID RATIO VS. LOG PRESSURE**

BORING NO. 185 TEST NO. C552.1
 SAMPLE NO. 3 DATE NOV. 1974
 DEPTH 7.9' TO 8.1'

C-573

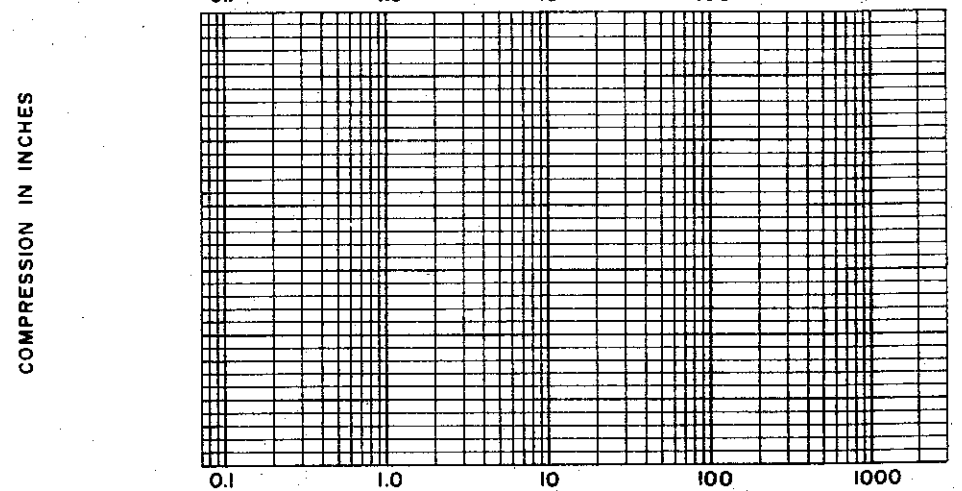
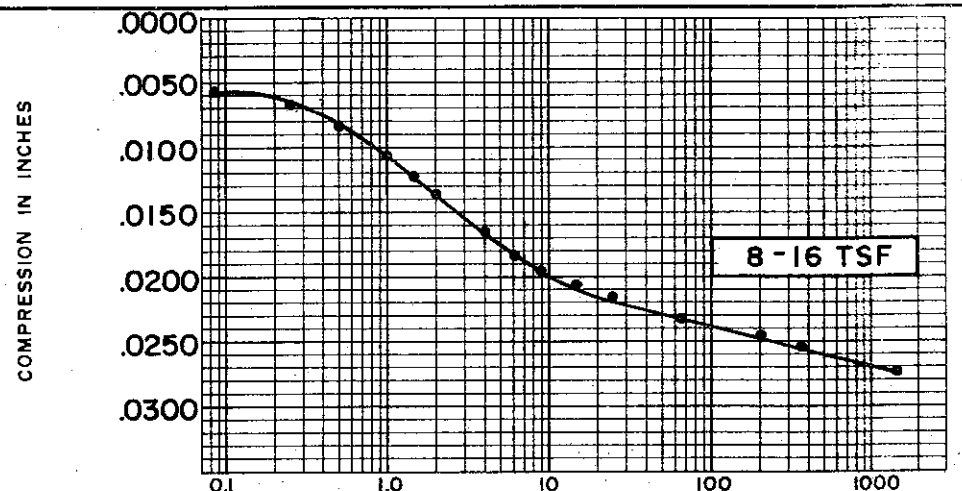
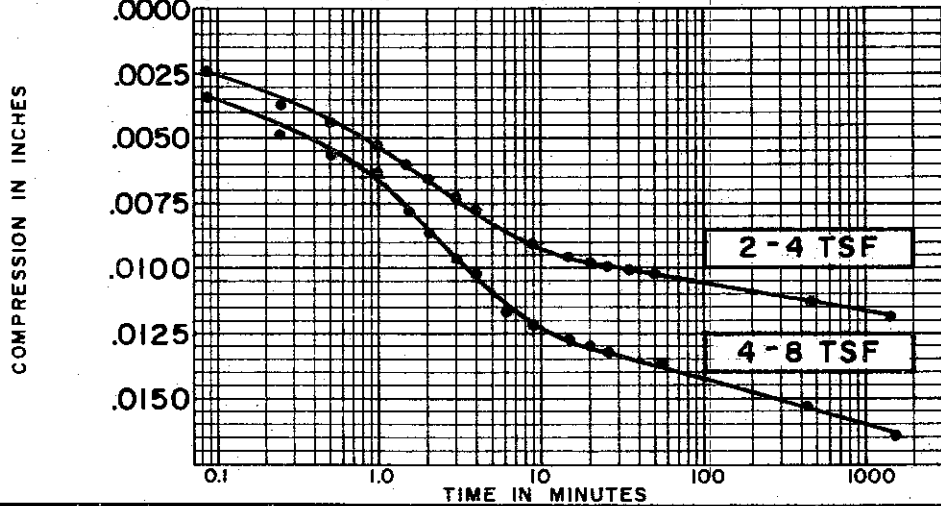
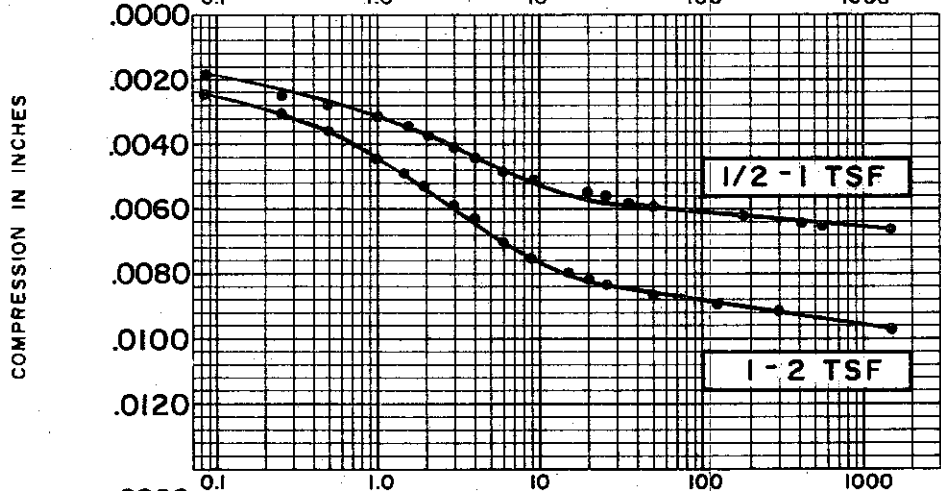
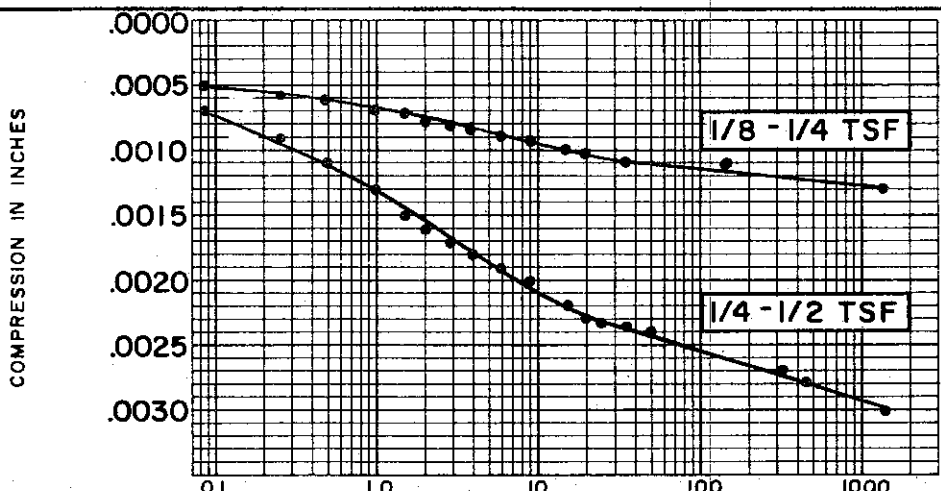

SOIL PROPERTIES	
SOIL DESCRIPTION:	SILTY CLAY (CL-CH)
SPECIFIC GRAVITY	2.72
INITIAL WATER CONTENT	29.1 %
FINAL WATER CONTENT	28.9 %
BORING NO.	185
SAMPLE NO.	3
DEPTH	7.9' TO 8.1'

TEST DATA	
INITIAL SAMPLE HEIGHT	0.80"
INITIAL SAMPLE DIAMETER	2.50"
INITIAL VOID RATIO	0.757

CONSOLIDATION TEST
 TIME VS. COMPRESSION CURVES
 THE DETROIT EDISON COMPANY
 BELLE RIVER PLANT UNITS I & II

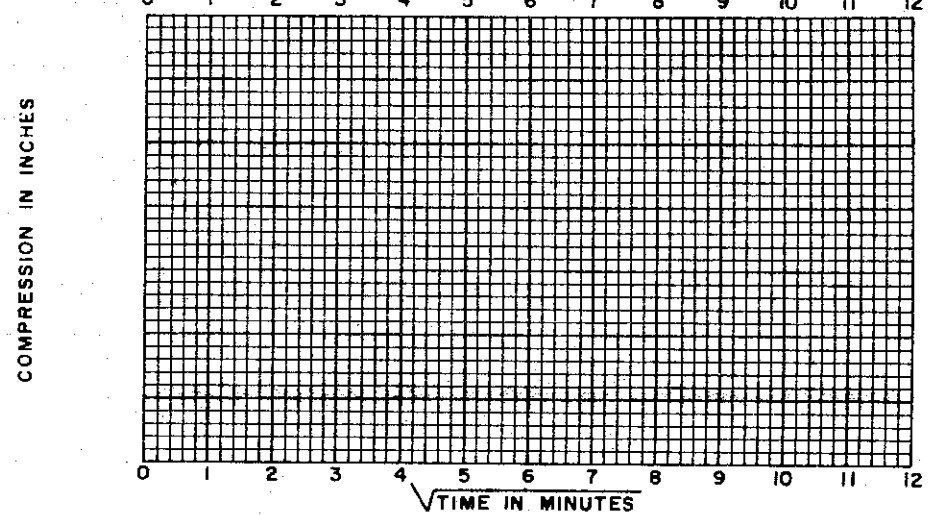
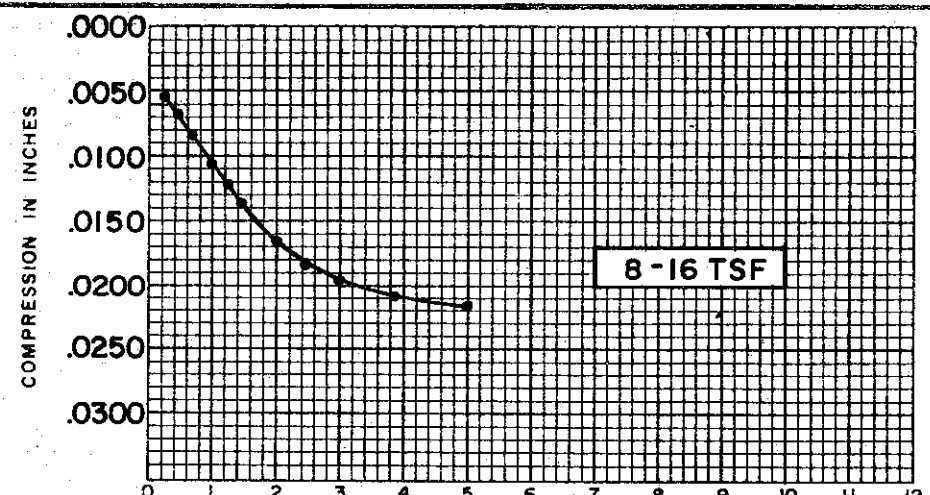
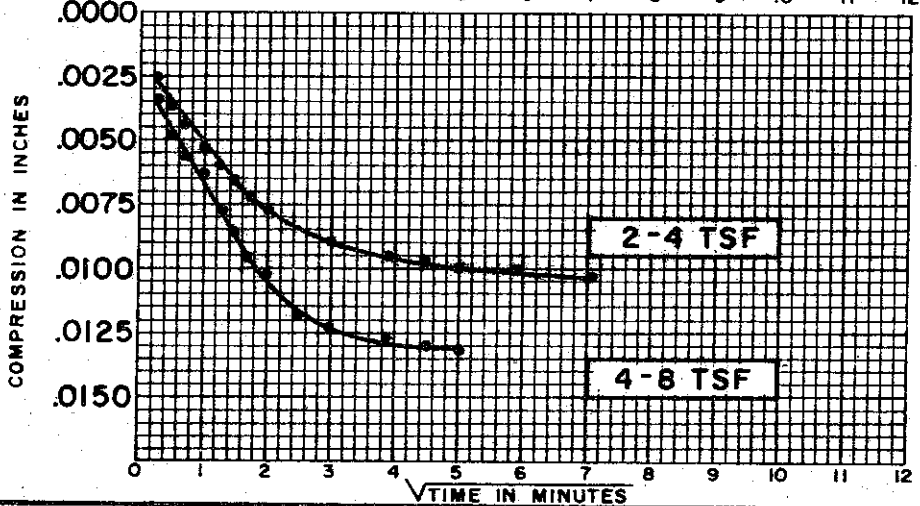
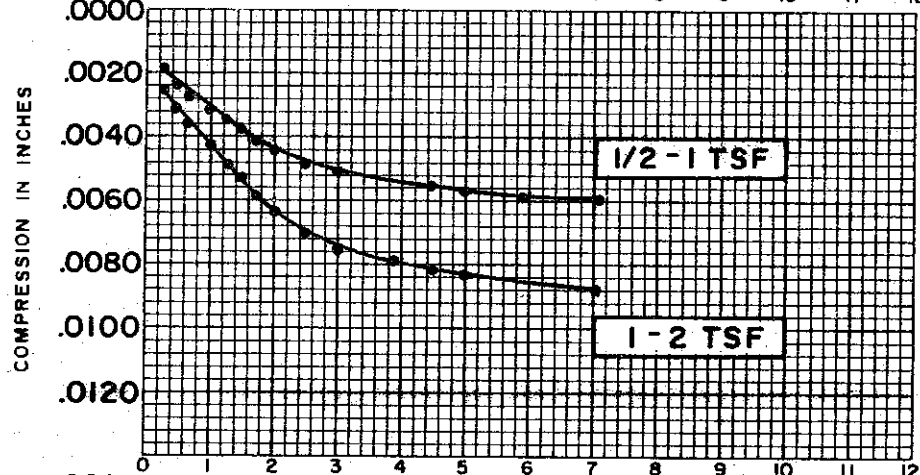
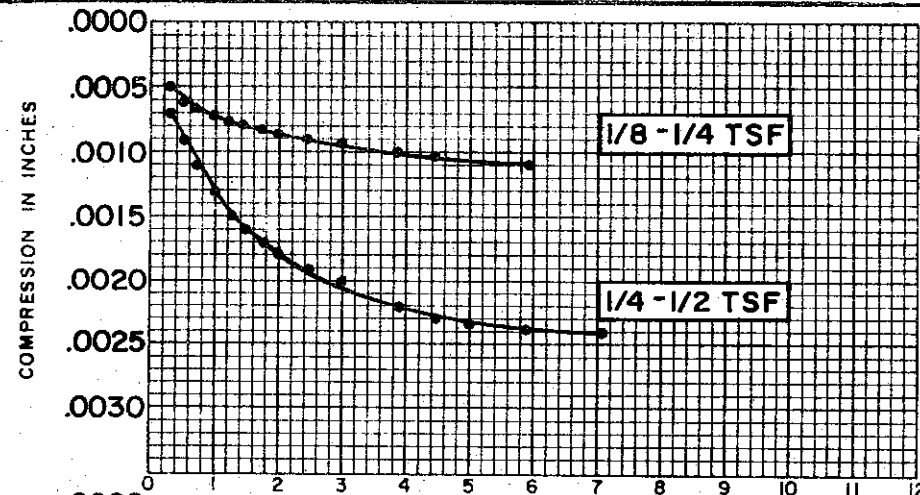

SOIL PROPERTIES		BORING NO.	185
SOIL DESCRIPTION:	SILTY CLAY (CL-CH)	SAMPLE NO.	3
SPECIFIC GRAVITY	2.72	DEPTH	7.9' TO 8.1'
INITIAL WATER CONTENT	29.1%		
FINAL WATER CONTENT	28.9%		

TEST DATA	
INITIAL SAMPLE HEIGHT	0.80"
INITIAL SAMPLE DIAMETER	2.50"
INITIAL VOID RATIO	0.757

**CONSOLIDATION TEST
TIME VS. COMPRESSION CURVES**

THE DETROIT EDISON COMPANY
BELLE RIVER PLANT UNITS I & II

C-575

9-576

APPLIED PRESSURE in tons/ft. ²	SQUARE ROOT FITTING METHOD			LOG FITTING METHOD		
	t ₉₀ in sec.	ft. ² /day	c _v cm. ² /sec.	t ₅₀ in sec.	ft. ² /day	c _v cm. ² /sec.
1/4 - 1/2	738	.11	.0012	300	.07	.0007
1/2 - 1	612	.13	.0014	180	.10	.0011
1 - 2	540	.14	.0015	138	.13	.0014
2 - 4	378	.19	.0020	78	.21	.0023
4 - 8	468	.15	.0016	108	.15	.0016
8 - 16	378	.17	.0018	108	.19	.0015
16 - 4	174	.36	.0039	60	.24	.0026
4 - 1	1164	.06	.0006	240	.07	.0007
1 - 1/4	3024	.02	.0002	900	.02	.0002

BORING NO. 38
 SAMPLE NO. 4
 DEPTH 14.6' to 14.7'
 TEST NO. C18.1

SOIL PROPERTIES
 SOIL DESCRIPTION: _____
Silty CLAY (CL-CH)
 INITIAL WATER CONTENT 29.0 %
 ATTERBERG LIMITS
 LIQUID LIMIT 46 % PLASTIC LIMIT 22 %

TEST DATA
 INITIAL SAMPLE HEIGHT 0.80 IN 2.03 CM.
 INITIAL VOID RATIO .770 C_c .19

APPLIED PRESSURE in tons/ft. ²	SQUARE ROOT FITTING METHOD			LOG FITTING METHOD		
	t ₉₀ in sec.	ft. ² /day	c _v cm. ² /sec.	t ₅₀ in sec.	ft. ² /day	c _v cm. ² /sec.
1/8 - 1/4	960	.08	.0009	---	---	----
1/4 - 1/2	612	.12	.0013	180	.10	.0011
1/2 - 1	468	.16	.0017	156	.11	.0012
1 - 2	378	.19	.0020	120	.13	.0014
2 - 4	288	.22	.0024	90	.17	.0018
4 - 1	135	.46	.0050	54	.27	.0029
1 - 1/4	912	.07	.0008	216	.07	.0007
1/4 - 1/2	264	.25	.0027	102	.15	.0016
1/2 - 1	438	.15	.0016	84	.18	.0019
1 - 2	173	.37	.0040	48	.31	.0033
2 - 4	135	.46	.0050	36	.40	.0043
4 - 8	216	.27	.0029	48	.28	.0030
8 - 16	192	.27	.0029	42	.29	.0031
16 - 4	138	.36	.0039	33	.34	.0037
4 - 1	576	.09	.0010	150	.08	.0009
1 - 1/4	1380	.04	.0004	450	.03	.0003

BORING NO. 38
 SAMPLE NO. 16
 DEPTH 74.0' to 74.1'
 TEST NO. C24.1

SOIL PROPERTIES
 SOIL DESCRIPTION: _____
Silty CLAY (CH)
 INITIAL WATER CONTENT 36.0 %
 ATTERBERG LIMITS
 LIQUID LIMIT 55 % PLASTIC LIMIT 24 %

TEST DATA
 INITIAL SAMPLE HEIGHT 0.80 IN 2.03 CM.
 INITIAL VOID RATIO .935 C_c .33

**CONSOLIDATION TEST
 SUMMARY OF c_v VALUES**
 THE DETROIT EDISON COMPANY
 BELLE RIVER PLANT UNITS I & II

APPLIED PRESSURE in tons/ft. ²	SQUARE ROOT FITTING METHOD			LOG FITTING METHOD		
	t ₉₀ in sec.	ft. ² /day	c _v cm. ² /sec.	t ₅₀ in sec.	ft. ² /day	c _v cm. ² /sec.
1/4 - 1/2	540	.15	.0016	168	.11	.0012
1/2 - 1	408	.20	.0021	180	.10	.0011
1 - 1/4	1164	.07	.0007	312	.06	.0006
1/4 - 1/2	438	.18	.0019	120	.15	.0016
1/2 - 1	822	.09	.0010	180	.10	.0011
1 - 2	378	.20	.0022	132	.13	.0014
2 - 4	408	.18	.0019	120	.14	.0015
4 - 8	408	.17	.0018	102	.16	.0017
8 - 16	540	.11	.0012	120	.13	.0014
24 - 6	138	.42	.0046	45	.31	.0033
6 - 1/2	1218	.06	.0006	450	.04	.0004

BORING NO. 41
SAMPLE NO. 5
DEPTH 10.8' to 11.0'
TEST NO. C29.1

SOIL PROPERTIES
SOIL DESCRIPTION: _____
Silty CLAY (CL-CH)
INITIAL WATER CONTENT 29.5 %
ATTERBERG LIMITS
LIQUID LIMIT 46 % PLASTIC LIMIT 23 %

TEST DATA
INITIAL SAMPLE HEIGHT 0.80 IN 2.03 CM.
INITIAL VOID RATIO 0.799 C_c 0.23

APPLIED PRESSURE in tons/ft. ²	SQUARE ROOT FITTING METHOD			LOG FITTING METHOD		
	t ₉₀ in sec.	ft. ² /day	c _v cm. ² /sec.	t ₅₀ in sec.	ft. ² /day	c _v cm. ² /sec.
1/4 - 1/2	614	.12	.0013	240	.07	.0008
1/2 - 1	540	.14	.0015	210	.08	.0009
1 - 2	614	.11	.0012	225	.07	.0008
2 - 4	778	.08	.0009	210	.07	.0007
4 - 8	614	.09	.0010	162	.08	.0009
8 - 16	406	.12	.0013	96	.12	.0013
16 - 4	194	.24	.0026	54	.20	.0022
4 - 1	1110	.05	.0005	240	.05	.0005
1 - 1/4	3024	.02	.0002	720	.02	.0002

BORING NO. 41
SAMPLE NO. 7
DEPTH 21.0' to 21.1'
TEST NO. C30.1

SOIL PROPERTIES
SOIL DESCRIPTION: _____
Silty CLAY (CL-CH)
INITIAL WATER CONTENT 38.1 %
ATTERBERG LIMITS
LIQUID LIMIT 47 % PLASTIC LIMIT 24 %

TEST DATA
INITIAL SAMPLE HEIGHT 0.80 IN 2.03 CM.
INITIAL VOID RATIO 1.055 C_c 0.34

**CONSOLIDATION TEST
SUMMARY OF c_v VALUES**
THE DETROIT EDISON COMPANY
BELLE RIVER PLANT UNITS I & II

C-577

APPLIED PRESSURE in tons/ft. ²	SQUARE ROOT FITTING METHOD			LOG FITTING METHOD			BORING NO. <u>41</u>
	t ₉₀ in sec.	ft. ² /day	c _v cm. ² /sec.	t ₅₀ in sec.	ft. ² /day	c _v cm. ² /sec.	
1/4 - 1/2	1500	.05	.0005	420	.04	.0004	SAMPLE NO. <u>13</u>
1/2 - 1	1056	.06	.0006	300	.05	.0005	DEPTH <u>53.0' to 53.2'</u>
1 - 2	738	.08	.0009	240	.06	.0006	TEST NO. <u>C33.1</u>
2 - 4	696	.07	.0008	228	.06	.0006	SOIL PROPERTIES
4 - 8	540	.09	.0010	150	.07	.0008	SOIL DESCRIPTION: _____
8 - 16	504	.08	.0009	108	.09	.0010	<u>Silty CLAY (CL-CH)</u>
24 - 6	378	.10	.0011	90	.10	.0011	INITIAL WATER CONTENT <u>46.5 %</u>
6 - 2	912	.05	.0005	192	.05	.0005	ATTERBERG LIMITS
2 - 1/2	1500	.03	.0003	480	.02	.0002	LIQUID LIMIT <u>52 %</u> PLASTIC LIMIT <u>25 %</u>
							TEST DATA
							INITIAL SAMPLE HEIGHT <u>0.75</u> IN <u>1.905</u> CM.
							INITIAL VOID RATIO <u>1.235</u> C _c <u>0.35</u>

APPLIED PRESSURE in tons/ft. ²	SQUARE ROOT FITTING METHOD			LOG FITTING METHOD			BORING NO. <u>41</u>
	t ₉₀ in sec.	ft. ² /day	c _v cm. ² /sec.	t ₅₀ in sec.	ft. ² /day	c _v cm. ² /sec.	
1/8 - 1/4	1500	.06	.0006	360	.05	.0005	SAMPLE NO. <u>17</u>
1/4 - 1/2	696	.11	.0012	240	.07	.0008	DEPTH <u>73.3'</u>
1/2 - 1	696	.10	.0011	180	.09	.0010	TEST NO. <u>C35.1</u>
1 - 2	468	.15	.0016	168	.10	.0011	SOIL PROPERTIES
2 - 4	318	.21	.0023	120	.13	.0014	SOIL DESCRIPTION: <u>Silty</u>
4 - 1	240	.27	.0029	45	.33	.0036	<u>CLAY, sandy (CL)</u>
1 - 1/4	1008	.07	.0007	228	.07	.0007	INITIAL WATER CONTENT <u>26.7 %</u>
1/4 - 1/2	264	.26	.0028	60	.26	.0028	ATTERBERG LIMITS
1/2 - 1	504	.13	.0014	102	.15	.0016	LIQUID LIMIT <u>25 %</u> PLASTIC LIMIT <u>15 %</u>
1 - 2	174	.38	.0041	78	.20	.0021	TEST DATA
2 - 4	216	.30	.0032	54	.28	.0030	INITIAL SAMPLE HEIGHT <u>0.80</u> IN <u>2.03</u> CM.
4 - 8	348	.18	.0019	96	.15	.0016	INITIAL VOID RATIO <u>.697</u> C _c <u>0.21</u>
8 - 16	348	.17	.0018	72	.19	.0020	CONSOLIDATION TEST SUMMARY OF c_v VALUES THE DETROIT EDISON COMPANY BELLE RIVER PLANT UNITS I & II
16 - 4	138	.40	.0043	36	.35	.0038	
4 - 1	438	.13	.0014	54	.24	.0026	
1 - 1/4	2382	.03	.0003	660	.02	.0002	

APPLIED PRESSURE in tons/ft. ²	SQUARE ROOT FITTING METHOD			LOG FITTING METHOD		
	t ₉₀ in sec.	ft. ² /day	c _v cm. ² /sec.	t ₅₀ in sec.	ft. ² /day	c _v cm. ² /sec.
1/4 - 1/2	540	.13	.0014	210	.07	.0008
1/2 - 1	408	.17	.0018	132	.12	.0013
1 - 2	378	.18	.0019	114	.13	.0014
2 - 4	408	.16	.0017	108	.13	.0014
4 - 8	408	.15	.0016	114	.12	.0013
8 - 16	408	.14	.0015	96	.13	.0014
24 - 6	216	.24	.0026	54	.22	.0024
6 - 2	822	.07	.0007	168	.07	.0008
2 - 1/2	1686	.04	.0004	348	.04	.0004

BORING NO. 41
SAMPLE NO. 25
DEPTH 113'
TEST NO. C38.1

SOIL PROPERTIES

SOIL DESCRIPTION: _____
Silty CLAY, sandy (CL)
INITIAL WATER CONTENT 24.2 %
ATTERBERG LIMITS
LIQUID LIMIT 29 % PLASTIC LIMIT 19 %

TEST DATA

INITIAL SAMPLE HEIGHT 0.75 IN 1.905 CM.
INITIAL VOID RATIO 0.642 C_c 0.18

APPLIED PRESSURE in tons/ft. ²	SQUARE ROOT FITTING METHOD			LOG FITTING METHOD		
	t ₉₀ in sec.	ft. ² /day	c _v cm. ² /sec.	t ₅₀ in sec.	ft. ² /day	c _v cm. ² /sec.
1/4 - 1/2	240	.33	.0036	108	.17	.0018
1/2 - 1	216	.36	.0039	120	.15	.0016
1 - 2	318	.24	.0026	90	.20	.0021
2 - 4	240	.32	.0034	108	.16	.0017
4 - 8	240	.31	.0033	108	.16	.0017
8 - 4	174	.41	.0044	54	.31	.0033
4 - 1	780	.09	.0010	276	.07	.0007
1 - 1/4	1380	.06	.0006	276	.07	.0007
1/4 - 1/2	348	.22	.0024	150	.12	.0013
1/2 - 1	540	.14	.0015	174	.10	.0011
1 - 2	780	.09	.0010	150	.11	.0012
2 - 4	654	.11	.0012	108	.16	.0017
4 - 8	468	.15	.0016	150	.16	.0012
8 - 16	378	.19	.0020	120	.13	.0014
24 - 6	540	.12	.0013	150	.10	.0011
6 - 2	960	.07	.0008	540	.03	.0003
2 - 1/2	1272	.06	.0006	960	.02	.0002

BORING NO. 41
SAMPLE NO. 29
DEPTH 130.9' to 131.1'
TEST NO. C40.1

SOIL PROPERTIES

SOIL DESCRIPTION: _____
Clayey SAND, gravelly (GC-SC)
INITIAL WATER CONTENT 11.3 %
ATTERBERG LIMITS
LIQUID LIMIT 25 % PLASTIC LIMIT 17 %

TEST DATA

INITIAL SAMPLE HEIGHT 0.80 IN 2.03 CM.
INITIAL VOID RATIO 0.370 C_c 0.09

**CONSOLIDATION TEST
SUMMARY OF c_v VALUES**

THE DETROIT EDISON COMPANY
BELLE RIVER PLANT UNITS I & II

APPLIED PRESSURE in tons/ft. ²	SQUARE ROOT FITTING METHOD			LOG FITTING METHOD			BORING NO. <u>48</u>
	t ₉₀ in sec.	ft. ² /day	c _v cm. ² /sec.	t ₉₀ in sec.	ft. ² /day	c _v cm. ² /sec.	
1/4 - 1/2	438	.18	.0019	180	.10	.0011	DEPTH <u>39.2' to 39.4'</u>
1/2 - 1	540	.14	.0015	210	.08	.0009	TEST NO. <u>C202.1</u>
1 - 2	654	.11	.0012	156	.10	.0011	SOIL PROPERTIES SOIL DESCRIPTION: _____ <u>Silty CLAY (CL-CH)</u> INITIAL WATER CONTENT <u>38.8 %</u> ATTERBERG LIMITS LIQUID LIMIT <u>47 %</u> PLASTIC LIMIT <u>24 %</u> TEST DATA INITIAL SAMPLE HEIGHT <u>0.80</u> IN <u>2.03</u> CM. INITIAL VOID RATIO <u>1.027</u> C _c <u>0.33</u>
2 - 1/2	504	.13	.0014	114	.14	.0015	
1/2 - 1/4	1500	.05	.0005	390	.05	.0005	
1/4 - 1/2	576	.13	.0014	138	.12	.0013	
1/2 - 1	468	.15	.0016	138	.12	.0013	
1 - 2	504	.14	.0015	108	.15	.0016	
2 - 4	696	.09	.0010	300	.05	.0005	
4 - 8	654	.09	.0010	174	.08	.0009	
8 - 16	504	.10	.0011	144	.08	.0009	
16 - 2	438	.12	.0013	108	.11	.0012	
2 - 1/2	2232	.03	.0003	540	.11	.0002	
1/2 - 1/8	4440	.01	.0001	1020	.01	.0001	

APPLIED PRESSURE in tons/ft. ²	SQUARE ROOT FITTING METHOD			LOG FITTING METHOD			BORING NO. <u>49</u>
	t ₉₀ in sec.	ft. ² /day	c _v cm. ² /sec.	t ₉₀ in sec.	ft. ² /day	c _v cm. ² /sec.	
1/4 - 1/2	470	.17	.0018	240	.07	.0008	DEPTH <u>13.7' to 14.0'</u>
1/2 - 1	540	.14	.0015	162	.11	.0012	TEST NO. <u>C133.1</u>
1 - 1/4	738	.10	.0011	210	.08	.0009	SOIL PROPERTIES SOIL DESCRIPTION: _____ <u>Silty CLAY (CL-CH)</u> INITIAL WATER CONTENT <u>33.3 %</u> ATTERBERG LIMITS LIQUID LIMIT <u>47 %</u> PLASTIC LIMIT <u>23 %</u> TEST DATA INITIAL SAMPLE HEIGHT <u>0.80</u> IN <u>2.03</u> CM. INITIAL VOID RATIO <u>0.863</u> C _c <u>0.26</u>
1/4 - 1/2	264	.29	.0031	126	.14	.0015	
1/2 - 1	540	.14	.0015	120	.15	.0016	
1 - 2	540	.14	.0015	156	.11	.0012	
2 - 4	540	.13	.0014	156	.10	.0011	
4 - 8	504	.13	.0014	126	.12	.0013	
8 - 16	318	.19	.0020	108	.13	.0014	
16 - 4	318	.18	.0019	66	.20	.0021	
4 - 1	1320	.05	.0005	330	.05	.0005	
1 - 1/4	4620	.01	.0001	1140	.01	.0001	

**CONSOLIDATION TEST
 SUMMARY OF c_v VALUES**
 THE DETROIT EDISON COMPANY
 BELLE RIVER PLANT UNITS I & II

APPLIED PRESSURE in tons/ft. ²	SQUARE ROOT FITTING METHOD			LOG FITTING METHOD			BORING NO. _____ SAMPLE NO. _____ DEPTH _____ TEST NO. _____
	t ₉₀ in sec.	ft. ² /day	c _v cm. ² /sec.	t ₅₀ in sec.	ft. ² /day	c _v cm. ² /sec.	
							SOIL PROPERTIES SOIL DESCRIPTION: _____ INITIAL WATER CONTENT _____ % ATTERBERG LIMITS LIQUID LIMIT _____ % PLASTIC LIMIT _____ %
							TEST DATA INITIAL SAMPLE HEIGHT _____ IN _____ CM. INITIAL VOID RATIO _____ C _c _____

APPLIED PRESSURE in tons/ft. ²	SQUARE ROOT FITTING METHOD			LOG FITTING METHOD			BORING NO. _____ 49 SAMPLE NO. _____ 11 DEPTH _____ 93.8' to 94.0' TEST NO. _____ C141.1
	t ₉₀ in sec.	ft. ² /day	c _v cm. ² /sec.	t ₅₀ in sec.	ft. ² /day	c _v cm. ² /sec.	
1/4 - 1/2	504	.13	.0014	174	.09	.0010	SOIL PROPERTIES SOIL DESCRIPTION: _____ Silty CLAY (CL)
1/2 - 1	504	.13	.0014	132	.11	.0012	INITIAL WATER CONTENT <u>28.6</u> %
1 - 2	348	.19	.0020	96	.16	.0017	ATTERBERG LIMITS
2 - 4	192	.32	.0034	57	.25	.0027	LIQUID LIMIT <u>37</u> % PLASTIC LIMIT <u>22</u> %
4 - 1	264	.22	.0024	48	.29	.0031	TEST DATA
1 - 1/4	780	.07	.0008	168	.08	.0009	INITIAL SAMPLE HEIGHT <u>0.75</u> IN <u>1.905</u> CM.
1/4 - 1/2	288	.22	.0023	66	.22	.0023	INITIAL VOID RATIO <u>0.701</u> C _c <u>0.20</u>
1/2 - 1	318	.20	.0021	84	.17	.0018	
1 - 2	264	.23	.0025	84	.17	.0018	
2 - 4	240	.25	.0027	60	.23	.0025	
4 - 8	264	.22	.0023	72	.19	.0020	
8 - 16	264	.20	.0021	60	.21	.0022	
16 - 4	156	.33	.0035	39	.30	.0032	
4 - 1	738	.07	.0008	120	.10	.0011	
1 - 1/4	2016	.03	.0003	420	.03	.0003	

**CONSOLIDATION TEST
SUMMARY OF c_v VALUES**

THE DETROIT EDISON COMPANY
BELLE RIVER PLANT UNITS I & II

C-581

C-582

APPLIED PRESSURE in tons/ft. ²	SQUARE ROOT FITTING METHOD			LOG FITTING METHOD			BORING NO. _____ SAMPLE NO. _____ DEPTH _____ TEST NO. _____
	t ₉₀ in sec.	ft. ² /day	c _v cm. ² /sec.	t ₅₀ in sec.	ft. ² /day	c _v cm. ² /sec.	
							SOIL PROPERTIES SOIL DESCRIPTION: _____ INITIAL WATER CONTENT _____ % ATTERBERG LIMITS LIQUID LIMIT _____ % PLASTIC LIMIT _____ % TEST DATA INITIAL SAMPLE HEIGHT _____ IN _____ CM. INITIAL VOID RATIO _____ C _c _____

APPLIED PRESSURE in tons/ft. ²	SQUARE ROOT FITTING METHOD			LOG FITTING METHOD		
	t ₉₀ in sec.	ft. ² /day	c _v cm. ² /sec.	t ₅₀ in sec.	ft. ² /day	c _v cm. ² /sec.
1/16 - 1/4	438	.18	.0019	174	.10	.0011
1/4 - 1/2	540	.14	.0015	138	.13	.0014
1/2 - 1	438	.18	.0019	84	.20	.0022
1 - 2	438	.17	.0018	84	.20	.0022
2 - 1	264	.27	.0029	60	.28	.0030
1 - 1/2	576	.13	.0014	156	.11	.0012
1/2 - 1/4	1272	.06	.0006	240	.07	.0008
1/4 - 1/2	240	.31	.0033	60	.29	.0031
1/2 - 1	468	.16	.0017	120	.14	.0015
1 - 2	408	.18	.0019	60	.28	.0030
2 - 4	960	.07	.0007	360	.05	.0005
4 - 8	698	.08	.0009	240	.06	.0006
8 - 16	612	.07	.0008	156	.07	.0007
16 - 4	288	.15	.0016	90	.11	.0012
4 - 1	2538	.02	.0002			
1 - 1/4	4338	.01	.0001			

BORING NO. _____ 50
SAMPLE NO. _____ 8
DEPTH _____ 38.5 - 38.9
TEST NO. _____ C86.1
SOIL PROPERTIES SOIL DESCRIPTION: _____ Silty CLAY (CH) INITIAL WATER CONTENT <u>51.6</u> % ATTERBERG LIMITS LIQUID LIMIT <u>55</u> % PLASTIC LIMIT <u>23</u> % TEST DATA INITIAL SAMPLE HEIGHT <u>0.80</u> IN <u>2.03</u> CM. INITIAL VOID RATIO <u>1.383</u> C _c <u>0.55</u>

**CONSOLIDATION TEST
 SUMMARY OF c_v VALUES**
 THE DETROIT EDISON COMPANY
 BELLE RIVER PLANT UNITS I & II

APPLIED PRESSURE in tons/ft. ²	SQUARE ROOT FITTING METHOD			LOG FITTING METHOD			BORING NO. _____
	t ₉₀ in sec.	ft. ² /day	c _v cm. ² /sec.	t ₅₀ in sec.	ft. ² /day	c _v cm. ² /sec.	
							DEPTH _____
							TEST NO. _____
							SOIL PROPERTIES
							SOIL DESCRIPTION: _____
							INITIAL WATER CONTENT _____ %
							ATTERBERG LIMITS
							LIQUID LIMIT _____ % PLASTIC LIMIT _____ %
							TEST DATA
							INITIAL SAMPLE HEIGHT _____ IN _____ CM.
							INITIAL VOID RATIO _____ C _c _____

APPLIED PRESSURE in tons/ft. ²	SQUARE ROOT FITTING METHOD			LOG FITTING METHOD			BORING NO. _____	
	t ₉₀ in sec.	ft. ² /day	c _v cm. ² /sec.	t ₅₀ in sec.	ft. ² /day	c _v cm. ² /sec.		SAMPLE NO. _____
1/16 - 1/8	378	.21	.0023	150	.12	.0013	DEPTH _____	
1/8 - 1/4	690	.11	.0012	210	.08	.0009	TEST NO. _____	
1/4 - 1/2	576	.13	.0014	168	.10	.0011	SOIL PROPERTIES	
1/2 - 1	378	.20	.0021	90	.20	.0021	SOIL DESCRIPTION: _____	
1 - 2	288	.25	.0027	72	.24	.0026	Silty CLAY (CL-CH)	
2 - 1	288	.25	.0027	51	.33	.0035	INITIAL WATER CONTENT <u>40.5</u> %	
1 - 1/4	780	.09	.0010	144	.12	.0013	ATTERBERG LIMITS	
1/4 - 1/2	348	.21	.0023	114	.15	.0016	LIQUID LIMIT <u>49</u> % PLASTIC LIMIT <u>20</u> %	
1/2 - 1	504	.15	.0016	108	.16	.0017	TEST DATA	
1 - 2	378	.19	.0020	60	.28	.0030	INITIAL SAMPLE HEIGHT <u>0.80</u> IN <u>2.03</u> CM.	
2 - 4	648	.10	.0011	156	.10	.0011	INITIAL VOID RATIO <u>1.013</u> C _c <u>0.45</u>	
4 - 8	540	.11	.0012	156	.08	.0009	CONSOLIDATION TEST SUMMARY OF c_v VALUES	
8 - 16	624	.07	.0008	120	.09	.0010		THE DETROIT EDISON COMPANY BELLE RIVER PLANT UNITS I & II
16 - 4	318	.15	.0016	84	.13	.0014		
4 - 1	1164	.05	.0005	312	.04	.0004		
1 - 1/4	3744	.02	.0002	840	.02	.0002		

C-583

C-584

APPLIED PRESSURE in tons/ft. ²	SQUARE ROOT FITTING METHOD			LOG FITTING METHOD		
	t ₉₀ in sec.	ft. ² /day	c _v cm. ² /sec.	t ₅₀ in sec.	ft. ² /day	c _v cm. ² /sec.
1/4 - 1/2	504	.16	.0017	72	.25	.0027
1/2 - 1	438	.18	.0019	114	.16	.0017
1 - 2	288	.26	.0028	43	.40	.0043
2 - 4	240	.29	.0031	60	.27	.0029
4 - 8	264	.24	.0026	45	.33	.0035
8 - 16	240	.23	.0025	36	.35	.0038
16 - 4	138	.38	.0041	18	.68	.0073
4 - 1	654	.08	.0009	144	.09	.0010
1 - 1/4	2616	.02	.0002	600	.02	.0002

BORING NO. 53
 SAMPLE NO. 5
 DEPTH 39.5'-39.8'
 TEST NO. C98.1

SOIL PROPERTIES
 SOIL DESCRIPTION: Silty CLAY, Sandy (CL)
 INITIAL WATER CONTENT 30.9%
 ATTERBERG LIMITS
 LIQUID LIMIT 39% PLASTIC LIMIT 20%

TEST DATA
 INITIAL SAMPLE HEIGHT 0.80 IN 2.03 CM.
 INITIAL VOID RATIO .872 C_c 0.35

APPLIED PRESSURE in tons/ft. ²	SQUARE ROOT FITTING METHOD			LOG FITTING METHOD		
	t ₉₀ in sec.	ft. ² /day	c _v cm. ² /sec.	t ₅₀ in sec.	ft. ² /day	c _v cm. ² /sec.

BORING NO. _____
 SAMPLE NO. _____
 DEPTH _____
 TEST NO. _____

SOIL PROPERTIES
 SOIL DESCRIPTION: _____
 INITIAL WATER CONTENT _____ %
 ATTERBERG LIMITS
 LIQUID LIMIT _____ % PLASTIC LIMIT _____ %

TEST DATA
 INITIAL SAMPLE HEIGHT _____ IN _____ CM.
 INITIAL VOID RATIO _____ C_c _____

**CONSOLIDATION TEST
 SUMMARY OF c_v VALUES**
 THE DETROIT EDISON COMPANY
 BELLE RIVER PLANT UNITS I & II

APPLIED PRESSURE in tons/ft. ²	SQUARE ROOT FITTING METHOD			LOG FITTING METHOD		
	t ₉₀ in sec.	ft. ² /day	c _v cm. ² /sec.	t ₅₀ in sec.	ft. ² /day	c _v cm. ² /sec.
1/4 - 1/2	540	.15	.0016	216	.08	.0009
1/2 - 1	438	.18	.0019	216	.08	.0009
1 - 2	540	.14	.0015	132	.13	.0014
2 - 4	438	.16	.0017	114	.14	.0015
4 - 8	408	.16	.0017	84	.18	.0019
8 - 16	348	.18	.0019	84	.17	.0018
16 - 4	348	.17	.0018	27		
4 - 1	1008	.06	.0006	144	.10	.0011
1 - 1/4	2304	.03	.0003	540	.03	.0003

BORING NO. 54
SAMPLE NO. 6
DEPTH 63.5' - 63.8'
TEST NO. C399.1

SOIL PROPERTIES
SOIL DESCRIPTION: Silty CLAY, sandy (CL)
INITIAL WATER CONTENT 26.0 %
ATTERBERG LIMITS
LIQUID LIMIT 36 % PLASTIC LIMIT 18 %

TEST DATA
INITIAL SAMPLE HEIGHT 0.80 IN 2.03 CM.
INITIAL VOID RATIO 0.696 C_c 0.24

APPLIED PRESSURE in tons/ft. ²	SQUARE ROOT FITTING METHOD			LOG FITTING METHOD		
	t ₉₀ in sec.	ft. ² /day	c _v cm. ² /sec.	t ₅₀ in sec.	ft. ² /day	c _v cm. ² /sec.

BORING NO. _____
SAMPLE NO. _____
DEPTH _____
TEST NO. _____

SOIL PROPERTIES
SOIL DESCRIPTION: _____
INITIAL WATER CONTENT _____ %
ATTERBERG LIMITS
LIQUID LIMIT _____ % PLASTIC LIMIT _____ %

TEST DATA
INITIAL SAMPLE HEIGHT _____ IN _____ CM.
INITIAL VOID RATIO _____ C_c _____

**CONSOLIDATION TEST
SUMMARY OF c_v VALUES**
THE DETROIT EDISON COMPANY
BELLE RIVER PLANT UNITS I & II

C-585

C-586

APPLIED PRESSURE in tons/ft. ²	SQUARE ROOT FITTING METHOD			LOG FITTING METHOD		
	t ₉₀ in sec.	ft. ² /day	c _v cm. ² /sec.	t ₅₀ in sec.	ft. ² /day	c _v cm. ² /sec.
1/4 - 1/2	540	.15	.0016	156	.12	.0013
1/2 - 1	540	.14	.0015	102	.18	.0019
1 - 2	408	.19	.0020	96	.18	.0019
2 - 4	348	.20	.0022	108	.15	.0016
4 - 8	438	.14	.0015	120	.12	.0013
8 - 16	318	.17	.0018	96	.13	.0014
16 - 4	216	.23	.0025	45	.26	.0028
4 - 1	576	.09	.0010	240	.06	.0006
1 - 1/4	2160	.03	.0003	570	.03	.0003

BORING NO. 54
 SAMPLE NO. 8
 DEPTH 73.7' - 74.0'
 TEST NO. C401.1

SOIL PROPERTIES
 SOIL DESCRIPTION: Silty CLAY (CL)
 INITIAL WATER CONTENT 38.3 %
 ATTERBERG LIMITS
 LIQUID LIMIT 45 % PLASTIC LIMIT 21 %

TEST DATA
 INITIAL SAMPLE HEIGHT 0.80 IN 2.03 CM.
 INITIAL VOID RATIO 0.982 C_c 0.41

APPLIED PRESSURE in tons/ft. ²	SQUARE ROOT FITTING METHOD			LOG FITTING METHOD		
	t ₉₀ in sec.	ft. ² /day	c _v cm. ² /sec.	t ₅₀ in sec.	ft. ² /day	c _v cm. ² /sec.

BORING NO. _____
 SAMPLE NO. _____
 DEPTH _____
 TEST NO. _____

SOIL PROPERTIES
 SOIL DESCRIPTION: _____
 INITIAL WATER CONTENT _____ %
 ATTERBERG LIMITS
 LIQUID LIMIT _____ % PLASTIC LIMIT _____ %

TEST DATA
 INITIAL SAMPLE HEIGHT _____ IN _____ CM.
 INITIAL VOID RATIO _____ C_c _____

**CONSOLIDATION TEST
 SUMMARY OF c_v VALUES**
 THE DETROIT EDISON COMPANY
 BELLE RIVER PLANT UNITS I & II

APPLIED PRESSURE in tons/ft. ²	SQUARE ROOT FITTING METHOD			LOG FITTING METHOD			BORING NO. <u>60</u>
	t ₉₀ in sec.	ft. ² /day	c _v cm. ² /sec.	t ₅₀ in sec.	ft. ² /day	c _v cm. ² /sec.	
1/4 - 1/2	348	.23	.0025	114	.16	.0017	SAMPLE NO. <u>2</u>
1/2 - 1	654	.12	.0013	216	.08	.0009	DEPTH <u>9.8' to 10.0'</u>
1 - 1/4	1560	.05	.0005	330	.06	.0006	TEST NO. <u>C42.1</u>
1/4 - 1/2	318	.24	.0026	180	.10	.0011	SOIL PROPERTIES
1/2 - 1	774	.10	.0011	270	.07	.0007	SOIL DESCRIPTION: _____
1 - 2	468	.16	.0017	180	.09	.0010	<u>Silty CLAY (CL-CH)</u>
2 - 4	576	.12	.0013	168	.10	.0011	INITIAL WATER CONTENT <u>30.0%</u>
4 - 8	540	.12	.0013	156	.10	.0011	ATTERBERG LIMITS
8 - 16	318	.20	.0021	132	.11	.0012	LIQUID LIMIT <u>53%</u> PLASTIC LIMIT <u>26%</u>
24 - 6	318	.18	.0019	72	.19	.0020	TEST DATA
6 - 2	1218	.05	.0005	420	.04	.0004	INITIAL SAMPLE HEIGHT <u>0.80</u> IN <u>2.03</u> CM.
2 - 1/2	3378	.02	.0002	960	.02	.0002	INITIAL VOID RATIO <u>0.787</u> C _c <u>0.23</u>

APPLIED PRESSURE in tons/ft. ²	SQUARE ROOT FITTING METHOD			LOG FITTING METHOD			BORING NO. <u>60</u>
	t ₉₀ in sec.	ft. ² /day	c _v cm. ² /sec.	t ₅₀ in sec.	ft. ² /day	c _v cm. ² /sec.	
1/4 - 1/2	240	.33	.0035	90	.20	.0022	SAMPLE NO. <u>16</u>
1/2 - 1	240	.33	.0035	78	.23	.0025	DEPTH <u>85.2' to 85.4'</u>
1 - 2	192	.39	.0042	54	.33	.0035	TEST NO. <u>C56.1</u>
2 - 4	264	.28	.0030	72	.23	.0025	SOIL PROPERTIES
4 - 8	264	.26	.0028	84	.19	.0020	SOIL DESCRIPTION: _____
8 - 16	348	.18	.0019	84	.17	.0018	<u>Silty CLAY (CL)</u>
16 - 4	156	.37	.0040	51	.26	.0028	INITIAL WATER CONTENT <u>27.9%</u>
4 - 1	864	.07	.0008	210	.07	.0007	ATTERBERG LIMITS
1 - 1/4	2400	.03	.0003	450	.04	.0004	LIQUID LIMIT <u>40%</u> PLASTIC LIMIT <u>19%</u>
							TEST DATA
							INITIAL SAMPLE HEIGHT <u>0.80</u> IN <u>2.03</u> CM.
							INITIAL VOID RATIO <u>0.744</u> C _c <u>0.27</u>

**CONSOLIDATION TEST
SUMMARY OF c_v VALUES**

THE DETROIT EDISON COMPANY
BELLE RIVER PLANT UNITS I & II

C-587

APPLIED PRESSURE in tons/ft. ²	SQUARE ROOT FITTING METHOD			LOG FITTING METHOD			BORING NO. _____	SAMPLE NO. _____	DEPTH _____	TEST NO. _____
	t ₉₀ in sec.	ft. ² /day	c _v cm. ² /sec.	t ₅₀ in sec.	ft. ² /day	c _v cm. ² /sec.				

SOIL PROPERTIES
 SOIL DESCRIPTION: _____
 INITIAL WATER CONTENT _____ %
 ATTERBERG LIMITS
 LIQUID LIMIT _____ % PLASTIC LIMIT _____ %

TEST DATA
 INITIAL SAMPLE HEIGHT _____ IN _____ CM.
 INITIAL VOID RATIO _____ C_c _____

APPLIED PRESSURE in tons/ft. ²	SQUARE ROOT FITTING METHOD			LOG FITTING METHOD			BORING NO. _____	SAMPLE NO. _____	DEPTH _____	TEST NO. _____
	t ₉₀ in sec.	ft. ² /day	c _v cm. ² /sec.	t ₅₀ in sec.	ft. ² /day	c _v cm. ² /sec.				
1/4 - 1/2	408	.20	.0021	138	.14	.0014	105	8	70.9 - 71.2	C380.1
1/2 - 1	318	.24	.0026	96	.19	.0020				
1 - 2	318	.24	.0026	102	.17	.0018				
2 - 4	408	.18	.0019	90	.19	.0020				
4 - 8	438	.16	.0017	114	.14	.0015				
8 - 16	318	.20	.0021	96	.15	.0016				
16 - 4	318	.20	.0021	72	.20	.0021				
4 - 1	774	.08	.0008	180	.09	.0009				
1 - 1/4	2454	.03	.0003	480	.03	.0003				

SOIL PROPERTIES
 SOIL DESCRIPTION: _____
 Silty CLAY (CL)
 INITIAL WATER CONTENT 23.7 %
 ATTERBERG LIMITS
 LIQUID LIMIT 37 % PLASTIC LIMIT 19 %

TEST DATA
 INITIAL SAMPLE HEIGHT 0.80 IN 2.03 CM.
 INITIAL VOID RATIO 0.625 C_c 0.21

**CONSOLIDATION TEST
 SUMMARY OF c_v VALUES**
 THE DETROIT EDISON COMPANY
 BELLE RIVER PLANT UNITS I & II

APPLIED PRESSURE in tons/ft. ²	SQUARE ROOT FITTING METHOD			LOG FITTING METHOD			BORING NO. _____ SAMPLE NO. _____ DEPTH _____ TEST NO. _____
	t ₉₀ in sec.	ft. ² /day	c _v cm. ² /sec.	t ₅₀ in sec.	ft. ² /day	c _v cm. ² /sec.	
							<u>SOIL PROPERTIES</u> SOIL DESCRIPTION: _____ INITIAL WATER CONTENT _____ % ATTERBERG LIMITS LIQUID LIMIT _____ % PLASTIC LIMIT _____ % <u>TEST DATA</u> INITIAL SAMPLE HEIGHT _____ IN _____ CM. INITIAL VOID RATIO _____ C _c _____

APPLIED PRESSURE in tons/ft. ²	SQUARE ROOT FITTING METHOD			LOG FITTING METHOD			BORING NO. _____ 118 SAMPLE NO. _____ 5 DEPTH _____ 38.9' - 39.3' TEST NO. _____ C256.1
	t ₉₀ in sec.	ft. ² /day	c _v cm. ² /sec.	t ₅₀ in sec.	ft. ² /day	c _v cm. ² /sec.	
1/4 - 1/2	540	.15	.0016	156	.13	.0013	<u>SOIL PROPERTIES</u> SOIL DESCRIPTION: _____ <u>Silty CLAY (CL)</u> INITIAL WATER CONTENT <u>36.9</u> % ATTERBERG LIMITS LIQUID LIMIT <u>41</u> % PLASTIC LIMIT <u>22</u> % <u>TEST DATA</u> INITIAL SAMPLE HEIGHT <u>0.80</u> IN <u>2.03</u> CM. INITIAL VOID RATIO <u>0.969</u> C _c <u>0.39</u>
1/2 - 1	378	.21	.0022	108	.17	.0018	
1 - 2	264	.28	.0030	84	.21	.0022	
2 - 1/2	264	.28	.0030	72	.24	.0026	
1/2 - 1/4	468	.16	.0017	132	.13	.0014	
1/4 - 1/2	240	.31	.0034	78	.22	.0024	
1/2 - 1	318	.24	.0025	72	.24	.0026	
1 - 2	174	.42	.0045	45	.38	.0041	
2 - 4	576	.12	.0013	192	.09	.0009	
4 - 8	654	.10	.0010	138	.11	.0011	
8 - 16	378	.14	.0014	102	.12	.0013	
16 - 4	102	.51	.0053	42	.28	.0030	
4 - 1	816	.07	.0007	240	.05	.0005	
1 - 1/4	2856	.02	.0002	780	.02	.0002	

**CONSOLIDATION TEST
SUMMARY OF c_v VALUES**

THE DETROIT EDISON COMPANY
BELLE RIVER PLANT UNITS I & II

C-589

C-590

APPLIED PRESSURE in tons/ft. ²	SQUARE ROOT FITTING METHOD			LOG FITTING METHOD			BORING NO. _____	SAMPLE NO. _____	DEPTH _____	TEST NO. _____
	t ₉₀ in sec.	ft. ² /day	c _v cm. ² /sec.	t ₅₀ in sec.	ft. ² /day	c _v cm. ² /sec.				

SOIL PROPERTIES
 SOIL DESCRIPTION: _____
 INITIAL WATER CONTENT _____ %
 ATTERBERG LIMITS
 LIQUID LIMIT _____ % PLASTIC LIMIT _____ %

TEST DATA
 INITIAL SAMPLE HEIGHT _____ IN _____ CM.
 INITIAL VOID RATIO _____ C_c _____

APPLIED PRESSURE in tons/ft. ²	SQUARE ROOT FITTING METHOD			LOG FITTING METHOD			BORING NO. _____ 118	SAMPLE NO. _____ 9	DEPTH _____ 78.7' - 79.0'	TEST NO. _____ C260.1
	t ₉₀ in sec.	ft. ² /day	c _v cm. ² /sec.	t ₅₀ in sec.	ft. ² /day	c _v cm. ² /sec.				
1/4 - 1/2	540	.15	.0016	186	.11	.0011				
1/2 - 1	540	.15	.0016	138	.13	.0014				
1 - 2	378	.20	.0022	114	.16	.0017				
2 - 4	348	.21	.0023	96	.18	.0019				
4 - 1	318	.22	.0025	72	.23	.0025				
1 - 1/4	1008	.08	.0008	288	.06	.0006				
1/4 - 1/2	240	.31	.0034	78	.22	.0024				
1/2 - 1	288	.26	.0028	84	.21	.0022				
1 - 2	408	.19	.0020	108	.16	.0017				
2 - 4	264	.28	.0030	66	.25	.0027				
4 - 8	264	.26	.0028	90	.18	.0019				
8 - 16	348	.20	.0022	96	.17	.0017				
16 - 4	216	.28	.0031	48	.30	.0032				
4 - 1	738	.09	.0009	228	.07	.0007				
1 - 1/4	3198	.02	.0002	630	.03	.0003				

SOIL PROPERTIES
 SOIL DESCRIPTION: _____
Silty CLAY (CL)
 INITIAL WATER CONTENT 27.8%
 ATTERBERG LIMITS
 LIQUID LIMIT 42% PLASTIC LIMIT 23%

TEST DATA
 INITIAL SAMPLE HEIGHT 0.80 IN 2.03 CM.
 INITIAL VOID RATIO 0.741 C_c 0.24

**CONSOLIDATION TEST
 SUMMARY OF c_v VALUES**
 THE DETROIT EDISON COMPANY
 BELLE RIVER PLANT UNITS I & II

APPLIED PRESSURE in tons/ft. ²	SQUARE ROOT FITTING METHOD			LOG FITTING METHOD			BORING NO. _____ SAMPLE NO. _____ DEPTH _____ TEST NO. _____
	t ₉₀ in sec.	ft. ² /day	c _v cm. ² /sec.	t ₅₀ in sec.	ft. ² /day	c _v cm. ² /sec.	
							SOIL PROPERTIES SOIL DESCRIPTION: _____ INITIAL WATER CONTENT _____ % ATTERBERG LIMITS LIQUID LIMIT _____ % PLASTIC LIMIT _____ % TEST DATA INITIAL SAMPLE HEIGHT _____ IN _____ CM. INITIAL VOID RATIO _____ C _c _____

APPLIED PRESSURE in tons/ft. ²	SQUARE ROOT FITTING METHOD			LOG FITTING METHOD			BORING NO. _____ SAMPLE NO. _____ DEPTH _____ TEST NO. _____
	t ₉₀ in sec.	ft. ² /day	c _v cm. ² /sec.	t ₅₀ in sec.	ft. ² /day	c _v cm. ² /sec.	
							BORING NO. _____ 129 SAMPLE NO. _____ 9 DEPTH _____ 39.1' - 39.3' TEST NO. _____ C389 SOIL PROPERTIES SOIL DESCRIPTION: _____ <u>Silty CLAY (CL)</u> INITIAL WATER CONTENT <u>40.2</u> % ATTERBERG LIMITS LIQUID LIMIT <u>41</u> % PLASTIC LIMIT <u>22</u> % TEST DATA INITIAL SAMPLE HEIGHT <u>0.80</u> IN <u>2.03</u> CM. INITIAL VOID RATIO <u>1.083</u> C _c <u>0.39</u>
1/4 - 1/2	540	.14	.0015	180	.11	.0011	CONSOLIDATION TEST SUMMARY OF c_v VALUES THE DETROIT EDISON COMPANY BELLE RIVER PLANT UNITS I & II
1/2 - 1	468	.16	.0017	156	.12	.0012	
1 - 2	780	.10	.0010	216	.08	.0008	
2 - 1/2	438	.16	.0017	96	.17	.0018	
1/2 - 1/4	1110	.07	.0007	270	.07	.0007	
1/4 - 1/2	540	.13	.0014	144	.12	.0012	
1/2 - 1	318	.22	.0024	102	.16	.0017	
1 - 2	264	.26	.0028	78	.20	.0022	
2 - 4	738	.09	.0009	186	.08	.0008	
4 - 8	738	.08	.0008	168	.08	.0008	
8 - 16	540	.10	.0010	132	.09	.0009	
16 - 4	288	.17	.0018	72	.15	.0016	
4 - 1	1056	.05	.0005	264	.05	.0005	
1 - 1/4	2779	.02	.0002	840	.01	.0001	

C-591

C-592

APPLIED PRESSURE in tons/ft. ²	SQUARE ROOT FITTING METHOD			LOG FITTING METHOD			BORING NO. _____	SAMPLE NO. _____	DEPTH _____	TEST NO. _____
	t ₉₀ in sec.	ft. ² /day	c _v cm. ² /sec.	t ₅₀ in sec.	ft. ² /day	c _v cm. ² /sec.				

SOIL PROPERTIES
 SOIL DESCRIPTION: _____
 INITIAL WATER CONTENT _____ %
 ATTERBERG LIMITS
 LIQUID LIMIT _____ % PLASTIC LIMIT _____ %

TEST DATA
 INITIAL SAMPLE HEIGHT _____ IN _____ CM.
 INITIAL VOID RATIO _____ C_c _____

APPLIED PRESSURE in tons/ft. ²	SQUARE ROOT FITTING METHOD			LOG FITTING METHOD		
	t ₉₀ in sec.	ft. ² /day	c _v cm. ² /sec.	t ₅₀ in sec.	ft. ² /day	c _v cm. ² /sec.
1/4 - 1/2	348	.22	.0024	108	.17	.0018
1/2 - 1	378	.20	.0022	120	.15	.0016
1 - 2	318	.23	.0026	96	.19	.0020
2 - 4	438	.17	.0018	96	.18	.0019
4 - 1	288	.24	.0027	51	.32	.0035
1 - 1/4	540	.14	.0015	192	.09	.0009
1/4 - 1/2	288	.26	.0028	78	.22	.0024
1/2 - 1	432	.17	.0018	96	.22	.0024
1 - 2	240	.30	.0033	72	.23	.0025
2 - 4	240	.29	.0032	60	.28	.0030
4 - 8	438	.16	.0016	90	.18	.0019
8 - 16	288	.21	.0023	78	.19	.0020
16 - 4	120	.48	.0053	30	.47	.0050
4 - 1	780	.09	.0009	186	.08	.0008
1 - 1/4	2265	.02	.0002	480	.03	.0003

BORING NO. 129
 SAMPLE NO. 21
 DEPTH 103.7 - 104.0
 TEST NO. C395.1

SOIL PROPERTIES
 SOIL DESCRIPTION: Silty CLAY, Sandy (CL)
 INITIAL WATER CONTENT 28.0 %
 ATTERBERG LIMITS
 LIQUID LIMIT 39 % PLASTIC LIMIT 21 %

TEST DATA
 INITIAL SAMPLE HEIGHT 0.80 IN 2.03 CM.
 INITIAL VOID RATIO 0.730 C_c .23

**CONSOLIDATION TEST
 SUMMARY OF c_v VALUES**
 THE DETROIT EDISON COMPANY
 BELLE RIVER PLANT UNITS I & II

APPLIED PRESSURE in tons/ft. ²	SQUARE ROOT FITTING METHOD			LOG FITTING METHOD		
	t ₉₀ in sec.	ft. ² /day	c _v cm. ² /sec.	t ₅₀ in sec.	ft. ² /day	c _v cm. ² /sec.
1/4 - 1/2	135		.0052	72		.0023
1/2 - 1	317		.0022	102		.0016
1 - 2	1009		.0007	348		.0005
2 - 4	913		.0007	270		.0006
4 - 8	738		.0008	216		.0007
8 - 16	778		.0007	180		.0007
16 - 4	346		.0016	66		.0020
4 - 1	960		.0006	330		.0004
1 - 1/4	4338		.0001	1440		.0001

BORING NO. 136
SAMPLE NO. ST6
DEPTH 13.0' to 16.0'
TEST NO. C527.1

SOIL PROPERTIES
SOIL DESCRIPTION: SILTY CLAY (CL)
INITIAL WATER CONTENT 17.3 %
ATTERBERG LIMITS
LIQUID LIMIT 43 % PLASTIC LIMIT 22 %

TEST DATA
INITIAL SAMPLE HEIGHT 3.28 IN 8.33 CM.
INITIAL VOID RATIO (0.675) C_c 0.15

APPLIED PRESSURE in tons/ft. ²	SQUARE ROOT FITTING METHOD			LOG FITTING METHOD		
	t ₉₀ in sec.	ft. ² /day	c _v cm. ² /sec.	t ₅₀ in sec.	ft. ² /day	c _v cm. ² /sec.

BORING NO. _____
SAMPLE NO. _____
DEPTH _____
TEST NO. _____

SOIL PROPERTIES
SOIL DESCRIPTION: _____
INITIAL WATER CONTENT _____ %
ATTERBERG LIMITS
LIQUID LIMIT _____ % PLASTIC LIMIT _____ %

TEST DATA
INITIAL SAMPLE HEIGHT _____ IN _____ CM.
INITIAL VOID RATIO _____ C_c _____

**CONSOLIDATION TEST
SUMMARY OF c_v VALUES**
THE DETROIT EDISON COMPANY
BELLE RIVER PLANT UNITS I & II

C-593

C-594

APPLIED PRESSURE in tons/ft. ²	SQUARE ROOT FITTING METHOD			LOG FITTING METHOD		
	t ₉₀ in sec.	ft. ² /day	c _v cm. ² /sec.	t ₅₀ in sec.	ft. ² /day	c _v cm. ² /sec.

BORING NO. _____
 SAMPLE NO. _____
 DEPTH _____
 TEST NO. _____

SOIL PROPERTIES
 SOIL DESCRIPTION: _____

 INITIAL WATER CONTENT _____ %
 ATTERBERG LIMITS
 LIQUID LIMIT _____ % PLASTIC LIMIT _____ %

TEST DATA
 INITIAL SAMPLE HEIGHT _____ IN _____ CM.
 INITIAL VOID RATIO _____ C_c _____

APPLIED PRESSURE in tons/ft. ²	SQUARE ROOT FITTING METHOD			LOG FITTING METHOD		
	t ₉₀ in sec.	ft. ² /day	c _v cm. ² /sec.	t ₅₀ in sec.	ft. ² /day	c _v cm. ² /sec.
1/4-1/2	378	.21	.0022	84	.21	.0023
1/2-1	504	.15	.0016	114	.17	.0017
1 - 2	576	.14	.0014	150	.12	.0012
2 - 1	812	.09	.0009	180	.10	.0010
1 - 1/4	72	1.0	.0105	36	.50	.0050
1/4-1/2	288	.25	.0027	108	.17	.0017
1/2-1	345	.21	.0022	108	.17	.0017
1 - 2	318	.23	.0024	102	.17	.0017
2 - 4	696	.10	.0010	186	.09	.0009
4 - 8	378	.17	.0017	108	.13	.0013
8 - 16	290	.19	.0020	72	.17	.0017

BORING NO. 142
 SAMPLE NO. 6
 DEPTH 20.1' to 20.5'
 TEST NO. C535.1

SOIL PROPERTIES
 SOIL DESCRIPTION: Silty CLAY (CL)

 INITIAL WATER CONTENT 38.2%
 ATTERBERG LIMITS
 LIQUID LIMIT 45% PLASTIC LIMIT 22%

TEST DATA
 INITIAL SAMPLE HEIGHT 0.80 IN 2.03 CM.
 INITIAL VOID RATIO 1.019 C_c 0.41

**CONSOLIDATION TEST
 SUMMARY OF c_v VALUES**
 THE DETROIT EDISON COMPANY
 BELLE RIVER PLANT UNITS I & II

APPLIED PRESSURE in tons/ft. ²	SQUARE ROOT FITTING METHOD			LOG FITTING METHOD		
	t ₉₀ in sec.	ft. ² /day	c _v cm. ² /sec.	t ₅₀ in sec.	ft. ² /day	c _v cm. ² /sec.
1/2 - 1	540	.12	.0013	228	.07	.0007
1 - 2	1440	.05	.0005	408	.04	.0004
2 - 4	1272	.05	.0005	306	.05	.0005
4 - 8	612	.09	.0010	216	.07	.0007
8 - 16	540	.10	.0011	150	.08	.0009
16 - 4	438	.12	.0013	96	.13	.0014
4 - 1	1752	.03	.0003	450	.03	.0003
1 - 1/4				1560	.01	.0001

BORING NO. 146
SAMPLE NO. 7
DEPTH 14.0' to 16.0'
TEST NO. C542.1

SOIL PROPERTIES
SOIL DESCRIPTION: _____
SILTY CLAY (CL)
INITIAL WATER CONTENT 15.9 %
ATTERBERG LIMITS
LIQUID LIMIT 46 % PLASTIC LIMIT 22 %

TEST DATA
INITIAL SAMPLE HEIGHT 0.75 IN 1.905 CM.
INITIAL VOID RATIO 0.679 C_c 0.14

APPLIED PRESSURE in tons/ft. ²	SQUARE ROOT FITTING METHOD			LOG FITTING METHOD		
	t ₉₀ in sec.	ft. ² /day	c _v cm. ² /sec.	t ₅₀ in sec.	ft. ² /day	c _v cm. ² /sec.

BORING NO. _____
SAMPLE NO. _____
DEPTH _____
TEST NO. _____

SOIL PROPERTIES
SOIL DESCRIPTION: _____
INITIAL WATER CONTENT _____ %
ATTERBERG LIMITS
LIQUID LIMIT _____ % PLASTIC LIMIT _____ %

TEST DATA
INITIAL SAMPLE HEIGHT _____ IN _____ CM.
INITIAL VOID RATIO _____ C_c _____

**CONSOLIDATION TEST
SUMMARY OF c_v VALUES**
THE DETROIT EDISON COMPANY
BELLE RIVER PLANT UNITS I & II

C-595

C-596

APPLIED PRESSURE in tons/ft. ²	SQUARE ROOT FITTING METHOD			LOG FITTING METHOD		
	t ₉₀ in sec.	ft. ² /day c _v	cm. ² /sec.	t ₅₀ in sec.	ft. ² /day c _v	cm. ² /sec.
1/4-1/2	194	.43	.0045	72	.26	.0028
1/2- 1	317	.25	.0027	96	.20	.0021
1 - 2	378	.21	.0022	96	.19	.0020
2 - 4	345	.23	.0024	72	.24	.0026
4 - 8	378	.19	.0020	84	.21	.0022
8-16	324	.20	.0021	108	.16	.0016

BORING NO. 185
 SAMPLE NO. 3
 DEPTH 7.9' to 8.1'
 TEST NO. C552.1

SOIL PROPERTIES
 SOIL DESCRIPTION: Silty CLAY (CL-CH)
 INITIAL WATER CONTENT 29.1%
 ATTERBERG LIMITS
 LIQUID LIMIT 50% PLASTIC LIMIT 23%

TEST DATA
 INITIAL SAMPLE HEIGHT 0.80 IN 2.03 CM.
 INITIAL VOID RATIO 0.757 C_c 0.18

APPLIED PRESSURE in tons/ft. ²	SQUARE ROOT FITTING METHOD			LOG FITTING METHOD		
	t ₉₀ in sec.	ft. ² /day c _v	cm. ² /sec.	t ₅₀ in sec.	ft. ² /day c _v	cm. ² /sec.

BORING NO. _____
 SAMPLE NO. _____
 DEPTH _____
 TEST NO. _____

SOIL PROPERTIES
 SOIL DESCRIPTION: _____
 INITIAL WATER CONTENT _____ %
 ATTERBERG LIMITS
 LIQUID LIMIT _____ % PLASTIC LIMIT _____ %

TEST DATA
 INITIAL SAMPLE HEIGHT _____ IN _____ CM.
 INITIAL VOID RATIO _____ C_c _____

**CONSOLIDATION TEST
 SUMMARY OF c_v VALUES**
 THE DETROIT EDISON COMPANY
 BELLE RIVER PLANT UNITS I & II

GRAIN SIZE DISTRIBUTION

U.S. STANDARD SIEVE SIZE

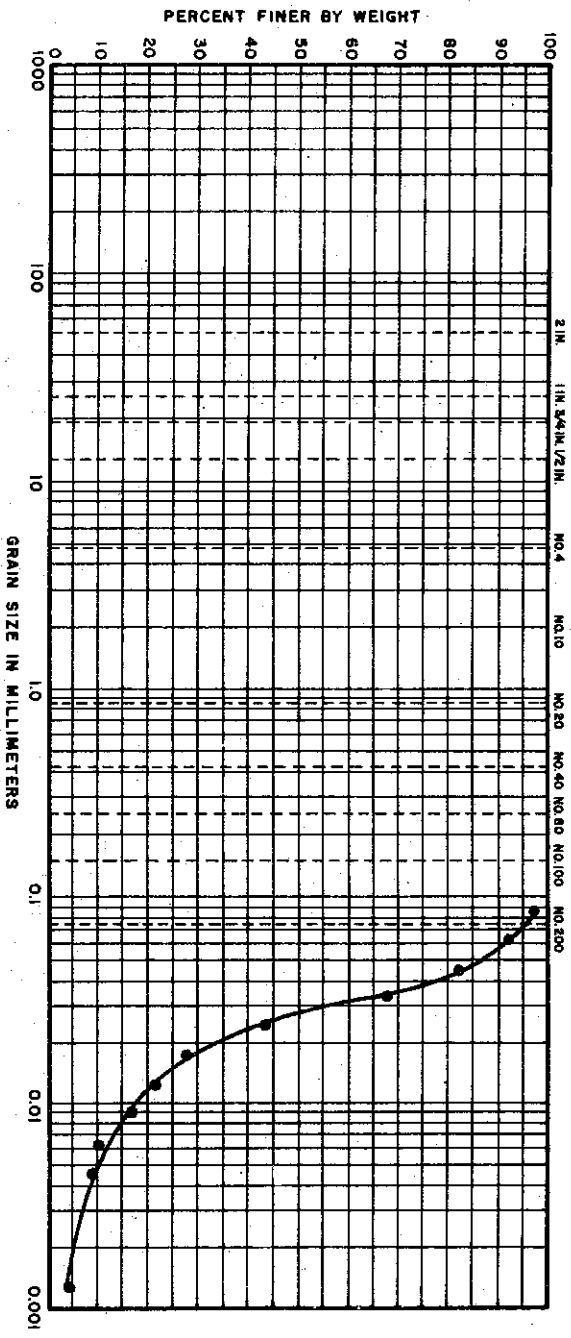

COBBLES	GRAVEL		SAND			SILT OR CLAY
	COARSE	FINE	COARSE	MEDIUM	FINE	

UNIFIED SOIL CLASSIFICATION SYSTEM

PLASTICITY CHART (COHESIVE SOIL ONLY)

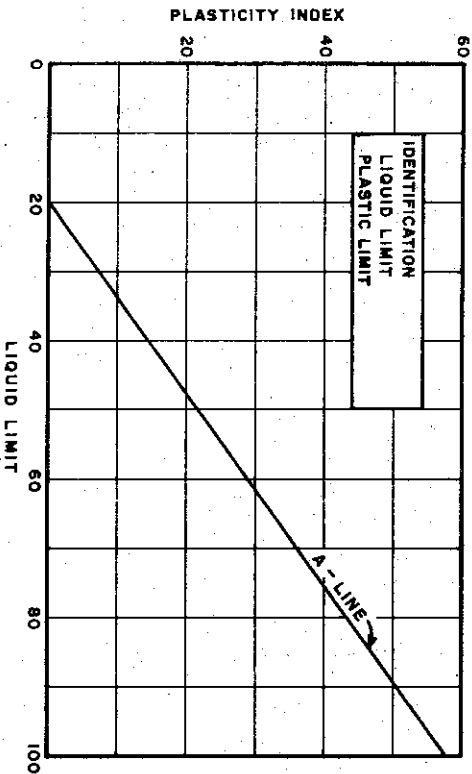

MATERIAL SOURCE

IDENTIFICATION : CLAYEY SILT (CL-ML)

EXPLORATION: BORING 7

SAMPLE : SS28

DEPTH : 129.6' TO 131.0'

SPECIFIC GRAVITY : USED 2.70

THE DETROIT EDISON COMPANY
BELLE RIVER PLANT UNITS I & II
SOIL CLASSIFICATION TESTS

FILE NO. 1255 DATE JAN. 74

GRAIN SIZE DISTRIBUTION

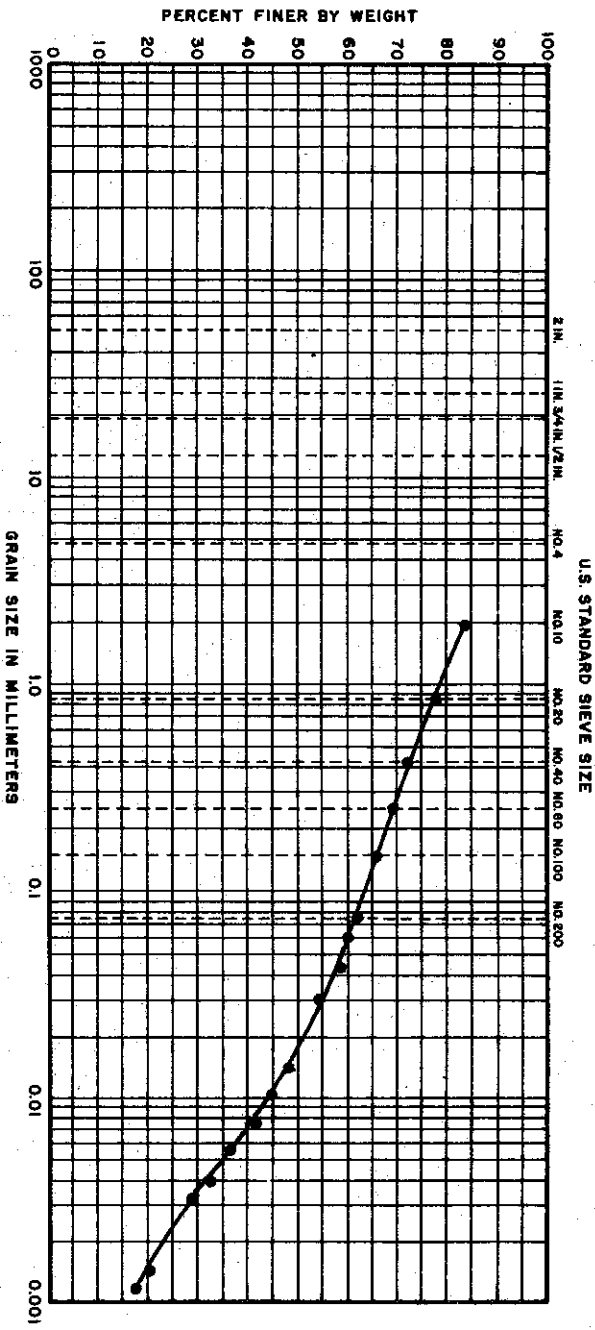

COBBLES	GRAVEL		SAND			SILT OR CLAY
	COARSE	FINE	COARSE	MEDIUM	FINE	

UNIFIED SOIL CLASSIFICATION SYSTEM

PLASTICITY CHART (COHESIVE SOIL ONLY)

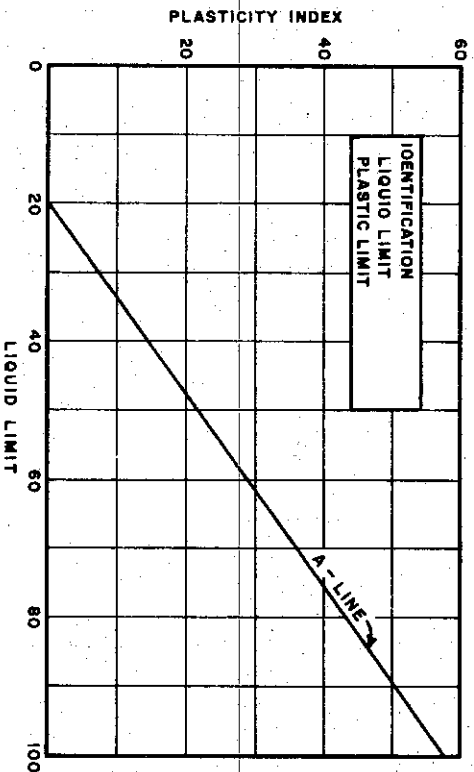

MATERIAL SOURCE

IDENTIFICATION : SILTY CLAY, SANDY (CL-ML)
 EXPLORATION: BORING 7
 SAMPLE : S630
 DEPTH : 136.8' TO 140.3'
 SPECIFIC GRAVITY : USED 2.70

THE DETROIT EDISON COMPANY
 BELLE RIVER PLANT UNITS I & II
 SOIL CLASSIFICATION TESTS

C-598

FILE NO. 1255 DATE JAN. 74

GRAIN SIZE DISTRIBUTION

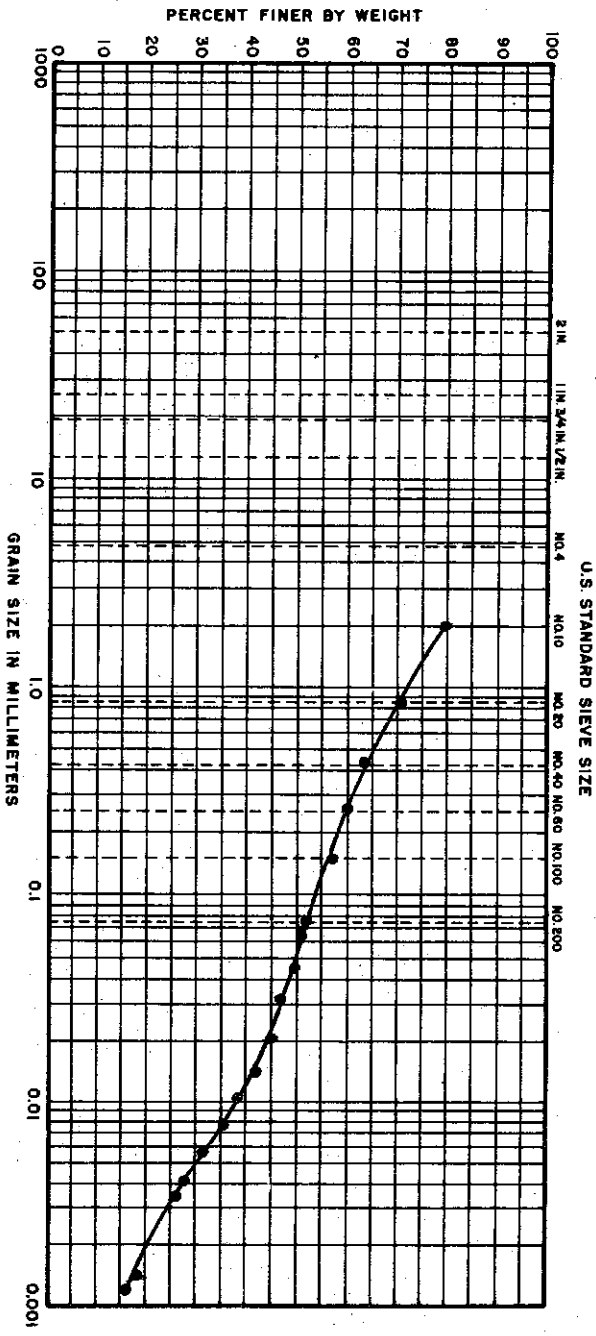

COBBLES	GRAVEL		SAND			SILT OR CLAY
	COARSE	FINE	COARSE	MEDIUM	FINE	

UNIFIED SOIL CLASSIFICATION SYSTEM

PLASTICITY CHART (COHESIVE SOIL ONLY)

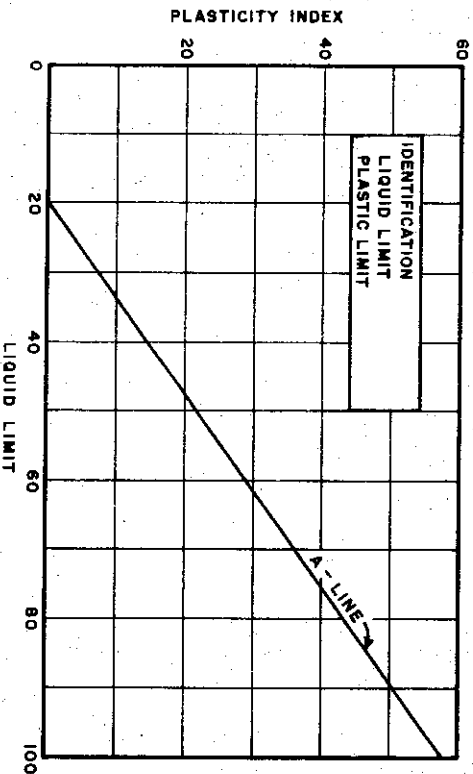

MATERIAL SOURCE

IDENTIFICATION : SILTY CLAY, SANDY (CL-ML)

EXPLORATION: BORING 10

SAMPLE : SS30

DEPTH : 141'

SPECIFIC GRAVITY : USED 2.70

THE DETROIT EDISON COMPANY
BELLE RIVER PLANT UNITS I & II
SOIL CLASSIFICATION TESTS

FILE NO. 1255 DATE JAN. 74

GRAIN SIZE DISTRIBUTION

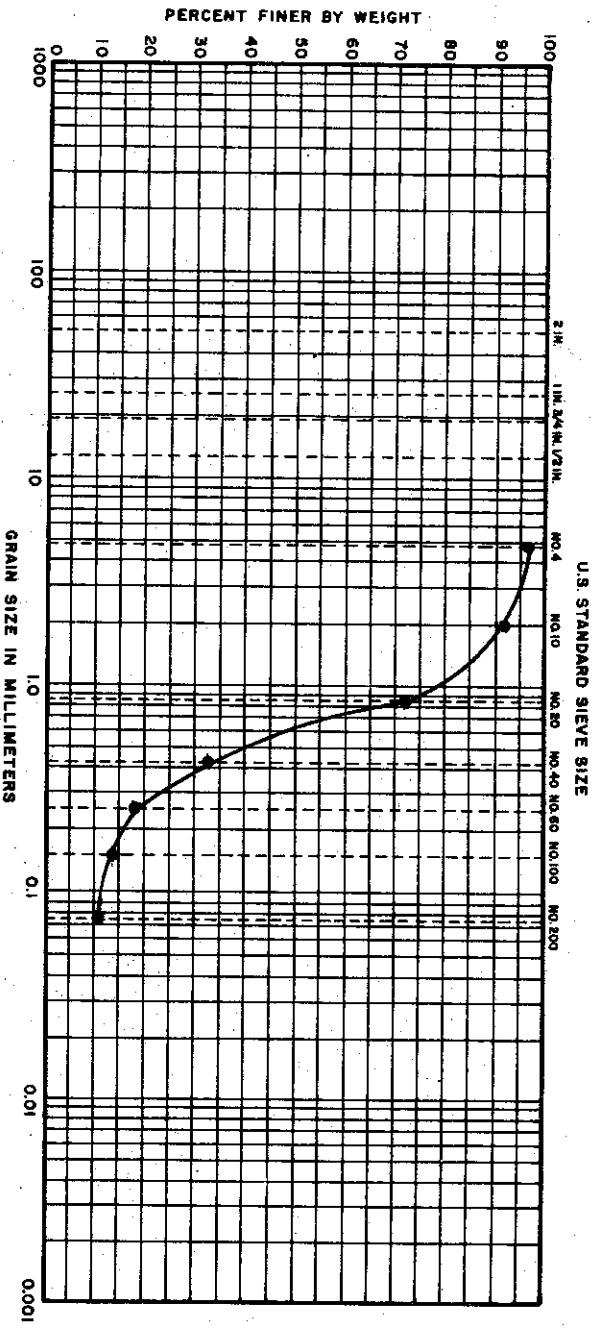

COBBLES	GRAVEL		SAND			SILT OR CLAY
	COARSE	FINE	COARSE	MEDIUM	FINE	

UNIFIED SOIL CLASSIFICATION SYSTEM

PLASTICITY CHART (COHESIVE SOIL ONLY)

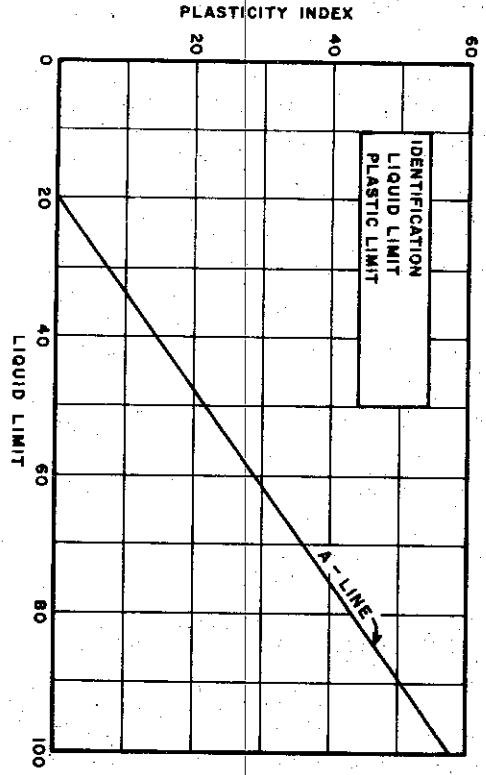

MATERIAL SOURCE

IDENTIFICATION : SILTY SAND (SM-SW)
 EXPLORATION: BORING 18
 SAMPLE : 11
 DEPTH : 103.5' TO 105.0'
 SPECIFIC GRAVITY: USED 2.70

THE DETROIT EDISON COMPANY
 BELLE RIVER PLANT UNITS I & II
 SOIL CLASSIFICATION TESTS

C-600

FILE NO. 1255

DATE JULY 1974

GRAIN SIZE DISTRIBUTION

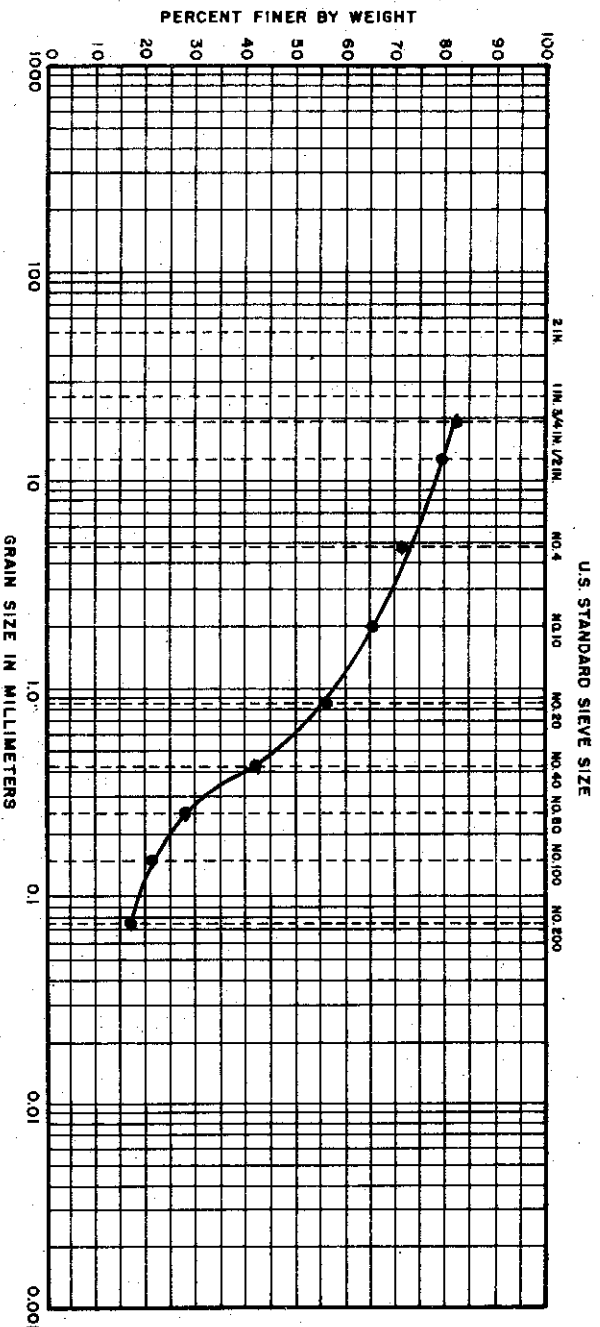

COBBLES	GRAVEL		SAND				SILT OR CLAY
	COARSE	FINE	COARSE	MEDIUM	FINE		

UNIFIED SOIL CLASSIFICATION SYSTEM

PLASTICITY CHART (COHESIVE SOIL ONLY)

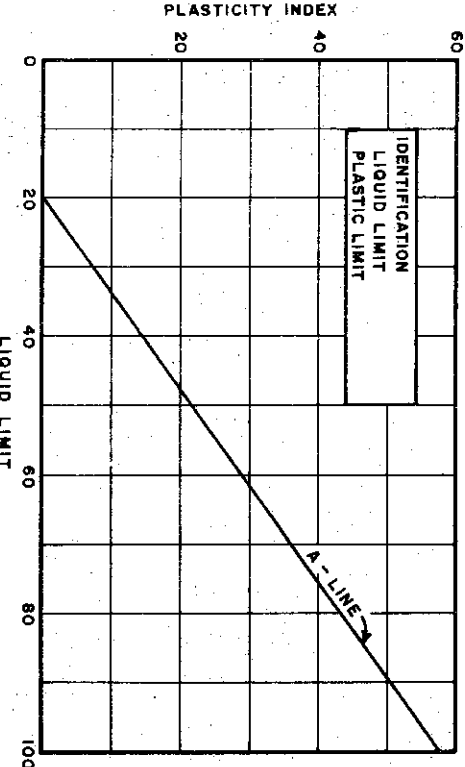

MATERIAL SOURCE

IDENTIFICATION : SILTY SAND, GRAVELLY (SM)
 EXPLORATION : BORING 18
 SAMPLE : 16
 DEPTH : 139.6' TO 141.0'
 SPECIFIC GRAVITY : USED 2.70

THE DETROIT EDISON COMPANY BELLE RIVER PLANT UNITS I & II SOIL CLASSIFICATION TESTS

FILE NO. 1255
 DATE JULY 1974

GRAIN SIZE DISTRIBUTION

U.S. STANDARD SIEVE SIZE

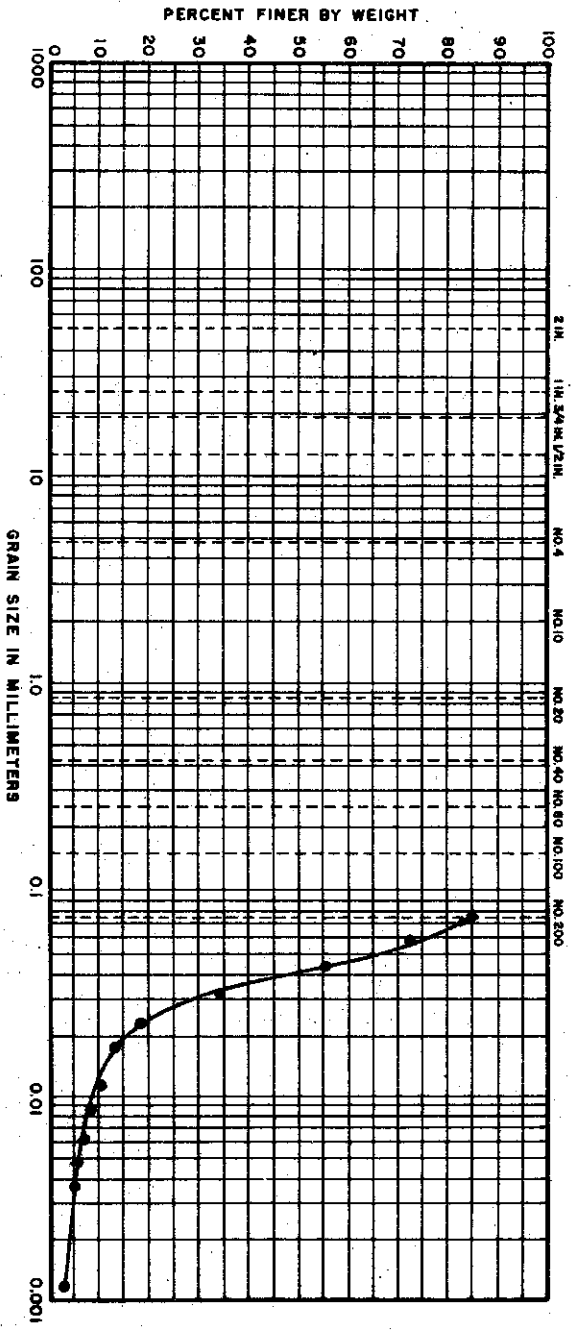

COBBLES	GRAVEL		SAND			SILT OR CLAY
	COARSE	FINE	COARSE	MEDIUM	FINE	

UNIFIED SOIL CLASSIFICATION SYSTEM

PLASTICITY CHART (COHESIVE SOIL ONLY)

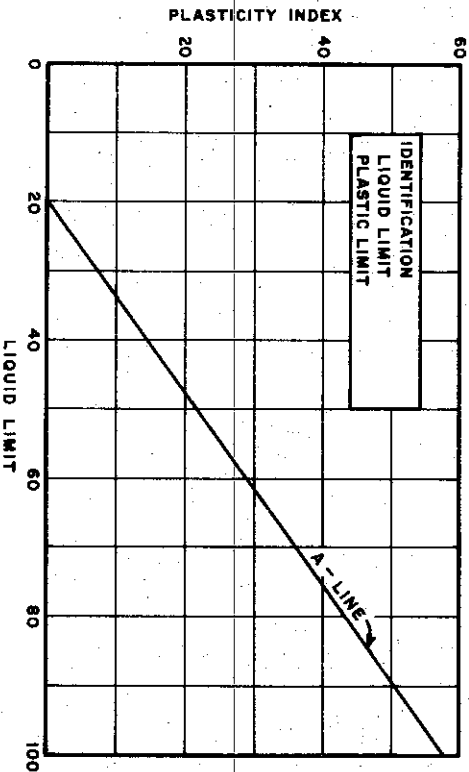

MATERIAL SOURCE

IDENTIFICATION : CLAYEY SILT (CL-ML)
 EXPLORATION: BORING 22
 SAMPLE : SS29
 DEPTH : 133.5' TO 135.5'
 SPECIFIC GRAVITY : USED 2.70

THE DETROIT EDISON COMPANY
 BELLE RIVER PLANT UNITS I & II
 SOIL CLASSIFICATION TESTS

C-602

FILE NO. 1255 DATE JAN. 74

GRAIN SIZE DISTRIBUTION

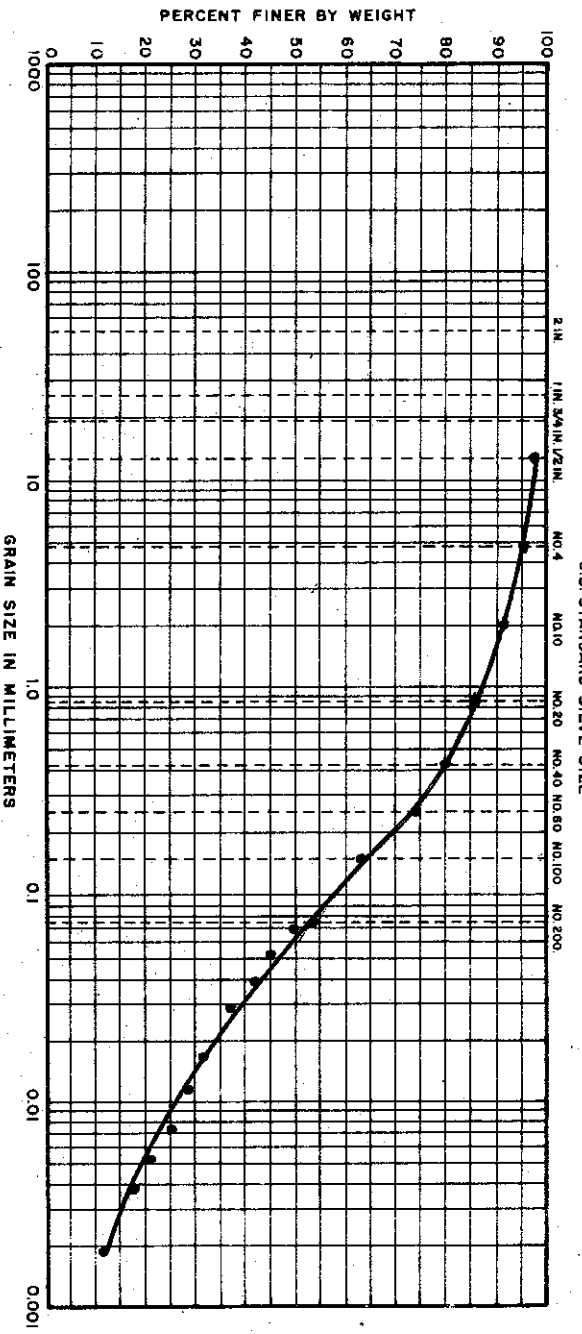

COBBLES	GRAVEL		SAND			SILT OR CLAY
	COARSE	FINE	COARSE	MEDIUM	FINE	

UNIFIED SOIL CLASSIFICATION SYSTEM

PLASTICITY CHART (COHESIVE SOIL ONLY)

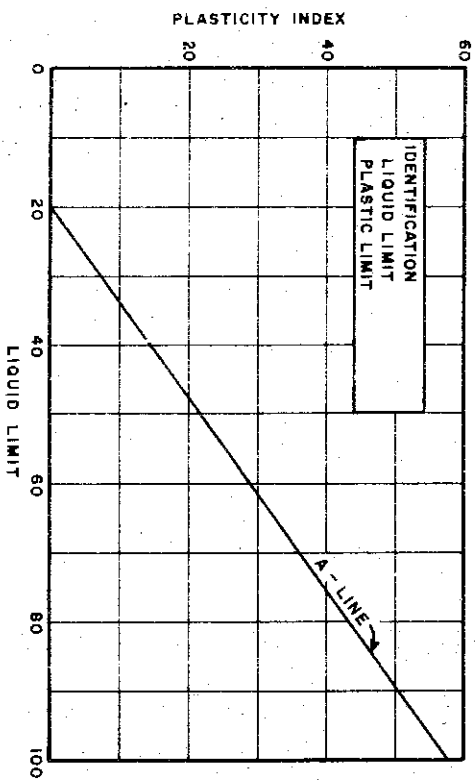

MATERIAL SOURCE

IDENTIFICATION : CLAYEY SILT, SANDY (CL-ML)
 EXPLORATION: BORING 27
 SAMPLE : SS17
 DEPTH : 68.5' TO 70.0'
 SPECIFIC GRAVITY : USED 2.70

THE DETROIT EDISON COMPANY
 BELLE RIVER PLANT UNITS I & II
 SOIL CLASSIFICATION TESTS

FILE NO. 1255 DATE JULY 1974

GRAIN SIZE DISTRIBUTION

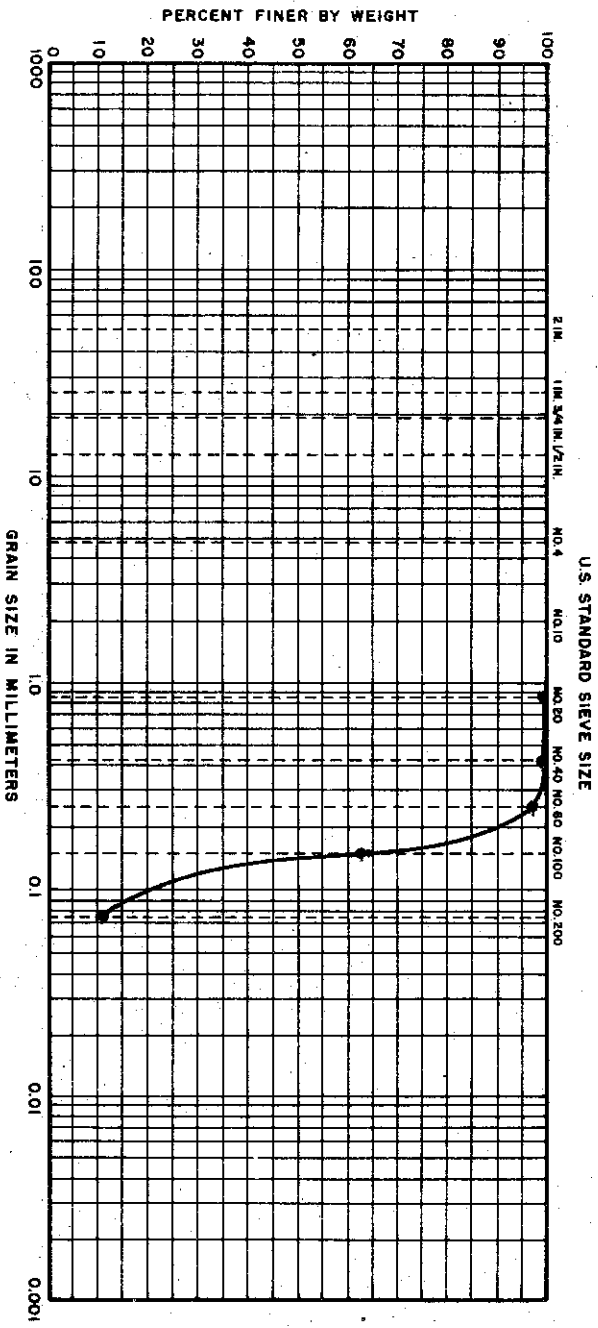

COBBLES	GRAVEL		SAND		SILT OR CLAY
	COARSE	FINE	COARSE	FINE	

UNIFIED SOIL CLASSIFICATION SYSTEM

PLASTICITY CHART (COHESIVE SOIL ONLY)

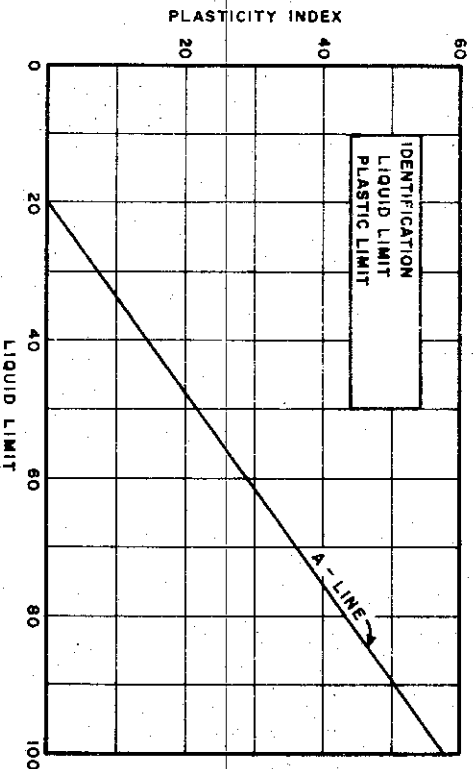

MATERIAL SOURCE

IDENTIFICATION : SILTY FINE SAND (SM-SP)
 EXPLORATION: BORING 27
 SAMPLE : 26
 DEPTH : 113.6' TO 114.4'
 SPECIFIC GRAVITY : USED 2.70

THE DETROIT EDISON COMPANY
 BELLE RIVER PLANT UNITS I & II
 SOIL CLASSIFICATION TESTS

C-604

FILE NO. 1255 DATE JULY 1974

GRAIN SIZE DISTRIBUTION

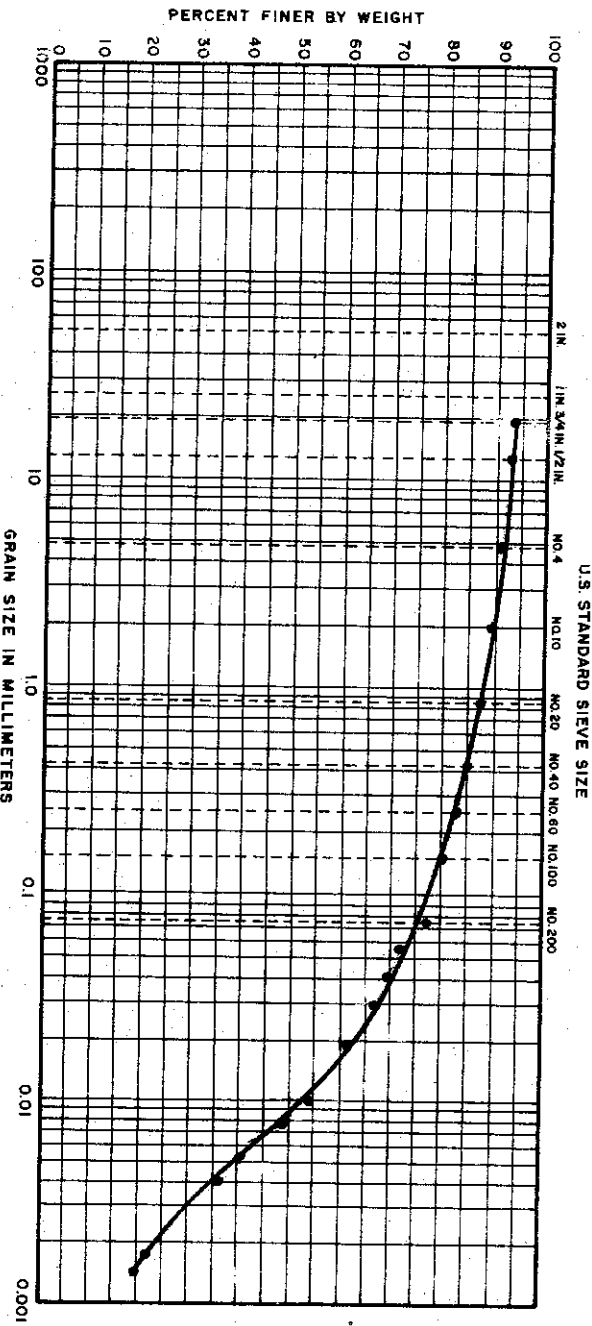

COBBLES	GRAVEL		SAND			SILT OR CLAY
	COARSE	FINE	COARSE	MEDIUM	FINE	

UNIFIED SOIL CLASSIFICATION SYSTEM

PLASTICITY CHART (COHESIVE SOIL ONLY)

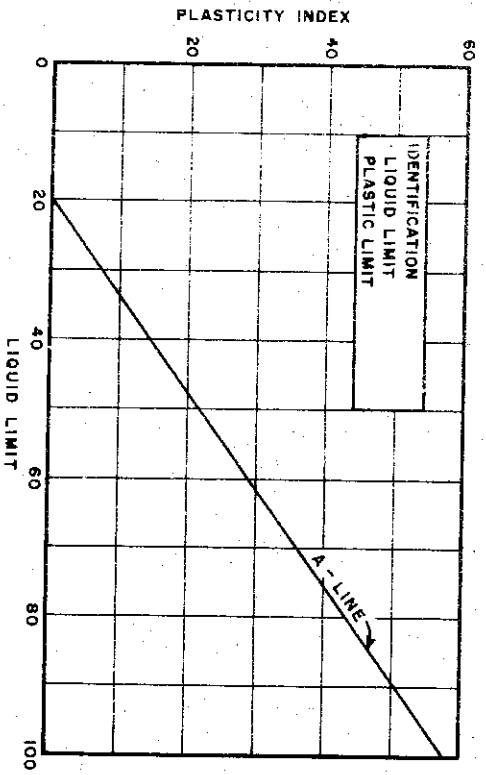

MATERIAL SOURCE

IDENTIFICATION: SILTY CLAY, SANDY (CL)
 EXPLORATION: BORING 30
 SAMPLE: SS15
 DEPTH: 68.5' TO 70.0'
 SPECIFIC GRAVITY: USED 2.70

THE DETROIT EDISON COMPANY
 BELLE RIVER PLANT UNITS I & II
 SOIL CLASSIFICATION TESTS

FILE NO. 1255
 DATE JULY 1974

GRAIN SIZE DISTRIBUTION

U.S. STANDARD SIEVE SIZE

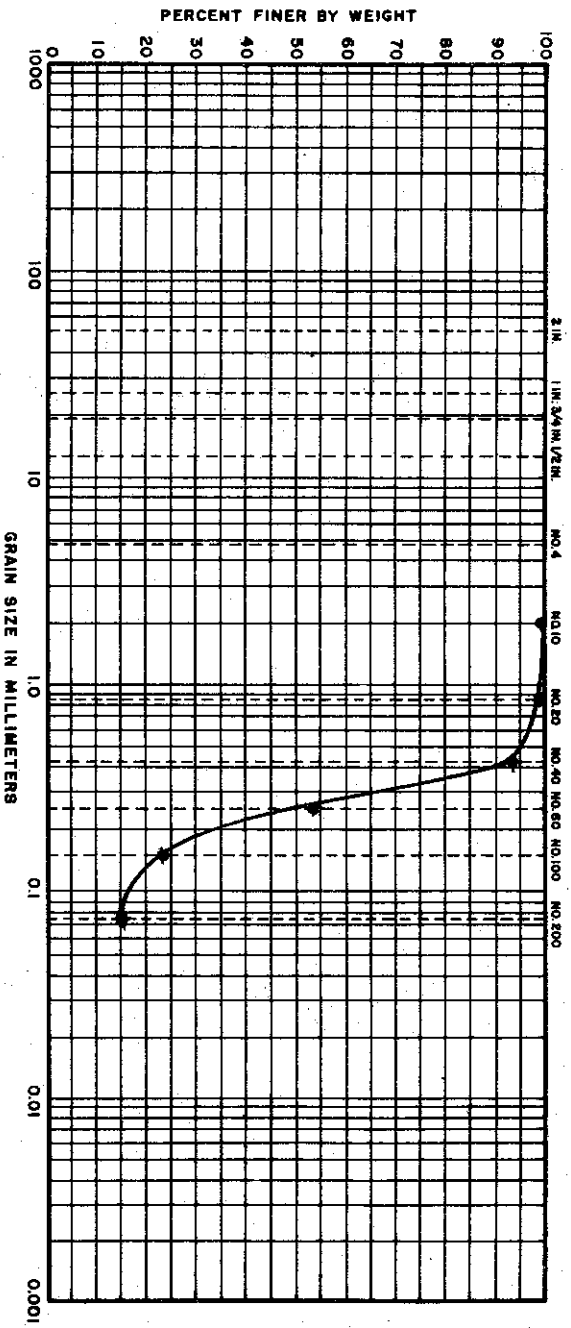

COBBLES	GRAVEL		SAND		SILT OR CLAY
	COARSE	FINE	COARSE	FINE	

UNIFIED SOIL CLASSIFICATION SYSTEM

PLASTICITY CHART (COHESIVE SOIL ONLY)

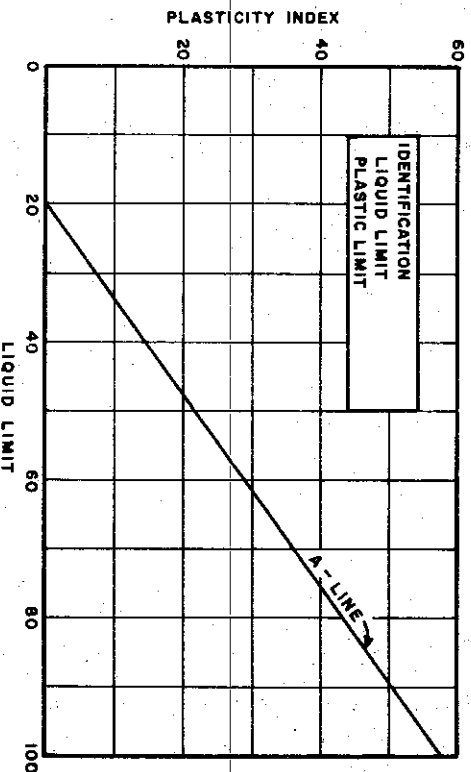

MATERIAL SOURCE

IDENTIFICATION : SILTY FINE SAND (SM)
 EXPLORATION: BORING 30
 SAMPLE : 21
 DEPTH : 98.5' TO 100.0'
 SPECIFIC GRAVITY: USED 2.70

THE DETROIT EDISON COMPANY
 BELLE RIVER PLANT UNITS I & II
 SOIL CLASSIFICATION TESTS

C-606

GOLDBERG - ZOINO & ASSOCIATES
 CONSULTANTS IN GEOTECHNICAL ENGINEERING

FILE NO. 1255 DATE JULY 1974

GRAIN SIZE DISTRIBUTION

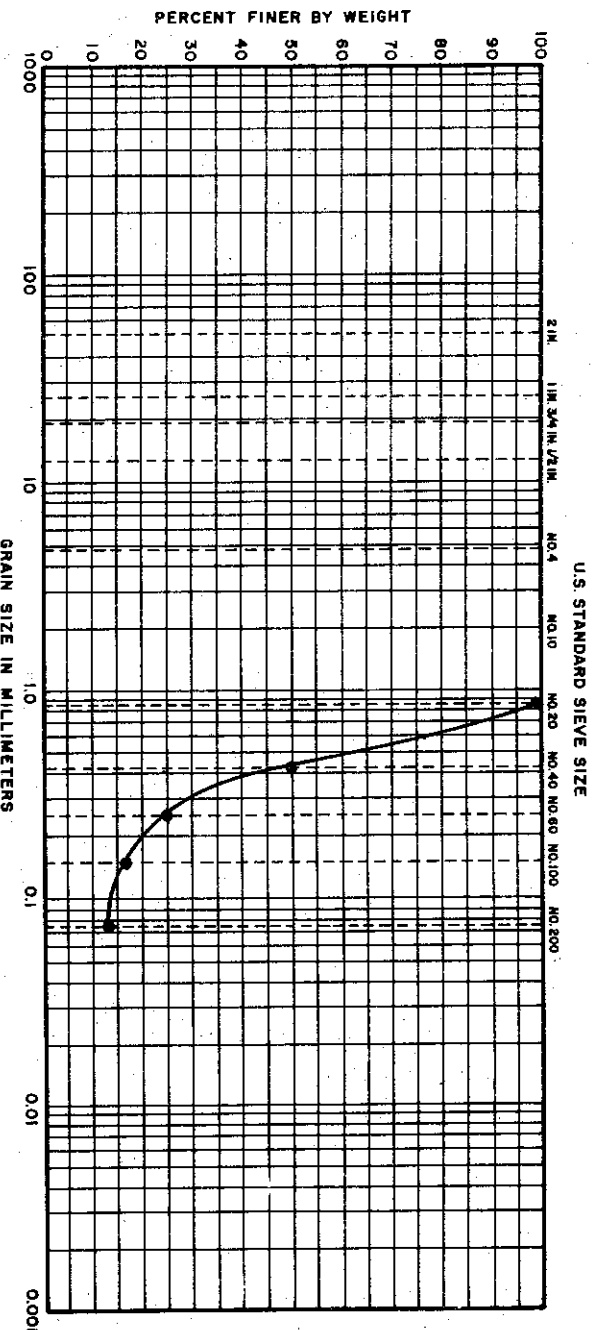

COBBLES	GRAVEL		SAND			SILT OR CLAY
	COARSE	FINE	COARSE	MEDIUM	FINE	

UNIFIED SOIL CLASSIFICATION SYSTEM

PLASTICITY CHART (COHESIVE SOIL ONLY)

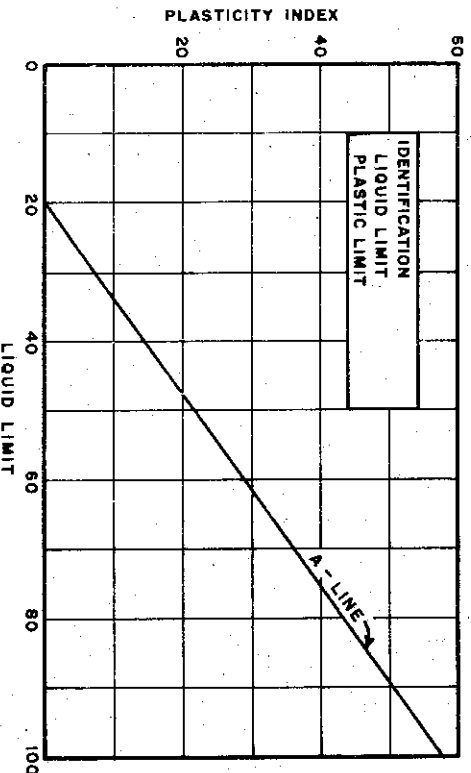

MATERIAL SOURCE

IDENTIFICATION: SILTY SAND (SM)
 EXPLORATION: BORING 30
 SAMPLE : 25
 DEPTH : 118.5' TO 120.0'
 SPECIFIC GRAVITY: USED 2.70

THE DETROIT EDISON COMPANY
 BELLE RIVER PLANT UNITS I & II
 SOIL CLASSIFICATION TESTS

FILE NO. 1255 DATE JULY 1974

GRAIN SIZE DISTRIBUTION

U.S. STANDARD SIEVE SIZE

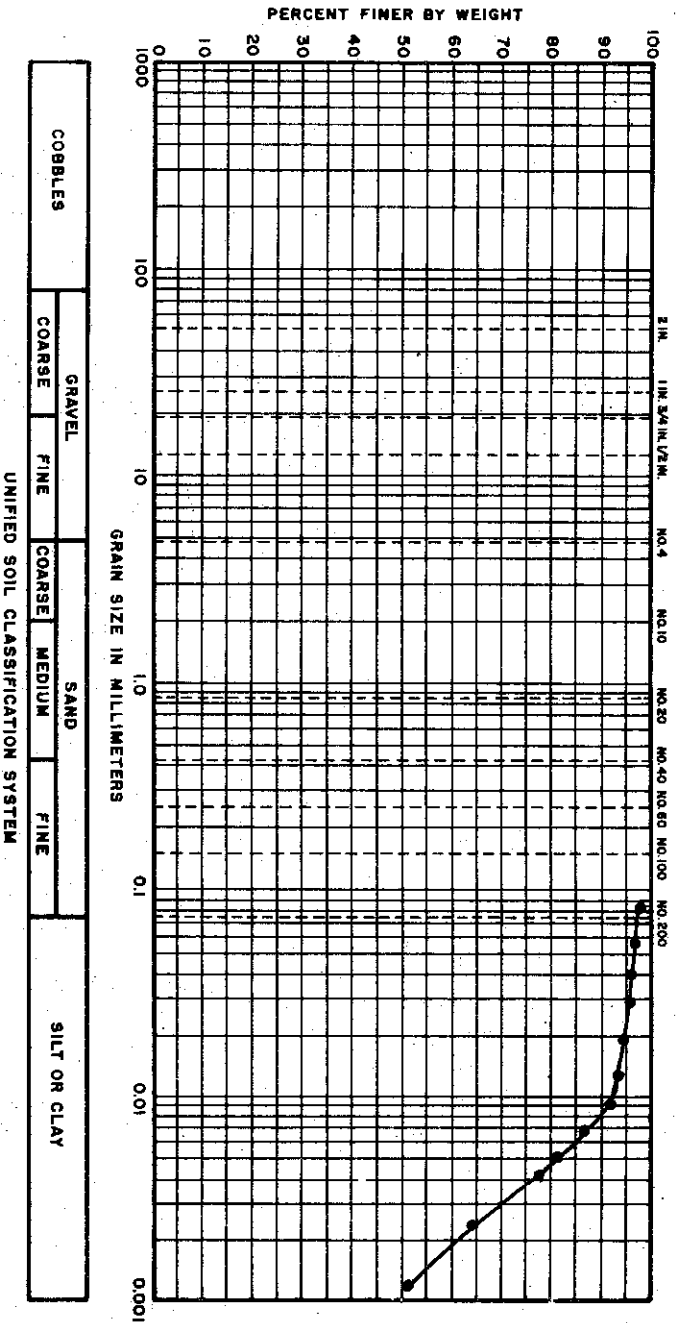

PLASTICITY CHART (COHESIVE SOIL ONLY)

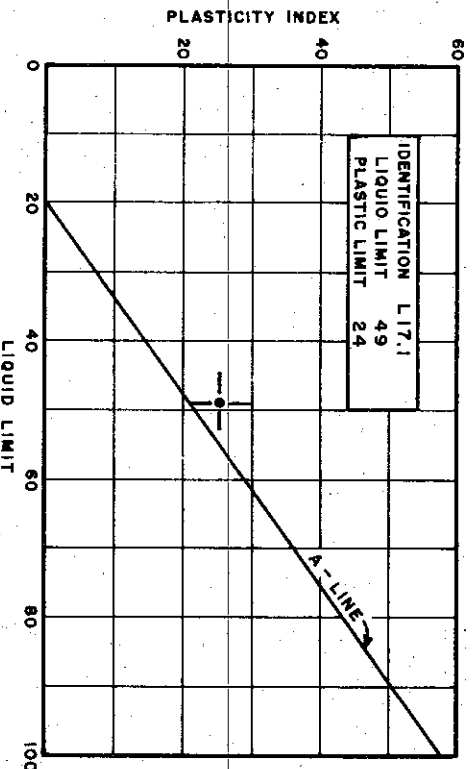

MATERIAL SOURCE

IDENTIFICATION : SILTY CLAY (CL-CH)
 EXPLORATION: BORING 38
 SAMPLE : 5
 DEPTH : 8.7' TO 9.0'
 SPECIFIC GRAVITY : USED 2.70

THE DETROIT EDISON COMPANY
 BELLE RIVER PLANT UNITS I & II
 SOIL CLASSIFICATION TESTS

C-608

GOLDBERG - ZOINO & ASSOCIATES
 CONSULTANTS IN GEOTECHNICAL ENGINEERING

FILE NO. 1255 DATE JAN. 74

GRAIN SIZE DISTRIBUTION

U.S. STANDARD SIEVE SIZE

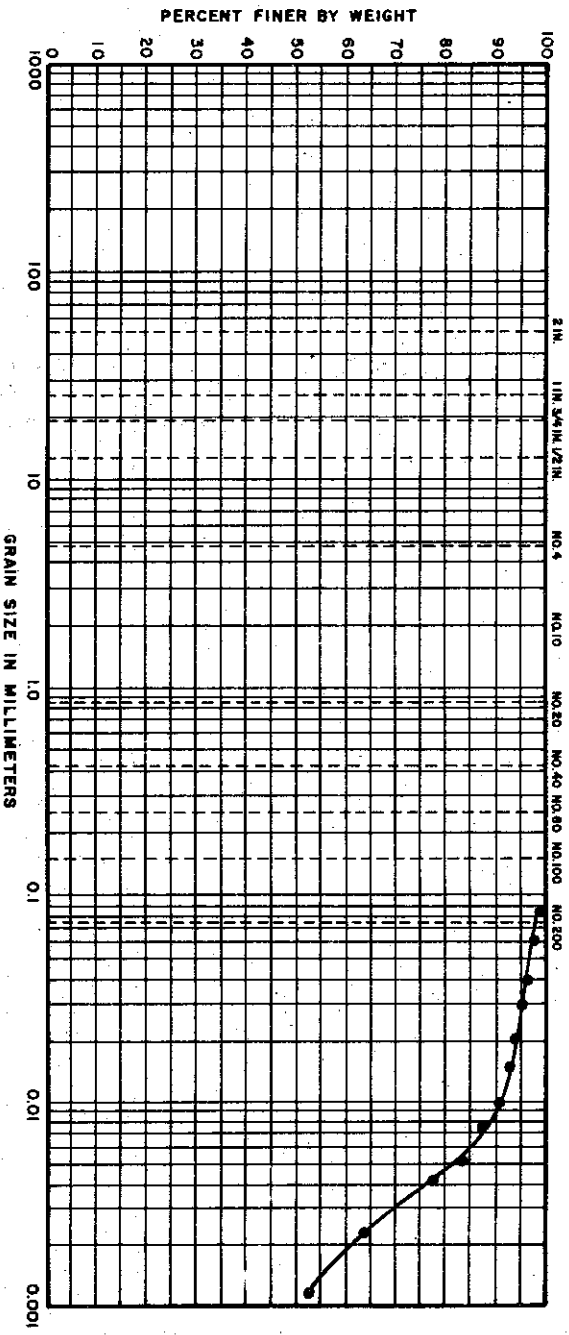

COBBLES	GRAVEL		SAND			SILT OR CLAY
	COARSE	FINE	COARSE	MEDIUM	FINE	

UNIFIED SOIL CLASSIFICATION SYSTEM

PLASTICITY CHART (COHESIVE SOIL ONLY)

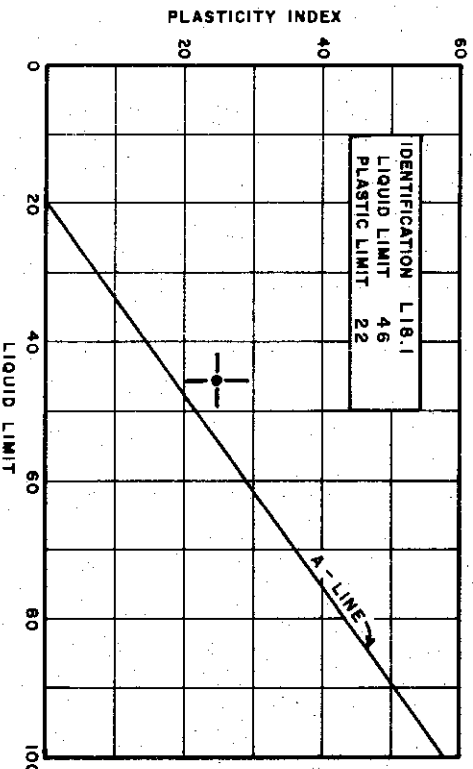

MATERIAL SOURCE

IDENTIFICATION : SILTY CLAY (CL-CH)

EXPLORATION: BORING 3B

SAMPLE : 4

DEPTH : 14.3' TO 14.6'

SPECIFIC GRAVITY = 2.71

THE DETROIT EDISON COMPANY
BELLE RIVER PLANT UNITS I & II
SOIL CLASSIFICATION TESTS

FILE NO. 1255 DATE JAN. 74

GRAIN SIZE DISTRIBUTION

U.S. STANDARD SIEVE SIZE

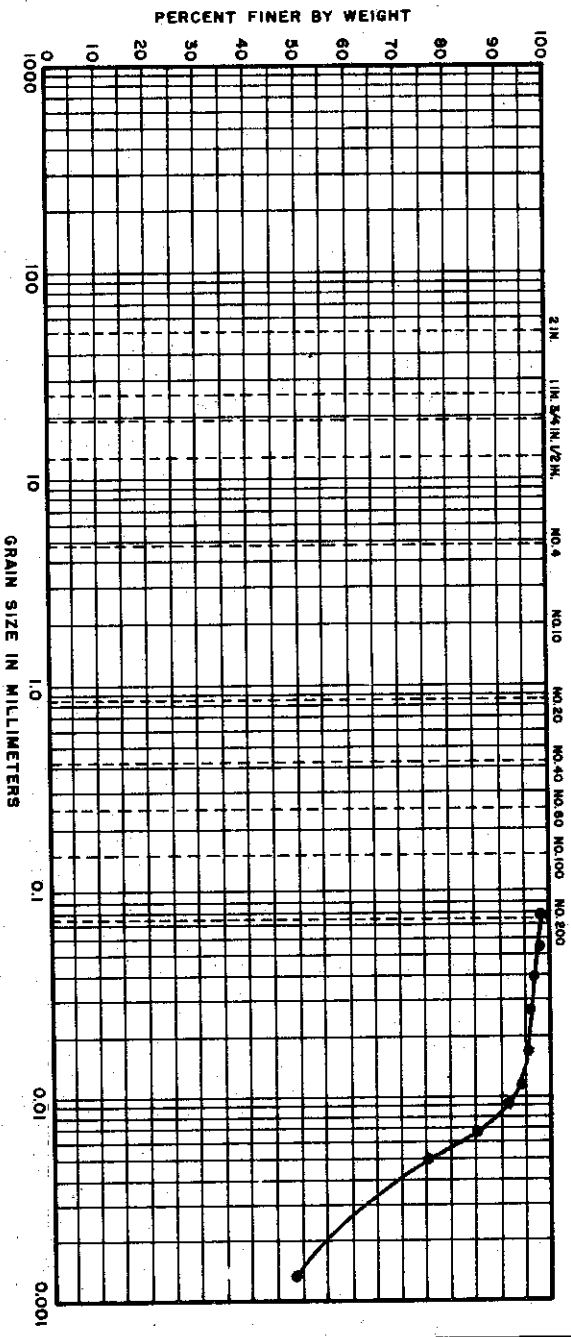

COBBLES	GRAVEL		SAND			SILT OR CLAY
	COARSE	FINE	COARSE	MEDIUM	FINE	

UNIFIED SOIL CLASSIFICATION SYSTEM

PLASTICITY CHART (COHESIVE SOIL ONLY)

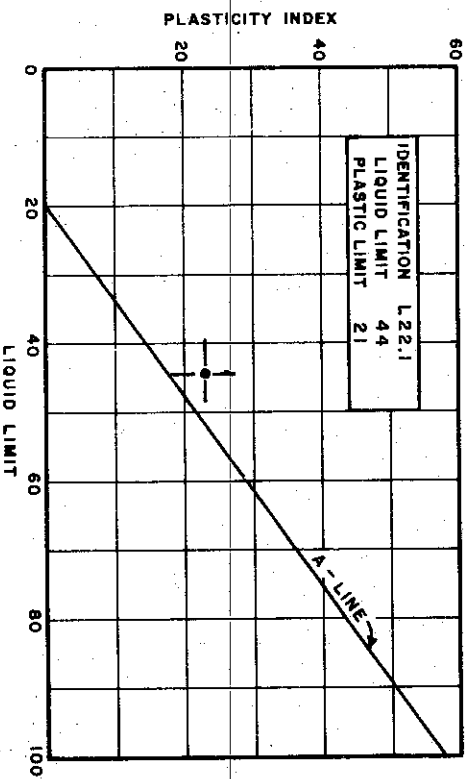

MATERIAL SOURCE

IDENTIFICATION : SILTY CLAY (CL)
 EXPLORATION: BORING 38
 SAMPLE : 12
 DEPTH : 54.1' TO 54.5'
 SPECIFIC GRAVITY : USED 2.70

THE DETROIT EDISON COMPANY
 BELLE RIVER PLANT UNITS I & II
 SOIL CLASSIFICATION TESTS

C-610

FILE NO. 1255 DATE JAN 74

GRAIN SIZE DISTRIBUTION

U.S. STANDARD SIEVE SIZE

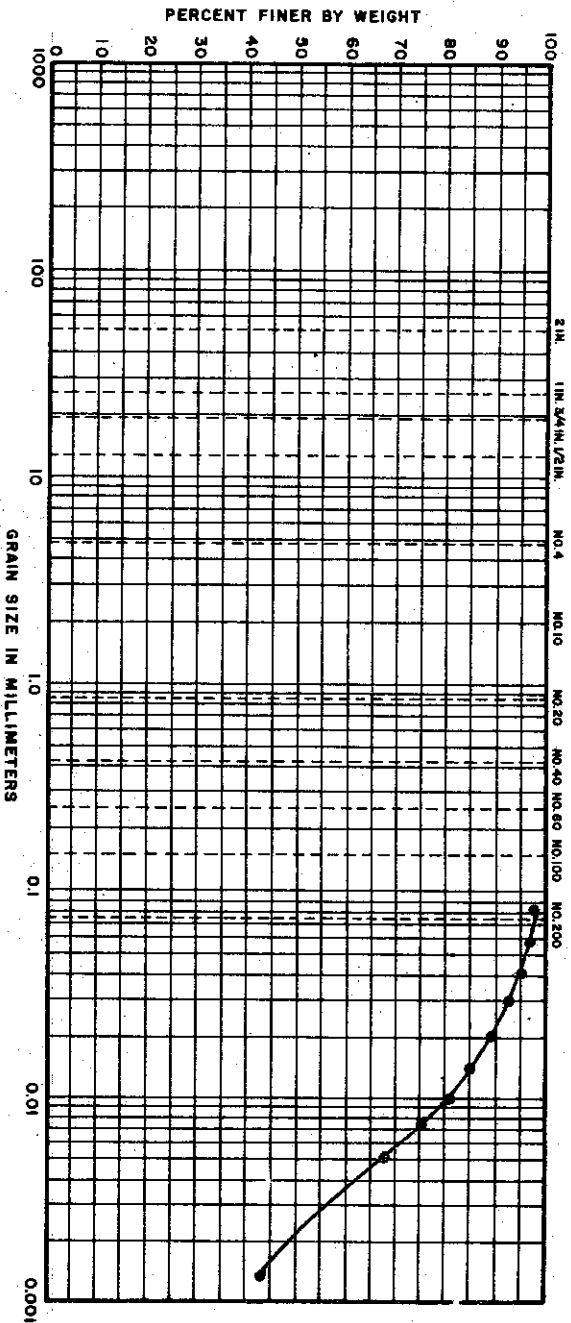

COBBLES	GRAVEL		SAND			SILT OR CLAY
	COARSE	FINE	COARSE	MEDIUM	FINE	

UNIFIED SOIL CLASSIFICATION SYSTEM

PLASTICITY CHART (COHESIVE SOIL ONLY)

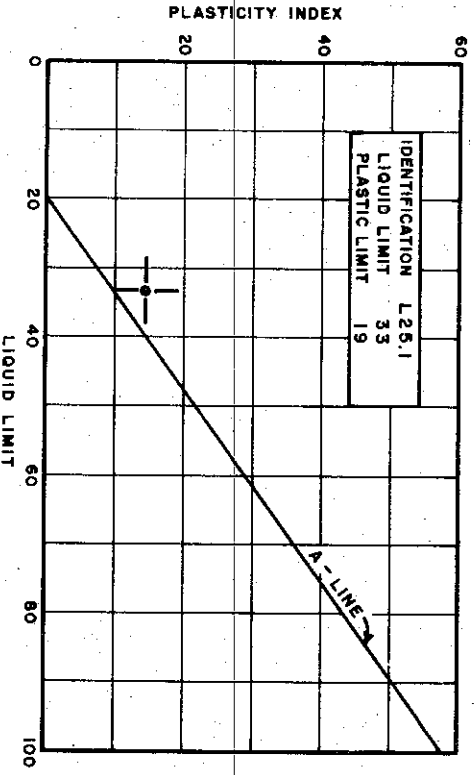

MATERIAL SOURCE

IDENTIFICATION : SILTY CLAY (CL)
 EXPLORATION: BORING 38
 SAMPLE : 18
 DEPTH : 84.6' TO 84.9'
 SPECIFIC GRAVITY : USED 2.70

THE DETROIT EDISON COMPANY
 BELLE RIVER PLANT UNITS I & II
 SOIL CLASSIFICATION TESTS

C-612

FILE NO. 1255 DATE JAN. 74

GRAIN SIZE DISTRIBUTION

U.S. STANDARD SIEVE SIZE

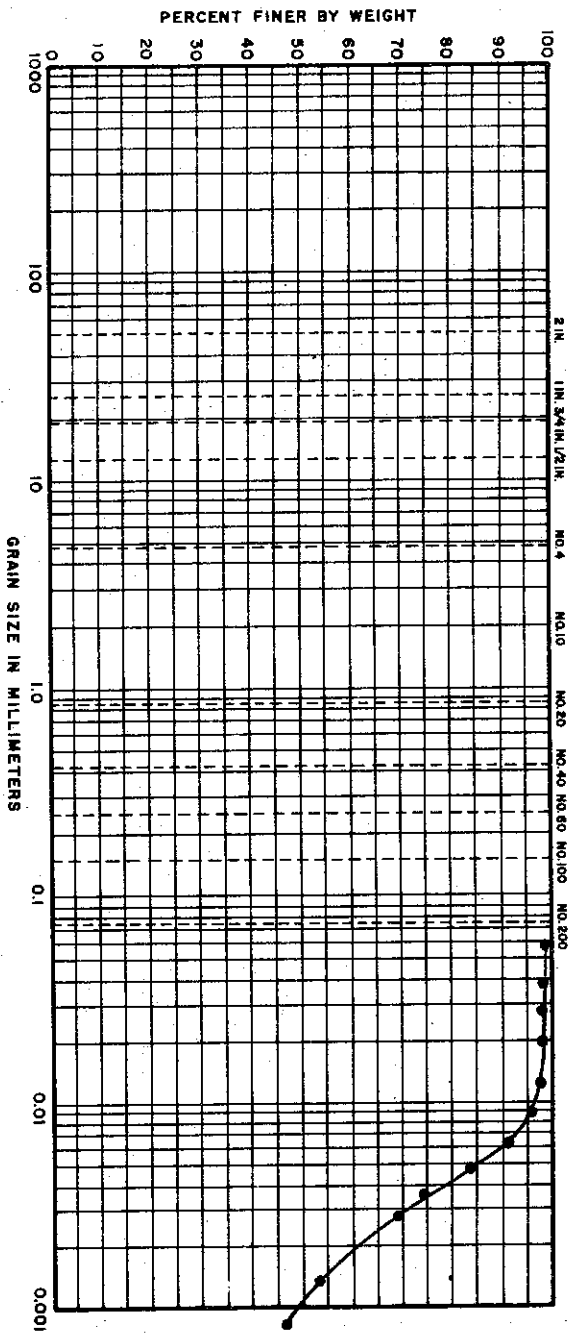

COBBLES	GRAVEL		SAND			SILT OR CLAY
	COARSE	FINE	COARSE	MEDIUM	FINE	

UNIFIED SOIL CLASSIFICATION SYSTEM

PLASTICITY CHART (COHESIVE SOIL ONLY)

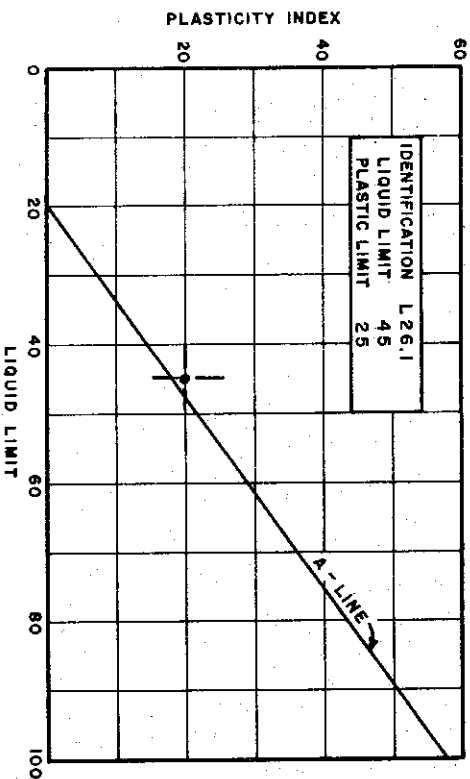

IDENTIFICATION L 26.1
LIQUID LIMIT 45
PLASTIC LIMIT 25

MATERIAL SOURCE

IDENTIFICATION : SILTY CLAY (CL)

EXPLORATION: BORING 38

SAMPLE : 24

DEPTH : 114.2' TO 114.5'

SPECIFIC GRAVITY : USED 2.70

THE DETROIT EDISON COMPANY
BELLE RIVER PLANT UNITS I & II
SOIL CLASSIFICATION TESTS

FILE NO. 1255

DATE JAN. 74

GRAIN SIZE DISTRIBUTION

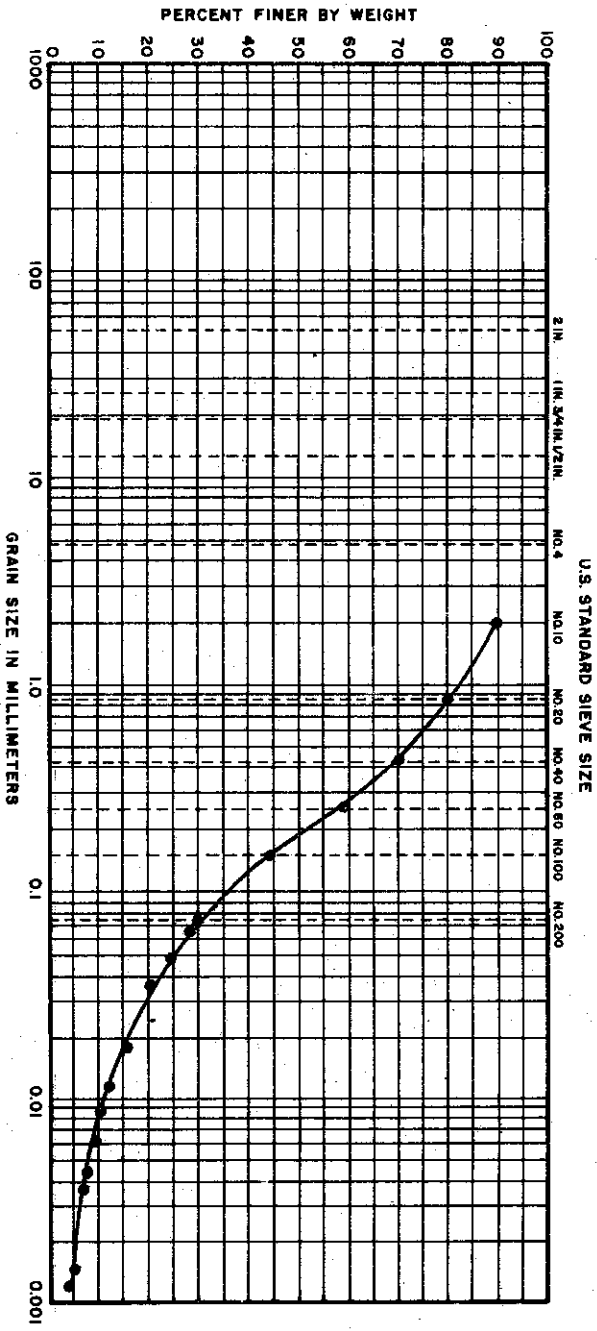

COBBLES	GRAVEL		SAND			SILT OR CLAY
	COARSE	FINE	COARSE	MEDIUM	FINE	

UNIFIED SOIL CLASSIFICATION SYSTEM

PLASTICITY CHART (COHESIVE SOIL ONLY)

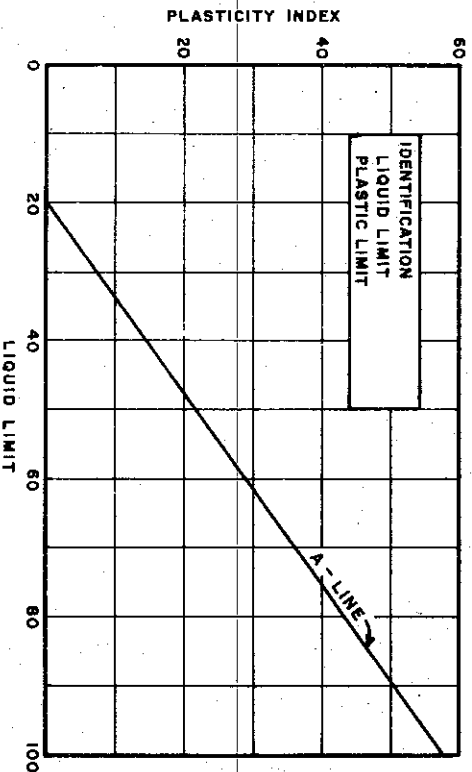

MATERIAL SOURCE

IDENTIFICATION : SILTY SAND (SM)
 EXPLORATION: BORING 38
 SAMPLE : SS30
 DEPTH : 138.5' TO 140.0'
 SPECIFIC GRAVITY : USED 2.70

THE DETROIT EDISON COMPANY
 BELLE RIVER PLANT UNITS I & II
 SOIL CLASSIFICATION TESTS

C-614

FILE NO. 1255 DATE JAN. 74

GRAIN SIZE DISTRIBUTION

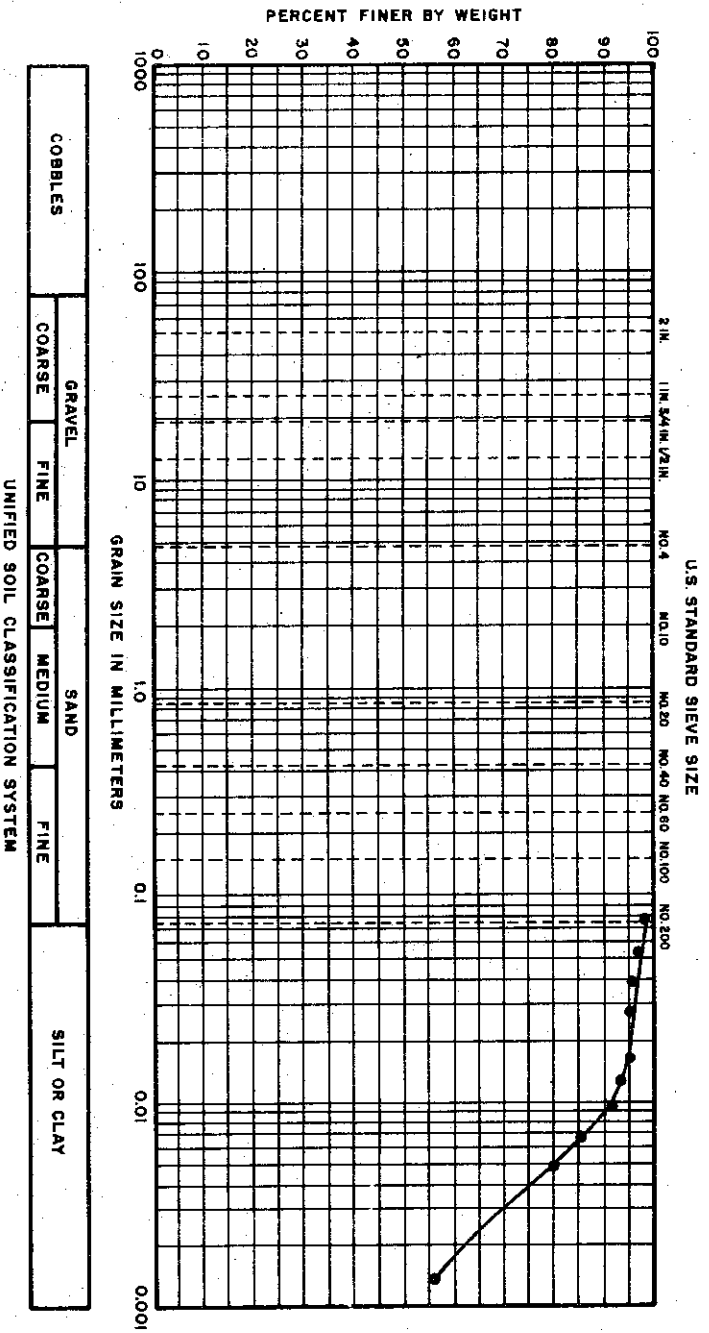

PLASTICITY CHART

(COHESIVE SOIL ONLY)

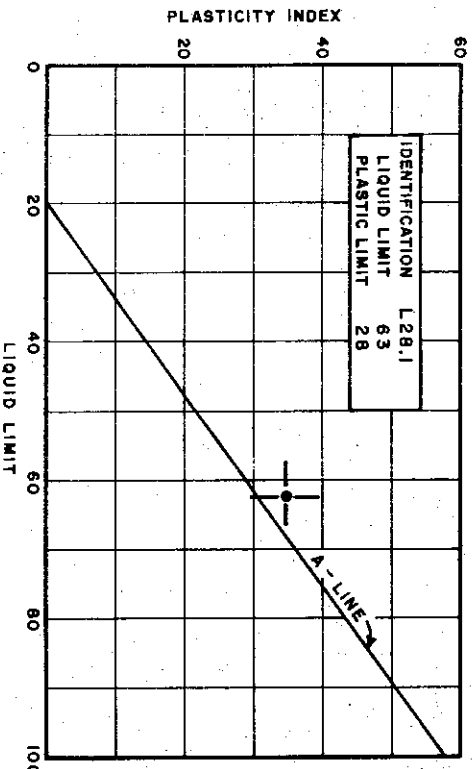

MATERIAL SOURCE

IDENTIFICATION: SILTY CLAY (CH)
EXPLORATION: BORING 4I
SAMPLE: 2
DEPTH: 4.5' TO 4.8'
SPECIFIC GRAVITY: USED 2.70

THE DETROIT EDISON COMPANY BELLE RIVER PLANT UNITS I & II SOIL CLASSIFICATION TESTS

FILE NO. 1255 DATE JAN. 74

GRAIN SIZE DISTRIBUTION

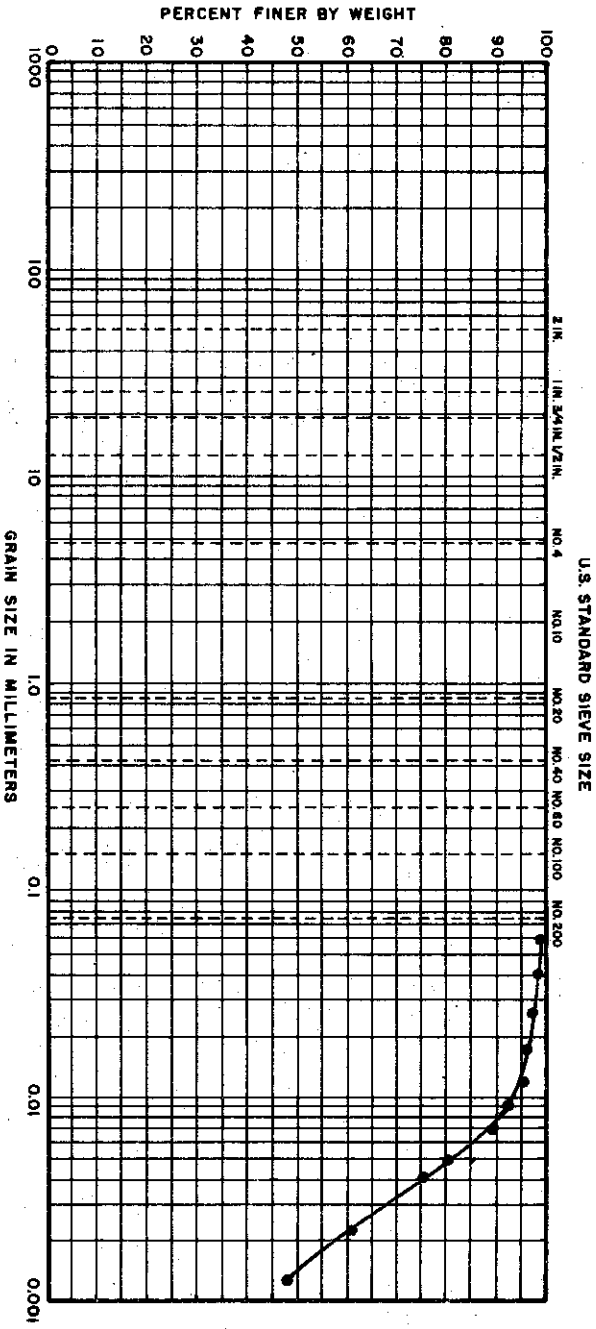

COBBLES	GRAVEL		SAND			SILT OR CLAY
	COARSE	FINE	COARSE	MEDIUM	FINE	

UNIFIED SOIL CLASSIFICATION SYSTEM

PLASTICITY CHART (COHESIVE SOIL ONLY)

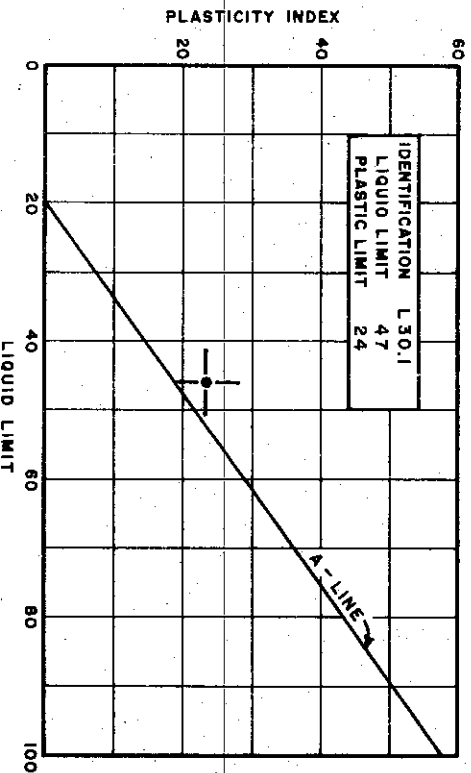

MATERIAL SOURCE

IDENTIFICATION: SILTY CLAY (CL)
 EXPLORATION: BORING 41
 SAMPLE: 7
 DEPTH: 20.6' TO 21.0'
 SPECIFIC GRAVITY = 2.66

THE DETROIT EDISON COMPANY
 BELLE RIVER PLANT UNITS I & II
 SOIL CLASSIFICATION TESTS

FILE NO. 1255
 DATE JAN. 74

GRAIN SIZE DISTRIBUTION

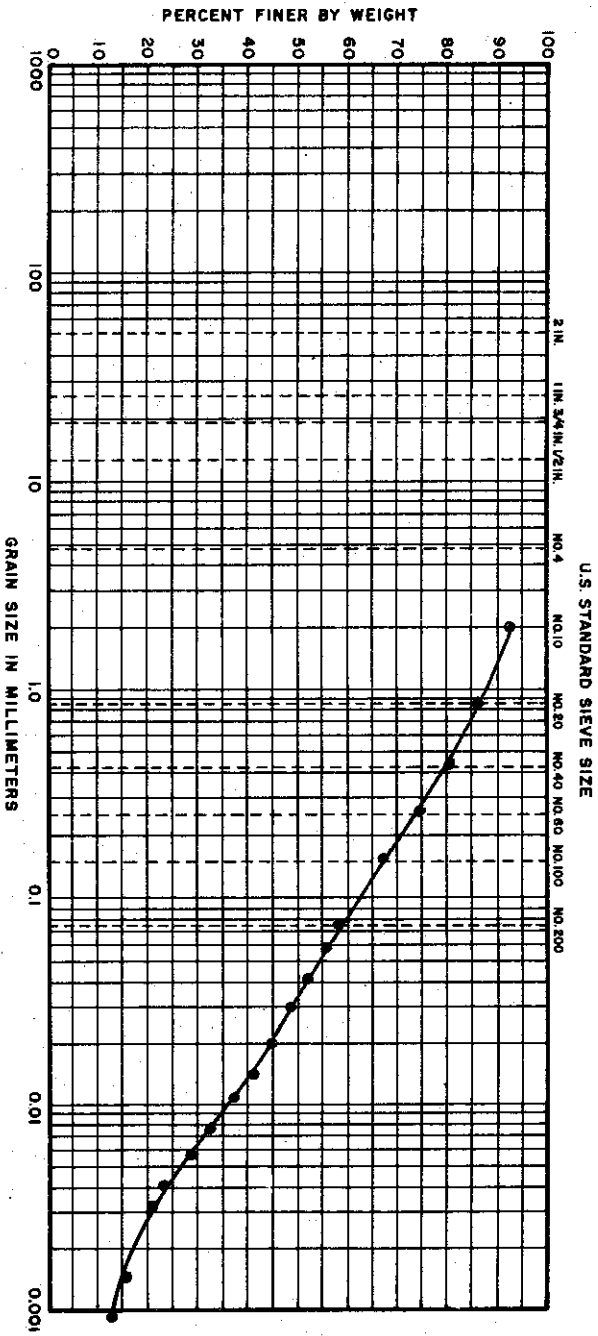

COBBLES	GRAVEL		SAND				SILT OR CLAY
	COARSE	FINE	COARSE	MEDIUM	FINE		

UNIFIED SOIL CLASSIFICATION SYSTEM

PLASTICITY CHART (COHESIVE SOIL ONLY)

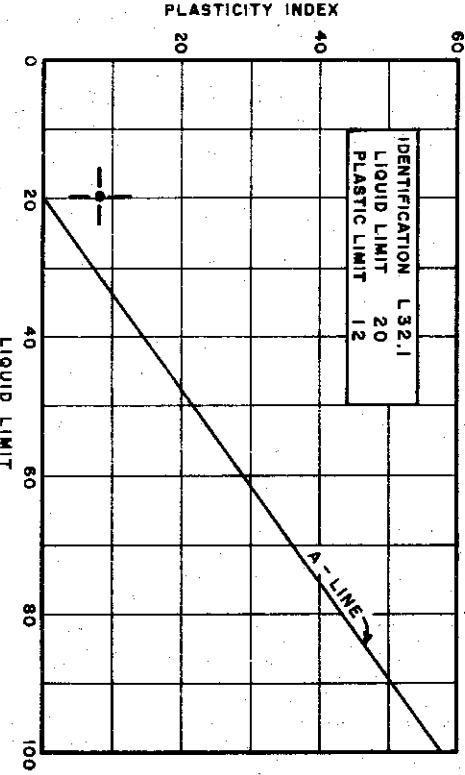

MATERIAL SOURCE

IDENTIFICATION : CLAYEY SAND (SC)
EXPLORATION: BORING 41
SAMPLE : II
DEPTH : 40.7' TO 41.0'
SPECIFIC GRAVITY : USED 2.70

THE DETROIT EDISON COMPANY
BELLE RIVER PLANT UNITS I & II
SOIL CLASSIFICATION TESTS

FILE NO. 1255 DATE JAN. 74

GRAIN SIZE DISTRIBUTION

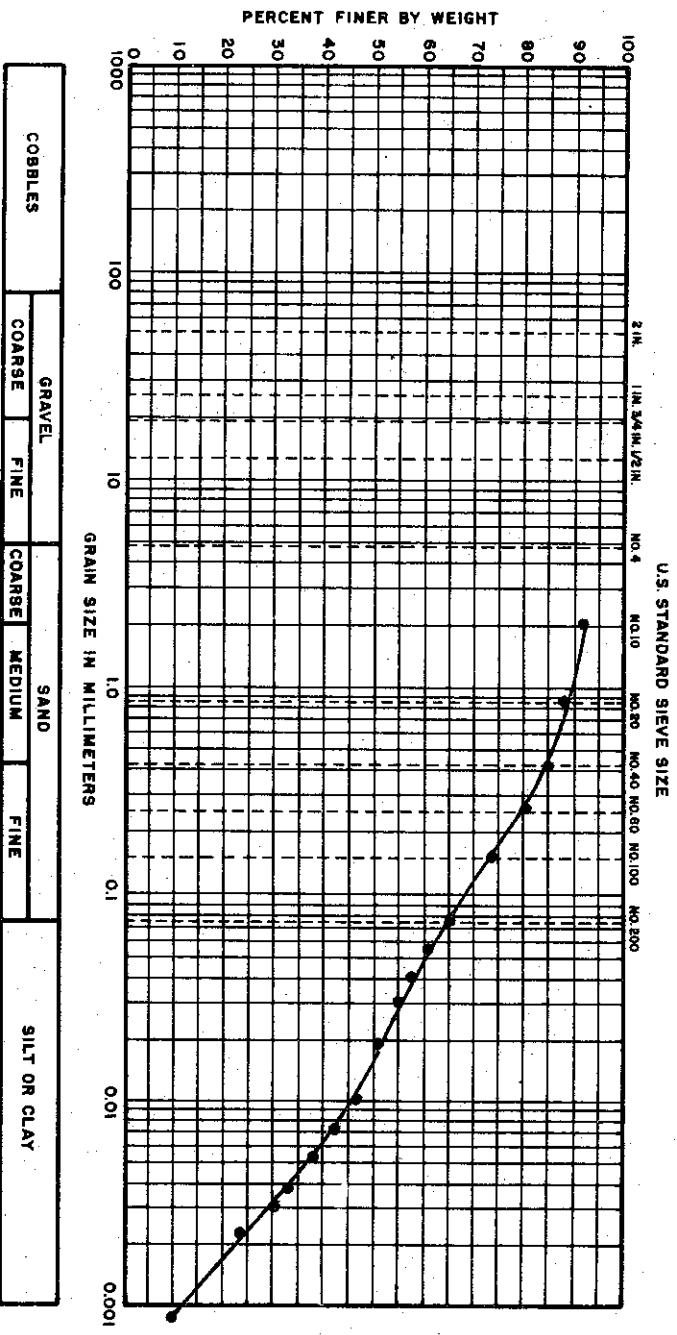

PLASTICITY CHART (COHESIVE SOIL ONLY)

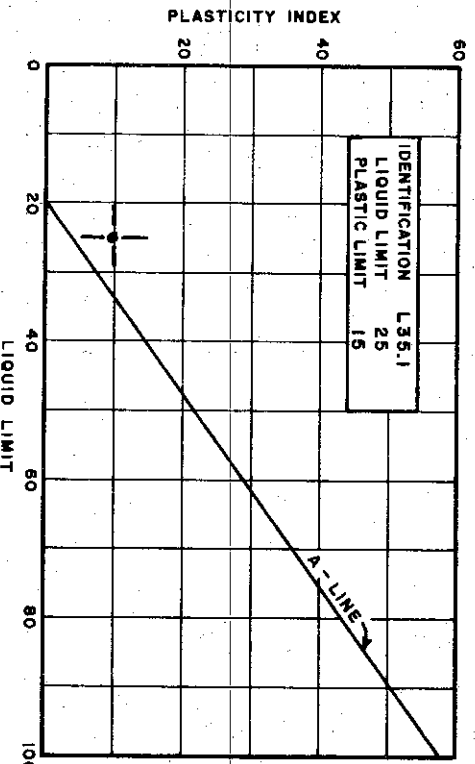

MATERIAL SOURCE

IDENTIFICATION : SILTY CLAY; ZONES OF SAND (CL-SC)
EXPLORATION: BORING 4I
SAMPLE : 17
DEPTH : 72.9' TO 73.2'
SPECIFIC GRAVITY = 2.68

THE DETROIT EDISON COMPANY
BELLE RIVER PLANT UNITS I & II
SOIL CLASSIFICATION TESTS

C-618

GRAIN SIZE DISTRIBUTION

U.S. STANDARD SIEVE SIZE

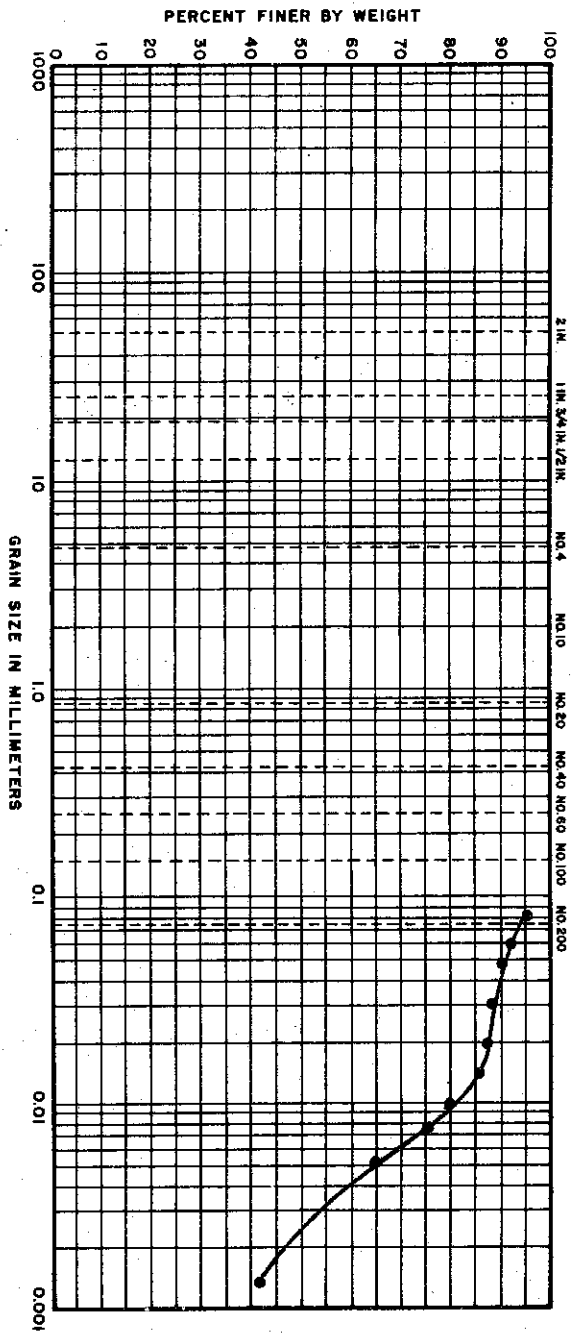

COBBLES	GRAVEL		SAND			SILT OR CLAY
	COARSE	FINE	COARSE	MEDIUM	FINE	

UNIFIED SOIL CLASSIFICATION SYSTEM

PLASTICITY CHART (COHESIVE SOIL ONLY)

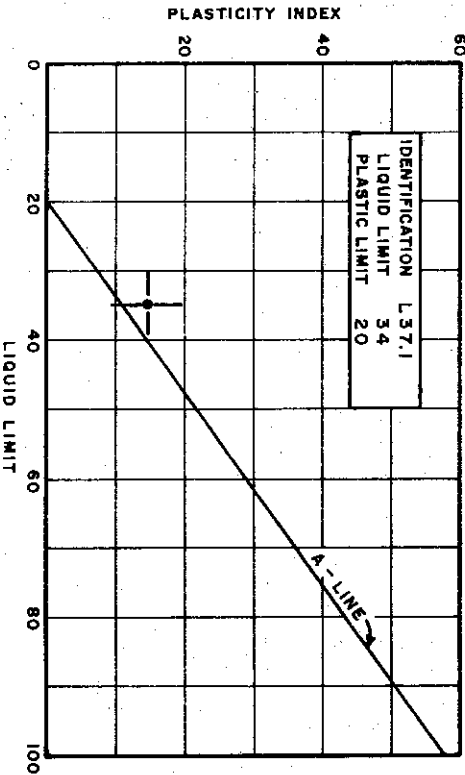

IDENTIFICATION L 37.1
LIQUID LIMIT 34
PLASTIC LIMIT 20

MATERIAL SOURCE

IDENTIFICATION : SILTY CLAY (CL)
EXPLORATION: BORING 41
SAMPLE : 23
DEPTH : 101.9' TO 102.2'
SPECIFIC GRAVITY : USED 2.70

THE DETROIT EDISON COMPANY
BELLE RIVER PLANT UNITS I & II
SOIL CLASSIFICATION TESTS
FILE NO. 1255
DATE JAN. 74

GRAIN SIZE DISTRIBUTION

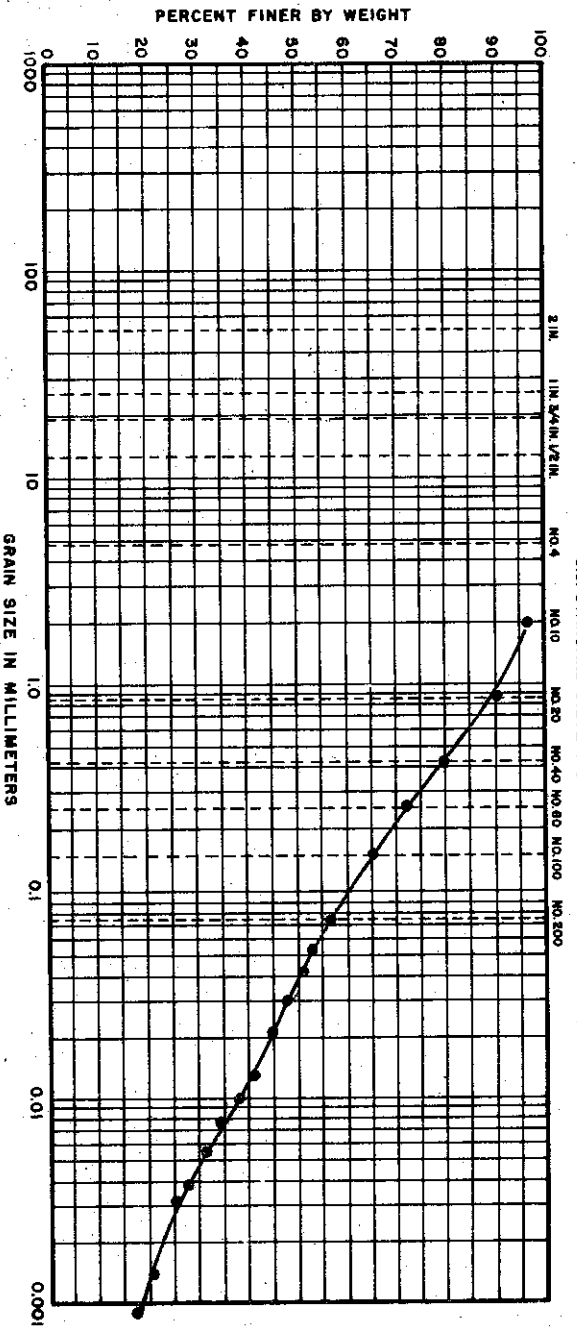

COBBLES	GRAVEL		SAND			SILT OR CLAY
	COARSE	FINE	COARSE	MEDIUM	FINE	

UNIFIED SOIL CLASSIFICATION SYSTEM

PLASTICITY CHART (COHESIVE SOIL ONLY)

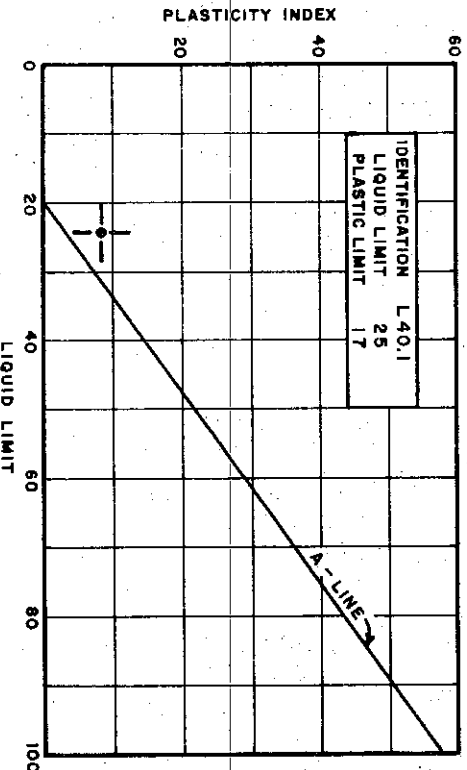

MATERIAL SOURCE

IDENTIFICATION : CLAYEY SAND (GC-SC)
 EXPLORATION: BORING 41
 SAMPLE : 29
 DEPTH : 130.7' TO 130.9'
 SPECIFIC GRAVITY = 2.69

THE DETROIT EDISON COMPANY
 BELLE RIVER PLANT UNITS I & II
 SOIL CLASSIFICATION TESTS

C-620

FILE NO. 1255 DATE JAN. 74

GRAIN SIZE DISTRIBUTION

U.S. STANDARD SIEVE SIZE

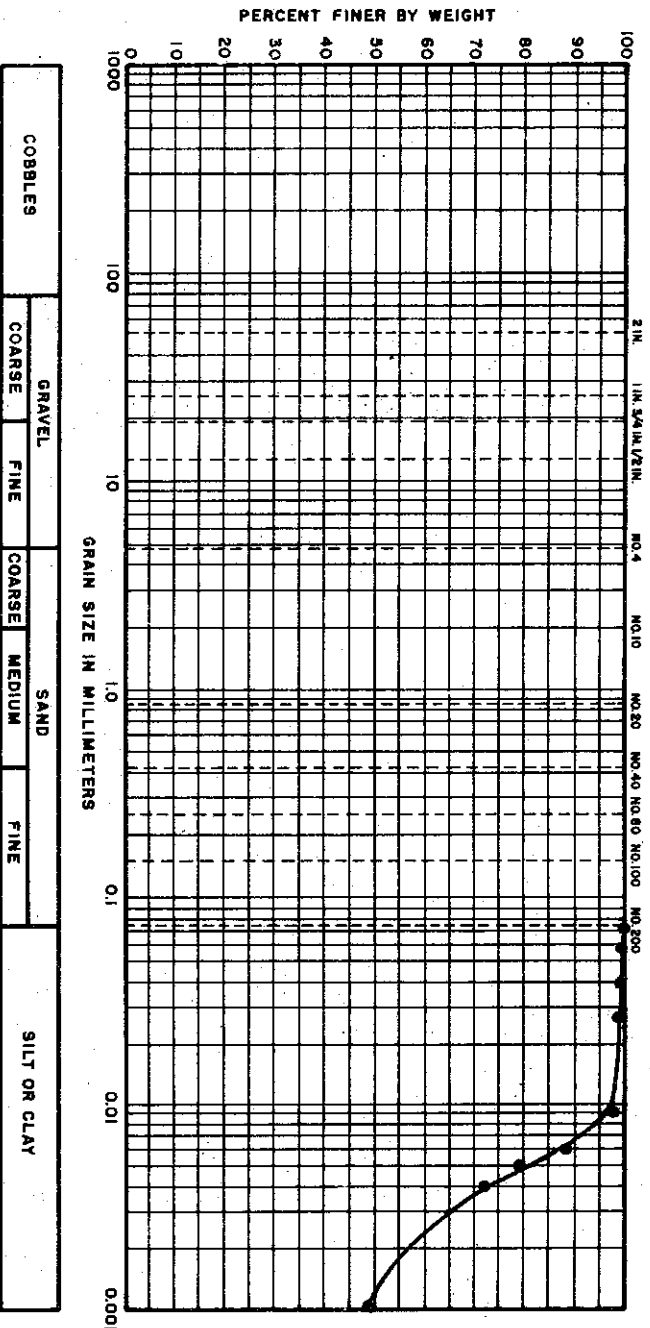

COBBLES	GRAVEL		SAND			SILT OR CLAY
	COARSE	FINE	COARSE	MEDIUM	FINE	

UNIFIED SOIL CLASSIFICATION SYSTEM

PLASTICITY CHART (COHESIVE SOIL ONLY)

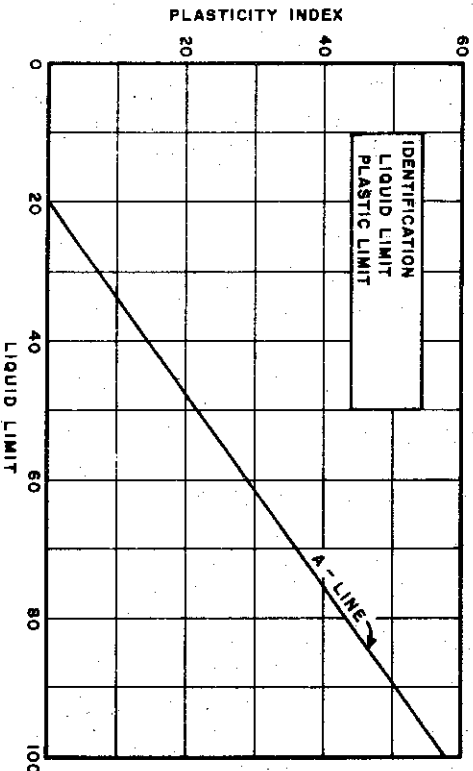

MATERIAL SOURCE

IDENTIFICATION : SILTY CLAY (CL-CH)
 EXPLORATION: BORING 48
 SAMPLE : 4
 DEPTH : 8' - 10'
 SPECIFIC GRAVITY : USED 2.70

THE DETROIT EDISON COMPANY
 BELLE RIVER PLANT UNITS I & II
 SOIL CLASSIFICATION TESTS

FILE NO. 1255 DATE MARCH 74

GRAIN SIZE DISTRIBUTION

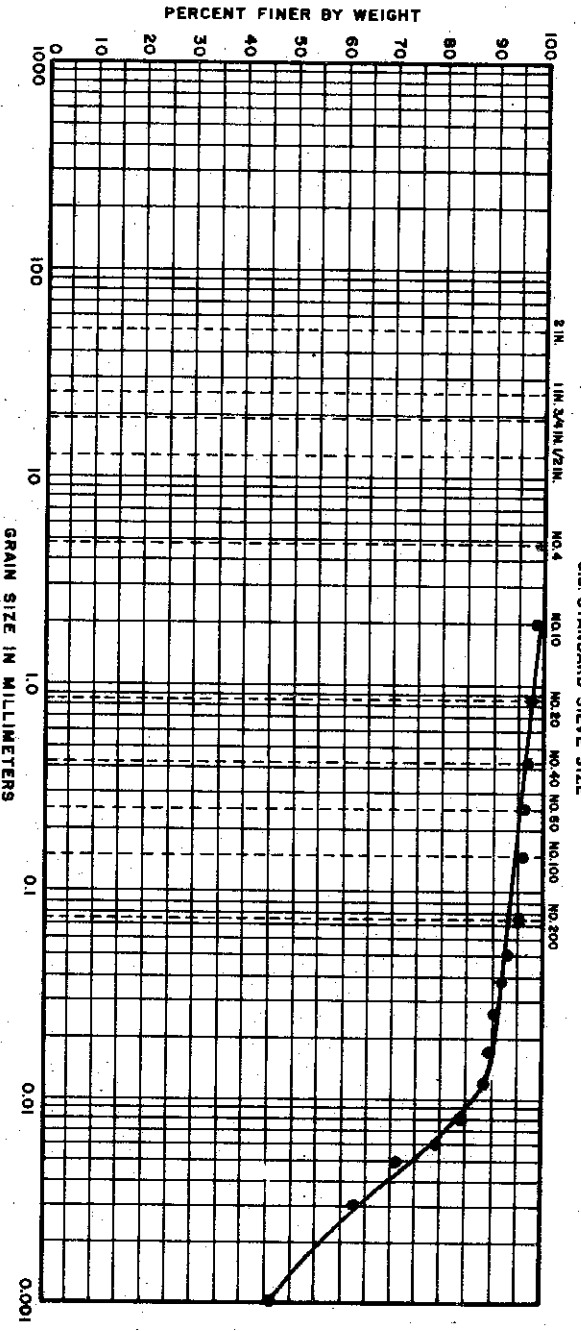

COBBLES	GRAVEL		SAND			SILT OR CLAY
	COARSE	FINE	COARSE	MEDIUM	FINE	

UNIFIED SOIL CLASSIFICATION SYSTEM

PLASTICITY CHART (COHESIVE SOIL ONLY)

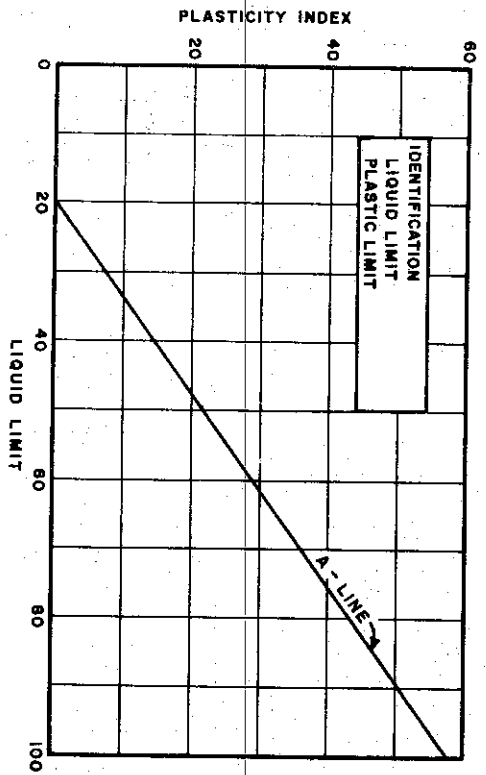

MATERIAL SOURCE

IDENTIFICATION : SILTY CLAY (CL)
 EXPLORATION: BORING 48
 SAMPLE : 26
 DEPTH : 118' - 120.6'
 SPECIFIC GRAVITY : USED 2.70

THE DETROIT EDISON COMPANY
 BELLE RIVER PLANT UNITS I & II
 SOIL CLASSIFICATION TESTS

C-622

FILE NO. 1255

DATE MARCH 74

GRAIN SIZE DISTRIBUTION

U.S. STANDARD SIEVE SIZE

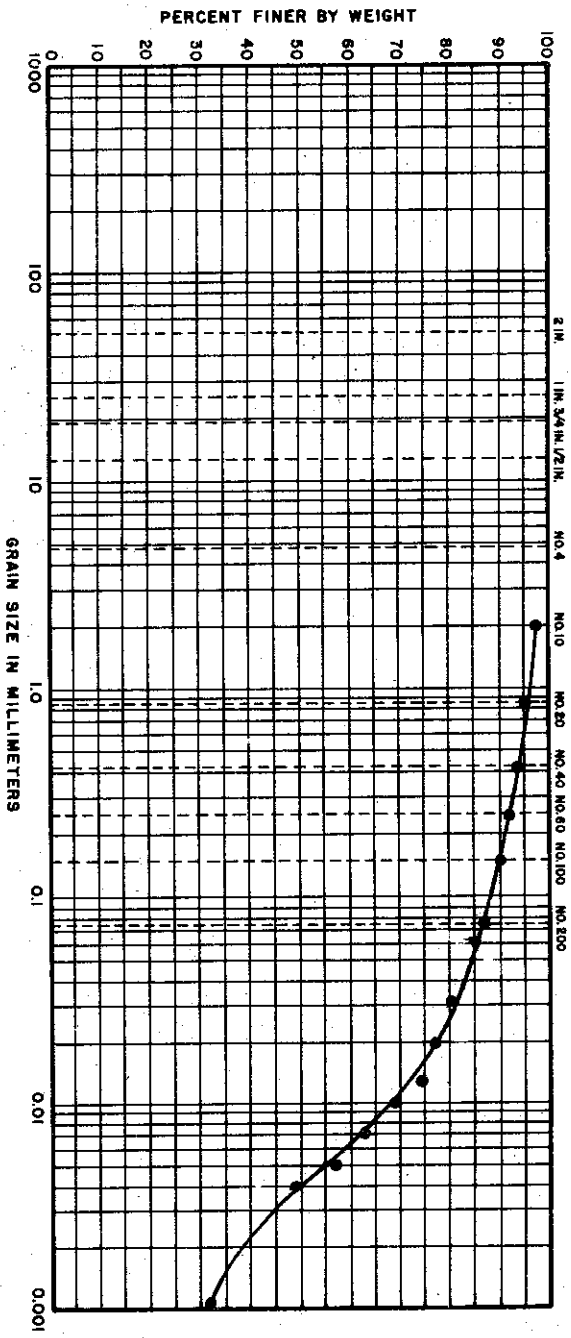

COBBLES	GRAVEL		SAND			SILT OR CLAY
	COARSE	FINE	COARSE	MEDIUM	FINE	

UNIFIED SOIL CLASSIFICATION SYSTEM

PLASTICITY CHART (COHESIVE SOIL ONLY)

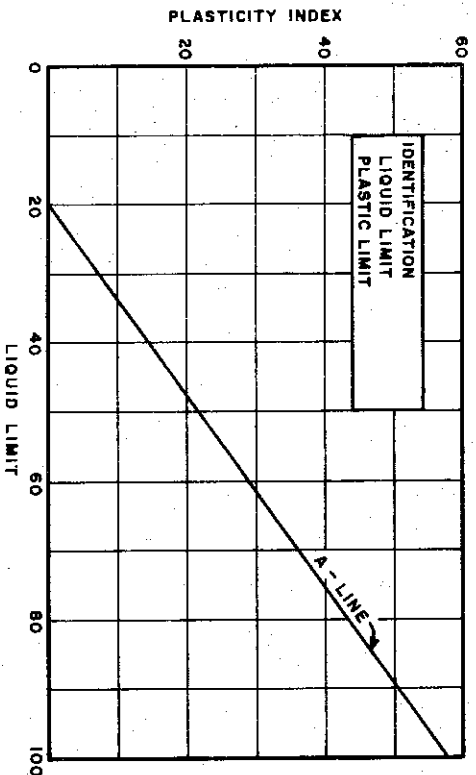

MATERIAL SOURCE

IDENTIFICATION : SILTY CLAY (CL)
 EXPLORATION: BORING 49
 SAMPLE : 7
 DEPTH : 53' - 55'
 SPECIFIC GRAVITY : USED 2.70

THE DETROIT EDISON COMPANY
 BELLE RIVER PLANT UNITS I & II
 SOIL CLASSIFICATION TESTS

FILE NO. 1255 DATE MARCH 74

GRAIN SIZE DISTRIBUTION

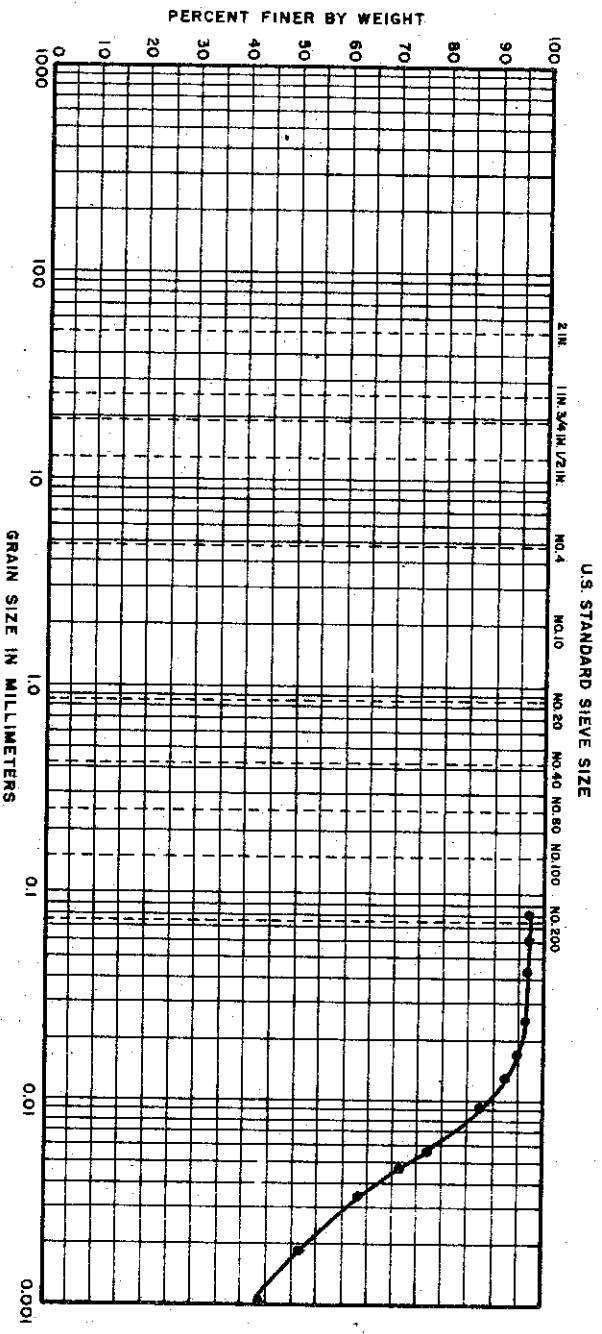

COBBLES	GRAVEL		SAND			SILT OR CLAY
	COARSE	FINE	COARSE	MEDIUM	FINE	

UNIFIED SOIL CLASSIFICATION SYSTEM

PLASTICITY CHART (COHESIVE SOIL ONLY)

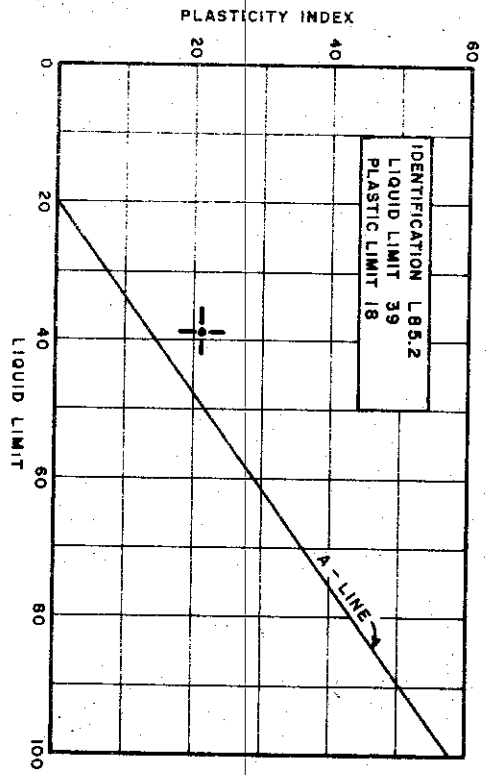

MATERIAL SOURCE

IDENTIFICATION: SILTY CLAY (CL)
 EXPLORATION: BORING 50
 SAMPLE: 6
 DEPTH: 28.3' TO 28.5'
 SPECIFIC GRAVITY: USED 2.70

THE DETROIT EDISON COMPANY
 BELLE RIVER PLANT UNITS I & II
 SOIL CLASSIFICATION TESTS

C-624

FILE NO. 1255
 DATE JULY 1974

GRAIN SIZE DISTRIBUTION

U.S. STANDARD SIEVE SIZE

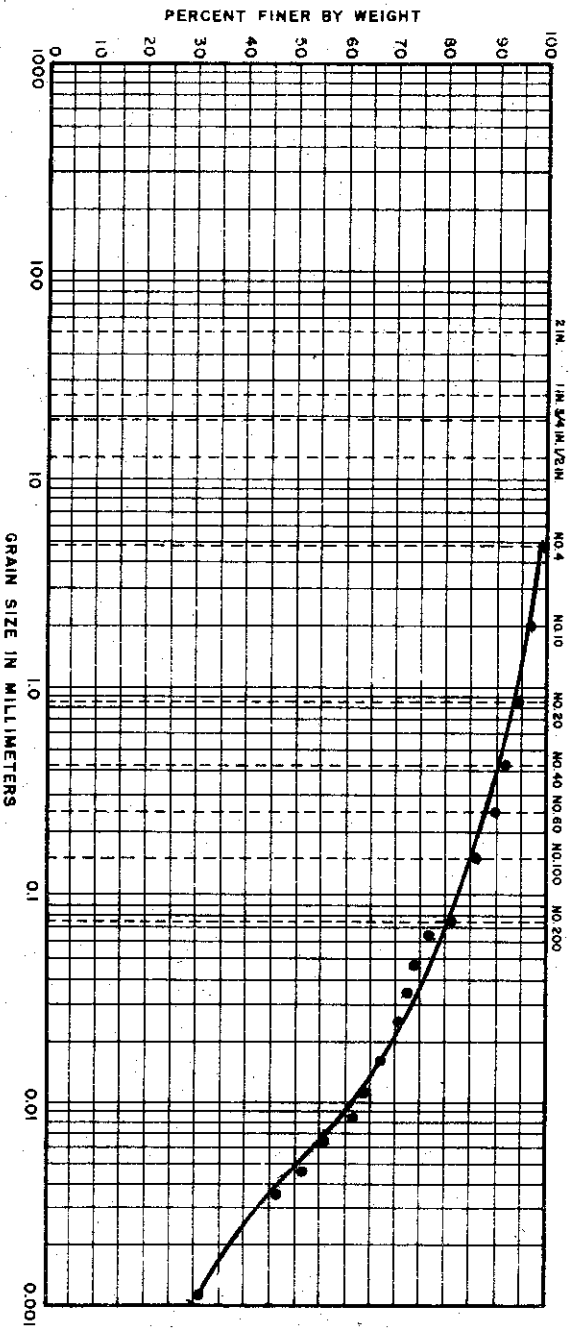

COBBLES	GRAVEL		SAND			SILT OR CLAY
	COARSE	FINE	COARSE	MEDIUM	FINE	

UNIFIED SOIL CLASSIFICATION SYSTEM

PLASTICITY CHART (COHESIVE SOIL ONLY)

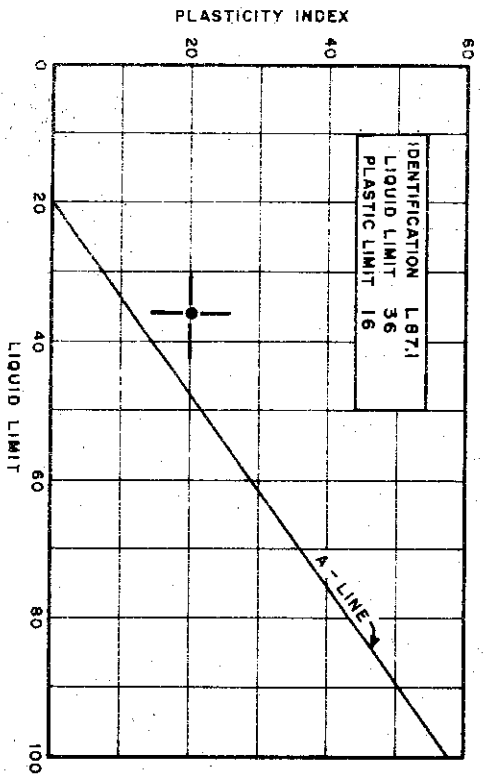

MATERIAL SOURCE

IDENTIFICATION: SILTY CLAY, SANDY (CL)
 EXPLORATION: BORING 50
 SAMPLE: 10
 DEPTH: 48.6' TO 48.8'
 SPECIFIC GRAVITY: USED 2.70

THE DETROIT EDISON COMPANY
 BELLE RIVER PLANT UNITS I & II
 SOIL CLASSIFICATION TESTS

GRAIN SIZE DISTRIBUTION

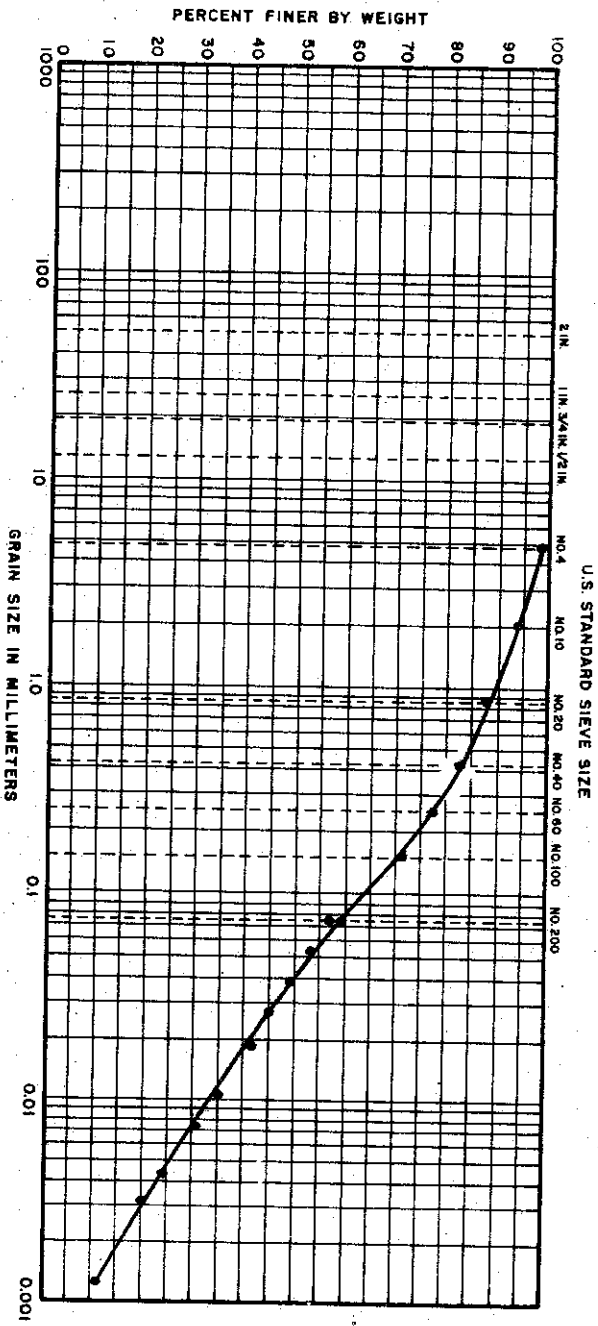

COBBLES	GRAVEL		SAND			SILT OR CLAY
	COARSE	FINE	COARSE	MEDIUM	FINE	

UNIFIED SOIL CLASSIFICATION SYSTEM

PLASTICITY CHART (COHESIVE SOIL ONLY)

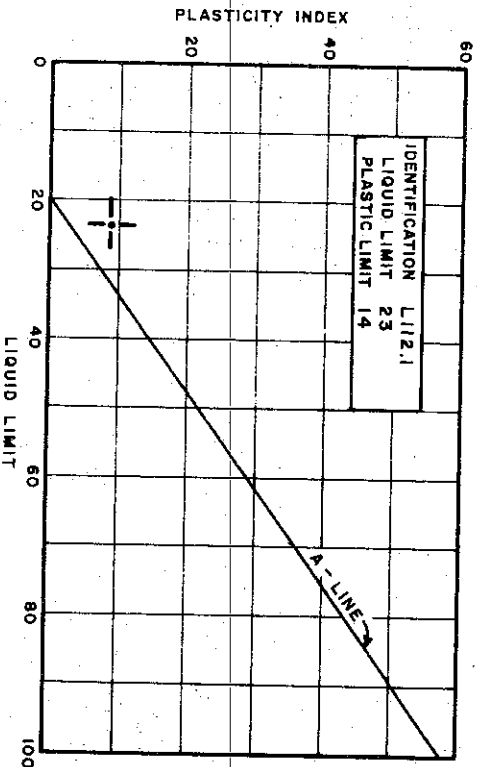

MATERIAL SOURCE

IDENTIFICATION : SILTY CLAY, SANDY (CL.)
 EXPLORATION: BORING 52
 SAMPLE : 7
 DEPTH : 58.6' TO 58.9'
 SPECIFIC GRAVITY: USED 2.70

THE DETROIT EDISON COMPANY
 BELLE RIVER PLANT UNITS I & II
 SOIL CLASSIFICATION TESTS

C-626

GOLDBERG - ZOINO & ASSOCIATES
 CONSULTANTS IN GEOTECHNICAL ENGINEERING

FILE NO. 1255 DATE JULY 1974

GRAIN SIZE DISTRIBUTION

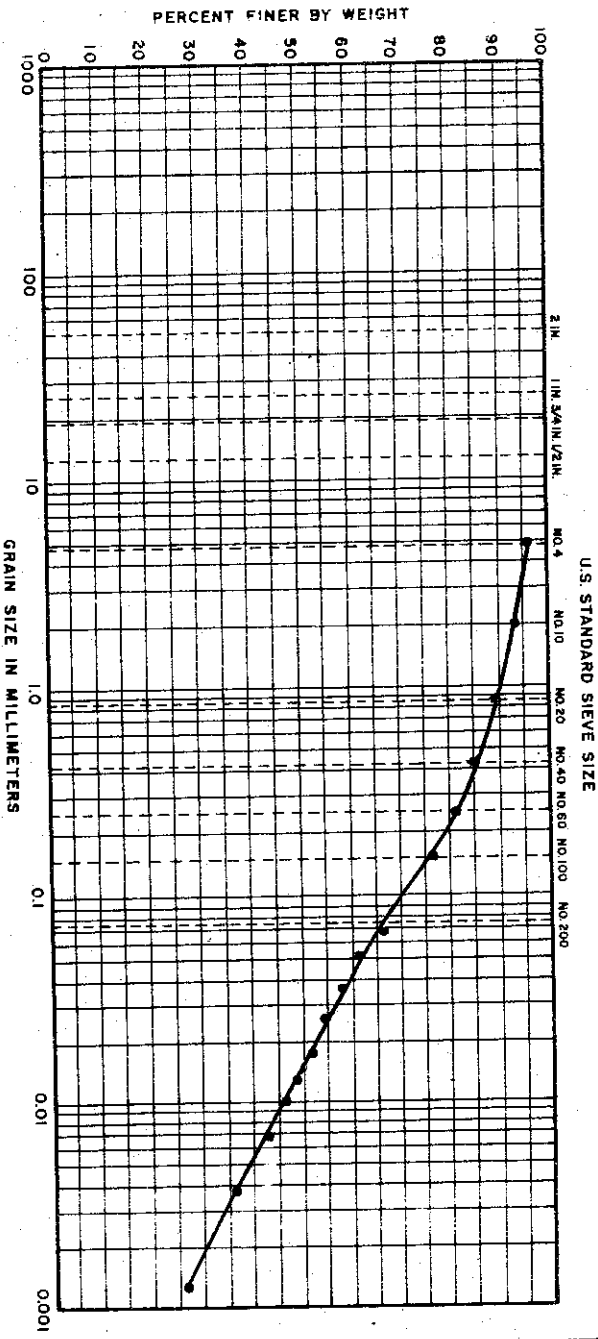

COBBLES	GRAVEL		SAND			SILT OR CLAY
	COARSE	FINE	COARSE	MEDIUM	FINE	

UNIFIED SOIL CLASSIFICATION SYSTEM

PLASTICITY CHART (COHESIVE SOIL ONLY)

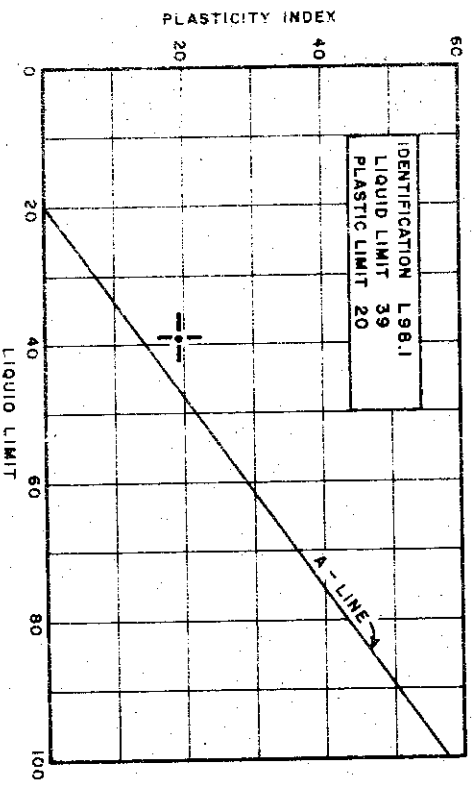

MATERIAL SOURCE

IDENTIFICATION: SILTY CLAY, SANDY (CL)
 EXPLORATION BORING: 53
 SAMPLE: 5
 DEPTH: 39.8' TO 39.8'
 SPECIFIC GRAVITY: 2.72

THE DETROIT EDISON COMPANY
 BELLE RIVER PLANT UNITS I & II
 SOIL CLASSIFICATION TESTS

GRAIN SIZE DISTRIBUTION

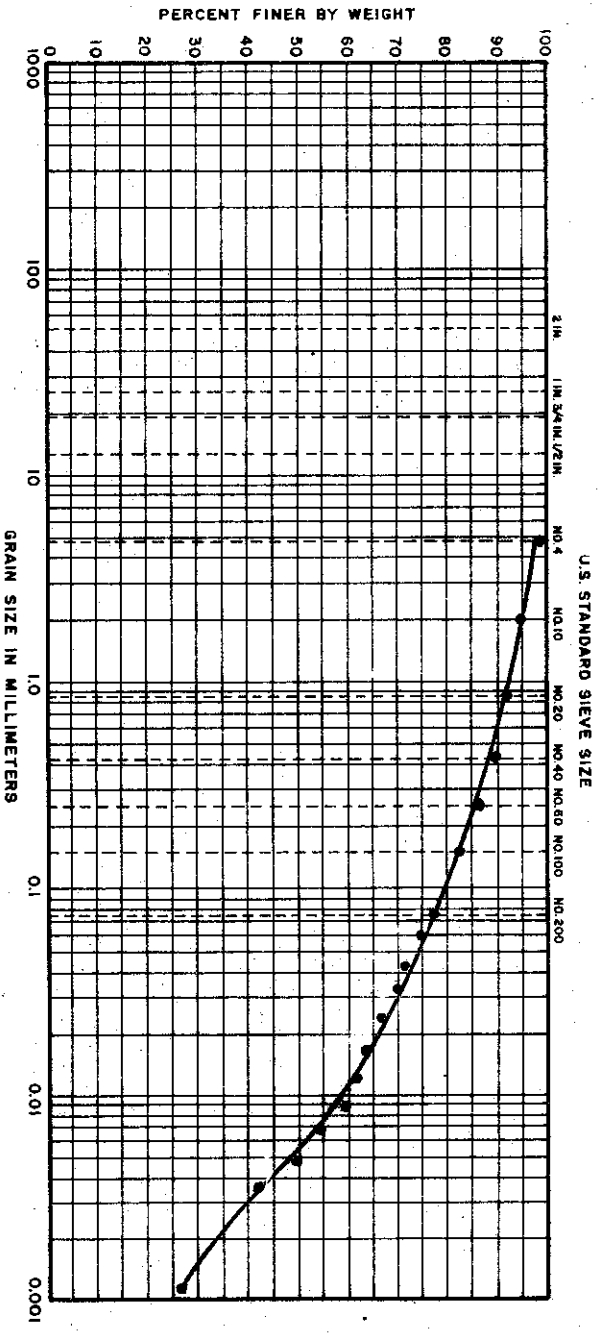

COBBLES	GRAVEL		SAND			SILT OR CLAY
	COARSE	FINE	COARSE	MEDIUM	FINE	

UNIFIED SOIL CLASSIFICATION SYSTEM

PLASTICITY CHART (COHESIVE SOIL ONLY)

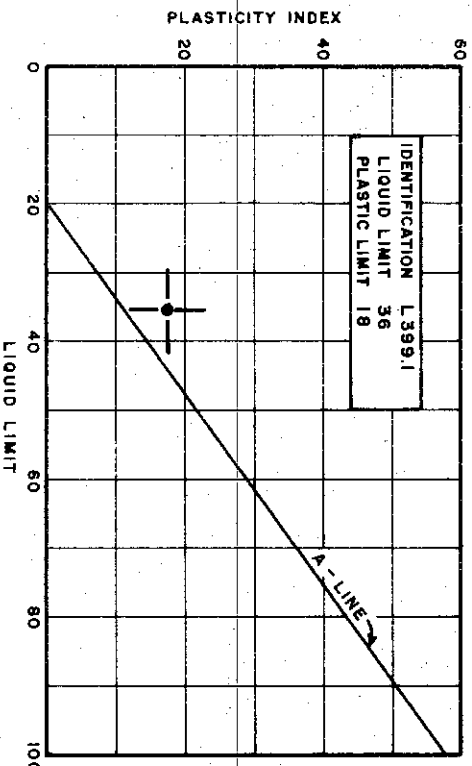

MATERIAL SOURCE

IDENTIFICATION: SILTY CLAY, SANDY (CL)

EXPLORATION: BORING 54

SAMPLE: 6

DEPTH: 63.5' TO 63.8'

SPECIFIC GRAVITY: 2.71

THE DETROIT EDISON COMPANY
BELLE RIVER PLANT UNITS I & II
SOIL CLASSIFICATION TESTS

C-628

FILE NO. 1255 DATE JULY 1974

GRAIN SIZE DISTRIBUTION

U.S. STANDARD SIEVE SIZE

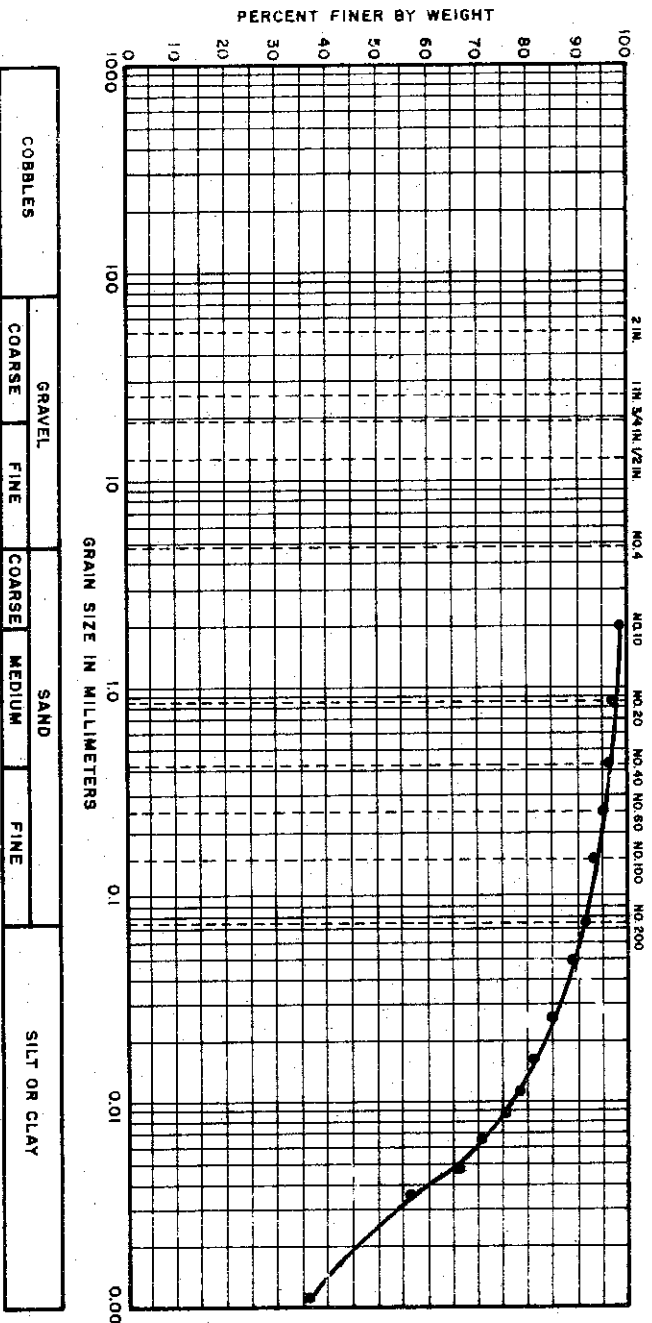

PLASTICITY CHART (COHESIVE SOIL ONLY)

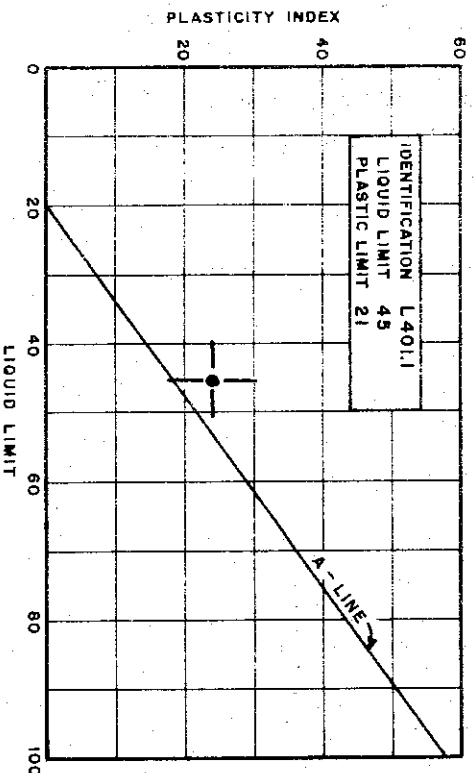

MATERIAL SOURCE

IDENTIFICATION : SILTY CLAY (CL)
EXPLORATION : BORING 54
SAMPLE : 8
DEPTH : 73.7' TO 74.0'
SPECIFIC GRAVITY : 2.73

THE DETROIT EDISON COMPANY
BELLE RIVER PLANT UNITS I & II
SOIL CLASSIFICATION TESTS

FILE NO. 1255 DATE JULY 1974

GRAIN SIZE DISTRIBUTION

U.S. STANDARD SIEVE SIZE

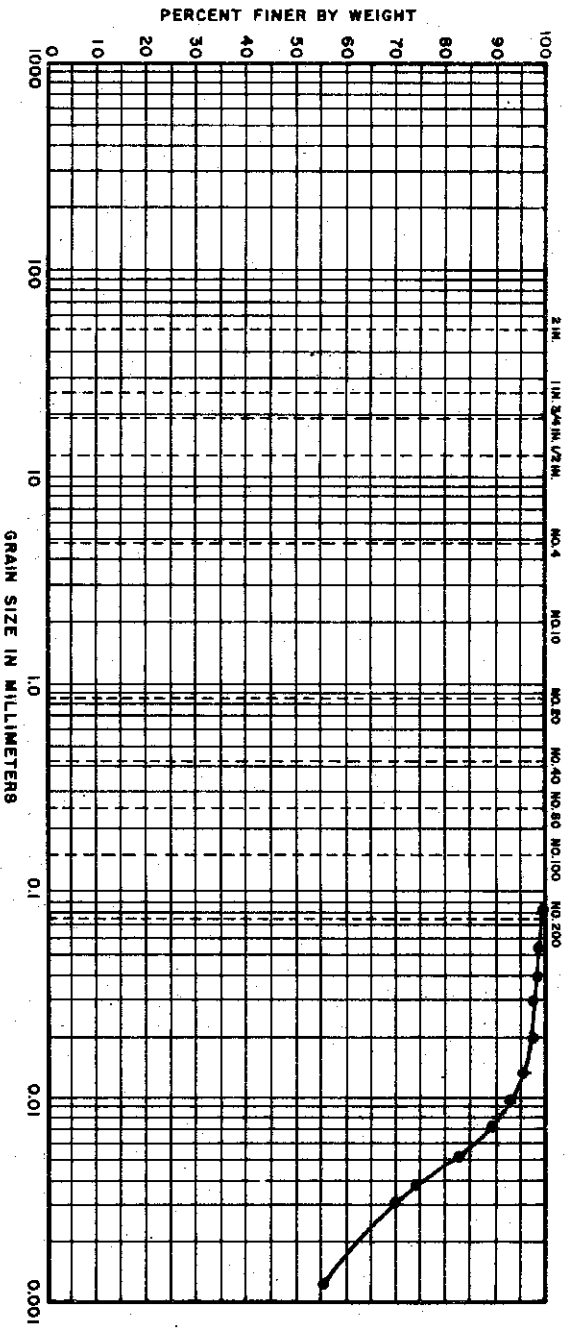

COBBLES	GRAVEL		SAND			SILT OR CLAY
	COARSE	FINE	COARSE	MEDIUM	FINE	

UNIFIED SOIL CLASSIFICATION SYSTEM

PLASTICITY CHART (COHESIVE SOIL ONLY)

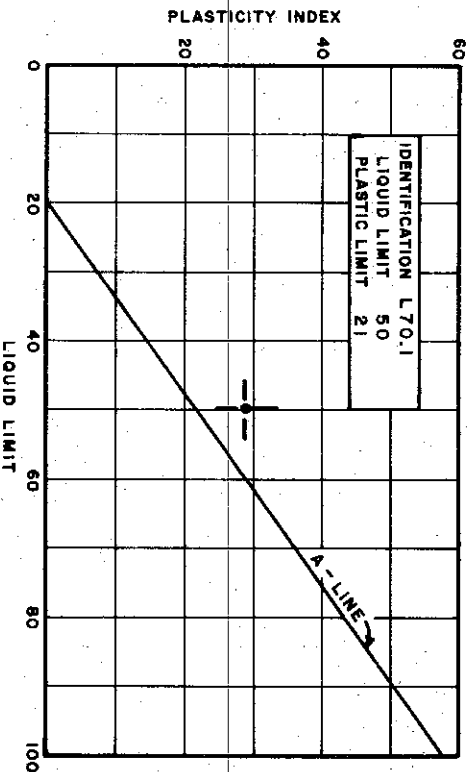

IDENTIFICATION L70.1
LIQUID LIMIT 50
PLASTIC LIMIT 21

MATERIAL SOURCE

IDENTIFICATION : SILTY CLAY (CL-CH)
EXPLORATION: BORING 60
SAMPLE : SS1
DEPTH : 5.0' TO 6.5'
SPECIFIC GRAVITY : USED 2.70

THE DETROIT EDISON COMPANY
BELLE RIVER PLANT UNITS I & II
SOIL CLASSIFICATION TESTS

C-630

FILE NO. 1255

DATE JAN. 74

GRAIN SIZE DISTRIBUTION

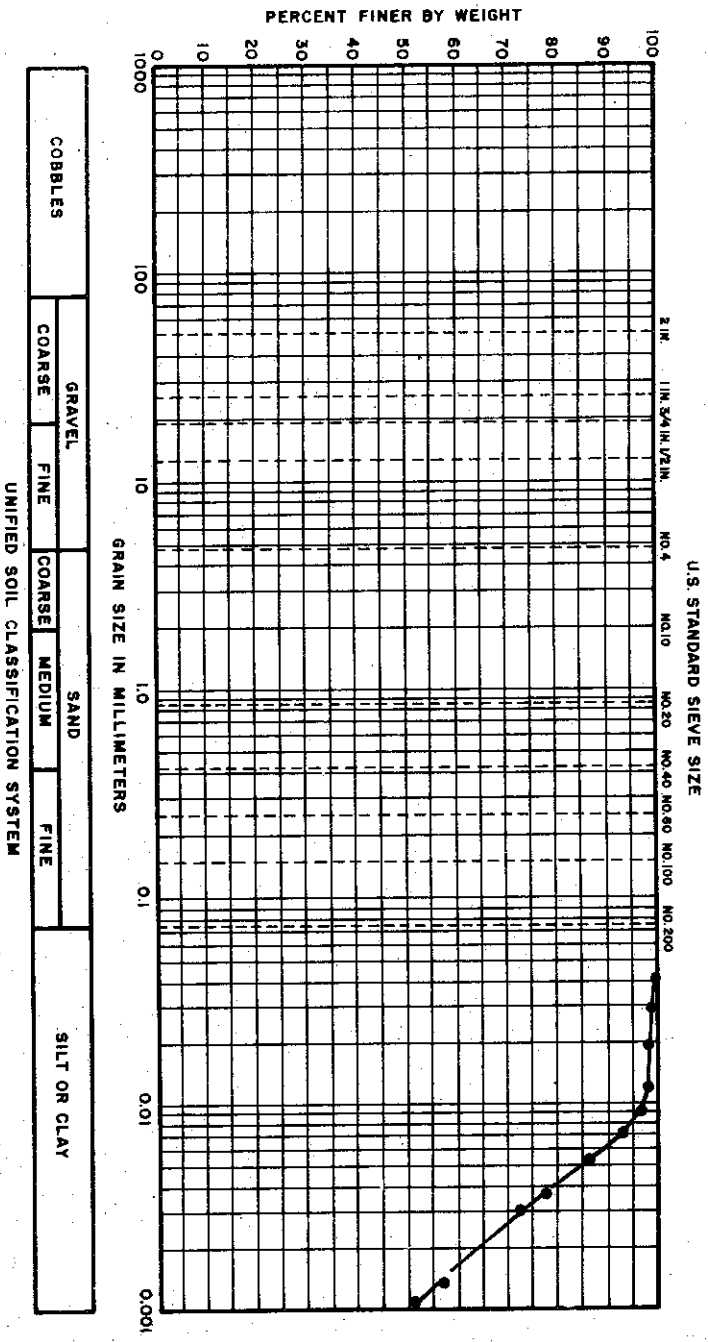

PLASTICITY CHART (COHESIVE SOIL ONLY)

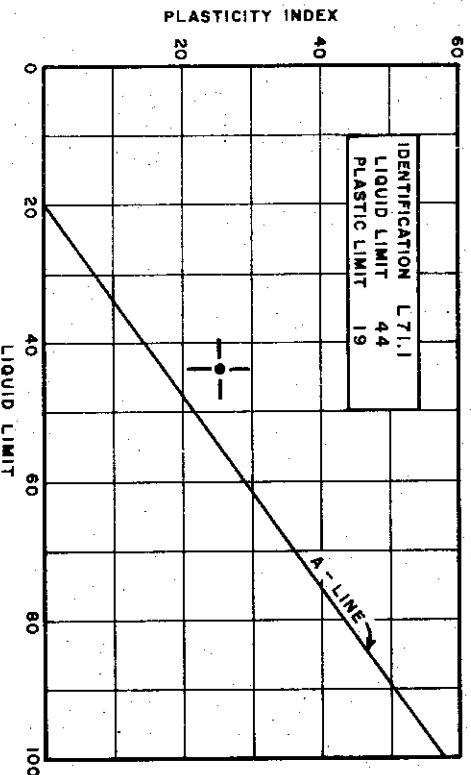

MATERIAL SOURCE

IDENTIFICATION : SILTY CLAY (CL)

EXPLORATION: BORING 60

SAMPLE : SS2

DEPTH : 10' TO 12.5'

SPECIFIC GRAVITY : USED 2.70

THE DETROIT EDISON COMPANY
BELLE RIVER PLANT UNITS I & II
SOIL CLASSIFICATION TESTS

FILE NO. 1255 DATE JAN. 74

GRAIN SIZE DISTRIBUTION

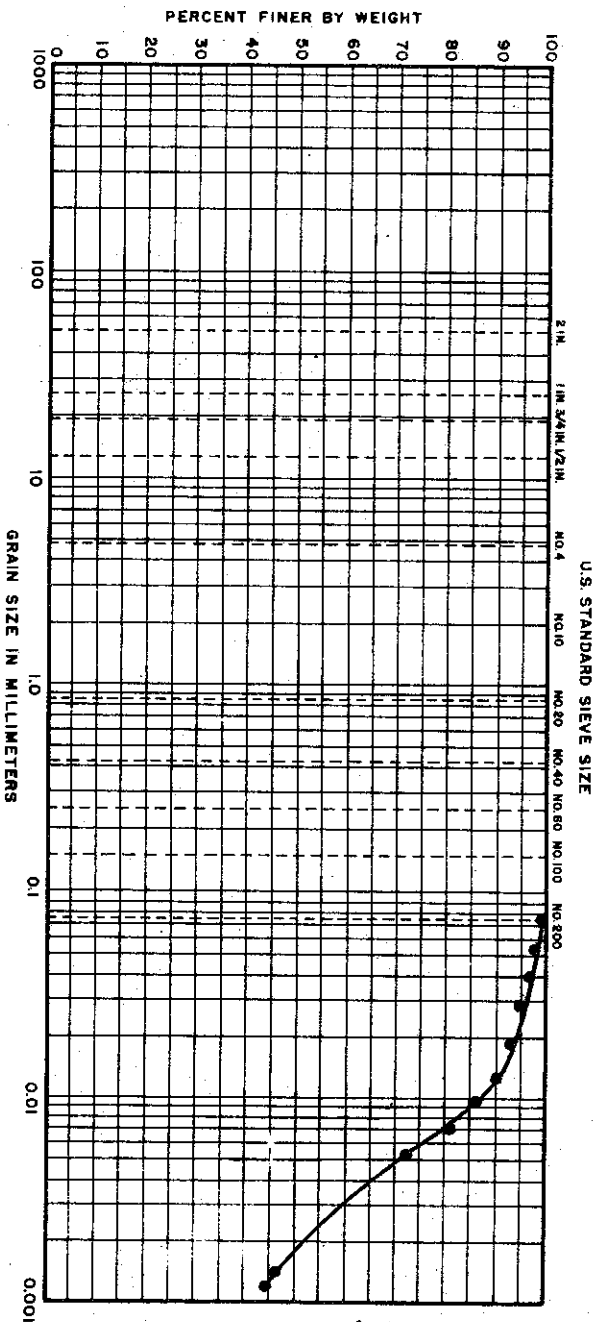

COBBLES	GRAVEL		SAND			SILT OR CLAY
	COARSE	FINE	COARSE	MEDIUM	FINE	

UNIFIED SOIL CLASSIFICATION SYSTEM

PLASTICITY CHART (COHESIVE SOIL ONLY)

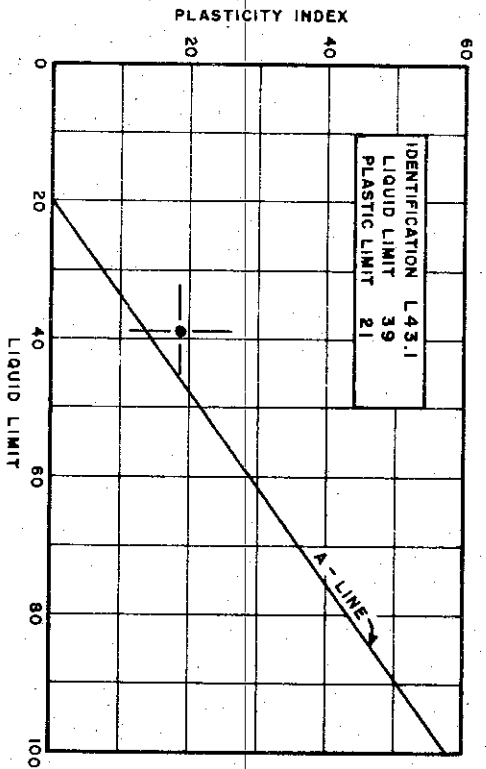

MATERIAL SOURCE

IDENTIFICATION: SILTY CLAY (CL)
 EXPLORATION: BORING 60
 SAMPLE: 3
 DEPTH: 18.1' TO 18.3'
 SPECIFIC GRAVITY ASSUMED 2.70

THE DETROIT EDISON COMPANY
 BELLE RIVER PLANT UNITS I & II
 SOIL CLASSIFICATION TESTS

GRAIN SIZE DISTRIBUTION

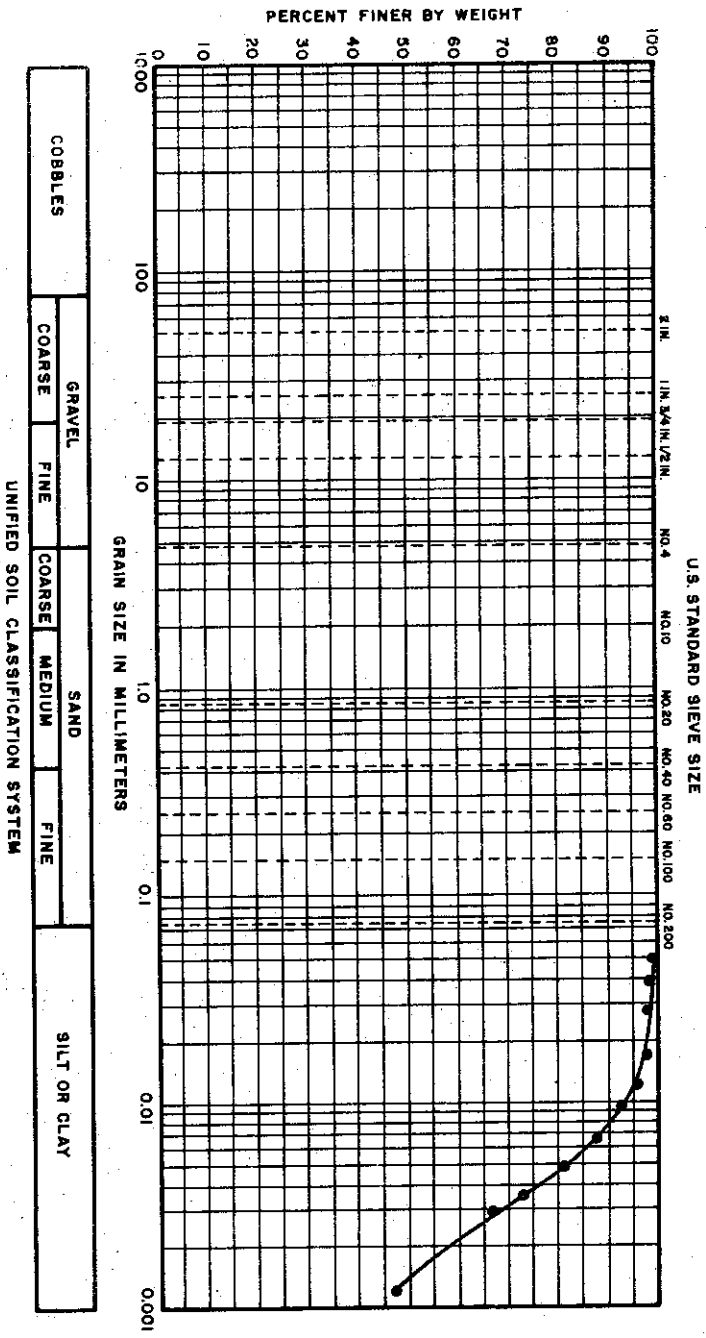

PLASTICITY CHART (COHESIVE SOIL ONLY)

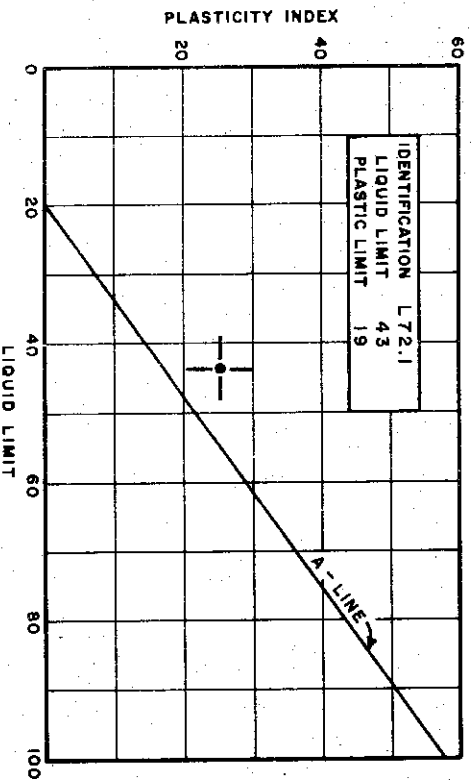

MATERIAL SOURCE

IDENTIFICATION: SILTY CLAY (CL)

EXPLORATION: BORING 60

SAMPLE: 553

DEPTH: 19' TO 20.5'

SPECIFIC GRAVITY: USED 2.70

THE DETROIT EDISON COMPANY
BELLE RIVER PLANT UNITS I & II
SOIL CLASSIFICATION TESTS

FILE NO. 1255 DATE JAN. 74

GRAIN SIZE DISTRIBUTION

U.S. STANDARD SIEVE SIZE

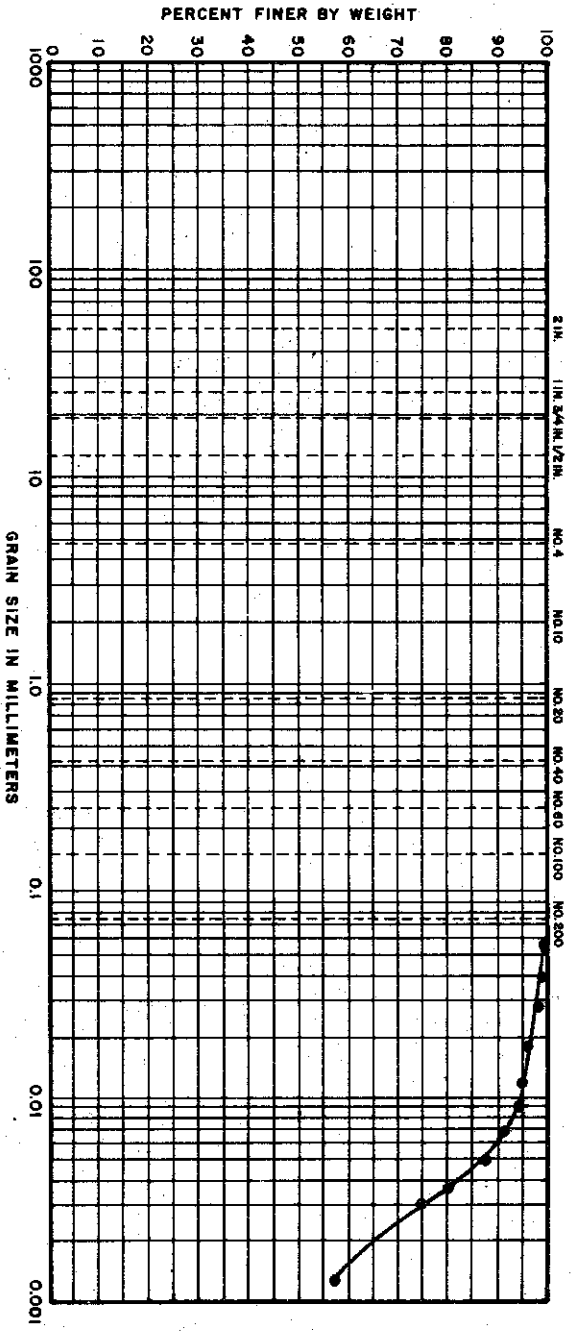

COBBLES	GRAVEL		SAND			SILT OR CLAY
	COARSE	FINE	COARSE	MEDIUM	FINE	

UNIFIED SOIL CLASSIFICATION SYSTEM

PLASTICITY CHART (COHESIVE SOIL ONLY)

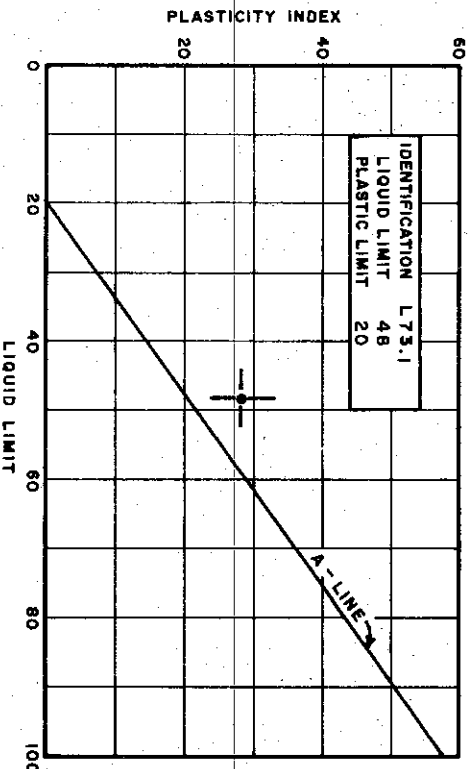

MATERIAL SOURCE

IDENTIFICATION : SILTY CLAY (CL-CH)
 EXPLORATION: BORING 60
 SAMPLE : SS 5
 DEPTH : 27' TO 28.5'
 SPECIFIC GRAVITY: USED 2.70

THE DETROIT EDISON COMPANY
 BELLE RIVER PLANT UNITS I & II
 SOIL CLASSIFICATION TESTS

C-634

FILE NO. 1255 DATE JAN. 74

GRAIN SIZE DISTRIBUTION

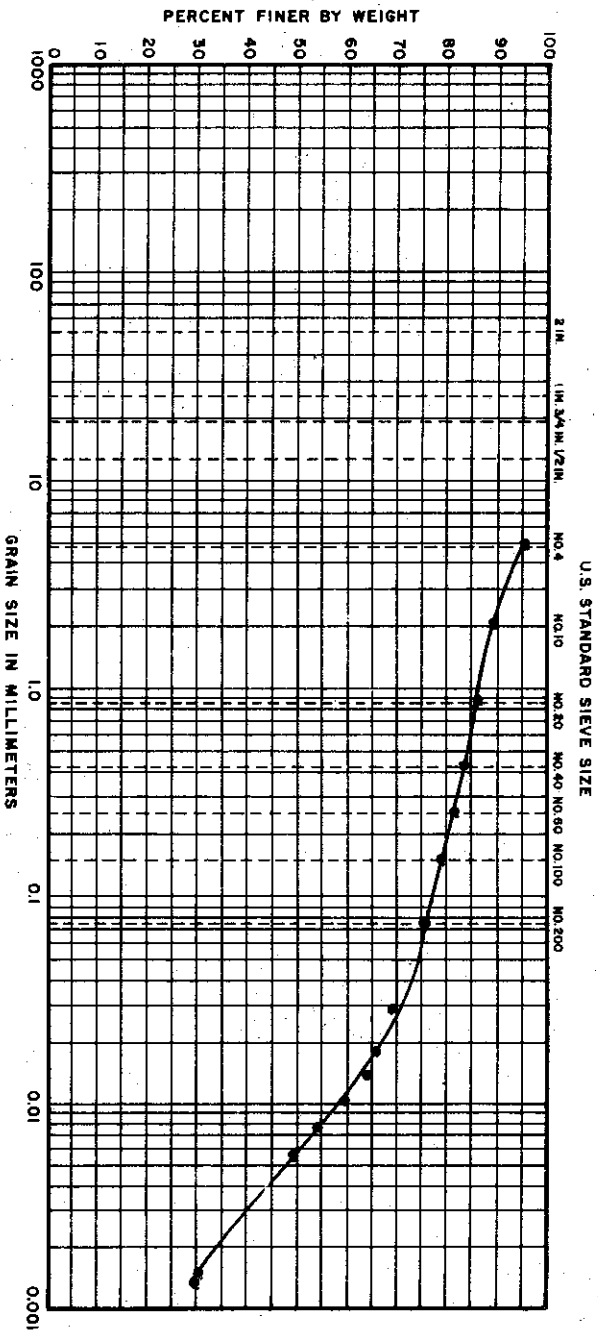

COBBLES	GRAVEL		SAND				SILT OR CLAY
	COARSE	FINE	COARSE	MEDIUM	FINE		

UNIFIED SOIL CLASSIFICATION SYSTEM

PLASTICITY CHART (COHESIVE SOIL ONLY)

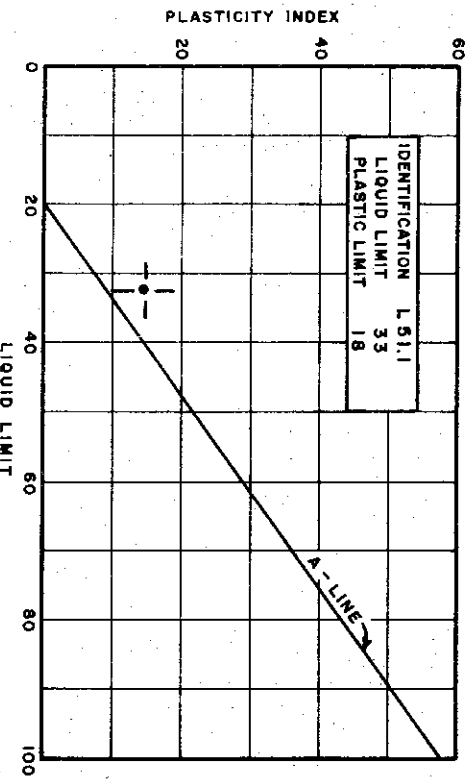

MATERIAL SOURCE

IDENTIFICATION: SILTY CLAY (CL)
 EXPLORATION: BORING 60
 SAMPLE : 11
 DEPTH : 56.1' TO 56.4'
 SPECIFIC GRAVITY ASSUMED 2.70

THE DETROIT EDISON COMPANY
 BELLE RIVER PLANT UNITS I & II
 SOIL CLASSIFICATION TESTS

FILE NO. 1255
 DATE MARCH 74

GRAIN SIZE DISTRIBUTION

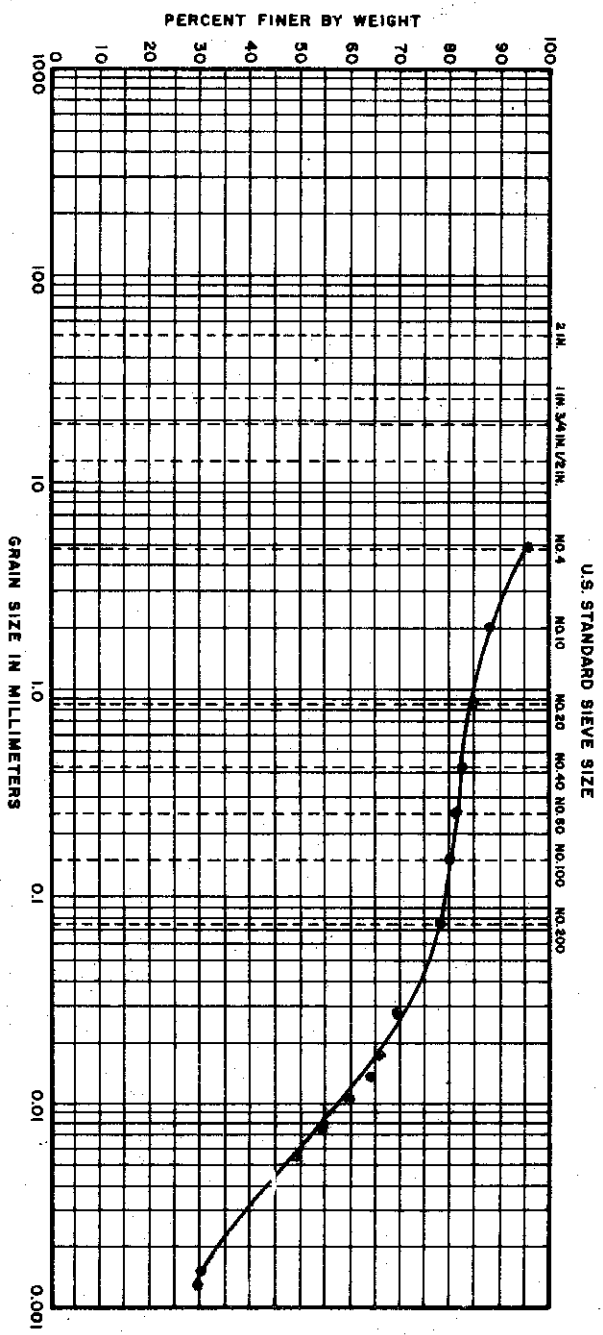

COBBLES	GRAVEL		SAND			SILT OR CLAY
	COARSE	FINE	COARSE	MEDIUM	FINE	

UNIFIED SOIL CLASSIFICATION SYSTEM

PLASTICITY CHART (COHESIVE SOIL ONLY)

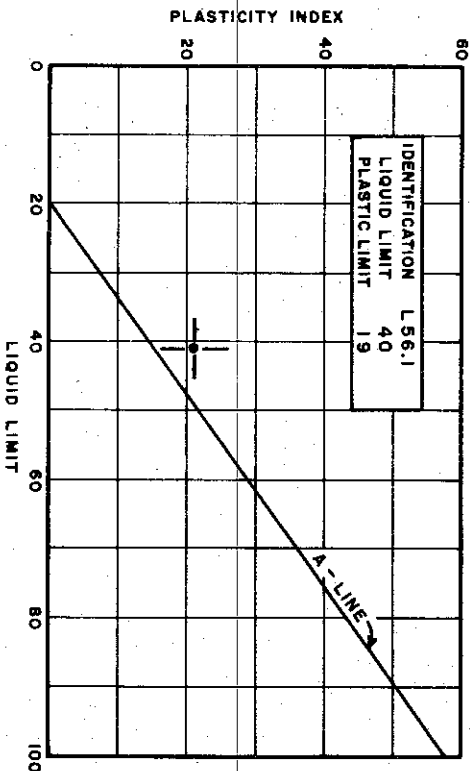

MATERIAL SOURCE

IDENTIFICATION: SILTY CLAY (CL)
 EXPLORATION: BORING 60
 SAMPLE: 16
 DEPTH: 85.6' TO 86.1'
 SPECIFIC GRAVITY 2.73

THE DETROIT EDISON COMPANY
 BELLE RIVER PLANT UNITS I & II
 SOIL CLASSIFICATION TESTS

C-636

FILE NO. 1255 DATE MARCH 74

GRAIN SIZE DISTRIBUTION

U.S. STANDARD SIEVE SIZE

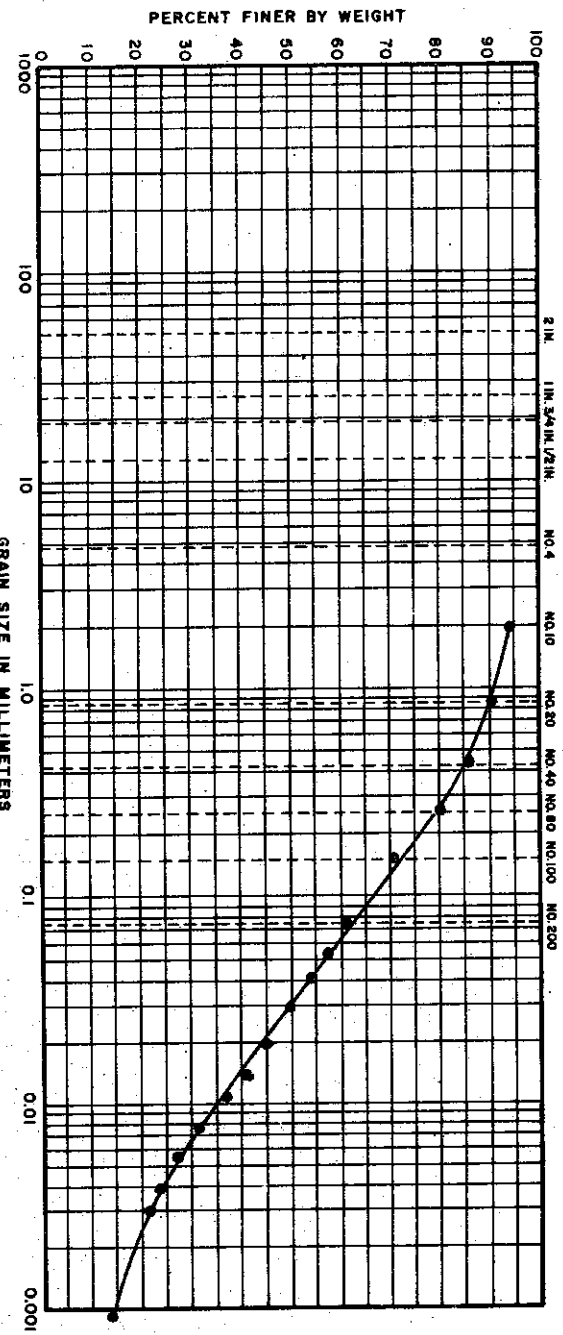

COBBLES	GRAVEL		SAND			SILT OR CLAY
	COARSE	FINE	COARSE	MEDIUM	FINE	

UNIFIED SOIL CLASSIFICATION SYSTEM

PLASTICITY CHART (COHESIVE SOIL ONLY)

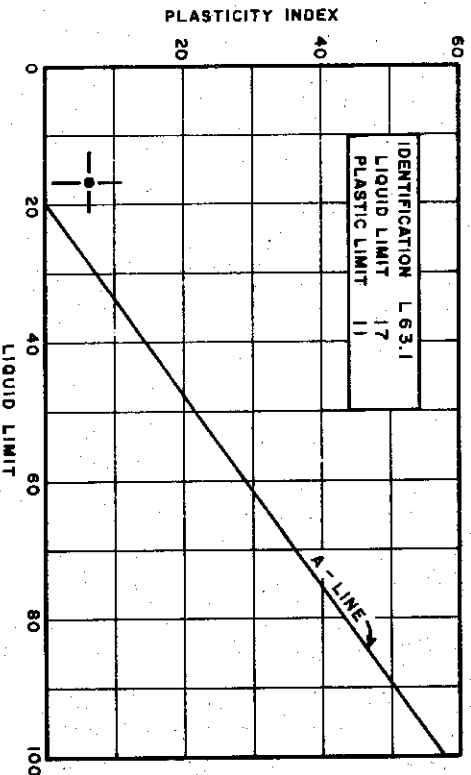

IDENTIFICATION L 63.1
LIQUID LIMIT 17
PLASTIC LIMIT 11

MATERIAL SOURCE

IDENTIFICATION : SILTY CLAY, SANDY (CL)

EXPLORATION: BORING 60

SAMPLE : 23

DEPTH : 119.5' TO 119.9'

SPECIFIC GRAVITY : USED 2.70

THE DETROIT EDISON COMPANY
BELLE RIVER PLANT UNITS I & II
SOIL CLASSIFICATION TESTS

FILE NO. 1255 DATE JAN. 74

GRAIN SIZE DISTRIBUTION

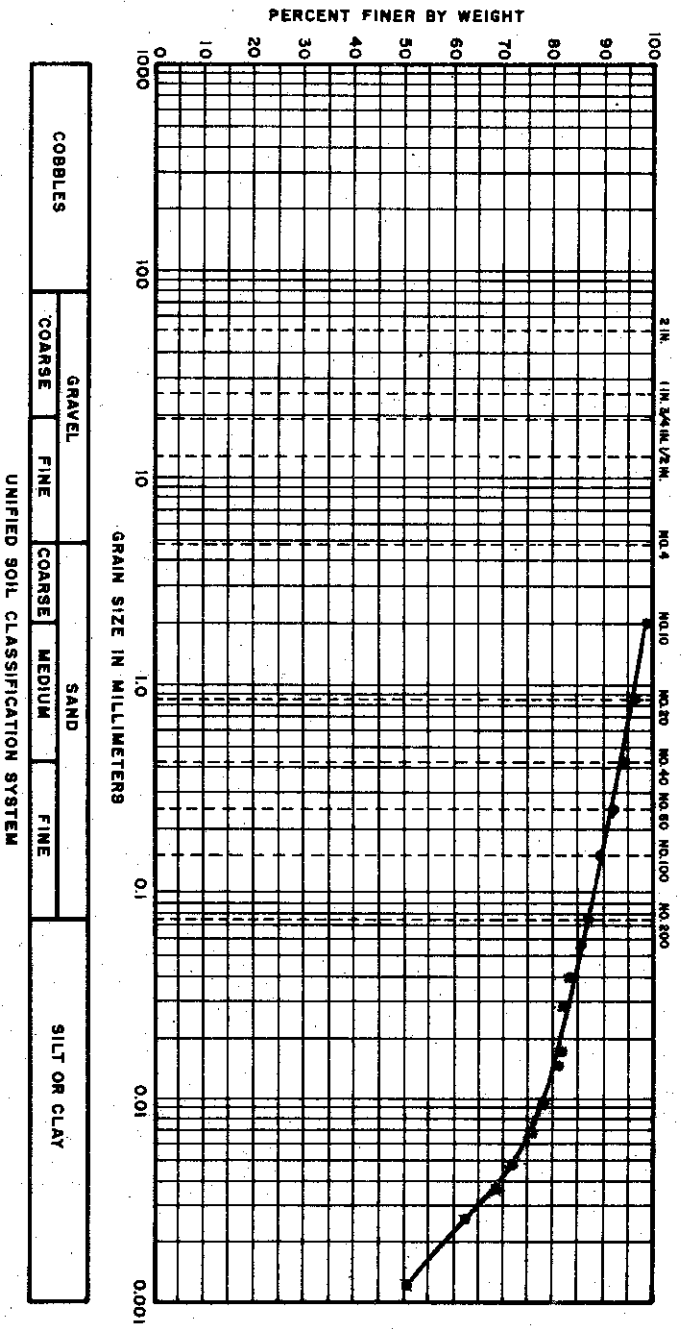

PLASTICITY CHART

(COHESIVE SOIL ONLY)

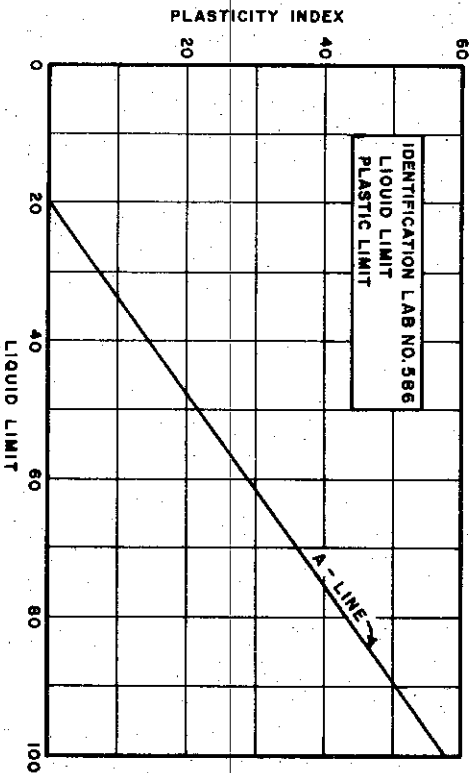

MATERIAL SOURCE

IDENTIFICATION : SILTY CLAY (CL-CH)
 EXPLORATION: BORING 137
 SAMPLE : SS1
 DEPTH : 1.5' TO 3.0'
 SPECIFIC GRAVITY : USED 2.70

THE DETROIT EDISON COMPANY
 BELLE RIVER PLANT UNITS I & II
 SOIL CLASSIFICATION TESTS

C-638

FILE NO. 1255

DATE NOV. 1974

GRAIN SIZE DISTRIBUTION

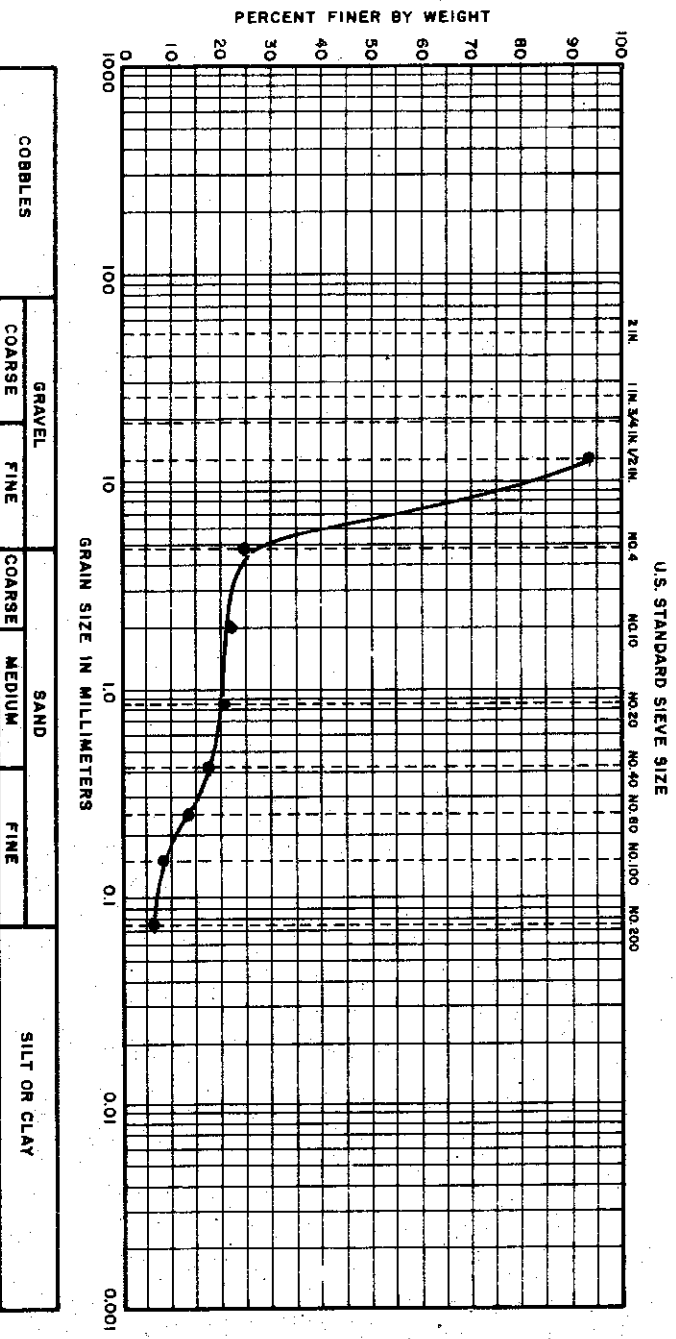

PLASTICITY CHART (COHESIVE SOIL ONLY)

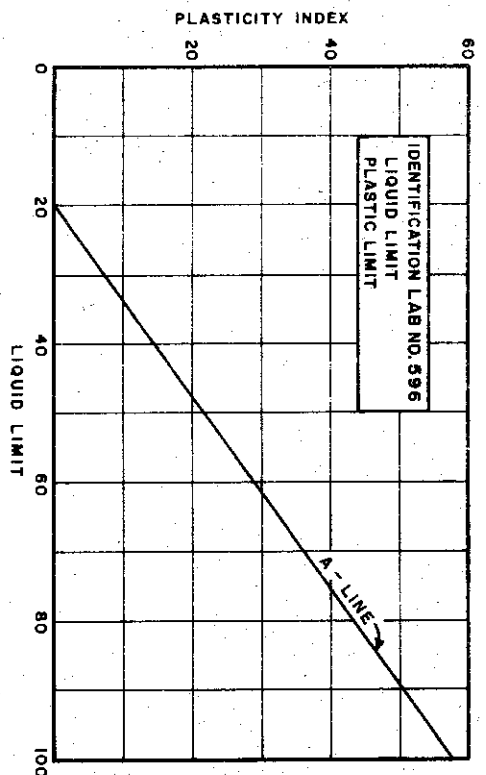

MATERIAL SOURCE

IDENTIFICATION : GRAVEL (GP)
 EXPLORATION: BORING 139
 SAMPLE : SS22
 DEPTH : 99.5' TO 101.0'

SPECIFIC GRAVITY

THE DETROIT EDISON COMPANY
 BELLE RIVER PLANT UNITS I & II
 SOIL CLASSIFICATION TESTS

FILE NO. 1255 DATE NOV. 1974

GRAIN SIZE DISTRIBUTION

U.S. STANDARD SIEVE SIZE

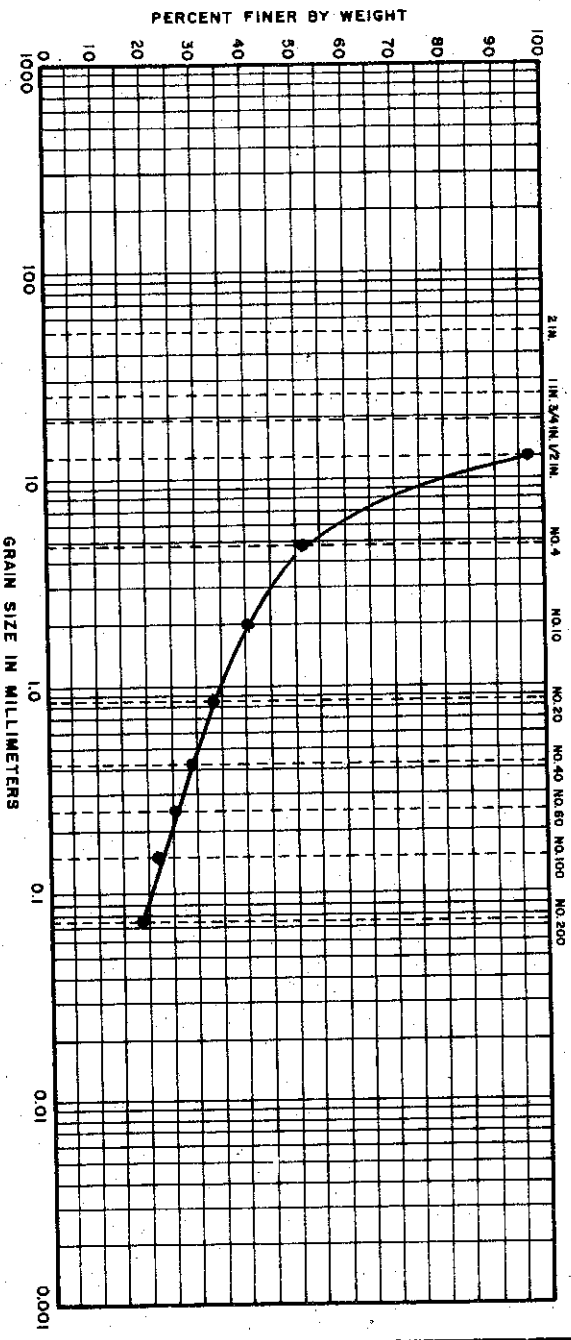

COBBLES	GRAVEL		SAND			SILT OR CLAY
	COARSE	FINE	COARSE	MEDIUM	FINE	

UNIFIED SOIL CLASSIFICATION SYSTEM

PLASTICITY CHART (COHESIVE SOIL ONLY)

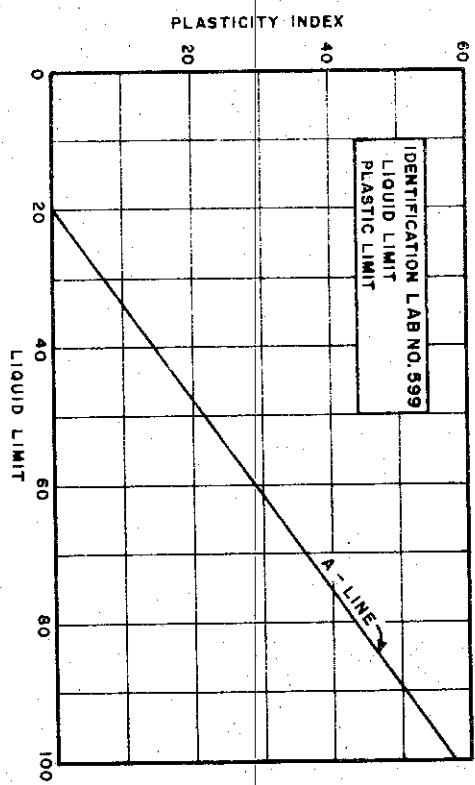

IDENTIFICATION LAB NO. 599
LIQUID LIMIT
PLASTIC LIMIT

MATERIAL SOURCE

IDENTIFICATION : SANDY GRAVEL (GM)
EXPLORATION: BORING 141
SAMPLE : SS21
DEPTH : 114.6' TO 116.0'
SPECIFIC GRAVITY

THE DETROIT EDISON COMPANY
BELLE RIVER PLANT UNITS I & II
SOIL CLASSIFICATION TESTS

C-640

FILE NO. 1255

DATE NOV. 1974

GRAIN SIZE DISTRIBUTION

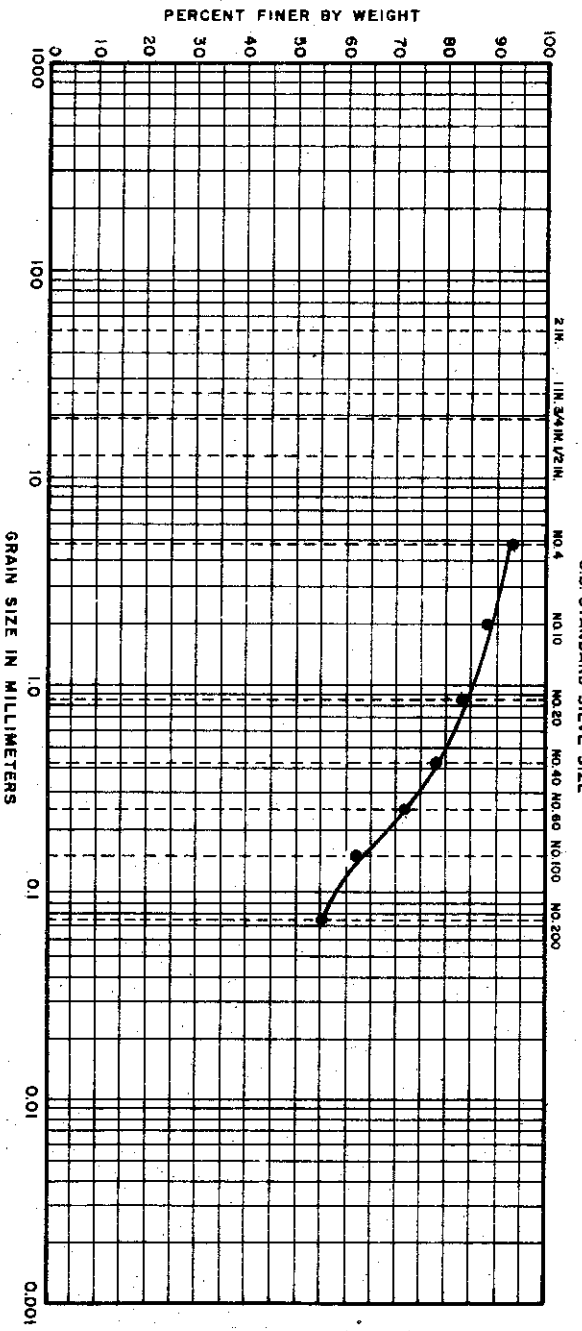

COBBLES	GRAVEL		SAND			SILT OR CLAY
	COARSE	FINE	COARSE	MEDIUM	FINE	

UNIFIED SOIL CLASSIFICATION SYSTEM

PLASTICITY CHART (COHESIVE SOIL ONLY)

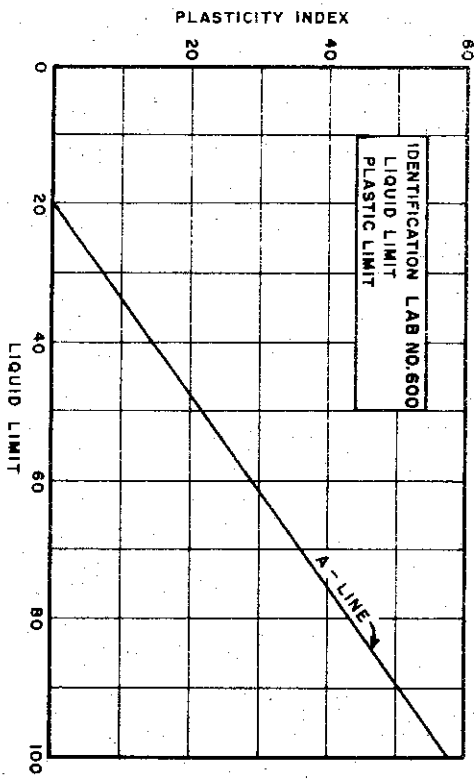

MATERIAL SOURCE

IDENTIFICATION: SANDY CLAY (SM-SC)
 EXPLORATION: BORING 141
 SAMPLE: SS27
 DEPTH: 144.5' TO 146.0'
 SPECIFIC GRAVITY

THE DETROIT EDISON COMPANY
 BELLE RIVER PLANT UNITS I & II
 SOIL CLASSIFICATION TESTS

GRAIN SIZE DISTRIBUTION

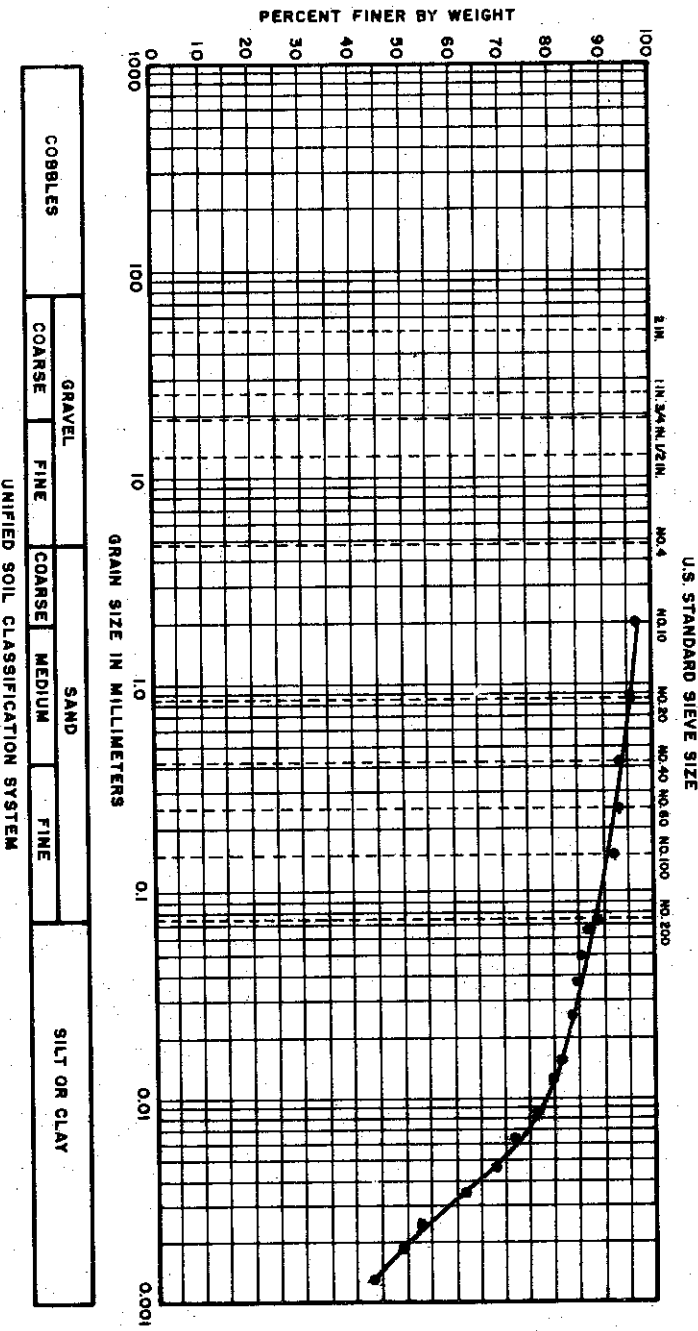

PLASTICITY CHART (COHESIVE SOIL ONLY)

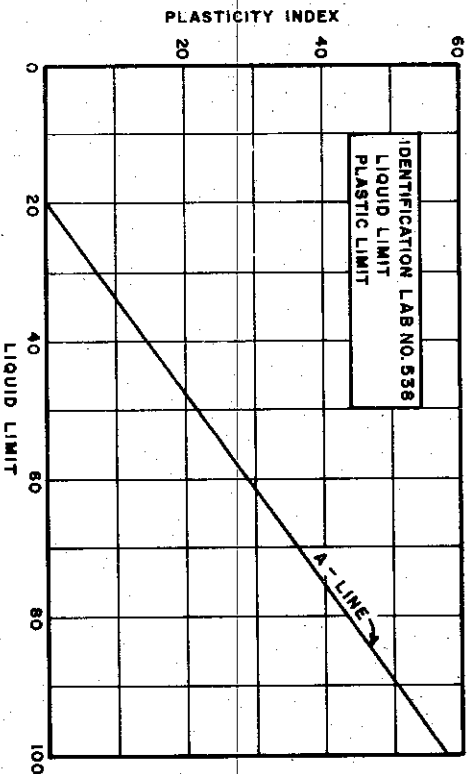

MATERIAL SOURCE

IDENTIFICATION : SILTY CLAY (CL)
 EXPLORATION: BORING 144
 SAMPLE : 6
 DEPTH : 13.8' TO 14.1'
 SPECIFIC GRAVITY : USED 2.70

THE DETROIT EDISON COMPANY
 BELLE RIVER PLANT UNITS I & II
 SOIL CLASSIFICATION TESTS

C-642

FILE NO. 1255 DATE NOV. 1974

GRAIN SIZE DISTRIBUTION

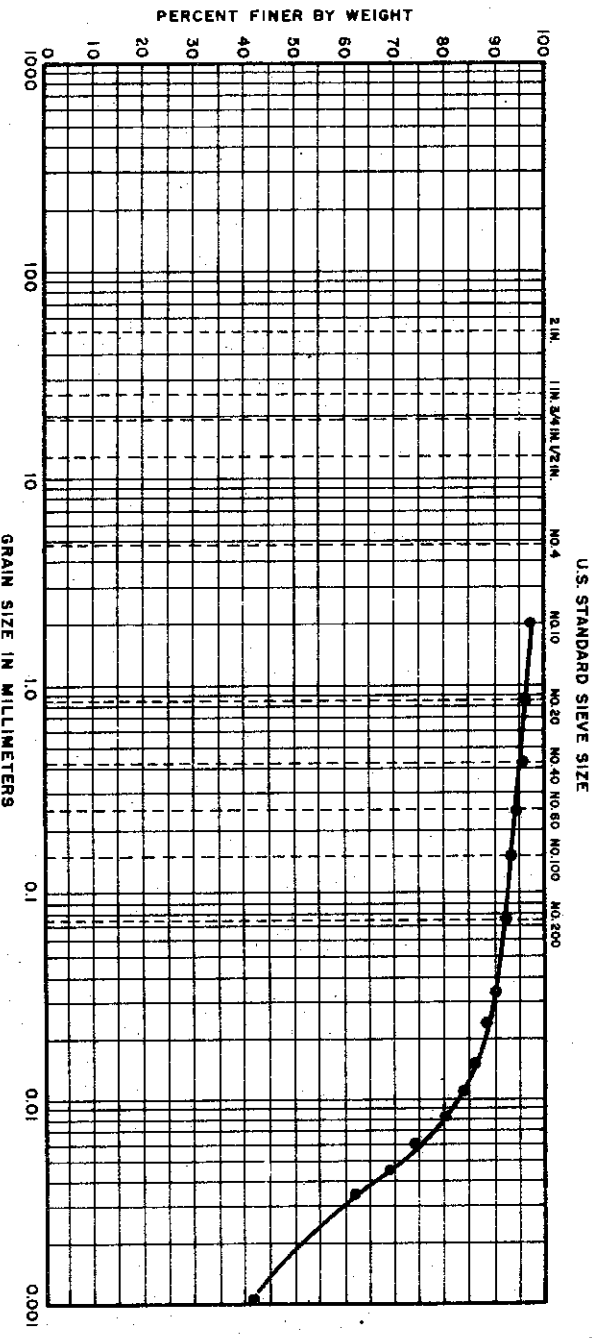

COBBLES	GRAVEL		SAND			SILT OR CLAY
	COARSE	FINE	COARSE	MEDIUM	FINE	

UNIFIED SOIL CLASSIFICATION SYSTEM

PLASTICITY CHART (COHESIVE SOIL ONLY)

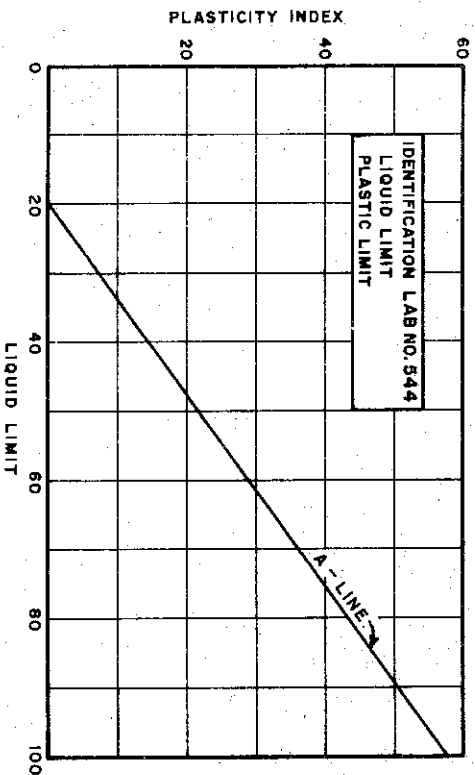

MATERIAL SOURCE

IDENTIFICATION : SILTY CLAY (CL-CH)
 EXPLORATION: BORING 151A
 SAMPLE : 2
 DEPTH : 7.7' TO 8.0'
 SPECIFIC GRAVITY : USED 2.70

THE DETROIT EDISON COMPANY
 BELLE RIVER PLANT UNITS I & II
 SOIL CLASSIFICATION TESTS

FILE NO. 1255 DATE NOV. 1974

GRAIN SIZE DISTRIBUTION

U.S. STANDARD SIEVE SIZE

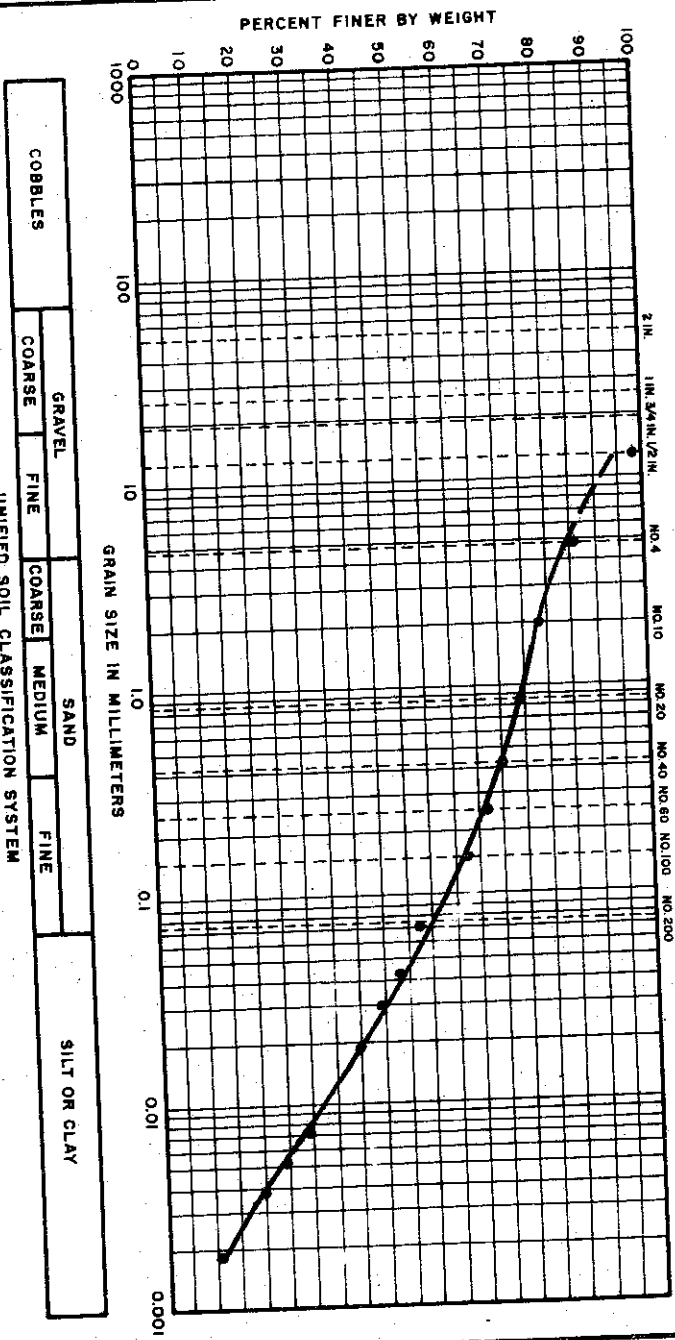

PLASTICITY CHART (COHESIVE SOIL ONLY)

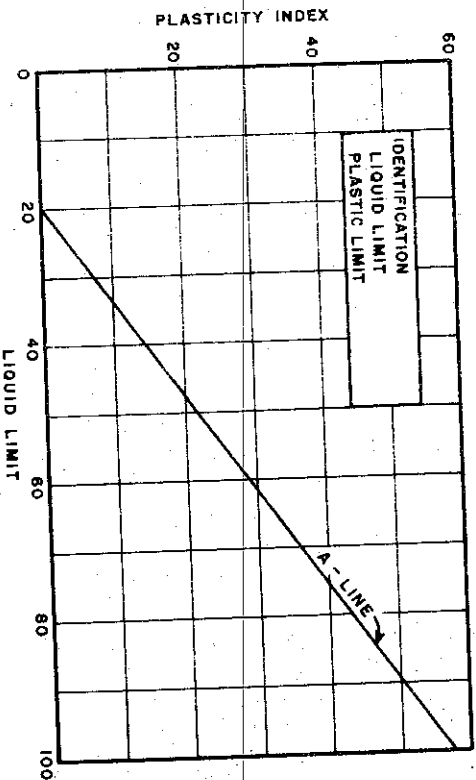

MATERIAL SOURCE

IDENTIFICATION : CLAYEY SILT, SANDY (CL-ML)

EXPLORATION: BORING 187

SAMPLE : SS14

DEPTH : 58.5' TO 60.0'

SPECIFIC GRAVITY : USED 2.70

THE DETROIT EDISON COMPANY
BELLE RIVER PLANT UNITS I & II
SOIL CLASSIFICATION TESTS

FILE NO. 1255 DATE JULY 1974

C-644

GOLDBERG - ZOINO & ASSOCIATES

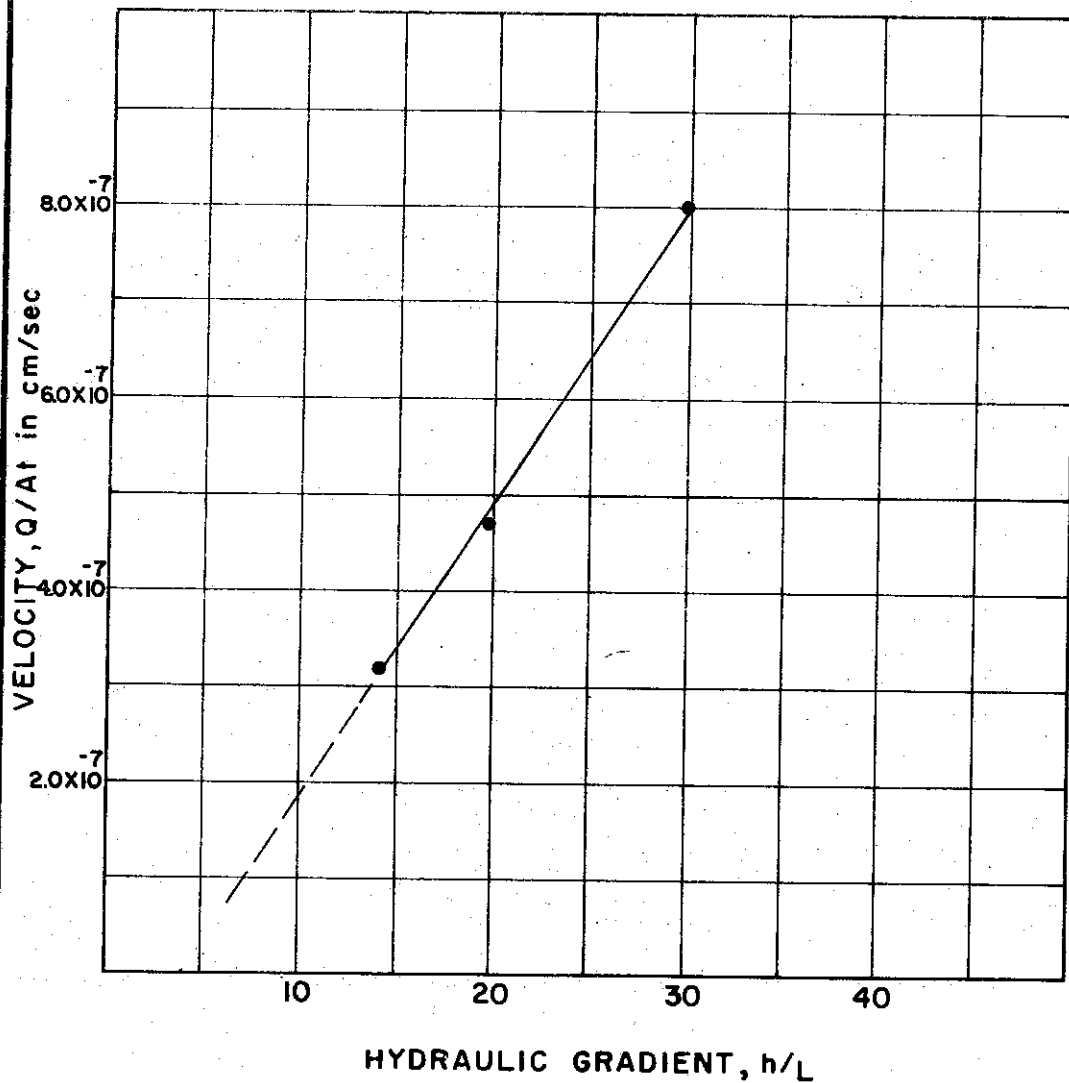

REMARKS: VOID RATIO AT END OF CONSOLIDATION STAGE = 0.875

SOIL PROPERTIES

SOIL DESCRIPTION SILTY CLAY (CL)
 SPECIFIC GRAVITY 2.70 DRY UNIT WEIGHT 84 pcf
 INITIAL WATER CONTENT 37.2 % INITIAL VOID RATIO 1.002
 ATTERBERG LIMITS:
 LIQUID LIMIT 39 % PLASTIC LIMIT 18 %

TEST DATA

	SYM	INITIAL	CONSOL STAGE	PERMEABILITY STAGES		
				1.50	1.50	1.50
CONSOLIDATION PRESSURE $\frac{kg}{cm^2}$	$\bar{\sigma}$		1.50	1.50	1.50	1.50
BACK PRESSURE TOP $\frac{kg}{cm^2}$	u_{top}			2.841	2.854	2.876
BACK PRESSURE BOTTOM $\frac{kg}{cm^2}$	u_{bot}			2.806	2.806	2.806
DIFFERENTIAL HEAD cm.	h			35.16	49.21	70.31
SAMPLE LENGTH cm.	L	2.540	2.39	2.39	2.39	2.39
HYDRAULIC GRADIENT	i			14.72	20.6	29.44
SAMPLE AREA cm^2	A	31.67	31.67	31.67	31.67	31.67
WATER DISCHARGED cm^3	Q			1.94	4.00	6.85
TIME OF DISCHARGE sec	t			190,800	266,400	270,000
PERMEABILITY cm/sec	k			2.18×10^{-8}	2.30×10^{-8}	2.72×10^{-8}

THE DETROIT EDISON COMPANY
 BELLE RIVER PLANT UNITS I & II

PERMEABILITY TEST VELOCITY VS. HYDRAULIC GRADIENT

BORING NO. 50
 SAMPLE NO. 6
 DEPTH 28.3' TO 28.5'

TEST NO. k 85.1
 DATE JULY 74

FILE 1255

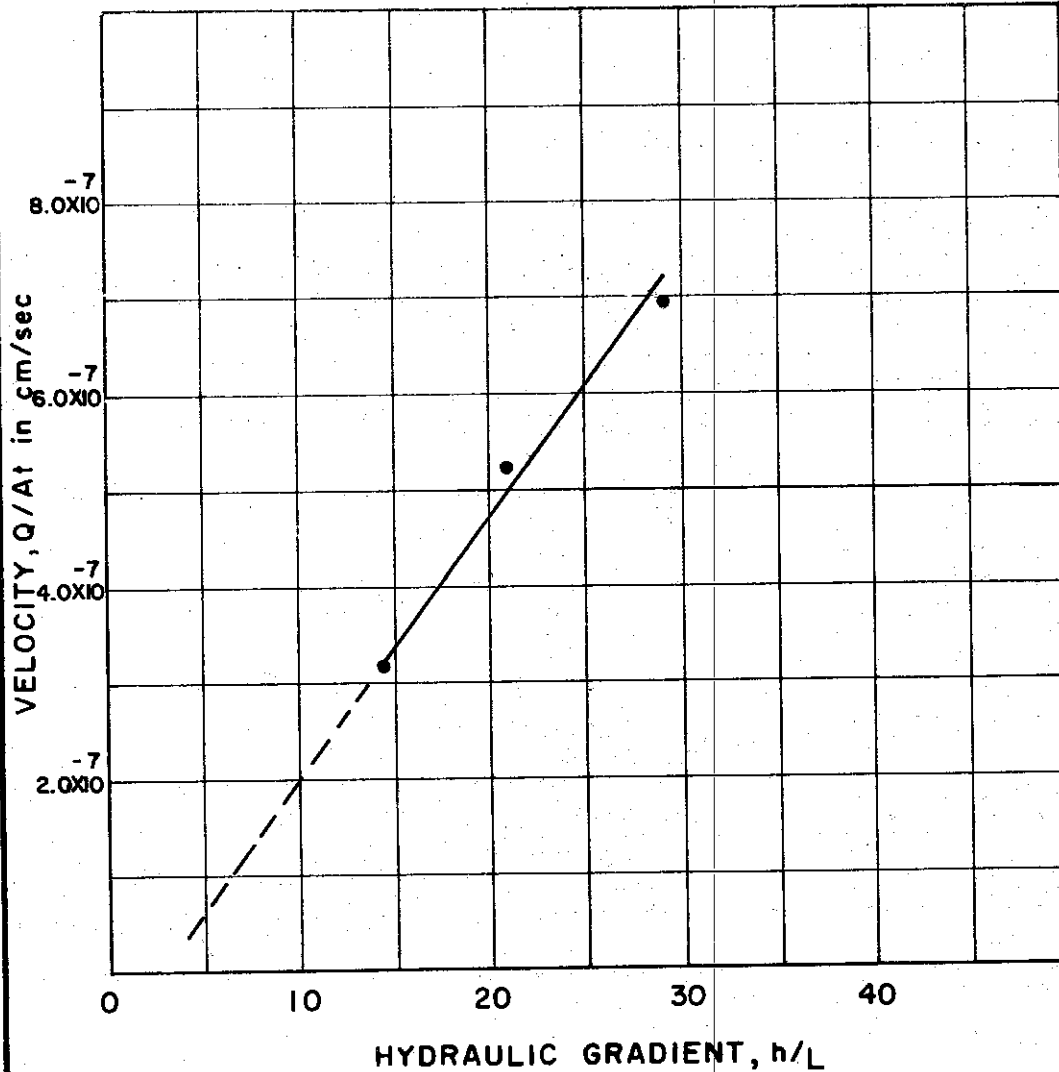

REMARKS: VOID RATIO AT END OF CONSOLIDATION STAGE = 0.645

SOIL PROPERTIES

SOIL DESCRIPTION SILTY CLAY, SANDY (CL)
 SPECIFIC GRAVITY 2.70 DRY UNIT WEIGHT 97 pcf
 INITIAL WATER CONTENT 26.9 % INITIAL VOID RATIO 0.730
 ATTERBERG LIMITS:
 LIQUID LIMIT 36 % PLASTIC LIMIT 16 %

TEST DATA

	S Y M	INITIAL	CONSOL STAGE	PERMEABILITY STAGES		
CONSOLIDATION PRESSURE σ_c kg/cm ²			2.00	2.00	2.00	2.00
BACK PRESSURE TOP kg/cm ² u_{top}				2.847	2.862	2.883
BOTTOM kg/cm ² u_{bot}				2.812	2.812	2.812
DIFFERENTIAL HEAD cm. h				35.15	49.21	70.31
SAMPLE LENGTH cm. L		2.540	2.420	2.420	2.420	2.420
HYDRAULIC GRADIENT i				14.52	20.31	29.00
SAMPLE AREA cm ² A		31.67	31.67	31.67	31.67	31.67
WATER DISCHARGED cm ³ Q				0.94	1.38	1.66
TIME OF DISCHARGE sec t				93,600	82,800	75,600
PERMEABILITY cm/sec k				⁻⁸ 2.18x10	⁻⁸ 2.58x10	⁻⁸ 2.39x10

THE DETROIT EDISON COMPANY
 BELLE RIVER PLANT UNITS I & II
PERMEABILITY TEST
VELOCITY VS. HYDRAULIC GRADIENT

BORING NO. 50
 SAMPLE NO. 10
 DEPTH 48.6 TO 48.8'

TEST NO. K 87.1
 DATE JULY 1974

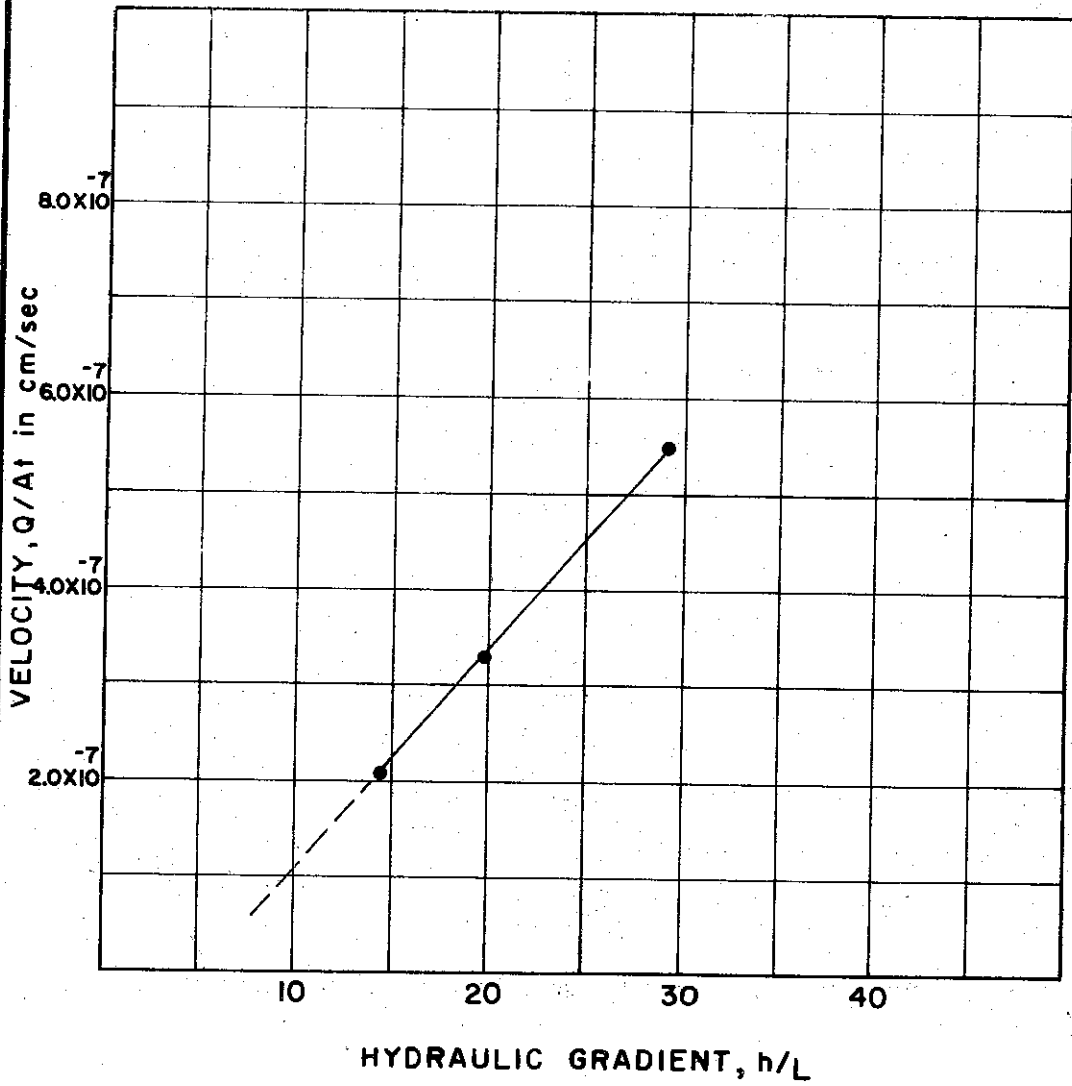

REMARKS: VOID RATIO AT END OF CONSOLIDATION STAGE = 0.374

C-647

SOIL PROPERTIES

SOIL DESCRIPTION SILTY CLAY, SANDY (CL)
 SPECIFIC GRAVITY 2.70 DRY UNIT WEIGHT 119 pcf
 INITIAL WATER CONTENT 15.1 % INITIAL VOID RATIO 0.411
 ATTERBERG LIMITS:
 LIQUID LIMIT 23 % PLASTIC LIMIT 14 %

TEST DATA

	S Y M	INITIAL	CONSOL STAGE	PERMEABILITY STAGES		
CONSOLIDATION PRESSURE $\frac{kg}{cm^2}$	$\bar{\sigma}$		2.30	2.30	2.30	2.30
BACK PRESSURE TOP $\frac{kg}{cm^2}$	u_{top}			2.841	2.854	2.876
BOTTOM $\frac{kg}{cm^2}$	u_{bot}			2.806	2.806	2.806
DIFFERENTIAL HEAD cm.	h			35.16	49.21	70.31
SAMPLE LENGTH cm.	L	2.54	2.47	2.47	2.47	2.47
HYDRAULIC GRADIENT	i			14.20	19.87	28.40
SAMPLE AREA cm^2	A	31.67	31.67	31.67	31.67	31.67
WATER DISCHARGED cm^3	Q			1.26	3.38	3.40
TIME OF DISCHARGE sec	t			190,800	320,400	198,000
PERMEABILITY cm/sec	k			⁻⁸ 1.46 x 10	⁻⁸ 1.68 x 10	⁻⁸ 1.91 x 10

THE DETROIT EDISON COMPANY
 BELLE RIVER PLANT UNITS I & II
PERMEABILITY TEST
VELOCITY VS. HYDRAULIC GRADIENT

BORING NO. 52
 SAMPLE NO. 7
 DEPTH 58.6' TO 58.9'

TEST NO. k112.1
 DATE JULY 74

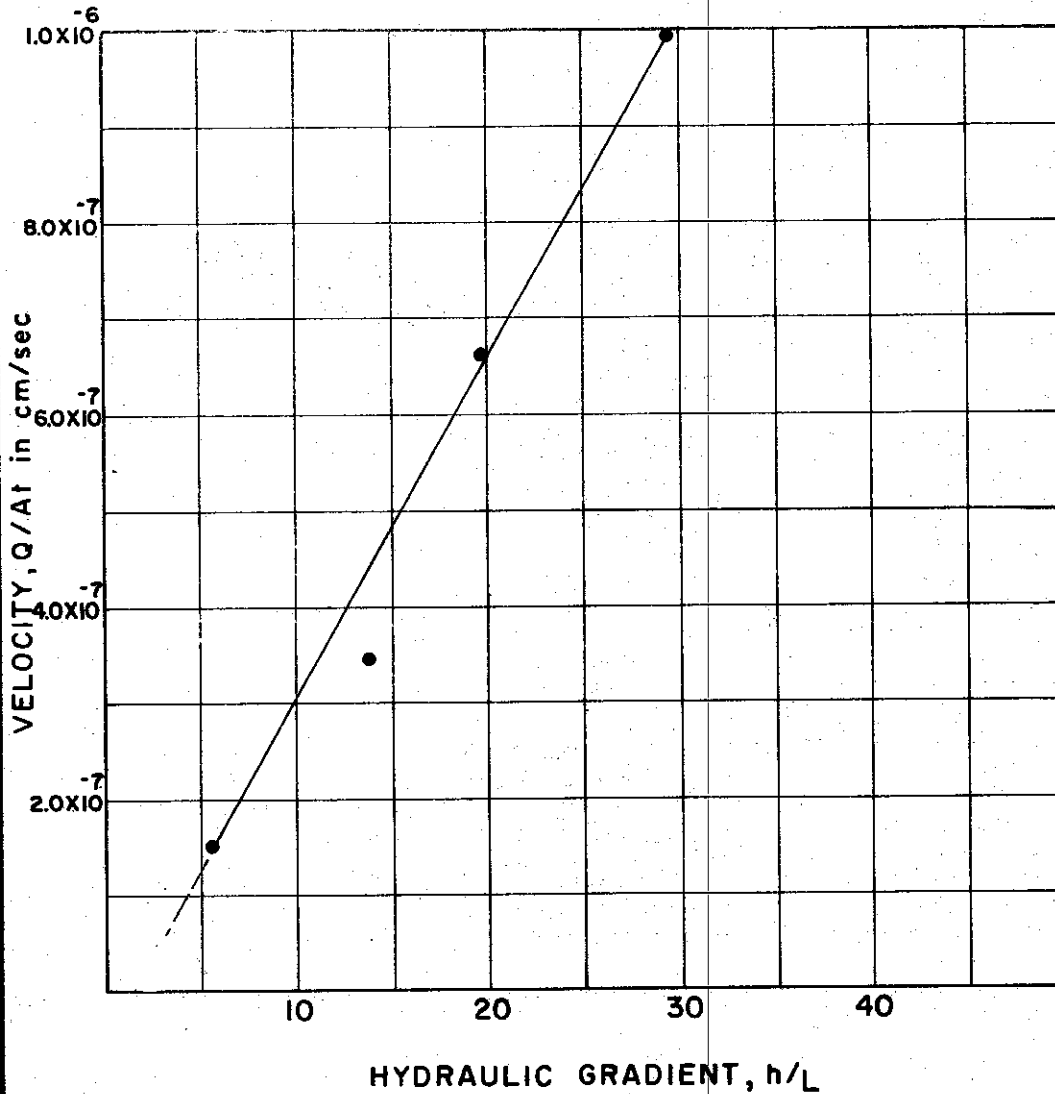

REMARKS: VOID RATIO AT END OF CONSOLIDATION STAGE = 0.685

SOIL PROPERTIES	
SOIL DESCRIPTION	SILTY CLAY, SANDY (CL)
SPECIFIC GRAVITY	2.72
DRY UNIT WEIGHT	104 pcf
INITIAL WATER CONTENT	30.2 %
INITIAL VOID RATIO	0.732
ATTERBERG LIMITS:	
LIQUID LIMIT	39 %
PLASTIC LIMIT	20 %

TEST DATA							
	S Y M	INITIAL	CONSOL STAGE	PERMEABILITY STAGES			
CONSOLIDATION PRESSURE σ_c kg/cm ²			1.74	1.74	1.74	1.74	1.74
BACK PRESSURE TOP kg/cm ² u_{top}				2.810	2.841	2.854	2.876
BACK PRESSURE BOTTOM kg/cm ² u_{bot}				2.806	2.806	2.806	2.806
DIFFERENTIAL HEAD cm. h				14.06	35.16	49.21	70.31
SAMPLE LENGTH cm. L		2.54	2.49	2.49	2.49	2.49	2.49
HYDRAULIC GRADIENT i				5.64	14.11	19.75	28.22
SAMPLE AREA cm ² A		31.67	31.67	31.67	31.67	31.67	31.67
WATER DISCHARGED cm ³ Q				1.22	2.30	5.89	8.50
TIME OF DISCHARGE sec. t				248,400	212,400	277,200	270,000
PERMEABILITY cm/sec k				2.75 × 10 ⁻⁸	2.42 × 10 ⁻⁸	3.40 × 10 ⁻⁸	3.52 × 10 ⁻⁸

THE DETROIT EDISON COMPANY
 BELLE RIVER PLANT UNITS I & II
PERMEABILITY TEST
VELOCITY VS. HYDRAULIC GRADIENT

BORING NO. 53
 SAMPLE NO. 5
 DEPTH 39.5' TO 39.8'

TEST NO. k 98.1
 DATE JULY 74

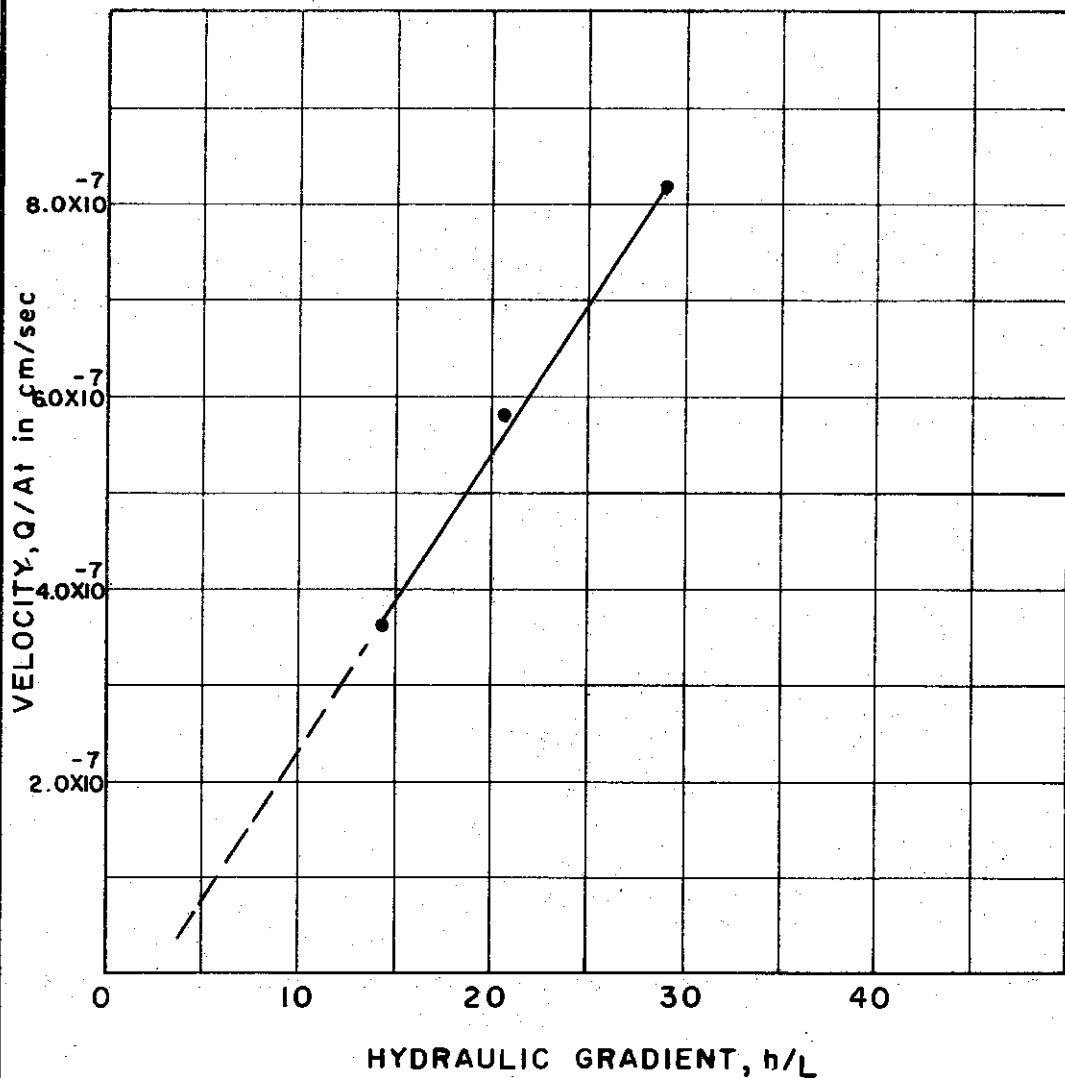

REMARKS: VOID RATIO AT END OF CONSOLIDATION STAGE=0.641

SOIL PROPERTIES

SOIL DESCRIPTION SILTY CLAY, SANDY (CL)
 SPECIFIC GRAVITY 2.71 DRY UNIT WEIGHT 98 pcf
 INITIAL WATER CONTENT 27.2 % INITIAL VOID RATIO 0.724
 ATTERBERG LIMITS:
 LIQUID LIMIT 36 % PLASTIC LIMIT 18 %

TEST DATA

	SYM	INITIAL	CONSOL STAGE	PERMEABILITY STAGES		
CONSOLIDATION PRESSURE σ_c kg/cm ²			2.40	2.40	2.40	2.40
BACK PRESSURE TOP kg/cm ² u_{top}				2.847	2.862	2.883
BACK PRESSURE BOTTOM kg/cm ² u_{bot}				2.812	2.812	2.812
DIFFERENTIAL HEAD cm. h				35.15	49.21	70.31
SAMPLE LENGTH cm. L		2.540	2.420	2.420	2.420	2.420
HYDRAULIC GRADIENT i				14.52	20.33	29.0
SAMPLE AREA cm ² A		31.67	31.67	31.67	31.67	31.67
WATER DISCHARGED cm ³ Q				1.08	1.52	1.76
TIME OF DISCHARGE sec t				93,800	82,800	75,600
PERMEABILITY cm/sec k				2.52 × 10 ⁻⁸	2.85 × 10 ⁻⁸	2.53 × 10 ⁻⁸

THE DETROIT EDISON COMPANY
 BELLE RIVER PLANT UNITS I & II

PERMEABILITY TEST VELOCITY VS. HYDRAULIC GRADIENT

BORING NO. 54
 SAMPLE NO. 6
 DEPTH 63.5' TO 63.8'

TEST NO. K 399.1
 DATE JULY 1974

FILE 1255

C-650

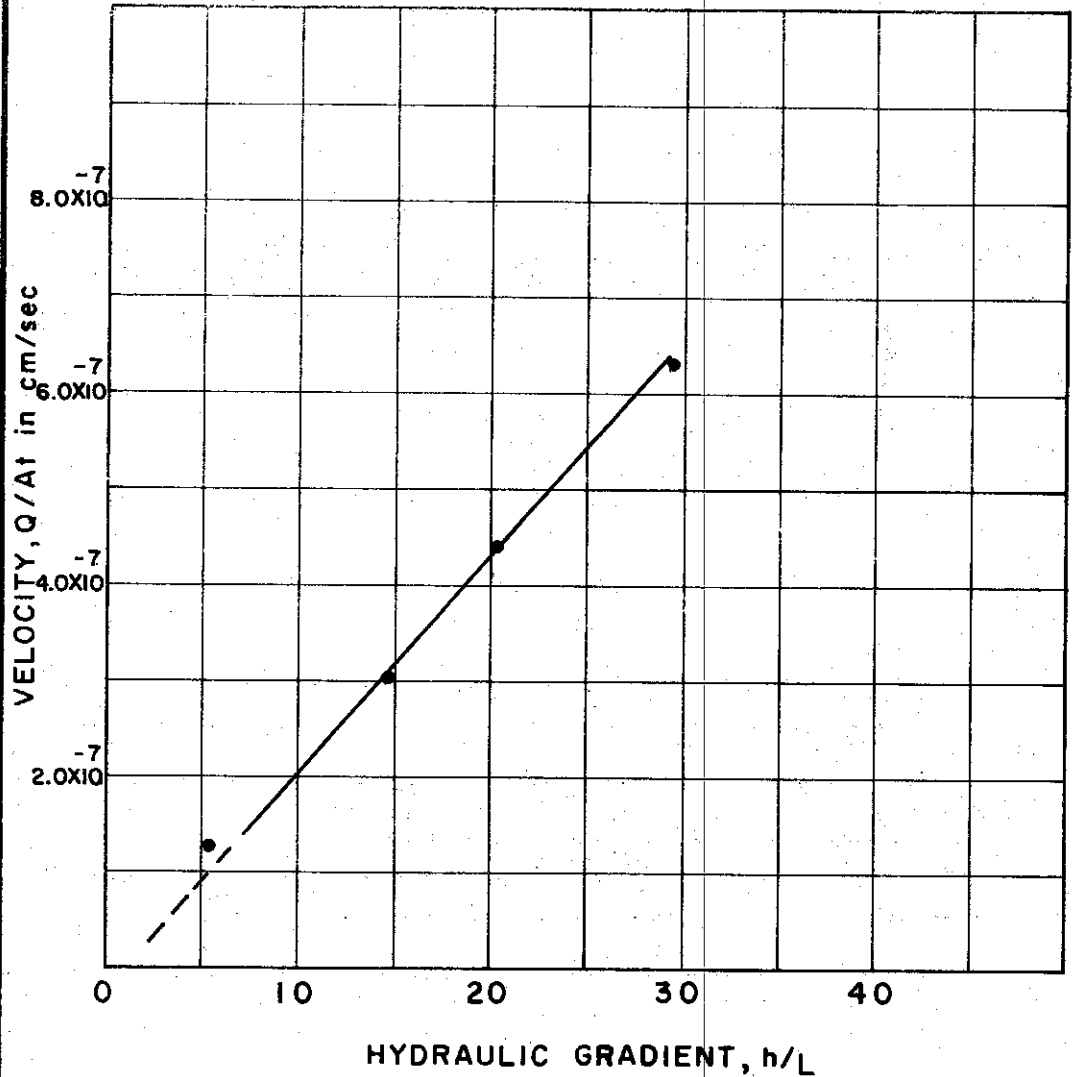

REMARKS: VOID RATIO AT END OF CONSOLIDATION STAGE = 0.72

SOIL PROPERTIES	
SOIL DESCRIPTION	SILTY CLAY (CL)
SPECIFIC GRAVITY	2.73
DRY UNIT WEIGHT	90 pcf
INITIAL WATER CONTENT	31.6 %
INITIAL VOID RATIO	0.851
ATTERBERG LIMITS:	
LIQUID LIMIT	45 %
PLASTIC LIMIT	21 %

TEST DATA							
	S Y M	INITIAL	CONSOL STAGE	PERMEABILITY STAGES			
CONSOLIDATION PRESSURE $\frac{kg}{cm^2}$	σ		2.71	2.71	2.71	2.71	2.71
BACK PRESSURE TOP $\frac{kg}{cm^2}$	u_{top}			2826	2847	2862	2883
BOTTOM $\frac{kg}{cm^2}$	u_{bot}			2812	2812	2812	2812
DIFFERENTIAL HEAD cm.	h			14.06	35.15	49.21	70.31
SAMPLE LENGTH cm.	L	2.540	2.376	2.376	2.376	2.376	2.376
HYDRAULIC GRADIENT	i			5.92	14.80	20.71	29.50
SAMPLE AREA cm^2	A	31.67	31.67	31.67	31.67	31.67	31.67
WATER DISCHARGED cm^3	Q			0.48	0.88	1.10	1.39
TIME OF DISCHARGE sec	t			108,000	90,000	79,200	75,600
PERMEABILITY cm/sec	k			2.37x10 ⁻⁸	2.09x10 ⁻⁸	2.18x10 ⁻⁸	2.00x10 ⁻⁸

THE DETROIT EDISON COMPANY
 BELLE RIVER PLANT UNITS I & II
PERMEABILITY TEST
VELOCITY VS. HYDRAULIC GRADIENT

BORING NO. 54 TEST NO. K 401.1
 SAMPLE NO. 8 DATE JULY 1974
 DEPTH 73.7 TO 74.0'

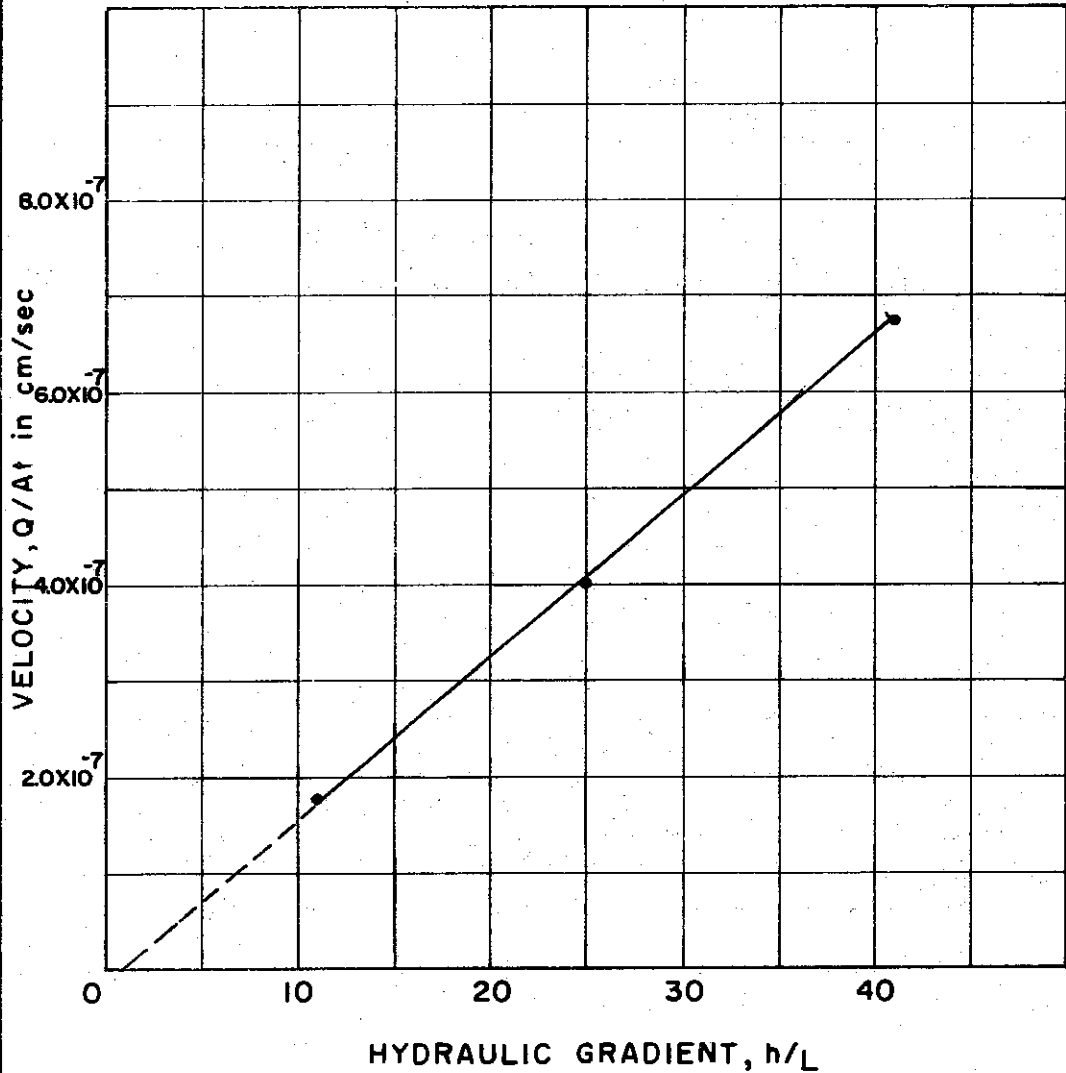

REMARKS:

C-651

SOIL PROPERTIES

SOIL DESCRIPTION SILTY CLAY (CL)
 SPECIFIC GRAVITY 2.70 DRY UNIT WEIGHT 103 pcf
 INITIAL WATER CONTENT 26.1 % INITIAL VOID RATIO 0.707
 ATTERBERG LIMITS:
 LIQUID LIMIT 39 % PLASTIC LIMIT 21 %

TEST DATA

	S Y M	INITIAL	CONSOL. STAGE	PERMEABILITY STAGES		
CONSOLIDATION PRESSURE σ_c kg/cm ²			1.05	1.05	1.05	1.05
BACK PRESSURE TOP u_{top} kg/cm ²				2.488	2.521	2.565
BACK PRESSURE BOTTOM u_{bot} kg/cm ²				2.460	2.460	2.460
DIFFERENTIAL HEAD cm. h				27.7	63.0	103.8
SAMPLE LENGTH cm. L		6.48	6.40	6.40	6.40	6.40
HYDRAULIC GRADIENT i				11.0	25.0	41.2
SAMPLE AREA cm ² A		11.37	11.37	11.37	11.37	11.37
WATER DISCHARGED cm ³ Q				.13	.29	.58
TIME OF DISCHARGE sec t				72,000	72,000	86,000
PERMEABILITY cm/sec k				1.60 x 10 ⁻⁸	1.61 x 10 ⁻⁸	1.63 x 10 ⁻⁸

THE DETROIT EDISON COMPANY
 BELLE RIVER PLANT UNITS I & II
PERMEABILITY TEST
VELOCITY VS. HYDRAULIC GRADIENT

BORING NO. 60 TEST NO. k43.1
 SAMPLE NO. 3 DATE MARCH 74
 DEPTH 18.1' TO 18.3'

C-652

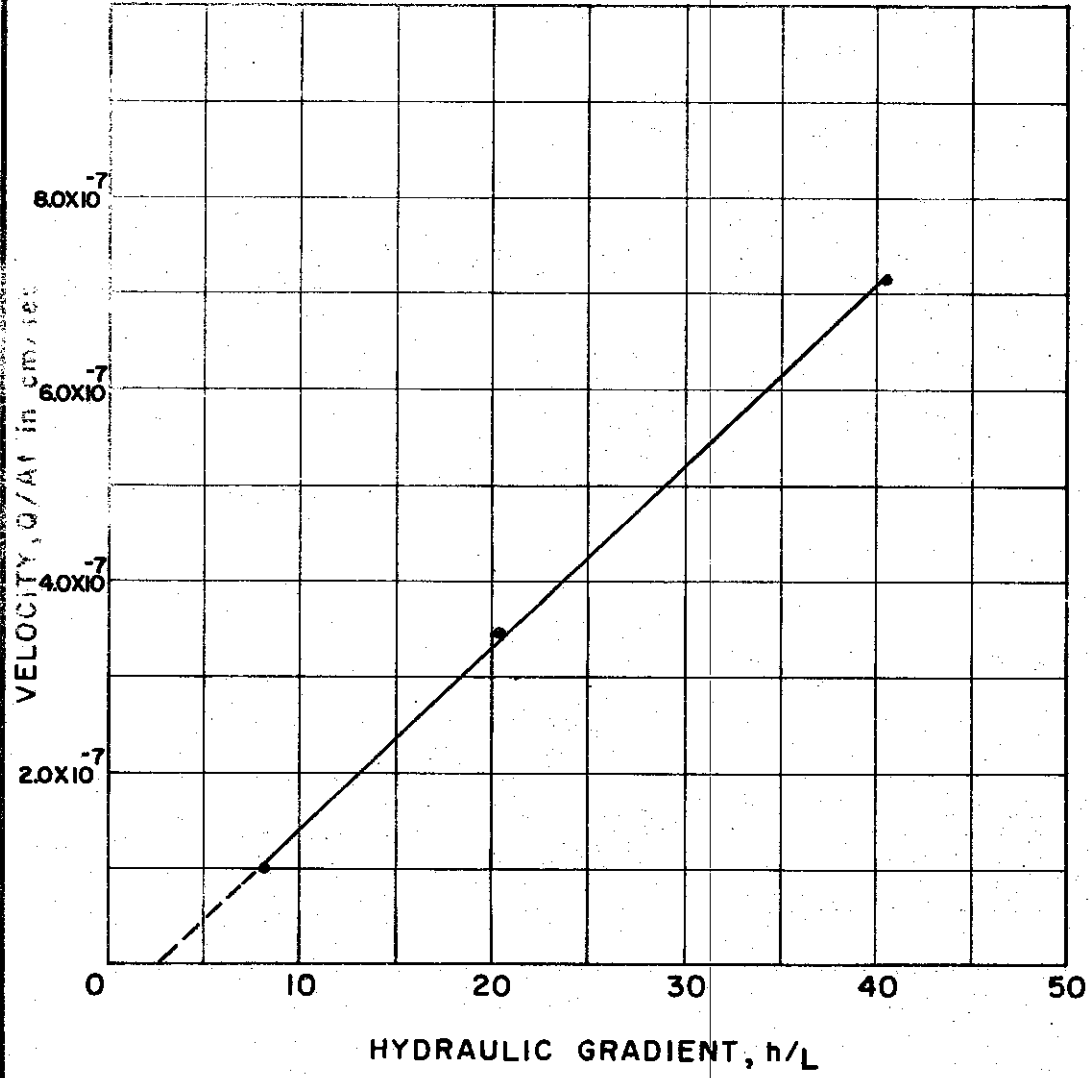

REMARKS:

SOIL PROPERTIES

SOIL DESCRIPTION SILTY CLAY (CL)
 SPECIFIC GRAVITY ≈ 2.70 DRY UNIT WEIGHT 98 pcf
 INITIAL WATER CONTENT 27.2% INITIAL VOID RATIO .730
 ATTERBERG LIMITS:
 LIQUID LIMIT 33 % PLASTIC LIMIT 18 %

TEST DATA

	S Y M	INITIAL	CONSOL STAGE	PERMEABILITY STAGES		
CONSOLIDATION PRESSURE kg/cm^2	σ		2.20	2.20	2.20	2.20
BACK PRESSURE TOP kg/cm^2	u_{top}			2.826	2.847	2.882
BOTTOM kg/cm^2	u_{bot}			2.812	2.812	2.812
DIFFERENTIAL HEAD cm.	h			14.06	35.16	70.30
SAMPLE LENGTH cm.	L	1.90	1.73	1.73	1.73	1.73
HYDRAULIC GRADIENT	i			8.13	20.32	40.63
SAMPLE AREA cm^2	A	31.70	31.70	31.70	31.70	31.70
WATER DISCHARGED cm^3	Q			.21	.66	.23
TIME OF DISCHARGE sec	t			66,600	59,400	10,200
PERMEABILITY cm/sec	k			1.25×10^{-8}	1.75×10^{-8}	1.76×10^{-8}

THE DETROIT EDISON COMPANY
 BELLE RIVER PLANT UNITS I & II
PERMEABILITY TEST
VELOCITY VS. HYDRAULIC GRADIENT
 BORING NO. 60 TEST NO. k51.1
 SAMPLE NO. 11 DATE MARCH 74
 DEPTH 56.1' TO 56.4'

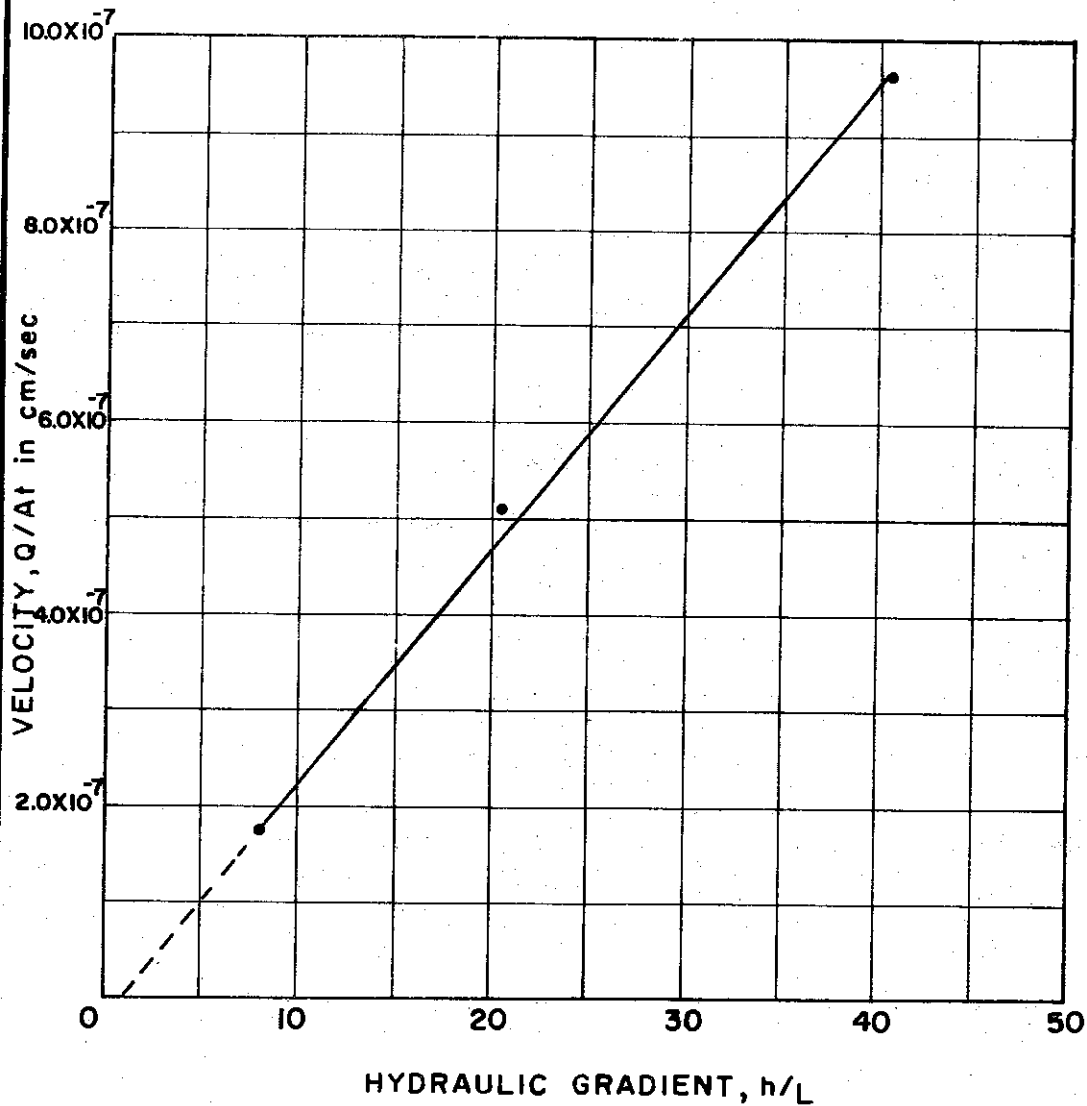

REMARKS:

SOIL PROPERTIES

SOIL DESCRIPTION SILTY CLAY (CL)
 SPECIFIC GRAVITY 2.73 DRY UNIT WEIGHT 96 pcf
 INITIAL WATER CONTENT 29.1 % INITIAL VOID RATIO .753
 ATTERBERG LIMITS:
 LIQUID LIMIT 40 % PLASTIC LIMIT 19 %

TEST DATA

	S Y M	INITIAL	CONSOL STAGE	PERMEABILITY STAGES		
CONSOLIDATION PRESSURE kg/cm^2	σ		3.00	3.00	3.00	3.00
BACK PRESSURE TOP kg/cm^2	u_{top}			2.836	2.847	2.882
BOTTOM kg/cm^2	u_{bot}			2.812	2.812	2.812
DIFFERENTIAL HEAD cm.	h			14.06	35.16	70.30
SAMPLE LENGTH cm.	L	1.90	1.74	1.74	1.74	1.74
HYDRAULIC GRADIENT	i			8.08	20.20	40.40
SAMPLE AREA cm^2	A	31.70	31.70	31.70	31.70	31.70
WATER DISCHARGED cm^3	Q			.34	.97	.31
TIME OF DISCHARGE sec	t			63,000	59,400	10,200
PERMEABILITY cm/sec	k			2.10×10^{-8}	2.55×10^{-8}	2.37×10^{-8}

THE DETROIT EDISON COMPANY
 BELLE RIVER PLANT UNITS I & II

PERMEABILITY TEST VELOCITY VS. HYDRAULIC GRADIENT

BORING NO. 60
 SAMPLE NO. 16
 DEPTH 85.6' TO 86.1'

TEST NO. k 56.1
 DATE MARCH 74

FILE 1255

GRAIN SIZE DISTRIBUTION

U.S. STANDARD SIEVE SIZE

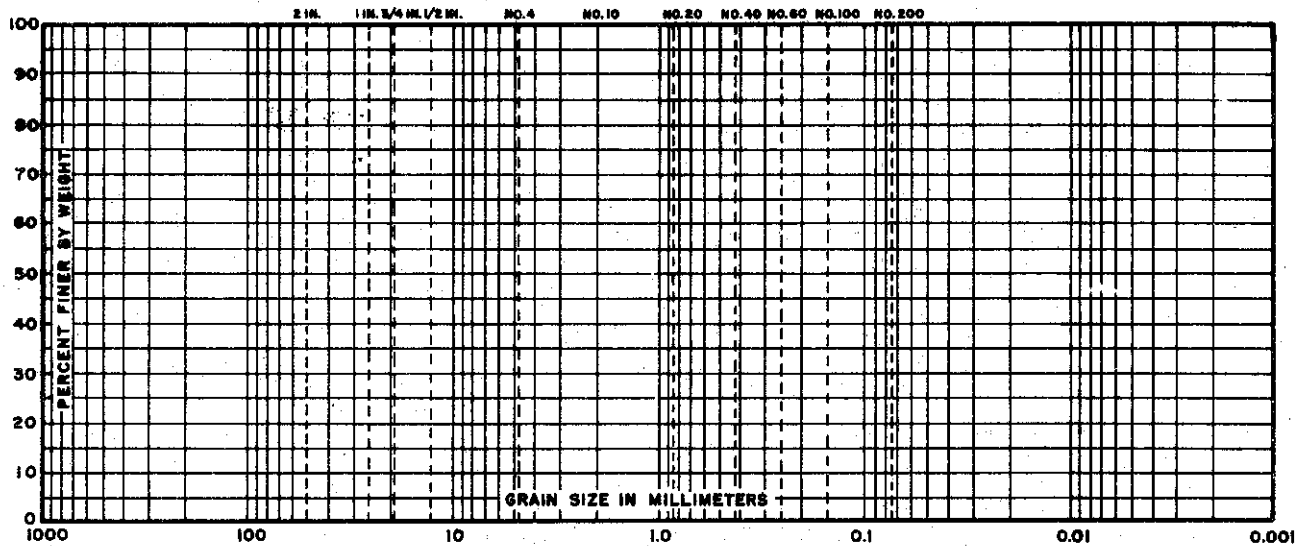

COBBLES	GRAVEL		SAND			SILT OR CLAY
	COARSE	FINE	COARSE	MEDIUM	FINE	

UNIFIED SOIL CLASSIFICATION SYSTEM

COMPACTION

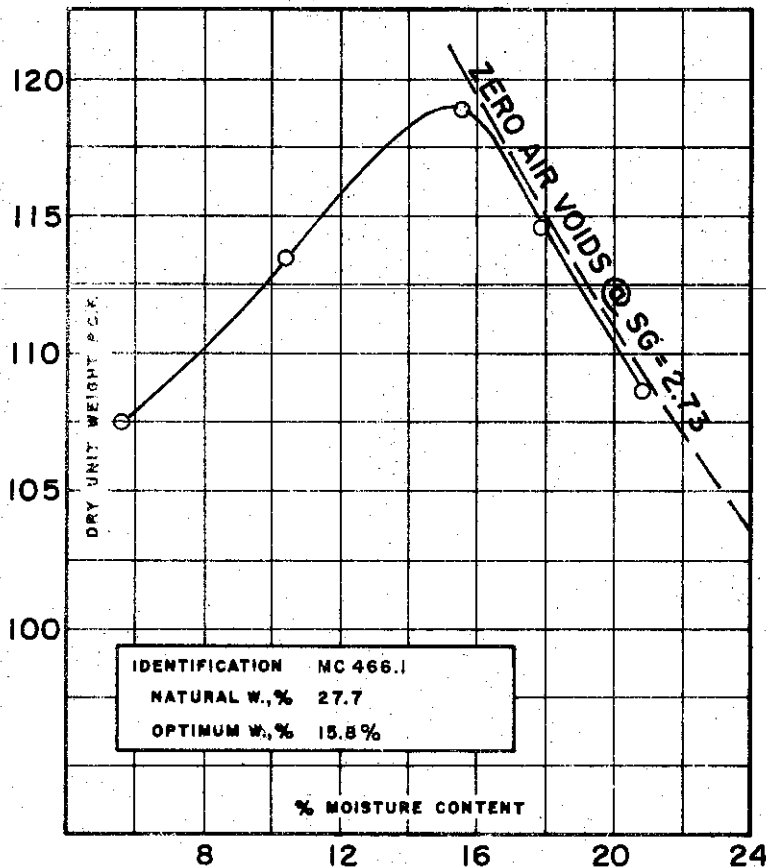

ATTERBERG LIMITS

IDENTIFICATION SEE DATA FOR
LIQUID LIMIT INDIVIDUAL
PLASTIC LIMIT SAMPLES

MATERIAL SOURCE

IDENTIFICATION SILTY CLAY (CL-CH)
EXPLORATION BORING 101, 105, 127, 128, 180 & 183
SAMPLE COMBINED SAMPLES
DEPTH 2.0' TO 10.0'

COMPACTION METHOD

ASTM TEST D1557 - METHOD C
AASHTO TEST
MOLD HEIGHT 4.584", MOLD DIAM. 4.000"
NO. LAYERS 5, BLOWS/LAYER 25,
HAMMER WT. 10 LBS, DROP HT. 18"

NOTES:

THE DETROIT EDISON COMPANY
BELLE RIVER PLANT UNITS I & II
COMPACTION - GRADATION
TESTS

C-656

FILE NO. 1255 DATE APRIL 74

GRAIN SIZE DISTRIBUTION

U.S. STANDARD SIEVE SIZE

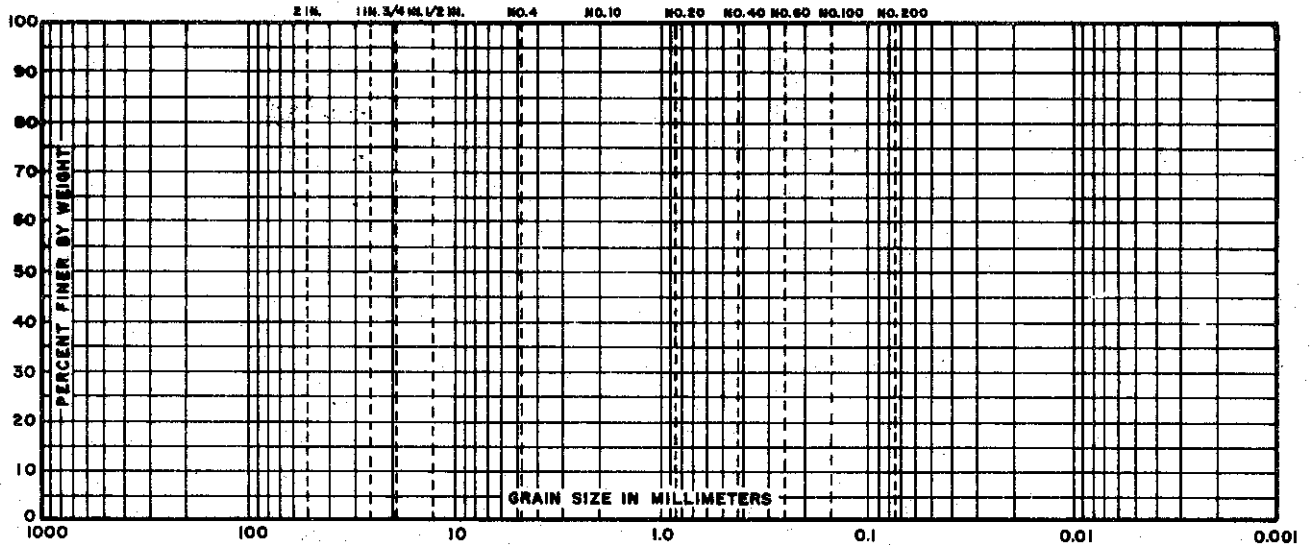

COBBLES	GRAVEL		SAND			SILT OR CLAY
	COARSE	FINE	COARSE	MEDIUM	FINE	

UNIFIED SOIL CLASSIFICATION SYSTEM

COMPACTION

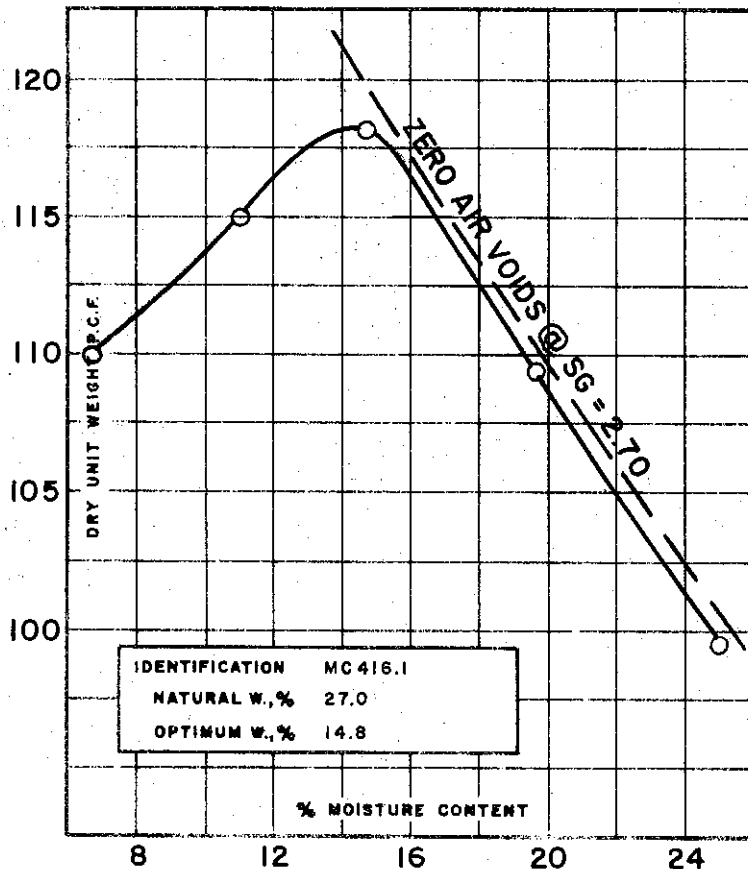

ATTERBERG LIMITS

IDENTIFICATION SILTY CLAY (CL-CH)
 LIQUID LIMIT 49
 PLASTIC LIMIT 22

MATERIAL SOURCE

IDENTIFICATION SILTY CLAY (CL-CH)
 EXPLORATION BORING 127
 SAMPLE 3
 DEPTH 5.6' TO 7.0'

COMPACTION METHOD

ASTM TEST 01557 - METHOD C
 AASHO TEST
 MOLD HEIGHT 4.56", MOLD DIAM. 4.00"
 NO. LAYERS 5, BLOWS/LAYER 25,
 HAMMER WT. 10 LBS, DROP HT. 18"

NOTES:

THE DETROIT EDISON COMPANY
 BELLE RIVER PLANT UNITS I & II
 COMPACTION - GRADATION
 TESTS

FILE NO. 1255 DATE JULY 74

GRAIN SIZE DISTRIBUTION

U.S. STANDARD BIEVE SIZE

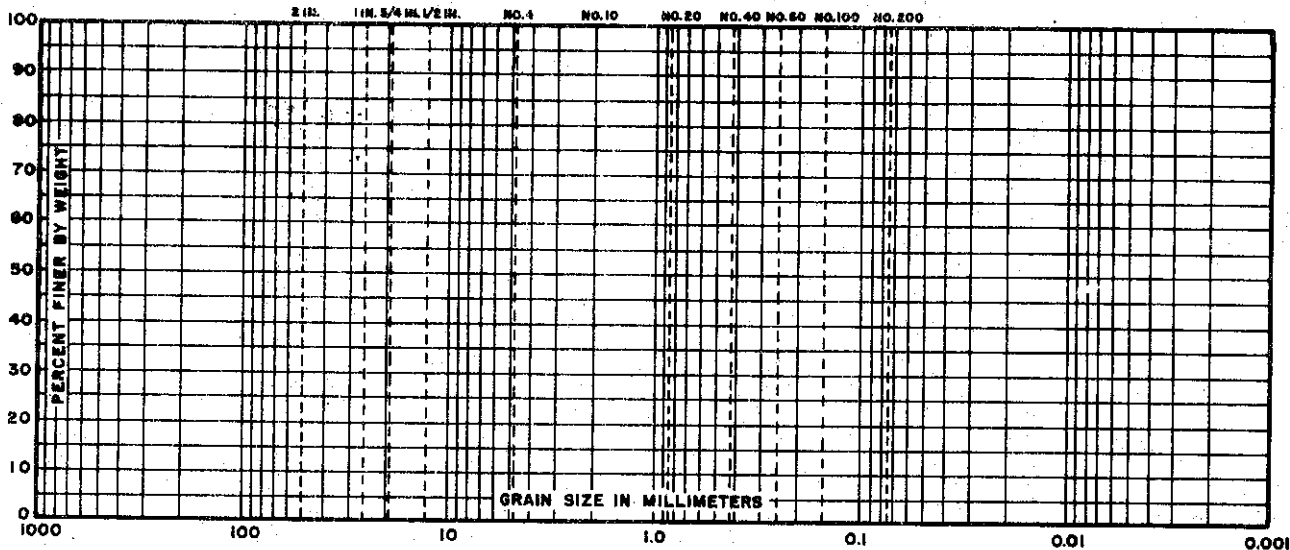

COBBLES	GRAVEL		SAND			SILT OR CLAY
	COARSE	FINE	COARSE	MEDIUM	FINE	

UNIFIED SOIL CLASSIFICATION SYSTEM

COMPACTION

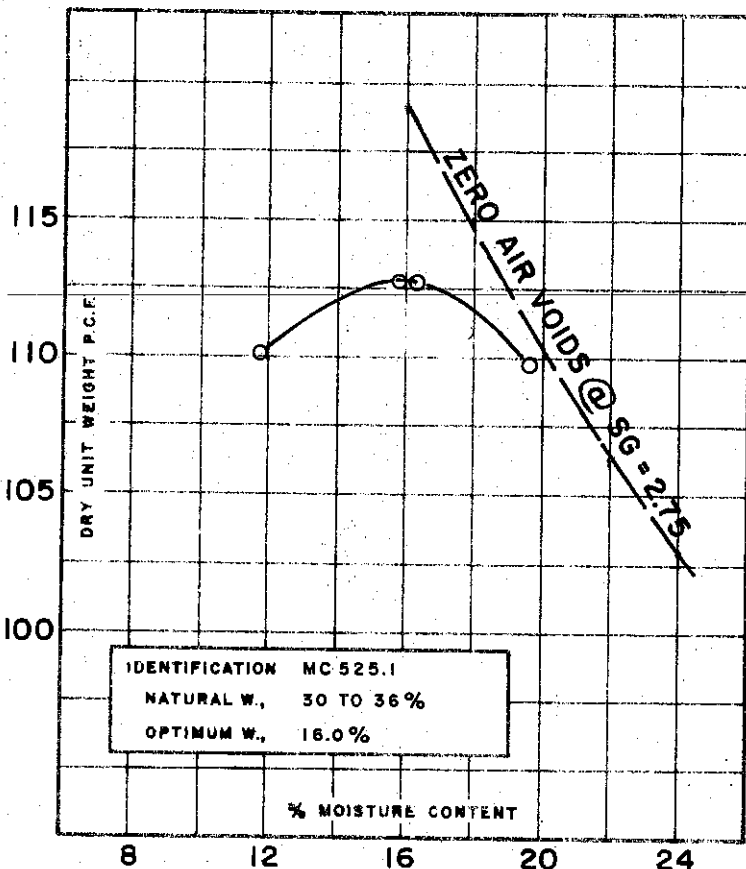

ATTERBERG LIMITS

IDENTIFICATION
 LIQUID LIMIT
 PLASTIC LIMIT

MATERIAL SOURCE

IDENTIFICATION SILTY CLAY (CH)
 EXPLORATION BORING 136
 SAMPLE 2
 DEPTH 3:0' TO 5:0'

COMPACTION METHOD

ASTM TEST D1557 - METHOD C
 AASHTO TEST
 MOLD HEIGHT 4.58", MOLD DIAM. 4.00"
 NO. LAYERS 5, BLOWS/LAYER 25,
 HAMMER WT. 10 LBS, DROP HT. 18"

NOTES:

THE DETROIT EDISON COMPANY
 BELLE RIVER PLANT UNITS I & II
 COMPACTION - GRADATION
 TESTS

C-658

FILE NO. 1255 DATE NOV. 74

GRAIN SIZE DISTRIBUTION

U.S. STANDARD SIEVE SIZE

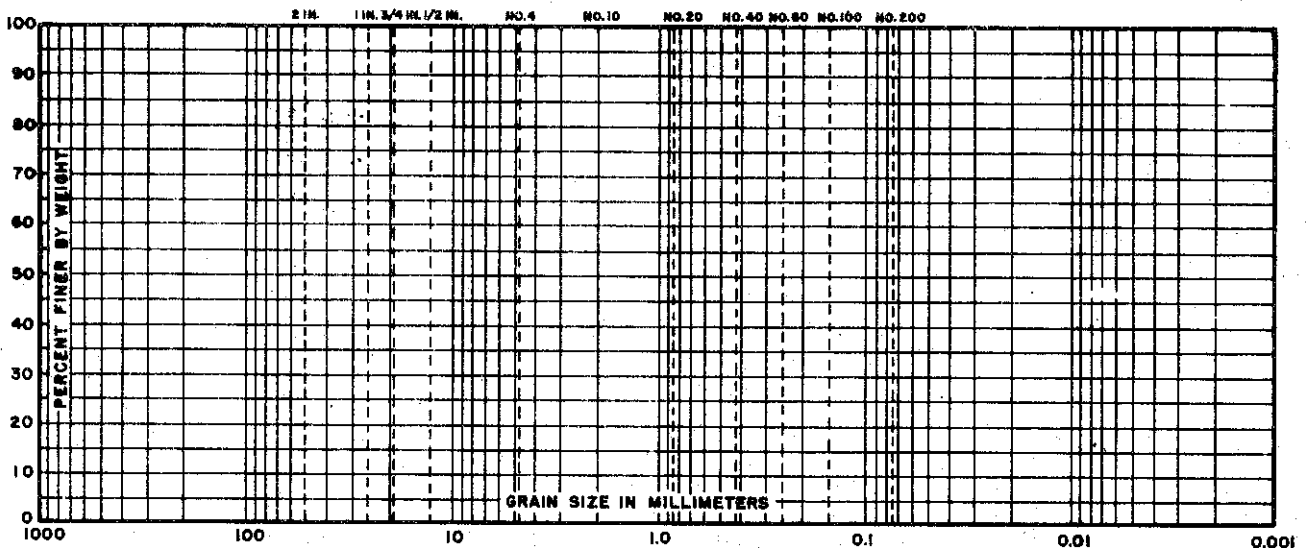

COBBLES	GRAVEL		SAND			SILT OR CLAY
	COARSE	FINE	COARSE	MEDIUM	FINE	

UNIFIED SOIL CLASSIFICATION SYSTEM

COMPACTION

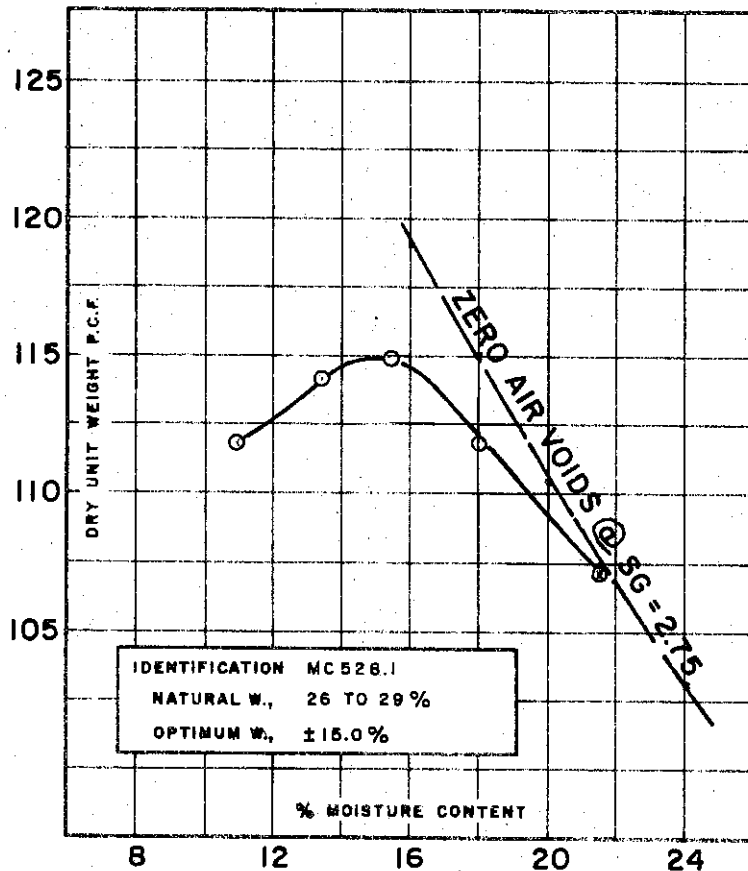

ATTERBERG LIMITS

IDENTIFICATION L 528.1
 LIQUID LIMIT 56
 PLASTIC LIMIT 23

MATERIAL SOURCE

IDENTIFICATION SILTY CLAY (CH)
 EXPLORATION BORING 141
 SAMPLE 1
 DEPTH 3.0' TO 5.0'

COMPACTION METHOD

ASTM TEST D1557 - METHOD C.
 AASHO TEST
 MOLD HEIGHT 4.58", MOLD DIAM. 4.00"
 NO. LAYERS 5, BLOWS/LAYER 25,
 HAMMER WT. 10 LBS, DROP HT. 18"

NOTES:

THE DETROIT EDISON COMPANY
 BELLE RIVER PLANT UNITS I & II
 COMPACTION - GRADATION
 TESTS

FILE NO. 1255 DATE NOV. 74

GRAIN SIZE DISTRIBUTION

U.S. STANDARD SIEVE SIZE

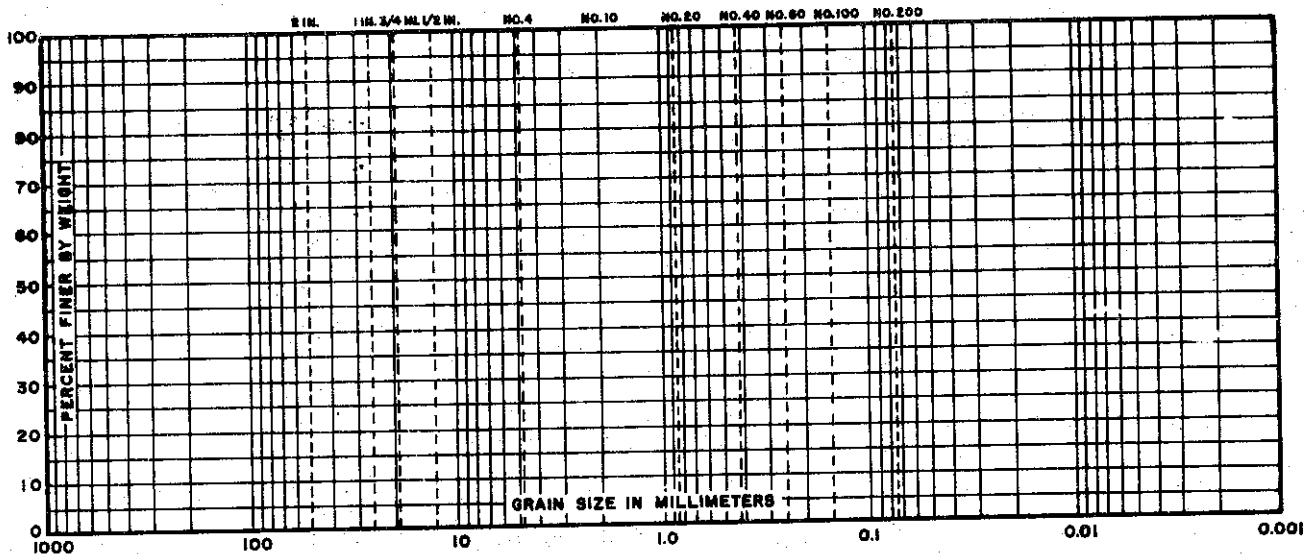

COBBLES	GRAVEL		SAND			SILT OR CLAY
	COARSE	FINE	COARSE	MEDIUM	FINE	

UNIFIED SOIL CLASSIFICATION SYSTEM

COMPACTION

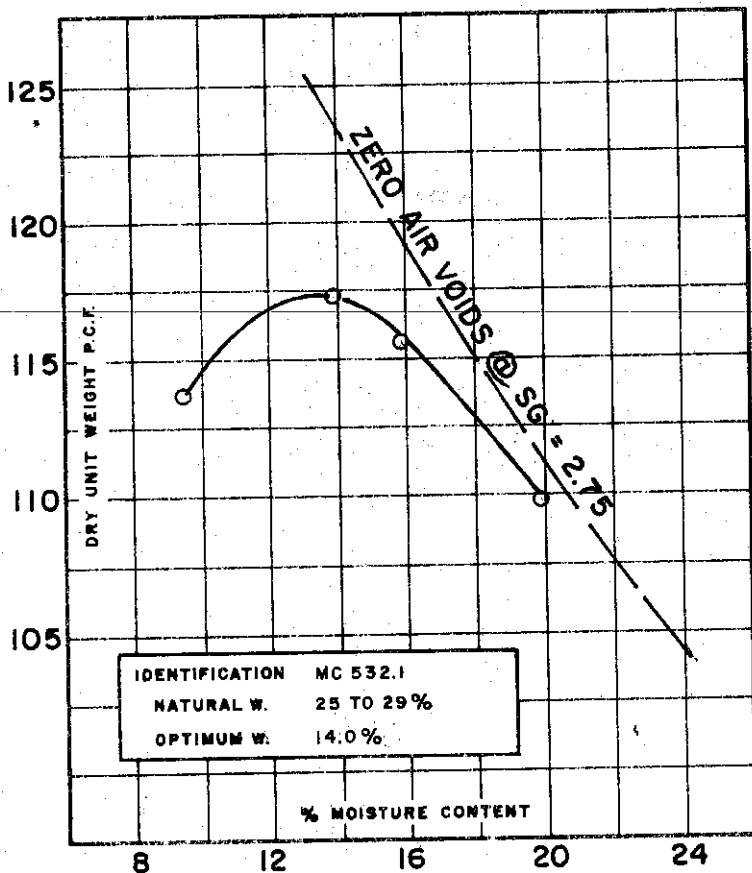

ATTERBERG LIMITS

IDENTIFICATION L 532.1
 LIQUID LIMIT 54
 PLASTIC LIMIT 23

MATERIAL SOURCE

IDENTIFICATION SILTY CLAY (CH)
 EXPLORATION BORING 142
 SAMPLE 1
 DEPTH 3.0' TO 5.5'

COMPACTION METHOD

ASTM TEST D1557 - METHOD C
 AASHTO TEST
 MOLD HEIGHT 4.58", MOLD DIAM. 4.00"
 NO. LAYERS 5, BLOWS/LAYER 25,
 HAMMER WT. 10 LBS, DROP HT. 18"

NOTES:

THE DETROIT EDISON COMPANY
 BELLE RIVER PLANT UNITS I & II
 COMPACTION - GRADATION
 TESTS

FILE NO. 1255 DATE APRIL 74

C-660

GRAIN SIZE DISTRIBUTION

U.S. STANDARD SIEVE SIZE

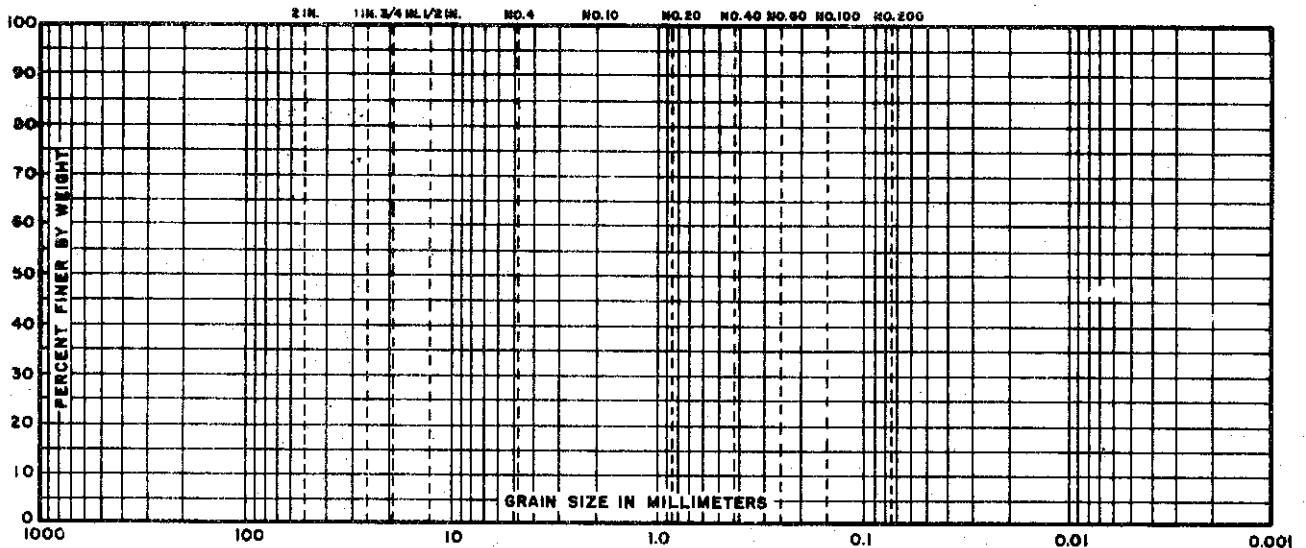

COBBLES	GRAVEL		SAND			SILT OR CLAY
	COARSE	FINE	COARSE	MEDIUM	FINE	

UNIFIED SOIL CLASSIFICATION SYSTEM

COMPACTION

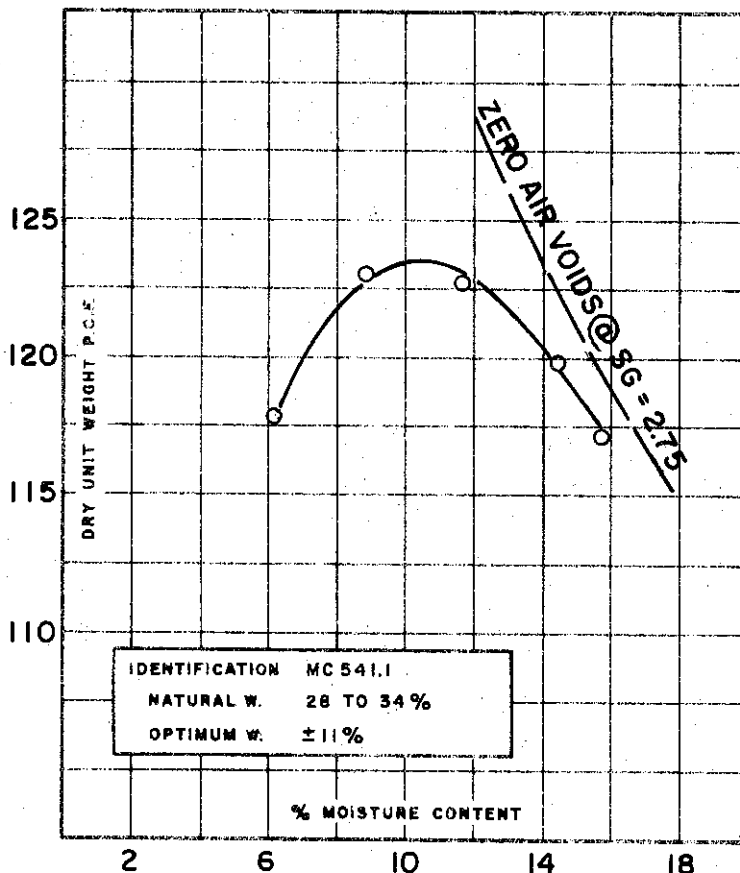

IDENTIFICATION MC 541.1
 NATURAL W. 28 TO 34%
 OPTIMUM W. ±11%

ATTERBERG LIMITS

IDENTIFICATION L 541.1
 LIQUID LIMIT 38
 PLASTIC LIMIT 19

MATERIAL SOURCE

IDENTIFICATION SILTY CLAY, SANDY (CL)
 EXPLORATION BORING 146
 SAMPLE 5
 DEPTH 10.0' TO 12.0'

COMPACTION METHOD

ASTM TEST D1557 - METHOD C
 AASHO TEST
 MOLD HEIGHT 4.58", MOLD DIAM. 4.00"
 NO. LAYERS 5, BLOWS/LAYER 25,
 HAMMER WT. 10 LBS, DROP HT. 18"

NOTES:

THE DETROIT EDISON COMPANY
 BELLE RIVER PLANT UNITS I & II
 COMPACTION - GRADATION
 TESTS

FILE NO. 1255 DATE APRIL 74

Appendix D

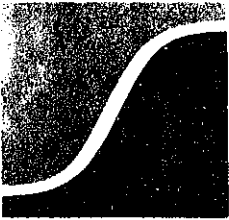

U.W. STOLL AND ASSOCIATES soil mechanics and foundation consultants
111 WEST KINGSLEY STREET ANN ARBOR, MICHIGAN 48103 (313) 994-5055

ULRICH W. STOLL
GARRETT EVANS
IN-KUIN KIM

September 8, 1975

Mr. Sherif Afifi
Bechtel Power Corporation
P. O. Box 1000
777 East Eisenhower Parkway
Ann Arbor, Michigan 48106

SUBJECT: Soil Testing
Hopper Investigation
Belle River Coal Handling
Detroit Edison Company
Technical Specification, 10539-3-C-13
REFERENCE: Purchase Order No. AA2184

Dear Sir:

Enclosed herewith is the summary of laboratory testing conducted on soil samples received from the subject site, as authorized by the referenced purchase order. The laboratory testing was performed in accordance with your technical specification 10539-3-C-13 and included the following tests:

	<u>Pages</u>
30 Visual Classification and In-Situ Moistures	B-1, B-2, B-9
10 Atterberg Limits	B-3, B-4, B-5
30 Unconfined Compression	B-6 through B-28
2 In-Situ Moisture and Density	B-6, B-8
5 Mechanical Analysis	B-29, B-30

We appreciate the opportunity of serving you and trust that this work has been performed to your satisfaction.

Very truly yours,

U. W. STOLL AND ASSOCIATES

In-Kuin Kim, P.E.

IKK/jb

Enclosures

U. W. STOLL AND ASSOCIATES
soil mechanics and foundation consultants

JOB NAME: HOPPER INVESTIGATION - BELLE RIVER
JOB LOCATION: BELLE RIVER, MICHIGAN
CLIENT: BECHTEL CORPORATION

BY: IKK DATE: 8/75
SUBJECT: NATURAL MOISTURES OF
BOTTLE SAMPLES

<u>BORING NUMBER</u>	<u>SAMPLE NUMBER</u>	<u>MOISTURE CONTENT (%)</u>	<u>VISUAL CLASSIFICATION</u>
B-191	S-1	23.2	GRAY-BROWN MOTTLED CLAY
	S-2	25.6	BROWN LAYERED CLAY
	S-3	38.6	GRAY CLAY WITH DRILL WASH
	S-4	35.9	GRAY CLAY WITH DRILL WASH
	S-5	39.6	GRAY CLAY WITH DRILL WASH
	S-6	43.1	GRAY CLAY WITH DRILL WASH
	S-7	39.4	GRAY CLAY
	S-8	32.5	GRAY CLAY
	S-9	34.6	GRAY CLAY
	S-10	37.1	GRAY CLAY
	S-11	33.4	GRAY CLAY
	S-12	30.7	GRAY CLAY WITH DRILL WASH
	S-13	28.7	GRAY CLAY WITH TRACE OF DRILL WASH
	S-14	27.2	GRAY CLAY WITH TRACE OF DRILL WASH
	S-15	27.1	GRAY CLAY
	S-16	24.2	GRAY CLAY
	S-17	24.0	GRAY CLAY
	S-18	24.8	GRAY CLAY
	S-19	26.8	GRAY CLAY WITH TRACE OF DRILL WASH
	S-20	25.4	GRAY CLAY
	S-21	25.9	GRAY CLAY
	S-22	27.8	GRAY CLAY
	S-23	26.7	GRAY CLAY
	S-24	25.9	GRAY CLAY
	S-25	32.2	GRAY CLAY

U. W. STILL AND ASSOCIATES
soil mechanics and foundation consultants

JOB NAME: HOPPER INVESTIGATION - BELLE RIVER
JOB LOCATION: BELLE RIVER, MICHIGAN
CLIENT: BECHTEL CORPORATION

BY: IKK DATE: 8/75
SUBJECT: NATURAL MOISTURES OF
BOTTLE SAMPLES

<u>BORING NUMBER</u>	<u>SAMPLE NUMBER</u>	<u>MOISTURE CONTENT (%)</u>	<u>VISUAL CLASSIFICATION</u>
B-191	S-26	40.6	GRAY CLAY
	S-27	25.7	WET CLAYEY SILT
	S-28	12.6	SANDY SILT
	S-29	10.2	DECOMPOSED SHALE



U. W. STOLL and ASSOCIATES
 SOIL MECHANICS AND FOUNDATION CONSULTANTS

JOB NAME: HOPPER INVESTIGATION, BELLE RIVER
 JOB LOCATION: BELLE RIVER, MICHIGAN
 CLIENT: BECHTEL POWER CORPORATION

BY: IKK DATE: 8/75
 SUBJECT: LABORATORY TEST DATA SUMMARY

BORING NO.	SAMPLE NO.	DEPTH OF SAMPLE (FT.)	MOISTURE DENSITY		GRAIN SIZE DISTRIBUTION (% OF TEST SAMPLE)							ATTERBERG LIMITS			STRENGTH TESTS			
			NATURAL MOISTURE (% OF DRY WTS.)	NATURAL DRY DENSITY (LBS/CU.FT.)	COLLOIDS	CLAY	SILT	FINE SAND	MEDIUM SAND	COARSE SAND	GRAVEL	LIQUID LIMIT	PLASTIC INDEX	SHRINKAGE LIMIT	TYPE OF TEST	MAX. PRINCIPAL STRESS (KG/SQ.CM.)	MIN. PRINCIPAL STRESS (KG/SQ.CM.)	AXIAL STRAIN AT FAILURE (%)
B-193	ST-1	6	13.4	103.6										UNCONF.			5%	4200
	ST-4	18.5	36.3	85.5										UNCONF.			3%	870
	ST-7	33.5	42.6	80.5										UNCONF.			3%	690
	ST-11	51.5	27.5	95.5										UNCONF.			6%	680
	ST-13	61.5	25.7	99.3										UNCONF.			16%	1190
	ST-15	72.5	22.2	103.6										UNCONF.			14%	1690
	ST-16	77.0	26.9	95.5										UNCONF.			5%	500
	ST-16	78.0	26.3	96.1										UNCONF.			4%	1560
	ST-19	98.0	23.6	99.3										UNCONF.				590
B-192	ST-1	20.0	31.9	88.7										UNCONF.			8%	460
	ST-4	35.0	33.1	88.0										UNCONF.			2%	710
	ST-6	45.0	39.2	78.7										UNCONF.			1%	630
	ST-7	52.0	34.5	87.4										UNCONF.			4%	660



U. W. STOLL and ASSOCIATES

SOIL MECHANICS AND FOUNDATION CONSULTANTS

JOB NAME: HOPPER INVESTIGATION, BELLE RIVER
 JOB LOCATION: BELLE RIVER, MICHIGAN
 CLIENT: BECHTEL POWER CORPORATION

BY: IKK DATE: 8/75
 SUBJECT: PLASTICITY CHART

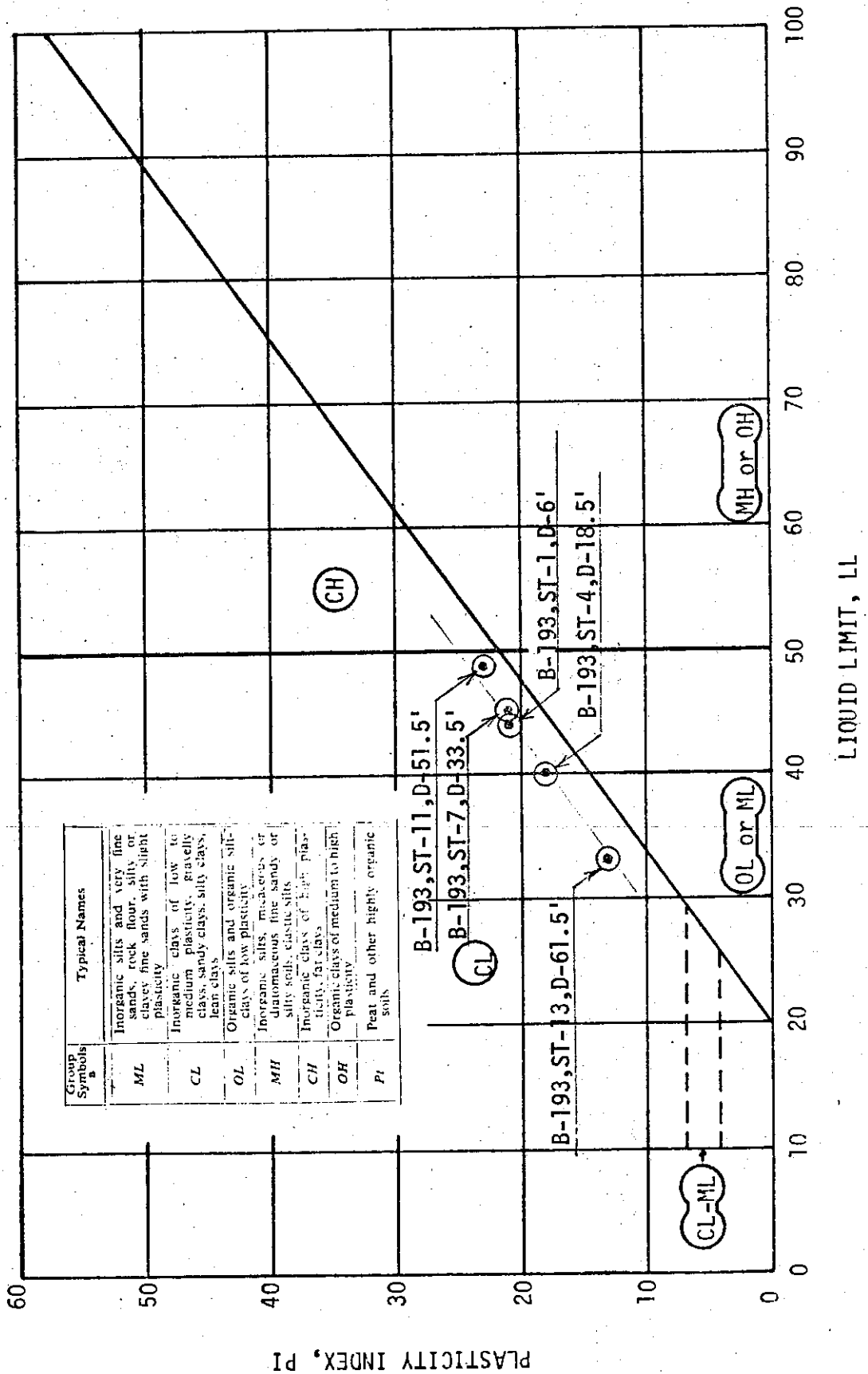



U. W. STOLL and ASSOCIATES

SOIL MECHANICS AND FOUNDATION CONSULTANTS

JOB NAME: HOPPER INVESTIGATION, BELLE RIVER
 JOB LOCATION: BELLE RIVER, MICHIGAN
 CLIENT: BECHTEL POWER CORPORATION

BY: IKK DATE: 8/75
 SUBJECT: PLASTICITY CHART

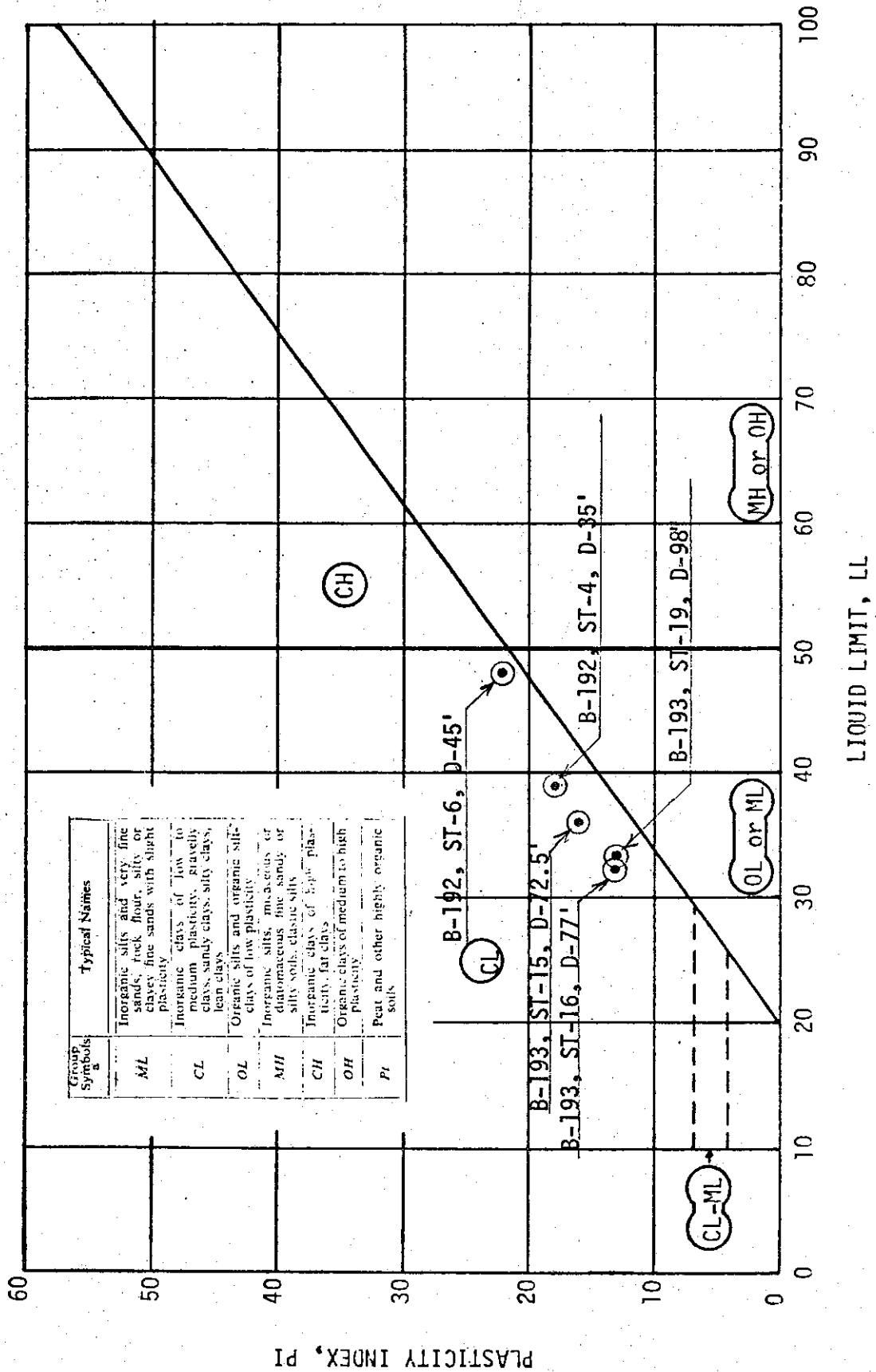

U. W. STOLL AND ASSOCIATES
soil mechanics and foundation consultants

JOB: HOPPER INVESTIGATION, BELLE RIVER
JOB LOCATION: BELLE RIVER, MICHIGAN
CLIENT: BECHTEL POWER CORPORATION

BY: IKK
SUBJECT:

DATE: 8/75

FIELD DATA LABORATORY DATA

BORING ----- SAMPLE	DEPTH ----- ELEV	A.S.T.M.		LABORATORY DESCRIPTION	TEST ----- DIAM (MM)	STRAIN	SHEAR	NATURAL
		PENETRATION BLOW	DEPTH				STRENGTH UNDIST	MOISTURE
							REMOLD	DRY DENS
							(KN/SQ.M)	(MG/CU.M)
B-193	6.0			STIFF BROWN SILT	UNCF		201.0	13.4%
ST-1	-6.0	PUSHED		CLAY WITH PEBBLE	72.0	5%		1.66
		\$		QU=4.5 TSF				
B-193	10.0			BROWN MOTTLED	NONE			30.0%
ST-2	-10.0	PUSHED		CLAY WITH PEBBLE	72.5			1.49
				SAMPLING DISTURBED				
				QU=1.75 TSF				
B-193	12.8			SOFT GRAY, CLAY	UNCF		61.3	32.6%
ST-3	-12.8	PUSHED		WITH SEAM OF SILTY	72.5	4%		1.44
				DARK GRAY SANDY				
				CLAY, TV=.57 TSF				
B-193	18.5			TAN GRAY SOFT	UNCF		41.8	36.3%
ST-4	-18.5	PUSHED		SILTY CLAY	72.5	3%		1.37
				(LACUSTRINE)				
				TV=.32 TSF				
B-193	23.5			TAN GRAY SOFT	UNCF		39.3	32.8%
ST-5	-23.5	PUSHED		PLASTIC CLAY	72.5	2%		1.38
				(LACUSTRINE)				
				TV=.29 TSF				
B-193	28.5			TAN GRAY SOFT	UNCF		29.6	41.4%
ST-6	-28.5	PUSHED		PLASTIC CLAY	72.0	2%		1.32
				(LACUSTRINE)				
				TV=.27 TSF				
B-193	33.5			TAN GRAY SOFT	UNCF		32.9	42.6%
ST-7	-33.5	PUSHED		PLASTIC CLAY	72.1	3%		1.29
				(LACUSTRINE)				
				TV=.27 TSF				

UNIT CONVERSIONS: 1 KN/SQ.M=20.88 PSF, 1 MG/CU.M=62.43 PCF)

U. W. STOLL AND ASSOCIATES
soil mechanics and foundation consultants

JOB NAME: HOPPER INVESTIGATION, BELLE RIVER
 JOB LOCATION: BELLE RIVER, MICHIGAN
 CLIENT: BECHTEL POWER CORPORATION

BY: IKK
 SUBJECT:

DATE: 8/75

FIELD DATA			LABORATORY DATA				
BORING ----- SAMPLE	DEPTH ----- ELEV	A.S.T.M. PENETRATION BLOW DEPTH	LABORATORY DESCRIPTION	TEST ---- DIAM (MM)	STRAIN	SHEAR STRENGTH UNDIST ----- REMOLD (KN/SQ.M)	NATURAL MOISTURE ----- DRY DENS (MG/CU.M)
B-193	38.5	PUSHED	TAN GRAY SOFT PLASTIC CLAY (LACUSTRINE)	UNCF	3%	42.9	38.4%
ST-8	-38.5		TV=.37TSF	72.9		1.33	
B-193	41.5	PUSHED	TAN GRAY SOFT LACUSTRINE CLAY	UNCF	2%	31.6	40.6%
ST-9	-41.5		TV=0.35TSF	72.3		1.30	
B-193	46.5	PUSHED	REDDISH-GRAY SOFT CLAY (LACUSTRINE)	UNCF	2%	40.4	46.5%
ST-10	-46.5		TV=0.35TSF	72.2		1.21	
B-193	51.5	PUSHED	SOFT GRAY MOTTLED LACUSTRINE CLAY	UNCF	6%	32.4	27.5%
ST-11	-51.5		TV=.29TSF	72.3		1.53	
B-193	56.5	PUSHED	SOFT GRAY PEBBLY SANDY CLAY	UNCF	16%	41.1	20.6%
ST-12	-56.5		TV=.41TSF	72.3		1.52	
B-193	61.5	PUSHED	PLASTIC GRAY SILTY CLAY WITH PEBBLES	UNCF	16%	56.9	25.7%
ST-13	-61.5		TV=.5 TSF	72.5		1.59	

U. W. STOLL AND ASSOCIATES
soil mechanics and foundation consultants

JOB NAME: HOPPER INVESTIGATION, BELLE RIVER
JOB LOCATION: BELLE RIVER, MICHIGAN
CLIENT: BECHTEL POWER CORPORATION

BY: IKK DATE: 8/75
SUBJECT:

FIELD DATA LABORATORY DATA

BORING ----- SAMPLE	DEPTH ----- ELEV	A.S.T.M. PENETRATION BLOW	LABORATORY DEPTH DESCRIPTION	TEST ----- DIAM (MM)	STRAIN	SHEAR	NATURAL
						STRENGTH UNDIST	MOISTURE
						REMOLD (KN/SQ.M)	DRY DENS (MG/CU.M)
B-193	66.0		FIRM GRAY SILTY CLAY	UNCF		78.9	22.3%
ST-14	-66.0	PUSHED	WITH PEBBLES TV= 0.63 TSF	72.3	20%		1.67
B-193	72.5		GRAY SILTY CLAY	UNCF		80.8	22.2%
ST-15	-72.5	PUSHED	WITH PEBBLES TV=.67-.78 TSF	72.4	14%		1.66
B-193	77.0		FIRM V. SILTY GRAY CLAY	UNCF		24.1	26.9%
ST-16	-77.0	PUSHED	SAND SEAMS TV=.65 TSF	72.9	5%		1.53
B-193	78.0		GRAY SILTY CLAY	UNCF		74.9	26.3%
ST-16	-78.0	PUSHED	WITH PEBBLES TV= .77 TSF	72.1	4%		1.54
B-193	82.0		GRAY SILTY CLAY	UNCF		70.8	20.4%
ST-17	-82.0	PUSHED	WITH PEBBLES TV= .85 TSF	72.2	14%		1.72
B-193	93.5		GRAY SILTY CLAY	NONE			25.5%
ST-18	-93.5	PUSHED	WITH PEBBLES DRILL WASH	71.1			1.62

(UNIT CONVERSIONS: 1 KN/SQ.M=20.88 PSF, 1 MG/CU.M=62.43 PCF)

U. W. STOLL AND ASSOCIATES
soil mechanics and foundation consultants

JOB NAME: HOPPER INVESTIGATION, BELLE RIVER
 JOB LOCATION: BELLE RIVER, MICHIGAN
 CLIENT: BECHTEL POWER CORPORATION

BY: IKK DATE: 8/75
 SUBJECT:

FIELD DATA LABORATORY DATA

BORING ----- SAMPLE	DEPTH ----- ELEV	A.S.T.M. PENETRATION BLOW	LABORATORY DEPTH DESCRIPTION	TEST ----- DIAM (MM)	STRAIN	SHEAR	NATURAL	
						STRENGTH UNDIST	MOISTURE	
						REMOLD (KN/SQ.M)	DRY DENS (MG/CU.M)	
B-193	98.0		GRAY SILTY CLAY WITH SOME	UNCF		28.0	23.6%	
		PUSHED			20%			
ST-19	-98.0		PEBBLES & MOTTLE TV=.45 TSF	72.4			1.59	
B-193, ST-20		PUSHED	GRAY SILTY CLAY WITH PEBBLES & DRILL WASH	NO TEST			31.1%	
B-193	112.0		SOFT GRAY SILTY CLAY	UNCF		19.1	28.5%	
		PUSHED			20%			
ST-21	-112.0		WITH PEBBLES TV=0.22 TSF	72.7			1.47	
B-193, ST-22		}	NO TESTS DUE TO DRILL WASH					
B-193, ST-23								

U. W. STOLL AND ASSOCIATES
soil mechanics and foundation consultants

JOB NAME HOPPER INVESTIGATION, BELLE RIVER
JOB LOCATION BELLE RIVER, MICHIGAN
CLIENT: BECHTEL POWER CORPORATION

BY: IKK
SUBJECT:

DATE: 8/75

FIELD DATA LABORATORY DATA

BORING ----- SAMPLE	DEPTH ----- ELEV	A.S.T.M.		LABORATORY DESCRIPTION	TEST ----- DIAM (MM)	STRAIN	SHEAR	NATURAL
		PENETRATION	BLOW DEPTH				UNDIST	MOISTURE
							REMOLD	DRY DENS
							(KN/SQ.M)	(MG/CU.M)
B-192	20.0			GRAYISH BROWN	UNCF		22.1	31.9%
		PUSHED		PLASTIC SOFT		8%		
ST-1	-20.0			LACUSTRINE CLAY	72.7			1.42
				TV=.27 TSF				
B-192	25.0			GRAYISH BROWN	UNCF		27.8	35.6%
		PUSHED		SOFT PLASTIC		4%		
ST-2	-25.0			LACUSTRINE CLAY	72.2			1.37
				TV=.27 TSF				
B-192	30.0			GRAYISH BROWN	UNCF		27.7	41.8%
		PUSHED		PLASTIC SOFT		3%		
ST-3	-30.0			LACUSTRINE CLAY	72.3			1.28
				TV=.25 TSF				
B-192	35.0			GRAYISH BROWN	UNCF		34.2	33.1%
		PUSHED		SOFT PLASTIC		2%		
ST-4	-35.0			CLAY(LACUSTRINE)	72.5			1.41
				TV=.28 TSF				
B-192	40.0			GRAYISH BROWN	UNCF		40.5	36.4%
		PUSHED		PLASTIC SOFT		2%		
ST-5	-40.0			LACUSTRINE CLAY	72.4			1.31
				TV=.28 TSF				
B-192	45.0			BROWNISH GRAY	UNCF		30.2	39.2%
		PUSHED		PLASTIC LACUSTRI		1%		
ST-6	-45.0			CLAY (MOTTLED)	72.3			1.26
				TV=.32 TSF				
B-192	52.0			FIRM GRAY	UNCF		31.4	34.5%
		PUSHED		SILTY CLAY		4%		
ST-7	-52.0			WITH PEBBLES	72.3			1.40
				TV= 0.26 TSF				

(UNIT CONVERSIONS: 1 KN/SQ.M=20.88 PSF, 1 MG/CU.M=62.43 PCF)

U. W. STOLL AND ASSOCIATES
soil mechanics and foundation consultants

JOB NAME: HOPPER INVESTIGATION, BELLE RIVER
JOB LOCATION: BELLE RIVER, MICHIGAN
CLIENT: BECHTEL POWER CORPORATION

BY: IKK
SUBJECT:

DATE: 8/75

F I E L D D A T A L A B O R A T O R Y D A T A

BORING ----- SAMPLE	DEPTH ----- ELEV	A.S.T.M.		LABORATORY DESCRIPTION	TEST ---- DIAM (MM)	STRAIN	SHEAR	NATURAL
		PENETRATION	BLOW DEPTH				UNDIST	MOISTURE
							REMOLD (KN/SQ.M)	DRY DENS (MG/CU.M)
B-192	55.0			SOFT GRAY SILTY CLAY	UNCF		36.8	27.8%
		PUSHED		WITH PEBBLES		10%		
ST-8	-55.0			TV=0.40 TSF	72.5			1.54
B-192	80.0			SOFT GRAY SILTY CLAY WITH	UNCF		84.5	26.6%
		PUSHED		FINE SAND LAYERS		7%		
ST-11	-80.0			TV=.52 TSF	72.5			1.55
B-192	60.0			PLASTIC GRAY SILTY CLAY	UNCF		46.0	26.5%
		PUSHED		WITH PEBBLES		16%		
ST-9	-60.0			TV=0.50 TSF	72.5			1.57
B-192	70.0			FIRM GRAY SILTY CLAY	UNCF		85.2	24.3%
		PUSHED		WITH PEBBLES		20%		
ST-10	-70.0			TV=0.82 TSF	72.3			1.64

U. W. STOLL AND ASSOCIATES
soil mechanics and foundation consultants

JOB NAME: HOPPER INVESTIGATION, BELLE RIVER
JOB LOCATION: BELLE RIVER, MICHIGAN
CLIENT: BECHTEL POWER CORPORATION

BY: IKK DATE: 8/75
SUBJECT:

SAMPLE IDENTIFICATION: B-193, ST-1, D-6

DIAL GAGE	LOAD GAGE	STRAIN %	STRESS (PSF)
1.50	.0	.00	119.33
2.00	5.0	.33	1064.92
2.50	11.0	.66	2192.85
3.00	16.5	.98	3219.35
3.50	21.0	1.31	4051.68
4.00	25.0	1.64	4785.06
4.50	28.5	1.97	5420.41
5.00	31.8	2.29	6014.33
5.50	35.0	2.62	6585.65
6.00	37.5	2.95	7024.04
6.50	39.8	3.28	7422.60
7.00	41.8	3.60	7763.41
7.50	43.5	3.93	8047.02
8.00	44.9	4.26	8274.00
8.50	45.6	4.59	8372.46
9.00	45.9	4.91	8397.85
9.50	45.9	5.24	8368.92
10.00	44.0	5.57	7999.41
10.50	39.0	5.90	7078.55

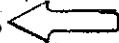

SAMPLE IDENTIFICATION: B-193, ST-3, D-12.8

DIAL GAGE	LOAD GAGE	STRAIN %	STRESS (PSF)
1.00	.0	.00	117.69
1.50	113.0	.35	595.39
2.00	222.0	.71	1052.83
2.50	332.0	1.06	1511.20
3.00	422.0	1.41	1882.54
3.50	485.0	1.77	2138.56
4.00	527.0	2.12	2305.42
4.50	558.0	2.48	2425.46
5.00	578.0	2.83	2499.18
5.50	590.0	3.18	2539.42
6.00	597.5	3.54	2560.86
6.50	600.0	3.89	2561.68
6.80	600.0	4.10	2556.02
7.00	599.0	4.24	2548.19
7.50	596.0	4.60	2526.63
8.00	593.0	4.95	2505.15



SAMPLE IDENTIFICATION: B-193, ST-4, D-18.5

DIAL GAGE	LOAD GAGE	STRAIN %	STRESS (PSF)
6.50	.0	.00	117.69
7.00	87.0	.33	485.48
7.50	160.0	.67	791.74
8.00	230.0	1.00	1083.33
8.50	290.0	1.34	1331.04
9.00	336.0	1.67	1518.59
9.50	366.0	2.00	1638.26
10.00	385.0	2.34	1711.47
10.50	395.0	2.67	1746.94
11.00	396.5	3.01	1747.13
11.50	388.0	3.34	1706.22
12.00	364.0	3.67	1600.15



U. W. STOLL AND ASSOCIATES
soil mechanics and foundation consultants

JOB NAME: HOPPER INVESTIGATION, BELLE RIVER
JOB LOCATION: BELLE RIVER, MICHIGAN
CLIENT: BECHTEL POWER CORPORATION

BY: IKK DATE: 8/75
SUBJECT:

SAMPLE IDENTIFICATION;		B-193, ST-5, D-23.5	
DIAL GAGE	LOAD GAGE	STRAIN %	STRESS (PSF)
4.50	.0	.00	117.69
5.00	80.0	.33	455.87
5.50	175.0	.66	855.09
6.00	272.0	.99	1260.05
6.50	337.0	1.32	1528.21
7.00	363.0	1.65	1631.69
7.30	366.0	1.85	1640.91
7.50	355.0	1.98	1592.92
8.00	323.0	2.31	1454.83
8.50	310.0	2.64	1396.17

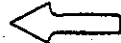

SAMPLE IDENTIFICATION;		B-193, ST-6, D-28.5	
DIAL GAGE	LOAD GAGE	STRAIN %	STRESS (PSF)
.00	.0	.00	119.33
1.00	124.0	.64	649.00
1.50	200.0	.96	970.96
2.00	250.0	1.28	1180.32
2.50	264.0	1.60	1235.80
3.00	265.0	1.92	1236.00
4.00	260.0	2.56	1206.94
5.00	250.0	3.21	1157.33
6.00	244.0	3.85	1124.83

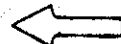

SAMPLE IDENTIFICATION;		B-193, ST-7, D-33.5	
DIAL GAGE	LOAD GAGE	STRAIN %	STRESS (PSF)
2.00	.0	.00	119.00
3.00	89.0	.65	497.86
4.00	177.0	1.30	867.51
5.00	260.0	1.95	1211.21
6.00	300.5	2.60	1372.55
7.00	290.0	3.25	1319.78
8.00	272.0	3.90	1236.66
9.00	262.0	4.55	1187.32



SAMPLE IDENTIFICATION;		B-193, ST-8, D-38.5	
DIAL GAGE	LOAD GAGE	STRAIN %	STRESS (PSF)
1.00	.0	.00	116.41
1.50	85.0	.35	471.73
2.00	138.0	.70	691.11
2.50	198.0	1.04	938.03
3.00	267.0	1.39	1220.47
3.50	331.0	1.74	1480.26
4.00	376.0	2.09	1660.05
4.50	400.0	2.44	1752.48
5.00	411.0	2.79	1791.13
5.50	412.5	3.13	1790.82
6.00	408.0	3.48	1766.14
6.50	390.0	3.83	1723.42

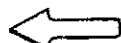

U. W. STOLL AND ASSOCIATES
soil mechanics and foundation consultants

JOB NAME: HOPPER INVESTIGATION, BELLE RIVER
 JOB LOCATION: BELLE RIVER, MICHIGAN
 CLIENT: BECHTEL POWER CORPORATION

BY: IKK
 SUBJECT:

DATE: 8/75

SAMPLE IDENTIFICATION:

B-193, ST-9, D-41.5

DIAL GAGE	LOAD GAGE	STRAIN %	STRESS (PSF)
.00	.0	.00	118.35
.50	91.0	.32	505.25
1.00	151.0	.64	758.14
1.25	179.0	.81	875.50
1.50	203.0	.97	975.56
1.75	224.0	1.13	1062.62
2.00	244.0	1.29	1145.18
2.50	272.0	1.61	1259.07
3.00	288.0	1.93	1321.94
3.50	288.0	2.26	1317.60
3.80	286.0	2.45	1306.66
4.30	281.0	2.77	1281.59
4.50	278.0	2.90	1267.45
5.00	270.0	3.22	1230.19



SAMPLE IDENTIFICATION:

B-193, ST-10, D-46.5

DIAL GAGE	LOAD GAGE	STRAIN %	STRESS (PSF)
.00	.0	.00	118.67
.25	69.0	.16	413.41
.50	116.0	.33	613.30
.75	160.0	.49	799.74
1.00	205.0	.66	989.82
1.25	245.0	.82	1158.03
1.50	285.0	.99	1325.68
2.00	349.0	1.32	1591.68
2.50	373.0	1.64	1687.44
3.00	358.0	1.97	1618.84
4.00	325.0	2.63	1470.41



U. W. STOLL AND ASSOCIATES
soil mechanics and foundation consultants

JOB NAME: HOPPER INVESTIGATION, BELLE RIVER
JOB LOCATION: BELLE RIVER, MICHIGAN
CLIENT: BECHTEL POWER CORPORATION

BY: IKK DATE: 8/75
SUBJECT:

SAMPLE IDENTIFICATION;		B-193, ST-11, D-51.5	
DIAL GAGE	LOAD GAGE	STRAIN %	STRESS (PSF)
1.00	.0	.00	118.35
1.25	38.0	.17	280.13
1.50	60.0	.33	373.29
2.00	100.0	.66	541.71
2.50	138.0	.99	700.54
3.00	176.0	1.32	858.31
3.50	205.0	1.65	977.21
4.00	232.0	1.98	1086.93
4.50	252.0	2.31	1166.68
5.00	266.0	2.64	1220.93
5.50	277.0	2.97	1262.36
6.00	284.5	3.30	1289.03
6.50	290.5	3.63	1309.31
7.00	295.0	3.96	1323.28
7.50	299.0	4.29	1335.07
8.00	302.0	4.62	1342.68
8.50	303.5	4.95	1344.12
9.00	306.0	5.28	1349.56
9.50	307.5	5.61	1350.90
10.00	309.0	5.94	1352.20
10.50	309.5	6.27	1349.45
11.00	310.2	6.61	1347.49
11.50	310.9	6.94	1345.50
12.00	311.3	7.27	1342.31
12.50	311.6	7.60	1338.72
13.00	311.7	7.93	1334.32
13.50	311.7	8.26	1329.54
14.50	310.5	8.92	1315.30
15.00	310.0	9.25	1308.59



U. W. STOLL AND ASSOCIATES
soil mechanics and foundation consultants

JOB NAME: HOPPER INVESTIGATION, BELLE RIVER
JOB LOCATION: BELLE RIVER, MICHIGAN
CLIENT: BECHTEL POWER CORPORATION

BY: IKK DATE: 8/75
SUBJECT:

SAMPLE IDENTIFICATION;
DIAL GAGE LOAD GAGE

B-193,ST-12,D-56.5

STRAIN STRESS
% (PSF)

.00	.0	.00	118.35
.25	44.0	.16	305.71
.50	63.0	.33	386.06
.75	81.0	.49	461.89
1.00	96.0	.66	524.75
1.75	135.0	1.15	686.75
2.00	150.0	1.32	748.81
2.50	177.0	1.64	859.69
3.00	204.0	1.97	969.82
3.50	227.0	2.30	1062.51
4.00	249.0	2.63	1150.39
4.50	268.0	2.96	1225.22
5.00	284.0	3.29	1287.14
6.00	309.0	3.95	1380.91
7.00	329.0	4.61	1452.91
8.00	345.0	5.26	1507.61
9.00	358.5	5.92	1551.37
10.00	369.5	6.58	1584.40
11.00	379.0	7.24	1610.86
12.00	387.5	7.89	1632.87
13.00	395.0	8.55	1650.49
14.00	401.5	9.21	1663.81
16.00	413.0	10.53	1683.63
17.00	418.0	11.18	1690.21
18.00	422.5	11.84	1694.63
19.00	428.0	12.50	1702.53
20.00	432.5	13.16	1706.41
21.00	437.0	13.82	1710.04
22.00	441.0	14.47	1711.60
24.00	449.5	15.79	1715.82
25.00	453.5	16.45	1716.69
27.00	461.0	17.76	1715.99
28.00	465.0	18.42	1716.19
29.00	468.0	19.08	1712.72
30.40	471.5	20.00	1705.18

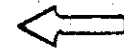

U. W. STOLL AND ASSOCIATES
soil mechanics and foundation consultants

JOB NAME: HOPPER. INVESTIGATION, BELLE RIVER
 JOB LOCATION: BELLE RIVER, MICHIGAN
 CLIENT: BECHTEL POWER CORPORATION

BY: IKK DATE: 8/75
 SUBJECT:

SAMPLE IDENTIFICATION;		B-193, ST-13, D-61.5	
DIAL GAGE	LOAD GAGE	STRAIN	STRESS
		%	(PSF)
1.00	.0	.00	117.69
1.50	76.0	.33	438.93
2.00	113.0	.67	593.53
2.50	48.0	1.00	318.30
3.00	182.0	1.33	878.63
3.50	218.0	1.66	1025.99
4.00	255.0	2.00	1176.49
4.50	292.0	2.33	1325.94
5.00	323.0	2.66	1449.55
5.50	353.0	2.99	1568.17
6.00	378.0	3.33	1665.41
6.50	398.0	3.66	1741.49
7.00	414.0	3.99	1800.71
7.50	429.0	4.32	1855.40
8.00	443.0	4.66	1905.63
8.50	456.0	4.99	1951.42
9.00	467.5	5.32	1990.82
9.50	478.0	5.66	2025.89
10.00	487.0	5.99	2054.67
10.50	496.0	6.32	2083.20
11.00	504.5	6.65	2109.50
12.00	520.0	7.32	2155.46
13.00	534.0	7.98	2194.68
14.00	547.0	8.65	2229.24
15.00	558.0	9.31	2255.36
16.00	569.0	9.98	2280.86
17.00	579.5	10.65	2303.84
18.00	588.5	11.31	2320.58
19.00	597.0	11.98	2334.94
20.00	604.5	12.64	2345.11
21.00	612.0	13.31	2354.86
22.00	619.0	13.97	2362.35
23.00	626.5	14.64	2371.27
24.00	633.0	15.30	2376.16
25.00	639.0	15.97	2378.90
26.00	644.0	16.63	2377.77
27.00	648.5	17.30	2374.59
28.00	653.0	17.96	2371.16
29.00	657.0	18.63	2365.75
30.00	660.5	19.29	2358.40
31.06	664.0	20.00	2349.68

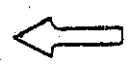

U. W. STOLL AND ASSOCIATES
soil mechanics and foundation consultants

JOB NAME: HOPPER INVESTIGATION, BELLE RIVER
 JOB LOCATION: BELLE RIVER, MICHIGAN
 CLIENT: BECHTEL POWER CORPORATION

BY: IKK
 SUBJECT:

DATE: 8/75

SAMPLE IDENTIFICATION;		B-193, ST-14, D-66	
DIAL GAGE	LOAD GAGE	STRAIN %	STRESS (PSF)
.00	.0	.00	118.35
1.00	105.0	.68	562.77
2.00	205.0	1.37	980.01
3.00	300.0	2.05	1370.48
4.00	382.0	2.74	1701.42
5.00	446.0	3.42	1953.33
6.00	495.0	4.11	2140.09
7.00	535.0	4.79	2287.40
8.00	570.0	5.48	2412.19
9.00	598.0	6.16	2506.89
10.00	625.0	6.85	2595.98
11.00	651.0	7.53	2679.54
12.00	675.0	8.22	2753.74
13.00	697.0	8.90	2818.76
14.00	717.0	9.59	2874.77
15.00	736.0	10.27	2925.78
16.00	755.0	10.96	2975.68
17.00	773.0	11.64	3020.69
18.00	788.0	12.33	3053.42
19.00	804.0	13.01	2088.99
20.00	818.0	13.70	3116.25
21.00	834.0	14.38	3150.01
22.00	848.0	15.07	3175.58
23.00	861.0	15.75	3196.73
24.00	875.0	16.44	3220.69
25.00	887.0	17.12	3236.75
26.00	900.0	17.81	3255.62
27.00	911.0	18.49	3266.77
28.00	923.0	19.18	3280.73
29.00	935.0	19.86	3293.99
29.20	937.0	20.00	3295.19
30.00	947.0	20.55	3306.54
31.00	958.0	21.23	3315.03



U. W. STOLL AND ASSOCIATES
soil mechanics and foundation consultants

JOB NAME: HOPPER INVESTIGATION, BELLE RIVER
 JOB LOCATION: BELLE RIVER, MICHIGAN
 CLIENT: BECHTEL POWER CORPORATION

BY: IKK DATE: 8/75
 SUBJECT:

SAMPLE IDENTIFICATION:		B-193, ST-15, D-72.5	
DIAL GAGE	LOAD GAGE	STRAIN %	STRESS (PSF)
.00	.0	.00	118.02
1.00	80.0	.62	455.81
2.00	130.0	1.24	663.23
3.00	180.0	1.86	868.02
4.00	230.0	2.47	1070.18
5.00	290.0	3.09	1310.96
6.00	355.0	3.71	1569.09
7.00	418.0	4.33	1815.64
8.00	476.0	4.95	2038.64
9.00	529.0	5.57	2238.48
11.00	620.0	6.80	2570.27
12.00	659.0	7.42	2706.94
13.00	692.0	8.04	2818.07
14.00	722.0	8.66	2915.80
15.00	751.0	9.28	3008.08
16.00	776.0	9.89	3083.49
17.00	798.0	10.51	3146.15
18.00	818.0	11.13	3200.08
19.00	838.0	11.75	3252.97
20.00	857.0	12.37	3301.06
22.00	890.0	13.61	3375.86
24.00	902.5	14.84	3372.86
26.00	880.0	16.08	3243.47
28.00	850.0	17.32	3090.05



SAMPLE IDENTIFICATION:		B-193, ST-16, D-77	
DIAL GAGE	LOAD GAGE	STRAIN %	STRESS (PSF)
1.00	.0	.00	116.41
2.00	88.0	.61	483.01
3.00	145.0	1.22	716.51
4.00	187.0	1.83	885.24
5.00	210.0	2.44	973.98
7.00	217.0	3.66	990.13
8.00	222.0	4.27	1003.96
10.00	226.0	5.49	1007.05
11.00	225.0	6.10	996.61

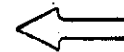

SAMPLE IDENTIFICATION:		B-193, ST-16, D-78	
DIAL GAGE	LOAD GAGE	STRAIN %	STRESS (PSF)
.00	.0	.00	119.00
1.00	250.0	.53	1186.01
2.00	420.0	1.06	1901.79
3.00	535.0	1.59	2377.45
4.00	610.0	2.12	2679.78
5.00	663.0	2.66	2886.75
6.00	698.0	3.19	3016.48
7.00	722.0	3.72	3099.14
8.00	733.0	4.25	3127.27



U. W. STOLL AND ASSOCIATES
soil mechanics and foundation consultants

JOB NAME: HOPPER INVESTIGATION, BELLE RIVER
 JOB LOCATION: BELLE RIVER, MICHIGAN
 CLIENT: BECHTEL POWER CORPORATION

BY: IKK DATE: 8/75
 SUBJECT:

SAMPLE IDENTIFICATION;		B-193, ST-17, D-82	
DIAL GAGE	LOAD GAGE	STRAIN %	STRESS (PSF)
4.00	.0	.00	118.67
4.50	105.0	.28	566.65
5.00	138.0	.56	705.57
6.00	192.0	1.11	930.26
7.00	242.0	1.67	1135.54
8.00	289.0	2.22	1325.88
9.00	333.0	2.78	1501.50
10.00	374.0	3.33	1662.61
11.00	412.0	3.89	1809.42
12.00	447.0	4.44	1942.15
13.00	481.0	5.00	2069.15
14.00	510.0	5.56	2174.32
15.00	538.0	6.11	2274.08
16.00	565.0	6.67	2368.52
17.00	590.0	7.22	2453.73
18.00	611.0	7.78	2521.95
19.00	634.0	8.33	2597.03
20.00	655.0	8.89	2663.21
22.00	692.0	10.00	2773.30
24.00	724.0	11.11	2860.85
26.00	751.0	12.22	2926.56
28.00	768.0	13.33	2952.59
30.00	780.0	14.44	2958.69
32.00	786.0	15.56	2941.96
34.00	789.5	16.67	2915.74
35.00	793.0	17.22	2908.70
36.00	796.0	17.78	2899.74



B-193, ST-1B NO STRENGTH TEST DUE TO DRILL WASH

U. W. STOLL AND ASSOCIATES
soil mechanics and foundation consultants

JOB NAME: HOPPER INVESTIGATION, BELLE RIVER
JOB LOCATION: BELLE RIVER, MICHIGAN
CLIENT: BECHTEL POWER CORPORATION

BY: IKK
SUBJECT:

DATE: 8/75

SAMPLE IDENTIFICATION:		B-193, ST-19, D-98	
DIAL GAGE	LOAD GAGE	STRAIN %	STRESS (PSF)
.00	.0	.00	118.02
1.00	23.0	.66	214.53
2.00	49.0	1.32	322.35
3.00	68.0	1.97	399.51
4.00	85.0	2.63	467.31
5.00	98.0	3.29	517.68
6.00	112.0	3.95	571.41
7.00	124.0	4.61	616.24
8.00	136.0	5.26	660.40
9.00	147.0	5.92	699.87
10.00	158.0	6.58	738.73
11.00	169.0	7.24	776.98
12.00	179.0	7.89	810.68
13.00	188.0	8.55	839.94
14.00	198.0	9.21	872.55
15.00	207.0	9.87	900.77
16.00	215.0	10.53	924.67
17.00	224.0	11.18	951.90
18.00	233.0	11.84	978.64
19.00	241.0	12.50	1001.14
20.00	250.0	13.16	1026.89
21.00	257.0	13.82	1044.80
22.00	265.0	14.47	1065.95
23.00	272.0	15.13	1083.05
24.00	279.0	15.79	1099.75
25.00	285.0	16.45	1112.51
26.00	292.0	17.11	1128.45
27.00	297.0	17.76	1137.00
28.00	302.0	18.42	1145.27
29.00	307.0	19.08	1153.27
30.00	311.5	19.74	1159.27
30.40	316.0	20.00	1170.80

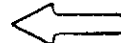

B-193, ST-20 No STRENGTH TEST DUE TO DRILL WASH
(W_m = 31.1%)

U. W. STOLL AND ASSOCIATES
soil mechanics and foundation consultants

JOB NAME: HOPPER INVESTIGATION, BELLE RIVER
JOB LOCATION: BELLE RIVER, MICHIGAN
CLIENT: BECHTEL POWER CORPORATION

BY: IKK
SUBJECT:

DATE: 8/75

SAMPLE IDENTIFICATION:		B-193, ST-21, D-112	
DIAL GAGE	LOAD GAGE	STRAIN %	STRESS (PSF)
.00	.0	.00	117.05
1.00	10.0	.65	158.23
2.00	28.0	1.31	232.21
3.00	45.0	1.96	301.05
4.00	58.0	2.62	352.50
5.00	70.0	3.27	399.15
6.00	80.0	3.92	437.02
7.00	90.0	4.58	474.34
8.00	98.0	5.23	503.10
9.00	105.0	5.89	527.45
10.00	112.0	6.54	551.41
11.00	119.0	7.19	574.98
12.00	126.0	7.85	598.17
13.00	132.0	8.50	617.11
14.00	138.0	9.16	635.71
15.00	144.0	9.81	653.99
16.00	148.0	10.46	664.37
17.00	153.0	11.12	678.28
18.00	158.0	11.77	691.92
19.00	163.0	12.43	705.28
20.00	168.0	13.08	718.37
21.00	172.0	13.73	727.53
22.00	177.0	14.39	740.09
23.00	180.0	15.04	745.20
24.00	185.0	15.70	757.26
25.00	188.0	16.35	761.99
26.00	192.0	17.00	770.05
27.00	195.0	17.66	774.41
28.00	198.0	18.31	778.61
29.00	202.0	18.97	786.06
30.00	205.0	19.62	789.90
31.00	210.0	20.27	800.31
32.00	212.0	20.93	800.42
30.60	208.0	20.01	796.18



B-193 ST-22 } NO TEST DUE TO DRILL WASH
B-193 ST-23 }

U. W. STOLL AND ASSOCIATES
soil mechanics and foundation consultants

JOB NAME: HOPPER INVESTIGATION, BELLE RIVER
JOB LOCATION: BELLE RIVER, MICHIGAN
CLIENT: BECHTEL POWER CORPORATION

BY: IKK
SUBJECT:

DATE: 8/75

SAMPLE IDENTIFICATION:		B-192, ST-1, D-20	
DIAL GAGE	LOAD GAGE	STRAIN %	STRESS (PSF)
.00	.0	.00	117.05
.40	11.5	.26	165.17
.80	20.0	.52	200.45
1.20	28.0	.79	233.44
1.60	35.0	1.05	262.07
2.00	42.0	1.31	290.55
2.40	50.0	1.57	323.03
2.80	57.0	1.83	351.18
3.20	65.0	2.10	383.32
3.60	73.0	2.36	415.28
4.00	81.0	2.62	447.07
4.40	90.0	2.88	482.77
4.80	99.0	3.14	518.28
5.20	108.0	3.41	553.59
5.60	118.0	3.67	592.77
6.80	147.0	4.45	704.94
7.20	157.0	4.72	743.24
7.60	166.0	4.98	777.31
8.00	174.0	5.24	807.18
8.40	181.0	5.50	832.88
8.80	187.0	5.76	854.45
9.20	192.0	6.02	871.92
9.60	197.0	6.29	889.27
10.00	200.0	6.55	898.63
10.40	203.0	6.81	907.91
10.80	206.0	7.07	917.13
11.20	208.0	7.33	922.38
11.60	209.0	7.60	923.67
12.00	210.0	7.86	924.94

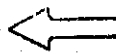

SAMPLE IDENTIFICATION:		B-192, ST-2, D-25	
DIAL GAGE	LOAD GAGE	STRAIN %	STRESS (PSF)
.00	.0	.00	118.67
.50	27.0	.33	233.50
1.00	51.0	.66	334.80
1.50	78.0	.99	448.15
2.00	105.0	1.32	560.73
2.50	135.0	1.65	685.17
3.00	165.0	1.98	808.78
3.50	192.0	2.31	918.98
4.00	213.0	2.64	1003.41
4.50	229.0	2.97	1066.48
5.00	242.0	3.30	1116.67
5.50	250.0	3.63	1145.87
6.00	255.0	3.96	1162.51
6.50	256.0	4.29	1162.61
7.00	251.0	4.62	1138.18

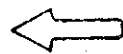

U. W. STOLL AND ASSOCIATES
soil mechanics and foundation consultants

JOB NAME: HOPPER INVESTIGATION, BELLE RIVER
JOB LOCATION: BELLE RIVER, MICHIGAN
CLIENT: BECHTEL POWER CORPORATION

BY: IKK
SUBJECT:

DATE: 8/75

SAMPLE IDENTIFICATION:		B-192, ST-3, D-30	
DIAL GAGE	LOAD GAGE	STRAIN %	STRESS (PSF)
.00	.0	.00	118.35
.50	45.0	.32	309.47
1.00	83.0	.65	469.65
1.50	118.0	.97	616.10
2.00	157.0	1.30	778.43
2.50	193.0	1.62	927.07
3.00	222.0	1.95	1045.42
3.50	241.0	2.27	1121.23
4.00	250.0	2.60	1154.93
4.30	251.0	2.79	1156.77
4.50	250.0	2.92	1151.08
5.00	247.0	3.25	1134.84

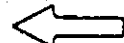

SAMPLE IDENTIFICATION:		B-192, ST-4, D-35	
DIAL GAGE	LOAD GAGE	STRAIN %	STRESS (PSF)
.00	.0	.00	117.69
1.00	136.0	.65	690.61
2.00	275.0	1.31	1268.54
2.80	315.0	1.83	1428.53
4.00	254.0	2.62	1164.87



SAMPLE IDENTIFICATION:		B-192, ST-5, D-40	
DIAL GAGE	LOAD GAGE	STRAIN %	STRESS (PSF)
.00	.0	.00	118.02
.50	86.0	.33	482.60
1.00	147.0	.66	739.02
1.50	205.0	.99	981.08
2.00	263.0	1.32	1221.51
2.50	313.0	1.65	1426.81
3.00	354.0	1.98	1593.15
3.50	377.0	2.31	1683.47
3.70	379.5	2.44	1691.58
4.10	372.0	2.70	1655.94
4.50	336.0	2.97	1502.71
5.00	310.0	3.30	1390.55



SAMPLE IDENTIFICATION:		B-192, ST-6, D-45	
DIAL GAGE	LOAD GAGE	STRAIN %	STRESS (PSF)
.00	.0	.00	118.35
.50	111.0	.33	590.33
1.00	194.0	.66	940.43
1.50	249.0	.99	1169.84
2.00	272.0	1.31	1262.87
2.15	272.0	1.41	1261.61
2.50	266.0	1.64	1233.47
3.00	254.0	1.97	1179.12
3.50	247.0	2.30	1145.97

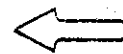

U. W. STOLL AND ASSOCIATES
soil mechanics and foundation consultants

JOB NAME: HOPPER INVESTIGATION, BELLE RIVER
JOB LOCATION: BELLE RIVER, MICHIGAN
CLIENT: BECHTEL POWER CORPORATION

BY: IKK
SUBJECT:

DATE: 8/75

SAMPLE IDENTIFICATION;		B-192, ST-7, D-52	
DIAL GAGE	LOAD GAGE	STRAIN %	STRESS (PSF)
.00	.0	.00	118.35
1.00	100.0	.71	541.43
2.00	170.0	1.42	832.16
3.00	224.0	2.14	1051.79
4.00	262.0	2.85	1201.77
5.00	285.0	3.56	1287.67
6.00	293.0	4.27	1310.87
7.00	270.0	4.98	1207.81

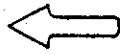

U. W. STOLL AND ASSOCIATES
soil mechanics and foundation consultants

JOB NAME: HOPPER INVESTIGATION, BELLE RIVER
 JOB LOCATION: BELLE RIVER, MICHIGAN
 CLIENT: BECHTEL POWER CORPORATION

BY: IKK DATE: 8/75
 SUBJECT: STRESS-STRAIN RELATIONS

SAMPLE IDENTIFICATION;		B-192, ST-8, D-55	
DIAL GAGE	LOAD GAGE	STRAIN %	STRESS (PSF)
.00	.0	.00	117.69
1.00	103.0	.62	551.62
2.00	165.0	1.23	808.20
3.00	132.0	1.85	665.62
4.00	195.0	2.47	922.33
5.00	247.0	3.09	1130.48
6.00	282.0	3.70	1266.39
7.00	305.0	4.32	1351.71
8.00	322.0	4.94	1411.61
9.00	334.0	5.56	1450.56
11.00	352.0	6.79	1502.84
12.00	358.0	7.41	1516.48
13.00	363.0	8.02	1525.90
14.00	367.5	8.64	1533.11
15.00	370.0	9.26	1532.38
16.00	373.5	9.88	1535.35
18.00	379.0	11.11	1535.08
19.00	381.0	11.73	1531.92
20.00	382.0	12.35	1524.93
21.00	383.0	12.96	1517.88
22.00	384.0	13.58	1510.79
23.00	384.0	14.20	1500.00
24.00	383.5	14.81	1487.40
25.00	381.0	15.43	1467.64

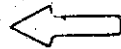

SAMPLE IDENTIFICATION;		B-192, ST-9, D-60	
DIAL GAGE	LOAD GAGE	STRAIN %	STRESS (PSF)
.00	.0	.00	117.69
1.00	70.0	.63	412.31
2.00	130.0	1.26	661.26
3.00	185.0	1.89	886.18
4.00	235.0	2.52	1087.46
5.00	280.0	3.14	1265.51
6.00	317.0	3.77	1408.47
7.00	347.0	4.40	1521.04
8.00	371.0	5.03	1607.81
9.00	389.0	5.66	1669.27
10.00	404.0	6.29	1717.83
11.00	417.0	6.92	1757.68
12.00	429.0	7.55	1792.91
13.00	439.0	8.18	1819.70
14.00	447.0	8.81	1838.22
16.00	463.0	10.06	1873.96
17.00	471.0	10.69	1891.20
18.00	476.0	11.32	1896.70
19.00	482.0	11.95	1905.68
20.00	488.0	12.58	1914.34
21.00	493.0	13.21	1919.00
D-28 22.00	497.0	13.84	1919.73

U. W. STOLL AND ASSOCIATES
soil mechanics and foundation consultants

JOB NAME: HOPPER INVESTIGATION, BELLE RIVER
JOB LOCATION: BELLE RIVER, MICHIGAN
CLIENT: BECHTEL POWER CORPORATION

BY: IKK DATE: 8/75
SUBJECT: STRESS-STRAIN RELATIONS

DIAL GAGE	LOAD GAGE	STRAIN %	STRESS (PSF)
24.00	505.0	15.09	1920.54
25.00	509.0	15.72	1920.63
26.00	512.0	16.35	1916.95
27.00	516.0	16.98	1916.64
28.00	519.0	17.61	1912.62
29.00	523.0	18.24	1911.90
30.00	525.0	18.87	1904.09
31.80	530.5	20.00	1896.20

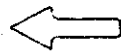

SAMPLE IDENTIFICATION:

B-192, ST-10, D-70

DIAL GAGE	LOAD GAGE	STRAIN %	STRESS (PSF)
.00	.0	.00	118.35
.25	30.0	.16	246.05
.50	60.0	.31	373.36
.75	90.0	.47	500.27
1.00	117.0	.62	614.05
1.50	164.0	.93	810.94
2.00	209.0	1.24	998.14
2.50	252.0	1.55	1175.75
3.00	295.0	1.86	1352.21
3.50	336.0	2.17	1519.18
4.00	377.0	2.48	1685.06
4.50	417.0	2.80	1845.71
5.00	450.0	3.11	1976.33
5.50	482.0	3.42	2101.96
6.00	512.0	3.73	2218.52
6.50	537.0	4.04	2313.79
7.00	560.0	4.35	2400.23
7.50	582.0	4.66	2482.00
8.00	603.0	4.97	2559.12
9.00	639.0	5.59	2687.51
10.00	672.0	6.21	2801.97
11.00	702.0	6.83	2902.75
12.00	727.0	7.45	2982.19
13.00	751.0	8.07	3056.37
14.00	773.0	8.70	3121.48
15.00	792.0	9.32	3173.81
16.00	810.0	9.94	3221.29
17.00	827.0	10.56	3263.99
18.00	844.0	11.18	3305.79
19.00	859.0	11.80	3339.16
20.00	874.0	12.42	3371.74
22.00	900.0	13.66	3419.75
24.00	926.0	14.91	3465.01
26.00	949.0	16.15	3496.77
28.00	971.0	17.39	3522.56
30.00	992.0	18.63	3542.54
32.20	1014.0	20.00	3558.20
34.00	1037.0	21.12	3585.93

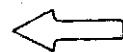

U. W. STOLL AND ASSOCIATES
soil mechanics and foundation consultants

JOB NAME: HOPPER INVESTIGATION, BELLE RIVER
JOB LOCATION: BELLE RIVER, MICHIGAN
CLIENT: BECHTEL POWER CORPORATION

BY: IKK DATE: 8/75
SUBJECT: STRESS-STRAIN RELATIONS

SAMPLE IDENTIFICATION;		B-192, ST-11, D-80	
DIAL GAGE	LOAD GAGE	STRAIN %	STRESS (PSF)
.00	.0	.00	117.69
.25	42.0	.16	295.57
.50	92.0	.31	506.76
.75	137.0	.47	696.15
1.00	177.0	.62	863.86
1.25	216.0	.78	1026.83
1.50	253.0	.93	1180.87
1.75	288.0	1.09	1326.02
2.00	324.0	1.24	1474.90
2.25	360.0	1.40	1623.31
2.50	395.0	1.55	1767.07
3.00	460.0	1.86	2032.36
3.50	522.0	2.17	2283.48
4.00	578.0	2.48	2508.12
4.50	622.0	2.79	2681.75
5.00	664.0	3.10	2846.00
5.50	696.0	3.41	2968.13
6.00	726.0	3.72	3081.24
6.50	752.0	4.03	3177.26
7.00	774.0	4.34	3256.35
7.50	795.0	4.65	3330.81
8.00	810.0	4.96	3380.51
8.50	826.0	5.27	3433.83
9.00	838.0	5.58	3470.69
9.50	848.0	5.89	3499.25
10.00	856.0	6.20	3519.58
11.00	864.5	6.82	3529.93
11.50	850.0	7.13	3461.00
12.00	820.0	7.44	3331.54
12.50	795.0	7.75	3222.46



U. W. STOLL AND ASSOCIATES
soil mechanics and foundation consultants

JOB NAME: HOPPER INVESTIGATION, BELLE RIVER
JOB LOCATION: BELLE RIVER, MICHIGAN
CLIENT: BECHTEL POWER CORPORATION

BY: IKK
SUBJECT: PARTICLE SIZE DISTRIBUTION ANALYSIS SUMMARY
DATE: 9/75

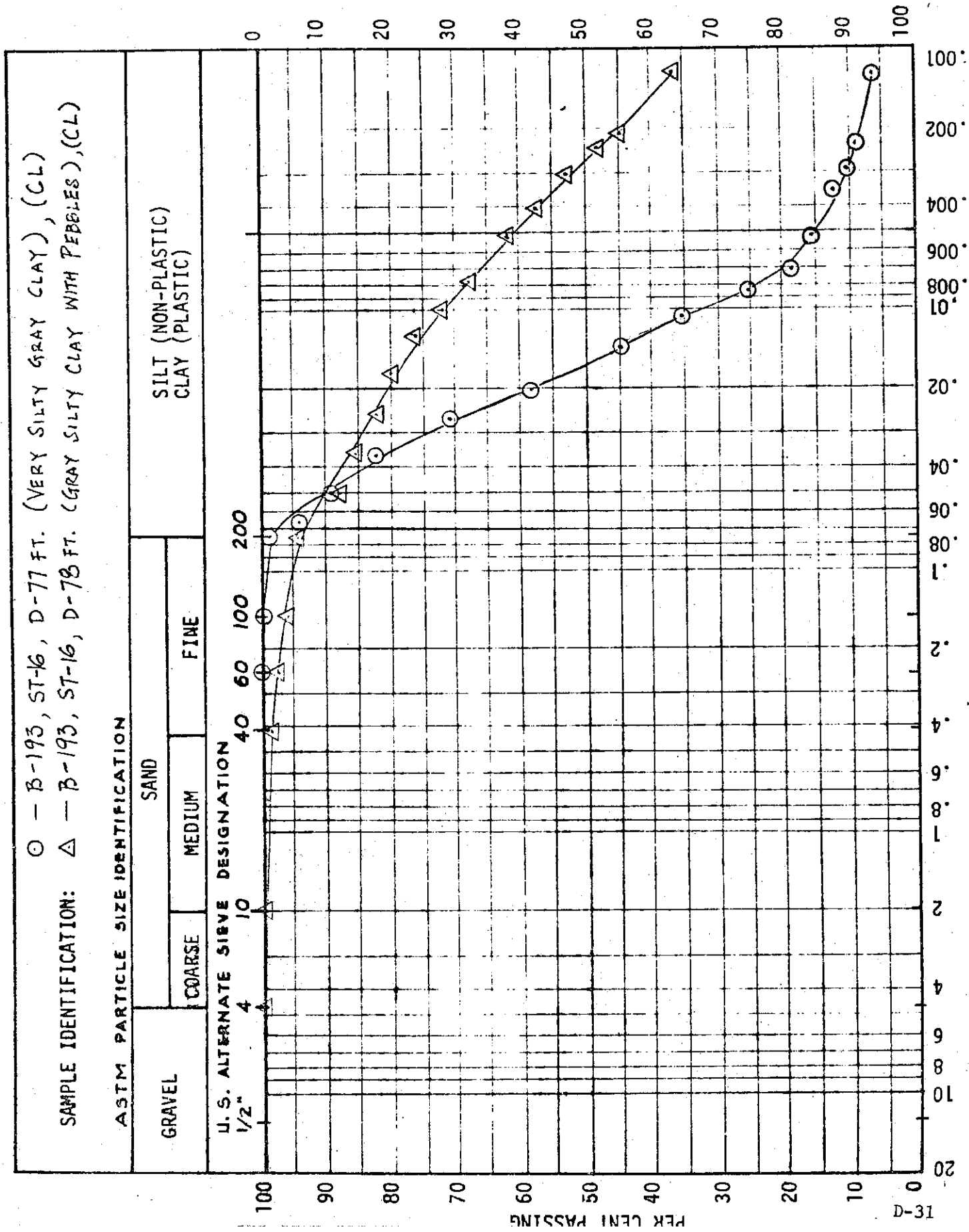

U. W. STOLL AND ASSOCIATES
soil mechanics and foundation consultants

JOB NAME: HOPPER INVESTIGATION, BELLE RIVER
 JOB LOCATION: BELLE RIVER, MICHIGAN
 CLIENT: BECHTEL POWER CORPORATION

BY: IKK

DATE: 9/75

SUBJECT: PARTICLE SIZE DISTRIBUTION ANALYSIS SUMMARY

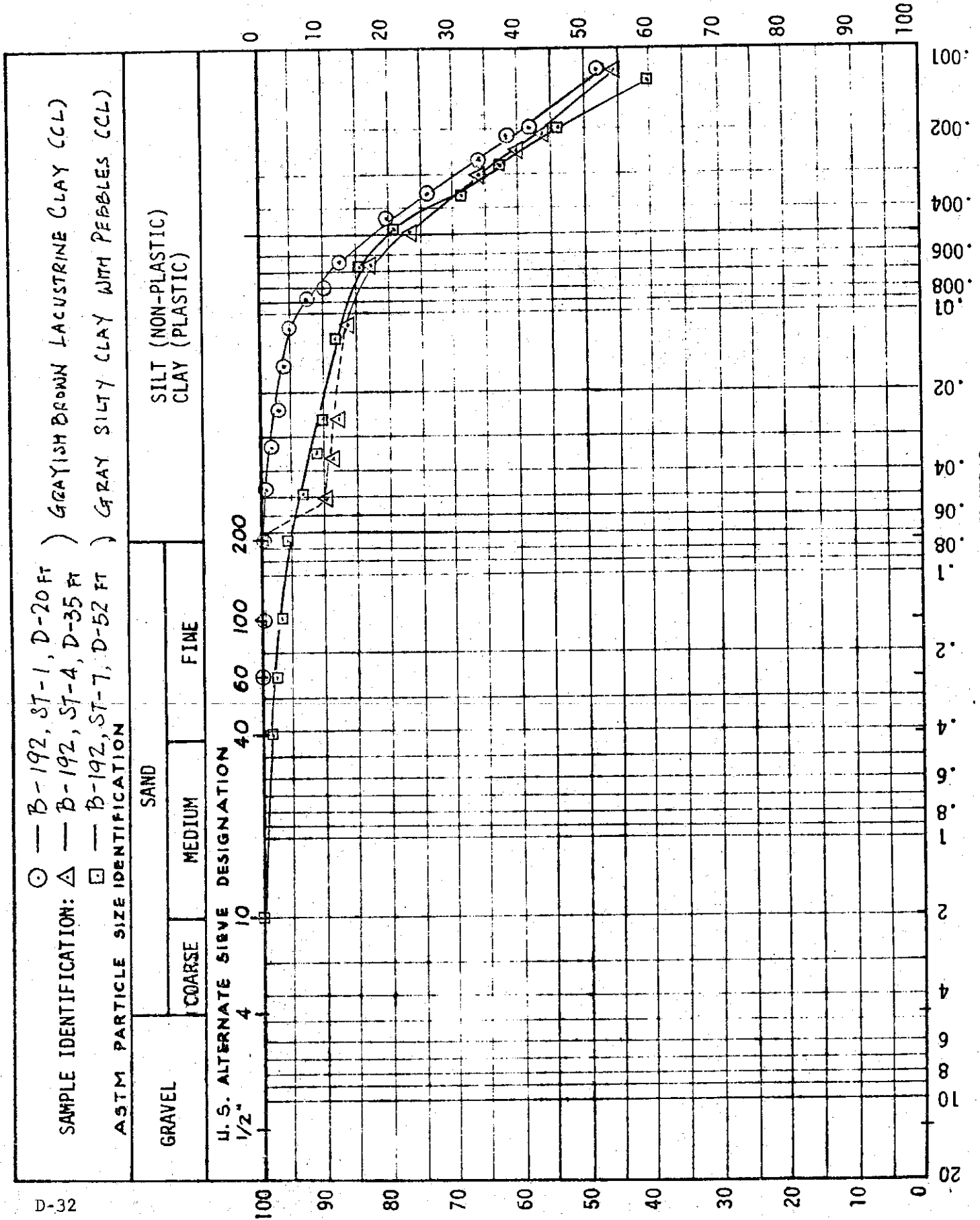

**APPENDIX G – 2016 LABORATORY TEST
RESULTS**

TRC Environmental Corporation													QC:	JPH				
Falling Head, Rising Tailwater Permeability Test (ASTM D5084, Method C)													QA:	JPH				
Project Name: DTE - BRPP BAB and DB						Cell #:						8						
Project #: 231828.0003.0000						USCS Description:						N/A						
Sample Name: MW-16-01, 50-52'						USCS Classification:						N/A						
Visual Descript: Gray lean clay						Average Kv =						2.9E-08 cm/s						
Sample Type: Undisturbed		Initial Values		Final Values														
Sample Dia. (in)		2.87		2.87		Permeant: Water												
Sample Ht. (in)		3.02		3.02		Permeant Specific Gravity: 1.00												
Tare & Wet (g)		775.10		649.20		Sample Specific Gravity: 2.70 Est.												
Tare & Dry (g)		562.60		471.50		Confining Pressure (psi): 100.0												
Tare (g)		88.86		88.64		Burette Diameter (in): 0.250												
Sample Wt. (g)		563.65		560.56		Burette Zero (cm): 100.0												
Moisture (%)		44.9		46.4		Maximum Gradient: 7.0												
Wet Density (pcf)		109.9		109.5		Average Gradient: 6.5												
Dry Density (pcf)		75.9		74.8		Max. Effect. Stress (psi): 5.7												
Saturation (%)		99.2		100.0		Min. Effect. Stress (psi): 4.3												
						Ave. Effect. Stress (psi): 4.8												
Yr.	Mo.	Day	Hr.	Min.	Run Time (s)	Temp C***	Pressure (psi) Bot	Pressure (psi) Top	Cham (cm)	Cham. Dif.(cm)	Bot (cm)	Bot. Dif.(cm)	Top (cm)	Top Dif.(cm)	Flow Dif.(%)	Kv *** cm/s	Ave.* 0.1	
1	2016	3	15	8	10.00	0.0	95	95	55.40		3.45		102.60					
2	2016	3	15	11	15.00	11100	23.0	95	95	56.10	0.70	4.05	0.60	101.30	1.30	-36.8	4.7E-08	
3	2016	3	15	14	16.00	10860	23.0	95	95	57.00	0.90	4.75	0.70	100.60	0.70	0.0	3.6E-08	
4	2016	3	15	18	15.00	14340	23.0	95	95	57.75	0.75	5.55	0.80	99.75	0.85	-3.0	3.3E-08	
5	2016	3	16	4	55.00	38400	22.0	95	95	59.30	1.55	7.65	2.10	97.50	2.25	-3.4	3.4E-08	
6	2016	3	16	8	38.00	13380	23.0	95	95	59.80	0.50	8.35	0.70	96.80	0.70	0.0	3.2E-08	
7	2016	3	16	11	56.00	11880	23.0	95	95	60.35	0.55	9.05	0.70	96.30	0.50	16.7	3.1E-08	
8	2016	3	16	15	1.00	11100	23.0	95	95	60.40	0.05	9.60	0.55	95.70	0.60	-4.3	3.2E-08	
9	2016	3	17	5	14.00	51180	22.0	95	95	61.30	0.90	12.10	2.50	93.20	2.50	0.0	3.2E-08	
10	2016	3	17	8	17.00	10980	24.0	95	95	62.05	0.75	12.65	0.55	92.75	0.45	10.0	3.0E-08	
11	2016	3	17	12	19.00	14520	23.0	95	95	62.15	0.10	13.25	0.60	92.05	0.70	-7.7	3.0E-08	
12	2016	3	17	17	49.00	19800	23.0	95	95	62.60	0.45	14.15	0.90	91.30	0.75	9.1	2.9E-08	
13	2016	3	18	5	23.00	41640	22.0	95	95	63.15	0.55	16.00	1.85	89.40	1.90	-1.3	3.3E-08	
14	2016	3	18	8	58.00	12900	24.0	95	95	63.60	0.45	16.55	0.55	88.90	0.50	4.8	3.0E-08	
15	2016	3	18	12	55.00	14220	23.0	95	95	63.80	0.20	17.10	0.55	88.30	0.60	-4.3	3.0E-08	
16	2016	3	18	16	30.00	12900	23.0	95	95	64.10	0.30	17.65	0.55	87.90	0.40	15.8	2.8E-08	
17	2016	3	21	4	58.00	217680	22.0	95	95	67.20	3.10	25.35	7.70	80.20	7.70	0.0	3.1E-08	
18	2016	3	21	8	1.00	10980	24.0	95	95	67.60	0.40	25.70	0.35	79.85	0.35	0.0	3.1E-08	
19	2016	3	21	12	10.00	14940	23.0	95	95	67.60	0.00	26.15	0.45	79.40	0.45	0.0	3.0E-08	
20	2016	3	21	15	12.00	10920	23.0	95	95	67.70	0.10	26.40	0.25	79.15	0.25	0.0	2.3E-08	1
21	2016	3	21	19	36.00	15840	23.0	95	95	68.30	0.60	26.90	0.50	78.70	0.45	5.3	3.1E-08	1
22	2016	3	21	21	31.00	6900	23.0	95	95	68.10	-0.20	27.10	0.20	78.50	0.20	0.0	3.0E-08	1
23	2016	3	22	5	52.00	30060	25.0	95	95	68.90	0.80	28.05	0.95	77.65	0.85	5.6	3.1E-08	1
24	2016	3	22	10	31.00	16740	23.0	95	95	68.85	-0.05	28.45	0.40	77.20	0.45	-5.9	2.8E-08	1
25	2016	3	22	15	59.00	19680	24.0	95	95	69.40	0.55	29.00	0.55	76.70	0.50	4.8	2.9E-08	1
26	2016	3	22	22	32.00	23580	24.0	95	95	69.80	0.40	29.55	0.55	76.10	0.60	-4.3	2.7E-08	1
**A zero in this column starts a series of measurements.													*Average Kv for those rows with a 1 in the Ave. column.			2.9E-08 cm/s		
(Termination determined by stable Kv and low flow differential.)													***Kv adjusted for temperature.					

TRC Environmental Corporation												QC:	JPH				
Falling Head, Rising Tailwater Permeability Test (ASTM D5084, Method C)												QA:	JPH				
Project Name: DTE - BRPP BAB and DB						Cell #:						9					
Project #: 231828.0003.0000						USCS Description:						N/A					
Sample Name: MW-16-05, 50-52'						USCS Classification:						N/A					
Visual Descript: Gray lean clay						Average Kv =						2.7E-08 cm/s					
Sample Type: Undisturbed		Initial Values		Final Values													
Sample Dia. (in)		2.87		2.84		Permeant:						Water					
Sample Ht. (in)		3.25		3.20		Permeant Specific Gravity:						1.00					
Tare & Wet (g)		536.11		691.40		Sample Specific Gravity:						2.70 Est.					
Tare & Dry (g)		403.90		517.10		Confining Pressure (psi):						100.0					
Tare (g)		93.83		91.24		Burette Diameter (in):						0.250					
Sample Wt. (g)		610.40		600.16		Burette Zero (cm):						100.0					
Moisture (%)		42.6		40.9		Maximum Gradient:						7.3					
Wet Density (pcf)		110.6		112.8		Average Gradient:						6.9					
Dry Density (pcf)		77.5		80.0		Max. Effect. Stress (psi):						6.1					
Saturation (%)		98.2		100.0		Min. Effect. Stress (psi):						4.6					
						Ave. Effect. Stress (psi):						5.1					
Yr.	Mo.	Day	Hr.	Min.	Run Time (s)	Temp C***	Pressure (psi) Bot	Pressure (psi) Top	Cham (cm)	Cham. Dif.(cm)	Bot (cm)	Bot. Dif.(cm)	Top (cm)	Top Dif.(cm)	Flow Dif.(%)	Kv *** cm/s	Ave.* 0.1
1	2016	3	15	8	11.00	0.0	95	95	25.20		1.95		101.75				
2	2016	3	15	11	15.00	0.0	95	95	27.70		1.80		99.60				
3	2016	3	15	14	17.00	10920	23.0	95	95	29.40	1.70	2.00	0.20	98.65	0.95	-65.2	3.2E-08
4	2016	3	15	18	16.00	14340	23.0	95	95	30.65	1.25	2.40	0.40	97.60	1.05	-44.8	3.1E-08
5	2016	3	16	4	56.00	38400	22.0	95	95	32.20	1.55	3.85	1.45	95.40	2.20	-20.5	3.1E-08
6	2016	3	16	8	39.00	13380	23.0	95	95	32.40	0.20	4.40	0.55	94.85	0.55	0.0	2.6E-08
7	2016	3	16	11	57.00	11880	23.0	95	95	33.85	1.45	4.95	0.55	94.40	0.45	10.0	2.7E-08
8	2016	3	16	15	2.00	11100	23.0	95	95	34.00	0.15	5.35	0.40	93.90	0.50	-11.1	2.7E-08
9	2016	3	17	5	15.00	51180	22.0	95	95	35.20	1.20	7.35	2.00	91.80	2.10	-2.4	2.8E-08
10	2016	3	17	8	17.00	10920	24.0	95	95	35.80	0.60	7.80	0.45	91.45	0.35	12.5	2.5E-08
11	2016	3	17	12	20.00	14580	23.0	95	95	35.90	0.10	8.30	0.50	89.85	1.60	-52.4	5.1E-08
12	2016	3	17	17	50.00	19800	23.0	95	95	36.40	0.50	9.10	0.80	89.25	0.60	14.3	2.6E-08
13	2016	3	18	5	23.00	41580	22.0	95	95	37.00	0.60	10.65	1.55	88.60	0.65	40.9	2.0E-08
14	2016	3	18	8	58.00	12900	24.0	95	95	37.50	0.50	11.15	0.50	88.15	0.45	5.3	2.7E-08
15	2016	3	18	12	55.00	14220	23.0	95	95	37.70	0.20	11.65	0.50	87.60	0.55	-4.8	2.8E-08
16	2016	3	18	16	31.00	12960	23.0	95	95	38.00	0.30	12.10	0.45	87.20	0.40	5.9	2.5E-08
17	2016	3	21	4	59.00	217680	22.0	95	95	41.00	3.00	19.25	7.15	79.85	7.35	-1.4	3.0E-08
18	2016	3	21	8	2.00	10980	24.0	95	95	41.40	0.40	19.55	0.30	79.60	0.25	9.1	2.4E-08
19	2016	3	21	12	10.00	14880	23.0	95	95	41.40	0.00	19.95	0.40	79.15	0.45	-5.9	2.8E-08
20	2016	3	21	15	13.00	10980	23.0	95	95	41.60	0.20	20.25	0.30	78.85	0.30	0.0	2.7E-08
21	2016	3	21	19	37.00	15840	23.0	95	95	42.00	0.40	20.80	0.55	78.55	0.30	29.4	2.7E-08
22	2016	3	21	21	32.00	6900	23.0	95	95	41.80	-0.20	20.90	0.10	78.30	0.25	-42.9	2.6E-08
23	2016	3	22	5	53.00	30060	25.0	95	95	42.75	0.95	21.75	0.85	77.55	0.75	6.3	2.6E-08
24	2016	3	22	10	32.00	16740	23.0	95	95	42.75	0.00	22.20	0.45	77.10	0.45	0.0	2.8E-08
25	2016	3	22	16	0.00	19680	24.0	95	95	43.25	0.50	22.75	0.55	76.65	0.45	10.0	2.7E-08
26	2016	3	22	22	33.00	23580	24.0	95	95	43.60	0.35	23.35	0.60	76.10	0.55	4.3	2.6E-08
**A zero in this column starts a series of measurements.												*Average Kv for those rows with a 1 in the Ave. column.				2.7E-08 cm/s	
(Termination determined by stable Kv and low flow differential.)												***Kv adjusted for temperature.					

TRC Environmental Corporation													QC:	JPH				
Falling Head, Rising Tailwater Permeability Test (ASTM D5084, Method C)													QA:	JPH				
Project Name: DTE - BRPP BAB and DB						Cell #:						9						
Project #: 231828.0003.0000						USCS Description:						N/A						
Sample Name: MW-16-07, 50-52'						USCS Classification:						N/A						
Visual Descript: Gray sandy lean clay, with gravel						Average Kv =						2.9E-08 cm/s						
Sample Type: Undisturbed		Initial Values		Final Values														
Sample Dia. (in)		2.86		2.83		Permeant: Water												
Sample Ht. (in)		3.50		3.48		Permeant Specific Gravity: 1.00												
Tare & Wet (g)		512.00		737.80		Sample Specific Gravity: 2.68 Est.												
Tare & Dry (g)		387.40		552.10		Confining Pressure (psi): 100.0												
Tare (g)		92.18		89.22		Burette Diameter (in): 0.250												
Sample Wt. (g)		666.40		648.58		Burette Zero (cm): 100.0												
Moisture (%)		42.2		40.1														
Wet Density (pcf)		112.9		112.9														
Dry Density (pcf)		79.4		80.6		Max. Effect. Stress (psi): 6.2												
Saturation (%)		102.4		100.0		Min. Effect. Stress (psi): 4.5												
						Ave. Effect. Stress (psi): 5.0												
Yr.	Mo.	Day	Hr.	Min.	Run Time (s)	Temp C***	Pressure (psi)		Cham (cm)	Cham. Dif.(cm)	Bot (cm)	Bot. Dif.(cm)	Top (cm)	Top Dif.(cm)	Flow Dif.(%)	Kv *** cm/s	Ave.* 0.1	
1	2016	4	21	11	16.00	0.0	95	95	16.80		2.50		102.25					
2	2016	4	21	20	32.00	33360	27.0	95	95	27.60	10.80	1.25	-1.25	96.40	5.85	-154.3	4.1E-08	
3	2016	4	22	9	22.00	46200	24.0	95	95	32.50	4.90	2.40	1.15	93.40	3.00	-44.6	3.0E-08	
4	2016	4	22	12	18.00	10560	24.0	95	95	33.50	1.00	2.85	0.45	92.90	0.50	-5.3	3.1E-08	
5	2016	4	22	18	33.00	22500	25.0	95	95	35.05	1.55	3.80	0.95	91.95	0.95	0.0	2.9E-08	
6	2016	4	25	11	30.00	233820	23.0	95	95	44.30	9.25	12.75	8.95	83.10	8.85	0.6	3.1E-08	
7	2016	4	25	17	41.00	22260	24.0	95	95	45.35	1.05	13.50	0.75	82.40	0.70	3.4	2.9E-08	
8	2016	4	25	20	39.00	10680	24.0	95	95	45.30	-0.05	13.80	0.30	82.00	0.40	-14.3	3.0E-08	
9	2016	4	25	23	15.00	9360	24.0	95	95	45.35	0.05	14.10	0.30	81.70	0.30	0.0	3.0E-08	
10	2016	4	26	4	59.00	20640	25.0	95	95	46.00	0.65	14.75	0.65	81.00	0.70	-3.7	3.0E-08	
11	2016	4	26	8	19.00	12000	24.0	95	95	45.95	-0.05	15.10	0.35	80.60	0.40	-6.7	3.0E-08	
12	2016	4	26	13	18.00	17940	24.0	95	95	46.40	0.45	15.70	0.60	80.10	0.50	9.1	3.0E-08	
13	2016	4	27	4	57.00	56340	23.0	95	95	47.60	1.20	17.40	1.70	78.60	1.50	6.2	2.9E-08	
14	2016	4	27	12	47.00	28200	23.0	95	95	47.95	0.35	18.20	0.80	77.90	0.70	6.7	2.8E-08	
15	2016	4	27	15	8.00	8460	23.0	95	95	47.90	-0.05	18.45	0.25	77.65	0.25	0.0	3.2E-08	
16	2016	4	28	5	1.00	49980	22.0	95	95	48.80	0.90	19.80	1.35	76.35	1.30	1.9	3.0E-08	
17	2016	4	28	8	5.00	11040	24.0	95	95	49.40	0.60	20.15	0.35	76.15	0.20	27.3	2.8E-08	
18	2016	4	28	14	56.00	24660	23.0	95	95	49.60	0.20	20.75	0.60	75.55	0.60	0.0	2.8E-08	
19	2016	4	28	20	48.00	21120	23.0	95	95	49.90	0.30	21.30	0.55	75.10	0.45	10.0	2.8E-08	
20	2016	4	29	5	31.00	31380	26.0	95	95	51.05	1.15	22.10	0.80	74.35	0.75	3.2	2.8E-08	
21	2016	4	29	10	27.00	17760	23.0	95	95	50.90	-0.15	22.50	0.40	73.90	0.45	-5.9	3.0E-08	
22	2016	4	29	14	41.00	15240	23.0	95	95	51.25	0.35	22.90	0.40	73.60	0.30	14.3	2.9E-08	
23	2016	4	29	18	0.00	11940	23.0	95	95	51.55	0.30	23.20	0.30	73.40	0.20	20.0	2.7E-08	
24	2016	5	1	16	23.00	166980	22.0	95	95	54.25	2.70	26.95	3.75	70.05	3.35	5.6	3.0E-08	
25	2016	5	2	4	58.00	45300	23.0	95	95	55.05	0.80	27.85	0.90	69.25	0.80	5.9	2.9E-08	
26	2016	5	2	8	4.00	11160	23.0	95	95	55.30	0.25	28.10	0.25	69.05	0.20	11.1	3.1E-08	
**A zero in this column starts a series of measurements.													*Average Kv for those rows with a 1 in the Ave. column.					
(Termination determined by stable Kv and low flow differential.)													***Kv adjusted for temperature.					

TRC Environmental Corporation												QC:	JPH					
Falling Head, Rising Tailwater Permeability Test (ASTM D5084, Method C)												QA:	JPH					
Project Name: DTE - BRPP BAB and DB						Cell #:						9						
Project #: 231828.0003.0000						USCS Description:						N/A						
Sample Name: MW-16-07, 50-52'						USCS Classification:						N/A						
Visual Descript: Gray sandy lean clay, with gravel																		
Sample Type: Undisturbed		Initial Values		Final Values														
Sample Dia. (in)		2.86		2.83		Permeant:						Water						
Sample Ht. (in)		3.50		3.48		Permeant Specific Gravity:						1.00						
Tare & Wet (g)		512.00		737.80		Sample Specific Gravity:						2.68 Est.						
Tare & Dry (g)		387.40		552.10		Confining Pressure (psi):						100.0						
Tare (g)		92.18		89.22		Burette Diameter (in):						0.250						
Sample Wt. (g)		666.40		648.58		Burette Zero (cm):						100.0						
Moisture (%)		42.2		40.1		Maximum Gradient:						3.8						
Wet Density (pcf)		112.9		112.9		Average Gradient:						3.6						
Dry Density (pcf)		79.4		80.6		Max. Effect. Stress (psi):						5.2						
Saturation (%)		102.4		100.0		Min. Effect. Stress (psi):						4.6						
						Ave. Effect. Stress (psi):						4.9						
Yr.	Mo.	Day	Hr.	Min.	Run Time (s)	Temp C***	Pressure (psi)		Cham (cm)	Cham. Dif.(cm)	Bot (cm)	Bot. Dif.(cm)	Top (cm)	Top Dif.(cm)	Flow Dif.(%)	Kv *** cm/s	Ave.* 0,1	
1	2016	5	2	8	4.00	0.0	95	95	55.30		28.10		69.05					
2	2016	5	2	13	15.00	18660	23.0	95	95	55.65	0.35	28.50	0.40	68.80	0.25	23.1	2.8E-08	
3	2016	5	2	20	45.00	27000	26.0	95	95	56.30	0.65	29.00	0.50	68.35	0.45	5.3	2.6E-08	
4	2016	5	3	4	50.00	29100	23.0	95	95	56.00	-0.30	29.50	0.50	67.75	0.60	-9.1	3.1E-08	
5	2016	5	3	8	0.00	11400	25.0	95	95	56.35	0.35	29.70	0.20	67.60	0.15	14.3	2.5E-08	
6	2016	5	3	11	10.00	11400	23.0	95	95	56.30	-0.05	29.90	0.20	67.35	0.25	-11.1	3.4E-08	
7	2016	5	3	14	12.00	10920	23.0	95	95	56.40	0.10	30.15	0.25	67.25	0.10	42.9	2.8E-08	
8	2016	5	3	19	36.00	19440	24.0	95	95	57.20	0.80	30.55	0.40	67.05	0.20	33.3	2.6E-08	
9	2016	5	4	5	24.00	35280	23.0	95	95	57.60	0.40	31.15	0.60	66.50	0.55	4.3	2.9E-08	
10	2016	5	4	9	48.00	15840	23.0	95	95	57.60	0.00	31.40	0.25	66.25	0.25	0.0	2.9E-08	
11	2016	5	4	14	50.00	18120	23.0	95	95	57.70	0.10	31.70	0.30	66.00	0.25	9.1	2.8E-08	
12	2016	5	4	20	0.00	18600	25.0	95	95	58.25	0.55	32.10	0.40	65.80	0.20	33.3	2.9E-08	
13	2016	5	5	5	24.00	33840	24.0	95	95	58.35	0.10	32.60	0.50	65.30	0.50	0.0	2.8E-08	1
14	2016	5	5	10	25.00	18060	24.0	95	95	58.60	0.25	32.90	0.30	65.10	0.20	20.0	2.7E-08	1
15	2016	5	5	14	42.00	15420	24.0	95	95	58.90	0.30	33.20	0.30	64.85	0.25	9.1	3.5E-08	1
16	2016	5	6	4	52.00	51000	23.0	95	95	59.50	0.60	34.00	0.80	64.25	0.60	14.3	2.8E-08	1
17	2016	5	6	9	32.00	16800	23.0	95	95	59.70	0.20	34.25	0.25	64.05	0.20	11.1	2.9E-08	1
18																		
19																		
20																		
21																		
22																		
23																		
24																		
25																		
26																		
**A zero in this column starts a series of measurements.												*Average Kv for those rows with a 1 in the Ave. column.				2.9E-08	cm/s	
(Termination determined by stable Kv and low flow differential.)												***Kv adjusted for temperature.						

TRC Environmental Corporation													QC:	JPH			
Falling Head, Rising Tailwater Permeability Test (ASTM D5084, Method C)													QA:	JPH			
Project Name: DTE - BRPP BAB and DB						Cell #:						10					
Project #: 231828.0003.0000						USCS Description:						N/A					
Sample Name: SB-16-01, 50-52'						USCS Classification:						N/A					
Visual Descript: Gray lean clay						Average Kv =						2.1E-08 cm/s					
Sample Type: Undisturbed		Initial Values		Final Values													
Sample Dia. (in)		2.87		2.82		Permeant: Water											
Sample Ht. (in)		2.88		2.86		Permeant Specific Gravity: 1.00											
Tare & Wet (g)		534.46		607.60		Sample Specific Gravity: 2.70 Est.											
Tare & Dry (g)		400.40		448.80		Confining Pressure (psi): 100.0											
Tare (g)		98.45		86.36		Burette Diameter (in): 0.250											
Sample Wt. (g)		532.36		521.24		Burette Zero (cm): 100.0											
Moisture (%)		44.4		43.8		Maximum Gradient: 8.9											
Wet Density (pcf)		109.0		111.0		Average Gradient: 8.4											
Dry Density (pcf)		75.5		77.2		Max. Effect. Stress (psi): 6.1											
Saturation (%)		97.4		100.0		Min. Effect. Stress (psi): 4.5											
						Ave. Effect. Stress (psi): 5.1											
Yr.	Mo.	Day	Hr.	Min.	Run Time (s)	Temp C***	Pressure (psi) Bot	Pressure (psi) Top	Cham (cm)	Cham. Dif.(cm)	Bot (cm)	Bot. Dif.(cm)	Top (cm)	Top Dif.(cm)	Flow Dif.(%)	Kv *** cm/s	Ave.* 0.1
1	2016	3	15	8	11.00	0.0	95	95	24.00		1.65		102.30				
2	2016	3	15	11	16.00	0.0	95	95	27.35		1.15		99.70				
3	2016	3	15	14	17.00	0.0	95	95	29.50		1.15		98.60				
4	2016	3	15	18	17.00	14400	23.0	95	95	30.90	1.40	1.35	0.20	97.50	1.10	-69.2	2.5E-08
5	2016	3	16	4	56.00	38340	22.0	95	95	34.75	3.85	2.00	0.65	95.00	2.50	-58.7	2.4E-08
6	2016	3	16	8	39.00	13380	23.0	95	95	35.00	0.25	2.50	0.50	94.55	0.45	5.3	2.0E-08
7	2016	3	16	11	58.00	11940	23.0	95	95	35.45	0.45	3.00	0.50	94.10	0.45	5.3	2.3E-08
8	2016	3	16	15	3.00	11100	23.0	95	95	35.80	0.35	3.35	0.35	93.60	0.50	-17.6	2.2E-08
9	2016	3	17	5	15.00	51120	22.0	95	95	38.75	2.95	4.55	1.20	91.10	2.50	-35.1	2.2E-08
10	2016	3	17	8	18.00	10980	24.0	95	95	38.25	-0.50	5.25	0.70	90.95	0.15	64.7	2.3E-08
11	2016	3	17	12	21.00	14580	23.0	95	95	38.60	0.35	5.65	0.40	90.35	0.60	-20.0	2.1E-08
12	2016	3	17	17	51.00	19800	23.0	95	95	38.50	-0.10	6.45	0.80	89.85	0.50	23.1	2.1E-08
13	2016	3	18	5	24.00	41580	22.0	95	95	40.80	2.30	7.40	0.95	87.95	1.90	-33.3	2.3E-08
14	2016	3	18	8	59.00	12900	24.0	95	95	40.40	-0.40	8.05	0.65	87.70	0.25	44.4	2.3E-08
15	2016	3	18	12	56.00	14220	23.0	95	95	40.70	0.30	8.40	0.35	87.25	0.45	-12.5	1.9E-08
16	2016	3	18	16	32.00	12960	23.0	95	95	40.70	0.00	8.95	0.55	86.90	0.35	22.2	2.4E-08
17	2016	3	21	4	59.00	217620	22.0	95	95	45.25	4.55	15.10	6.15	80.30	6.60	-3.5	2.2E-08
18	2016	3	21	8	2.00	10980	24.0	95	95	45.25	0.00	15.50	0.40	80.10	0.20	33.3	2.2E-08
19	2016	3	21	12	11.00	14940	23.0	95	95	45.40	0.15	15.90	0.40	79.65	0.45	-5.9	2.4E-08
20	2016	3	21	15	13.00	10920	23.0	95	95	45.70	0.30	16.10	0.20	79.35	0.30	-20.0	1.9E-08
21	2016	3	21	19	38.00	15900	23.0	95	95	45.70	0.00	16.65	0.55	79.10	0.25	37.5	2.1E-08
22	2016	3	21	21	33.00	6900	23.0	95	95	46.10	0.40	16.70	0.05	78.80	0.30	-71.4	2.2E-08
23	2016	3	22	5	53.00	30000	25.0	95	95	47.20	1.10	17.35	0.65	78.00	0.80	-10.3	2.0E-08
24	2016	3	22	10	32.00	16740	23.0	95	95	47.10	-0.10	17.80	0.45	77.60	0.40	5.9	2.2E-08
25	2016	3	22	16	0.00	19680	24.0	95	95	47.40	0.30	18.35	0.55	77.15	0.45	10.0	2.2E-08
26	2016	3	22	22	34.00	23640	24.0	95	95	47.10	-0.30	19.10	0.75	76.80	0.35	36.4	2.1E-08
**A zero in this column starts a series of measurements.													*Average Kv for those rows with a 1 in the Ave. column.		2.1E-08 cm/s		
(Termination determined by stable Kv and low flow differential.)													***Kv adjusted for temperature.				

**APPENDIX H – 2020 LABORATORY TEST
RESULTS**



Excel Geotechnical Testing, Inc.
"Excellence in Testing"

953 Forrest Street, Roswell, Georgia 30075
Tel: (770) 910 7537, www.excelgeotesting.com

Project Name: Belle River ALD Support
Project No: PN1017
Client Sample ID: B1-1 (3')
Lab Sample No: 20L186

ASTM C136, D422, D854, D1140, D2216, D2487, D2974, D4318, D4373, D6913, D7928

SOIL INDEX PROPERTIES

Grain Size, Spec. Gravity, Moist. Cont., Eng. Classification, Organic Content, Atterberg Limits, Carbonate Content

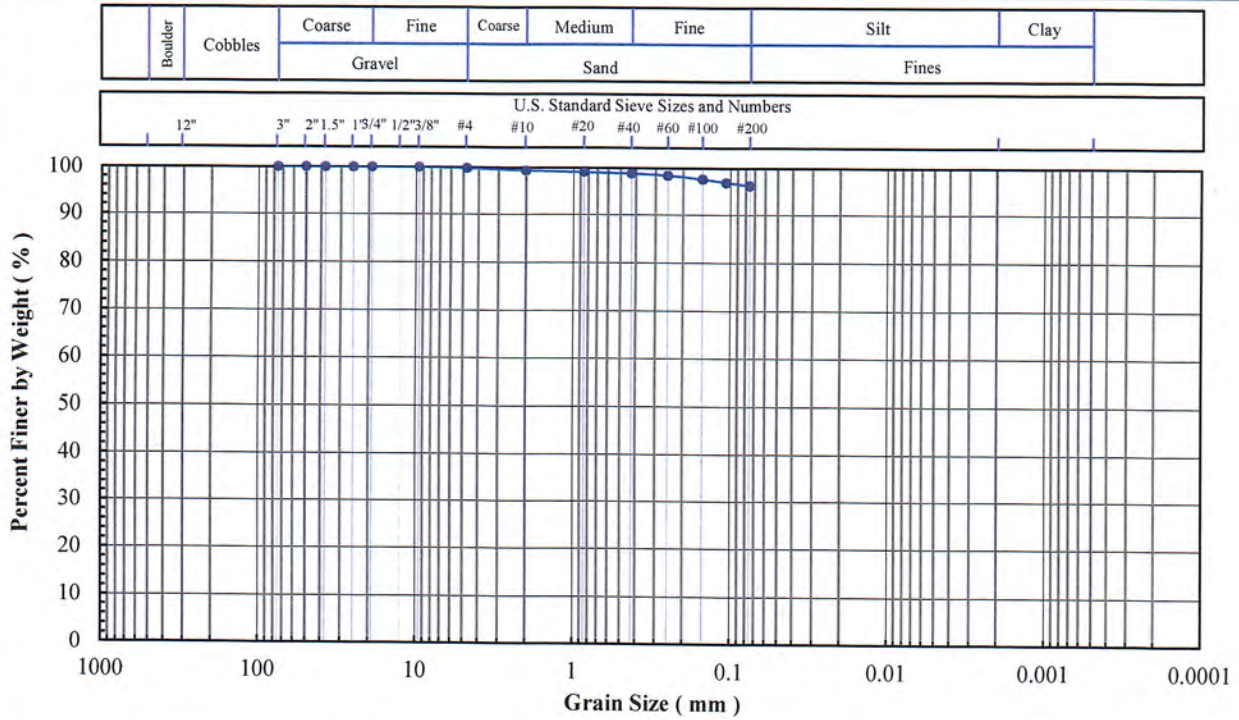

Sieve No.	Size (mm)	% Finer
3"	75	100.0
2"	50	100.0
1.5"	37.5	100.0
1"	25	100.0
3/4"	19	100.0
3/8"	9.5	100.0
#4	4.75	99.8
#10	2.00	99.3
#20	0.850	99.0
#40	0.425	98.7
#60	0.250	98.3
#100	0.150	97.5
#140	0.106	96.8
#200	0.075	96.1

Hydrometer Particle Diameter (mm)	% Finer

Gravel (%):	0.2
Sand (%):	3.7
Fines (%):	96.1
Silt (%):	
Clay (%):	

Coeff. Unif. (Cu):	
Coeff. Curv. (Cc):	

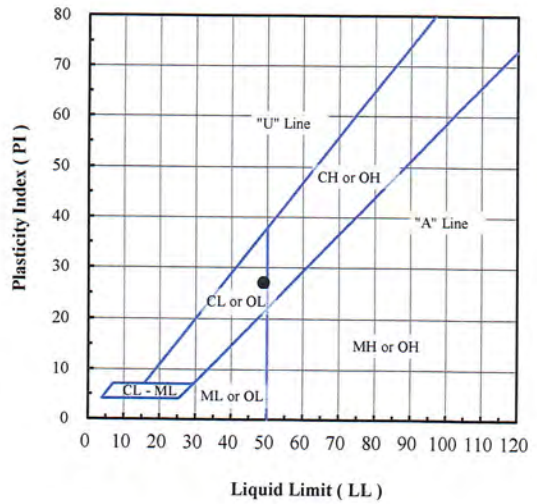

Specific Gravity (-):

Org. Content (%):

Carbon. Content (%):

Client Sample ID.	Lab Sample No.	Moisture Content (%)	Fines Content < No. 200 (%)	Atterberg Limits			Engineering Classification
				LL (-)	PL (-)	PI (-)	
B1-1 (3')	20L186	22.6	96.1	49	22	27	CL - Lean clay

Note(s):

01-25-2021
AA1 MSR



Excel Geotechnical Testing, Inc.
"Excellence in Testing"

953 Forrest Street, Roswell, Georgia 30075
Tel: (770) 910 7537, www.excelgeotesting.com

Project Name: Bell River ALD Support
Project No: PN1017
Client Sample ID: B1-6 (25')
Lab Sample No: 20L191

ASTM C136, D422, D854, D1140, D2216, D2487, D2974, D4318, D4373, D6913, D7928

SOIL INDEX PROPERTIES

Grain Size, Spec. Gravity, Moist. Cont., Eng. Classification, Organic Content, Atterberg Limits, Carbonate Content

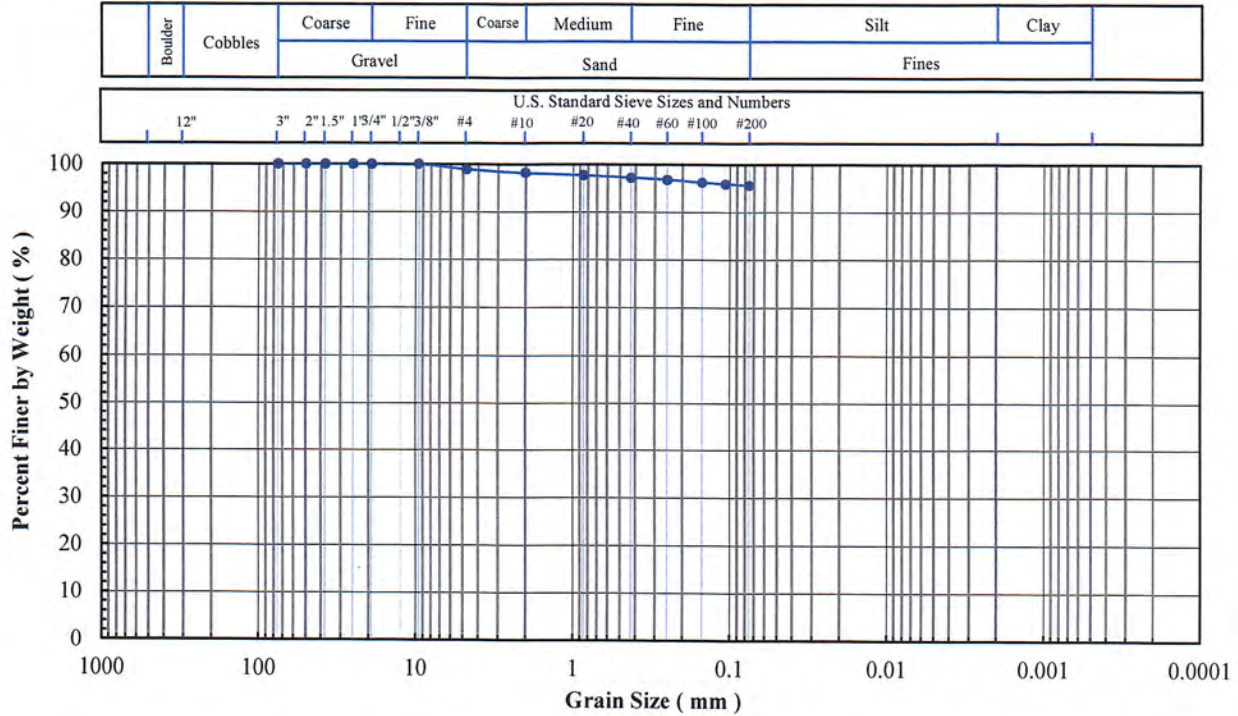

Sieve No.	Size (mm)	% Finer
3"	75	100.0
2"	50	100.0
1.5"	37.5	100.0
1"	25	100.0
3/4"	19	100.0
3/8"	9.5	100.0
#4	4.75	98.9
#10	2.00	98.2
#20	0.850	97.7
#40	0.425	97.2
#60	0.250	96.8
#100	0.150	96.2
#140	0.106	95.9
#200	0.075	95.6

Hydrometer Particle Diameter (mm)	% Finer

Gravel (%):	1.1
Sand (%):	3.3
Fines (%):	95.6
Silt (%):	
Clay (%):	

Coeff. Unif. (Cu):	
Coeff. Curv. (Cc):	

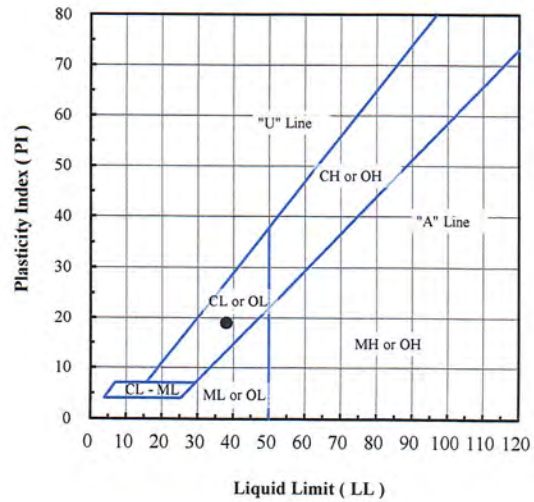

Specific Gravity (-):

Org. Content (%):

Carbon. Content (%):

Client Sample ID.	Lab Sample No.	Moisture Content (%)	Fines Content < No. 200 (%)	Atterberg Limits			Engineering Classification
				LL (-)	PL (-)	PI (-)	
B1-6 (25')	20L191	35.5	95.6	38	19	19	CL - Lean clay

Note(s):

01-26-2021
A.A. NSR



Excel Geotechnical Testing, Inc.
 "Excellence in Testing"

953 Forrest Street, Roswell, Georgia 30075
 Tel: (770) 910 7537, www.excelgeotesting.com

Project Name: Belle River ALD Support
 Project No: PN1017
 Client Sample ID: B1-9 (48')
 Lab Sample No: 20L194

ASTM C136, D422, D854, D1140, D2216, D2487, D2974, D4318, D4373, D6913, D7928

SOIL INDEX PROPERTIES

Grain Size, Spec. Gravity, Moist. Cont., Eng. Classification, Organic Content, Atterberg Limits, Carbonate Content

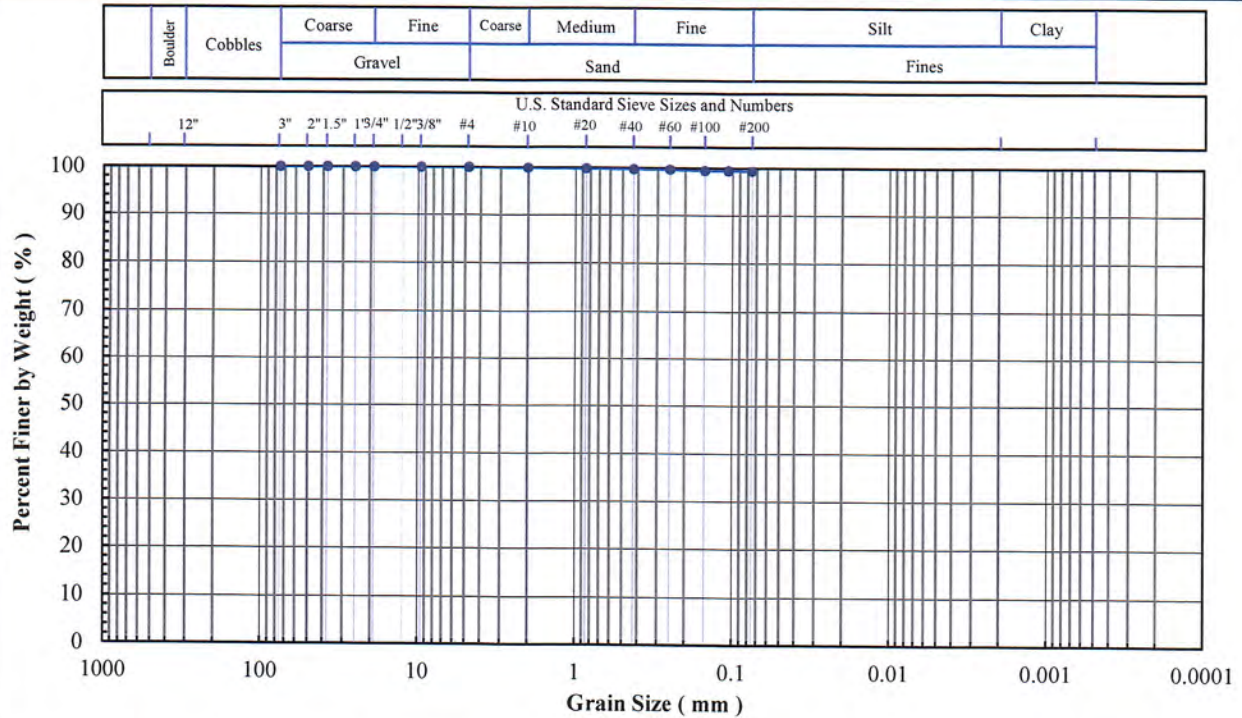

Sieve No.	Size (mm)	% Finer
3"	75	100.0
2"	50	100.0
1.5"	37.5	100.0
1"	25	100.0
3/4"	19	100.0
3/8"	9.5	100.0
#4	4.75	100.0
#10	2.00	99.9
#20	0.850	99.8
#40	0.425	99.7
#60	0.250	99.6
#100	0.150	99.4
#140	0.106	99.4
#200	0.075	99.3

Hydrometer Particle Diameter (mm)	% Finer

Gravel (%):	
Sand (%):	0.7
Fines (%):	99.3
Silt (%):	
Clay (%):	

Coeff. Unif. (Cu):	
Coeff. Curv. (Cc):	

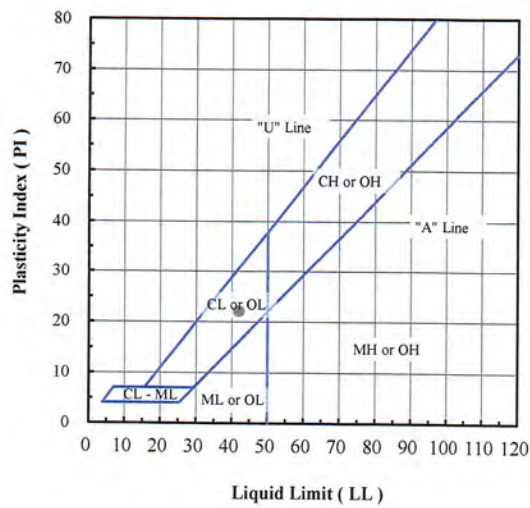

Specific Gravity (-):

Org. Content (%):

Carbon. Content (%):

Client Sample ID.	Lab Sample No:	Moisture Content (%)	Fines Content < No. 200 (%)	Atterberg Limits			Engineering Classification
				LL (-)	PL (-)	PI (-)	
B1-9 (48')	20L194	39.5	99.3	42	20	22	CL - Lean clay

Note(s):

01-21-2021
AA, NSR



Excel Geotechnical Testing, Inc.
"Excellence in Testing"

953 Forrest Street, Roswell, Georgia 30075
Tel: (770) 910 7537, www.excelgeotesting.com

Project Name: Belle River ALD Support
Project No: PN1017
Client Sample ID: B1-11 (59')
Lab Sample No: 20L196

ASTM C136, D422, D854, D1140, D2216, D2487, D2974, D4318, D4373, D6913, D7928

SOIL INDEX PROPERTIES

Grain Size, Spec. Gravity, Moist. Cont., Eng. Classification, Organic Content, Atterberg Limits, Carbonate Content

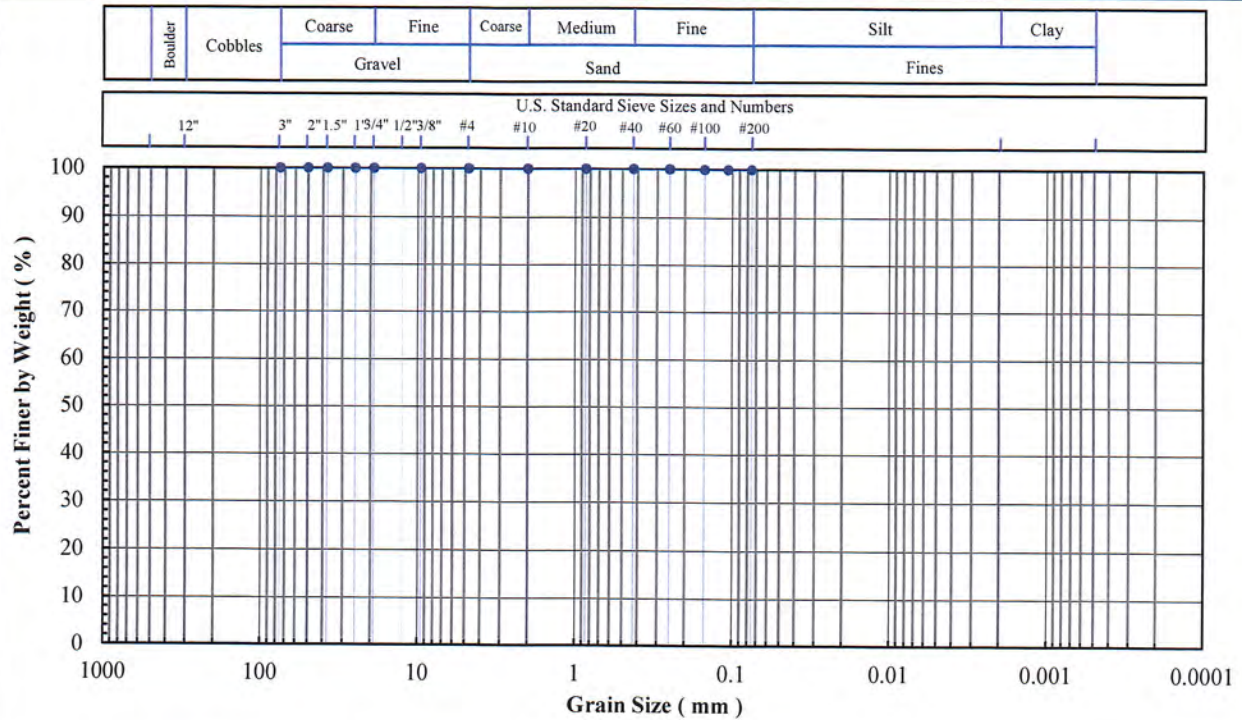

Sieve No.	Size (mm)	% Finer
3"	75	100.0
2"	50	100.0
1.5"	37.5	100.0
1"	25	100.0
3/4"	19	100.0
3/8"	9.5	100.0
#4	4.75	100.0
#10	2.00	100.0
#20	0.850	100.0
#40	0.425	100.0
#60	0.250	100.0
#100	0.150	99.9
#140	0.106	99.9
#200	0.075	99.9

Hydrometer Particle Diameter (mm)	% Finer

Gravel (%):	
Sand (%):	0.1
Fines (%):	99.9
Silt (%):	
Clay (%):	

Coeff. Unif. (Cu):	
Coeff. Curv. (Cc):	

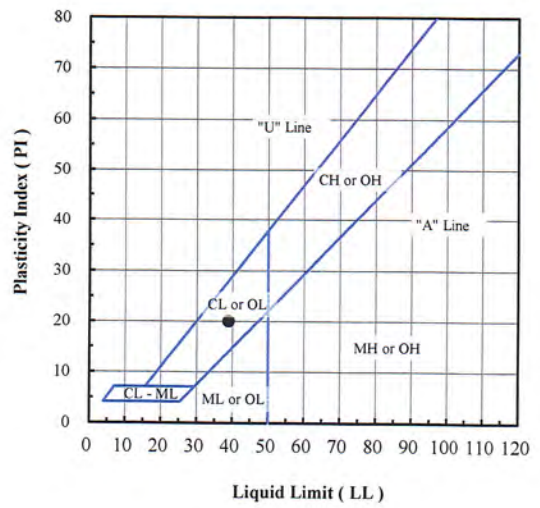

Specific Gravity (-):

Org. Content (%):

Carbon. Content (%):

Client Sample ID.	Lab Sample No.	Moisture Content (%)	Fines Content < No. 200 (%)	Atterberg Limits			Engineering Classification
				LL (-)	PL (-)	PI (-)	
B1-11 (59')	20L196	36.8	99.9	39	19	20	CL - Lean clay

Note(s):

01-25-2021
AAI, NSR



Excel Geotechnical Testing, Inc.
"Excellence in Testing"

953 Forrest Street, Roswell, Georgia 30075
Tel: (770) 910 7537, www.excelgeotesting.com

Project Name: Belle River ALD Support

Project No: PN1017

Client Sample ID: B1-14 (80')

Lab Sample No: 20L199

ASTM C136, D422, D854, D1140, D2216, D2487, D2974, D4318, D4373, D6913, D7928

SOIL INDEX PROPERTIES

Grain Size, Spec. Gravity, Moist. Cont., Eng. Classification, Organic Content, Atterberg Limits, Carbonate Content

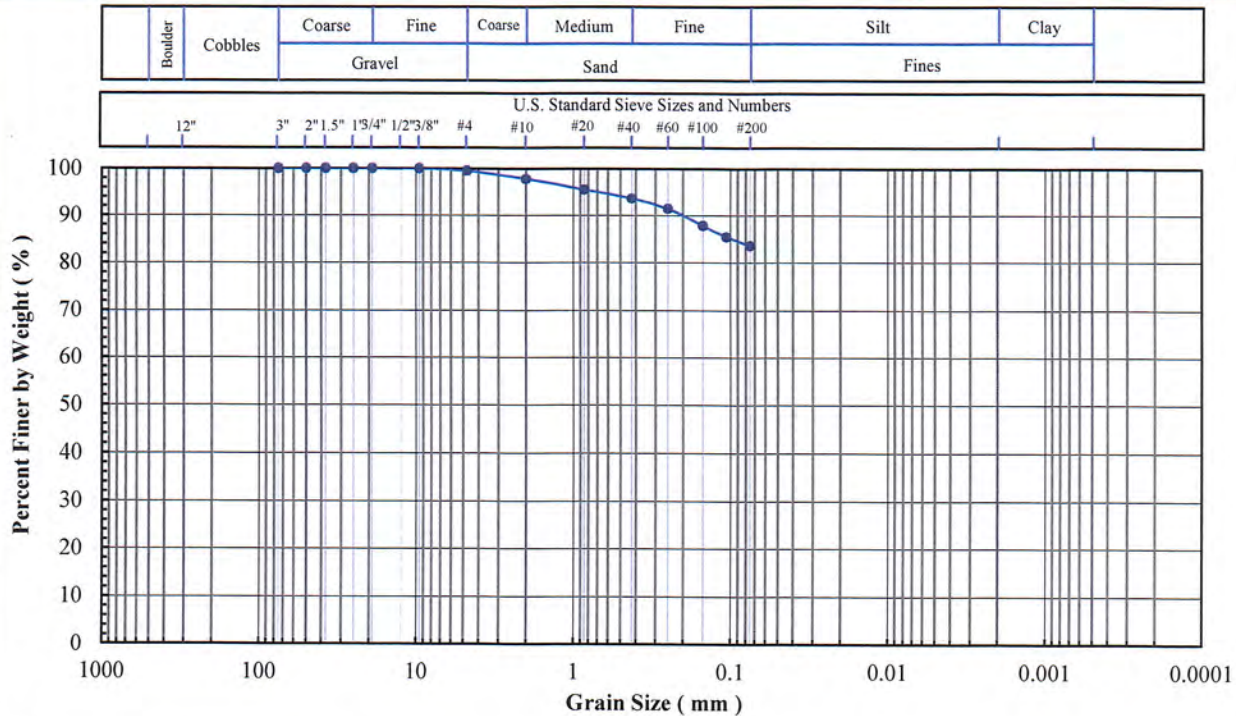

Sieve No.	Size (mm)	% Finer
3"	75	100.0
2"	50	100.0
1.5"	37.5	100.0
1"	25	100.0
3/4"	19	100.0
3/8"	9.5	100.0
#4	4.75	99.5
#10	2.00	97.8
#20	0.850	95.5
#40	0.425	93.6
#60	0.250	91.4
#100	0.150	87.8
#140	0.106	85.4
#200	0.075	83.5

Hydrometer Particle Diameter (mm)	% Finer

Gravel (%):	0.5
Sand (%):	16.0
Fines (%):	83.5
Silt (%):	
Clay (%):	

Coeff. Unif. (Cu):	
Coeff. Curv. (Cc):	

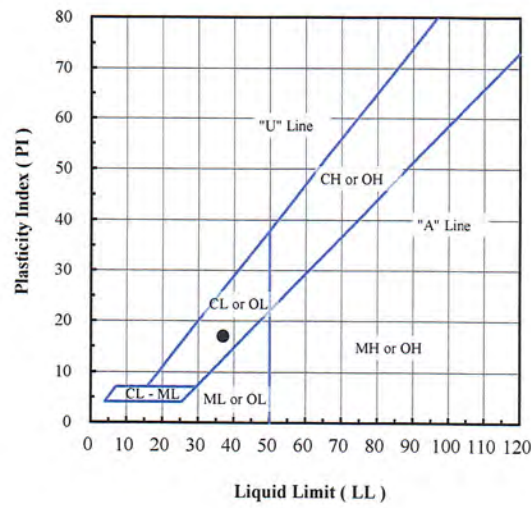

Specific Gravity (-):

Org. Content (%):

Carbon. Content (%):

Client Sample ID.	Lab Sample No.	Moisture Content (%)	Fines Content < No. 200 (%)	Atterberg Limits			Engineering Classification
				LL (-)	PL (-)	PI (-)	
B1-14 (80')	20L199	24.6	83.5	37	20	17	CL - Lean clay with sand

Note(s):

01-25-2021
AA, NSR



Excel Geotechnical Testing, Inc.
"Excellence in Testing"

953 Forrest Street, Roswell, Georgia 30075
 Tel: (770) 910 7537, www.excelgeotesting.com

Project Name: Bell River ALD Support
Project No: PN1017
Client Sample ID: B1-16 (85')
Lab Sample No: 20L201

ASTM C136, D422, D854, D1140, D2216, D2487, D2974, D4318,
 D4373, D6913, D7928

SOIL INDEX PROPERTIES

Grain Size, Spec. Gravity, Moist. Cont.,
 Eng. Classification, Organic Content, Atterberg Limits, Carbonate Content

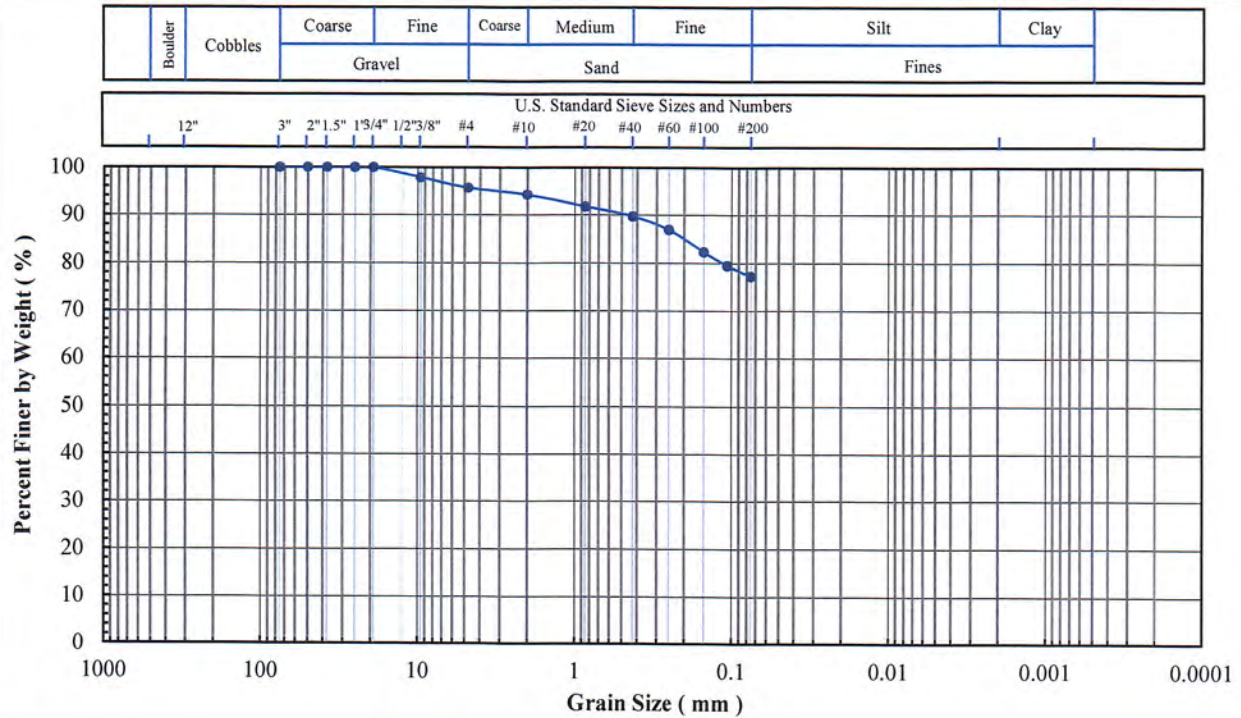

Sieve No.	Size (mm)	% Finer
3"	75	100
2"	50	100
1.5"	37.5	100
1"	25	100
3/4"	19	100
3/8"	9.5	98
#4	4.75	96
#10	2.00	94
#20	0.850	92
#40	0.425	90
#60	0.250	87
#100	0.150	82
#140	0.106	79
#200	0.075	77

Hydrometer Particle Diameter (mm)	% Finer

Gravel (%):	4
Sand (%):	19
Fines (%):	77
Silt (%):	
Clay (%):	

Coeff. Unif. (Cu):	
Coeff. Curv. (Cc):	

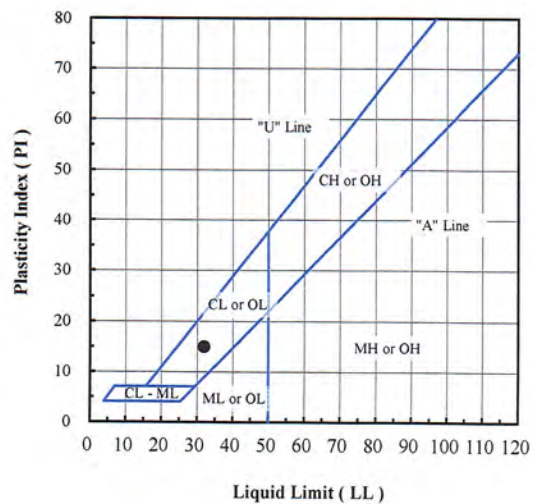

Specific Gravity (-):

Org. Content (%):

Carbon. Content (%):

Client Sample ID.	Lab Sample No.	Moisture Content (%)	Fines Content < No. 200 (%)	Atterberg Limits			Engineering Classification
				LL (-)	PL (-)	PI (-)	
B1-16 (85')	20L201	19.5	77	32	17	15	CL - Lean clay with sand

Note(s): Sieve specimen was undersized.

01-26-2021
 AA1NSR



Excel Geotechnical Testing, Inc.
 "Excellence in Testing"

953 Forrest Street, Roswell, Georgia 30075
 Tel: (770) 910 7537, www.excelgeotesting.com

Project Name: Belle River ALD Support
 Project No: PN1017
 Client Sample ID: B1-ST-1 (7-9)
 Lab Sample No: 20L143

ASTM C136, D422, D854, D1140, D2216, D2487, D2974, D4318,
 D4373, D6913, D7928

SOIL INDEX PROPERTIES

Grain Size, Spec. Gravity, Moist. Cont.
 Eng. Classification, Organic Content, Atterberg Limits, Carbonate Content

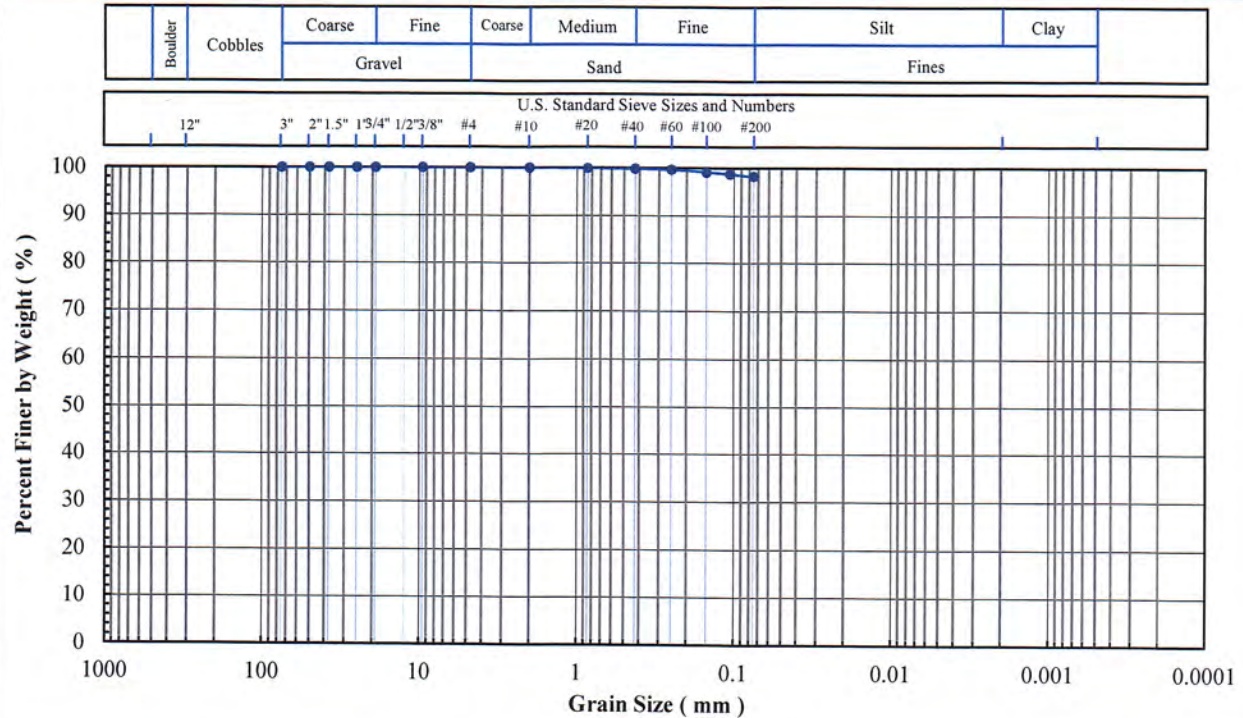

Sieve No.	Size (mm)	% Finer
3"	75	100.0
2"	50	100.0
1.5"	37.5	100.0
1"	25	100.0
3/4"	19	100.0
3/8"	9.5	100.0
#4	4.75	100.0
#10	2.00	100.0
#20	0.850	99.9
#40	0.425	99.8
#60	0.250	99.6
#100	0.150	99.1
#140	0.106	98.7
#200	0.075	98.2

Hydrometer Particle Diameter (mm)	% Finer

Gravel (%):	
Sand (%):	1.8
Fines (%):	98.2
Silt (%):	
Clay (%):	

Coeff. Unif. (Cu):	
Coeff. Curv. (Cc):	

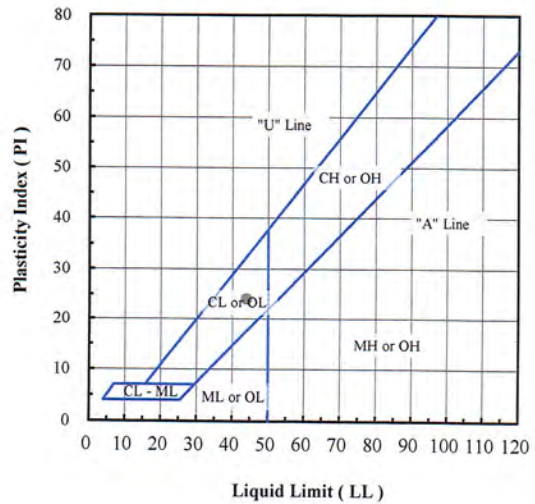

Specific Gravity (-):	
-----------------------	--

Org. Content (%):	
-------------------	--

Carbon. Content (%):	
----------------------	--

Client Sample ID.	Lab Sample No.	Moisture Content (%)	Fines Content < No. 200 (%)	Atterberg Limits			Engineering Classification
				LL (-)	PL (-)	PI (-)	
B1-ST-1 (7-9)	20L143	22.7	98.2	44	20	24	CL - Lean clay

Note(s):

*02-01-2021
 AA, NSB*



Excel Geotechnical Testing, Inc.
"Excellence in Testing"

953 Forrest Street, Roswell, Georgia 30075
 Tel: (770) 910 7537, www.excelgeotesting.com

Project Name: Belle River ALD Support
 Project No: PN1017
 Client Sample ID: B1-ST-3 (36-38')
 Lab Sample No: 20L145

ASTM C136, D422, D854, D1140, D2216, D2487, D2974, D4318, D4373, D6913, D7928

SOIL INDEX PROPERTIES

Grain Size, Spec. Gravity, Moist. Cont., Eng. Classification, Organic Content, Atterberg Limits, Carbonate Content

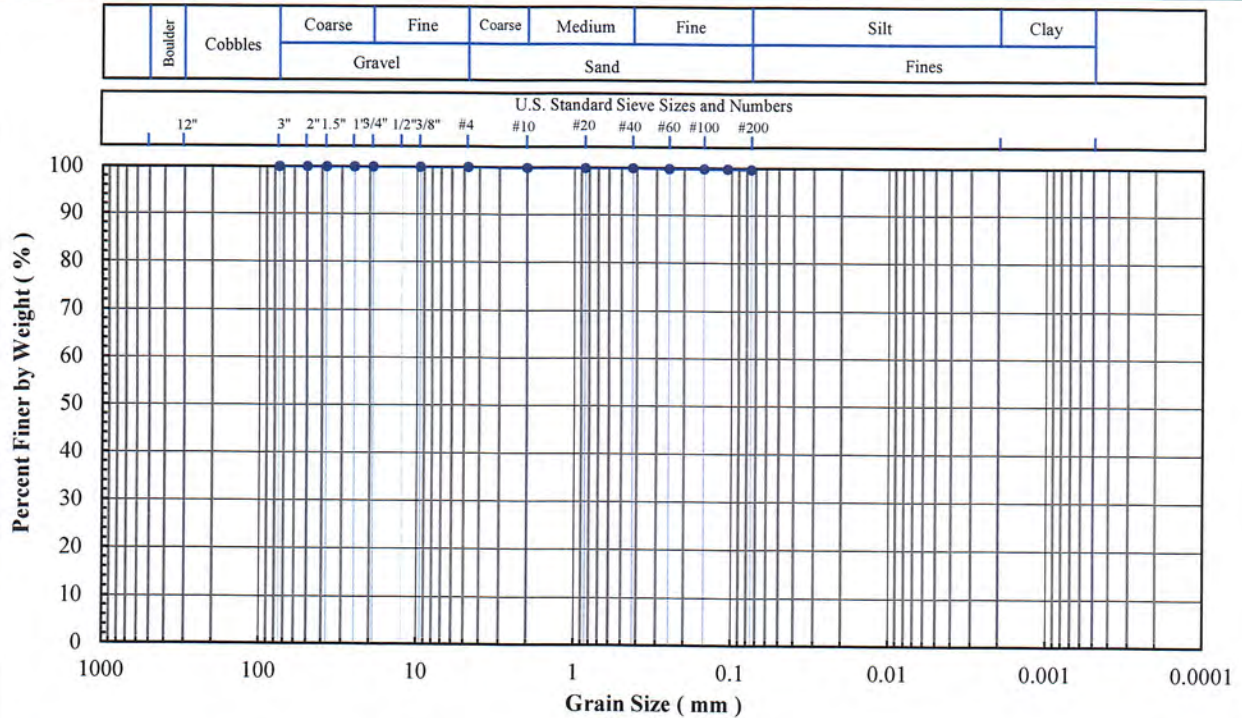

Sieve No.	Size (mm)	% Finer
3"	75	100.0
2"	50	100.0
1.5"	37.5	100.0
1"	25	100.0
3/4"	19	100.0
3/8"	9.5	100.0
#4	4.75	100.0
#10	2.00	99.9
#20	0.850	99.9
#40	0.425	99.9
#60	0.250	99.8
#100	0.150	99.8
#140	0.106	99.8
#200	0.075	99.7

Hydrometer Particle Diameter (mm)	% Finer

Gravel (%):	
Sand (%):	0.3
Fines (%):	99.7
Silt (%):	
Clay (%):	

Coeff. Unif. (Cu):	
Coeff. Curv. (Cc):	

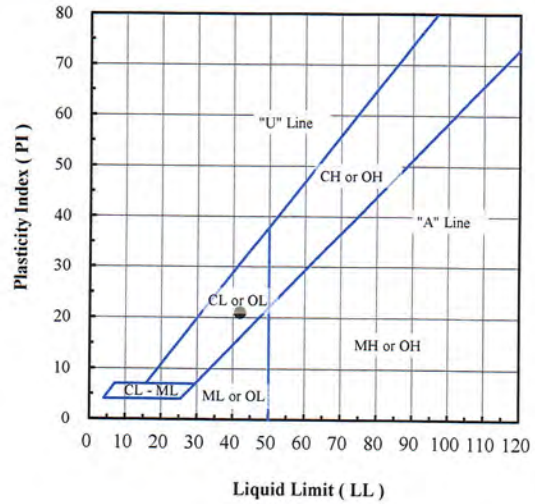

Specific Gravity (-):	
-----------------------	--

Org. Content (%):	
-------------------	--

Carbon. Content (%):	
----------------------	--

Client Sample ID.	Lab Sample No.	Moisture Content (%)	Fines Content < No. 200 (%)	Atterberg Limits			Engineering Classification
				LL (-)	PL (-)	PI (-)	
B1-ST-3 (36-38')	20L145	35.2	99.7	42	21	21	CL - Lean clay

Note(s):

02-01-2021
 AA1 NSR



Excel Geotechnical Testing, Inc.
"Excellence in Testing"

953 Forrest Street, Roswell, Georgia 30075
Tel: (770) 910 7537, www.excelgeotesting.com

Project Name: Belle River ALD Support
Project No: PN1017
Client Sample ID: B2-2 (5')
Lab Sample No: 20L205

ASTM C136, D422, D854, D1140, D2216, D2487, D2974, D4318, D4373, D6913, D7928

SOIL INDEX PROPERTIES

Grain Size, Spec. Gravity, Moist. Cont., Eng. Classification, Organic Content, Atterberg Limits, Carbonate Content

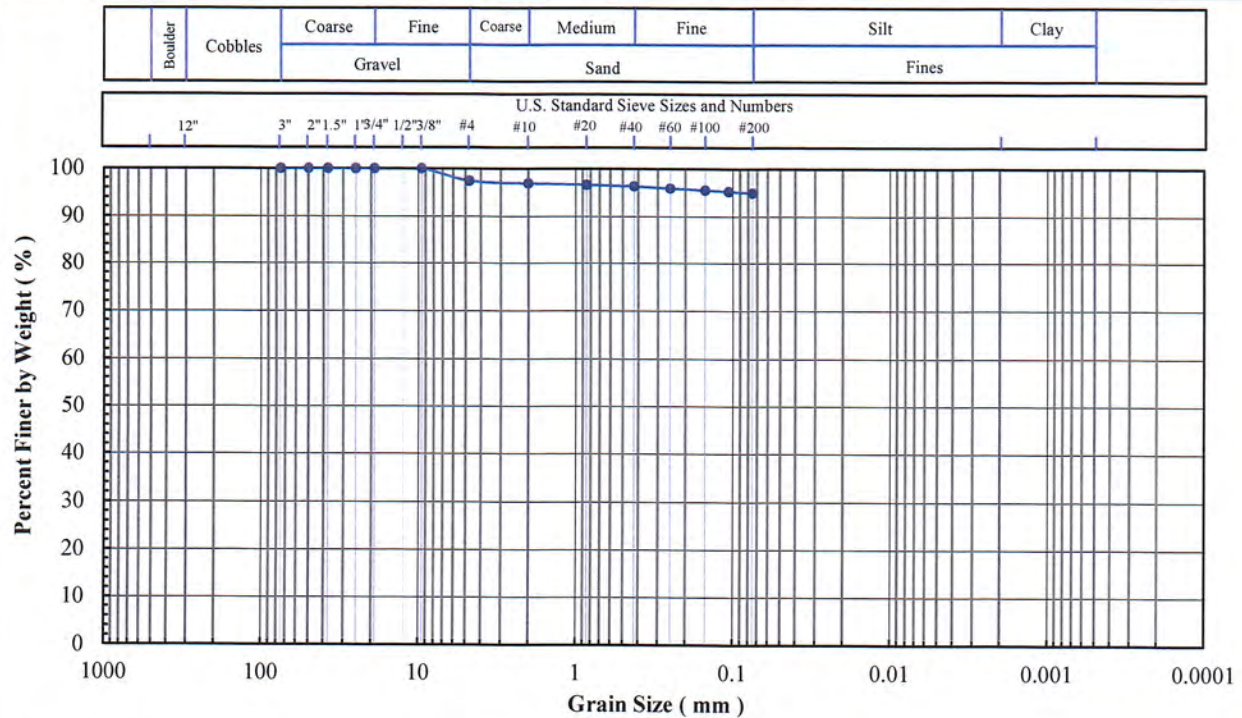

Sieve No.	Size (mm)	% Finer
3"	75	100.0
2"	50	100.0
1.5"	37.5	100.0
1"	25	100.0
3/4"	19	100.0
3/8"	9.5	100.0
#4	4.75	97.4
#10	2.00	96.9
#20	0.850	96.6
#40	0.425	96.3
#60	0.250	95.9
#100	0.150	95.5
#140	0.106	95.2
#200	0.075	94.9

Hydrometer Particle Diameter (mm)	% Finer

Gravel (%):	2.6
Sand (%):	2.5
Fines (%):	94.9
Silt (%):	
Clay (%):	

Coeff. Unif. (Cu):	
Coeff. Curv. (Cc):	

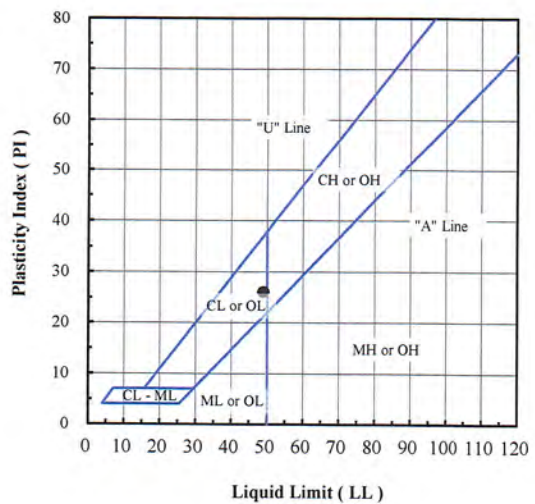

Specific Gravity (-):

Org. Content (%):

Carbon. Content (%):

Client Sample ID.	Lab Sample No.	Moisture Content (%)	Fines Content < No. 200 (%)	Atterberg Limits			Engineering Classification
				LL (-)	PL (-)	PI (-)	
B2-2 (5')	20L205	26.9	94.9	49	23	26	CL - Lean clay

Note(s):

01-25-2021
AA1/NSR



Excel Geotechnical Testing, Inc.
"Excellence in Testing"

953 Forrest Street, Roswell, Georgia 30075
Tel: (770) 910 7537, www.excelgeotesting.com

Project Name: Belle River ALD Support

Project No: PN1017

Client Sample ID: B2-5 (18')

Lab Sample No: 20L208

ASTM C136, D422, D854, D1140, D2216, D2487, D2974, D4318, D4373, D6913, D7928

SOIL INDEX PROPERTIES

Grain Size, Spec. Gravity, Moist. Cont., Eng. Classification, Organic Content, Atterberg Limits, Carbonate Content

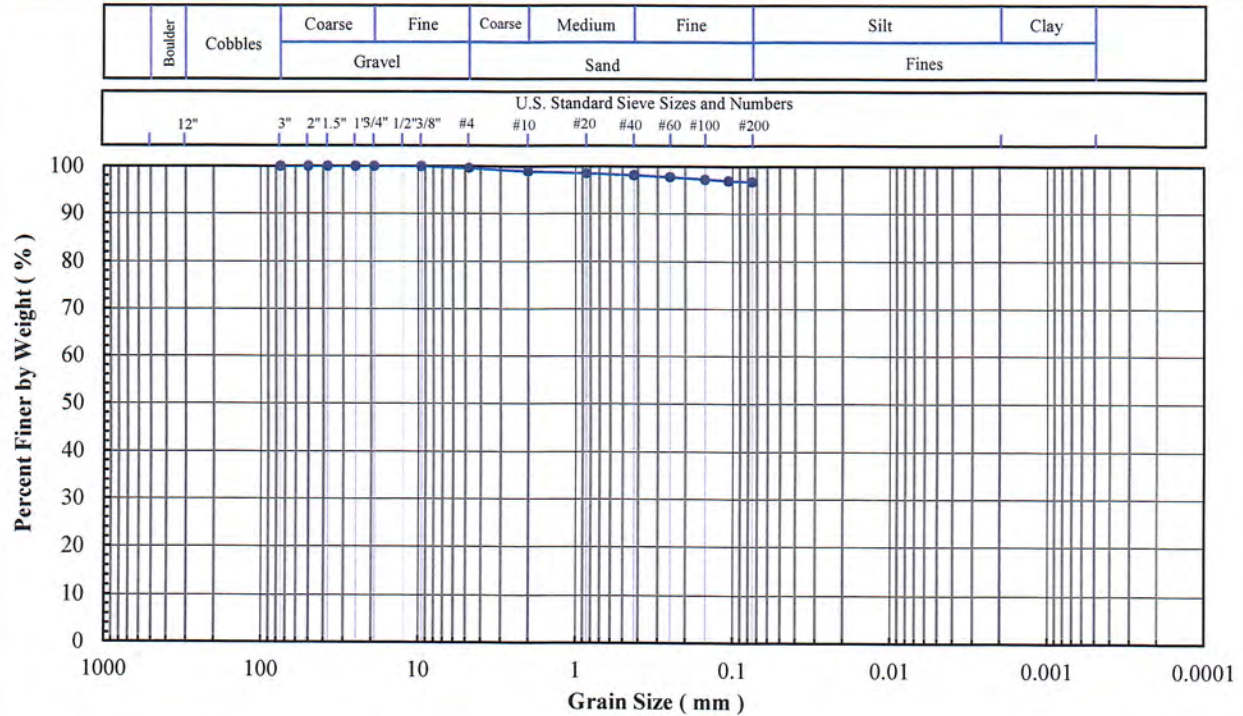

Sieve No.	Size (mm)	% Finer
3"	75	100.0
2"	50	100.0
1.5"	37.5	100.0
1"	25	100.0
3/4"	19	100.0
3/8"	9.5	100.0
#4	4.75	99.6
#10	2.00	98.9
#20	0.850	98.5
#40	0.425	98.1
#60	0.250	97.7
#100	0.150	97.2
#140	0.106	96.9
#200	0.075	96.7

Hydrometer Particle Diameter (mm)	% Finer

Gravel (%):	0.4
Sand (%):	2.9
Fines (%):	96.7
Silt (%):	
Clay (%):	

Coeff. Unif. (Cu):	
Coeff. Curv. (Cc):	

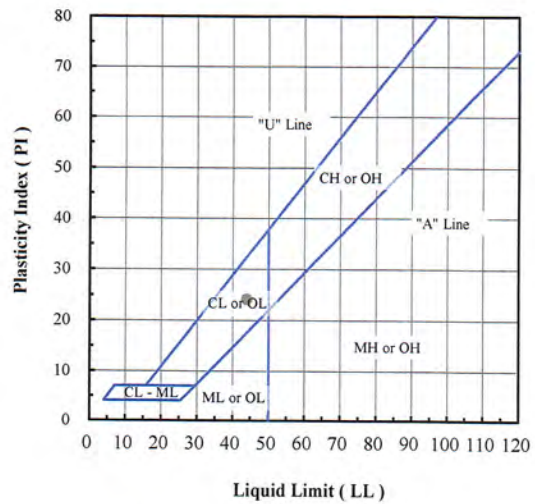

Specific Gravity (-):

Org. Content (%):

Carbon. Content (%):

Client Sample ID.	Lab Sample No.	Moisture Content (%)	Fines Content < No. 200 (%)	Atterberg Limits			Engineering Classification
				LL (-)	PL (-)	PI (-)	
B2-5 (18')	20L208	36.3	96.7	44	20	24	CL - Lean Clay

Note(s):

01-25-2021
AA, N5R



Excel Geotechnical Testing, Inc.
"Excellence in Testing"

953 Forrest Street, Roswell, Georgia 30075
Tel: (770) 910 7537, www.excelgeotesting.com

Project Name: Belle River ALD Support
Project No: PN1017
Client Sample ID: B2-8 (40')
Lab Sample No: 20L211

ASTM C136, D422, D854, D1140, D2216, D2487, D2974, D4318, D4373, D6913, D7928

SOIL INDEX PROPERTIES

Grain Size, Spec. Gravity, Moist. Cont., Eng. Classification, Organic Content, Atterberg Limits, Carbonate Content

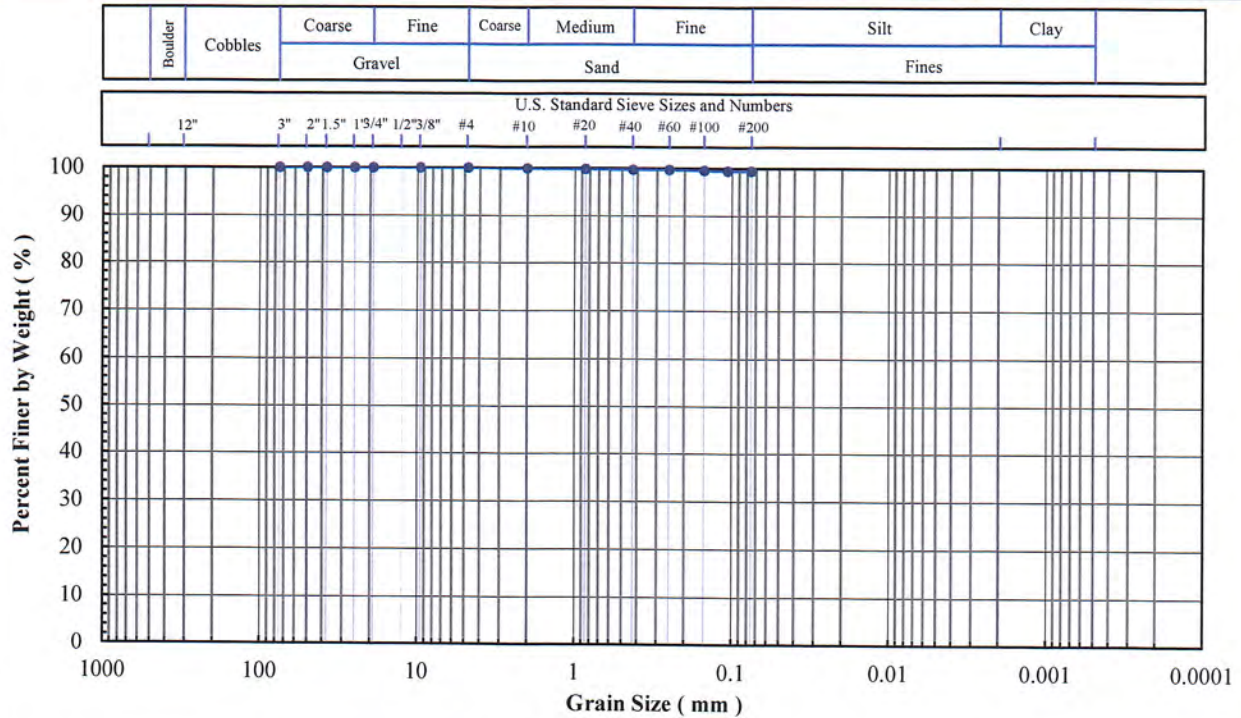

Sieve No.	Size (mm)	% Finer
3"	75	100.0
2"	50	100.0
1.5"	37.5	100.0
1"	25	100.0
3/4"	19	100.0
3/8"	9.5	100.0
#4	4.75	100.0
#10	2.00	99.9
#20	0.850	99.8
#40	0.425	99.7
#60	0.250	99.7
#100	0.150	99.5
#140	0.106	99.4
#200	0.075	99.4

Hydrometer Particle Diameter (mm)	% Finer

Gravel (%):	
Sand (%):	0.6
Fines (%):	99.4
Silt (%):	
Clay (%):	

Coeff. Unif. (Cu):	
Coeff. Curv. (Cc):	

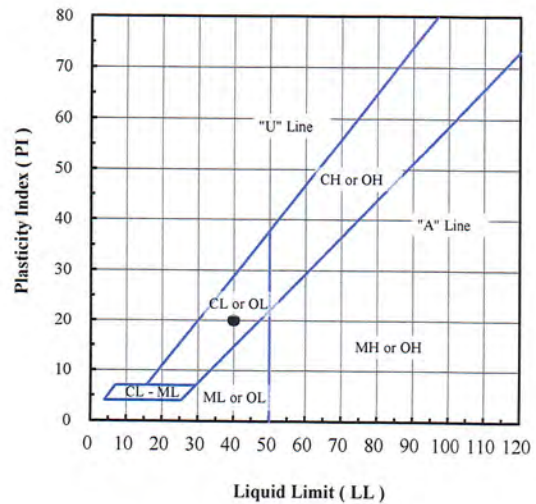

Specific Gravity (-):	
-----------------------	--

Org. Content (%):	
-------------------	--

Carbon. Content (%):	
----------------------	--

Client Sample ID.	Lab Sample No.	Moisture Content (%)	Fines Content < No. 200 (%)	Atterberg Limits			Engineering Classification
				LL (-)	PL (-)	PI (-)	
B2-8 (40')	20L211	37.5	99.4	40	20	20	CL - Lean clay

Note(s):

01-25-2021
AAI, MSR



Excel Geotechnical Testing, Inc.
"Excellence in Testing"

953 Forrest Street, Roswell, Georgia 30075
Tel: (770) 910 7537, www.excelgeotesting.com

Project Name: Belle River ALD Support
Project No: PN1017
Client Sample ID: B2-12 (60')
Lab Sample No: 20L215

ASTM C136, D422, D854, D1140, D2216, D2487, D2974, D4318, D4373, D6913, D7928

SOIL INDEX PROPERTIES

Grain Size, Spec. Gravity, Moist. Cont., Eng. Classification, Organic Content, Atterberg Limits, Carbonate Content

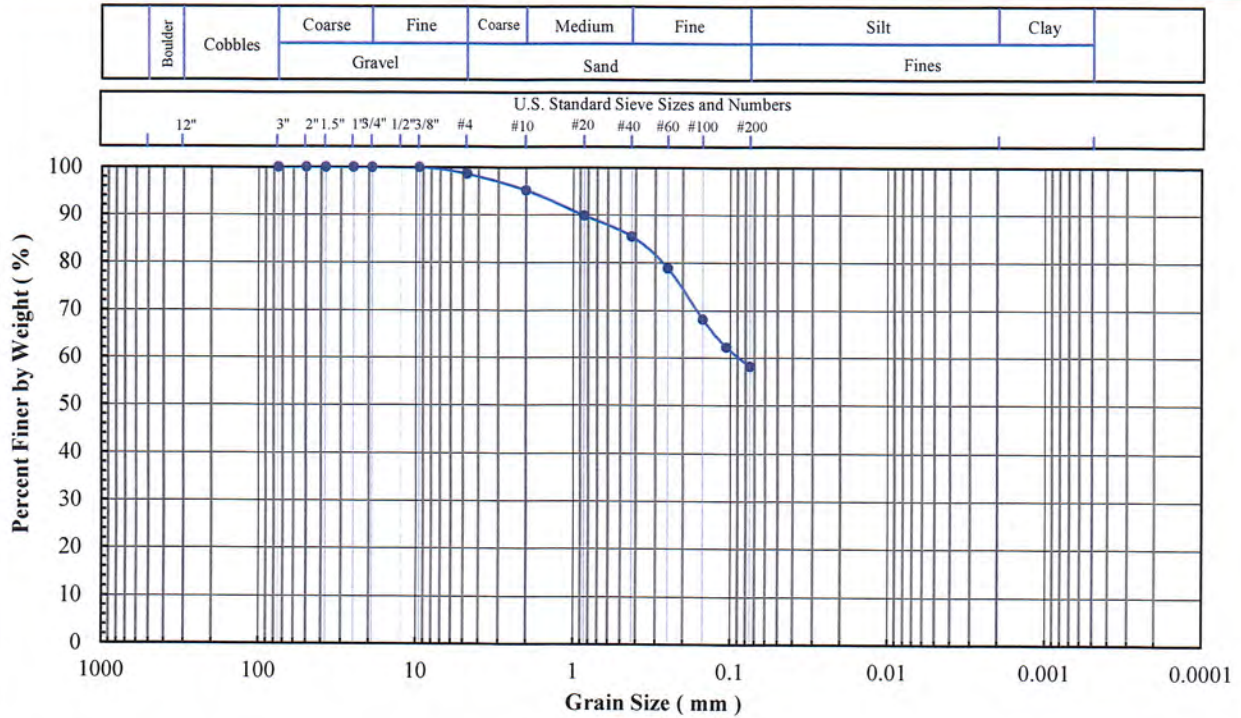

Sieve No.	Size (mm)	% Finer
3"	75	100.0
2"	50	100.0
1.5"	37.5	100.0
1"	25	100.0
3/4"	19	100.0
3/8"	9.5	100.0
#4	4.75	98.6
#10	2.00	95.1
#20	0.850	89.8
#40	0.425	85.4
#60	0.250	78.8
#100	0.150	68.1
#140	0.106	62.2
#200	0.075	58.1

Hydrometer Particle Diameter (mm)	% Finer

Gravel (%):	1.4
Sand (%):	40.5
Fines (%):	58.1
Silt (%):	
Clay (%):	

Coeff. Unif. (Cu):	
Coeff. Curv. (Cc):	

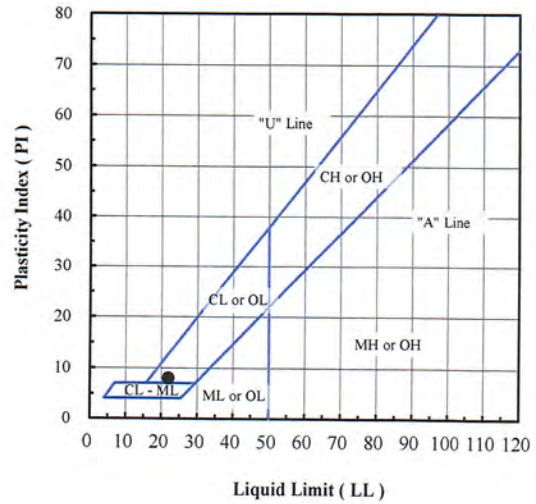

Specific Gravity (-):	
-----------------------	--

Org. Content (%):	
-------------------	--

Carbon. Content (%):	
----------------------	--

Client Sample ID.	Lab Sample No.	Moisture Content (%)	Fines Content < No. 200 (%)	Atterberg Limits			Engineering Classification
				LL (-)	PL (-)	PI (-)	
B2-12 (60')	20L215	17.4	58.1	22	14	8	CL - Sandy lean clay

Note(s):

01-25-2021
AA1, NSR



Excel Geotechnical Testing, Inc.
 "Excellence in Testing"

953 Forrest Street, Roswell, Georgia 30075
 Tel: (770) 910 7537, www.excelgeotesting.com

Project Name: Belle River ALD Support

Project No: PN1017

Client Sample ID: B2-16 (80')

Lab Sample No: 20L219

ASTM C136, D422, D854, D1140, D2216, D2487, D2974, D4318, D4373, D6913, D7928

SOIL INDEX PROPERTIES

Grain Size, Spec. Gravity, Moist. Cont., Eng. Classification, Organic Content, Atterberg Limits, Carbonate Content

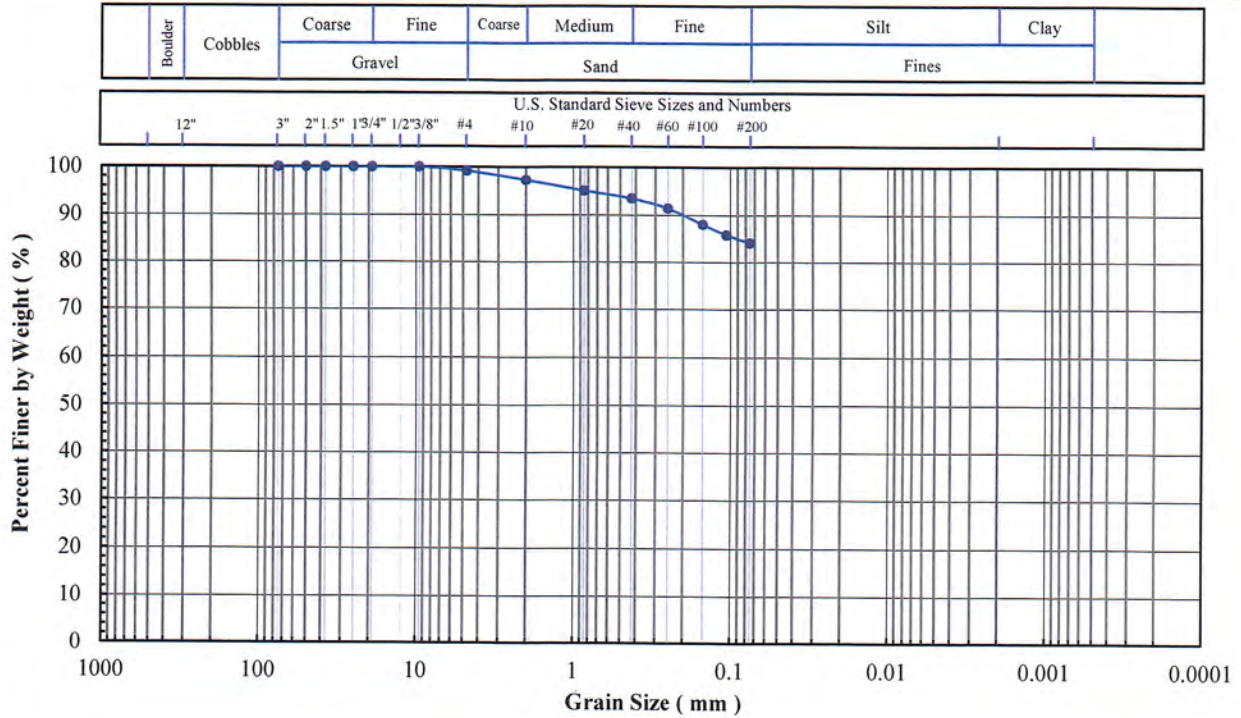

Sieve No.	Size (mm)	% Finer
3"	75	100.0
2"	50	100.0
1.5"	37.5	100.0
1"	25	100.0
3/4"	19	100.0
3/8"	9.5	100.0
#4	4.75	99.2
#10	2.00	97.3
#20	0.850	95.1
#40	0.425	93.5
#60	0.250	91.4
#100	0.150	88.0
#140	0.106	85.8
#200	0.075	84.1

Hydrometer Particle Diameter (mm)	% Finer

Gravel (%):	0.8
Sand (%):	15.1
Fines (%):	84.1
Silt (%):	
Clay (%):	

Coeff. Unif. (Cu):	
Coeff. Curv. (Cc):	

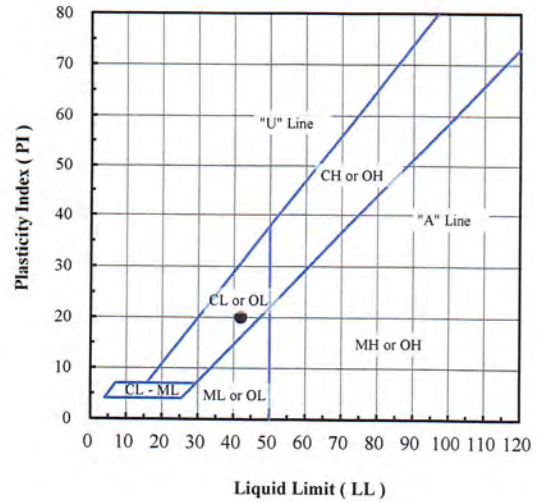

Specific Gravity (-):

Org. Content (%):

Carbon. Content (%):

Client Sample ID.	Lab Sample No.	Moisture Content (%)	Fines Content < No. 200 (%)	Atterberg Limits			Engineering Classification
				LL (-)	PL (-)	PI (-)	
B2-16 (80')	20L219	25.2	84.1	42	22	20	CL - Lean clay with sand

Note(s):

01-25-2021
 AA1 NSR



Excel Geotechnical Testing, Inc.
 "Excellence in Testing"

953 Forrest Street, Roswell, Georgia 30075
 Tel: (770) 910 7537, www.excelgeotesting.com

Project Name: Belle River ALD Support
 Project No: PN1017
 Client Sample ID: B2-ST-1 (1-3')
 Lab Sample No: 20L149

ASTM C136, D422, D854, D1140, D2216, D2487, D2974, D4318,
 D4373, D6913, D7928

SOIL INDEX PROPERTIES

Grain Size, Spec. Gravity, Moist. Cont.,
 Eng. Classification, Organic Content, Atterberg Limits, Carbonate Content

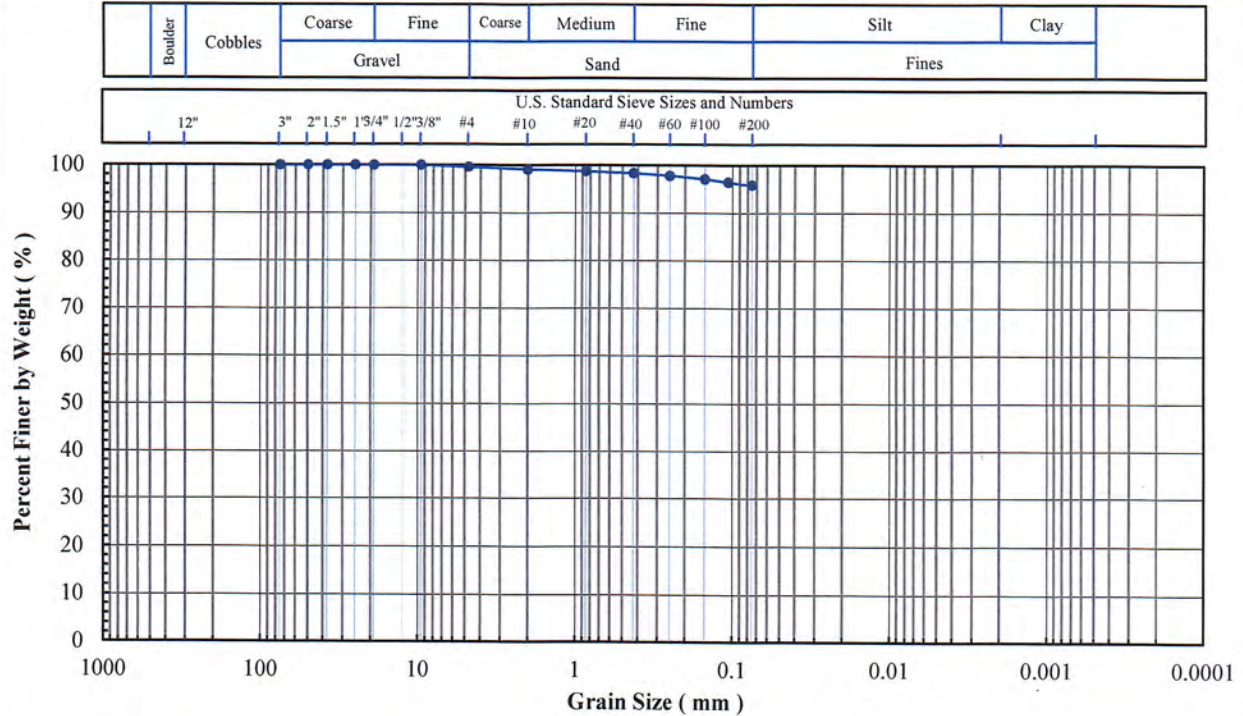

Sieve No.	Size (mm)	% Finer
3"	75	100.0
2"	50	100.0
1.5"	37.5	100.0
1"	25	100.0
3/4"	19	100.0
3/8"	9.5	100.0
#4	4.75	99.6
#10	2.00	99.1
#20	0.850	98.7
#40	0.425	98.3
#60	0.250	97.8
#100	0.150	97.1
#140	0.106	96.4
#200	0.075	95.8

Hydrometer Particle Diameter (mm)	% Finer

Gravel (%):	0.4
Sand (%):	3.8
Fines (%):	95.8
Silt (%):	
Clay (%):	

Coeff. Unif. (Cu):	
Coeff. Curv. (Cc):	

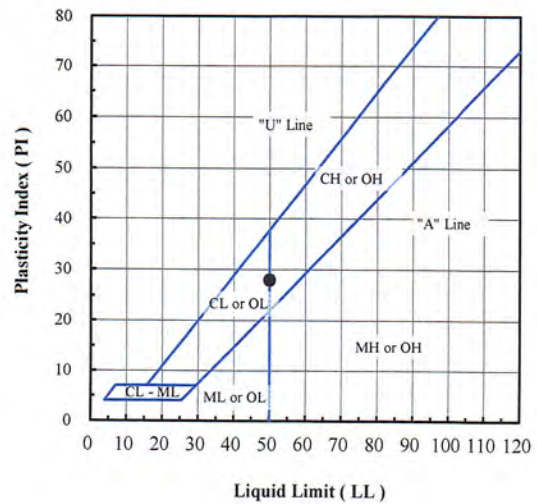

Specific Gravity (-):	
-----------------------	--

Org. Content (%):	
-------------------	--

Carbon. Content (%):	
----------------------	--

Client Sample ID.	Lab Sample No.	Moisture Content (%)	Fines Content < No. 200 (%)	Atterberg Limits			Engineering Classification
				LL (-)	PL (-)	PI (-)	
B2-ST-1 (1-3')	20L149	23.0	95.8	50	22	28	CL - Lean clay

Note(s):

02-01-2021
 AA1NSA



Excel Geotechnical Testing, Inc.
"Excellence in Testing"

953 Forrest Street, Roswell, Georgia 30075
 Tel: (770) 910 7537, www.excelgeotesting.com

Project Name: Belle River ALD Support
 Project No: PN1017
 Client Sample ID: B3-2 (5')
 Lab Sample No: 20L224

ASTM C136, D422, D854, D1140, D2216, D2487, D2974, D4318, D4373, D6913, D7928

SOIL INDEX PROPERTIES

Grain Size, Spec. Gravity, Moist. Cont., Eng. Classification, Organic Content, Atterberg Limits, Carbonate Content

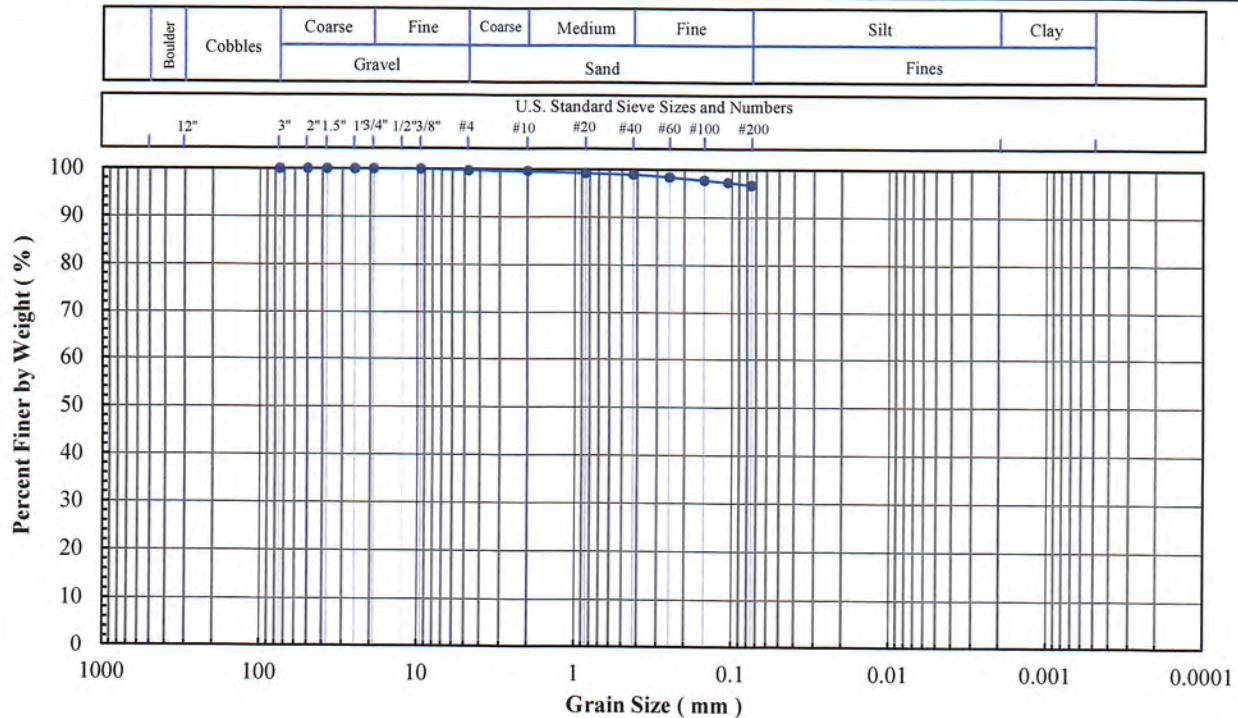

Sieve No.	Size (mm)	% Finer
3"	75	100.0
2"	50	100.0
1.5"	37.5	100.0
1"	25	100.0
3/4"	19	100.0
3/8"	9.5	100.0
#4	4.75	99.7
#10	2.00	99.6
#20	0.850	99.2
#40	0.425	98.9
#60	0.250	98.4
#100	0.150	97.7
#140	0.106	97.3
#200	0.075	96.7

Hydrometer Particle Diameter (mm)	% Finer

Gravel (%):	0.3
Sand (%):	3.0
Fines (%):	96.7
Silt (%):	
Clay (%):	

Coeff. Unif. (Cu):	
Coeff. Curv. (Cc):	

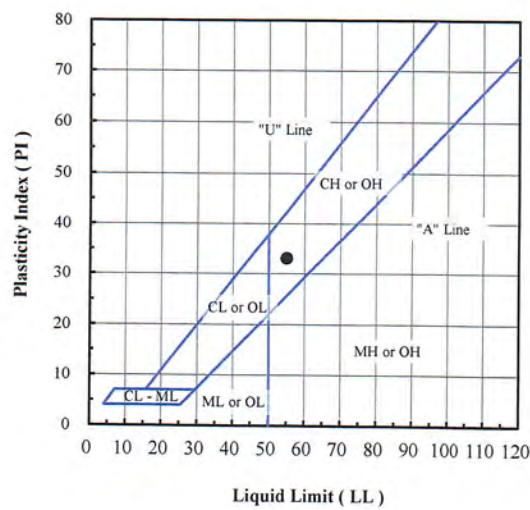

Specific Gravity (-):

Org. Content (%):

Carbon. Content (%):

Client Sample ID.	Lab Sample No.	Moisture Content (%)	Fines Content < No. 200 (%)	Atterberg Limits			Engineering Classification
				LL (-)	PL (-)	PI (-)	
B3-2 (5')	20L224	24.1	96.7	55	22	33	CH - Fat clay

Note(s):

*01-25-2021
 A.A. NSR*



Excel Geotechnical Testing, Inc.
 "Excellence in Testing"

953 Forrest Street, Roswell, Georgia 30075
 Tel: (770) 910 7537, www.excelgeotesting.com

Project Name: Belle River ALD Support
 Project No: PN1017
 Client Sample ID: B3-6 (25')
 Lab Sample No: 20L228

ASTM C136, D422, D854, D1140, D2216, D2487, D2974, D4318, D4373, D6913, D7928

SOIL INDEX PROPERTIES

Grain Size, Spec. Gravity, Moist. Cont., Eng. Classification, Organic Content, Atterberg Limits, Carbonate Content

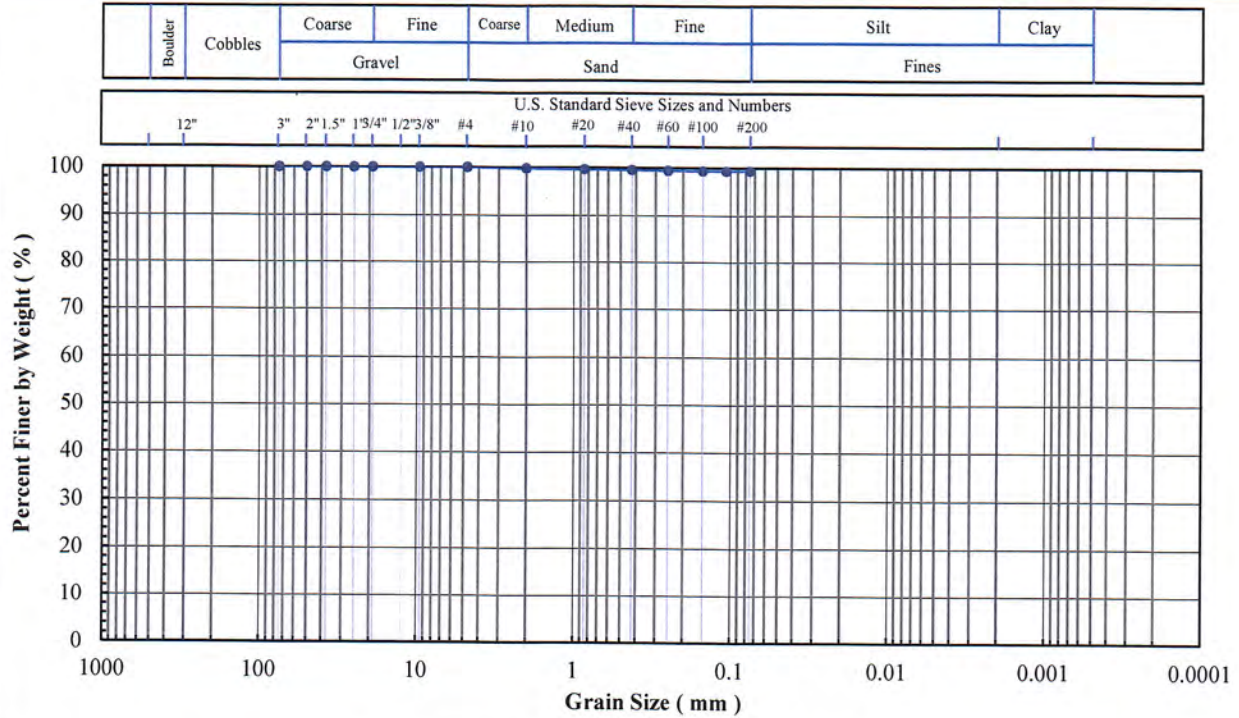

Sieve No.	Size (mm)	% Finer
3"	75	100.0
2"	50	100.0
1.5"	37.5	100.0
1"	25	100.0
3/4"	19	100.0
3/8"	9.5	100.0
#4	4.75	100.0
#10	2.00	99.8
#20	0.850	99.6
#40	0.425	99.5
#60	0.250	99.4
#100	0.150	99.3
#140	0.106	99.3
#200	0.075	99.3

Hydrometer Particle Diameter (mm)	% Finer

Gravel (%):	
Sand (%):	0.7
Fines (%):	99.3
Silt (%):	
Clay (%):	

Coeff. Unif. (Cu):	
Coeff. Curv. (Cc):	

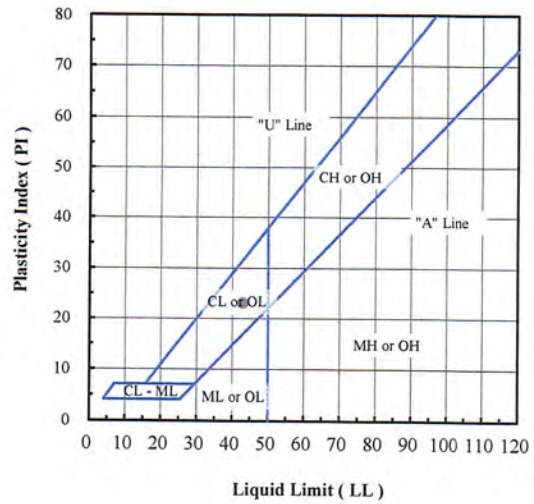

Specific Gravity (-):

Org. Content (%):

Carbon. Content (%):

Client Sample ID.	Lab Sample No.	Moisture Content (%)	Fines Content < No. 200 (%)	Atterberg Limits			Engineering Classification
				LL (-)	PL (-)	PI (-)	
B3-6 (25')	20L228	37.7	99.3	43	20	23	CL - Lean clay

Note(s):

01-25-2021
 AA, NSR



Excel Geotechnical Testing, Inc.
"Excellence in Testing"

953 Forrest Street, Roswell, Georgia 30075
Tel: (770) 910 7537, www.excelgeotesting.com

Project Name: Belle River ALD Support

Project No: PN1017

Client Sample ID: B3-10 (45')

Lab Sample No: 20L232

ASTM C136, D422, D854, D1140, D2216, D2487, D2974, D4318, D4373, D6913, D7928

SOIL INDEX PROPERTIES

Grain Size, Spec. Gravity, Moist. Cont., Eng. Classification, Organic Content, Atterberg Limits, Carbonate Content

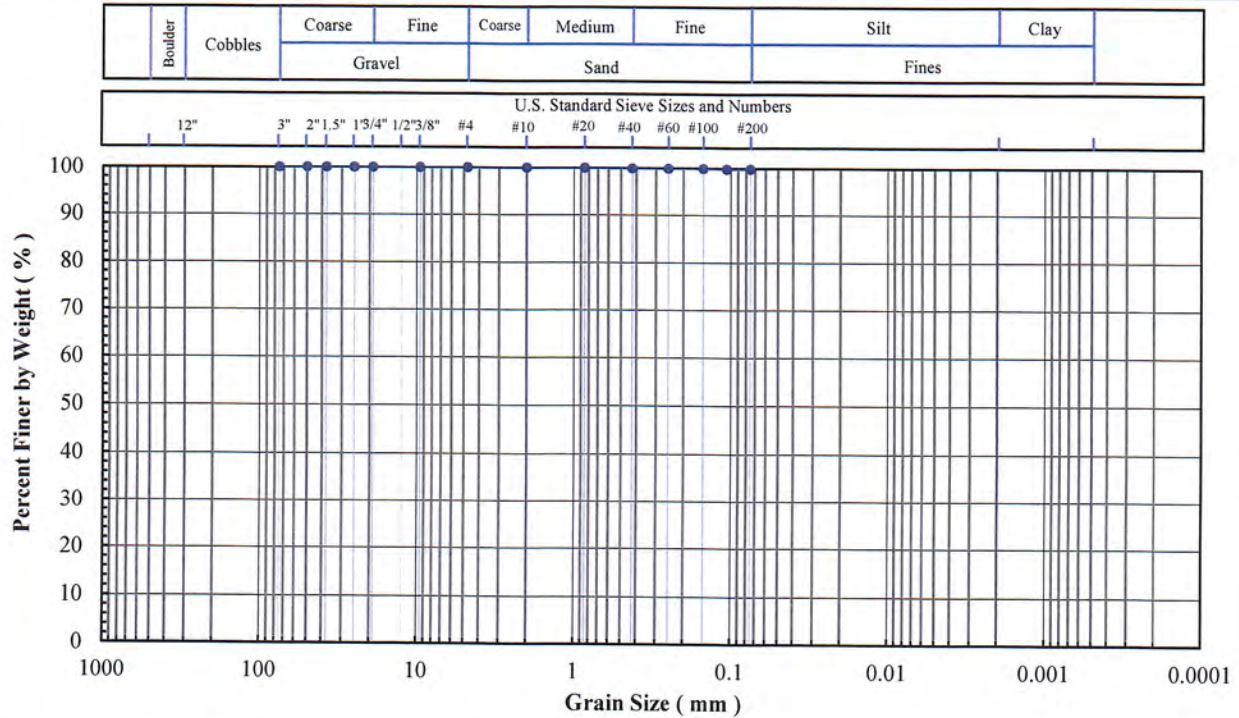

Sieve No.	Size (mm)	% Finer
3"	75	100.0
2"	50	100.0
1.5"	37.5	100.0
1"	25	100.0
3/4"	19	100.0
3/8"	9.5	100.0
#4	4.75	100.0
#10	2.00	100.0
#20	0.850	100.0
#40	0.425	99.9
#60	0.250	99.9
#100	0.150	99.9
#140	0.106	99.8
#200	0.075	99.8

Hydrometer Particle Diameter (mm)	% Finer

Gravel (%):	
Sand (%):	0.2
Fines (%):	99.8
Silt (%):	
Clay (%):	

Coeff. Unif. (Cu):	
Coeff. Curv. (Cc):	

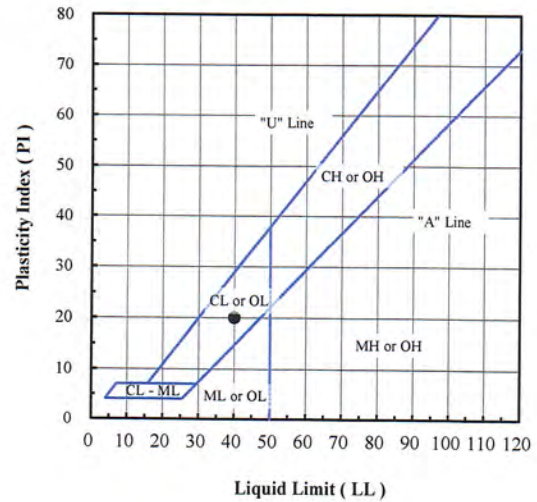

Specific Gravity (-):

Org. Content (%):

Carbon. Content (%):

Client Sample ID.	Lab Sample No.	Moisture Content (%)	Fines Content < No. 200 (%)	Atterberg Limits			Engineering Classification
				LL (-)	PL (-)	PI (-)	
B3-10 (45')	20L232	36.5	99.8	40	20	20	CL - Lean clay

Note(s):

*01-25-2021
AA, NSK*



Excel Geotechnical Testing, Inc.
"Excellence in Testing"

953 Forrest Street, Roswell, Georgia 30075
Tel: (770) 910 7537, www.excelgeotesting.com

Project Name: Belle River ALD Support
Project No: PN1017
Client Sample ID: B3-18 (85')
Lab Sample No: 20L240

ASTM C136, D422, D854, D1140, D2216, D2487, D2974, D4318, D4373, D6913, D7928

SOIL INDEX PROPERTIES

Grain Size, Spec. Gravity, Moist. Cont., Eng. Classification, Organic Content, Atterberg Limits, Carbonate Content

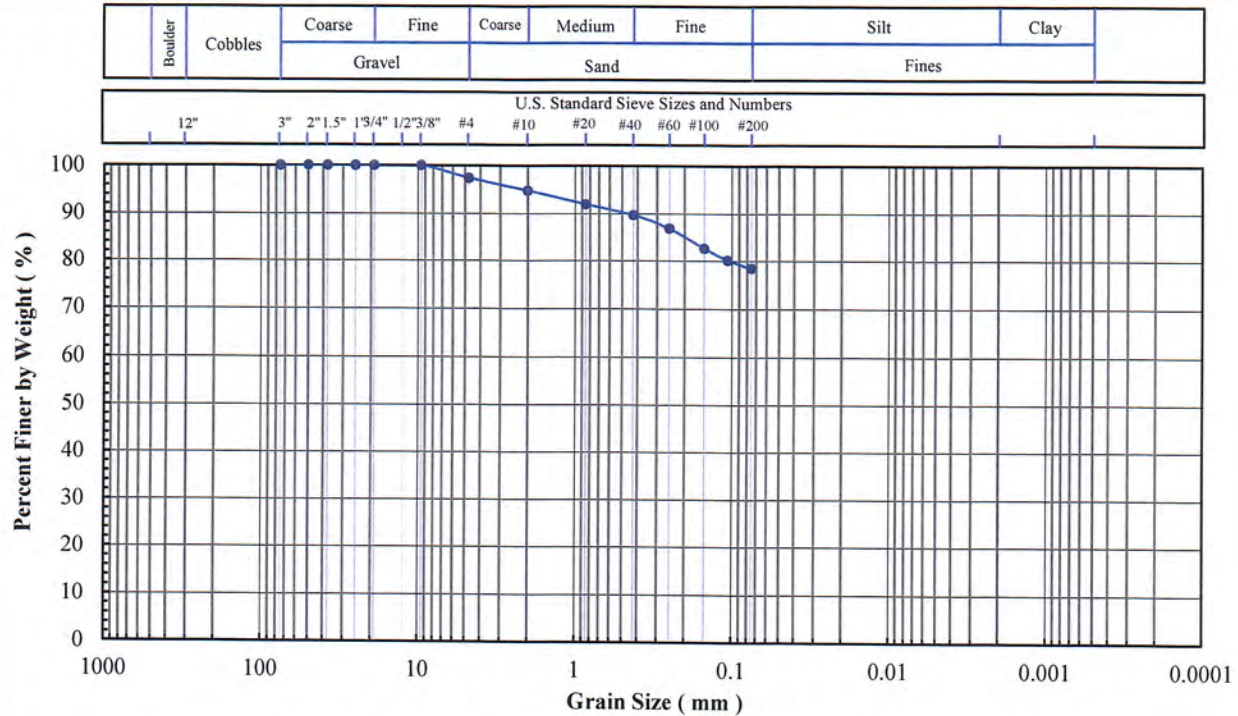

Sieve No.	Size (mm)	% Finer
3"	75	100.0
2"	50	100.0
1.5"	37.5	100.0
1"	25	100.0
3/4"	19	100.0
3/8"	9.5	100.0
#4	4.75	97.4
#10	2.00	94.8
#20	0.850	91.9
#40	0.425	89.7
#60	0.250	86.8
#100	0.150	82.6
#140	0.106	80.1
#200	0.075	78.4

Hydrometer Particle Diameter (mm)	% Finer

Gravel (%):	2.6
Sand (%):	19.0
Fines (%):	78.4
Silt (%):	
Clay (%):	

Coeff. Unif. (Cu):	
Coeff. Curv. (Cc):	

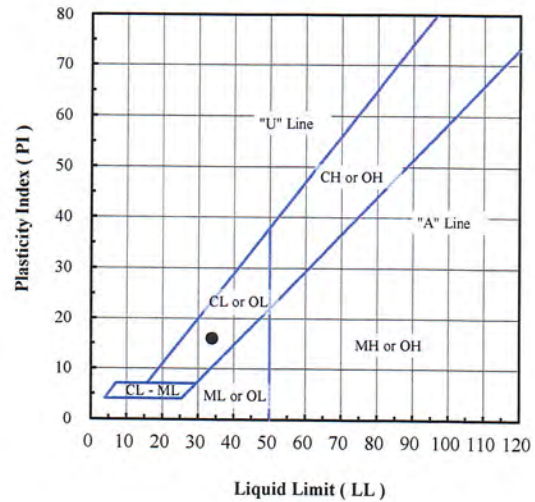

Specific Gravity (-):

Org. Content (%):

Carbon. Content (%):

Client Sample ID.	Lab Sample No.	Moisture Content (%)	Fines Content < No. 200 (%)	Atterberg Limits			Engineering Classification
				LL (-)	PL (-)	PI (-)	
B3-18 (85')	20L240	21.9	78.4	34	18	16	CL - Lean clay with sand

Note(s):

01-25-2021
AA1159



Excel Geotechnical Testing, Inc.
"Excellence in Testing"

953 Forrest Street, Roswell, Georgia 30075
 Tel: (770) 910 7537, www.excelgeotesting.com

Project Name: Bell River ALD Support
 Project No: PN1017
 Client Sample ID: B3-14 (67')
 Lab Sample No: 20L236

ASTM C136, D422, D854, D1140, D2216, D2487, D2974, D4318,
 D4373, D6913, D7928

SOIL INDEX PROPERTIES

Grain Size, Spec. Gravity, Moist. Cont.,
 Eng. Classification, Organic Content, Atterberg Limits, Carbonate Content

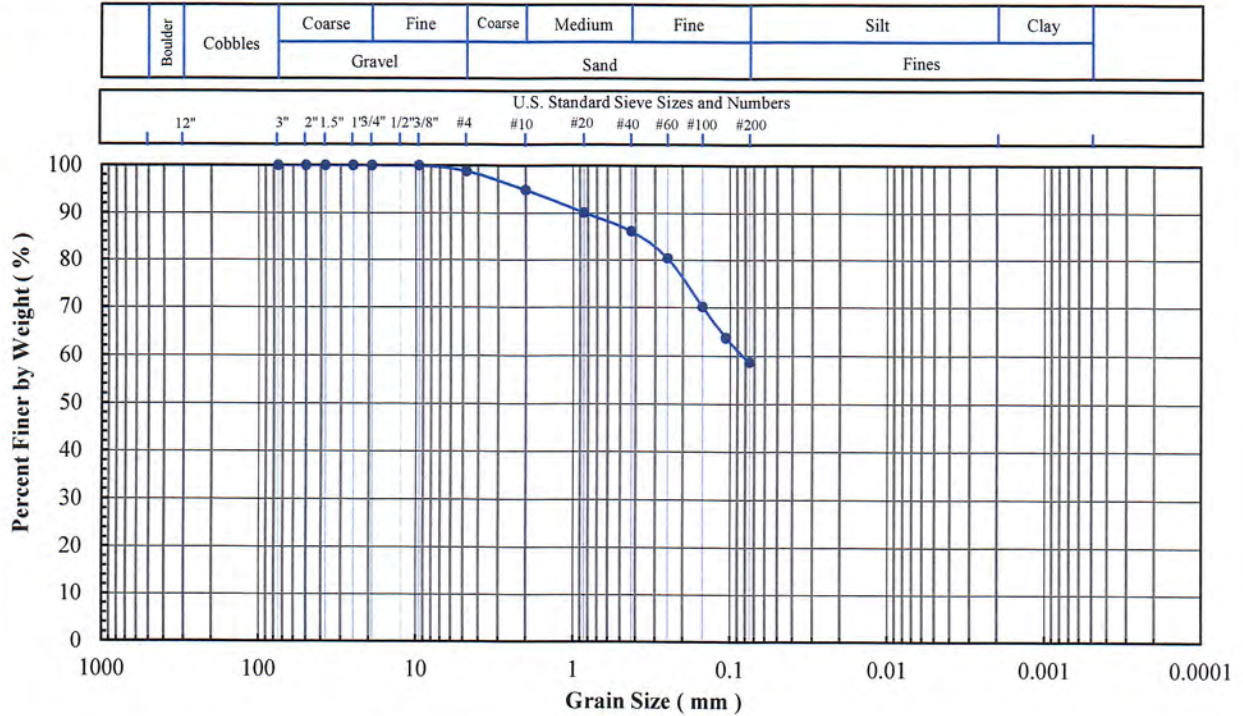

Sieve No.	Size (mm)	% Finer
3"	75	100.0
2"	50	100.0
1.5"	37.5	100.0
1"	25	100.0
3/4"	19	100.0
3/8"	9.5	100.0
#4	4.75	98.8
#10	2.00	94.9
#20	0.850	90.1
#40	0.425	86.2
#60	0.250	80.4
#100	0.150	70.1
#140	0.106	63.7
#200	0.075	58.6

Hydrometer Particle Diameter (mm)	% Finer

Gravel (%):	1.2
Sand (%):	40.2
Fines (%):	58.6
Silt (%):	
Clay (%):	

Coeff. Unif. (Cu):	
Coeff. Curv. (Cc):	

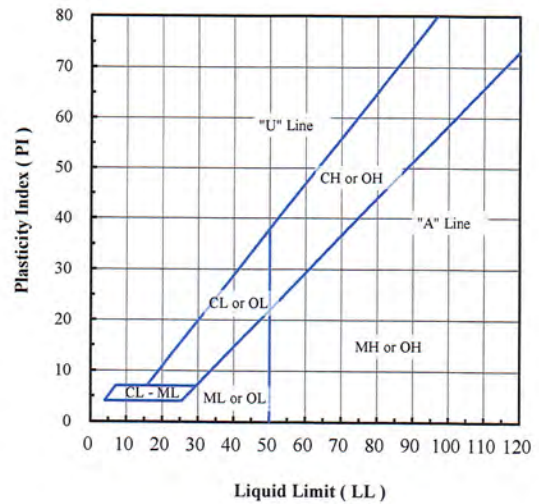

Specific Gravity (-):

Org. Content (%):

Carbon. Content (%):

Client Sample ID.	Lab Sample No.	Moisture Content (%)	Fines Content < No. 200 (%)	Atterberg Limits			Engineering Classification
				LL (-)	PL (-)	PI (-)	
B3-14 (67')	20L236	15.2	58.6				

Note(s):

02-03-2021
 AA, NSF



Excel Geotechnical Testing, Inc.
"Excellence in Testing"

953 Forrest Street, Roswell, Georgia 30075
Tel: (770) 910 7537, www.excelgeotesting.com

Project Name: Belle River ALD Support
Project No: PN1017
Client Sample ID: B4-1 (10')
Lab Sample No: 20L243

ASTM C136, D422, D854, D1140, D2216, D2487, D2974, D4318, D4373, D6913, D7928

SOIL INDEX PROPERTIES

Grain Size, Spec. Gravity, Moist. Cont., Eng. Classification, Organic Content, Atterberg Limits, Carbonate Content

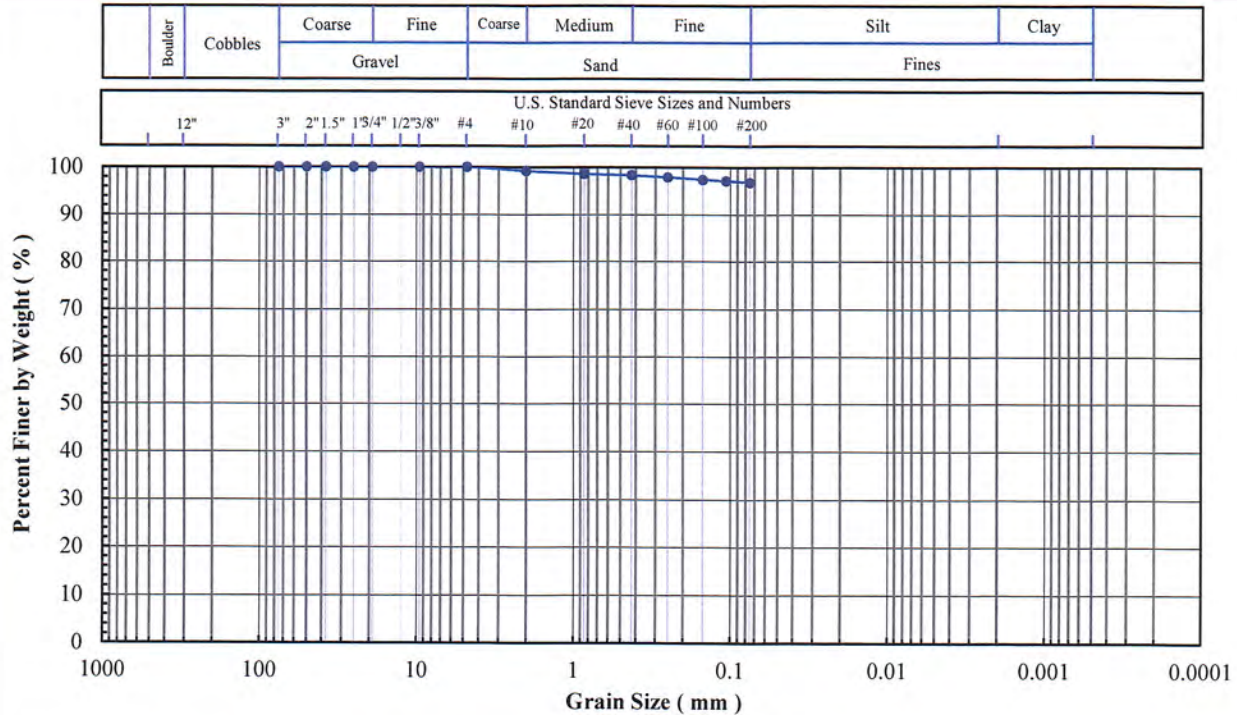

Sieve No.	Size (mm)	% Finer
3"	75	100.0
2"	50	100.0
1.5"	37.5	100.0
1"	25	100.0
3/4"	19	100.0
3/8"	9.5	100.0
#4	4.75	100.0
#10	2.00	99.2
#20	0.850	98.6
#40	0.425	98.3
#60	0.250	97.9
#100	0.150	97.4
#140	0.106	97.1
#200	0.075	96.8

Hydrometer Particle Diameter (mm)	% Finer

Gravel (%):	
Sand (%):	3.2
Fines (%):	96.8
Silt (%):	
Clay (%):	

Coeff. Unif. (Cu):	
Coeff. Curv. (Cc):	

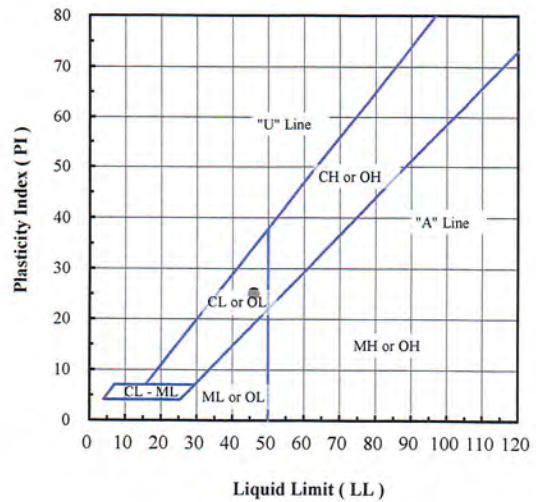

Specific Gravity (-):

Org. Content (%):

Carbon. Content (%):

Client Sample ID	Lab Sample No	Moisture Content (%)	Fines Content < No. 200 (%)	Atterberg Limits			Engineering Classification
				LL (-)	PL (-)	PI (-)	
B4-1 (10')	20L243	25.6	96.8	46	21	25	CL - Lean clay

Note(s):

01-25-2021
AA, NSR



Excel Geotechnical Testing, Inc.
"Excellence in Testing"

953 Forrest Street, Roswell, Georgia 30075
Tel: (770) 910 7537, www.excelgeotesting.com

Project Name: Belle River ALD Support

Project No: PN1017

Client Sample ID: B4-7 (34')

Lab Sample No: 20L249

ASTM C136, D422, D854, D1140, D2216, D2487, D2974, D4318, D4373, D6913, D7928

SOIL INDEX PROPERTIES

Grain Size, Spec. Gravity, Moist. Cont., Eng. Classification, Organic Content, Atterberg Limits, Carbonate Content

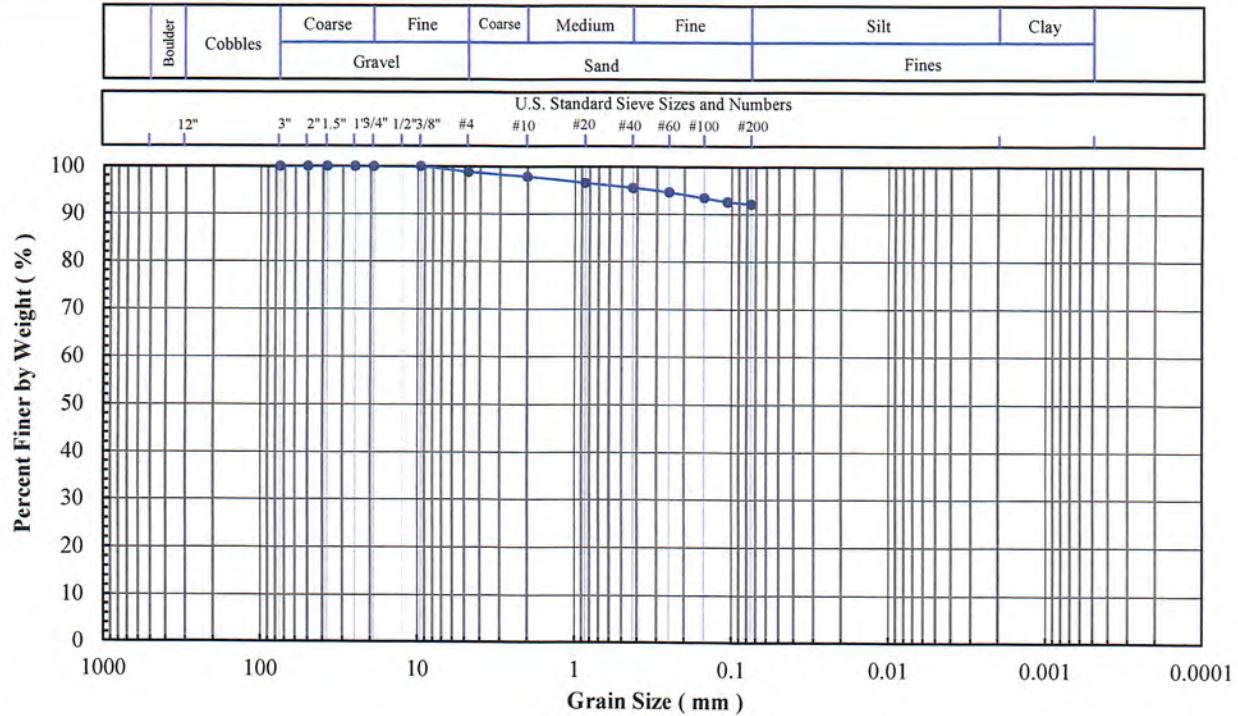

Sieve No.	Size (mm)	% Finer
3"	75	100.0
2"	50	100.0
1.5"	37.5	100.0
1"	25	100.0
3/4"	19	100.0
3/8"	9.5	100.0
#4	4.75	98.8
#10	2.00	97.8
#20	0.850	96.4
#40	0.425	95.4
#60	0.250	94.5
#100	0.150	93.3
#140	0.106	92.5
#200	0.075	92.0

Hydrometer Particle Diameter (mm)	% Finer

Gravel (%):	1.2
Sand (%):	6.8
Fines (%):	92.0
Silt (%):	
Clay (%):	

Coeff. Unif. (Cu):	
Coeff. Curv. (Cc):	

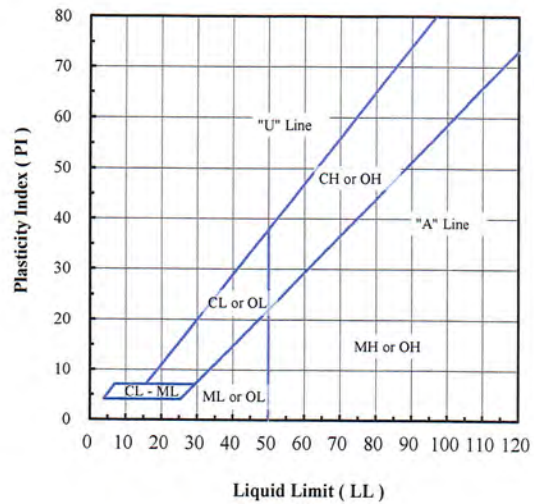

Specific Gravity (-):

Org. Content (%):

Carbon. Content (%):

Client Sample ID.	Lab Sample No.	Moisture Content (%)	Fines Content < No. 200 (%)	Atterberg Limits			Engineering Classification
				LL (-)	PL (-)	PI (-)	
B4-7 (34')	20L249	33.9	92.0				

Note(s):

01-25-2021
AA1 MSR



Excel Geotechnical Testing, Inc.
"Excellence in Testing"

953 Forrest Street, Roswell, Georgia 30075
Tel: (770) 910 7537, www.excelgeotesting.com

Project Name: Belle River ALD Support

Project No: PN1017

Client Sample ID: B4-12 (55')

Lab Sample No: 20L254

ASTM C136, D422, D854, D1140, D2216, D2487, D2974, D4318, D4373, D6913, D7928

SOIL INDEX PROPERTIES

Grain Size, Spec. Gravity, Moist. Cont., Eng. Classification, Organic Content, Atterberg Limits, Carbonate Content

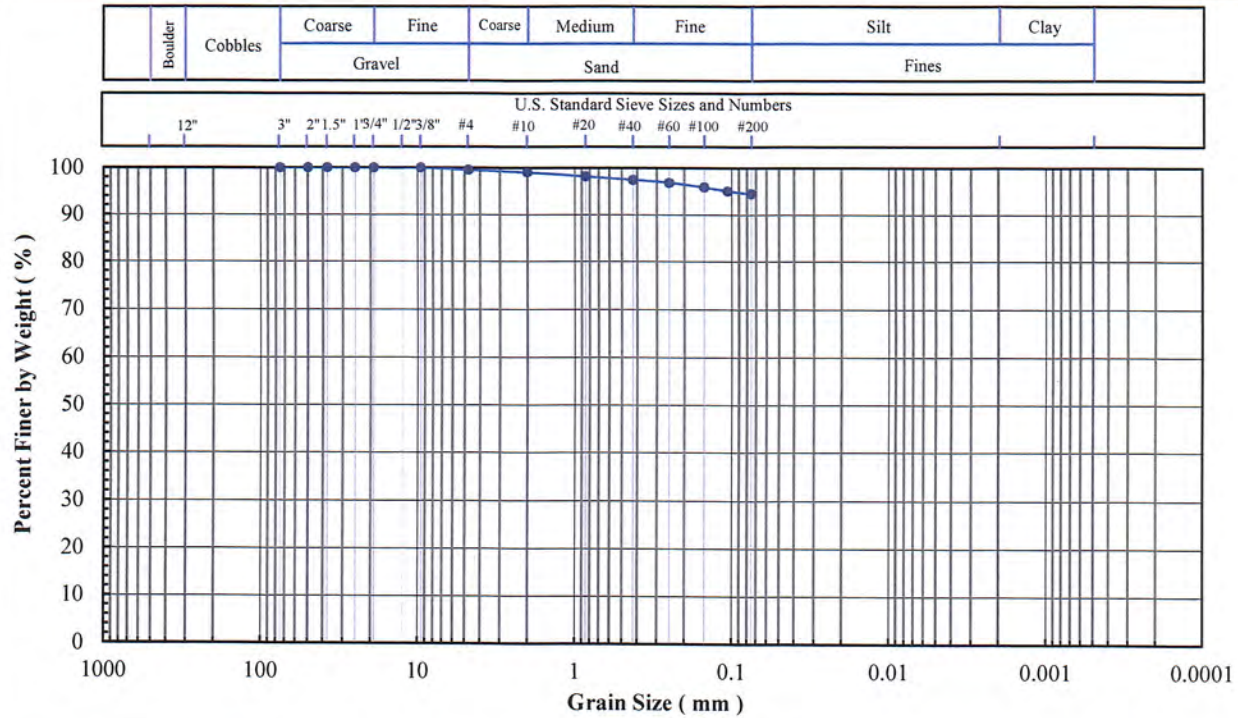

Sieve No.	Size (mm)	% Finer
3"	75	100.0
2"	50	100.0
1.5"	37.5	100.0
1"	25	100.0
3/4"	19	100.0
3/8"	9.5	100.0
#4	4.75	99.5
#10	2.00	99.0
#20	0.850	98.1
#40	0.425	97.4
#60	0.250	96.8
#100	0.150	95.8
#140	0.106	95.0
#200	0.075	94.4

Hydrometer Particle Diameter (mm)	% Finer

Gravel (%):	0.5
Sand (%):	5.1
Fines (%):	94.4
Silt (%):	
Clay (%):	

Coeff. Unif. (Cu):	
Coeff. Curv. (Cc):	

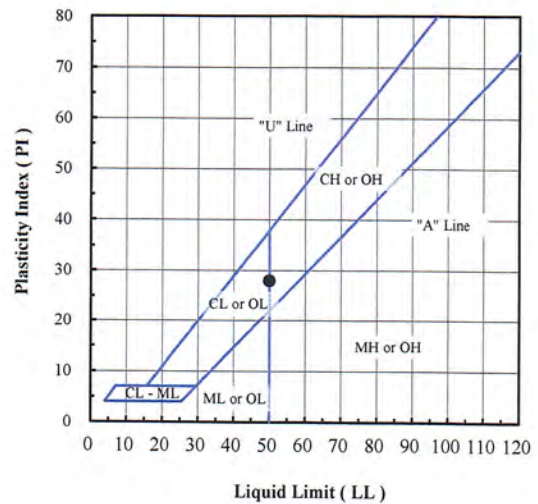

Specific Gravity (-):

Org. Content (%):

Carbon. Content (%):

Client Sample ID	Lab Sample No:	Moisture Content (%)	Fines Content < No. 200 (%)	Atterberg Limits			Engineering Classification
				LL (-)	PL (-)	PI (-)	
B4-12 (55')	20L254	41.4	94.4	50	22	28	CH - Fat clay

Note(s):

01-25-2021
AA1NSR



Excel Geotechnical Testing, Inc.
"Excellence in Testing"

953 Forrest Street, Roswell, Georgia 30075
Tel: (770) 910 7537, www.excelgeotesting.com

Project Name: Belle River ALD Support

Project No: PN1017

Client Sample ID: B4-16 (75')

Lab Sample No: 20L258

ASTM C136, D422, D854, D1140, D2216, D2487, D2974, D4318, D4373, D6913, D7928

SOIL INDEX PROPERTIES

Grain Size, Spec. Gravity, Moist. Cont., Eng. Classification, Organic Content, Atterberg Limits, Carbonate Content

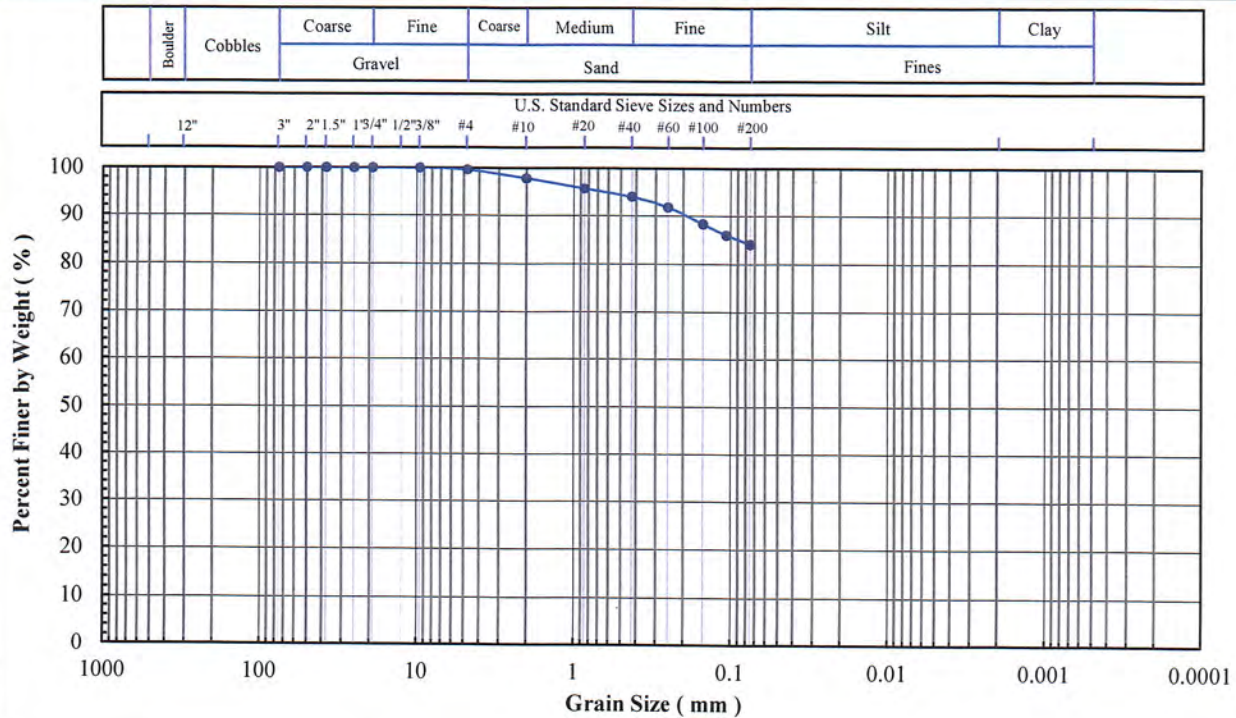

Sieve No.	Size (mm)	% Finer
3"	75	100.0
2"	50	100.0
1.5"	37.5	100.0
1"	25	100.0
3/4"	19	100.0
3/8"	9.5	100.0
#4	4.75	99.6
#10	2.00	97.8
#20	0.850	95.6
#40	0.425	93.9
#60	0.250	91.7
#100	0.150	88.2
#140	0.106	85.9
#200	0.075	84.0

Hydrometer Particle Diameter (mm)	% Finer

Gravel (%):	0.4
Sand (%):	15.6
Fines (%):	84.0
Silt (%):	
Clay (%):	

Coeff. Unif. (Cu):	
Coeff. Curv. (Cc):	

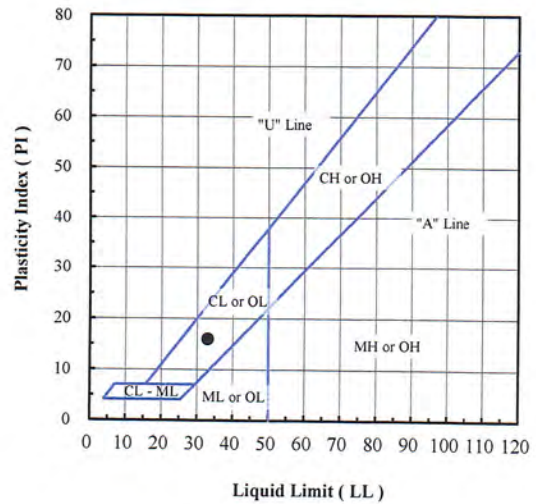

Specific Gravity (-):

Org. Content (%):

Carbon. Content (%):

Client Sample ID.	Lab Sample No:	Moisture Content (%)	Fines Content < No. 200 (%)	Atterberg Limits			Engineering Classification
				LL (-)	PL (-)	PI (-)	
B4-16 (75')	20L258	24.0	84.0	33	17	16	CL - Lean clay with sand

Note(s):

01-25-2021
AA, NJSR



Excel Geotechnical Testing, Inc.
"Excellence in Testing"

953 Forrest Street, Roswell, Georgia 30075
Tel: (770) 910 7537, www.excelgeotesting.com

Project Name: Belle River ALD Support
Project No: PN1017
Client Sample ID: B4-20 (95')
Lab Sample No: 20L262

ASTM C136, D422, D854, D1140, D2216, D2487, D2974, D4318, D4373, D6913, D7928

SOIL INDEX PROPERTIES

Grain Size, Spec. Gravity, Moist. Cont., Eng. Classification, Organic Content, Atterberg Limits, Carbonate Content

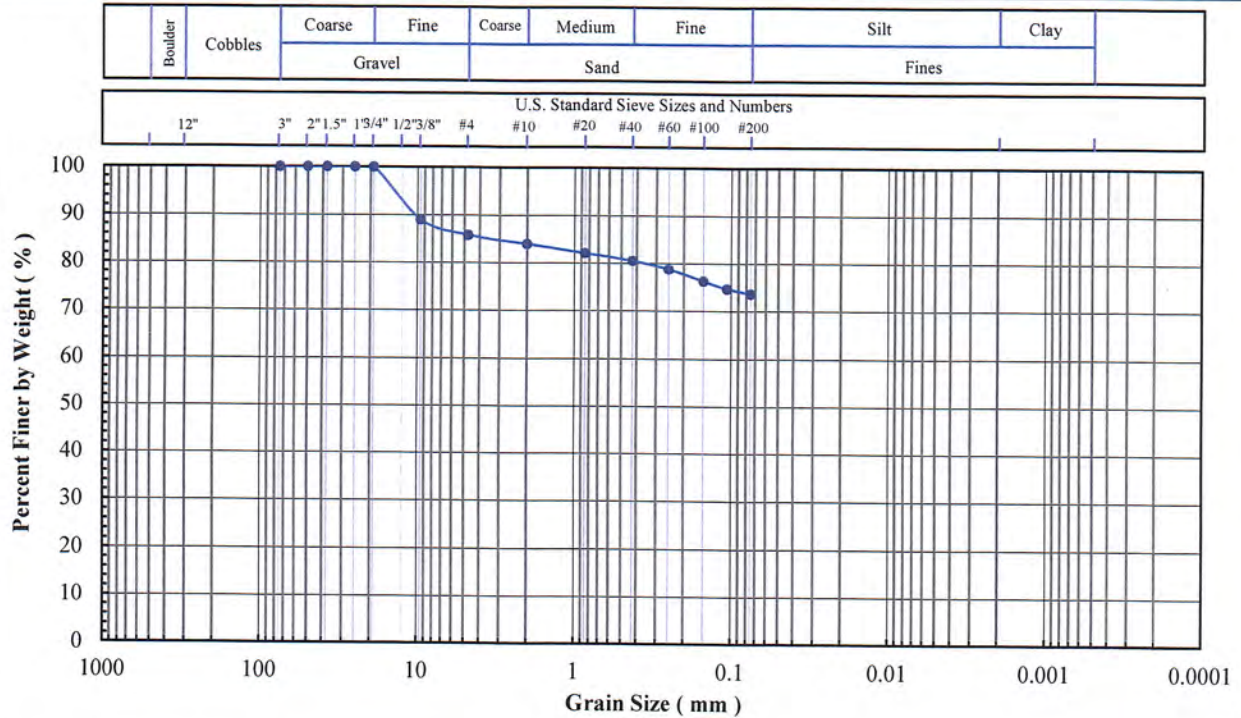

Sieve No.	Size (mm)	% Finer
3"	75	100
2"	50	100
1.5"	37.5	100
1"	25	100
3/4"	19	100
3/8"	9.5	89
#4	4.75	86
#10	2.00	84
#20	0.850	82
#40	0.425	81
#60	0.250	79
#100	0.150	76
#140	0.106	75
#200	0.075	74

Hydrometer Particle Diameter (mm)	% Finer

Gravel (%):	14
Sand (%):	12
Fines (%):	74
Silt (%):	
Clay (%):	

Coeff. Unif. (Cu):	
Coeff. Curv. (Cc):	

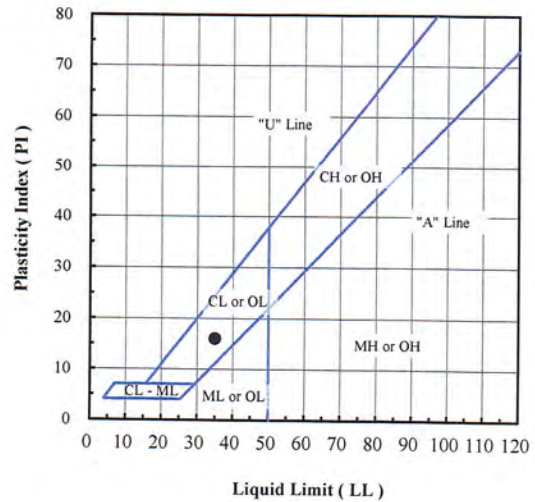

Specific Gravity (-):

Org. Content (%):

Carbon. Content (%):

Client Sample ID.	Lab Sample No.	Moisture Content (%)	Fines Content < No. 200 (%)	Atterberg Limits			Engineering Classification
				LL (-)	PL (-)	PI (-)	
B4-20 (95')	20L262	21.7	74	35	19	16	CL - Lean clay with gravel

Note(s): Sieve specimen was undersized.

01-25-2021
AA1 JSR



Excel Geotechnical Testing, Inc.
 "Excellence in Testing"

953 Forrest Street, Roswell, Georgia 30075
 Tel: (770) 910 7537, www.excelgeotesting.com

Project Name: Belle River ALD Support

Project No: PN1017

Client Sample ID: B5-1 (7')

Lab Sample No: 20L263

ASTM C136, D422, D854, D1140, D2216, D2487, D2974, D4318, D4373, D6913, D7928

SOIL INDEX PROPERTIES

Grain Size, Spec. Gravity, Moist. Cont., Eng. Classification, Organic Content, Atterberg Limits, Carbonate Content

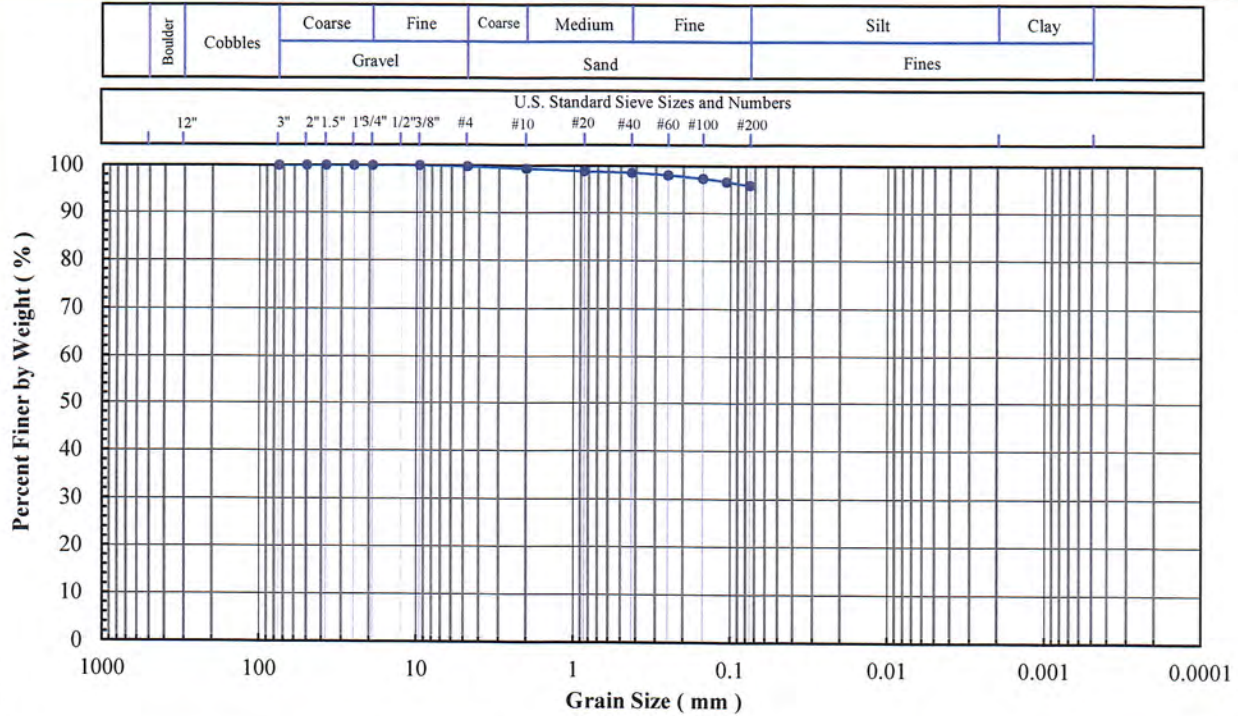

Sieve No.	Size (mm)	% Finer
3"	75	100.0
2"	50	100.0
1.5"	37.5	100.0
1"	25	100.0
3/4"	19	100.0
3/8"	9.5	100.0
#4	4.75	99.8
#10	2.00	99.3
#20	0.850	98.8
#40	0.425	98.5
#60	0.250	98.0
#100	0.150	97.3
#140	0.106	96.6
#200	0.075	95.8

Hydrometer Particle Diameter (mm)	% Finer

Gravel (%):	0.2
Sand (%):	4.0
Fines (%):	95.8
Silt (%):	
Clay (%):	

Coeff. Unif. (Cu):	
Coeff. Curv. (Cc):	

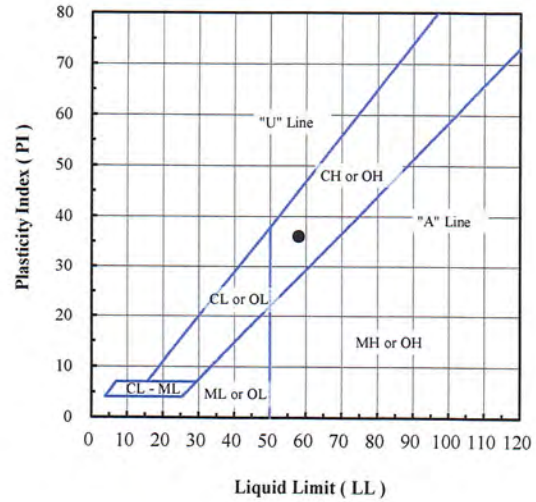

Specific Gravity (-):

Org. Content (%):

Carbon. Content (%):

Client Sample ID.	Lab Sample No:	Moisture Content (%)	Fines Content < No. 200 (%)	Atterberg Limits			Engineering Classification
				LL (-)	PL (-)	PI (-)	
B5-1 (7')	20L263	35.7	95.8	58	22	36	CH - Fat clay

Note(s):

01-25-2021
 AA, NSR



Excel Geotechnical Testing, Inc.
"Excellence in Testing"

953 Forrest Street, Roswell, Georgia 30075
Tel: (770) 910 7537, www.excelgeotesting.com

Project Name: Belle River ALD Support
Project No: PN1017
Client Sample ID: B5-4 (29')
Lab Sample No: 20L266

ASTM C136, D422, D854, D1140, D2216, D2487, D2974, D4318, D4373, D6913, D7928

SOIL INDEX PROPERTIES

Grain Size, Spec. Gravity, Moist. Cont., Eng. Classification, Organic Content, Atterberg Limits, Carbonate Content

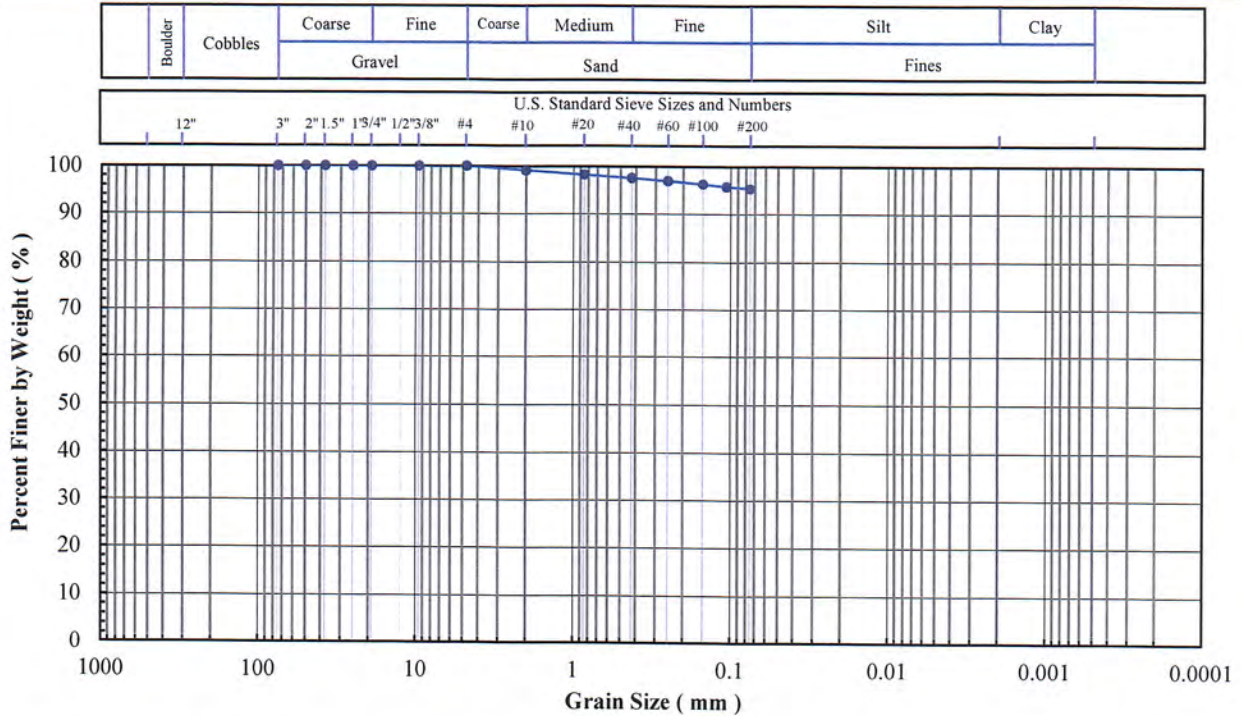

Sieve No.	Size (mm)	% Finer
3"	75	100.0
2"	50	100.0
1.5"	37.5	100.0
1"	25	100.0
3/4"	19	100.0
3/8"	9.5	100.0
#4	4.75	100.0
#10	2.00	99.1
#20	0.850	98.2
#40	0.425	97.5
#60	0.250	96.9
#100	0.150	96.2
#140	0.106	95.7
#200	0.075	95.3

Hydrometer Particle Diameter (mm)	% Finer

Gravel (%):	
Sand (%):	4.7
Fines (%):	95.3
Silt (%):	
Clay (%):	

Coeff. Unif. (Cu):	
Coeff. Curv. (Cc):	

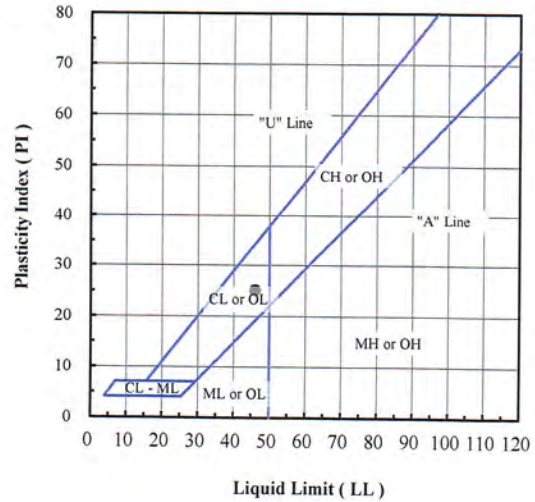

Specific Gravity (-):

Org. Content (%):

Carbon. Content (%):

Client Sample ID.	Lab Sample No.	Moisture Content (%)	Fines Content < No. 200 (%)	Atterberg Limits			Engineering Classification
				LL (-)	PL (-)	PI (-)	
B5-4 (29')	20L266	39.1	95.3	46	21	25	CL - Lean clay

Note(s):

01-25-2021
AA, MSR



Excel Geotechnical Testing, Inc.

"Excellence in Testing"

953 Forrest Street, Roswell, Georgia 30075
Tel: (770) 910 7537, www.excelgeotesting.com

Project Name: Belle River ALD Support

Project No: PN1017

Client Sample ID: B5-9 (52')

Lab Sample No: 20L271

ASTM C136, D422, D854, D1140, D2216, D2487, D2974, D4318, D4373, D6913, D7928

SOIL INDEX PROPERTIES

Grain Size, Spec. Gravity, Moist. Cont., Eng. Classification, Organic Content, Atterberg Limits, Carbonate Content

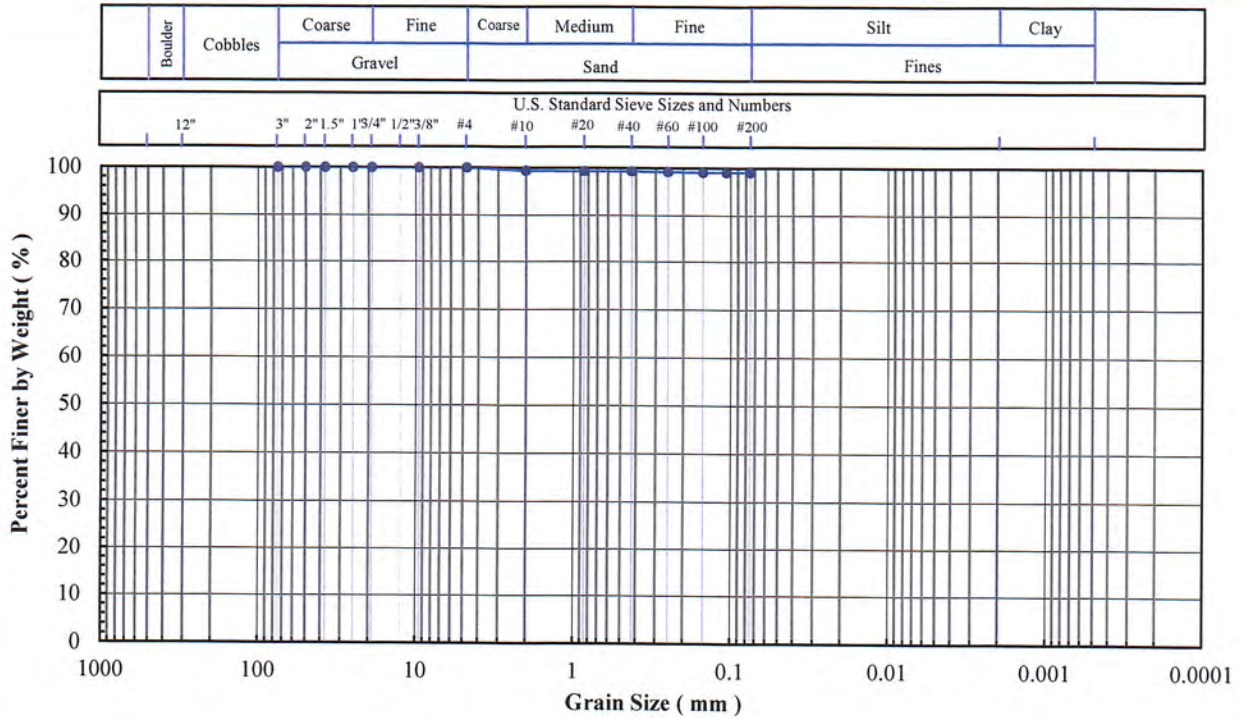

Sieve No.	Size (mm)	% Finer
3"	75	100.0
2"	50	100.0
1.5"	37.5	100.0
1"	25	100.0
3/4"	19	100.0
3/8"	9.5	100.0
#4	4.75	100.0
#10	2.00	99.4
#20	0.850	99.3
#40	0.425	99.3
#60	0.250	99.2
#100	0.150	99.1
#140	0.106	99.1
#200	0.075	99.1

Hydrometer Particle Diameter (mm)	% Finer

Gravel (%):	
Sand (%):	0.9
Fines (%):	99.1
Silt (%):	
Clay (%):	

Coeff. Unif. (Cu):	
Coeff. Curv. (Cc):	

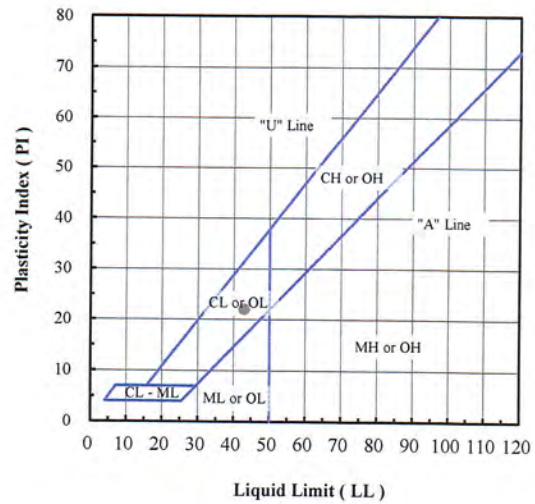

Specific Gravity (-):	
-----------------------	--

Org. Content (%):	
-------------------	--

Carbon. Content (%):	
----------------------	--

Client Sample ID.	Lab Sample No.	Moisture Content (%)	Fines Content < No. 200 (%)	Atterberg Limits			Engineering Classification
				LL (-)	PL (-)	PI (-)	
B5-9 (52')	20L271	40.2	99.1	43	21	22	CL - Lean clay

Note(s):

01-25-2021
AA, MSR



Excel Geotechnical Testing, Inc.
"Excellence in Testing"

953 Forrest Street, Roswell, Georgia 30075
Tel: (770) 910 7537, www.excelgeotesting.com

Project Name: Belle River ALD Support
Project No: PN1017
Client Sample ID: B5-13 (72')
Lab Sample No: 20L275

ASTM C136, D422, D854, D1140, D2216, D2487, D2974, D4318, D4373, D6913, D7928

SOIL INDEX PROPERTIES

Grain Size, Spec. Gravity, Moist. Cont., Eng. Classification, Organic Content, Atterberg Limits, Carbonate Content

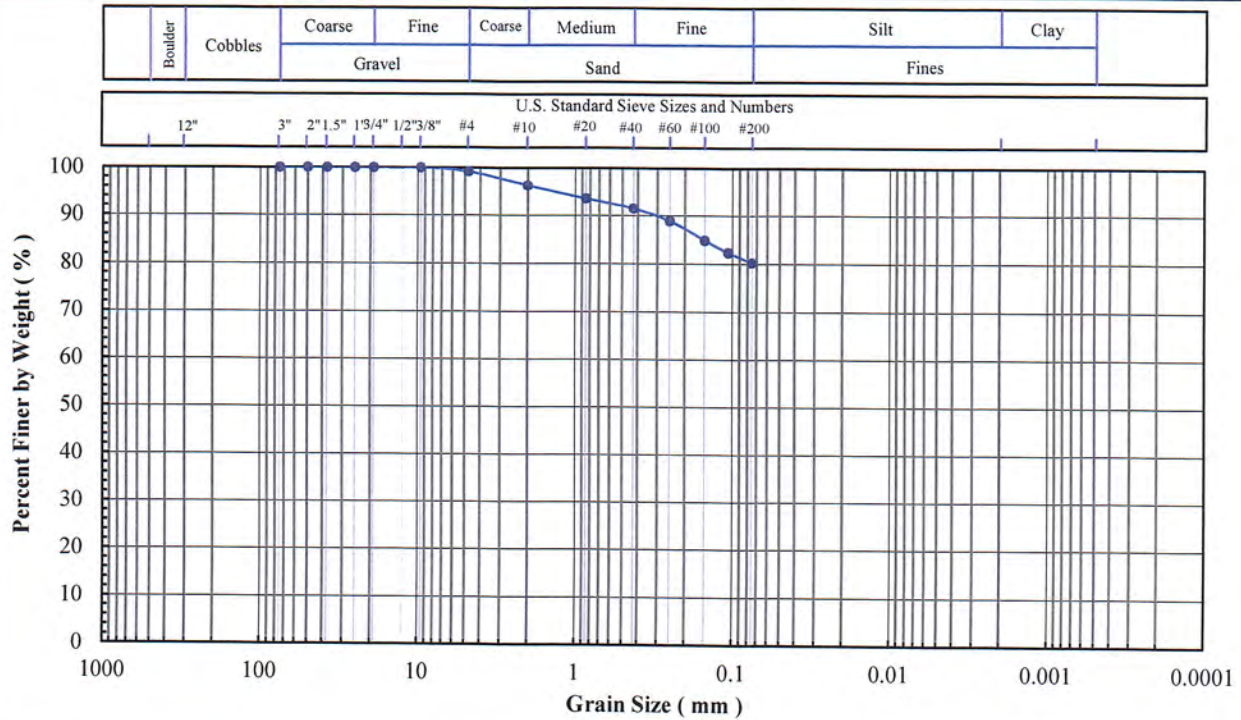

Sieve No.	Size (mm)	% Finer
3"	75	100.0
2"	50	100.0
1.5"	37.5	100.0
1"	25	100.0
3/4"	19	100.0
3/8"	9.5	100.0
#4	4.75	99.2
#10	2.00	96.2
#20	0.850	93.5
#40	0.425	91.4
#60	0.250	88.8
#100	0.150	84.8
#140	0.106	82.3
#200	0.075	80.2

Hydrometer Particle Diameter (mm)	% Finer

Gravel (%):	0.8
Sand (%):	19.0
Fines (%):	80.2
Silt (%):	
Clay (%):	

Coeff. Unif. (Cu):	
Coeff. Curv. (Cc):	

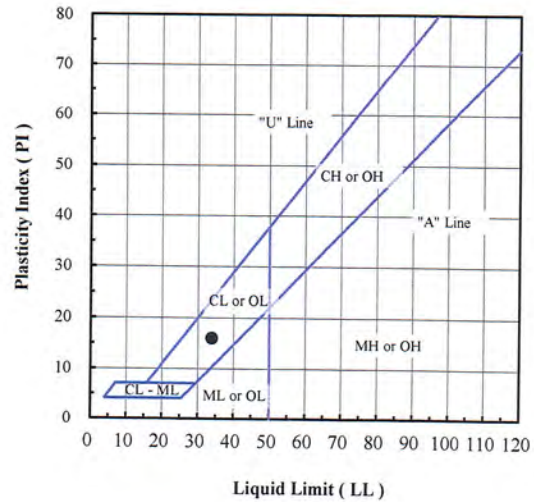

Specific Gravity (-):

Org. Content (%):

Carbon. Content (%):

Client Sample ID.	Lab Sample No.	Moisture Content (%)	Fines Content < No. 200 (%)	Atterberg Limits			Engineering Classification
				LL (-)	PL (-)	PI (-)	
B5-13 (72')	20L275	27.1	80.2	34	18	16	CL - Lean clay with sand

Note(s):

01-25-2021
AA1, NSR



Excel Geotechnical Testing, Inc.
 "Excellence in Testing"

953 Forrest Street, Roswell, Georgia 30075
 Tel: (770) 910 7537, www.excelgeotesting.com

Project Name: Belle River ALD Support

Project No: PN1017

Client Sample ID: B5-17 (92')

Lab Sample No: 20L279

ASTM C136, D422, D854, D1140, D2216, D2487, D2974, D4318, D4373, D6913, D7928

SOIL INDEX PROPERTIES

Grain Size, Spec. Gravity, Moist. Cont., Eng. Classification, Organic Content, Atterberg Limits, Carbonate Content

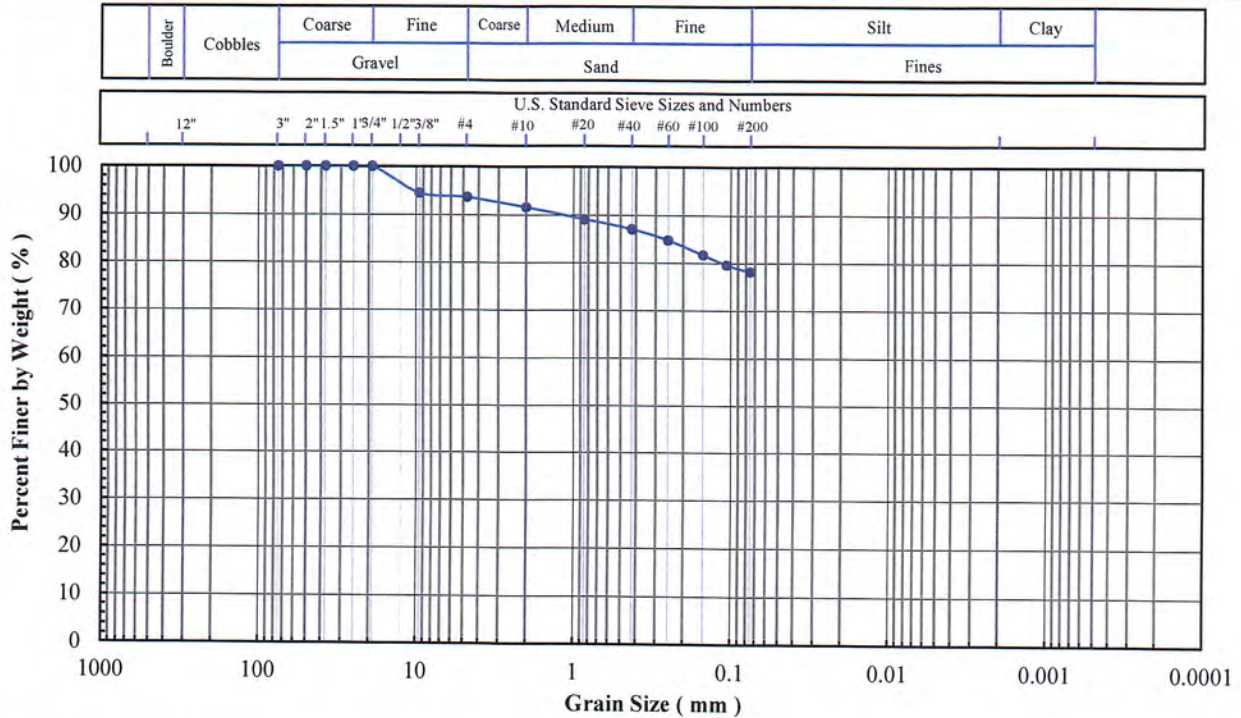

Sieve No.	Size (mm)	% Finer
3"	75	100
2"	50	100
1.5"	37.5	100
1"	25	100
3/4"	19	100
3/8"	9.5	95
#4	4.75	94
#10	2.00	92
#20	0.850	89
#40	0.425	87
#60	0.250	85
#100	0.150	82
#140	0.106	80
#200	0.075	78

Hydrometer Particle Diameter (mm)	% Finer

Gravel (%):	6
Sand (%):	16
Fines (%):	78
Silt (%):	
Clay (%):	

Coeff. Unif. (Cu):	
Coeff. Curv. (Cc):	

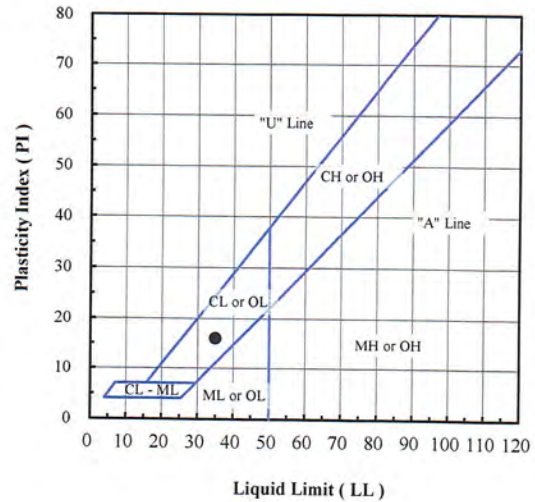

Specific Gravity (-):

Org. Content (%):

Carbon. Content (%):

Client Sample ID.	Lab Sample No.	Moisture Content (%)	Fines Content < No. 200 (%)	Atterberg Limits			Engineering Classification
				LL (-)	PL (-)	PI (-)	
B5-17 (92')	20L279	22.0	78	35	19	16	CL - Lean clay with sand

Note(s): Sieve specimen was undersized.

01-25-2021
AA, MSR



Excel Geotechnical Testing, Inc.
"Excellence in Testing"

953 Forrest Street, Roswell, Georgia 30075
Tel: (770) 910 7537, www.excelgeotesting.com

Project Name: Belle River ALD Support

Project No: PN1017

Client Sample ID: B6-3 (15')

Lab Sample No: 20L284

ASTM C136, D422, D854, D1140, D2216, D2487, D2974, D4318, D4373, D6913, D7928

SOIL INDEX PROPERTIES

Grain Size, Spec. Gravity, Moist. Cont., Eng. Classification, Organic Content, Atterberg Limits, Carbonate Content

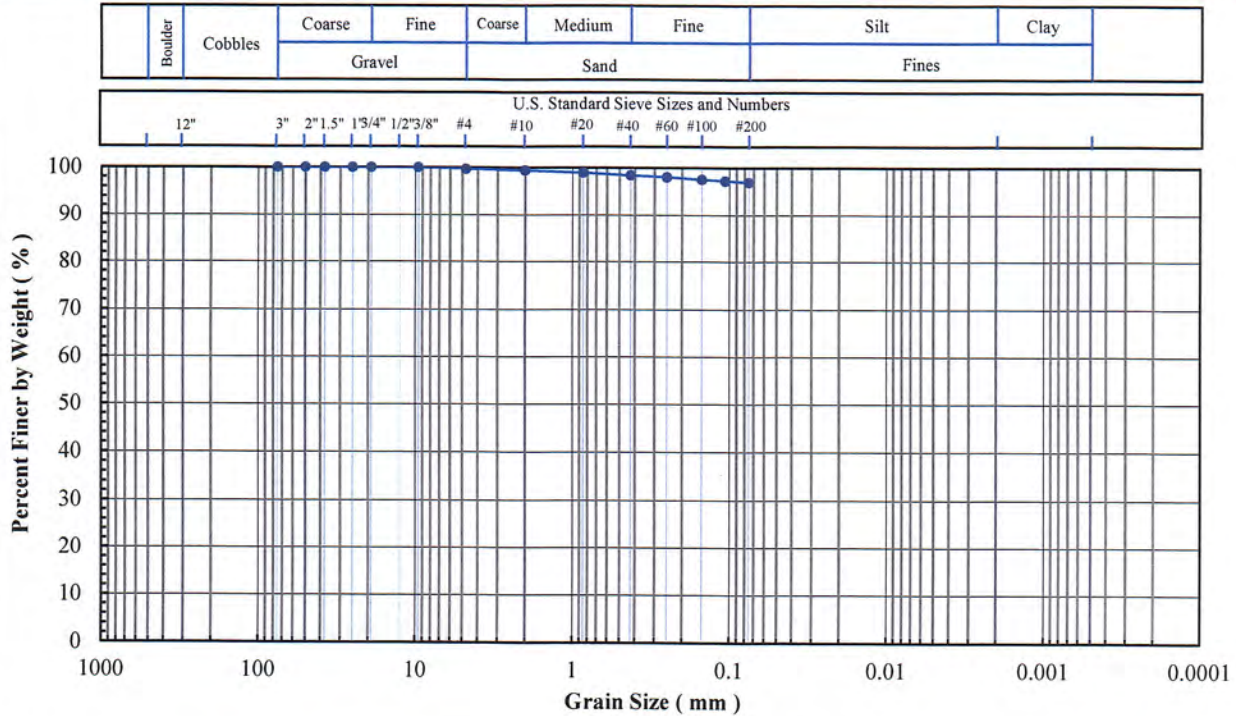

Sieve No.	Size (mm)	% Finer
3"	75	100.0
2"	50	100.0
1.5"	37.5	100.0
1"	25	100.0
3/4"	19	100.0
3/8"	9.5	100.0
#4	4.75	99.7
#10	2.00	99.4
#20	0.850	98.9
#40	0.425	98.4
#60	0.250	98.0
#100	0.150	97.5
#140	0.106	97.2
#200	0.075	96.9

Hydrometer Particle Diameter (mm)	% Finer

Gravel (%):	0.3
Sand (%):	2.8
Fines (%):	96.9
Silt (%):	
Clay (%):	

Coeff. Unif. (Cu):	
Coeff. Curv. (Cc):	

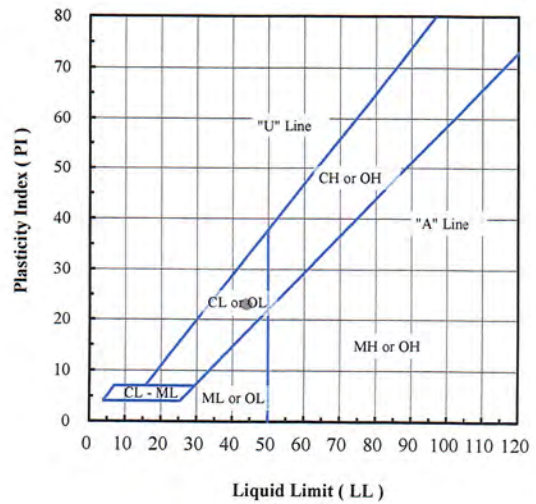

Specific Gravity (-):

Org. Content (%):

Carbon. Content (%):

Client Sample ID	Lab Sample No:	Moisture Content (%)	Fines Content < No. 200 (%)	Atterberg Limits			Engineering Classification
				LL (-)	PL (-)	PI (-)	
B6-3 (15')	20L284	36.7	96.9	44	21	23	CL - Lean clay

Note(s):

*01-26-2021
AA, NSR*



Excel Geotechnical Testing, Inc.
"Excellence in Testing"

953 Forrest Street, Roswell, Georgia 30075
Tel: (770) 910 7537, www.excelgeotesting.com

Project Name: Belle River ALD Support

Project No: PN1017

Client Sample ID: B6-7 (35')

Lab Sample No: 20L288

ASTM C136, D422, D854, D1140, D2216, D2487, D2974, D4318, D4373, D6913, D7928

SOIL INDEX PROPERTIES

Grain Size, Spec. Gravity, Moist. Cont., Eng. Classification, Organic Content, Atterberg Limits, Carbonate Content

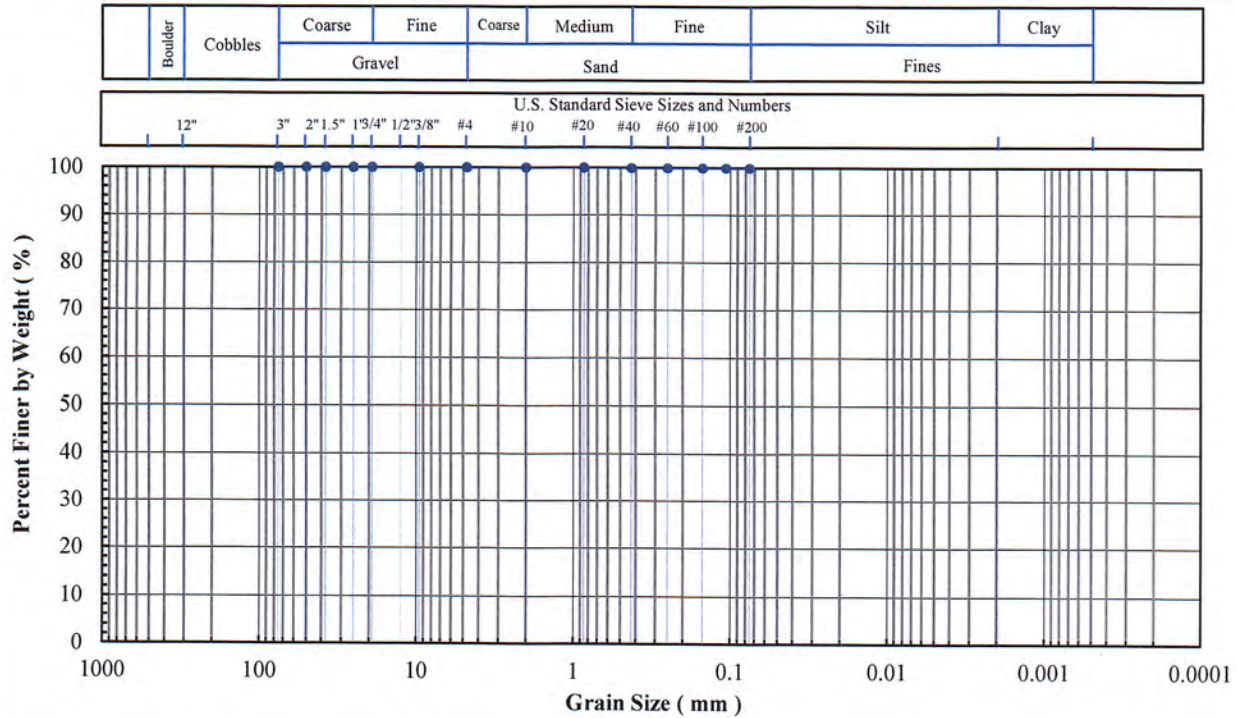

Sieve No.	Size (mm)	% Finer
3"	75	100.0
2"	50	100.0
1.5"	37.5	100.0
1"	25	100.0
3/4"	19	100.0
3/8"	9.5	100.0
#4	4.75	100.0
#10	2.00	100.0
#20	0.850	100.0
#40	0.425	99.9
#60	0.250	99.9
#100	0.150	99.9
#140	0.106	99.9
#200	0.075	99.9

Hydrometer Particle Diameter (mm)	% Finer

Gravel (%):	
Sand (%):	0.1
Fines (%):	99.9
Silt (%):	
Clay (%):	

Coeff. Unif. (Cu):	
Coeff. Curv. (Cc):	

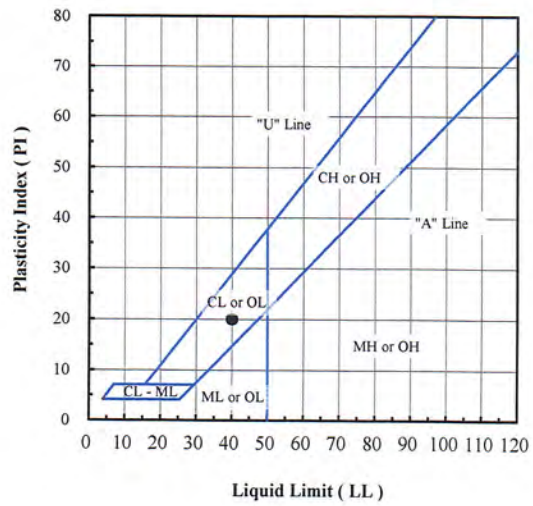

Specific Gravity (-):

Org. Content (%):

Carbon. Content (%):

Client Sample ID.	Lab Sample No.	Moisture Content (%)	Fines Content < No. 200 (%)	Atterberg Limits			Engineering Classification
				LL (-)	PL (-)	PI (-)	
B6-7 (35')	20L288	37.8	99.9	40	20	20	CL - Lean clay

Note(s):

01-26-2021
AAI/NSR



Excel Geotechnical Testing, Inc.
"Excellence in Testing"

953 Forrest Street, Roswell, Georgia 30075
Tel: (770) 910 7537, www.excelgeotesting.com

Project Name: Belle River ALD Support
Project No: PN1017
Client Sample ID: B6-11 (55')
Lab Sample No: 20L292

ASTM C136, D422, D854, D1140, D2216, D2487, D2974, D4318, D4373, D6913, D7928

SOIL INDEX PROPERTIES

Grain Size, Spec. Gravity, Moist. Cont., Eng. Classification, Organic Content, Atterberg Limits, Carbonate Content

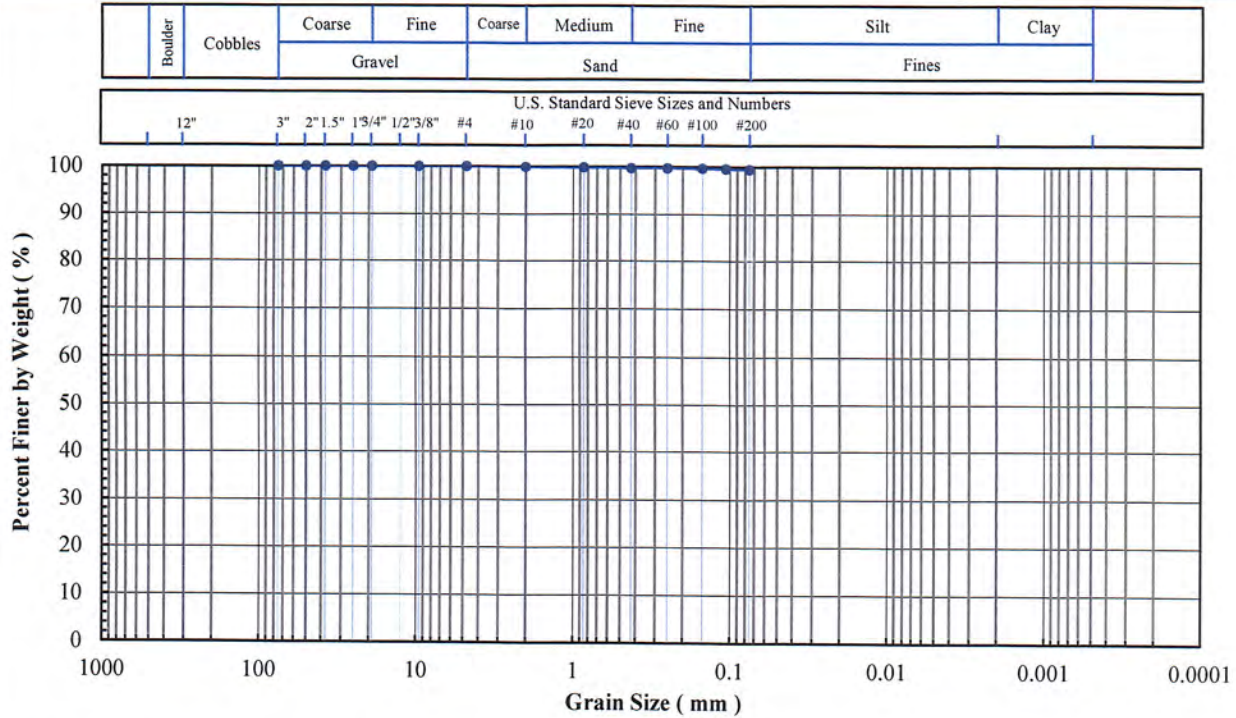

Sieve No.	Size (mm)	% Finer
3"	75	100.0
2"	50	100.0
1.5"	37.5	100.0
1"	25	100.0
3/4"	19	100.0
3/8"	9.5	100.0
#4	4.75	100.0
#10	2.00	99.9
#20	0.850	99.8
#40	0.425	99.7
#60	0.250	99.7
#100	0.150	99.6
#140	0.106	99.5
#200	0.075	99.4

Hydrometer Particle Diameter (mm)	% Finer

Gravel (%):	
Sand (%):	0.6
Fines (%):	99.4
Silt (%):	
Clay (%):	

Coeff. Unif. (Cu):	
Coeff. Curv. (Cc):	

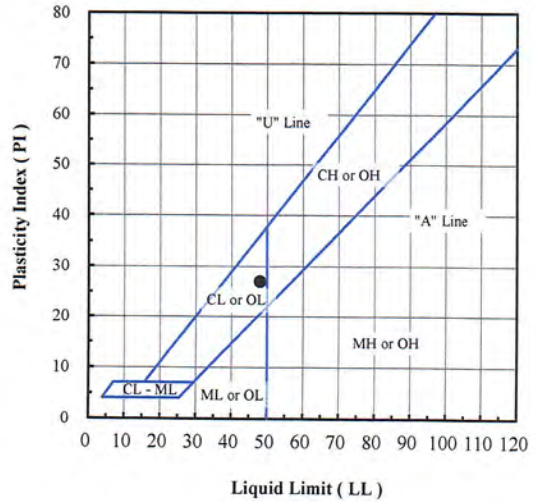

Specific Gravity (-):

Org. Content (%):

Carbon. Content (%):

Client Sample ID.	Lab Sample No:	Moisture Content (%)	Fines Content < No. 200 (%)	Atterberg Limits			Engineering Classification
				LL (-)	PL (-)	PI (-)	
B6-11 (55')	20L292	38.7	99.4	48	21	27	CL - Lean Clay

Note(s):

01-26-2021
AA, NSR



Excel Geotechnical Testing, Inc.
"Excellence in Testing"

953 Forrest Street, Roswell, Georgia 30075
Tel: (770) 910 7537, www.excelgeotesting.com

Project Name: Belle River ALD Support
Project No: PN1017
Client Sample ID: B6-15 (75')
Lab Sample No: 20L296

ASTM C136, D422, D854, D1140, D2216, D2487, D2974, D4318, D4373, D6913, D7928

SOIL INDEX PROPERTIES

Grain Size, Spec. Gravity, Moist. Cont., Eng. Classification, Organic Content, Atterberg Limits, Carbonate Content

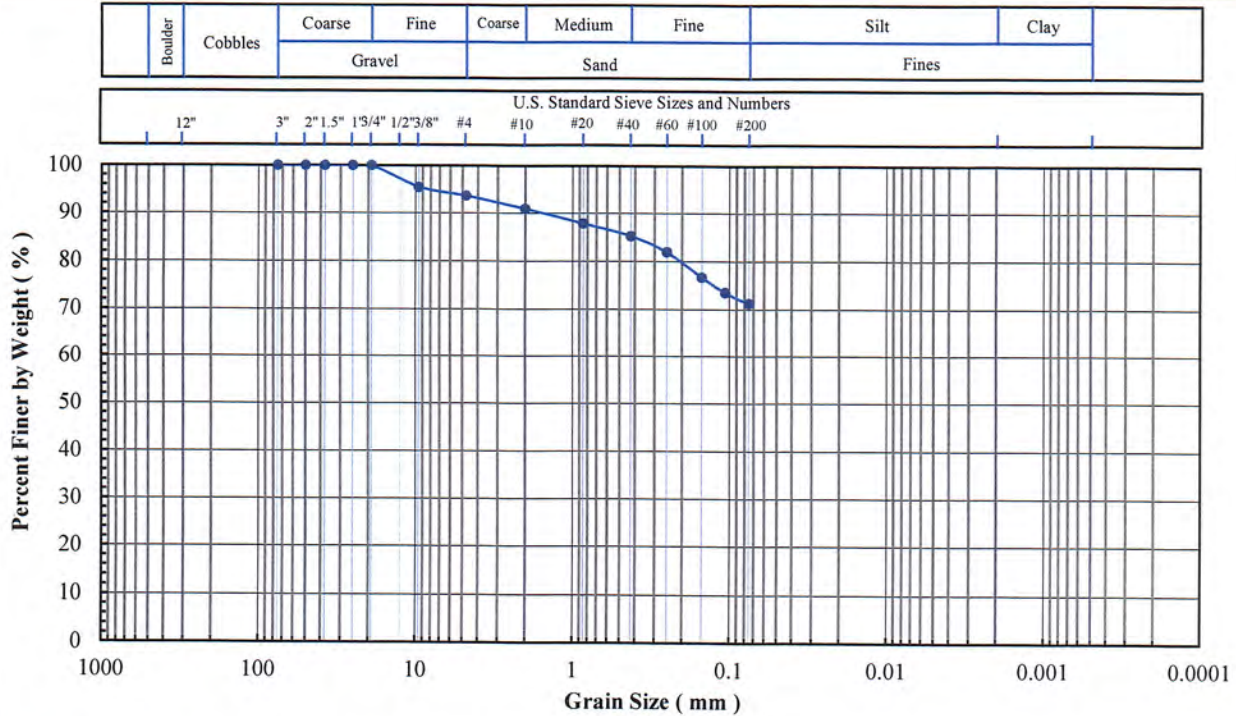

Sieve No.	Size (mm)	% Finer
3"	75	100
2"	50	100
1.5"	37.5	100
1"	25	100
3/4"	19	100
3/8"	9.5	95
#4	4.75	94
#10	2.00	91
#20	0.850	88
#40	0.425	85
#60	0.250	82
#100	0.150	77
#140	0.106	74
#200	0.075	71

Hydrometer Particle Diameter (mm)	% Finer

Gravel (%):	6
Sand (%):	23
Fines (%):	71
Silt (%):	
Clay (%):	

Coeff. Unif. (Cu):	
Coeff. Curv. (Cc):	

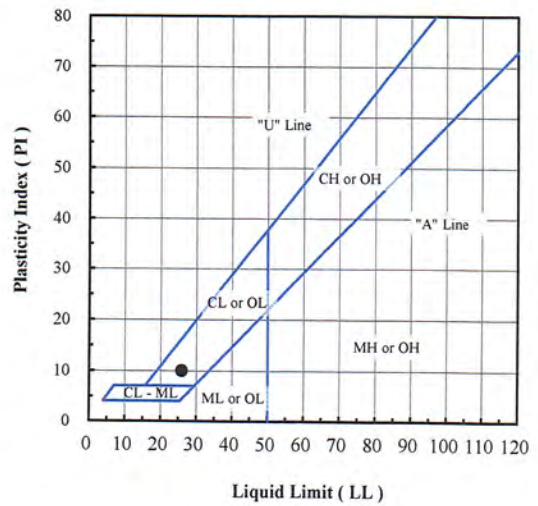

Specific Gravity (-):

Org. Content (%):

Carbon. Content (%):

Client Sample ID.	Lab Sample No.	Moisture Content (%)	Fines Content < No. 200 (%)	Atterberg Limits			Engineering Classification
				LL (-)	PL (-)	PI (-)	
B6-15 (75')	20L296	20.5	71	26	16	10	CL - Lean clay with sand

Note(s): Sieve specimen was undersized.

01-26-2021
AA, MSR



Excel Geotechnical Testing, Inc.
"Excellence in Testing"

953 Forrest Street, Roswell, Georgia 30075
Tel: (770) 910 7537, www.excelgeotesting.com

Project Name: Belle River ALD Support
Project No: PN1017
Client Sample ID: B6-19 (95')
Lab Sample No: 20L300

ASTM C136, D422, D854, D1140, D2216, D2487, D2974, D4318, D4373, D6913, D7928

SOIL INDEX PROPERTIES

Grain Size, Spec. Gravity, Moist. Cont., Eng. Classification, Organic Content, Atterberg Limits, Carbonate Content

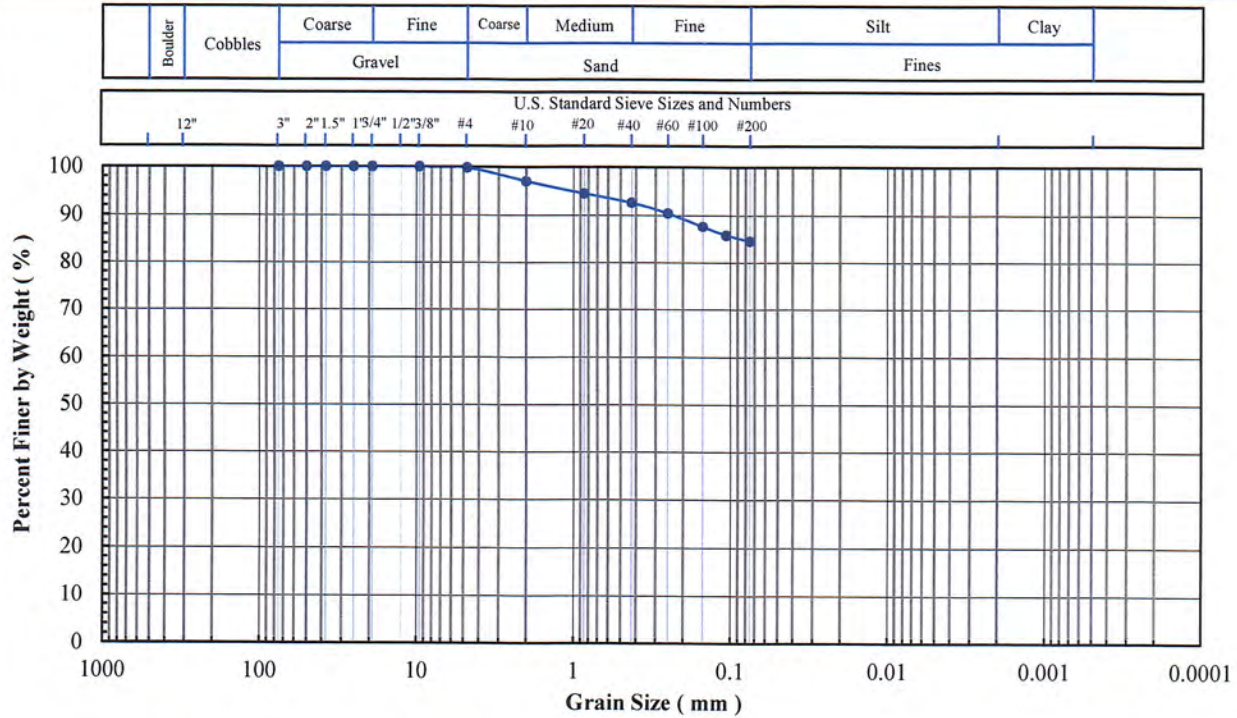

Sieve No.	Size (mm)	% Finer
3"	75	100.0
2"	50	100.0
1.5"	37.5	100.0
1"	25	100.0
3/4"	19	100.0
3/8"	9.5	100.0
#4	4.75	99.8
#10	2.00	97.0
#20	0.850	94.5
#40	0.425	92.6
#60	0.250	90.4
#100	0.150	87.6
#140	0.106	85.8
#200	0.075	84.6

Hydrometer Particle Diameter (mm)	% Finer

Gravel (%):	0.2
Sand (%):	15.2
Fines (%):	84.6
Silt (%):	
Clay (%):	

Coeff. Unif. (Cu):	
Coeff. Curv. (Cc):	

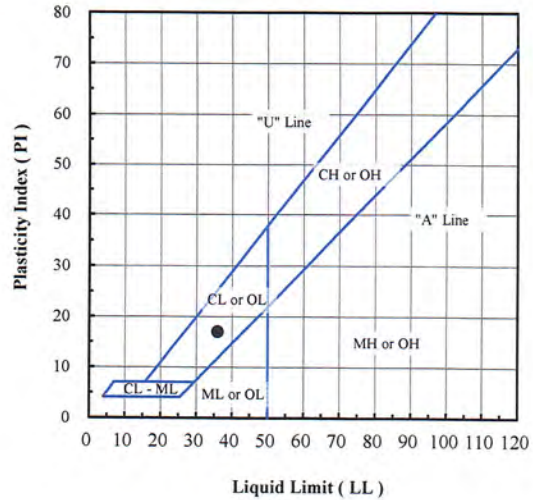

Specific Gravity (-):

Org. Content (%):

Carbon. Content (%):

Client Sample ID.	Lab Sample No:	Moisture Content (%)	Fines Content < No. 200 (%)	Atterberg Limits			Engineering Classification
				LL (-)	PL (-)	PI (-)	
B6-19 (95')	20L300	26.5	84.6	36	19	17	CL - Lean clay with sand

Note(s):

*01-26-2021
AAI, NSR*



Excel Geotechnical Testing, Inc.
"Excellence in Testing"

953 Forrest Street, Roswell, Georgia 30075
 Tel: (770) 910 7537, www.excelgeotesting.com

FLEXIBLE WALL PERMEABILITY TEST ⁽¹⁾
ASTM D5084

Project Name:	Belle River ALD Support
Project Number:	PN1017
Client Name:	Geosyntec Consultants
Site Sample ID:	B1-ST-3 (36-38')
Lab Sample Number:	20L145
Material Type:	Soil
Specified Value (cm/sec):	NA
Date Test Started:	1/26/2021

Specimen Type (See Note2) (-)	Specimen Initial Conditions				Test Conditions					Hydraulic Conductivity (cm/s)
	Specimen Final Conditions				Cell Press. (psi)	Back Press. (psi)	Consolid. Press. (psi)	Permeant Liquid ⁽³⁾ (-)	Average Gradient (-)	
	Spec. Length (cm)	Spec. Diameter (cm)	Dry Unit Weight (pcf)	Moisture Content (%)						
ST	3.43	7.37	89.5	35.0	53.0	50.0	3.0	DDW	12	2.2E-8
	3.47	7.04	97.4	27.6	63.00	50.0	13.0	DDW	10	2.7E-9

Notes:

1. Method C, "Falling-Head, Increasing-Tailwater" test procedures were followed during the testing.
2. Specimen preparation: ST = Shelby Tube, R = Remolded, B = Block Sample.
3. Type of permeant liquid: DTW = Deaired Tap Water, DDW = Deaired Deionized (Distilled) Water

*7-21-2021
APK, NSR*



Excel Geotechnical Testing, Inc.
"Excellence in Testing"

953 Forrest Street, Roswell, Georgia 30075
 Tel: (770) 910 7537, www.excelgeotesting.com

FLEXIBLE WALL PERMEABILITY TEST ⁽¹⁾
ASTM D5084

Project Name:	Belle River ALD Support
Project Number:	PN1017
Client Name:	Geosyntec Consultants
Site Sample ID:	B2-ST-2 (7-9')
Lab Sample Number:	20L150
Material Type:	Soil
Specified Value (cm/sec):	NA
Date Test Started:	1/26/2021

Specimen Type (See Note2) (-)	Specimen Initial Conditions				Test Conditions					Hydraulic Conductivity (cm/s)
	Specimen Final Conditions				Cell Press. (psi)	Back Press. (psi)	Consolid. Press. (psi)	Permeant Liquid ⁽³⁾ (-)	Average Gradient (-)	
	Spec. Length (cm)	Spec. Diameter (cm)	Dry Unit Weight (pcf)	Moisture Content (%)						
ST	3.54	7.22	98.2	26.8	53.0	50.0	3.0	DDW	12	2.1E-8
	3.54	7.20	98.8	26.4	54.00	50.0	4.0	DDW	12	2.0E-8

Notes:

- Method C, "Falling-Head, Increasing-Tailwater" test procedures were followed during the testing.
- Specimen preparation: ST = Shelby Tube, R = Remolded, B = Block Sample.
- Type of permeant liquid: DTW = Deaired Tap Water, DDW = Deaired Deionized (Distilled) Water

*7-21-2021
 HPK, NSP*



Excel Geotechnical Testing, Inc.
"Excellence in Testing"

953 Forrest Street, Roswell, Georgia 30075
 Tel: (770) 910 7537, www.excelgeotesting.com

FLEXIBLE WALL PERMEABILITY TEST ⁽¹⁾
ASTM D5084

Project Name:	Belle River ALD Support
Project Number:	PN1017
Client Name:	Geosyntec Consultants
Site Sample ID:	B2-ST-7 (97-99')
Lab Sample Number:	20L155
Material Type:	Soil
Specified Value (cm/sec):	NA
Date Test Started:	2/15/2021

Specimen Type (See Note2) (-)	Specimen Initial Conditions				Test Conditions					Hydraulic Conductivity (cm/s)
	Specimen Final Conditions				Cell Press. (psi)	Back Press. (psi)	Consolid. Press. (psi)	Permeant Liquid ⁽³⁾ (-)	Average Gradient (-)	
	Spec. Length (cm)	Spec. Diameter (cm)	Dry Unit Weight (pcf)	Moisture Content (%)						
ST	3.53	7.24	110.9	20.3	53.0	50.0	3.0	DDW	3	3.3E-8
	3.50	7.16	114.2	18.5	77.00	50.0	27.0	DDW	6	2.2E-8

Notes:

1. Method C, "Falling-Head, Increasing-Tailwater" test procedures were followed during the testing.
2. Specimen preparation: ST = Shelby Tube, R = Remolded, B = Block Sample.
3. Type of permeant liquid: DTW = Deaired Tap Water, DDW = Deaired Deionized (Distilled) Water

* Deviations:

Laboratory temperature at 22±3 °C.

*7-21-2021
APK, NSR*



Excel Geotechnical Testing, Inc.
"Excellence in Testing"

953 Forrest Street, Roswell, Georgia 30075
 Tel: (770) 910 7537, www.excelgeotesting.com

FLEXIBLE WALL PERMEABILITY TEST ⁽¹⁾
ASTM D5084

Project Name:	Belle River ALD Support
Project Number:	PN1017
Client Name:	Geosyntec Consultants
Site Sample ID:	B3-ST-1 (1-3')
Lab Sample Number:	20L156
Material Type:	Soil
Specified Value (cm/sec):	NA
Date Test Started:	2/8/2021

Specimen Type (See Note2) (-)	Specimen Initial Conditions				Test Conditions					Hydraulic Conductivity (cm/s)
	Specimen Final Conditions				Cell Press. (psi)	Back Press. (psi)	Consolid. Press. (psi)	Permeant Liquid ⁽³⁾ (-)	Average Gradient (-)	
	Spec. Length (cm)	Spec. Diameter (cm)	Dry Unit Weight (pcf)	Moisture Content (%)						
ST	3.53	7.17	111.4	19.1	53.0	50.0	3.0	DDW	8	9.6E-9
	3.62	7.29	104.7	22.7						

Notes:

1. Method C, "Falling-Head, Increasing-Tailwater" test procedures were followed during the testing.
2. Specimen preparation: ST = Shelby Tube, R = Remolded, B = Block Sample.
3. Type of permeant liquid: DTW = Deaired Tap Water, DDW = Deaired Deionized (Distilled) Water

*7-21-2021
APK, WSR*



Excel Geotechnical Testing, Inc.
"Excellence in Testing"

953 Forrest Street, Roswell, Georgia 30075
 Tel: (770) 910 7537, www.excelgeotesting.com

FLEXIBLE WALL PERMEABILITY TEST ⁽¹⁾
ASTM D5084

Project Name:	Belle River ALD Support
Project Number:	PN1017
Client Name:	Geosyntec Consultants
Site Sample ID:	B4-ST-4 (67-69')
Lab Sample Number:	20L165
Material Type:	Soil
Specified Value (cm/sec):	NA
Date Test Started:	2/15/2021

Specimen Type (See Note2) (-)	Specimen Initial Conditions				Test Conditions					Hydraulic Conductivity (cm/s)
	Specimen Final Conditions				Cell Press. (psi)	Back Press. (psi)	Consolid. Press. (psi)	Permeant Liquid ⁽³⁾ (-)	Average Gradient (-)	
	Spec. Length (cm)	Spec. Diameter (cm)	Dry Unit Weight (pcf)	Moisture Content (%)						
ST	3.53	7.23	129.8	11.6	53.0	50.0	3.0	DDW	5	2.8E-8
	3.55	7.21	129.5	11.1	69.00	50.0	19.0	DDW	10	1.8E-8

Notes:

1. Method C, "Falling-Head, Increasing-Tailwater" test procedures were followed during the testing.
2. Specimen preparation: ST = Shelby Tube, R = Remolded, B = Block Sample.
3. Type of permeant liquid: DTW = Deaired Tap Water, DDW = Deaired Deionized (Distilled) Water

*7-21-2021
 APK, MSR*



Excel Geotechnical Testing, Inc.
"Excellence in Testing"

953 Forrest Street, Roswell, Georgia 30075
Tel: (770) 910 7537, www.excelgeotesting.com

FLEXIBLE WALL PERMEABILITY TEST ⁽¹⁾
ASTM D5084

Project Name:	Belle River ALD Support
Project Number:	PN1017
Client Name:	Geosyntec Consultants
Site Sample ID:	B5-ST-2 (27-29')
Lab Sample Number:	20L169
Material Type:	Soil
Specified Value (cm/sec):	NA
Date Test Started:	2/15/2021

Specimen Type (See Note2) (-)	Specimen Initial Conditions				Test Conditions					Hydraulic Conductivity (cm/s)
	Specimen Final Conditions				Cell Press. (psi)	Back Press. (psi)	Consolid. Press. (psi)	Permeant Liquid ⁽³⁾ (-)	Average Gradient (-)	
	Spec. Length (cm)	Spec. Diameter (cm)	Dry Unit Weight (pcf)	Moisture Content (%)						
ST	3.49	7.34	85.9	36.8	53.0	50.0	3.0	DDW	9	3.4E-8
	3.48	7.02	93.4	30.7	60.00	50.0	10.0	DDW	4	2.1E-8

Notes:

1. Method C, "Falling-Head, Increasing-Tailwater" test procedures were followed during the testing.
2. Specimen preparation: ST = Shelby Tube, R = Remolded, B = Block Sample.
3. Type of permeant liquid: DTW = Deaired Tap Water, DDW = Deaired Deionized (Distilled) Water

*7-21-2021
APK, ASR*



Excel Geotechnical Testing, Inc.
"Excellence in Testing"

953 Forrest Street, Roswell, Georgia 30075
 Tel: (770) 910 7537, www.excelgeotesting.com

FLEXIBLE WALL PERMEABILITY TEST ⁽¹⁾
ASTM D5084

Project Name:	Belle River ALD Support
Project Number:	PN1017
Client Name:	Geosyntec Consultants
Site Sample ID:	B6-ST-4 (47-49')
Lab Sample Number:	20L177
Material Type:	Soil
Specified Value (cm/sec):	NA
Date Test Started:	2/17/2021

Specimen Type (See Note2) (-)	Specimen Initial Conditions				Test Conditions					Hydraulic Conductivity (cm/s)
	Specimen Final Conditions				Cell Press. (psi)	Back Press. (psi)	Consolid. Press. (psi)	Permeant Liquid ⁽³⁾ (-)	Average Gradient (-)	
	Spec. Length (cm)	Spec. Diameter (cm)	Dry Unit Weight (pcf)	Moisture Content (%)						
ST	3.49	7.32	86.6	38.3	53.0	50.0	3.0	DDW	5	2.5E-8
	3.45	7.16	93.3	29.6	65.00	50.0	15.0	DDW	10	1.8E-8

Notes:

1. Method C, "Falling-Head, Increasing-Tailwater" test procedures were followed during the testing.
2. Specimen preparation: ST = Shelby Tube, R = Remolded, B = Block Sample.
3. Type of permeant liquid: DTW = Deaired Tap Water, DDW = Deaired Deionized (Distilled) Water

*7-21-2021
 AFK, NSB*



Excel Geotechnical Testing, Inc.
"Excellence in Testing"

953 Forrest Street, Roswell, Georgia 30075
 Tel: (770) 910 7537, www.excelgeotesting.com

FLEXIBLE WALL PERMEABILITY TEST ⁽¹⁾
ASTM D5084

Project Name:	Belle River ALD Support
Project Number:	PN1017
Client Name:	Geosyntec Consultants
Site Sample ID:	B6-ST-7 (97-99')
Lab Sample Number:	20L180
Material Type:	Soil
Specified Value (cm/sec):	NA
Date Test Started:	2/17/2021

Specimen Type (See Note2) (-)	Specimen Initial Conditions				Test Conditions					Hydraulic Conductivity (cm/s)
	Specimen Final Conditions				Cell Press. (psi)	Back Press. (psi)	Consolid. Press. (psi)	Permeant Liquid ⁽³⁾ (-)	Average Gradient (-)	
	Spec. Length (cm)	Spec. Diameter (cm)	Dry Unit Weight (pcf)	Moisture Content (%)						
ST	3.53	7.29	104.1	23.5	53.0	50.0	3.0	DDW	4	2.4E-8
	3.51	7.18	108.3	21.0	76.00	50.0	26.0	DDW	9	1.2E-8

Notes:

1. Method C, "Falling-Head, Increasing-Tailwater" test procedures were followed during the testing.
2. Specimen preparation: ST = Shelby Tube, R = Remolded, B = Block Sample.
3. Type of permeant liquid: DTW = Deaired Tap Water, DDW = Deaired Deionized (Distilled) Water

*7-21-2021
 HPK, MSK*



Excel Geotechnical Testing, Inc.

"Excellence in Testing"

953 Forrest Street, Roswell, Georgia 30075
Tel: (770) 910 7537 Fax: (770) 910 7538

LAST PAGE

Test Applicability and Limitations:

- The results are applicable only for the materials received at the laboratory and tested which may or may not be representative of the materials at the site.

Storage Policy:

- Uncontaminated Material: All samples (or what is left) will be archived for a period of 3 months from the date received. Thereafter the samples will be discarded unless a written request for extended storage is received. A rate of \$1.00 per sample per day will be applied after the initial 3 month storage period.

- Contaminated Material: All samples (or what is left) will be archived for a period of 3 months from the date received. Thereafter, the samples will be returned to the project manager or his/her designated receiver unless a written request for extended storage is received. A rate of \$1.30 per sample per day will be applied after the initial 3 months storage.

APPENDIX I1 – CPT LOGS



GeoSyntec

Job No: 20-61-21681

Date: 2020-12-10 14:55

Site: DTE Belle River Power Plant

Sounding: CPT20-01

Cone: 551:T1500F15U500

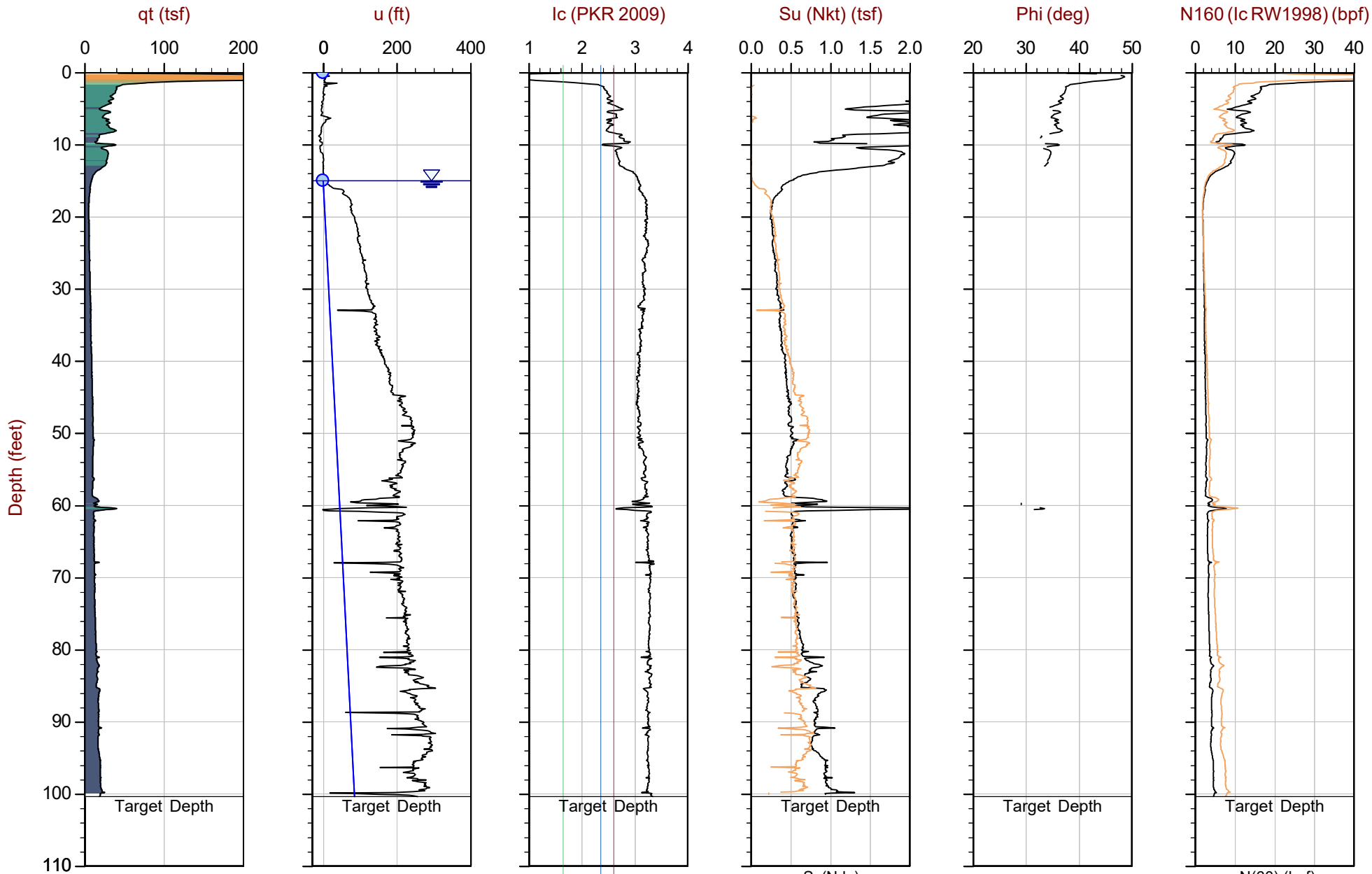

Max Depth: 30.600 m / 100.39 ft

Depth Inc: 0.025 m / 0.082 ft

Avg Int: EveryPoint

Overplot Item: ● Ueq ● Assumed Ueq

File: 20-61-21681_CP01.COR

Unit Wt: SBTQtn (PKR2009)

Su Nkt/Ndu: 15.0 / 9.0

△ Dissipation, Ueq achieved

◁ Dissipation, Ueq not achieved

SBT: Robertson, 2009 and 2010

Coords: Michigan State Plane South N: 470985ft E: 13625925ft

Sheet No: 1 of 1

◁ Dissipation, Ueq assumed

— Hydrostatic Line



GeoSyntec

Job No: 20-61-21681

Date: 2020-12-11 08:28

Site: DTE Belle River Power Plant

Sounding: CPT20-01B

Cone: 551:T1500F15U500

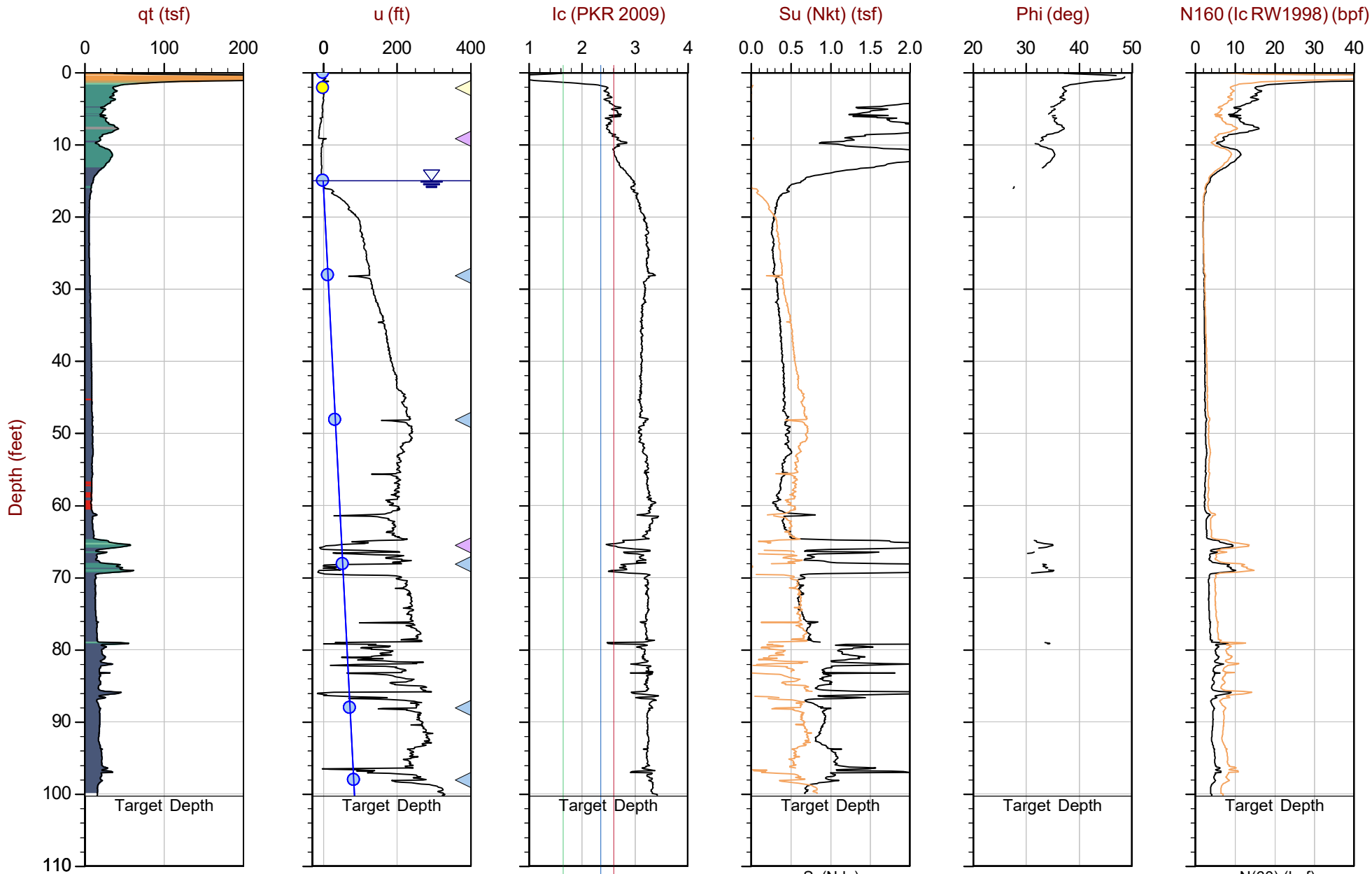

Max Depth: 30.575 m / 100.31 ft

Depth Inc: 0.025 m / 0.082 ft

Avg Int: EveryPoint

Overplot Item: ● Ueq ● Assumed Ueq

File: 20-61-21681_CP01B.COR

Unit Wt: SBTQtn(PKR2009)

Su Nkt/Ndu: 15.0 / 9.0

◀ Dissipation, Ueq achieved

◀ Dissipation, Ueq not achieved

SBT: Robertson, 2009 and 2010

Coords: Michigan State Plane South N: 470980ft E: 13625906ft

Sheet No: 1 of 1

◀ Dissipation, Ueq assumed

— Hydrostatic Line



GeoSyntec

Job No: 20-61-21681

Date: 2020-12-09 12:28

Site: DTE Belle River Power Plant

Sounding: CPT20-02

Cone: 513:T1500F15U500

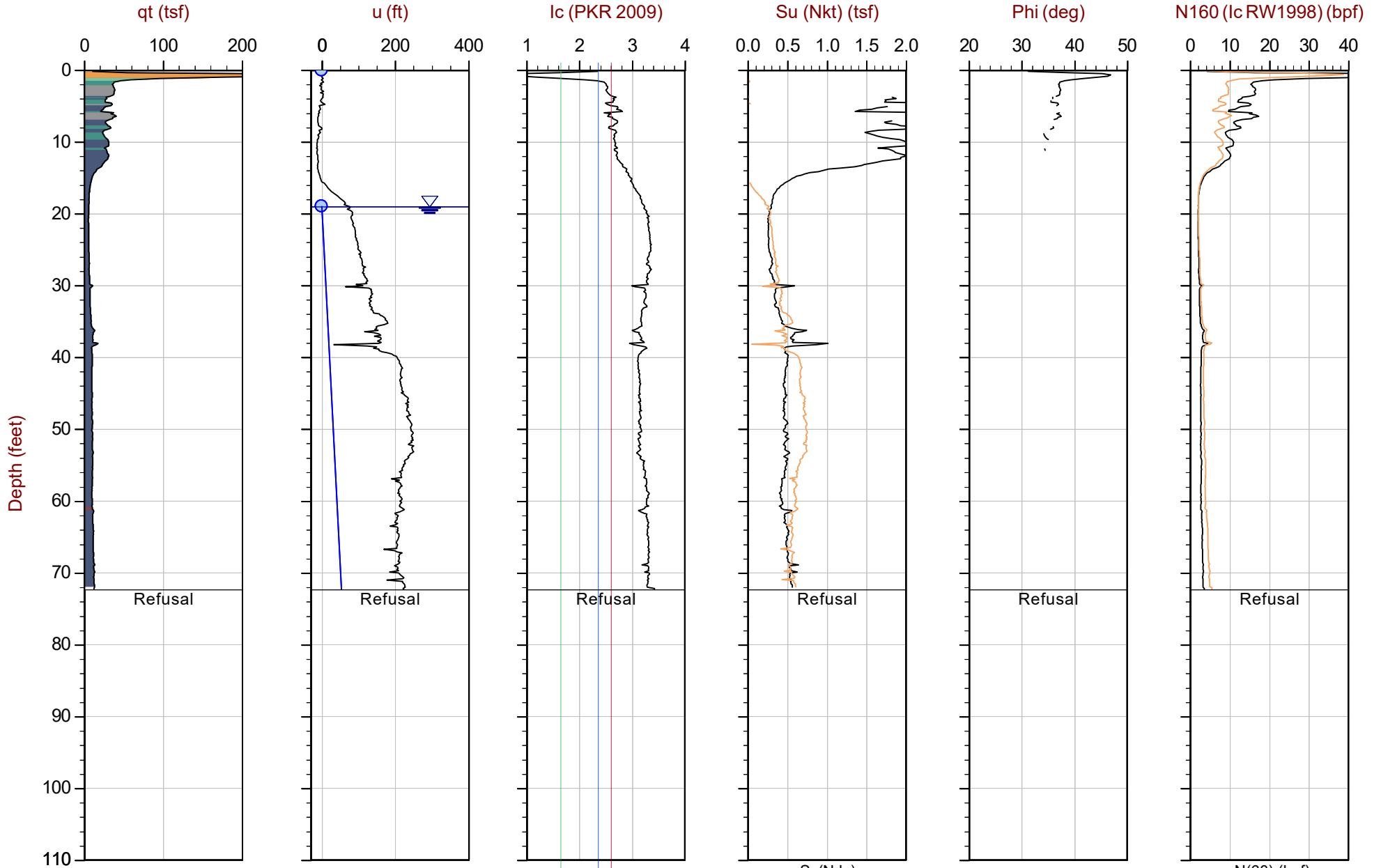

Max Depth: 22.050 m / 72.34 ft

Depth Inc: 0.050 m / 0.164 ft

Avg Int: EveryPoint

Overplot Item: ● Ueq ○ Assumed Ueq

File: 20-61-21681_CP02.COR

Unit Wt: SBTQtn (PKR2009)

Su Nkt/Ndu: 15.0 / 9.0

◁ Dissipation, Ueq achieved

◁ Dissipation, Ueq not achieved

SBT: Robertson, 2009 and 2010

Coords: Michigan State Plane South N: 470997ft E: 13626119ft

Sheet No: 1 of 1

◁ Dissipation, Ueq assumed

— Hydrostatic Line



GeoSyntec

Job No: 20-61-21681

Date: 2020-12-09 14:00

Site: DTE Belle River Power Plant

Sounding: CPT20-03

Cone: 551:T1500F15U500

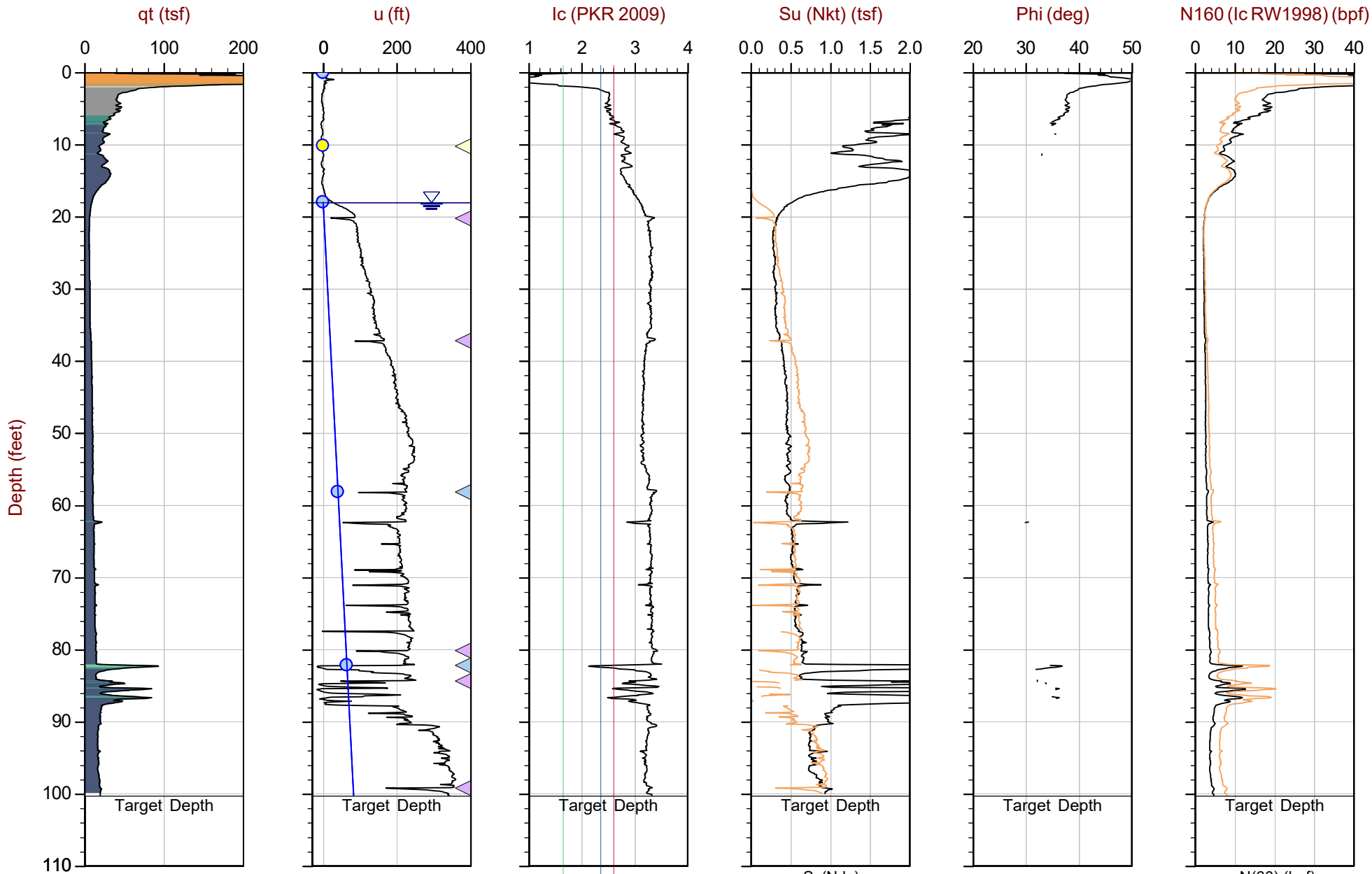

Max Depth: 30.575 m / 100.31 ft

Depth Inc: 0.025 m / 0.082 ft

Avg Int: EveryPoint

Overplot Item: ● Ueq ○ Assumed Ueq

File: 20-61-21681_CP03.COR

Unit Wt: SBTQtn(PKR2009)

SuNkt/Ndu: 15.0 / 9.0

△ Dissipation, Ueq achieved

◁ Dissipation, Ueq not achieved

SBT: Robertson, 2009 and 2010

Coords: Michigan State Plane South N: 471039ft E: 13626171ft

Sheet No: 1 of 1

◁ Dissipation, Ueq assumed

— Hydrostatic Line

— Su(Ndu)

— N(60) (bpf)



GeoSyntec

Job No: 20-61-21681

Date: 2020-12-09 11:05

Site: DTE Belle River Power Plant

Sounding: CPT20-04

Cone: 551:T1500F15U500

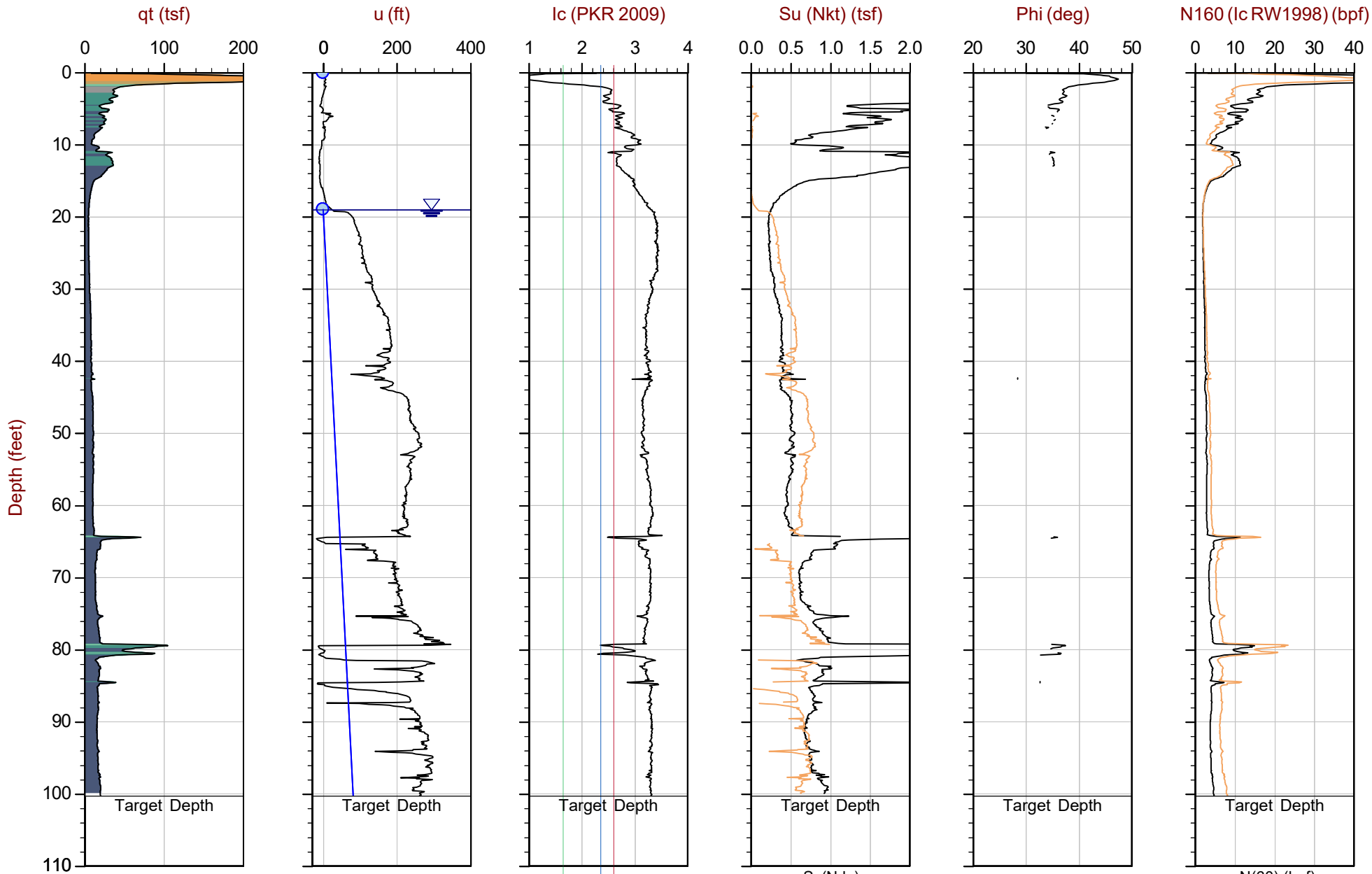

Max Depth: 30.575 m / 100.31 ft

Depth Inc: 0.025 m / 0.082 ft

Avg Int: EveryPoint

Overplot Item: ● Ueq ● Assumed Ueq

File: 20-61-21681_CP04.COR

Unit Wt: SBTQtn(PKR2009)

SuNkt/Ndu: 15.0 / 9.0

◁ Dissipation, Ueq achieved

◁ Dissipation, Ueq not achieved

SBT: Robertson, 2009 and 2010

Coords: Michigan State Plane South N: 471237ft E: 13626152ft

Sheet No: 1 of 1

◁ Dissipation, Ueq assumed

— Hydrostatic Line



GeoSyntec

Job No: 20-61-21681

Date: 2020-12-09 12:02

Site: DTE Belle River Power Plant

Sounding: CPT20-05

Cone: 551:T1500F15U500

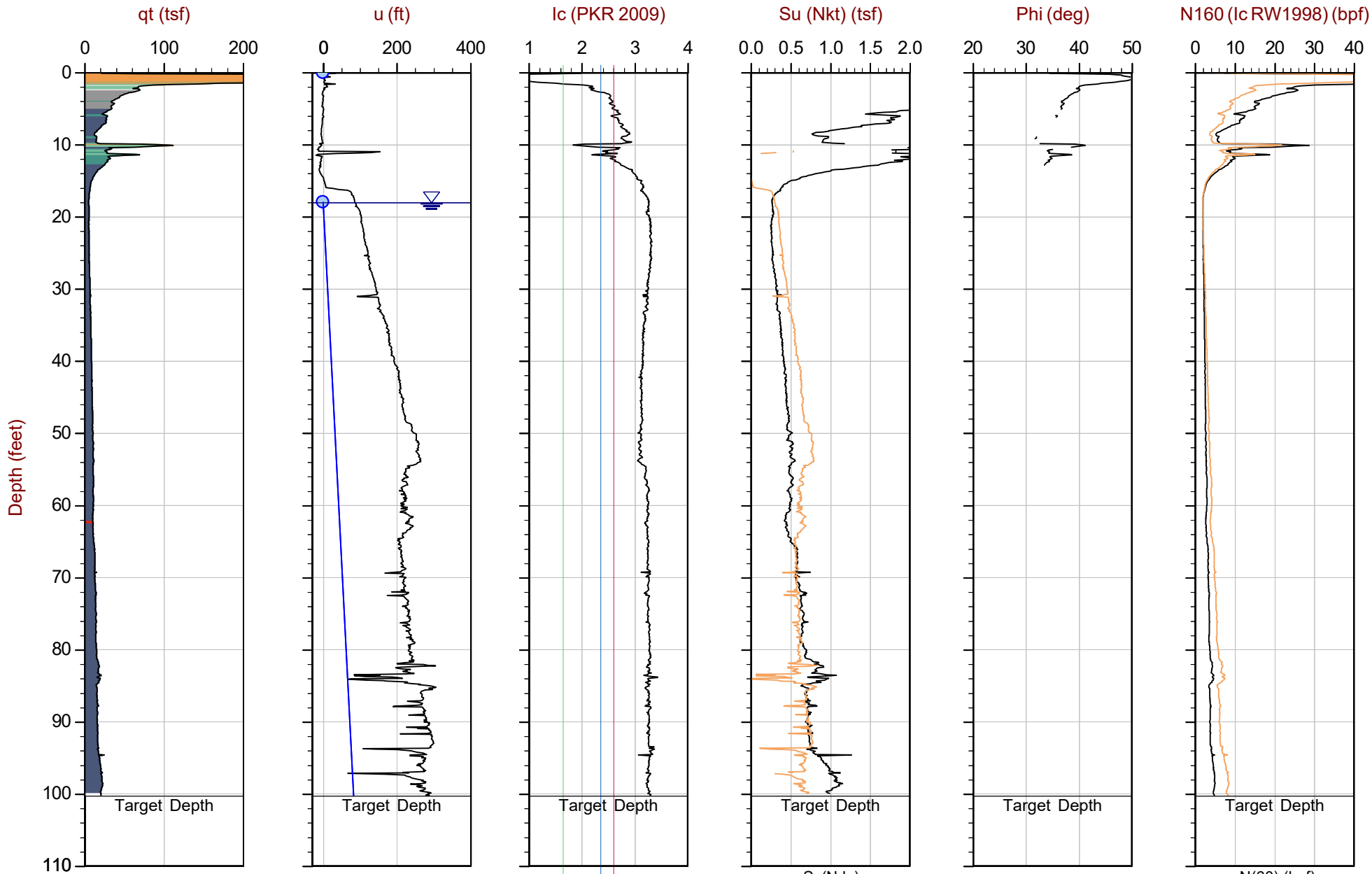

Max Depth: 30.575 m / 100.31 ft

Depth Inc: 0.025 m / 0.082 ft

Avg Int: EveryPoint

Overplot Item: ● Ueq ○ Assumed Ueq

File: 20-61-21681_CP05.COR

Unit Wt: SBTQtn(PKR2009)

SuNkt/Ndu: 15.0 / 9.0

◁ Dissipation, Ueq achieved

◁ Dissipation, Ueq not achieved

SBT: Robertson, 2009 and 2010

Coords: Michigan State Plane South N: 471243ft E: 13625954ft

Sheet No: 1 of 1

◁ Dissipation, Ueq assumed

— Hydrostatic Line

— N(60) (bpf)



GeoSyntec

Job No: 20-61-21681

Date: 2020-12-09 13:54

Site: DTE Belle River Power Plant

Sounding: CPT20-06

Cone: 513:T1500F15U500

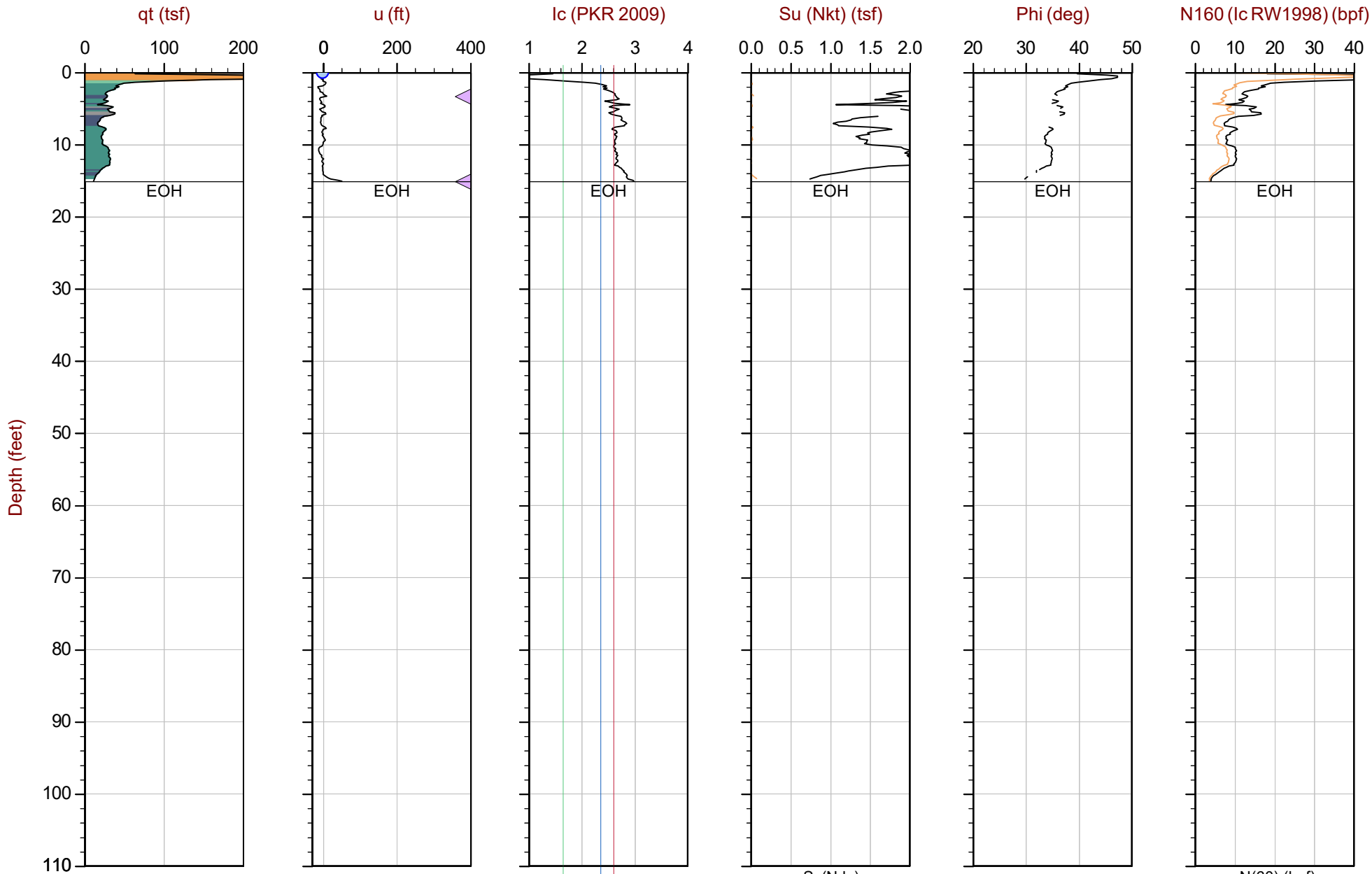

Max Depth: 4.600 m / 15.09 ft

Depth Inc: 0.050 m / 0.164 ft

Avg Int: EveryPoint

Overplot Item: ● Ueq ● Assumed Ueq

File: 20-61-21681_CP06.COR

Unit Wt: SBTQtn (PKR2009)

Su Nkt/Ndu: 15.0 / 9.0

◁ Dissipation, Ueq achieved

◁ Dissipation, Ueq not achieved

SBT: Robertson, 2009 and 2010

Coords: Michigan State Plane South N: 471221ft E: 13625753ft

Sheet No: 1 of 1

◁ Dissipation, Ueq assumed

— Hydrostatic Line

Su(Ndu)

N(60) (bpf)



GeoSyntec

Job No: 20-61-21681

Date: 2020-12-10 08:43

Site: DTE Belle River Power Plant

Sounding: CPT20-06B

Cone: 513:T1500F15U500

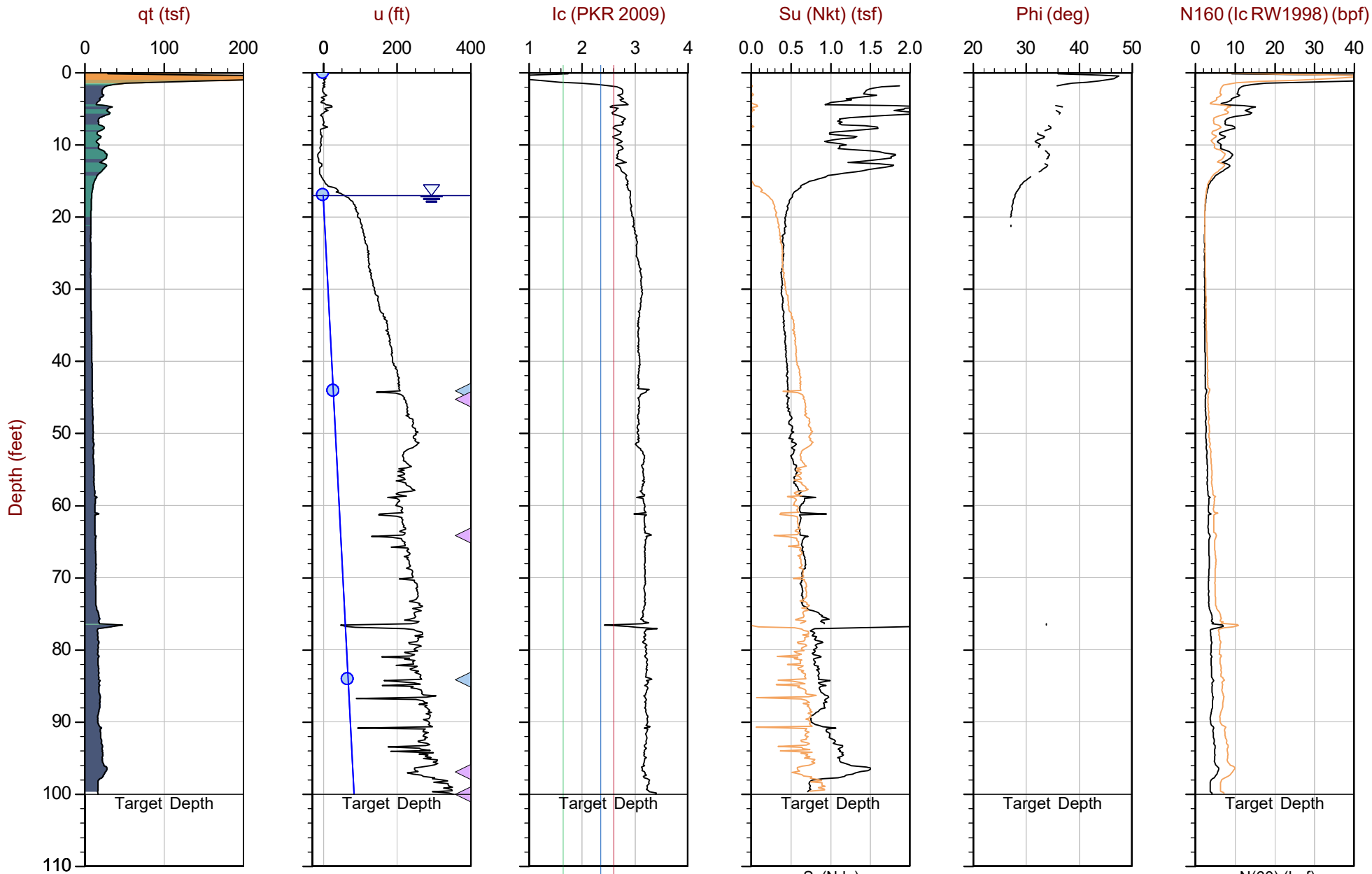

Max Depth: 30.500 m / 100.06 ft

Depth Inc: 0.050 m / 0.164 ft

Avg Int: EveryPoint

Overplot Item: ● Ueq ● Assumed Ueq

File: 20-61-21681_CP06B.COR

Unit Wt: SBTQtn(PKR2009)

SuNkt/Ndu: 15.0 / 9.0

◀ Dissipation, Ueq achieved

◀ Dissipation, Ueq not achieved

SBT: Robertson, 2009 and 2010

Coords: Michigan State Plane South N: 471216ft E: 13625742ft

Sheet No: 1 of 1

◀ Dissipation, Ueq assumed

— Hydrostatic Line



GeoSyntec

Job No: 20-61-21681

Date: 2020-12-09 11:04

Site: DTE Belle River Power Plant

Sounding: CPT20-07

Cone: 513:T1500F15U500

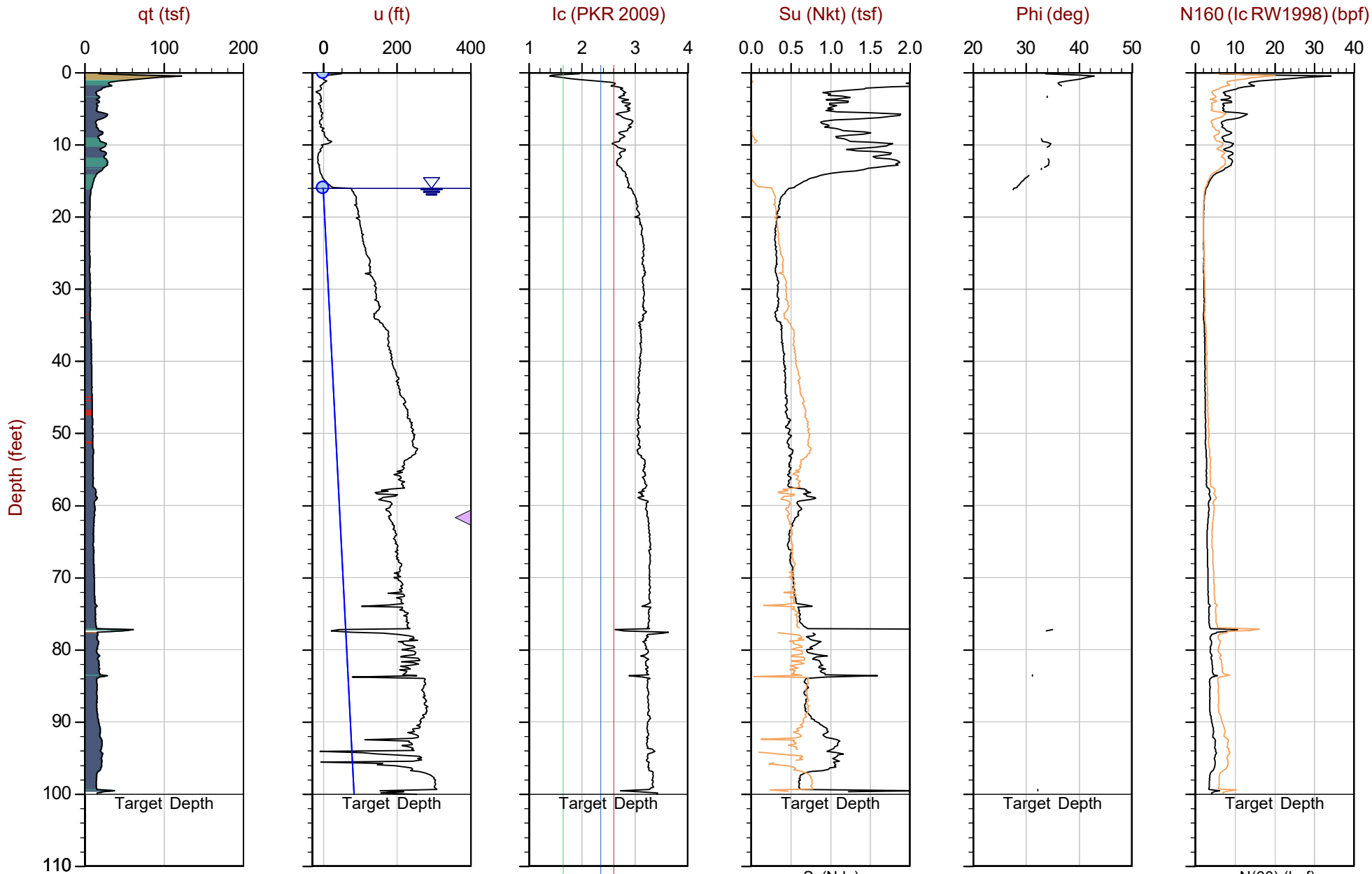

Max Depth: 30.500 m / 100.06 ft

Depth Inc: 0.050 m / 0.164 ft

Avg Int: EveryPoint

Overplot Item: ● Ueq ○ Assumed Ueq

File: 20-61-21681_CP07.COR

Unit Wt: SBTQtn(PKR2009)

Su Nkt/Ndu: 15.0 / 9.0

◁ Dissipation, Ueq achieved

◁ Dissipation, Ueq not achieved

SBT: Robertson, 2009 and 2010

Coords: Michigan State Plane South N: 471015ft E: 13625752ft

Sheet No: 1 of 1

◁ Dissipation, Ueq assumed

— Hydrostatic Line



GeoSyntec

Job No: 20-61-21681

Date: 2020-12-11 12:09

Site: DTE Belle River Power Plant

Sounding: CPT20-08

Cone: 568:T1500F15U500

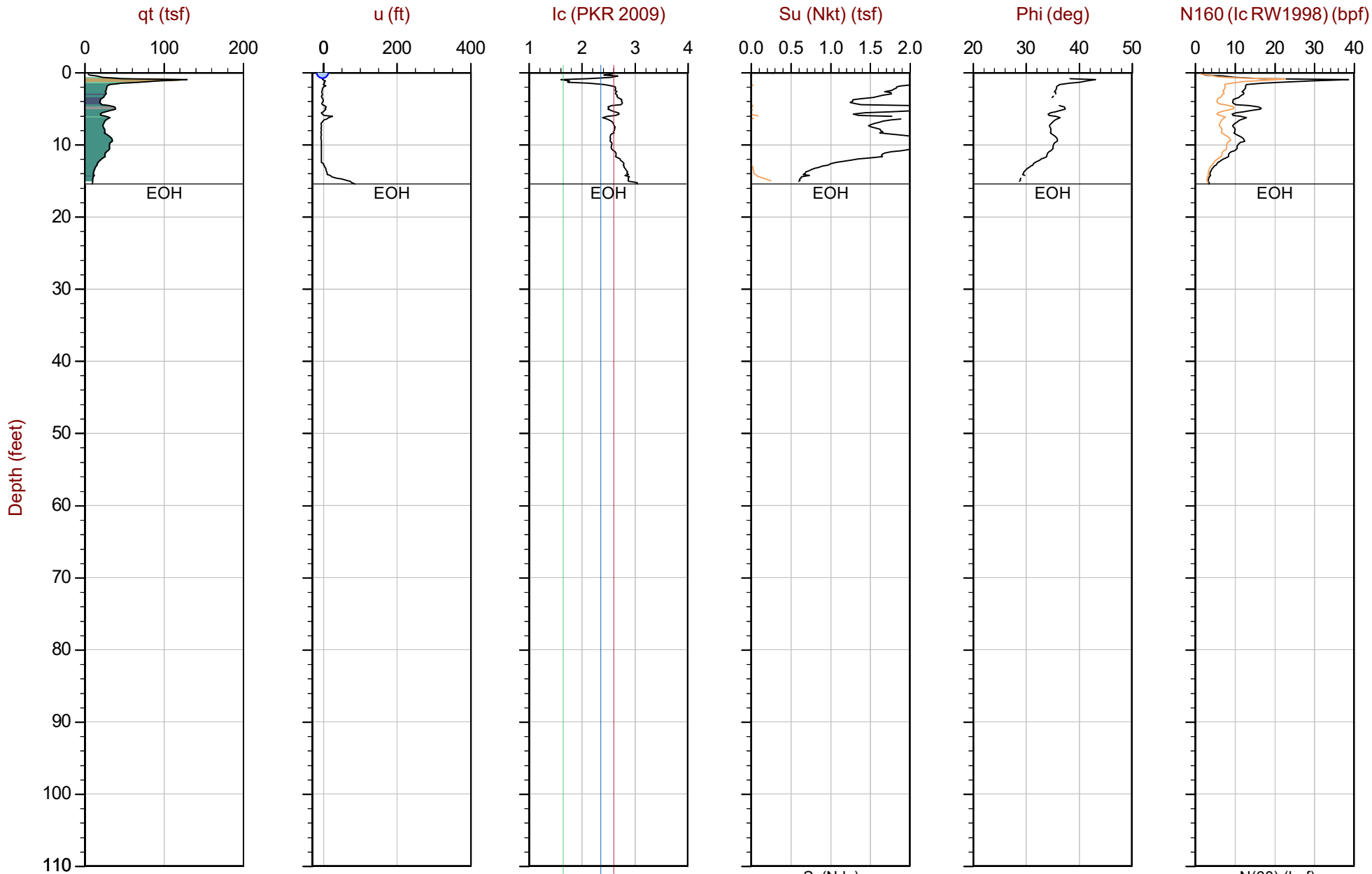

Max Depth: 4.700 m / 15.42 ft

Depth Inc: 0.050 m / 0.164 ft

Avg Int: EveryPoint

Overplot Item: ● Ueq ● Assumed Ueq

File: 20-61-21681_CP08.COR

Unit Wt: SBTQtn(PKR2009)

SuNkt/Ndu: 15.0 / 9.0

◀ Dissipation, Ueq achieved

◀ Dissipation, Ueq not achieved

SBT: Robertson, 2009 and 2010

Coords: Michigan State Plane South N: 470392ft E: 13626398ft

Sheet No: 1 of 1

◀ Dissipation, Ueq assumed

— Hydrostatic Line



GeoSyntec

Job No: 20-61-21681

Date: 2020-12-11 12:35

Site: DTE Belle River Power Plant

Sounding: CPT20-08B

Cone: 568:T1500F15U500

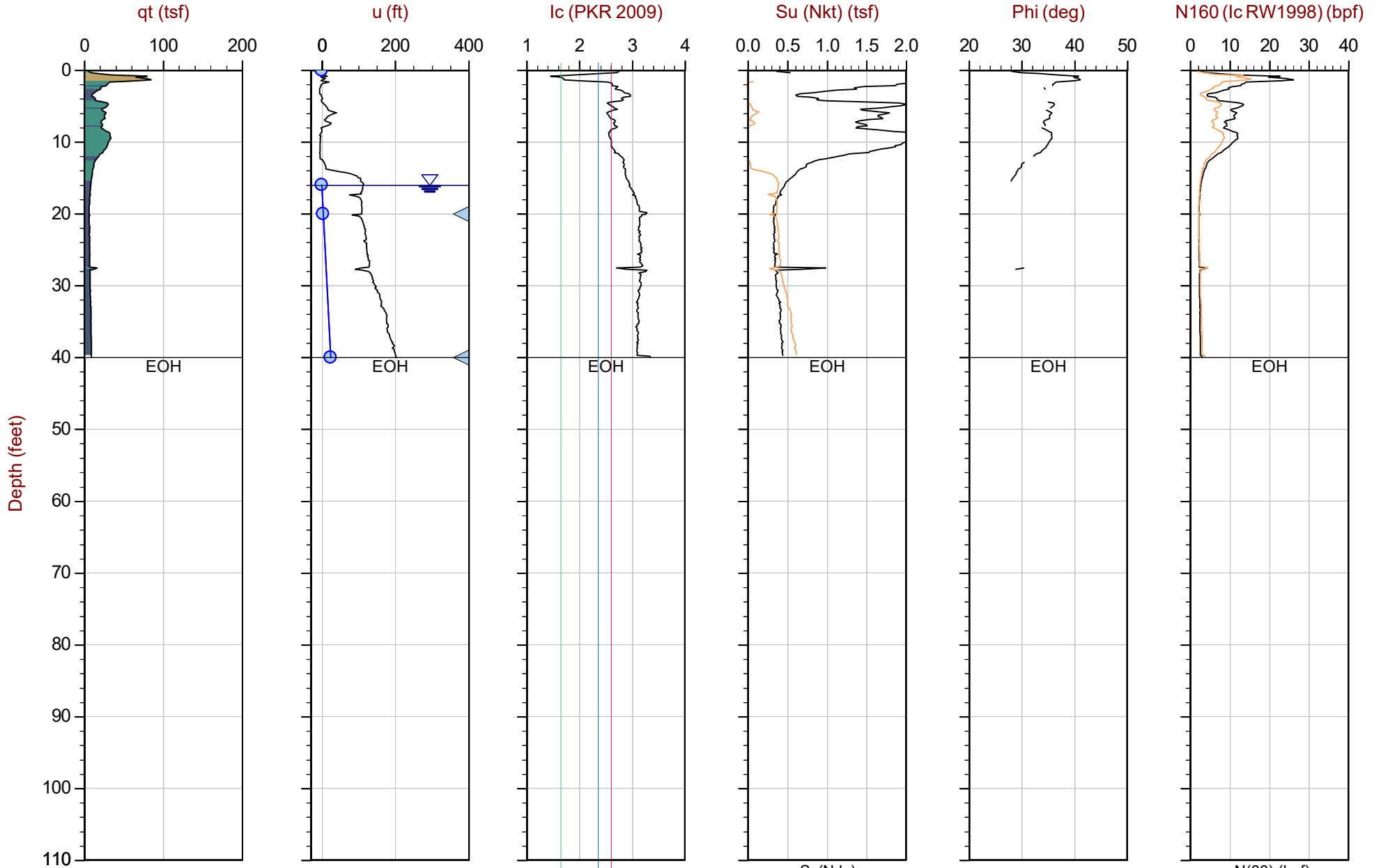

Max Depth: 12.200 m / 40.03 ft

Depth Inc: 0.050 m / 0.164 ft

Avg Int: EveryPoint

Overplot Item: ● Ueq ● Assumed Ueq

File: 20-61-21681_CP08B.COR

Unit Wt: SBTQtn(PKR2009)

SuNkt/Ndu: 15.0 / 9.0

◁ Dissipation, Ueq achieved

◁ Dissipation, Ueq not achieved

SBT: Robertson, 2009 and 2010

Coords: Michigan State Plane South N: 470382ft E: 13626396ft

Sheet No: 1 of 1

◁ Dissipation, Ueq assumed

— Hydrostatic Line



GeoSyntec

Job No: 20-61-21681

Date: 2020-12-15 08:41

Site: DTE Belle River Power Plant

Sounding: CPT20-08C

Cone: 568:T1500F15U500

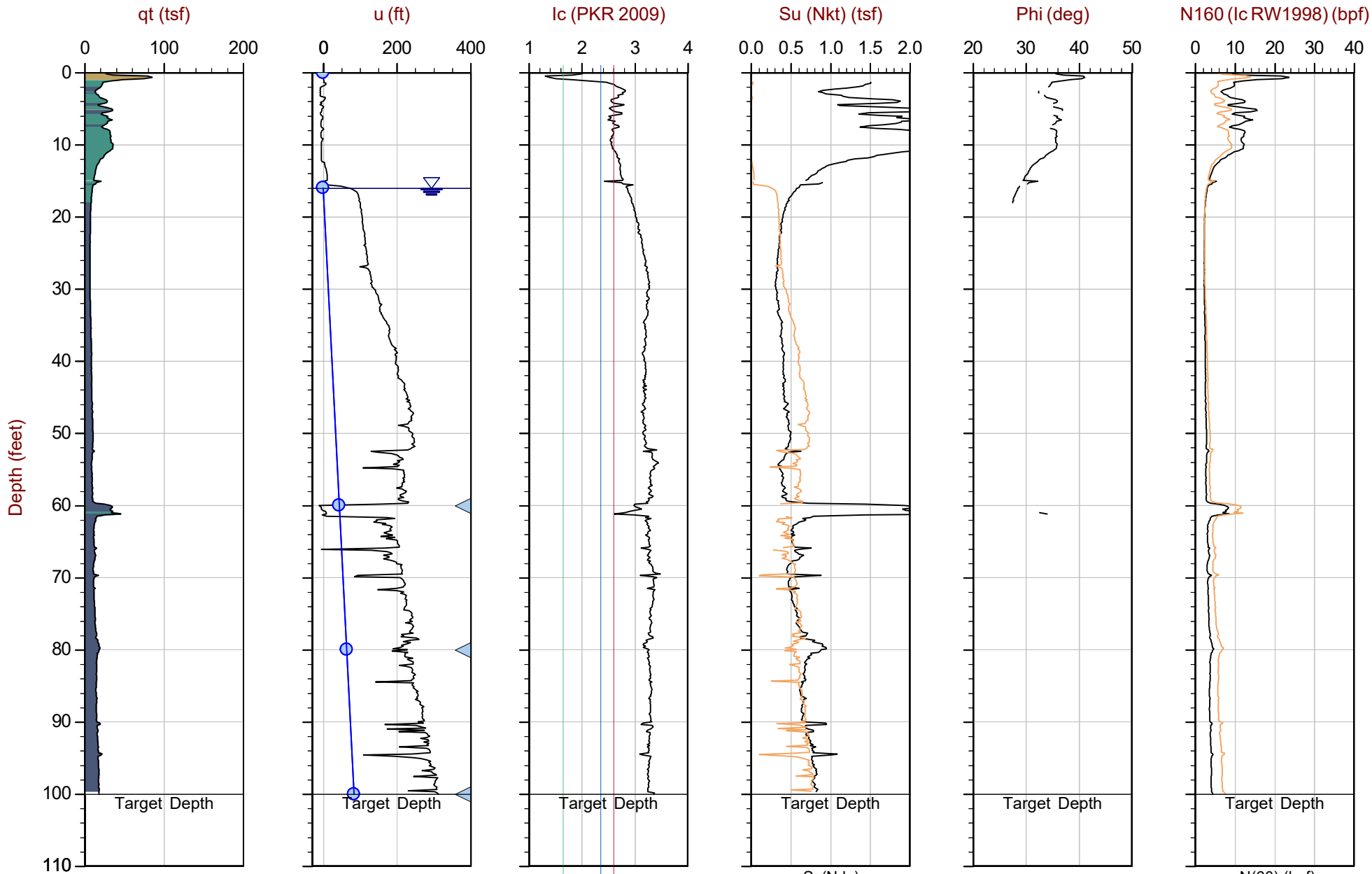

Max Depth: 30.500 m / 100.06 ft

Depth Inc: 0.050 m / 0.164 ft

Avg Int: EveryPoint

Overplot Item: ● Ueq ○ Assumed Ueq

File: 20-61-21681_CP08C.COR

Unit Wt: SBTQtn (PKR2009)

Su Nkt/Ndu: 15.0 / 9.0

◁ Dissipation, Ueq achieved

◁ Dissipation, Ueq not achieved

SBT: Robertson, 2009 and 2010

Coords: Michigan State Plane South N: 470384ft E: 13626391ft

Sheet No: 1 of 1

◁ Dissipation, Ueq assumed

— Hydrostatic Line



GeoSyntec

Job No: 20-61-21681

Date: 2020-12-16 11:02

Site: DTE Belle River Power Plant

Sounding: CPT20-10.1

Cone: 551:T1500F15U500

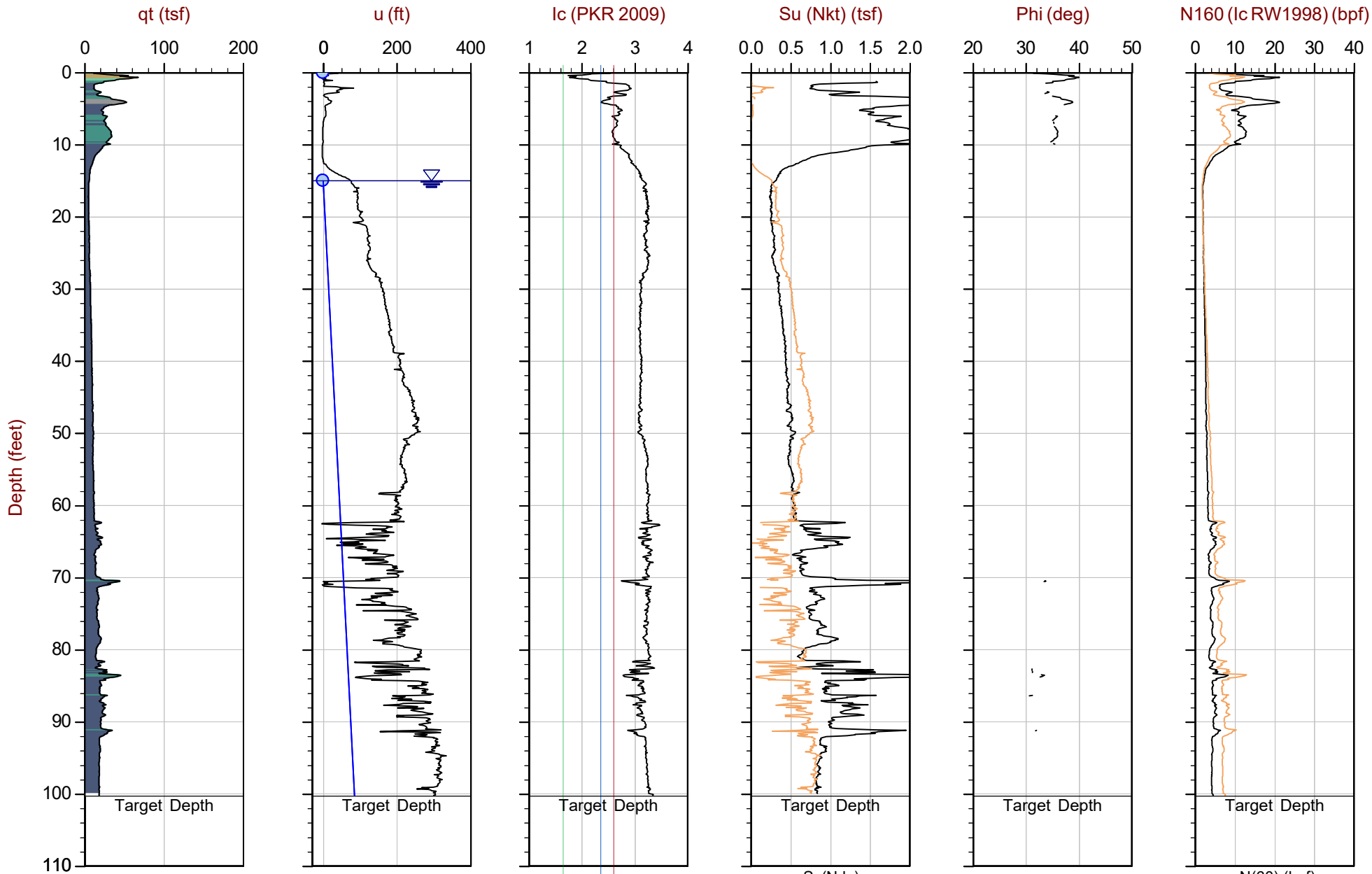

Max Depth: 30.575 m / 100.31 ft

Depth Inc: 0.025 m / 0.082 ft

Avg Int: EveryPoint

Overplot Item: ● Ueq ○ Assumed Ueq

File: 20-61-21681_CP10.1.COR

Unit Wt: SBTQtn(PKR2009)

SuNkt/Ndu: 15.0 / 9.0

◁ Dissipation, Ueq achieved

◁ Dissipation, Ueq not achieved

SBT: Robertson, 2009 and 2010

Coords: Michigan State Plane South N: 469861ft E: 13626732ft

Sheet No: 1 of 1

◁ Dissipation, Ueq assumed

— Hydrostatic Line

— Su(Ndu)

— N(60) (bpf)



GeoSyntec

Job No: 20-61-21681

Date: 2020-12-16 11:53

Site: DTE Belle River Power Plant

Sounding: CPT20-10A

Cone: 551:T1500F15U500

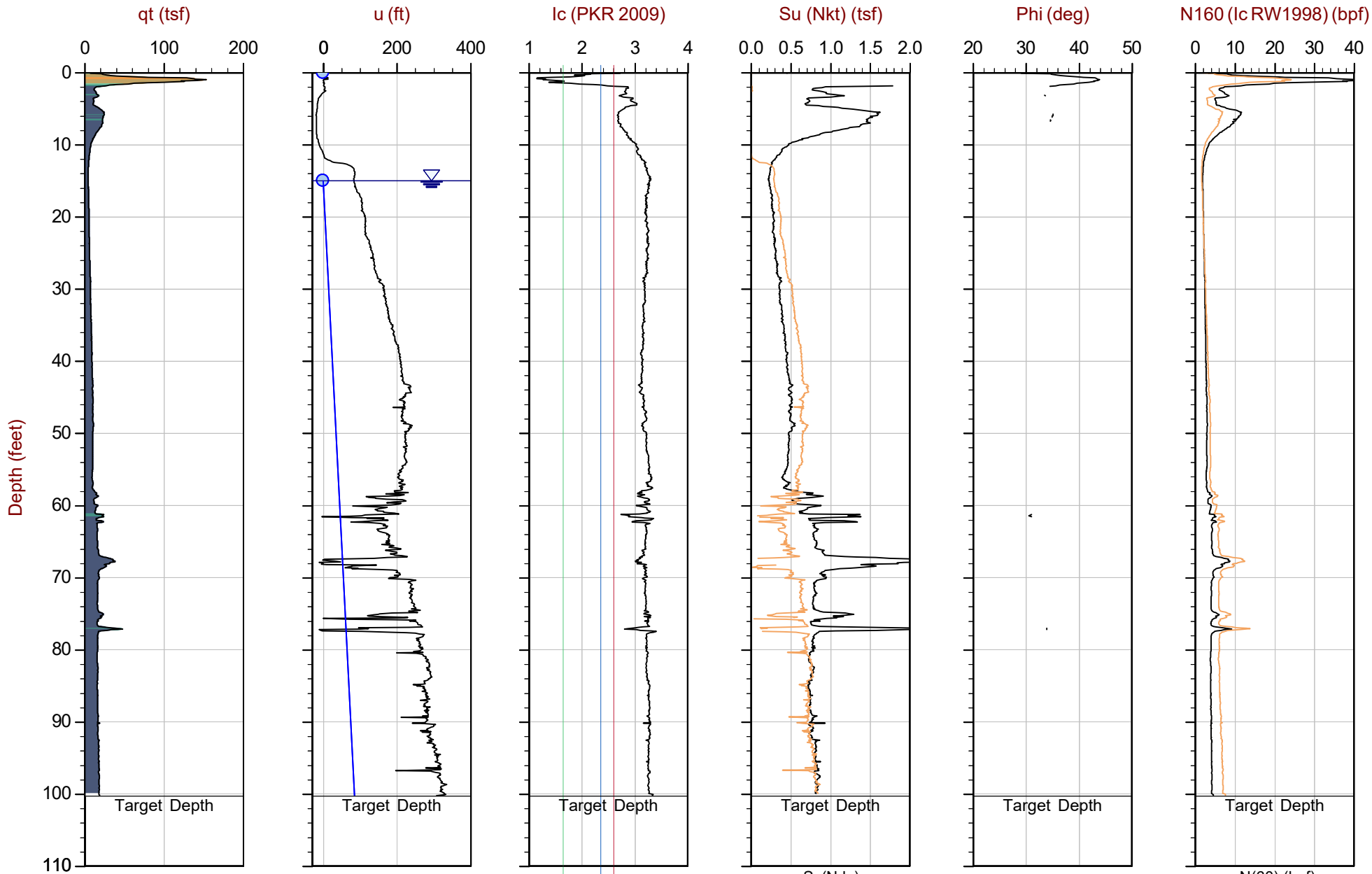

Max Depth: 30.575 m / 100.31 ft

Depth Inc: 0.025 m / 0.082 ft

Avg Int: EveryPoint

Overplot Item: ● Ueq ● Assumed Ueq

File: 20-61-21681_CP10A.COR

Unit Wt: SBTQtn(PKR2009)

Su Nkt/Ndu: 15.0 / 9.0

◁ Dissipation, Ueq achieved

◁ Dissipation, Ueq not achieved

SBT: Robertson, 2009 and 2010

Coords: Michigan State Plane South N: 469934ft E: 13626592ft

Sheet No: 1 of 1

◁ Dissipation, Ueq assumed

— Hydrostatic Line



GeoSyntec

Job No: 20-61-21681

Date: 2020-12-15 11:07

Site: DTE Belle River Power Plant

Sounding: CPT20-11

Cone: 551:T1500F15U500

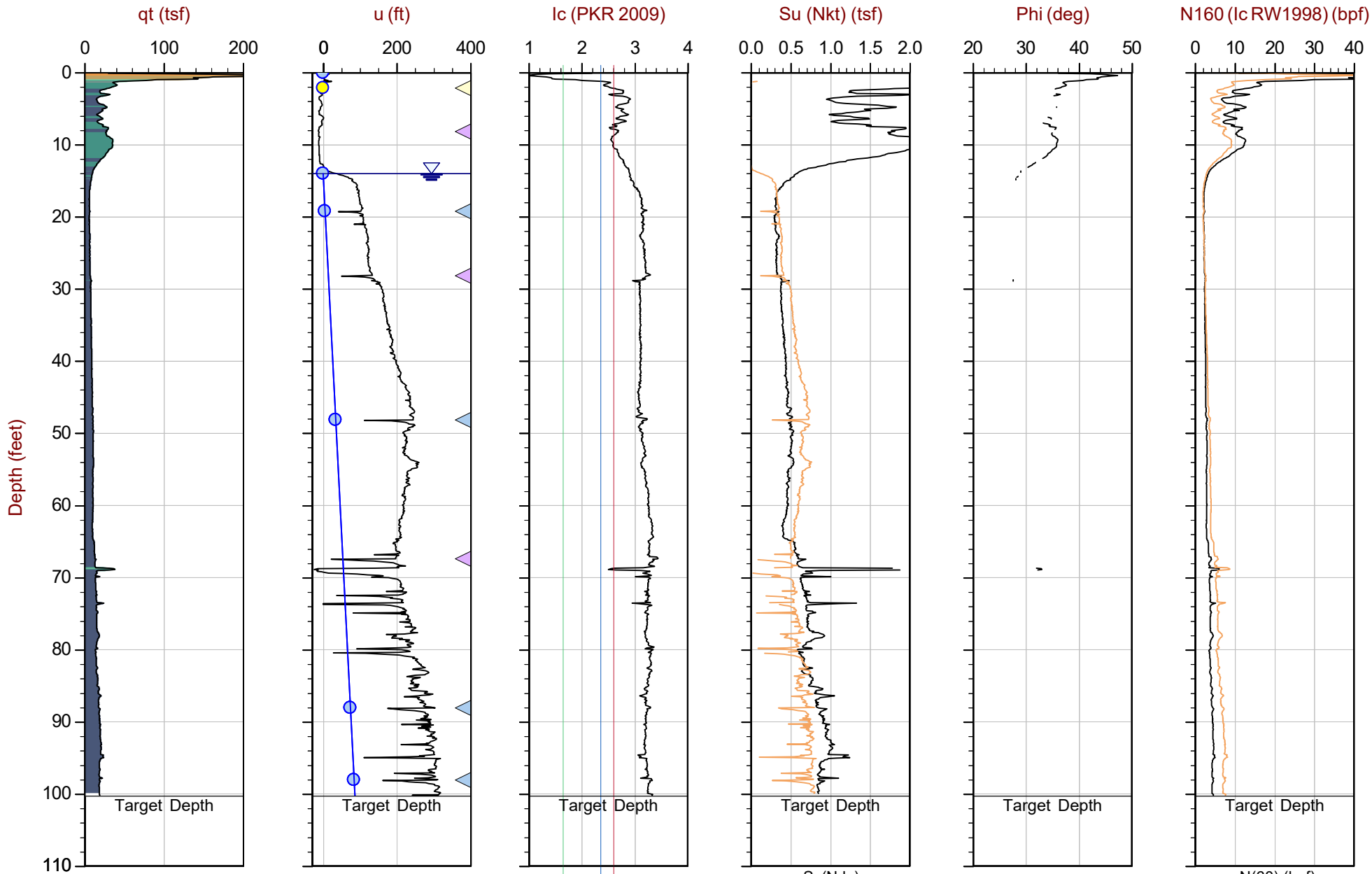

Max Depth: 30.575 m / 100.31 ft

Depth Inc: 0.025 m / 0.082 ft

Avg Int: EveryPoint

Overplot Item: ● Ueq ● Assumed Ueq

File: 20-61-21681_CP11.COR

Unit Wt: SBTQtn (PKR2009)

Su Nkt/Ndu: 15.0 / 9.0

△ Dissipation, Ueq achieved

▽ Dissipation, Ueq not achieved

SBT: Robertson, 2009 and 2010

Coords: Michigan State Plane South N: 469979ft E: 13626765ft

Sheet No: 1 of 1

◀ Dissipation, Ueq assumed

— Hydrostatic Line

Su(Ndu)

N(60) (bpf)



GeoSyntec

Job No: 20-61-21681

Date: 2020-12-15 08:44

Site: DTE Belle River Power Plant

Sounding: CPT20-12

Cone: 551:T1500F15U500

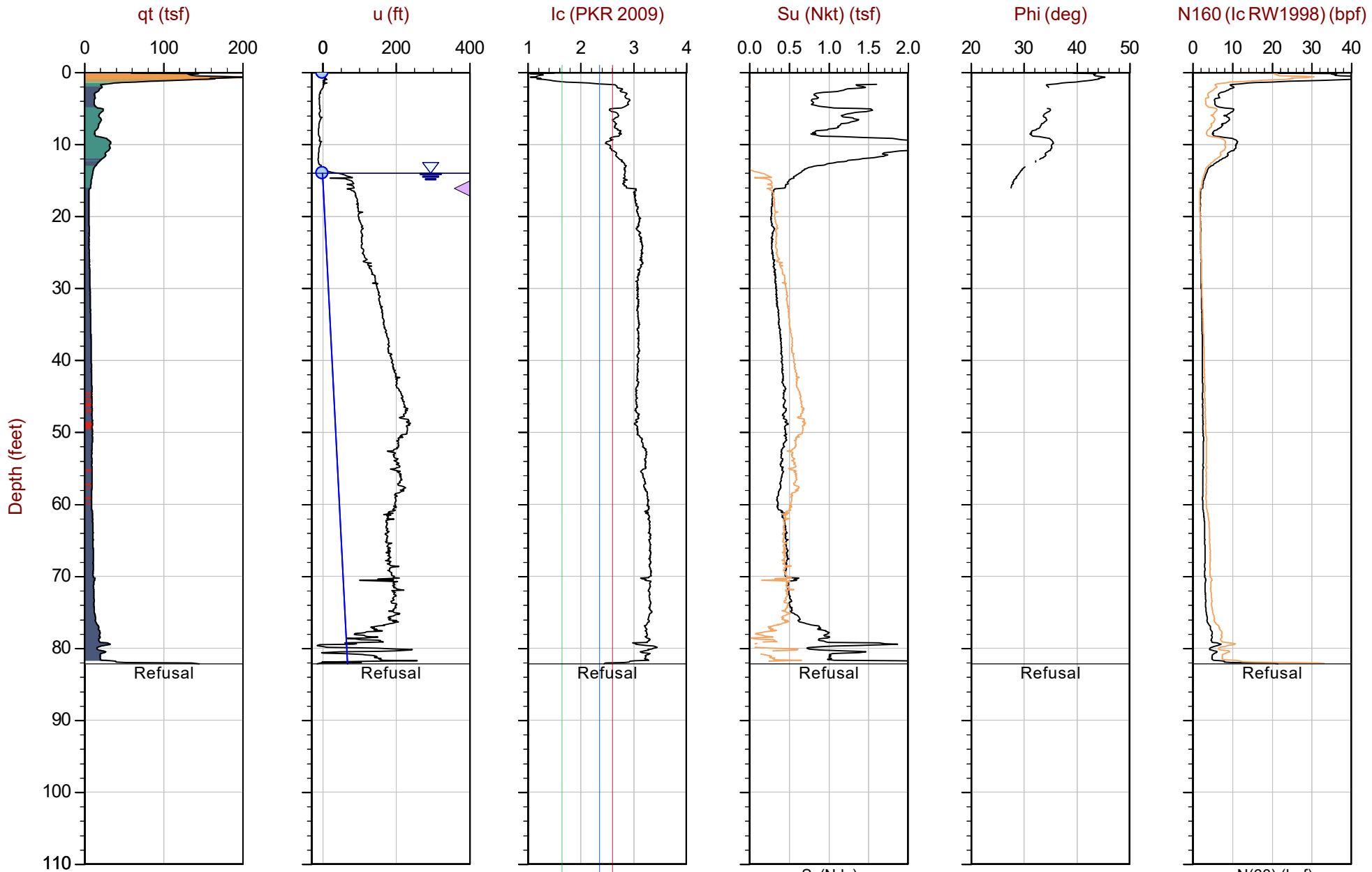

Max Depth: 25.050 m / 82.18 ft

Depth Inc: 0.025 m / 0.082 ft

Avg Int: EveryPoint

Overplot Item: ● Ueq ● Assumed Ueq

File: 20-61-21681_CP12.COR

Unit Wt: SBTQtn(PKR2009)

SuNkt/Ndu: 15.0 / 9.0

◁ Dissipation, Ueq achieved

◁ Dissipation, Ueq not achieved

SBT: Robertson, 2009 and 2010

Coords: Michigan State Plane South N: 470292ft E: 13626802ft

Sheet No: 1 of 1

◁ Dissipation, Ueq assumed

— Hydrostatic Line



GeoSyntec

Job No: 20-61-21681

Date: 2020-12-10 15:00

Site: DTE Belle River Power Plant

Sounding: CPT20-13

Cone: 513:T1500F15U500

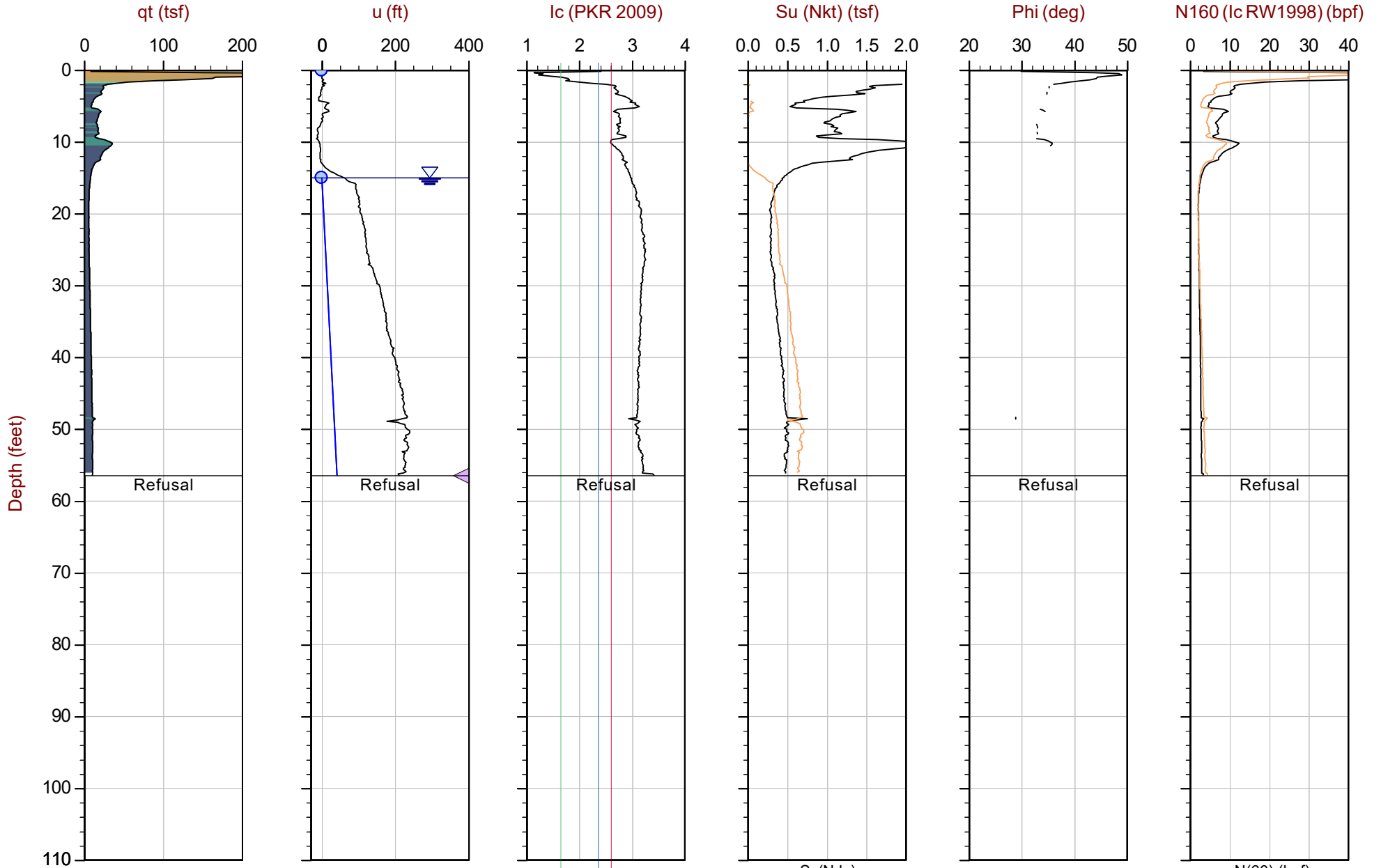

Max Depth: 17.200 m / 56.43 ft

Depth Inc: 0.050 m / 0.164 ft

Avg Int: EveryPoint

Overplot Item: ● Ueq ● Assumed Ueq

File: 20-61-21681_CP13.COR

Unit Wt: SBTQtn(PKR2009)

SuNkt/Ndu: 15.0 / 9.0

◁ Dissipation, Ueq achieved

◁ Dissipation, Ueq not achieved

SBT: Robertson, 2009 and 2010

Coords: Michigan State Plane South N: 470478ft E: 13626800ft

Sheet No: 1 of 1

◁ Dissipation, Ueq assumed

— Hydrostatic Line



GeoSyntec

Job No: 20-61-21681

Date: 2020-12-11 09:09

Site: DTE Belle River Power Plant

Sounding: CPT20-13B

Cone: 568:T1500F15U500

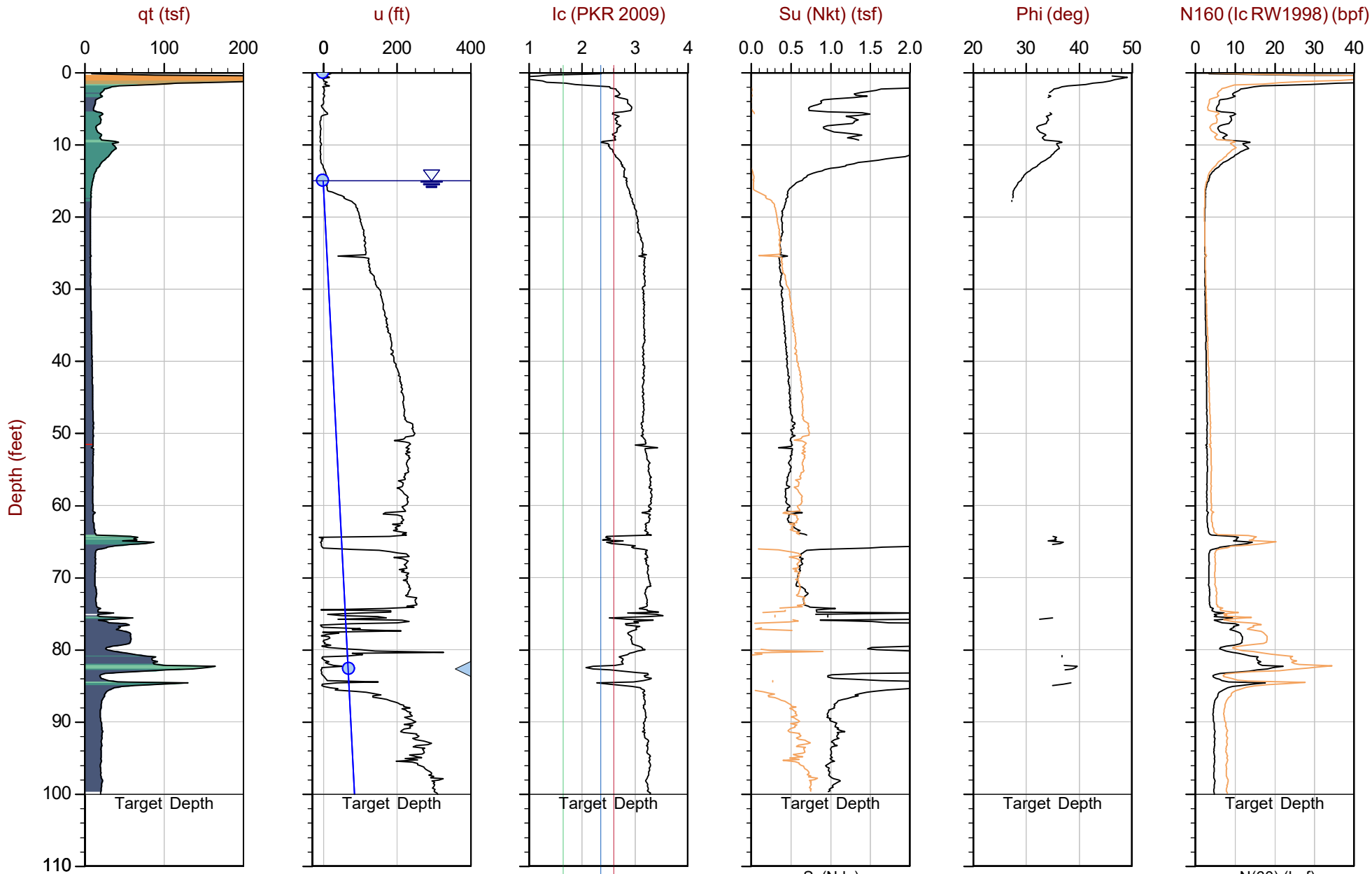

Max Depth: 30.500 m / 100.06 ft

Depth Inc: 0.050 m / 0.164 ft

Avg Int: EveryPoint

Overplot Item: ● Ueq ● Assumed Ueq

File: 20-61-21681_CP13B.COR

Unit Wt: SBTQtn(PKR2009)

SuNkt/Ndu: 15.0 / 9.0

◀ Dissipation, Ueq achieved

◀ Dissipation, Ueq not achieved

SBT: Robertson, 2009 and 2010

Coords: Michigan State Plane South N: 470491ft E: 13626793ft

Sheet No: 1 of 1

◀ Dissipation, Ueq assumed

— Hydrostatic Line

Soil Behavior Type (SBT) Scatter Plots

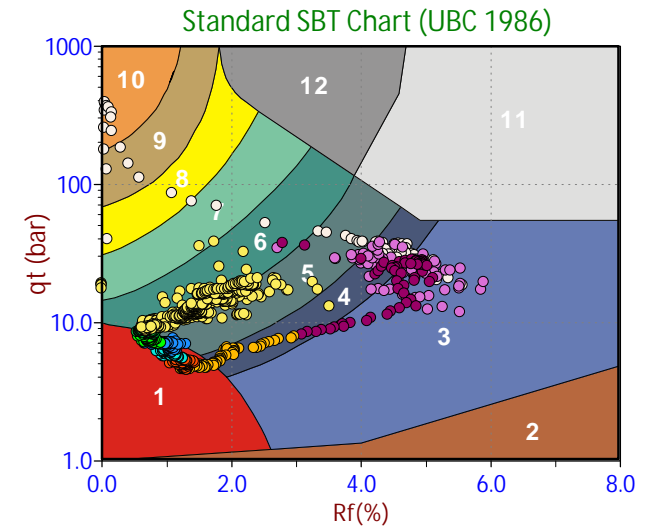
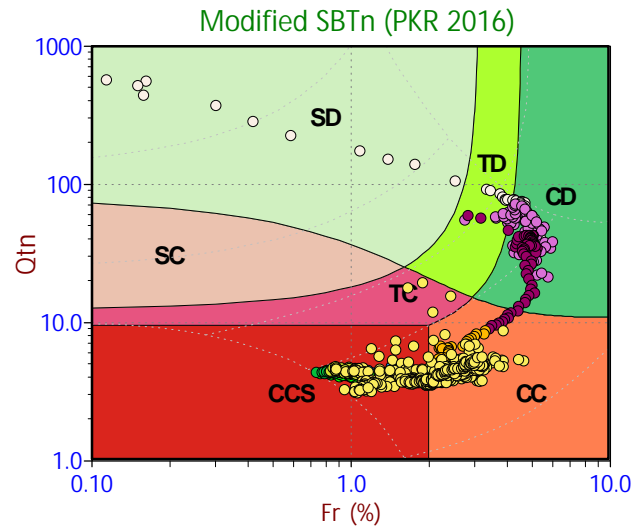
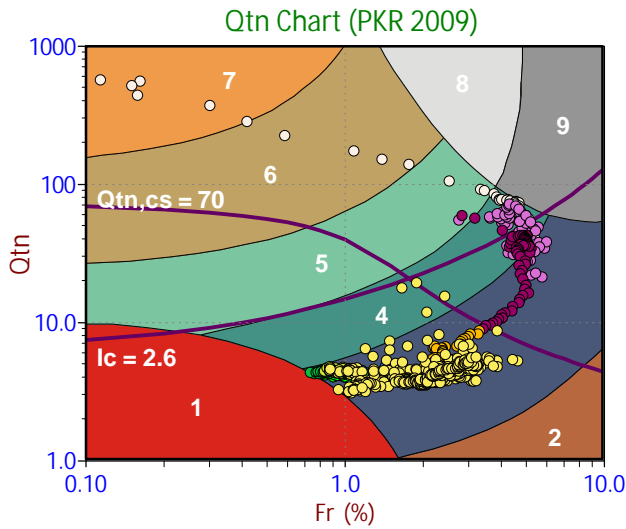

Depth Ranges

- >0.0 to 5.0 ft
- >5.0 to 10.0 ft
- >10.0 to 15.0 ft
- >15.0 to 20.0 ft
- >20.0 to 25.0 ft
- >25.0 to 30.0 ft
- >30.0 to 35.0 ft
- >35.0 to 40.0 ft
- >40.0 to 45.0 ft
- >45.0 to 50.0 ft
- >50.0 ft

Legend

- Sensitive, Fine Grained
- Organic Soils
- Clays
- Silt Mixtures
- Sand Mixtures
- Sands
- Gravelly Sand to Sand
- Stiff Sand to Clayey Sand
- Very Stiff Fine Grained

Legend

- CCS (Cont. sensitive clay like)
- CC (Cont. clay like)
- TC (Cont. transitional)
- SC (Cont. sand like)
- CD (Dil. clay like)
- TD (Dil. transitional)
- SD (Dil. sand like)

Legend

- Sensitive Fines
- Organic Soil
- Clay
- Silty Clay
- Clayey Silt
- Silt
- Sandy Silt
- Silty Sand/Sand
- Sand
- Gravelly Sand
- Stiff Fine Grained
- Cemented Sand

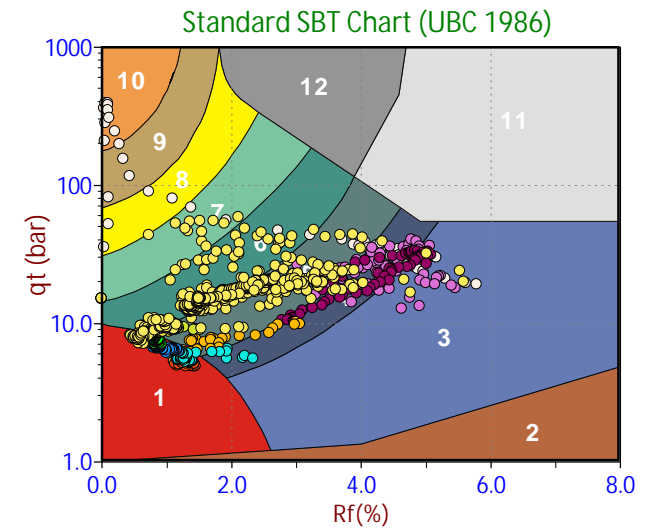
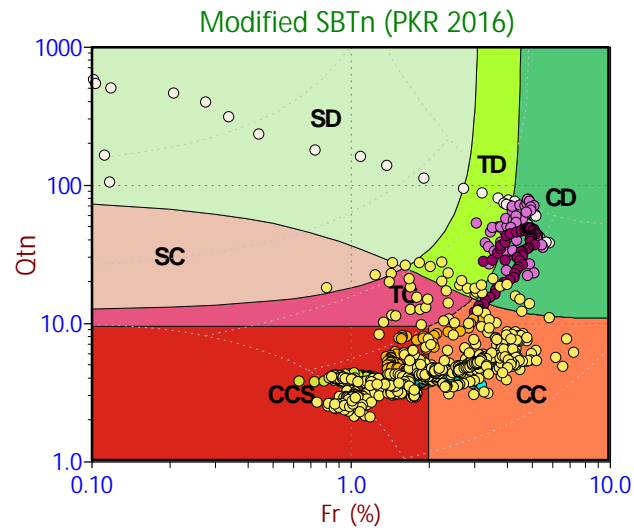
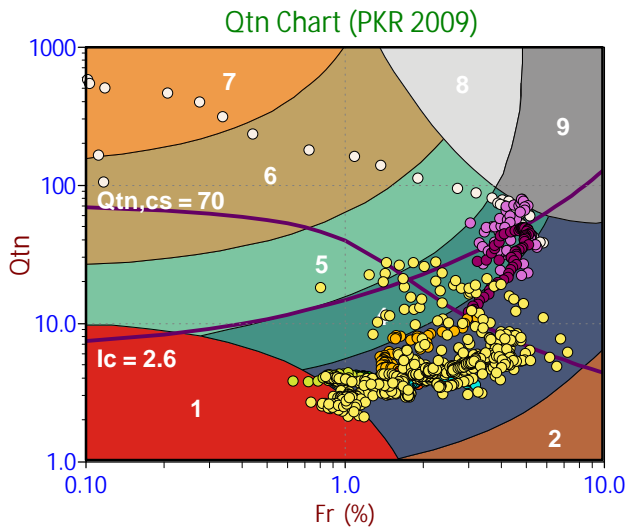

Depth Ranges

- >0.0 to 5.0 ft
- >5.0 to 10.0 ft
- >10.0 to 15.0 ft
- >15.0 to 20.0 ft
- >20.0 to 25.0 ft
- >25.0 to 30.0 ft
- >30.0 to 35.0 ft
- >35.0 to 40.0 ft
- >40.0 to 45.0 ft
- >45.0 to 50.0 ft
- >50.0 ft

Legend

- Sensitive, Fine Grained
- Organic Soils
- Clays
- Silt Mixtures
- Sand Mixtures
- Sands
- Gravelly Sand to Sand
- Stiff Sand to Clayey Sand
- Very Stiff Fine Grained

Legend

- CCS (Cont. sensitive clay like)
- CC (Cont. clay like)
- TC (Cont. transitional)
- SC (Cont. sand like)
- CD (Dil. clay like)
- TD (Dil. transitional)
- SD (Dil. sand like)

Legend

- Sensitive Fines
- Organic Soil
- Clay
- Silty Clay
- Clayey Silt
- Silt
- Sandy Silt
- Silty Sand/Sand
- Sand
- Gravelly Sand
- Stiff Fine Grained
- Cemented Sand

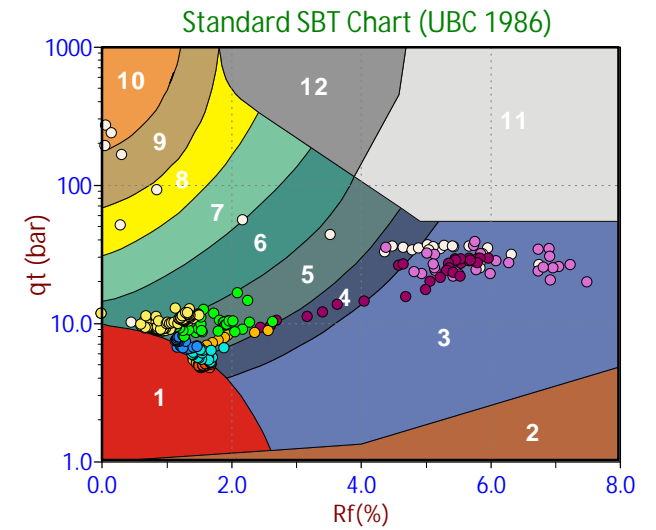
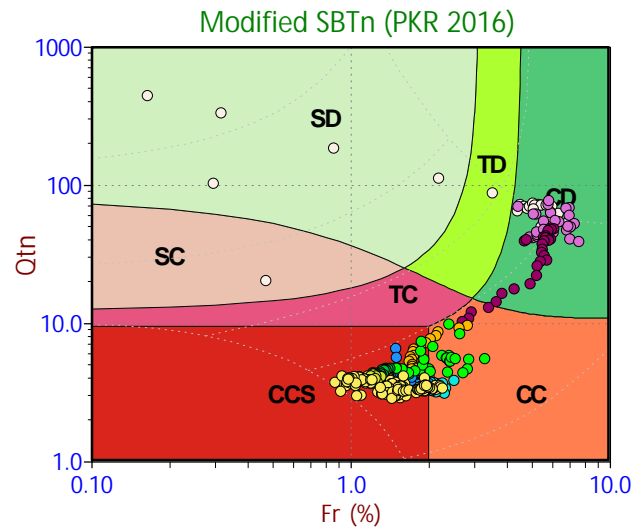
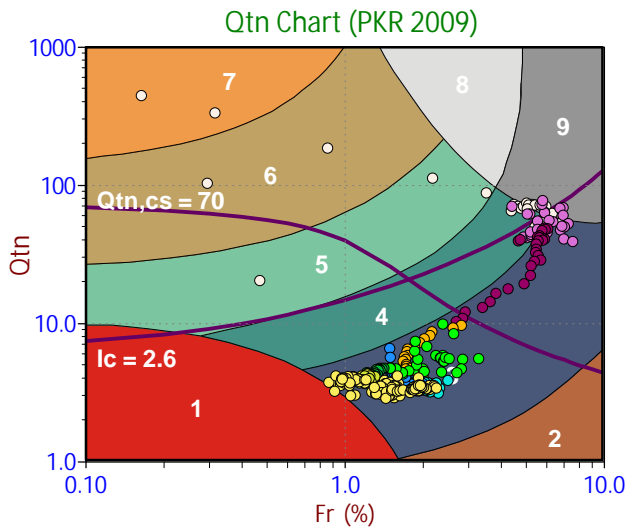

Depth Ranges

- >0.0 to 5.0 ft
- >5.0 to 10.0 ft
- >10.0 to 15.0 ft
- >15.0 to 20.0 ft
- >20.0 to 25.0 ft
- >25.0 to 30.0 ft
- >30.0 to 35.0 ft
- >35.0 to 40.0 ft
- >40.0 to 45.0 ft
- >45.0 to 50.0 ft
- >50.0 ft

Legend

- Sensitive, Fine Grained
- Organic Soils
- Clays
- Silt Mixtures
- Sand Mixtures
- Sands
- Gravelly Sand to Sand
- Stiff Sand to Clayey Sand
- Very Stiff Fine Grained

Legend

- CCS (Cont. sensitive clay like)
- CC (Cont. clay like)
- TC (Cont. transitional)
- SC (Cont. sand like)
- CD (Dil. clay like)
- TD (Dil. transitional)
- SD (Dil. sand like)

Legend

- Sensitive Fines
- Organic Soil
- Clay
- Silty Clay
- Clayey Silt
- Silt
- Sandy Silt
- Silty Sand/Sand
- Sand
- Gravelly Sand
- Stiff Fine Grained
- Cemented Sand

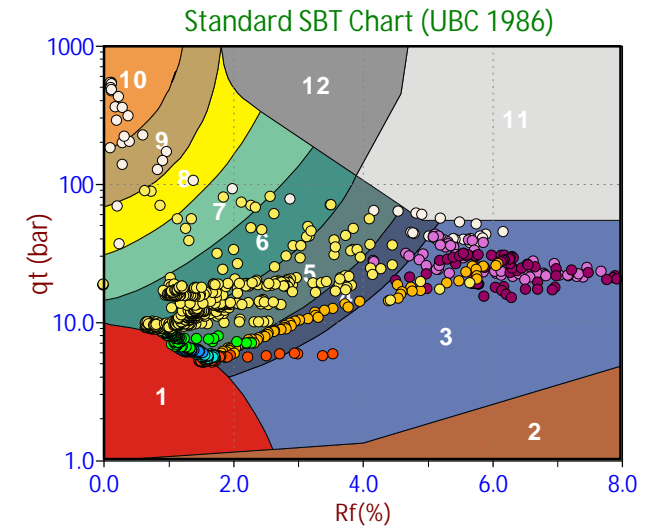
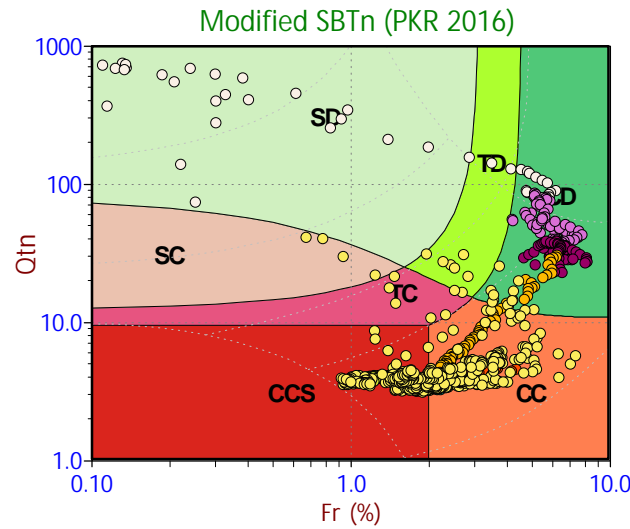
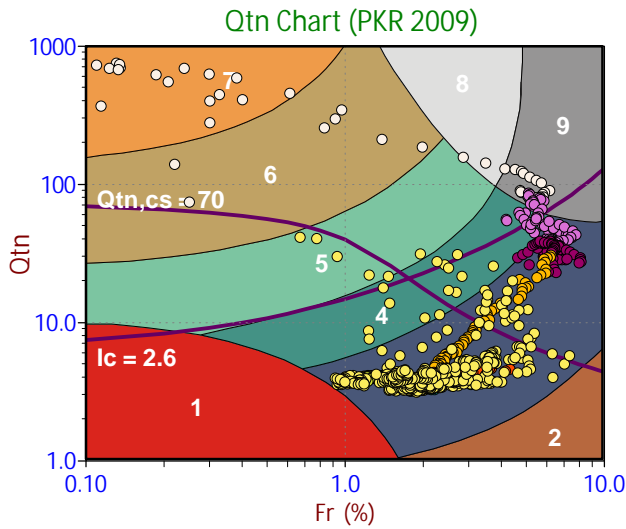

Depth Ranges

- >0.0 to 5.0 ft
- >5.0 to 10.0 ft
- >10.0 to 15.0 ft
- >15.0 to 20.0 ft
- >20.0 to 25.0 ft
- >25.0 to 30.0 ft
- >30.0 to 35.0 ft
- >35.0 to 40.0 ft
- >40.0 to 45.0 ft
- >45.0 to 50.0 ft
- >50.0 ft

Legend

- Sensitive, Fine Grained
- Organic Soils
- Clays
- Silt Mixtures
- Sand Mixtures
- Sands
- Gravelly Sand to Sand
- Stiff Sand to Clayey Sand
- Very Stiff Fine Grained

Legend

- CCS (Cont. sensitive clay like)
- CC (Cont. clay like)
- TC (Cont. transitional)
- SC (Cont. sand like)
- CD (Dil. clay like)
- TD (Dil. transitional)
- SD (Dil. sand like)

Legend

- Sensitive Fines
- Organic Soil
- Clay
- Silty Clay
- Clayey Silt
- Silt
- Sandy Silt
- Silty Sand/Sand
- Sand
- Gravelly Sand
- Stiff Fine Grained
- Cemented Sand

Qtn Chart (PKR 2009)

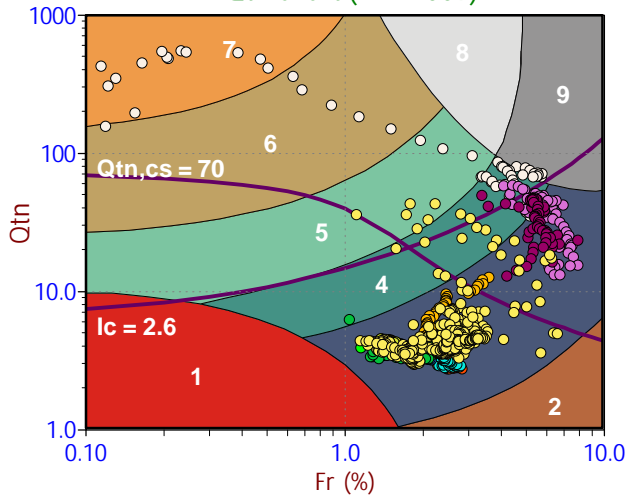

Modified SBTn (PKR 2016)

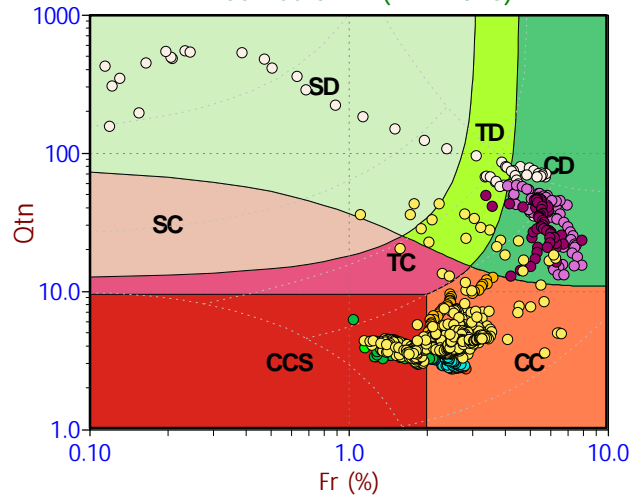

Standard SBT Chart (UBC 1986)

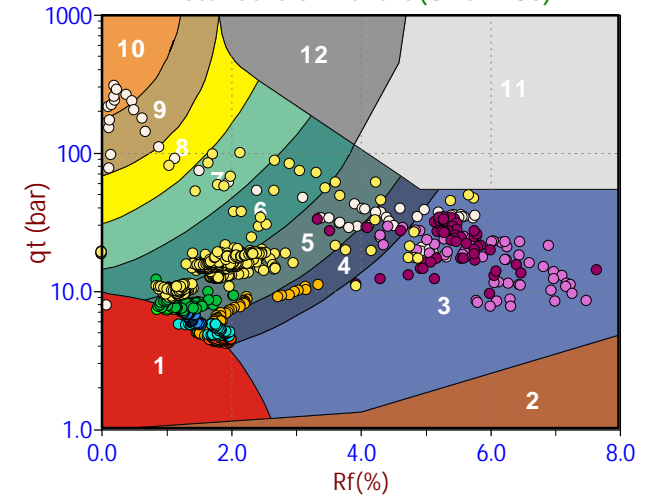

Depth Ranges

- >0.0 to 5.0 ft
- >5.0 to 10.0 ft
- >10.0 to 15.0 ft
- >15.0 to 20.0 ft
- >20.0 to 25.0 ft
- >25.0 to 30.0 ft
- >30.0 to 35.0 ft
- >35.0 to 40.0 ft
- >40.0 to 45.0 ft
- >45.0 to 50.0 ft
- >50.0 ft

Legend

- Sensitive, Fine Grained
- Organic Soils
- Clays
- Silt Mixtures
- Sand Mixtures
- Sands
- Gravelly Sand to Sand
- Stiff Sand to Clayey Sand
- Very Stiff Fine Grained

Legend

- CCS (Cont. sensitive clay like)
- CC (Cont. clay like)
- TC (Cont. transitional)
- SC (Cont. sand like)
- CD (Dil. clay like)
- TD (Dil. transitional)
- SD (Dil. sand like)

Legend

- Sensitive Fines
- Organic Soil
- Clay
- Silty Clay
- Clayey Silt
- Silt
- Sandy Silt
- Silty Sand/Sand
- Sand
- Gravelly Sand
- Stiff Fine Grained
- Cemented Sand

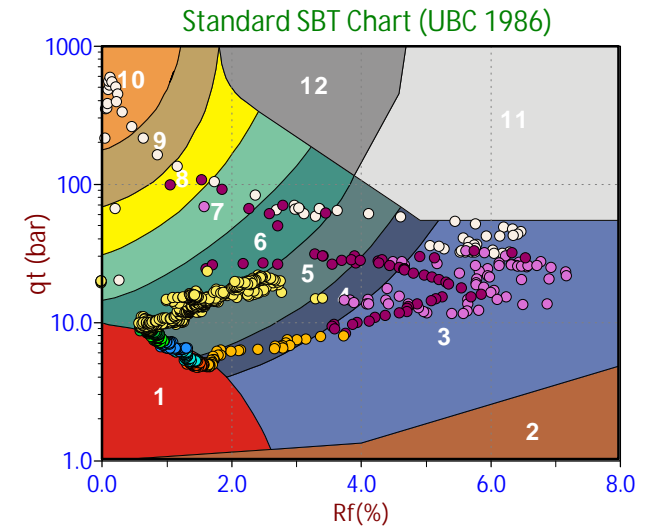
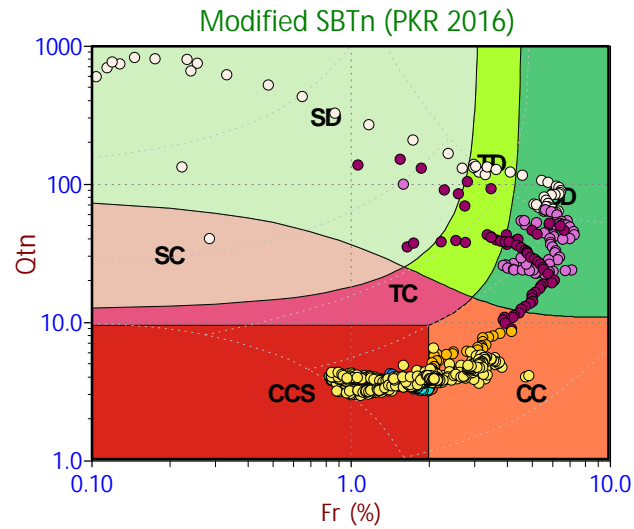
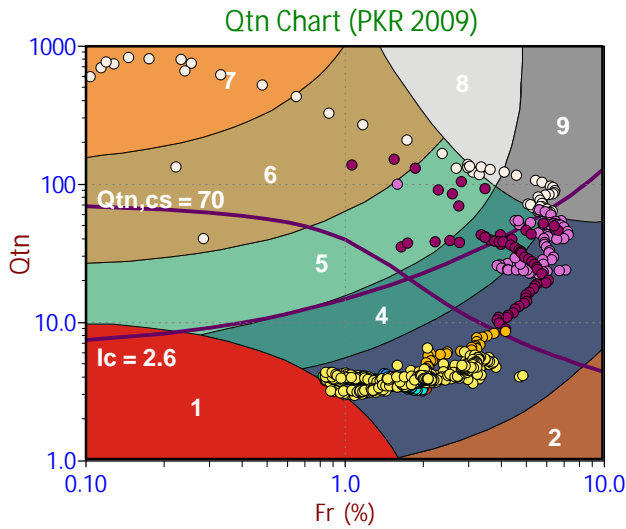

Depth Ranges

- >0.0 to 5.0 ft
- >5.0 to 10.0 ft
- >10.0 to 15.0 ft
- >15.0 to 20.0 ft
- >20.0 to 25.0 ft
- >25.0 to 30.0 ft
- >30.0 to 35.0 ft
- >35.0 to 40.0 ft
- >40.0 to 45.0 ft
- >45.0 to 50.0 ft
- >50.0 ft

Legend

- Sensitive, Fine Grained
- Organic Soils
- Clays
- Silt Mixtures
- Sand Mixtures
- Sands
- Gravelly Sand to Sand
- Stiff Sand to Clayey Sand
- Very Stiff Fine Grained

Legend

- CCS (Cont. sensitive clay like)
- CC (Cont. clay like)
- TC (Cont. transitional)
- SC (Cont. sand like)
- CD (Dil. clay like)
- TD (Dil. transitional)
- SD (Dil. sand like)

Legend

- Sensitive Fines
- Organic Soil
- Clay
- Silty Clay
- Clayey Silt
- Silt
- Sandy Silt
- Silty Sand/Sand
- Sand
- Gravelly Sand
- Stiff Fine Grained
- Cemented Sand

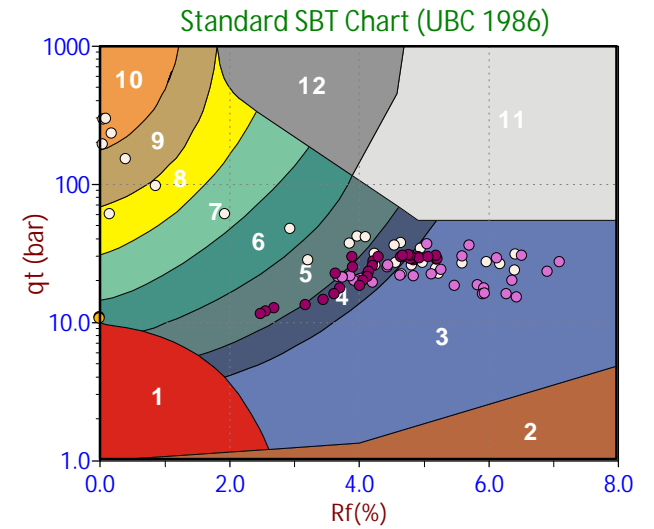
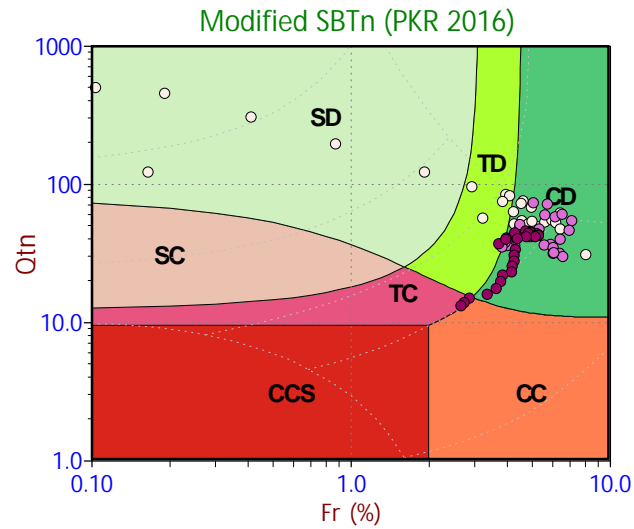
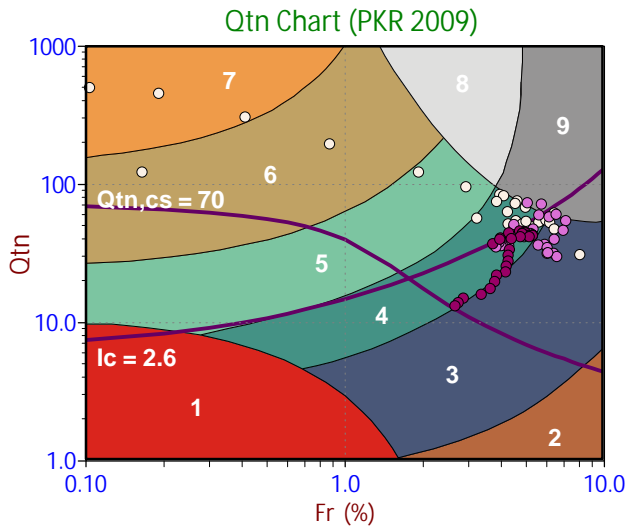

Depth Ranges

- >0.0 to 5.0 ft
- >5.0 to 10.0 ft
- >10.0 to 15.0 ft
- >15.0 to 20.0 ft
- >20.0 to 25.0 ft
- >25.0 to 30.0 ft
- >30.0 to 35.0 ft
- >35.0 to 40.0 ft
- >40.0 to 45.0 ft
- >45.0 to 50.0 ft
- >50.0 ft

Legend

- Sensitive, Fine Grained
- Organic Soils
- Clays
- Silt Mixtures
- Sand Mixtures
- Sands
- Gravelly Sand to Sand
- Stiff Sand to Clayey Sand
- Very Stiff Fine Grained

Legend

- CCS (Cont. sensitive clay like)
- CC (Cont. clay like)
- TC (Cont. transitional)
- SC (Cont. sand like)
- CD (Dil. clay like)
- TD (Dil. transitional)
- SD (Dil. sand like)

Legend

- Sensitive Fines
- Organic Soil
- Clay
- Silty Clay
- Clayey Silt
- Silt
- Sandy Silt
- Silty Sand/Sand
- Sand
- Gravelly Sand
- Stiff Fine Grained
- Cemented Sand

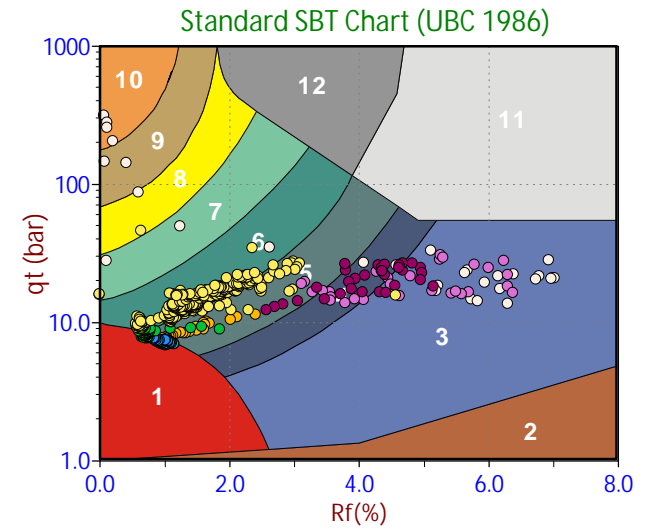
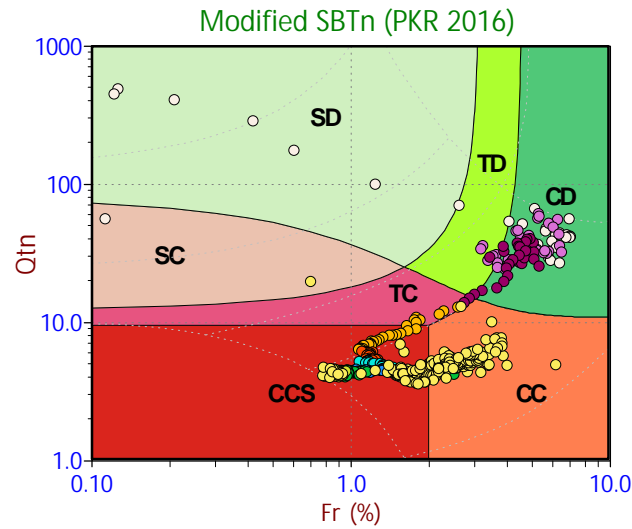
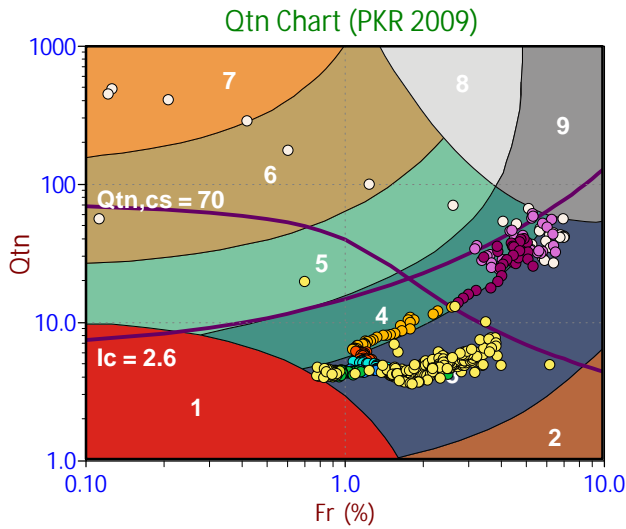

Depth Ranges

- >0.0 to 5.0 ft
- >5.0 to 10.0 ft
- >10.0 to 15.0 ft
- >15.0 to 20.0 ft
- >20.0 to 25.0 ft
- >25.0 to 30.0 ft
- >30.0 to 35.0 ft
- >35.0 to 40.0 ft
- >40.0 to 45.0 ft
- >45.0 to 50.0 ft
- >50.0 ft

Legend

- Sensitive, Fine Grained
- Organic Soils
- Clays
- Silt Mixtures
- Sand Mixtures
- Sands
- Gravelly Sand to Sand
- Stiff Sand to Clayey Sand
- Very Stiff Fine Grained

Legend

- CCS (Cont. sensitive clay like)
- CC (Cont. clay like)
- TC (Cont. transitional)
- SC (Cont. sand like)
- CD (Dil. clay like)
- TD (Dil. transitional)
- SD (Dil. sand like)

Legend

- Sensitive Fines
- Organic Soil
- Clay
- Silty Clay
- Clayey Silt
- Silt
- Sandy Silt
- Silty Sand/Sand
- Sand
- Gravelly Sand
- Stiff Fine Grained
- Cemented Sand

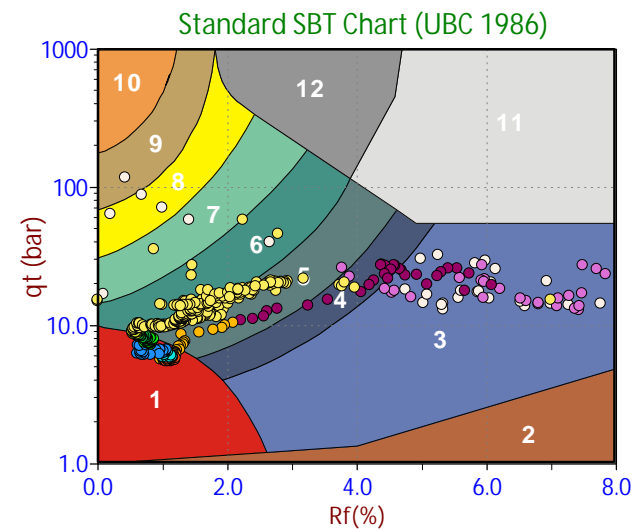
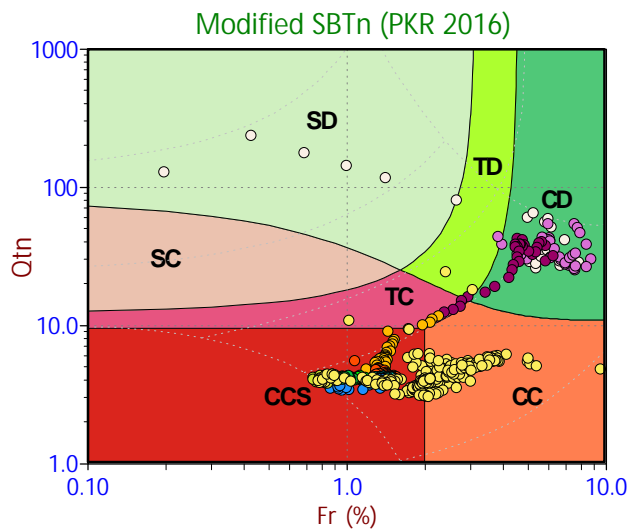
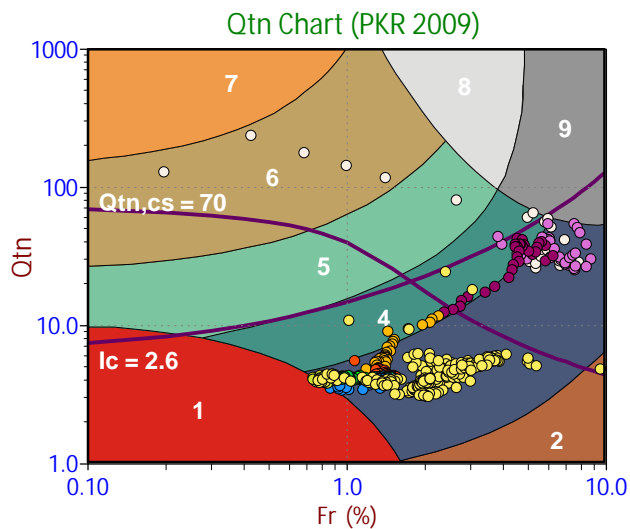

Depth Ranges

- >0.0 to 5.0 ft
- >5.0 to 10.0 ft
- >10.0 to 15.0 ft
- >15.0 to 20.0 ft
- >20.0 to 25.0 ft
- >25.0 to 30.0 ft
- >30.0 to 35.0 ft
- >35.0 to 40.0 ft
- >40.0 to 45.0 ft
- >45.0 to 50.0 ft
- >50.0 ft

Legend

- Sensitive, Fine Grained
- Organic Soils
- Clays
- Silt Mixtures
- Sand Mixtures
- Sands
- Gravelly Sand to Sand
- Stiff Sand to Clayey Sand
- Very Stiff Fine Grained

Legend

- CCS (Cont. sensitive clay like)
- CC (Cont. clay like)
- TC (Cont. transitional)
- SC (Cont. sand like)
- CD (Dil. clay like)
- TD (Dil. transitional)
- SD (Dil. sand like)

Legend

- Sensitive Fines
- Organic Soil
- Clay
- Silty Clay
- Clayey Silt
- Silt
- Sandy Silt
- Silty Sand/Sand
- Sand
- Gravelly Sand
- Stiff Fine Grained
- Cemented Sand

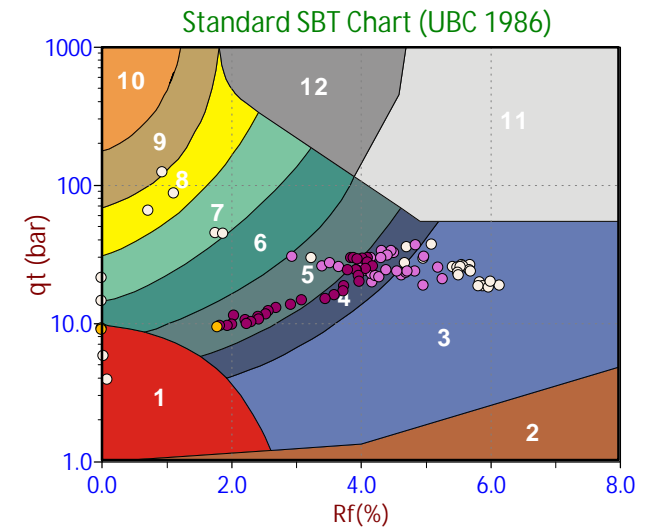
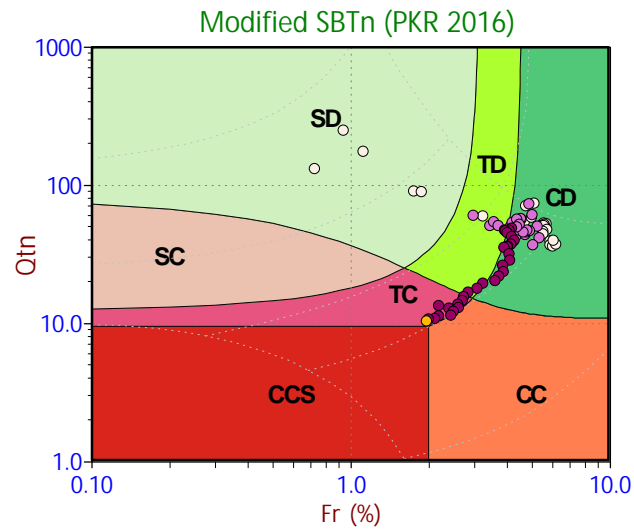
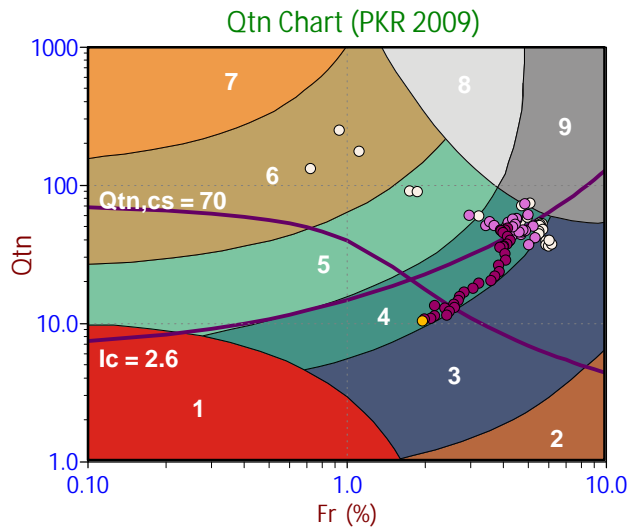

Depth Ranges

- >0.0 to 5.0 ft
- >5.0 to 10.0 ft
- >10.0 to 15.0 ft
- >15.0 to 20.0 ft
- >20.0 to 25.0 ft
- >25.0 to 30.0 ft
- >30.0 to 35.0 ft
- >35.0 to 40.0 ft
- >40.0 to 45.0 ft
- >45.0 to 50.0 ft
- >50.0 ft

Legend

- Sensitive, Fine Grained
- Organic Soils
- Clays
- Silt Mixtures
- Sand Mixtures
- Sands
- Gravelly Sand to Sand
- Stiff Sand to Clayey Sand
- Very Stiff Fine Grained

Legend

- CCS (Cont. sensitive clay like)
- CC (Cont. clay like)
- TC (Cont. transitional)
- SC (Cont. sand like)
- CD (Dil. clay like)
- TD (Dil. transitional)
- SD (Dil. sand like)

Legend

- Sensitive Fines
- Organic Soil
- Clay
- Silty Clay
- Clayey Silt
- Silt
- Sandy Silt
- Silty Sand/Sand
- Sand
- Gravelly Sand
- Stiff Fine Grained
- Cemented Sand



Qtn Chart (PKR 2009)

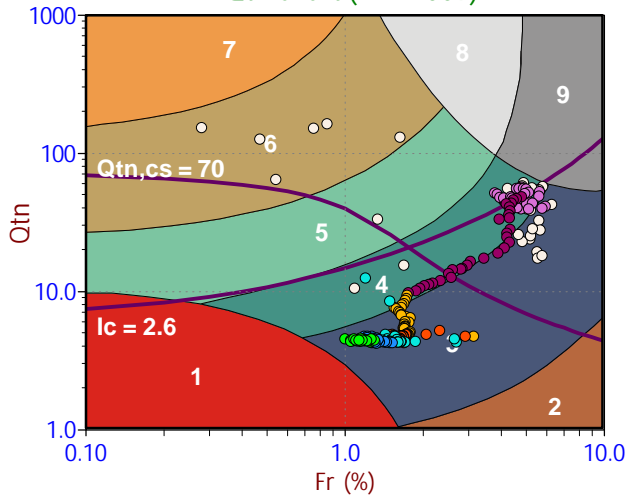

Modified SBTn (PKR 2016)

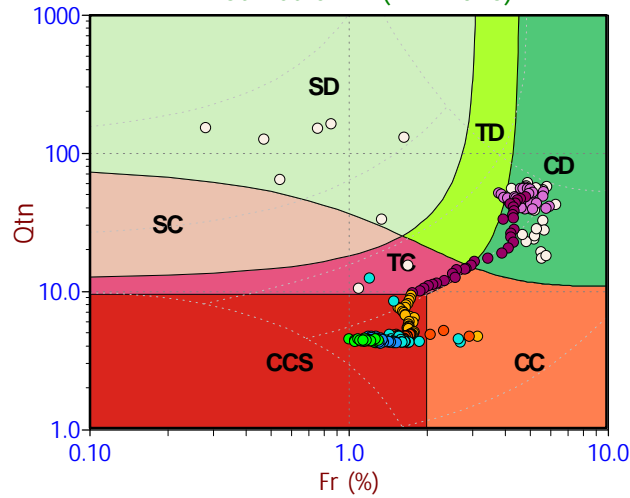

Standard SBT Chart (UBC 1986)

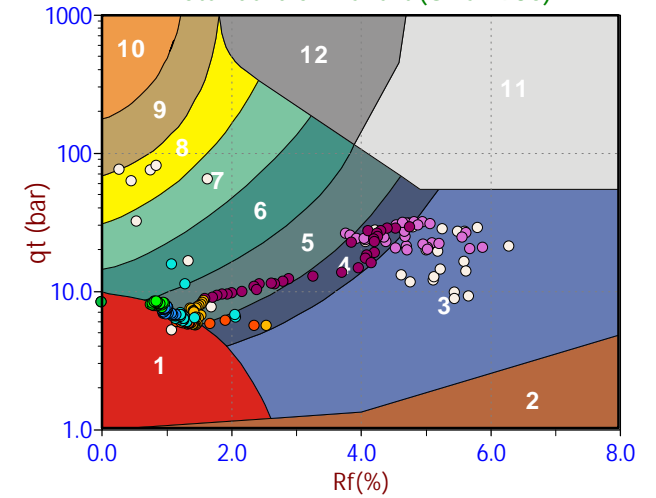

Depth Ranges

- >0.0 to 5.0 ft
- >5.0 to 10.0 ft
- >10.0 to 15.0 ft
- >15.0 to 20.0 ft
- >20.0 to 25.0 ft
- >25.0 to 30.0 ft
- >30.0 to 35.0 ft
- >35.0 to 40.0 ft
- >40.0 to 45.0 ft
- >45.0 to 50.0 ft
- >50.0 ft

Legend

- Sensitive, Fine Grained
- Organic Soils
- Clays
- Silt Mixtures
- Sand Mixtures
- Sands
- Gravelly Sand to Sand
- Stiff Sand to Clayey Sand
- Very Stiff Fine Grained

Legend

- CCS (Cont. sensitive clay like)
- CC (Cont. clay like)
- TC (Cont. transitional)
- SC (Cont. sand like)
- CD (Dil. clay like)
- TD (Dil. transitional)
- SD (Dil. sand like)

Legend

- Sensitive Fines
- Organic Soil
- Clay
- Silty Clay
- Clayey Silt
- Silt
- Sandy Silt
- Silty Sand/Sand
- Sand
- Gravelly Sand
- Stiff Fine Grained
- Cemented Sand

Qtn Chart (PKR 2009)

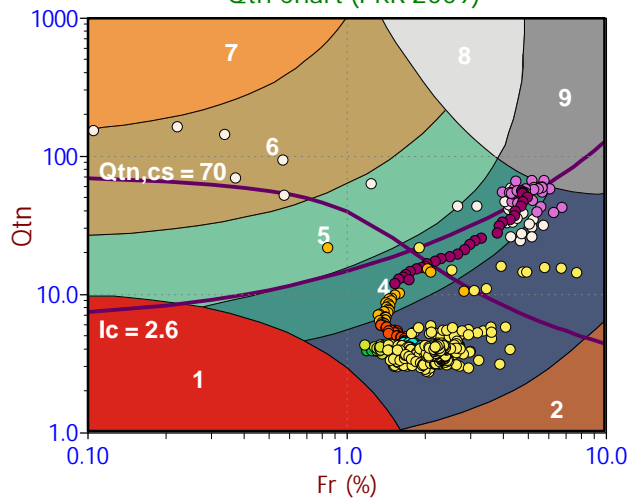

Modified SBTn (PKR 2016)

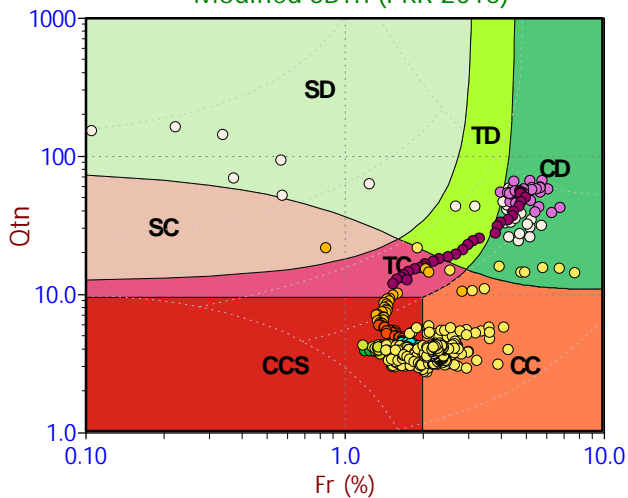

Standard SBT Chart (UBC 1986)

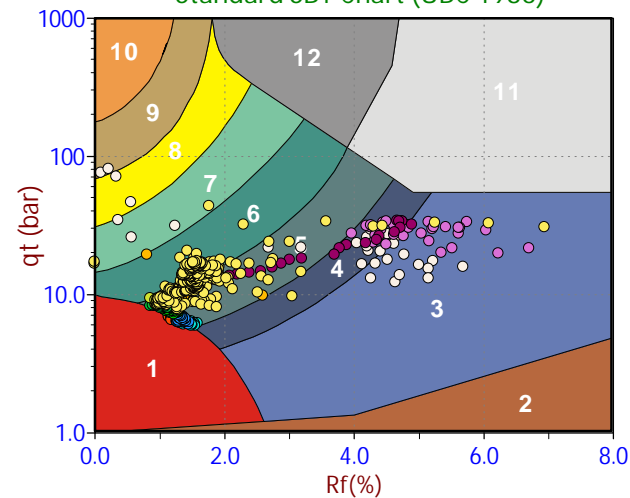

Depth Ranges

- >0.0 to 5.0 ft
- >5.0 to 10.0 ft
- >10.0 to 15.0 ft
- >15.0 to 20.0 ft
- >20.0 to 25.0 ft
- >25.0 to 30.0 ft
- >30.0 to 35.0 ft
- >35.0 to 40.0 ft
- >40.0 to 45.0 ft
- >45.0 to 50.0 ft
- >50.0 ft

Legend

- Sensitive, Fine Grained
- Organic Soils
- Clays
- Silt Mixtures
- Sand Mixtures
- Sands
- Gravelly Sand to Sand
- Stiff Sand to Clayey Sand
- Very Stiff Fine Grained

Legend

- CCS (Cont. sensitive clay like)
- CC (Cont. clay like)
- TC (Cont. transitional)
- SC (Cont. sand like)
- CD (Dil. clay like)
- TD (Dil. transitional)
- SD (Dil. sand like)

Legend

- Sensitive Fines
- Organic Soil
- Clay
- Silty Clay
- Clayey Silt
- Silt
- Sandy Silt
- Silty Sand/Sand
- Sand
- Gravelly Sand
- Stiff Fine Grained
- Cemented Sand

Qtn Chart (PKR 2009)

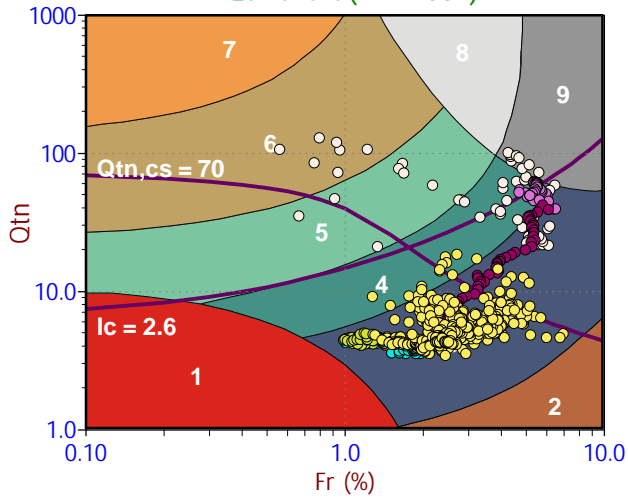

Modified SBTn (PKR 2016)

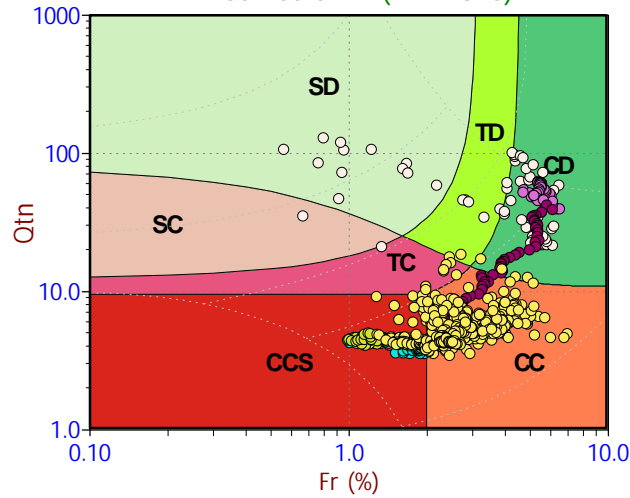

Standard SBT Chart (UBC 1986)

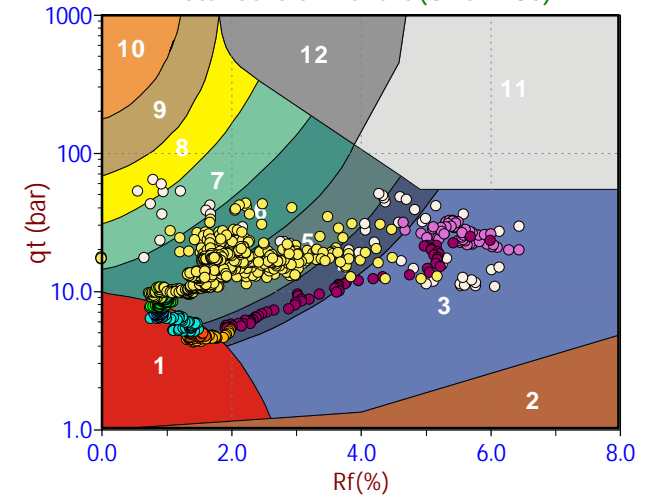

Depth Ranges

- >0.0 to 5.0 ft
- >5.0 to 10.0 ft
- >10.0 to 15.0 ft
- >15.0 to 20.0 ft
- >20.0 to 25.0 ft
- >25.0 to 30.0 ft
- >30.0 to 35.0 ft
- >35.0 to 40.0 ft
- >40.0 to 45.0 ft
- >45.0 to 50.0 ft
- >50.0 ft

Legend

- Sensitive, Fine Grained
- Organic Soils
- Clays
- Silt Mixtures
- Sand Mixtures
- Sands
- Gravelly Sand to Sand
- Stiff Sand to Clayey Sand
- Very Stiff Fine Grained

Legend

- CCS (Cont. sensitive clay like)
- CC (Cont. clay like)
- TC (Cont. transitional)
- SC (Cont. sand like)
- CD (Dil. clay like)
- TD (Dil. transitional)
- SD (Dil. sand like)

Legend

- Sensitive Fines
- Organic Soil
- Clay
- Silty Clay
- Clayey Silt
- Silt
- Sandy Silt
- Silty Sand/Sand
- Sand
- Gravelly Sand
- Stiff Fine Grained
- Cemented Sand

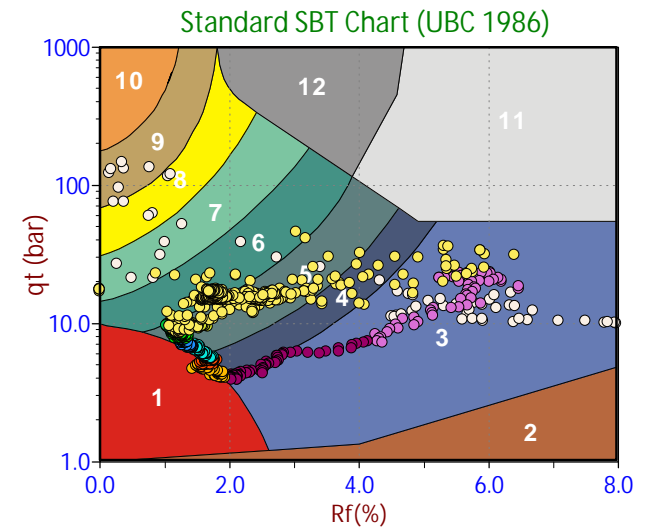
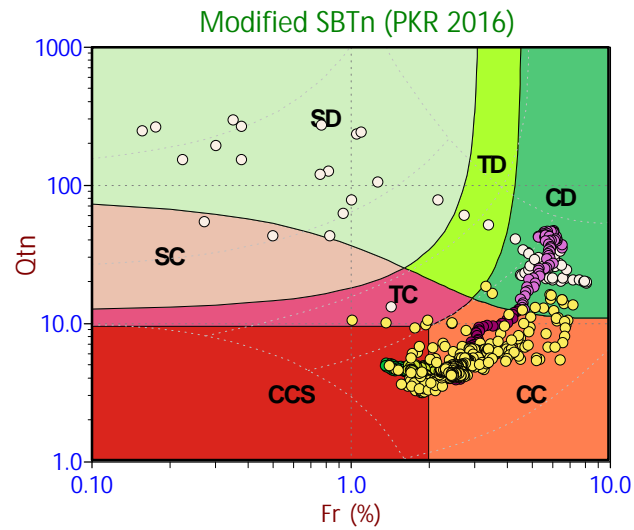
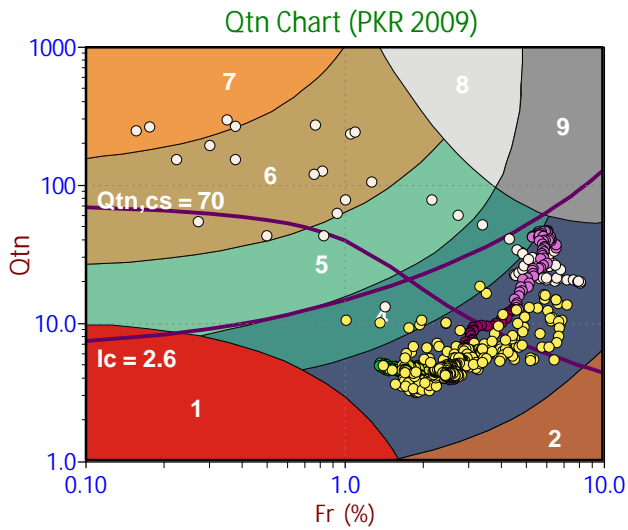

Depth Ranges

- >0.0 to 5.0 ft
- >5.0 to 10.0 ft
- >10.0 to 15.0 ft
- >15.0 to 20.0 ft
- >20.0 to 25.0 ft
- >25.0 to 30.0 ft
- >30.0 to 35.0 ft
- >35.0 to 40.0 ft
- >40.0 to 45.0 ft
- >45.0 to 50.0 ft
- >50.0 ft

Legend

- Sensitive, Fine Grained
- Organic Soils
- Clays
- Silt Mixtures
- Sand Mixtures
- Sands
- Gravelly Sand to Sand
- Stiff Sand to Clayey Sand
- Very Stiff Fine Grained

Legend

- CCS (Cont. sensitive clay like)
- CC (Cont. clay like)
- TC (Cont. transitional)
- SC (Cont. sand like)
- CD (Dil. clay like)
- TD (Dil. transitional)
- SD (Dil. sand like)

Legend

- Sensitive Fines
- Organic Soil
- Clay
- Silty Clay
- Clayey Silt
- Silt
- Sandy Silt
- Silty Sand/Sand
- Sand
- Gravelly Sand
- Stiff Fine Grained
- Cemented Sand

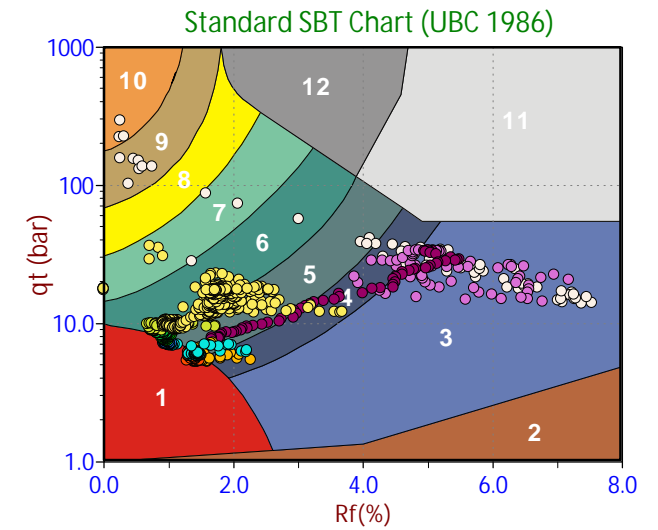
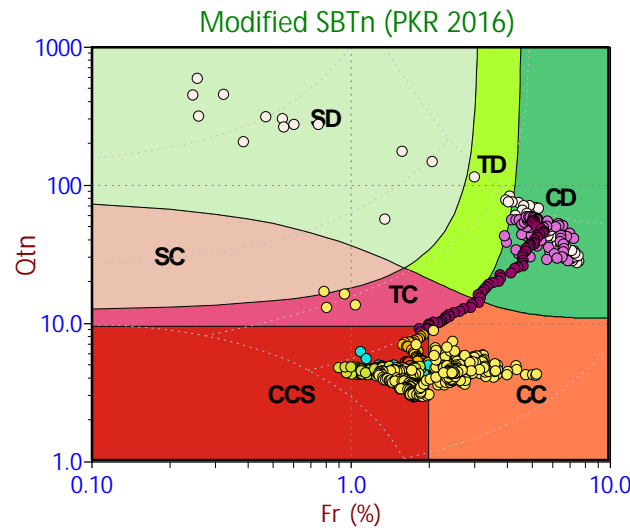
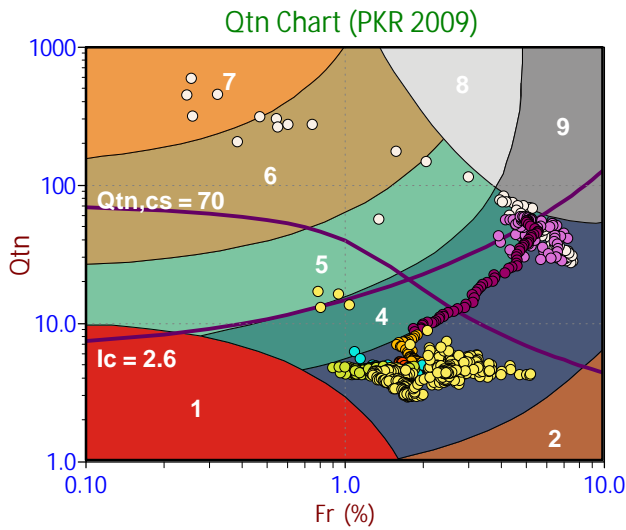

Depth Ranges

- >0.0 to 5.0 ft
- >5.0 to 10.0 ft
- >10.0 to 15.0 ft
- >15.0 to 20.0 ft
- >20.0 to 25.0 ft
- >25.0 to 30.0 ft
- >30.0 to 35.0 ft
- >35.0 to 40.0 ft
- >40.0 to 45.0 ft
- >45.0 to 50.0 ft
- >50.0 ft

Legend

- Sensitive, Fine Grained
- Organic Soils
- Clays
- Silt Mixtures
- Sand Mixtures
- Sands
- Gravelly Sand to Sand
- Stiff Sand to Clayey Sand
- Very Stiff Fine Grained

Legend

- CCS (Cont. sensitive clay like)
- CC (Cont. clay like)
- TC (Cont. transitional)
- SC (Cont. sand like)
- CD (Dil. clay like)
- TD (Dil. transitional)
- SD (Dil. sand like)

Legend

- Sensitive Fines
- Organic Soil
- Clay
- Silty Clay
- Clayey Silt
- Silt
- Sandy Silt
- Silty Sand/Sand
- Sand
- Gravelly Sand
- Stiff Fine Grained
- Cemented Sand

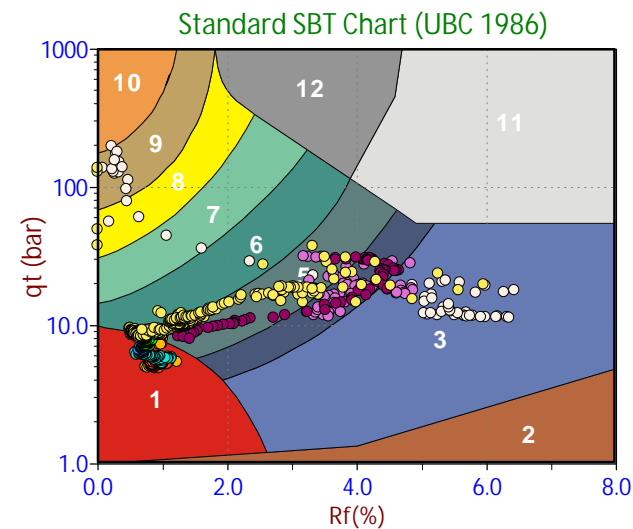
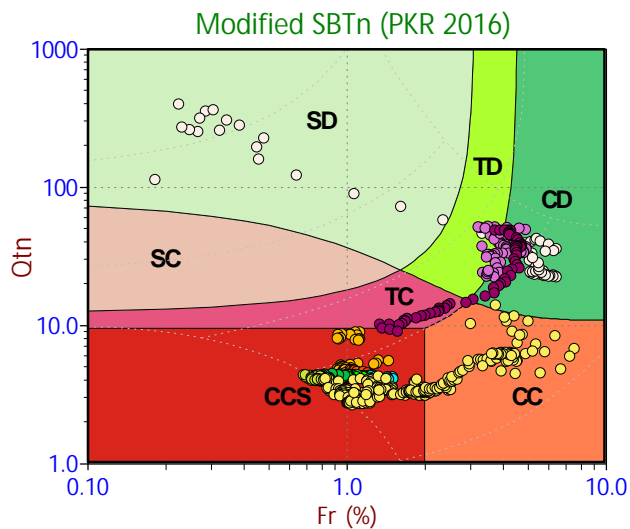
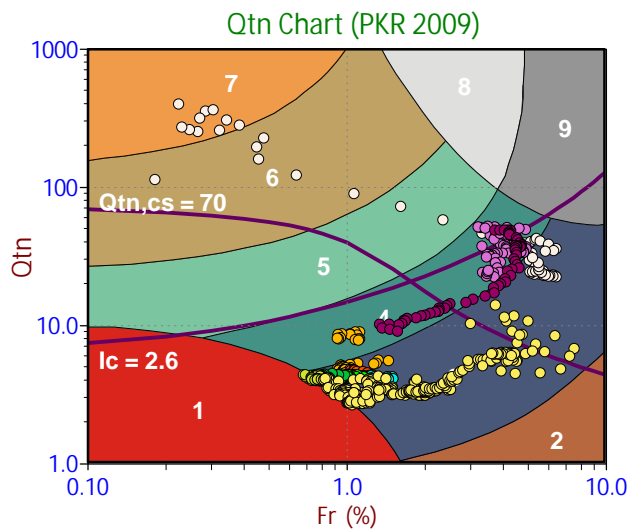

Depth Ranges

- >0.0 to 5.0 ft
- >5.0 to 10.0 ft
- >10.0 to 15.0 ft
- >15.0 to 20.0 ft
- >20.0 to 25.0 ft
- >25.0 to 30.0 ft
- >30.0 to 35.0 ft
- >35.0 to 40.0 ft
- >40.0 to 45.0 ft
- >45.0 to 50.0 ft
- >50.0 ft

Legend

- Sensitive, Fine Grained
- Organic Soils
- Clays
- Silt Mixtures
- Sand Mixtures
- Sands
- Gravelly Sand to Sand
- Stiff Sand to Clayey Sand
- Very Stiff Fine Grained

Legend

- CCS (Cont. sensitive clay like)
- CC (Cont. clay like)
- TC (Cont. transitional)
- SC (Cont. sand like)
- CD (Dil. clay like)
- TD (Dil. transitional)
- SD (Dil. sand like)

Legend

- Sensitive Fines
- Organic Soil
- Clay
- Silty Clay
- Clayey Silt
- Silt
- Sandy Silt
- Silty Sand/Sand
- Sand
- Gravelly Sand
- Stiff Fine Grained
- Cemented Sand

Qtn Chart (PKR 2009)

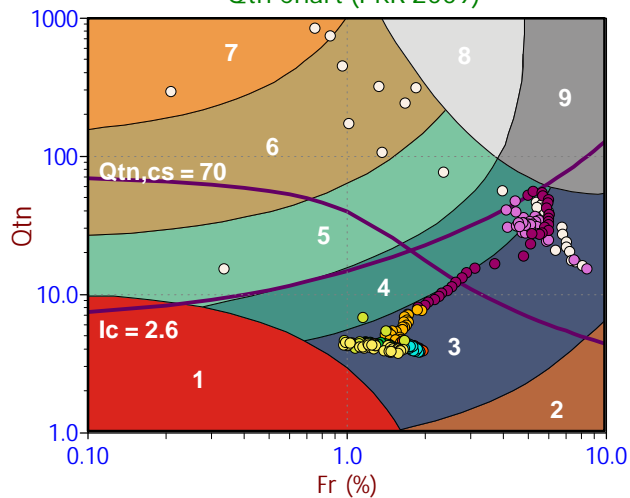

Modified SBTn (PKR 2016)

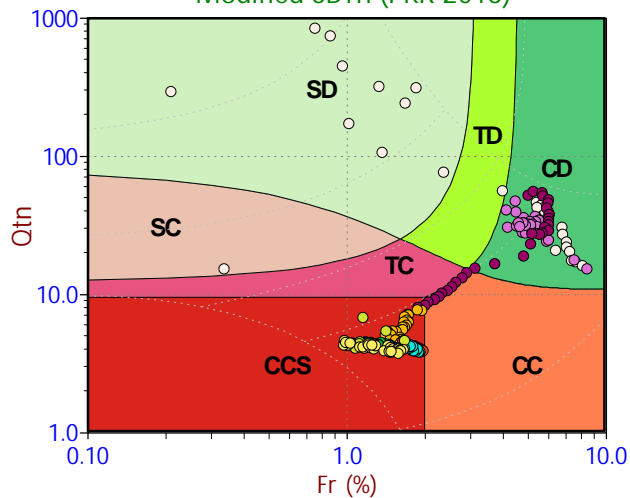

Standard SBT Chart (UBC 1986)

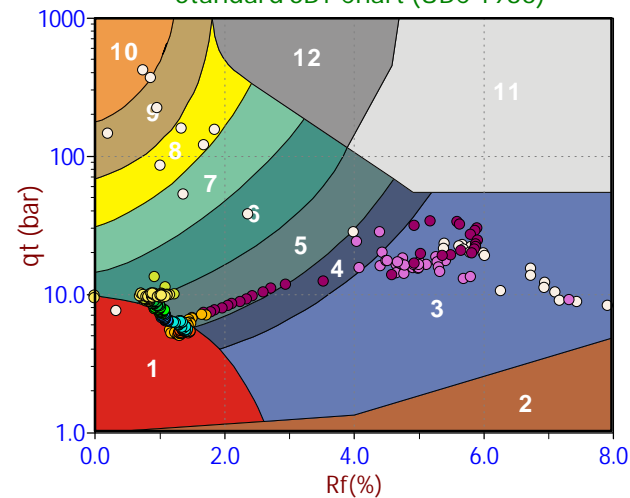

Depth Ranges

- >0.0 to 5.0 ft
- >5.0 to 10.0 ft
- >10.0 to 15.0 ft
- >15.0 to 20.0 ft
- >20.0 to 25.0 ft
- >25.0 to 30.0 ft
- >30.0 to 35.0 ft
- >35.0 to 40.0 ft
- >40.0 to 45.0 ft
- >45.0 to 50.0 ft
- >50.0 ft

Legend

- Sensitive, Fine Grained
- Organic Soils
- Clays
- Silt Mixtures
- Sand Mixtures
- Sands
- Gravelly Sand to Sand
- Stiff Sand to Clayey Sand
- Very Stiff Fine Grained

Legend

- CCS (Cont. sensitive clay like)
- CC (Cont. clay like)
- TC (Cont. transitional)
- SC (Cont. sand like)
- CD (Dil. clay like)
- TD (Dil. transitional)
- SD (Dil. sand like)

Legend

- Sensitive Fines
- Organic Soil
- Clay
- Silty Clay
- Clayey Silt
- Silt
- Sandy Silt
- Silty Sand/Sand
- Sand
- Gravelly Sand
- Stiff Fine Grained
- Cemented Sand

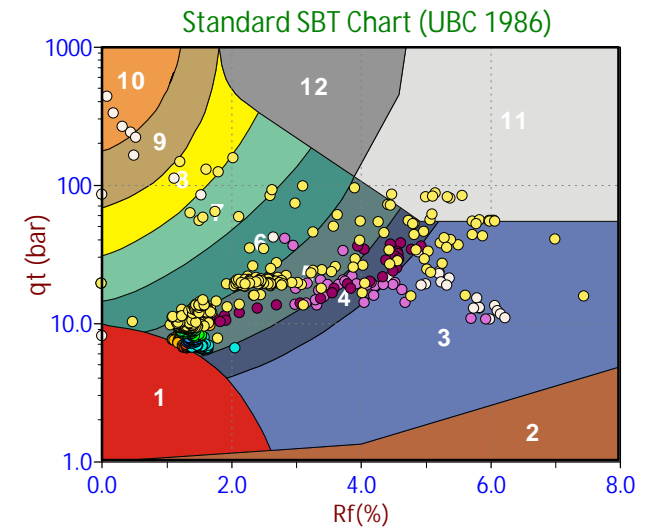
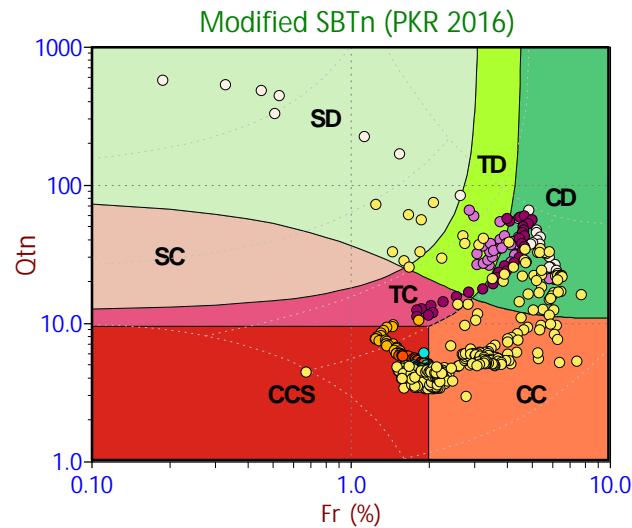
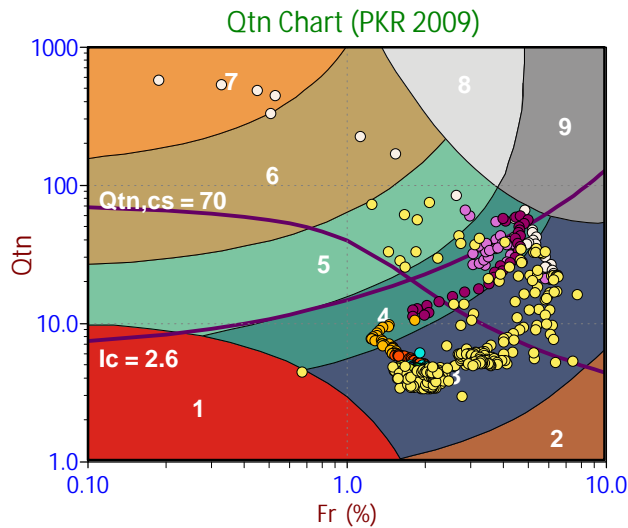

Depth Ranges

- >0.0 to 5.0 ft
- >5.0 to 10.0 ft
- >10.0 to 15.0 ft
- >15.0 to 20.0 ft
- >20.0 to 25.0 ft
- >25.0 to 30.0 ft
- >30.0 to 35.0 ft
- >35.0 to 40.0 ft
- >40.0 to 45.0 ft
- >45.0 to 50.0 ft
- >50.0 ft

Legend

- Sensitive, Fine Grained
- Organic Soils
- Clays
- Silt Mixtures
- Sand Mixtures
- Sands
- Gravelly Sand to Sand
- Stiff Sand to Clayey Sand
- Very Stiff Fine Grained

Legend

- CCS (Cont. sensitive clay like)
- CC (Cont. clay like)
- TC (Cont. transitional)
- SC (Cont. sand like)
- CD (Dil. clay like)
- TD (Dil. transitional)
- SD (Dil. sand like)

Legend

- Sensitive Fines
- Organic Soil
- Clay
- Silty Clay
- Clayey Silt
- Silt
- Sandy Silt
- Silty Sand/Sand
- Sand
- Gravelly Sand
- Stiff Fine Grained
- Cemented Sand

APPENDIX I2 – PPD TEST RESULTS



Geosyntec

Job No: 20-61-21681
Date: 12/11/2020 08:28
Site: DTE Belle River Power Plant

Sounding: CPT20-01B
Cone: 551:T1500F15U500 Area=15 cm²

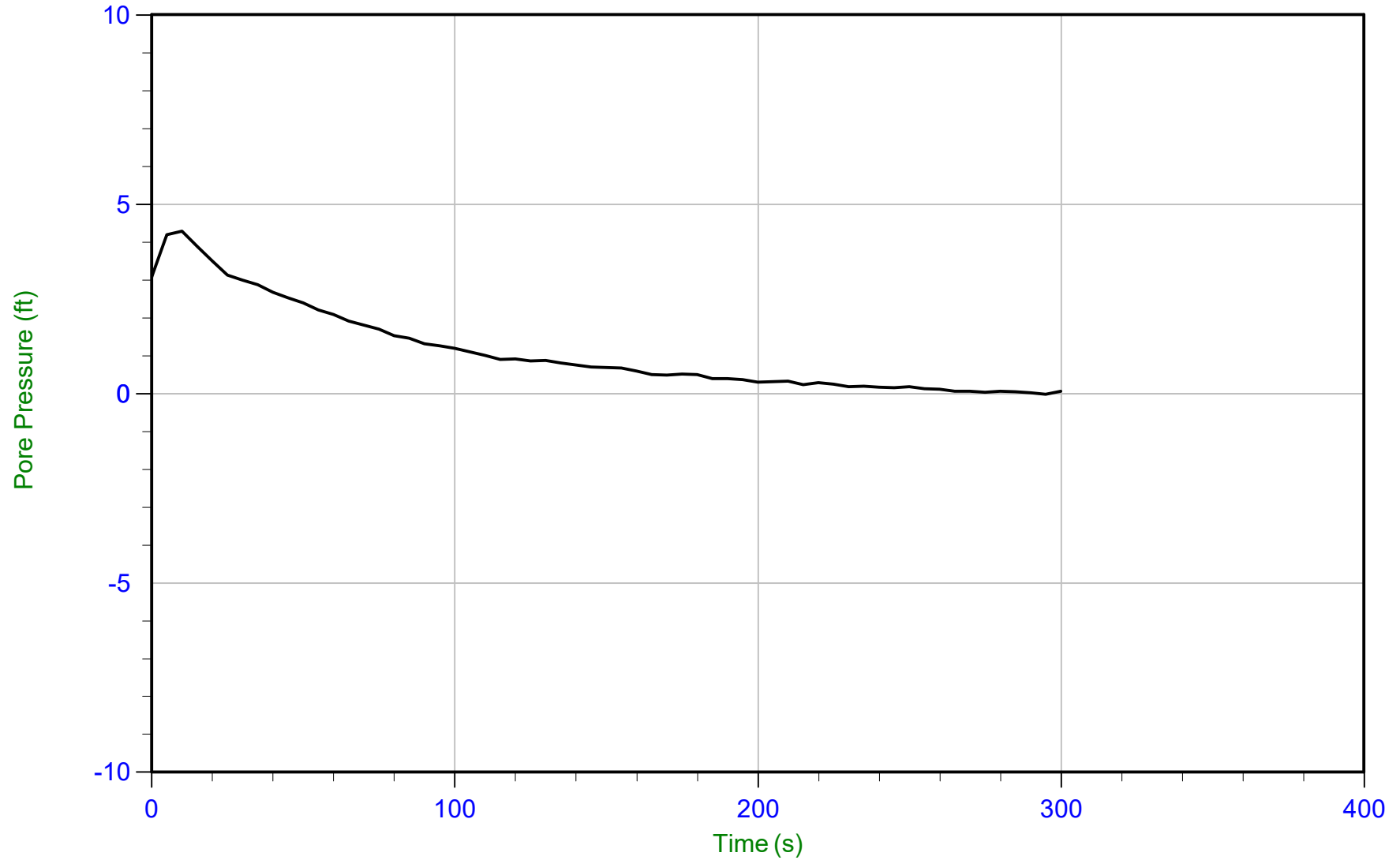

Trace Summary:

Filename: 20-61-21681_CP01B.PPF
Depth: 0.650 m / 2.133 ft
Duration: 300.0 s

u Min: -0.0 ft
u Max: 4.3 ft
u Final: 0.1 ft

WT: 0.650 m / 2.133 ft
Ueq: 0.0 ft



Geosyntec

Job No: 20-61-21681
Date: 12/11/2020 08:28
Site: DTE Belle River Power Plant

Sounding: CPT20-01B
Cone: 551:T1500F15U500 Area=15 cm²

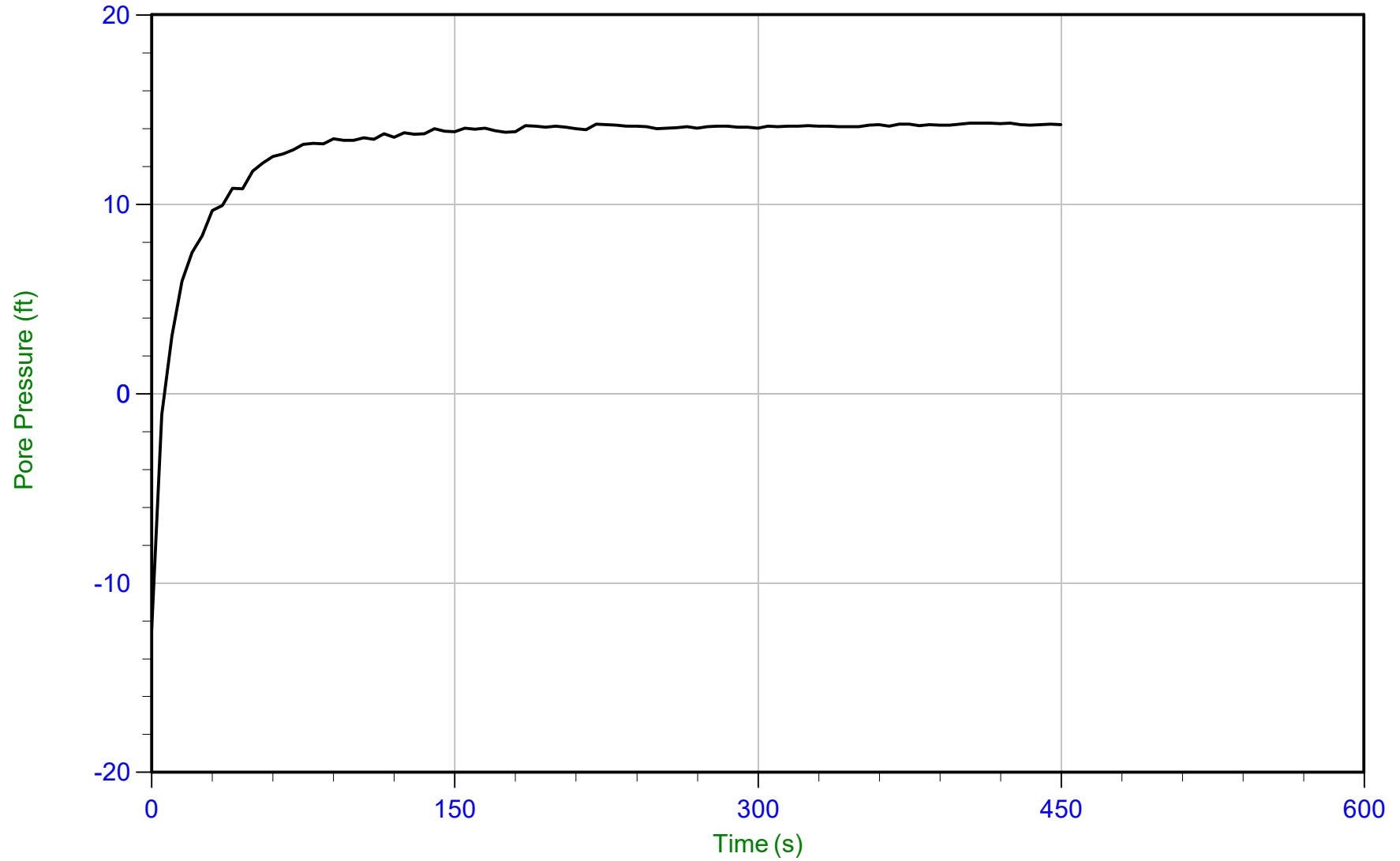

Trace Summary:

Filename: 20-61-21681_CP01B.PPF
Depth: 2.775 m / 9.104 ft
Duration: 450.0 s

u Min: -12.5 ft
u Max: 14.3 ft
u Final: 14.2 ft



Geosyntec

Job No: 20-61-21681
Date: 12/11/2020 08:28
Site: DTE Belle River Power Plant

Sounding: CPT20-01B
Cone: 551:T1500F15U500 Area=15 cm²

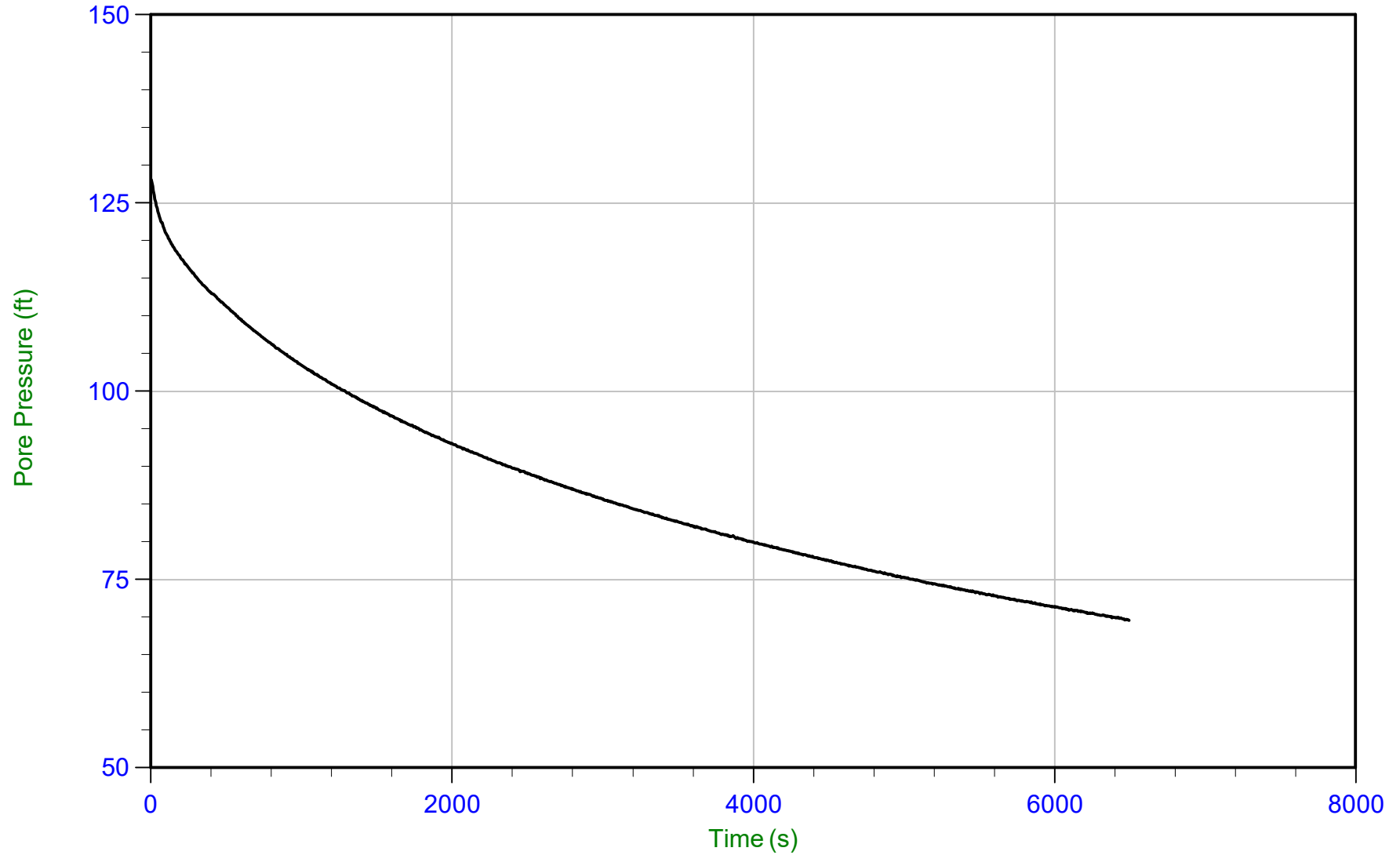

Trace Summary:

Filename: 20-61-21681_CP01B.PPF
Depth: 8.575 m / 28.133 ft
Duration: 6500.0 s

u Min: 69.6 ft
u Max: 128.1 ft
u Final: 69.6 ft

WT: 4.572 m / 15.000 ft
Ueq: 13.1 ft
U(50): 70.62 ft

T(50): 6203.4 s
lr: 100
Ch: 0.1 cm²/min



Geosyntec

Job No: 20-61-21681
Date: 12/11/2020 08:28
Site: DTE Belle River Power Plant

Sounding: CPT20-01B
Cone: 551:T1500F15U500 Area=15 cm²

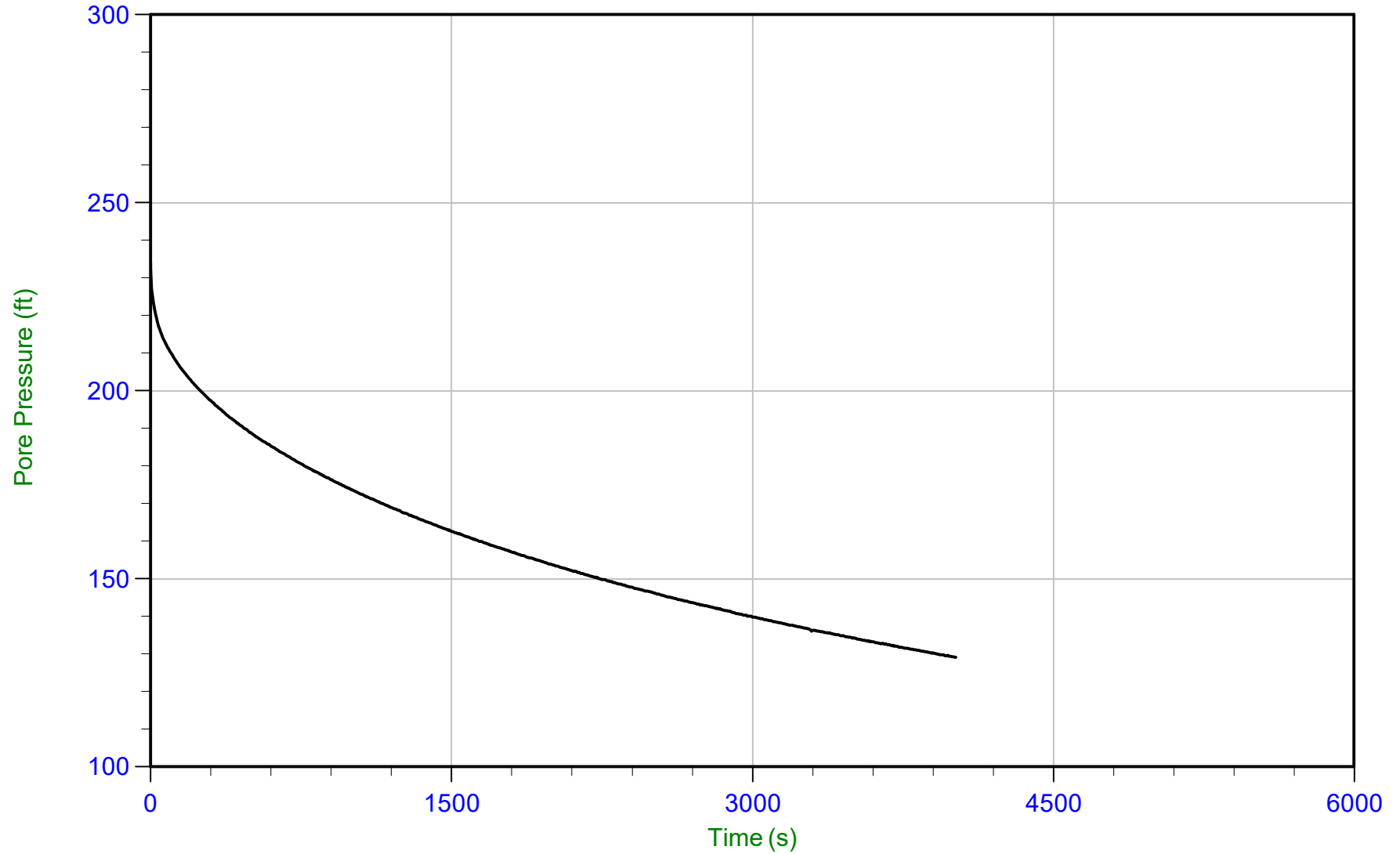

Trace Summary:

Filename: 20-61-21681_CP01B.PPF
Depth: 14.675 m / 48.146 ft
Duration: 4015.0 s

u Min: 129.2 ft
u Max: 234.0 ft
u Final: 129.2 ft

WT: 4.572 m / 15.000 ft
Ueq: 33.1 ft
U(50): 133.60 ft

T(50): 3564.5 s
lr: 100
Ch: 0.2 cm²/min



Geosyntec

Job No: 20-61-21681
Date: 12/11/2020 08:28
Site: DTE Belle River Power Plant

Sounding: CPT20-01B
Cone: 551:T1500F15U500 Area=15 cm²

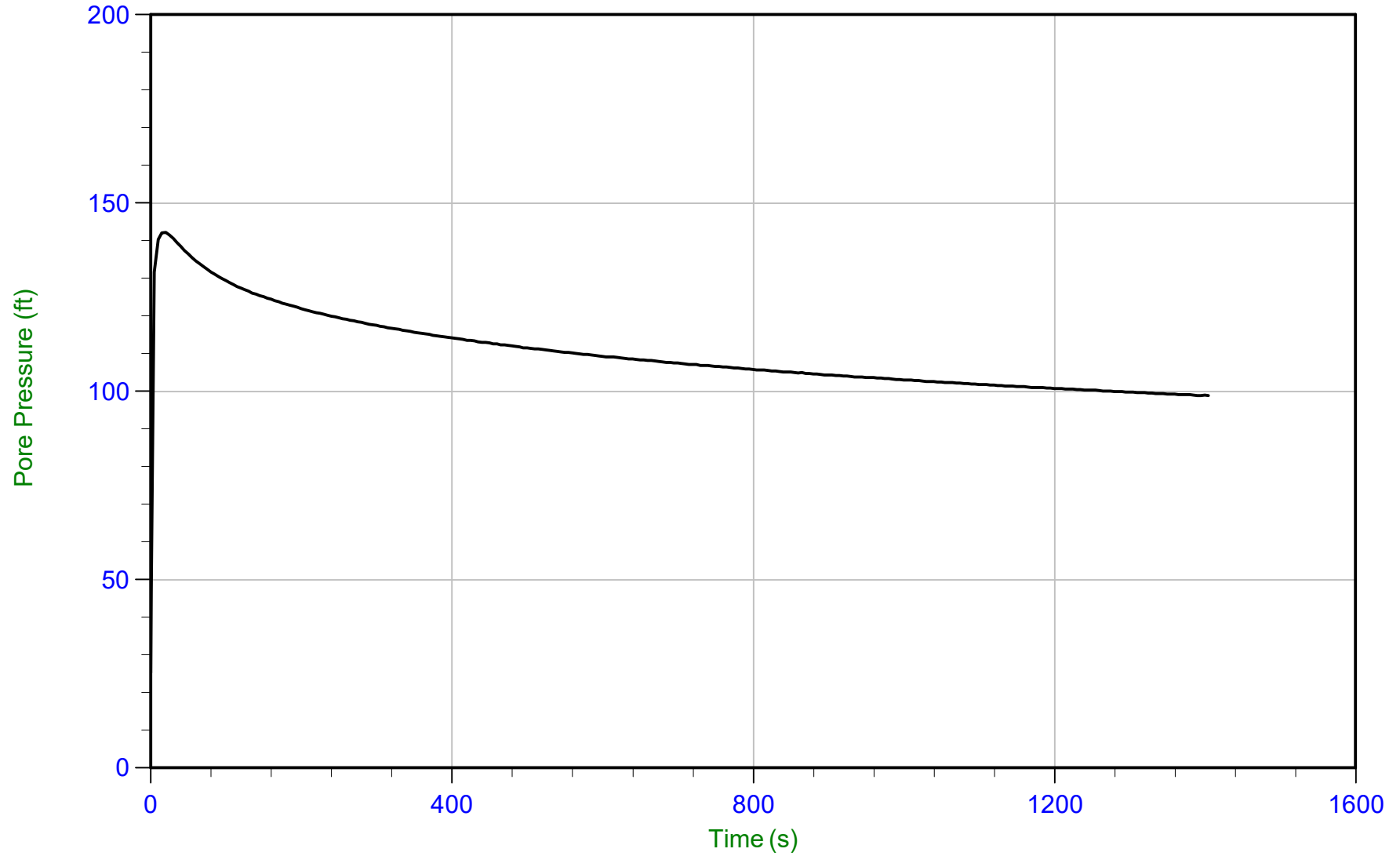

Trace Summary:

Filename: 20-61-21681_CP01B.PPF
Depth: 19.975 m / 65.534 ft
Duration: 1405.0 s

u Min: 25.2 ft
u Max: 142.2 ft
u Final: 98.9 ft



Geosyntec

Job No: 20-61-21681
Date: 12/11/2020 08:28
Site: DTE Belle River Power Plant

Sounding: CPT20-01B
Cone: 551:T1500F15U500 Area=15 cm²

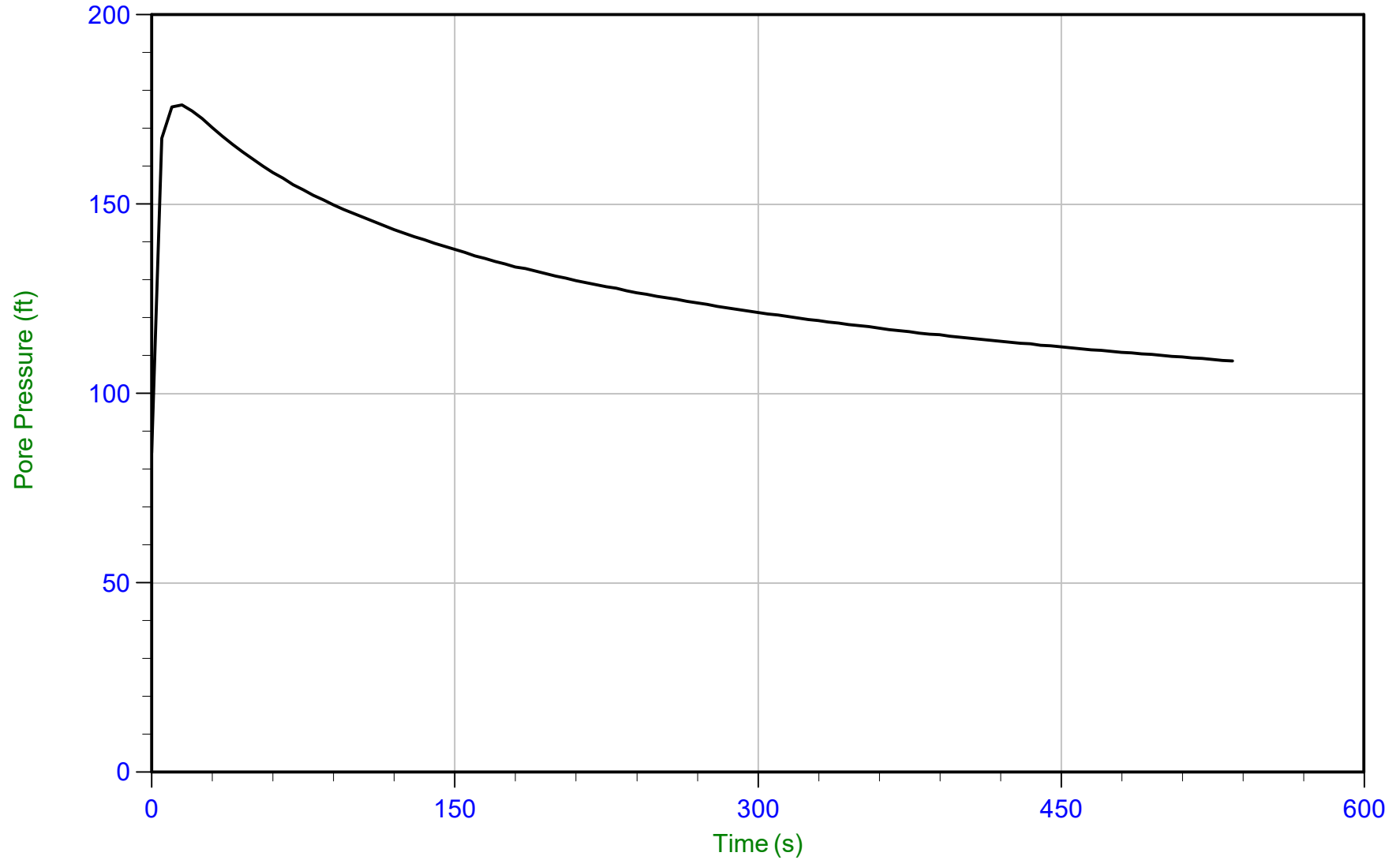

Trace Summary:

Filename: 20-61-21681_CP01B.PPF
Depth: 20.775 m / 68.159 ft
Duration: 535.0 s

u Min: 84.4 ft
u Max: 176.2 ft
u Final: 108.6 ft

WT: 4.572 m / 15.000 ft
Ueq: 53.2 ft
U(50): 114.66 ft

T(50): 389.0 s
lr: 100
Ch: 1.8 cm²/min



Geosyntec

Job No: 20-61-21681
Date: 12/11/2020 08:28
Site: DTE Belle River Power Plant

Sounding: CPT20-01B
Cone: 551:T1500F15U500 Area=15 cm²

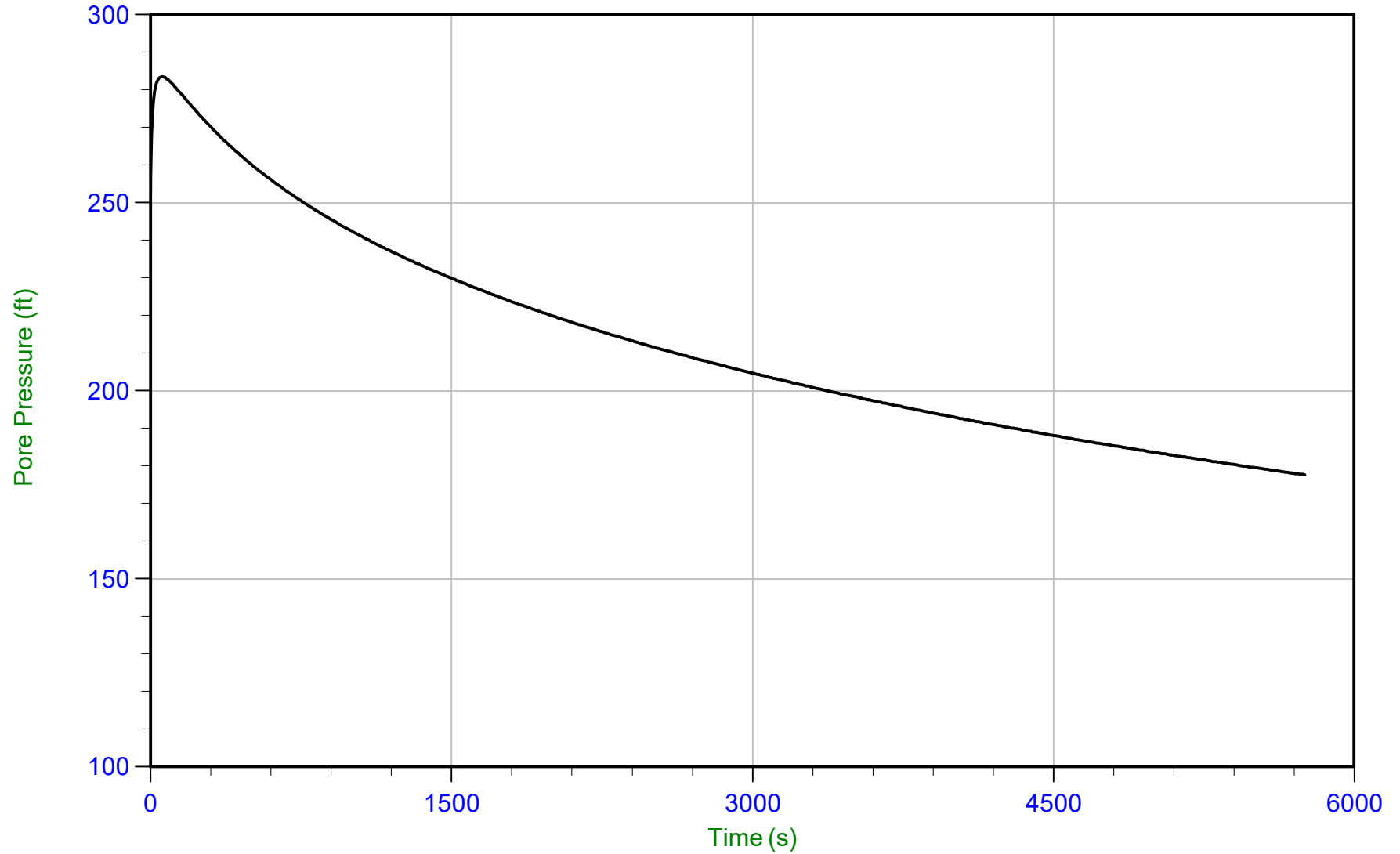

Trace Summary:

Filename: 20-61-21681_CP01B.PPF
Depth: 26.850 m / 88.089 ft
Duration: 5755.0 s

u Min: 177.6 ft
u Max: 283.6 ft
u Final: 177.6 ft

WT: 4.572 m / 15.000 ft
Ueq: 73.1 ft
U(50): 178.34 ft

T(50): 5600.8 s
lr: 100
Ch: 0.1 cm²/min



Geosyntec

Job No: 20-61-21681
Date: 12/11/2020 08:28
Site: DTE Belle River Power Plant

Sounding: CPT20-01B
Cone: 551:T1500F15U500 Area=15 cm²

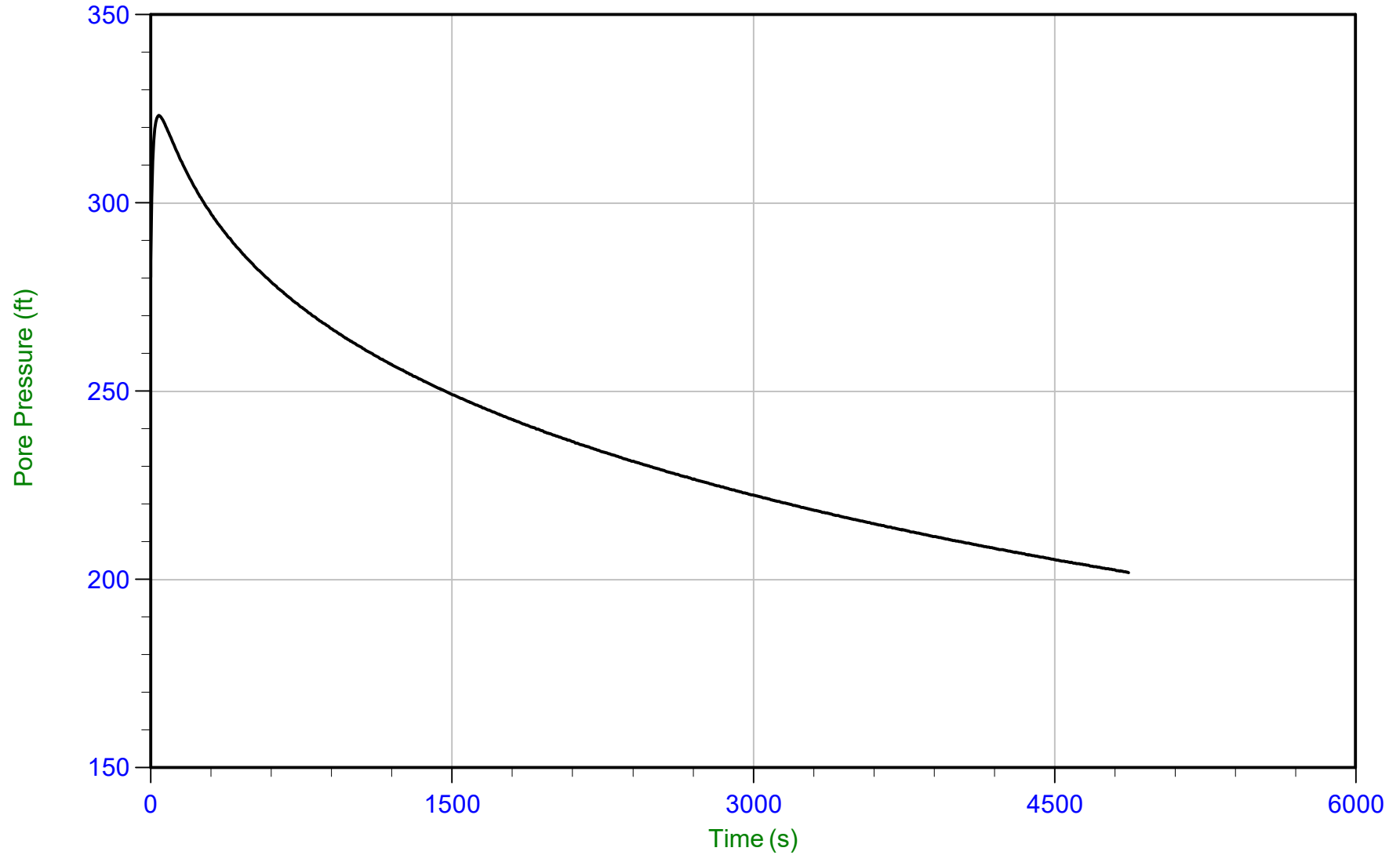

Trace Summary:

Filename: 20-61-21681_CP01B.PPF
Depth: 29.900 m / 98.096 ft
Duration: 4870.0 s

u Min: 201.9 ft
u Max: 323.3 ft
u Final: 201.9 ft

WT: 4.572 m / 15.000 ft
Ueq: 83.1 ft
U(50): 203.21 ft

T(50): 4686.3 s
lr: 100
Ch: 0.1 cm²/min



Geosyntec

Job No: 20-61-21681
Date: 12/09/2020 14:00
Site: DTE Belle River Power Plant

Sounding: CPT20-03
Cone: 551:T1500F15U500 Area=15 cm²

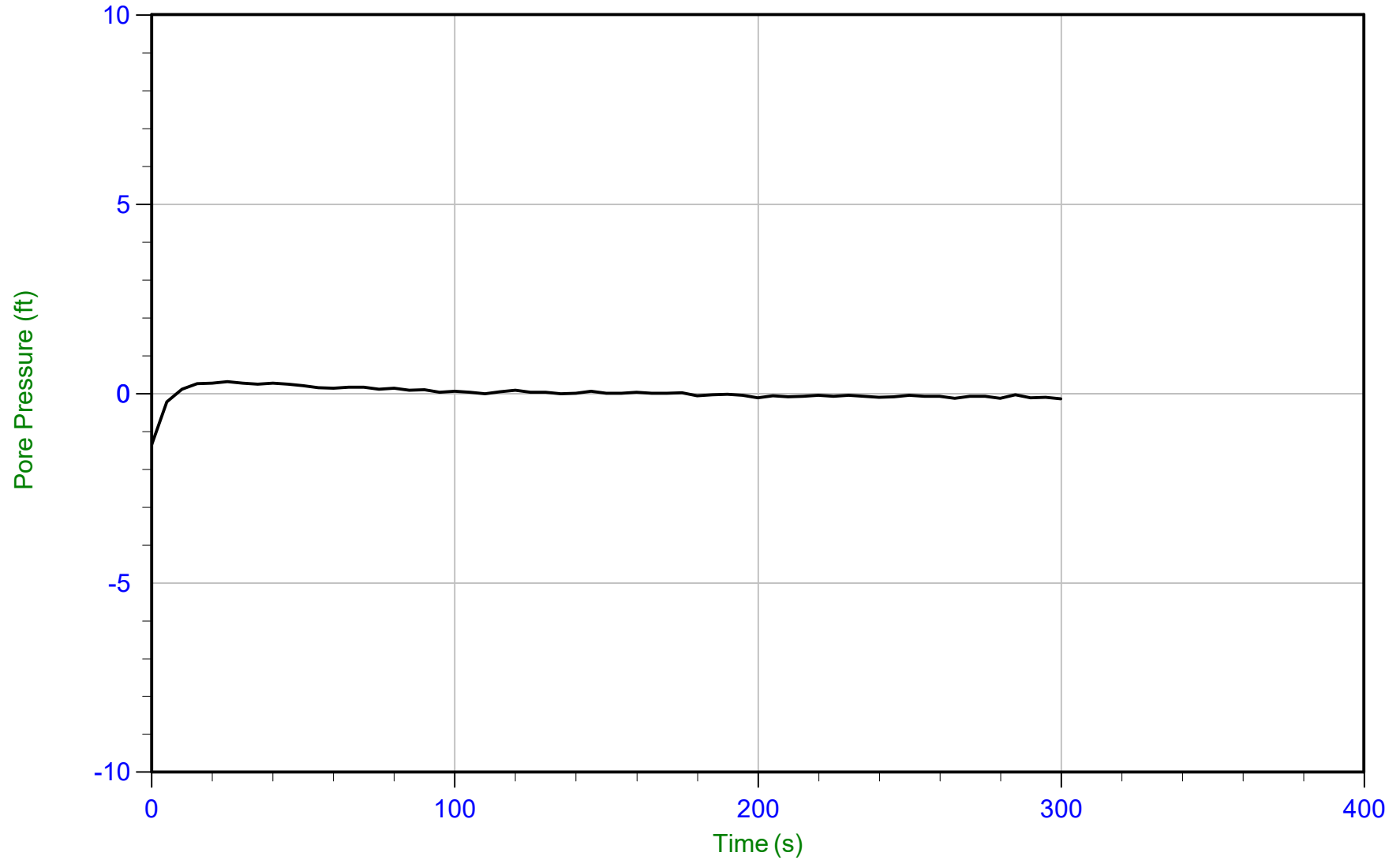

Trace Summary:

Filename: 20-61-21681_CP03.PPF
Depth: 3.100 m / 10.170 ft
Duration: 300.0 s

u Min: -1.4 ft
u Max: 0.3 ft
u Final: -0.1 ft

WT: 3.100 m / 10.170 ft
Ueq: 0.0 ft



Geosyntec

Job No: 20-61-21681
Date: 12/09/2020 14:00
Site: DTE Belle River Power Plant

Sounding: CPT20-03
Cone: 551:T1500F15U500 Area=15 cm²

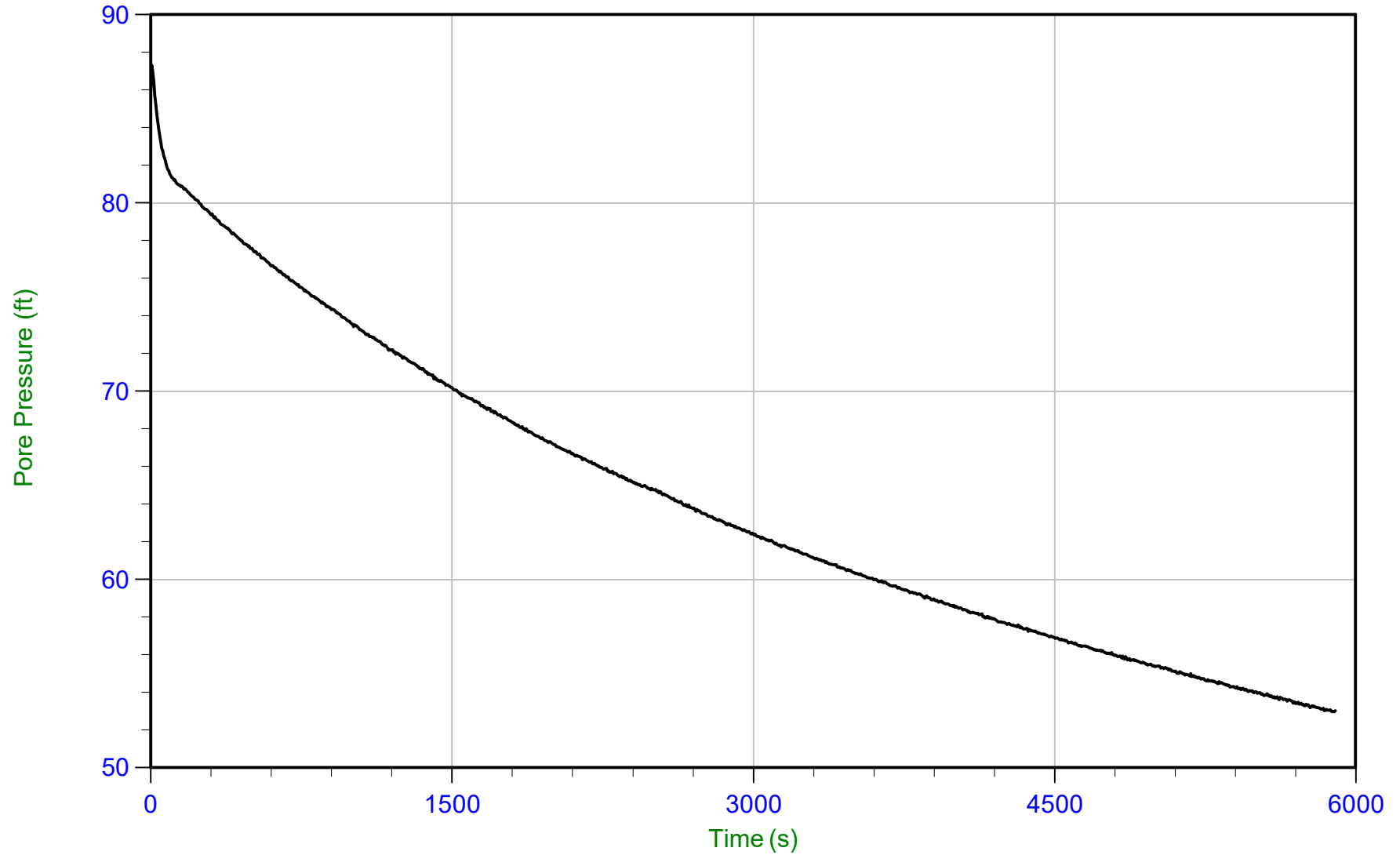

Trace Summary:

Filename: 20-61-21681_CP03.PPF
Depth: 6.150 m / 20.177 ft
Duration: 5900.0 s

u Min: 53.0 ft
u Max: 87.3 ft
u Final: 53.0 ft



Geosyntec

Job No: 20-61-21681
Date: 12/09/2020 14:00
Site: DTE Belle River Power Plant

Sounding: CPT20-03
Cone: 551:T1500F15U500 Area=15 cm²

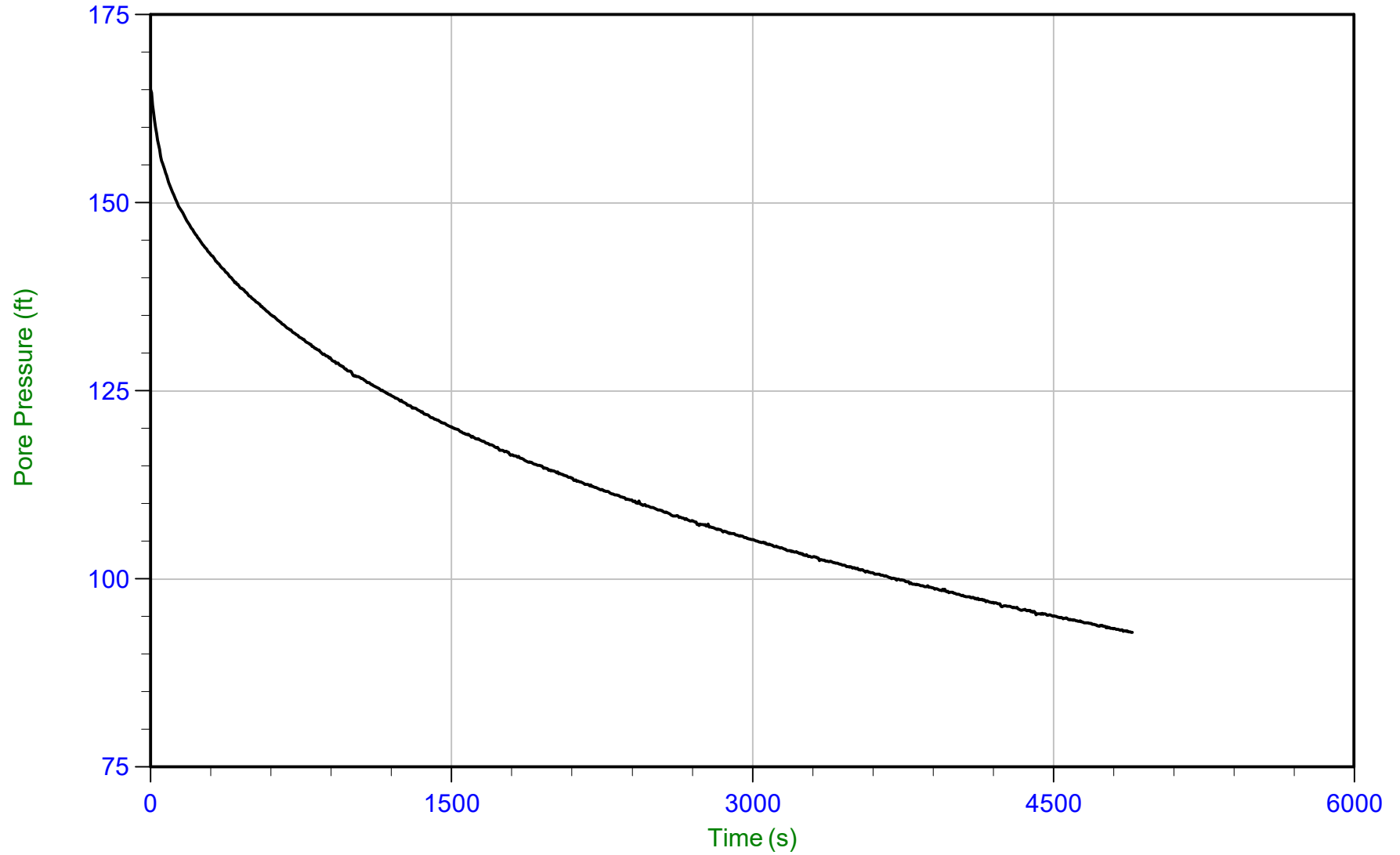

Trace Summary:

Filename: 20-61-21681_CP03.PPF
Depth: 11.325 m / 37.155 ft
Duration: 4895.0 s

u Min: 92.9 ft
u Max: 165.1 ft
u Final: 92.9 ft



Geosyntec

Job No: 20-61-21681
Date: 12/09/2020 14:00
Site: DTE Belle River Power Plant

Sounding: CPT20-03
Cone: 551:T1500F15U500 Area=15 cm²

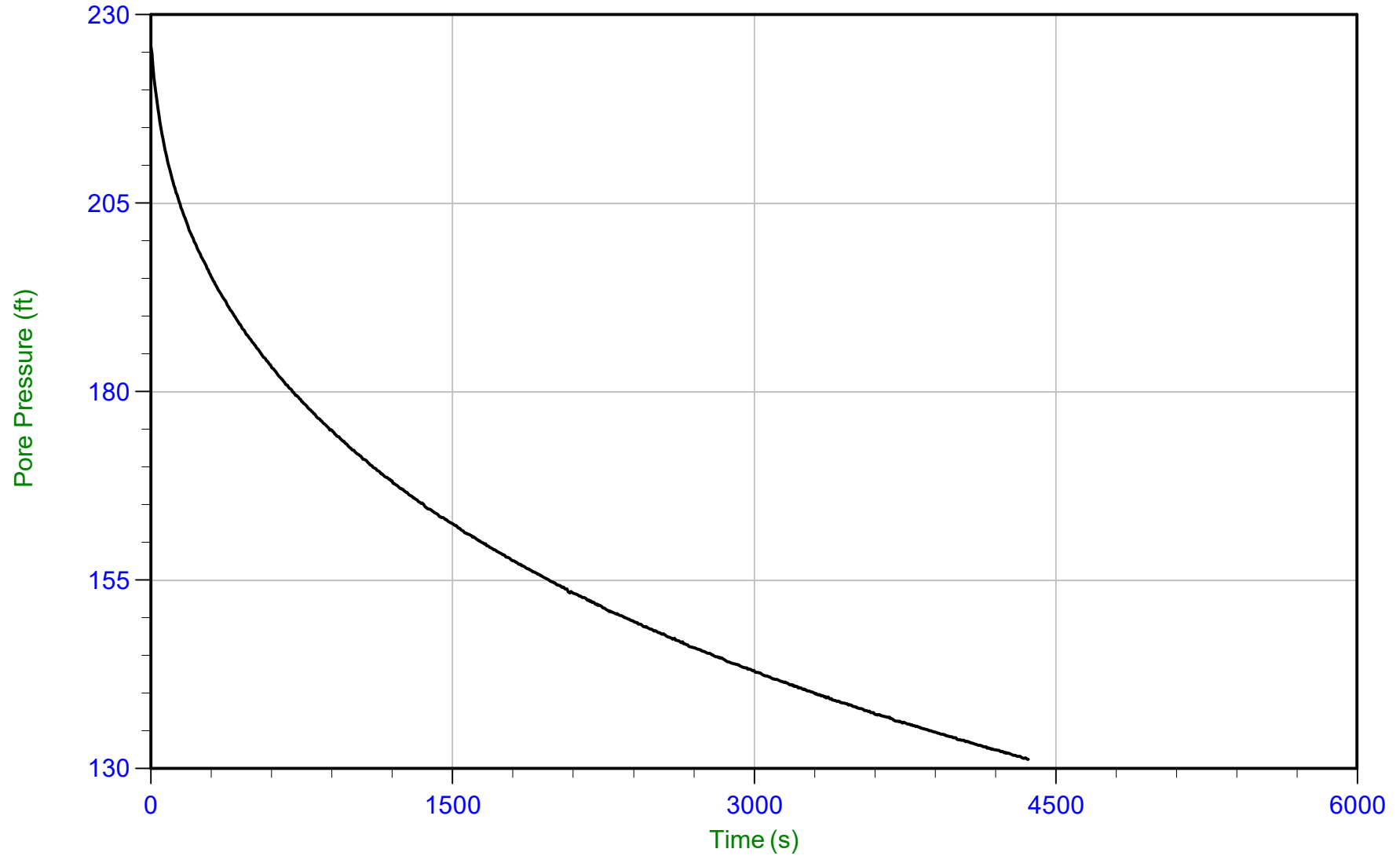

Trace Summary:

Filename: 20-61-21681_CP03.PPF
Depth: 17.725 m / 58.152 ft
Duration: 4365.0 s

u Min: 131.3 ft
u Max: 225.8 ft
u Final: 131.3 ft

WT: 5.486 m / 17.998 ft
Ueq: 40.2 ft
U(50): 133.00 ft

T(50): 4136.3 s
lr: 100
Ch: 0.2 cm²/min



Geosyntec

Job No: 20-61-21681
Date: 12/09/2020 14:00
Site: DTE Belle River Power Plant

Sounding: CPT20-03
Cone: 551:T1500F15U500 Area=15 cm²

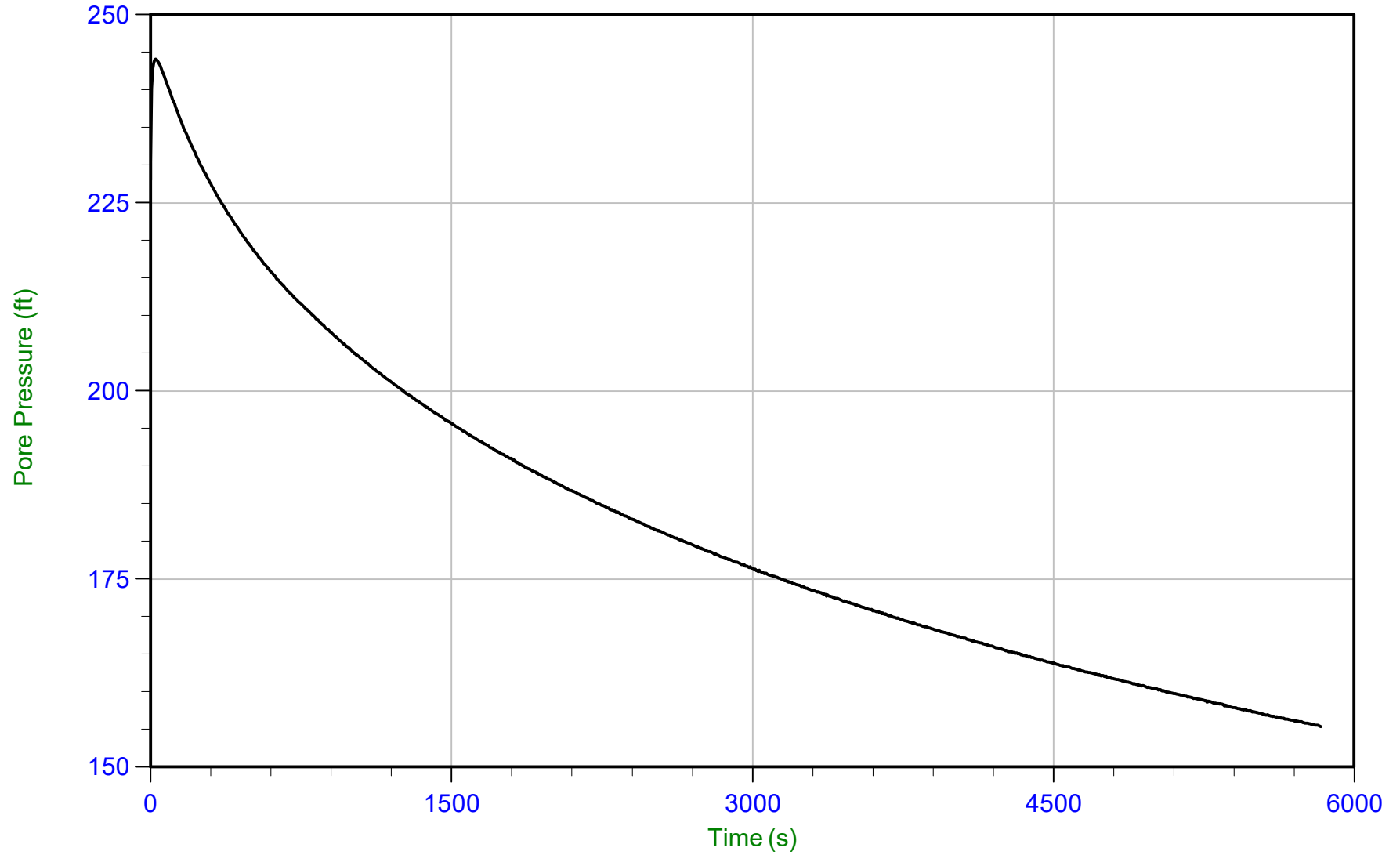

Trace Summary:

Filename: 20-61-21681_CP03.PPF
Depth: 24.425 m / 80.134 ft
Duration: 5835.0 s

u Min: 155.4 ft
u Max: 244.1 ft
u Final: 155.4 ft



Geosyntec

Job No: 20-61-21681
Date: 12/09/2020 14:00
Site: DTE Belle River Power Plant

Sounding: CPT20-03
Cone: 551:T1500F15U500 Area=15 cm²

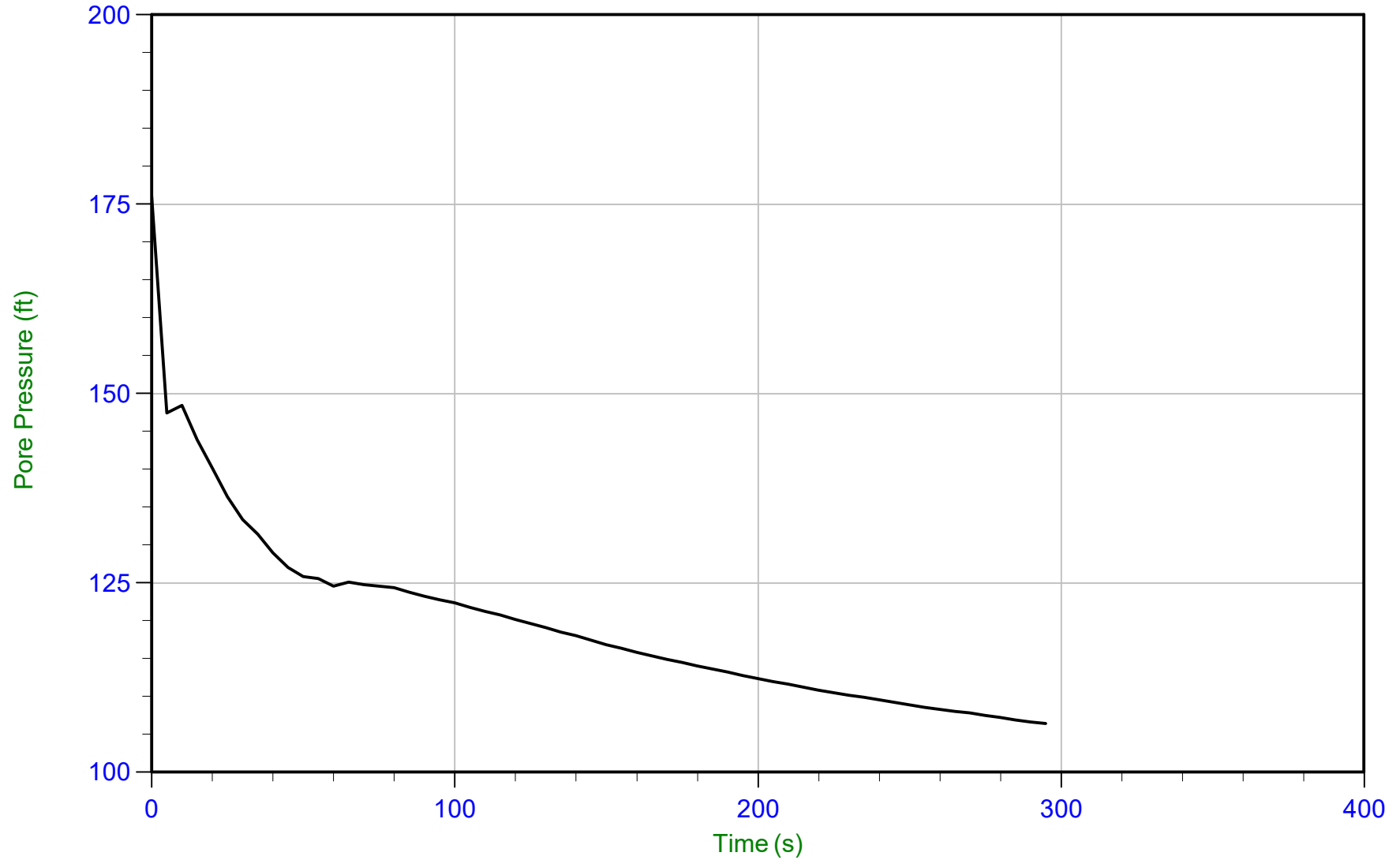

Trace Summary:

Filename: 20-61-21681_CP03.PPF
Depth: 25.050 m / 82.184 ft
Duration: 295.0 s

u Min: 106.4 ft
u Max: 176.0 ft
u Final: 106.4 ft

WT: 5.486 m / 17.998 ft
Ueq: 64.2 ft
U(50): 120.10 ft

T(50): 120.6 s
lr: 100
Ch: 5.8 cm²/min



Geosyntec

Job No: 20-61-21681
Date: 12/09/2020 14:00
Site: DTE Belle River Power Plant

Sounding: CPT20-03
Cone: 551:T1500F15U500 Area=15 cm²

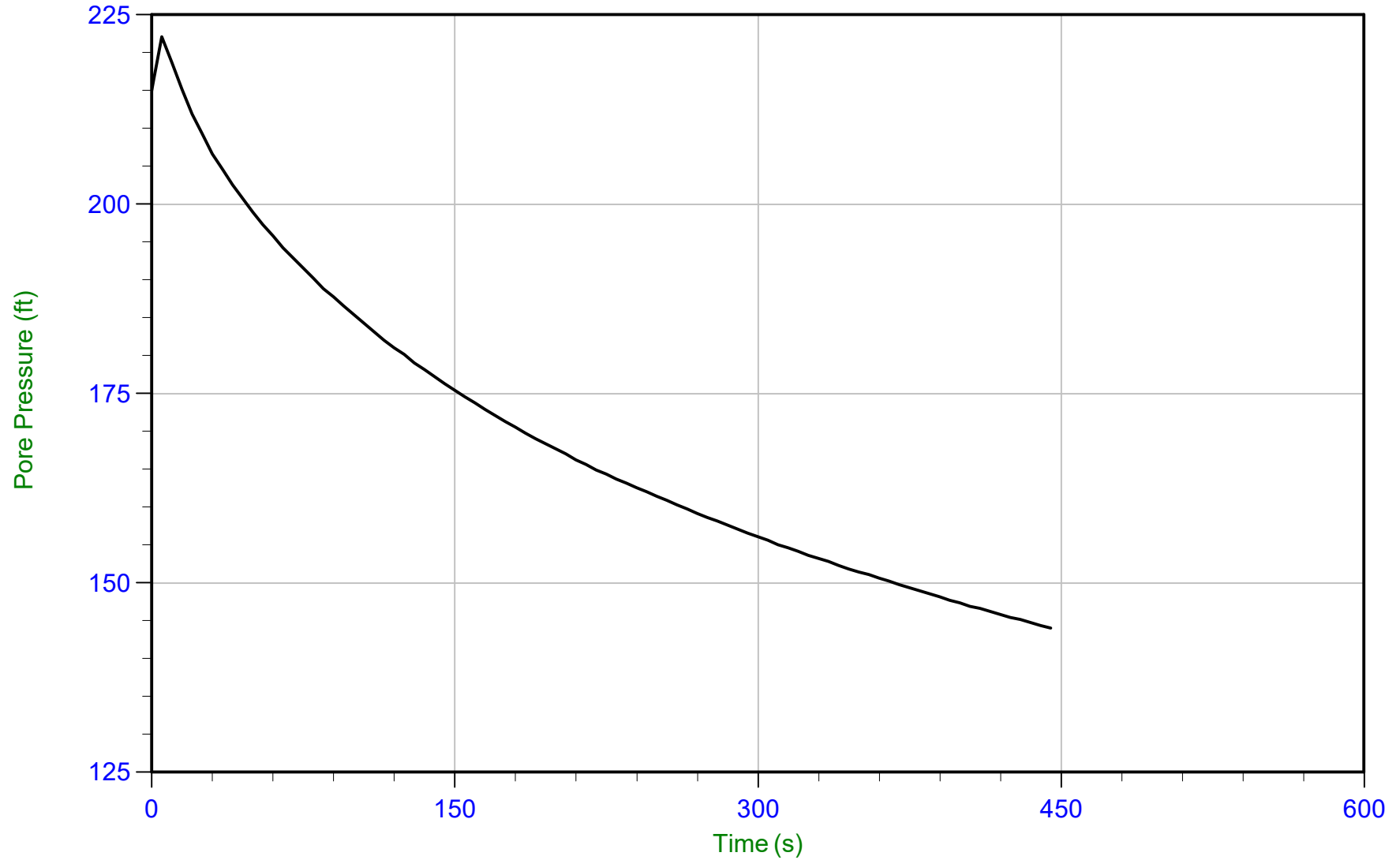

Trace Summary:

Filename: 20-61-21681_CP03.PPF
Depth: 25.700 m / 84.317 ft
Duration: 445.0 s

u Min: 144.0 ft
u Max: 222.1 ft
u Final: 144.0 ft



Geosyntec

Job No: 20-61-21681
Date: 12/09/2020 14:00
Site: DTE Belle River Power Plant

Sounding: CPT20-03
Cone: 551:T1500F15U500 Area=15 cm²

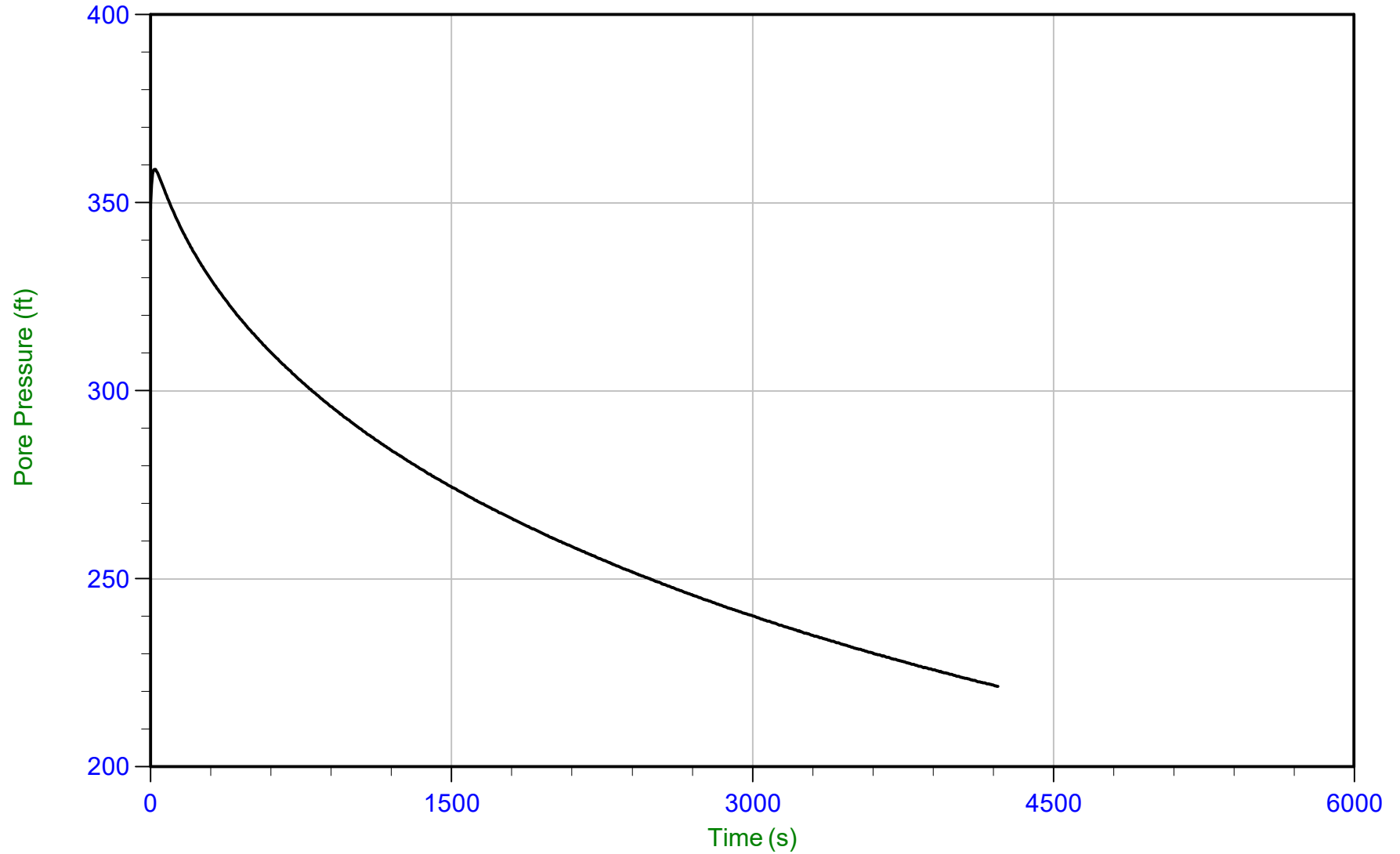

Trace Summary:

Filename: 20-61-21681_CP03.PPF
Depth: 30.225 m / 99.162 ft
Duration: 4225.0 s

u Min: 221.4 ft
u Max: 358.9 ft
u Final: 221.4 ft



Geosyntec

Job No: 20-61-21681
Date: 12/15/2020 11:07
Site: DTE Belle River Power Plant

Sounding: CPT20-11
Cone: 551:T1500F15U500 Area=15 cm²

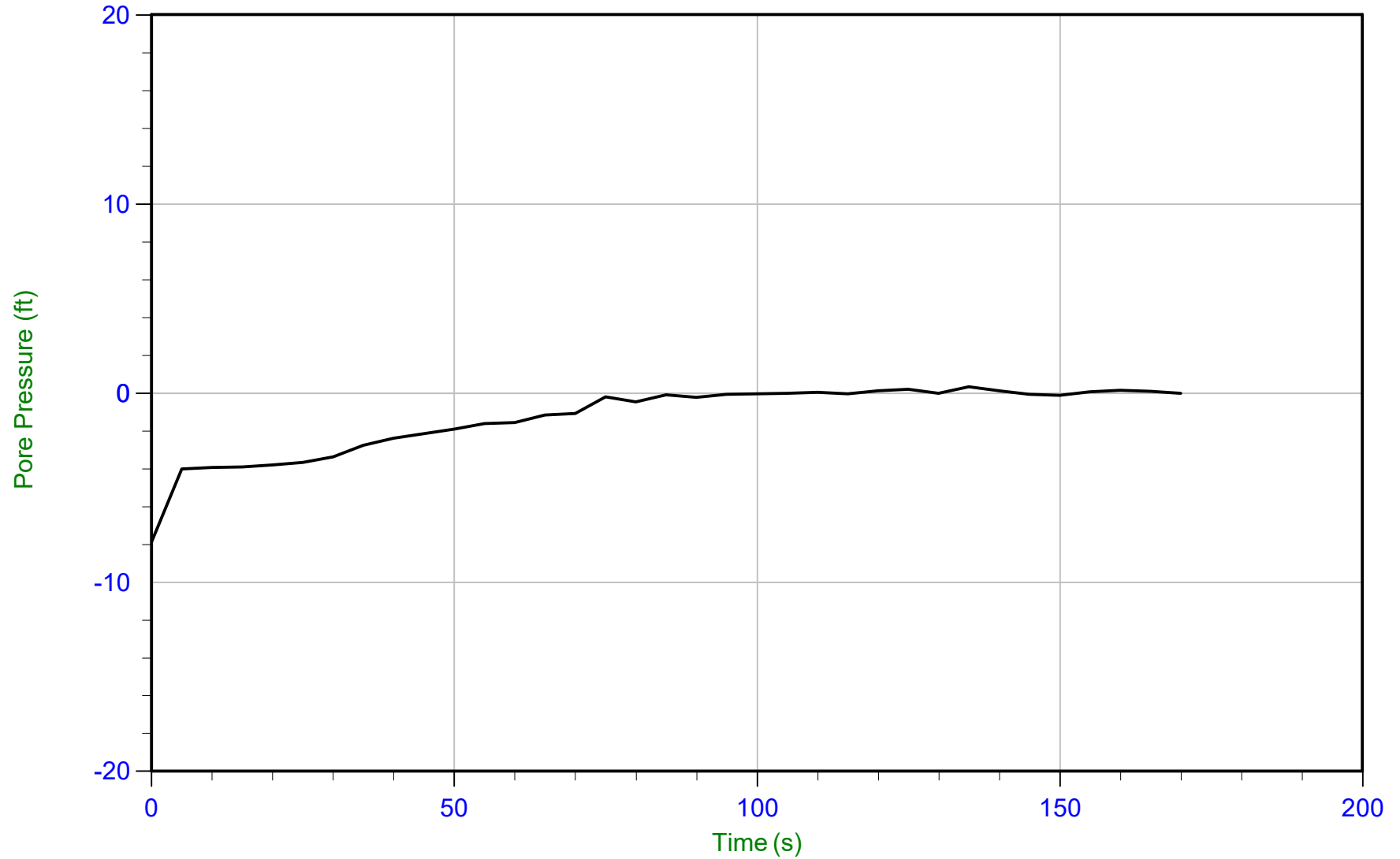

Trace Summary:

Filename: 20-61-21681_CP11.PPF
Depth: 0.650 m / 2.133 ft
Duration: 170.0 s

u Min: -7.9 ft
u Max: 0.3 ft
u Final: -0.0 ft

WT: 0.650 m / 2.133 ft
Ueq: 0.0 ft



Geosyntec

Job No: 20-61-21681
Date: 12/15/2020 11:07
Site: DTE Belle River Power Plant

Sounding: CPT20-11
Cone: 551:T1500F15U500 Area=15 cm²

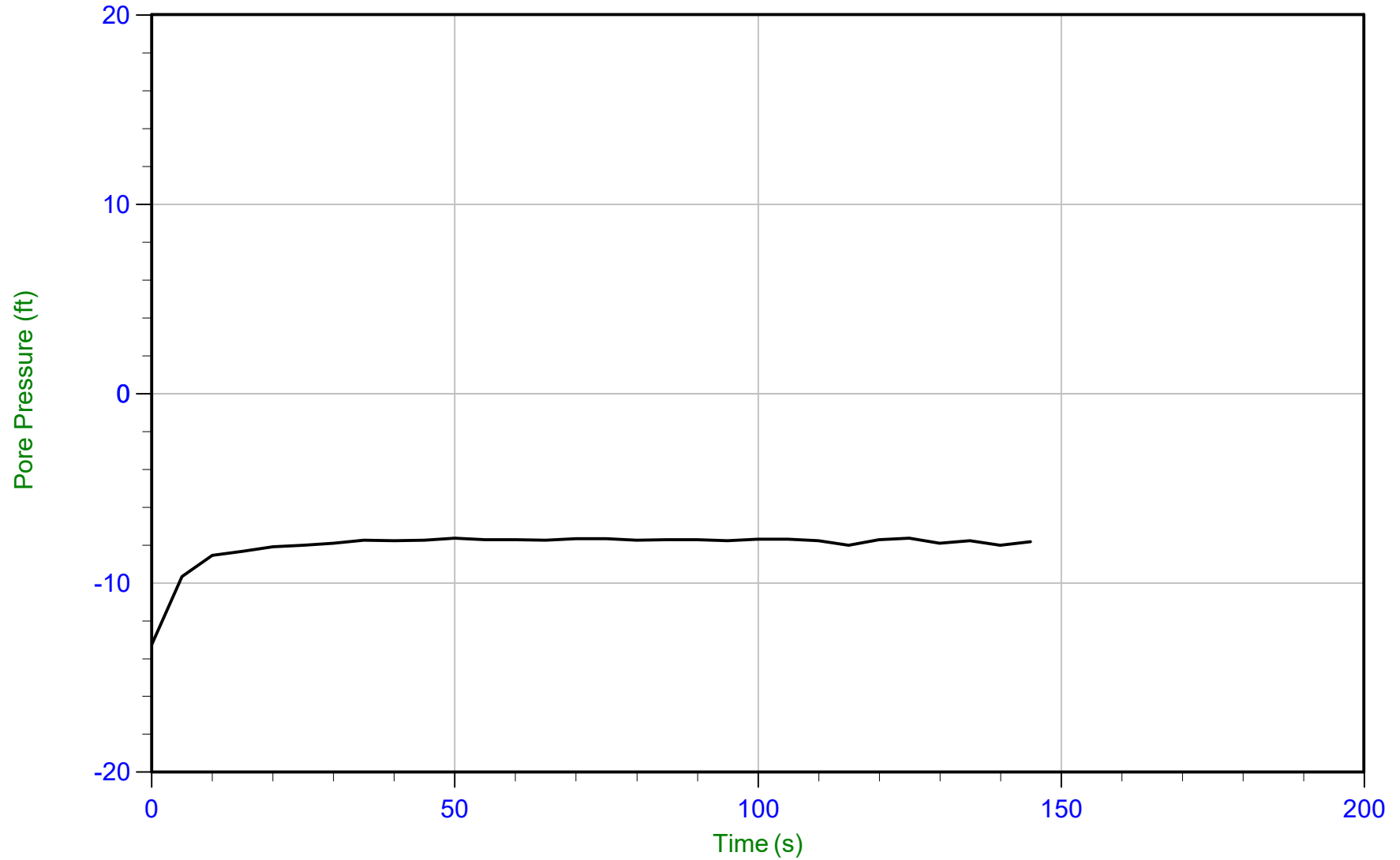

Trace Summary:

Filename: 20-61-21681_CP11.PPF
Depth: 2.475 m / 8.120 ft
Duration: 145.0 s

u Min: -13.3 ft
u Max: -7.6 ft
u Final: -7.8 ft



Geosyntec

Job No: 20-61-21681
Date: 12/15/2020 11:07
Site: DTE Belle River Power Plant

Sounding: CPT20-11
Cone: 551:T1500F15U500 Area=15 cm²

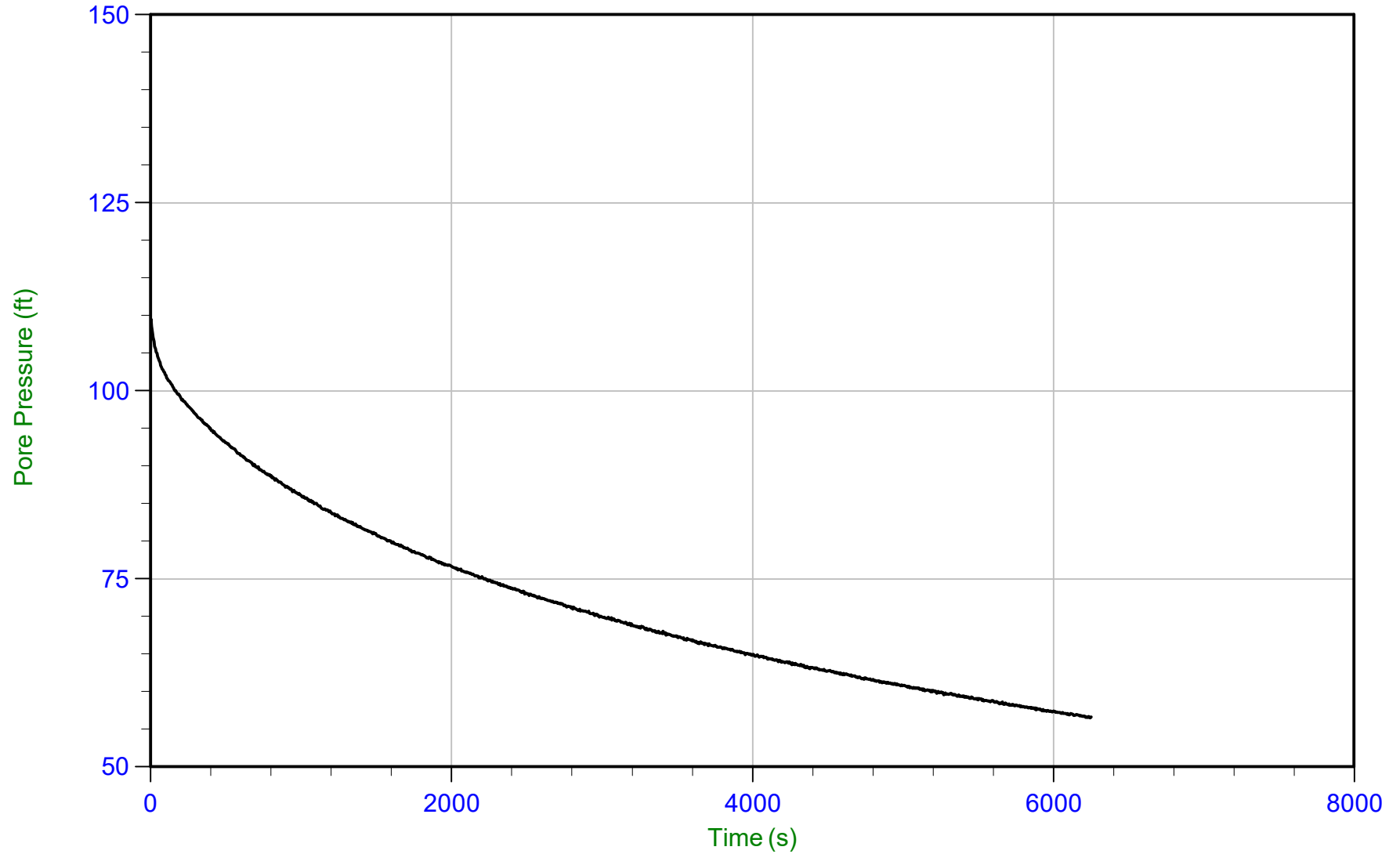

Trace Summary:

Filename: 20-61-21681_CP11.PPF
Depth: 5.850 m / 19.193 ft
Duration: 6255.0 s

u Min: 56.5 ft
u Max: 109.5 ft
u Final: 56.6 ft

WT: 4.267 m / 13.999 ft
Ueq: 5.2 ft
U(50): 57.33 ft

T(50): 5985.9 s
lr: 100
Ch: 0.1 cm²/min



Geosyntec

Job No: 20-61-21681
Date: 12/15/2020 11:07
Site: DTE Belle River Power Plant

Sounding: CPT20-11
Cone: 551:T1500F15U500 Area=15 cm²

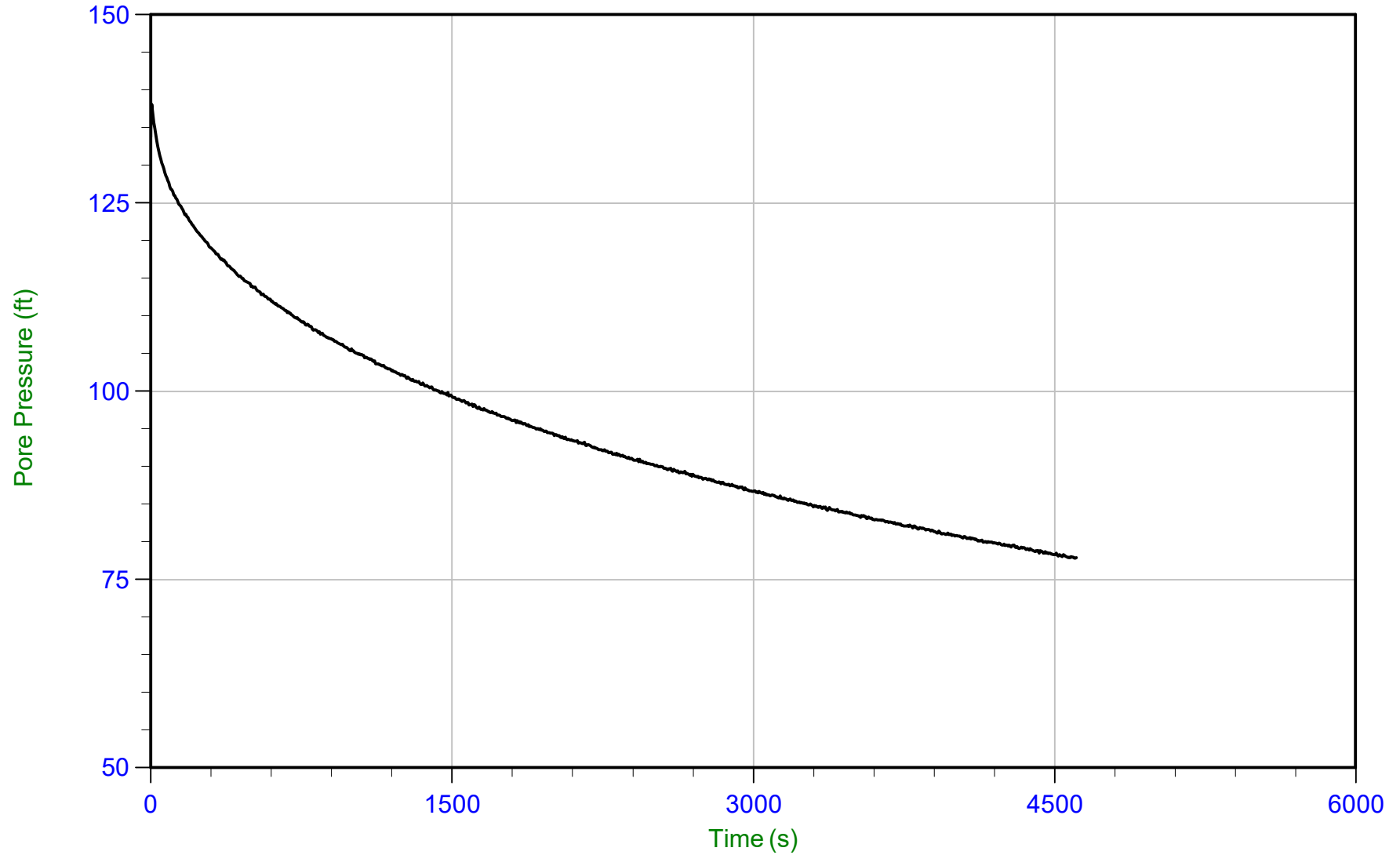

Trace Summary:

Filename: 20-61-21681_CP11.PPF
Depth: 8.575 m / 28.133 ft
Duration: 4610.0 s

u Min: 77.8 ft
u Max: 138.1 ft
u Final: 77.9 ft



Geosyntec

Job No: 20-61-21681
Date: 12/15/2020 11:07
Site: DTE Belle River Power Plant

Sounding: CPT20-11
Cone: 551:T1500F15U500 Area=15 cm²

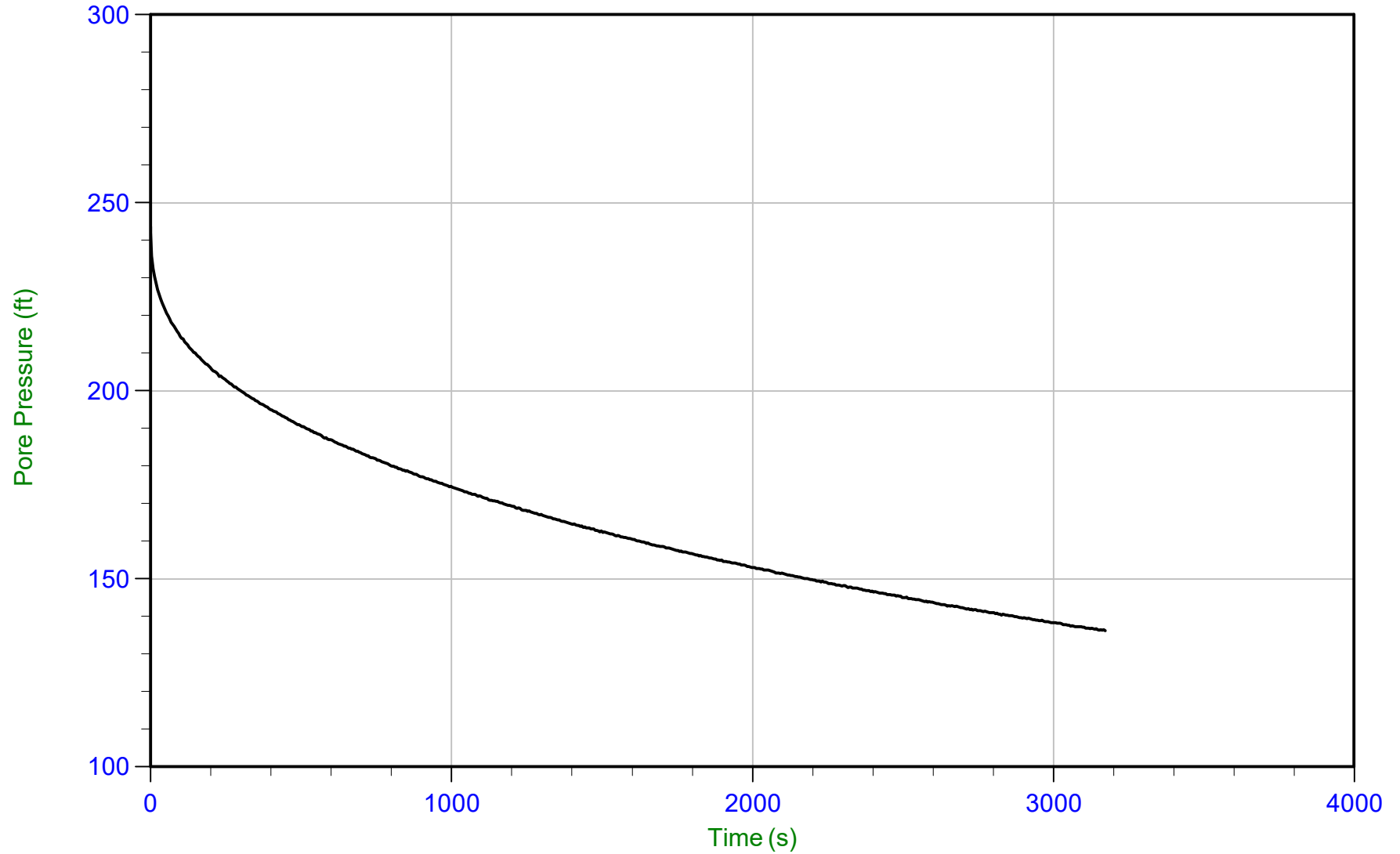

Trace Summary:

Filename: 20-61-21681_CP11.PPF
Depth: 14.675 m / 48.146 ft
Duration: 3175.0 s

u Min: 136.1 ft
u Max: 243.7 ft
u Final: 136.1 ft

WT: 4.267 m / 13.999 ft
Ueq: 34.1 ft
U(50): 138.91 ft

T(50): 2952.5 s
lr: 100
Ch: 0.2 cm²/min



Geosyntec

Job No: 20-61-21681
Date: 12/15/2020 11:07
Site: DTE Belle River Power Plant

Sounding: CPT20-11
Cone: 551:T1500F15U500 Area=15 cm²

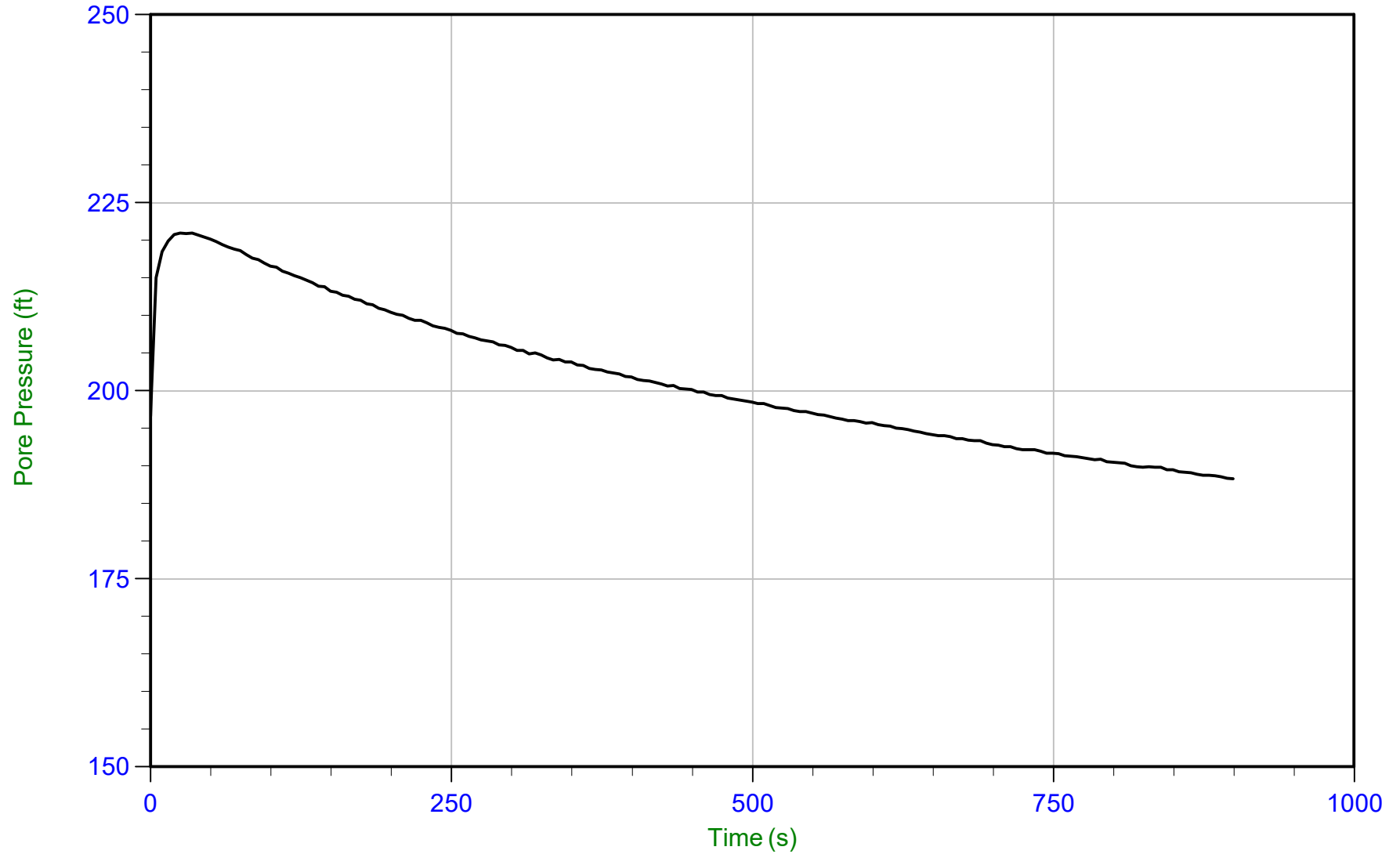

Trace Summary:

Filename: 20-61-21681_CP11.PPF
Depth: 20.550 m / 67.420 ft
Duration: 900.0 s

u Min: 188.3 ft
u Max: 221.0 ft
u Final: 188.3 ft



Geosyntec

Job No: 20-61-21681
Date: 12/15/2020 11:07
Site: DTE Belle River Power Plant

Sounding: CPT20-11
Cone: 551:T1500F15U500 Area=15 cm²

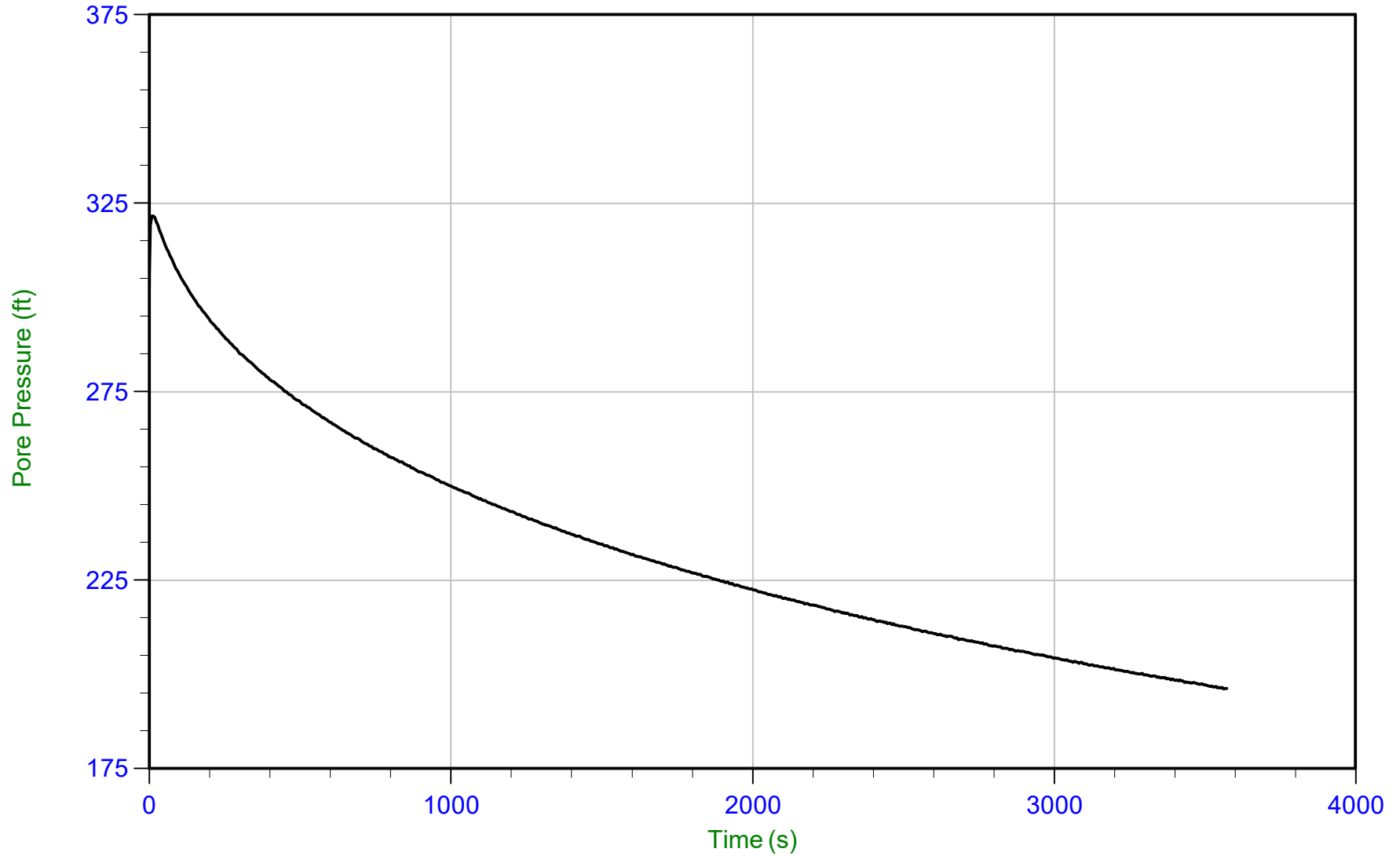

Trace Summary:

Filename: 20-61-21681_CP11.PPF
Depth: 26.850 m / 88.089 ft
Duration: 3575.0 s

u Min: 196.1 ft
u Max: 321.7 ft
u Final: 196.3 ft

WT: 4.267 m / 13.999 ft
Ueq: 74.1 ft
U(50): 197.88 ft

T(50): 3435.4 s
lr: 100
Ch: 0.2 cm²/min



Geosyntec

Job No: 20-61-21681
Date: 12/15/2020 11:07
Site: DTE Belle River Power Plant

Sounding: CPT20-11
Cone: 551:T1500F15U500 Area=15 cm²

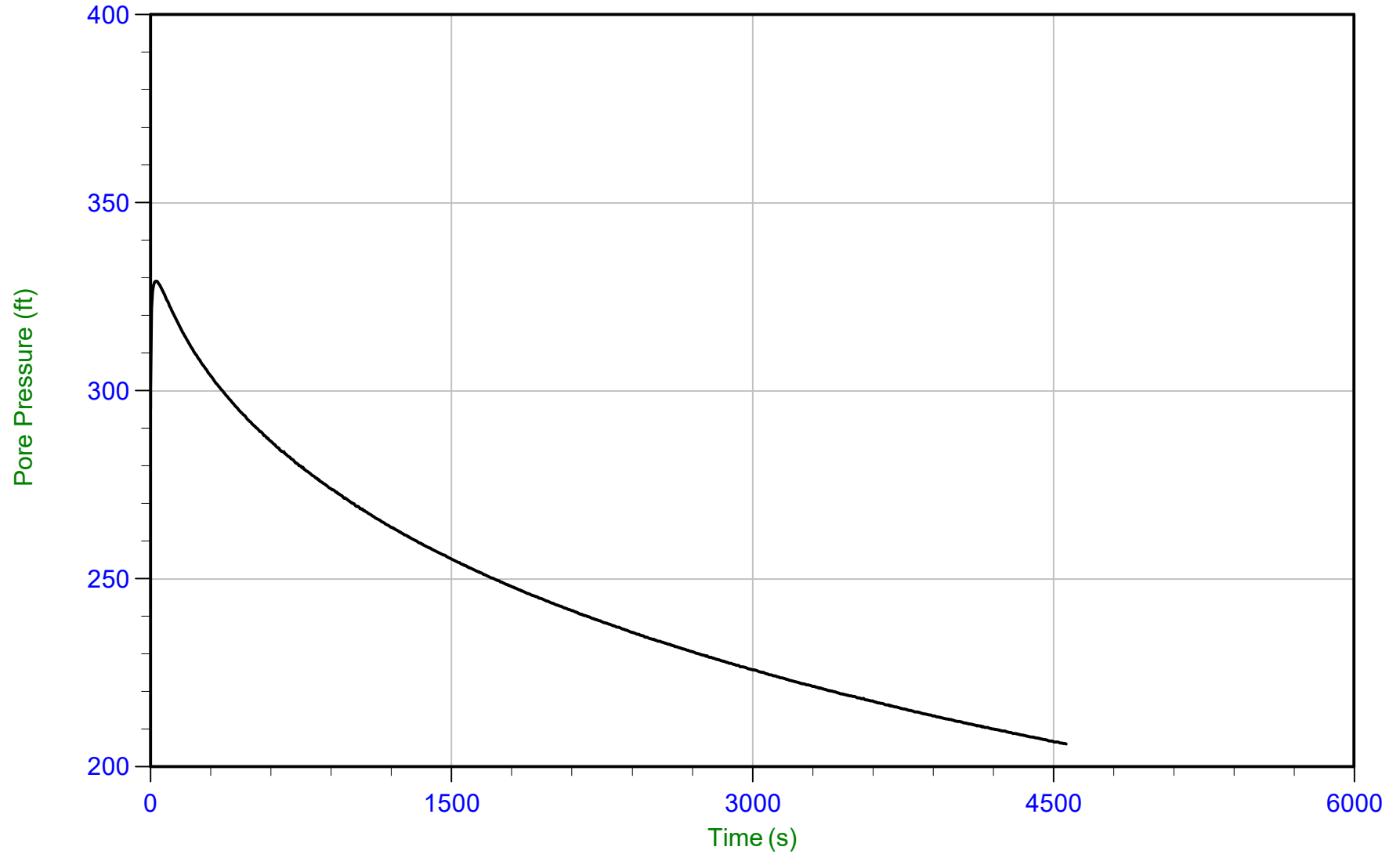

Trace Summary:

Filename: 20-61-21681_CP11.PPF
Depth: 29.900 m / 98.096 ft
Duration: 4565.0 s

u Min: 206.1 ft
u Max: 329.2 ft
u Final: 206.1 ft

WT: 4.267 m / 13.999 ft
Ueq: 84.1 ft
U(50): 206.63 ft

T(50): 4484.0 s
lr: 100
Ch: 0.2 cm²/min



Geosyntec

Job No: 20-61-21681
Date: 12/15/2020 08:44
Site: DTE Belle River Power Plant

Sounding: CPT20-12
Cone: 551:T1500F15U500 Area=15 cm²

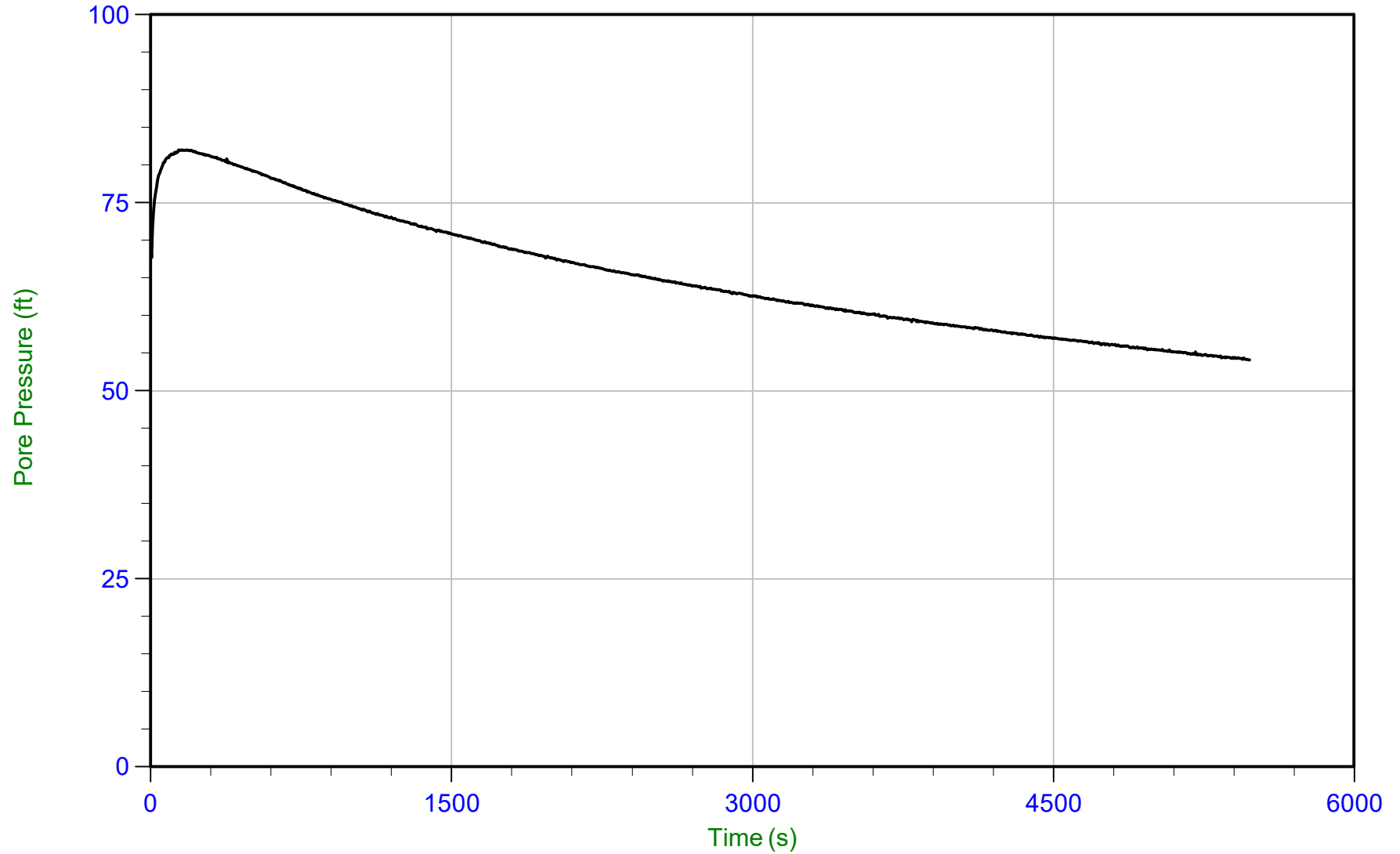

Trace Summary:

Filename: 20-61-21681_CP12.PPF
Depth: 4.900 m / 16.076 ft
Duration: 5480.0 s

u Min: 54.1 ft
u Max: 82.0 ft
u Final: 54.1 ft



Geosyntec

Job No: 20-61-21681
Date: 12/09/2020 13:54
Site: DTE Belle River Power Plant

Sounding: CPT20-06
Cone: 513:T1500F15U500 Area=15 cm²

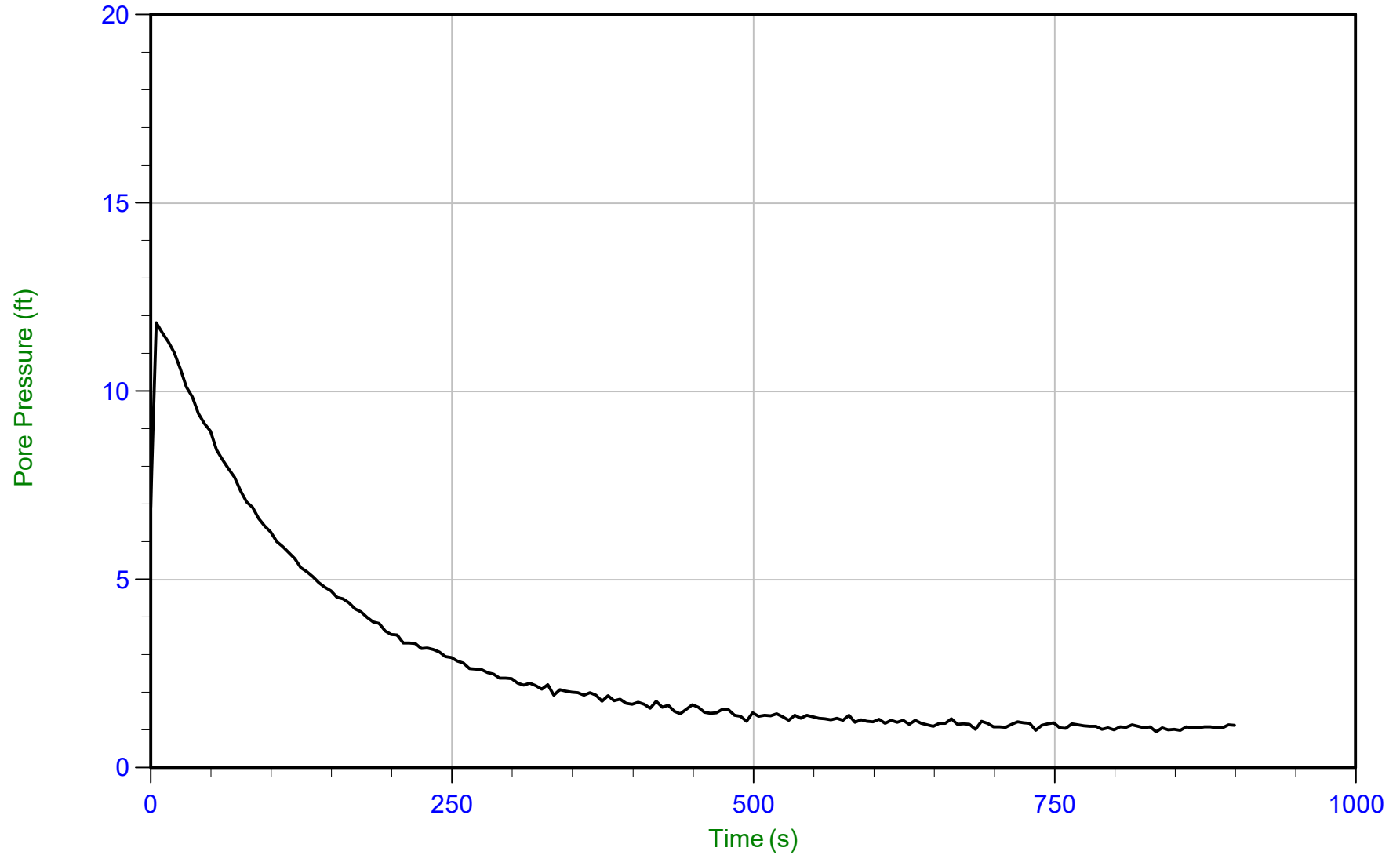

Trace Summary:

Filename: 20-61-21681_CP06.PPF
Depth: 1.000 m / 3.281 ft
Duration: 900.0 s

u Min: 1.0 ft
u Max: 11.8 ft
u Final: 1.1 ft



Geosyntec

Job No: 20-61-21681
Date: 12/09/2020 13:54
Site: DTE Belle River Power Plant

Sounding: CPT20-06
Cone: 513:T1500F15U500 Area=15 cm²

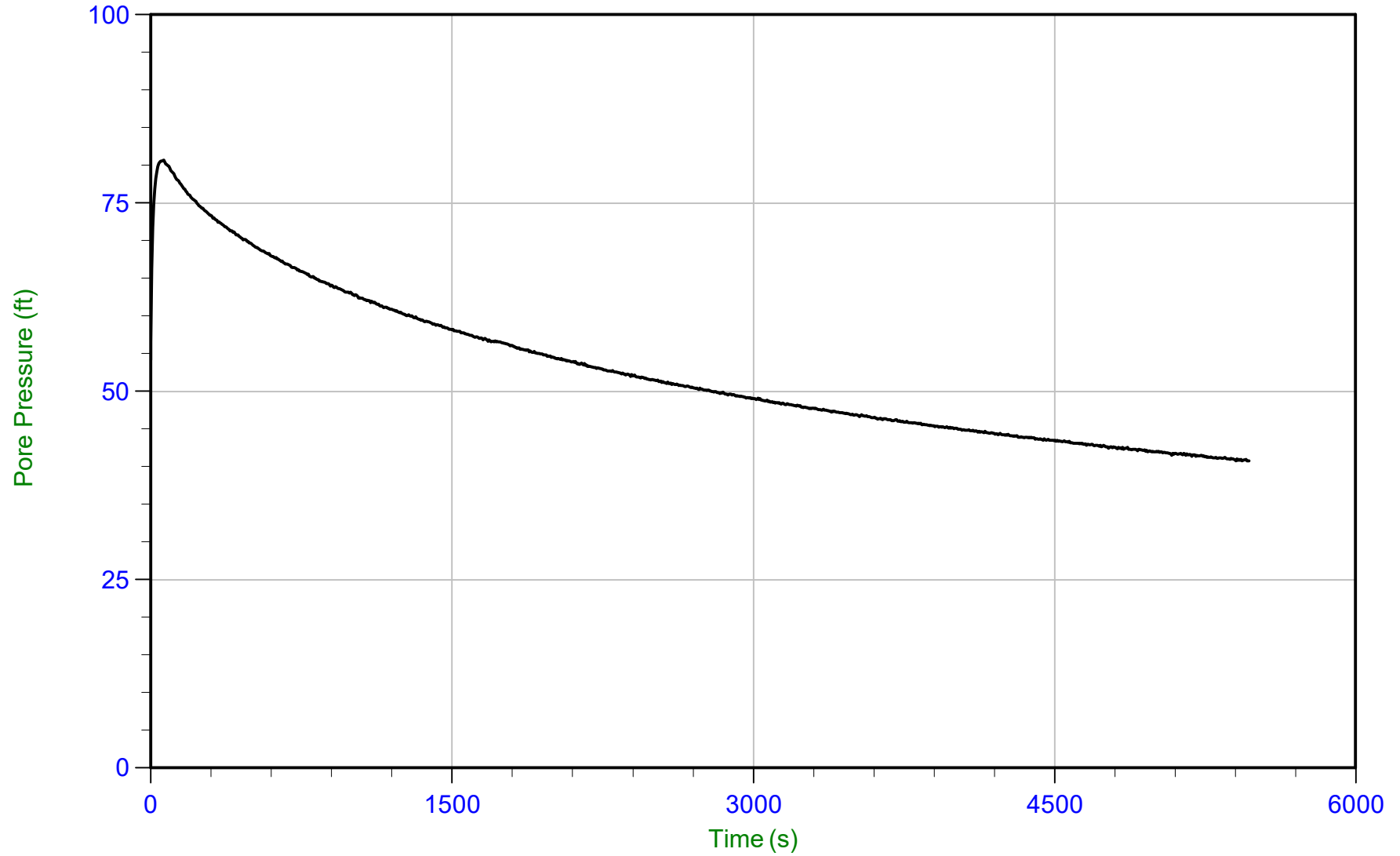

Trace Summary:

Filename: 20-61-21681_CP06.PPF
Depth: 4.600 m / 15.092 ft
Duration: 5470.0 s

u Min: 40.7 ft
u Max: 80.7 ft
u Final: 40.8 ft



Geosyntec

Job No: 20-61-21681
Date: 12/10/2020 08:43
Site: DTE Belle River Power Plant

Sounding: CPT20-06B
Cone: 513:T1500F15U500 Area=15 cm²

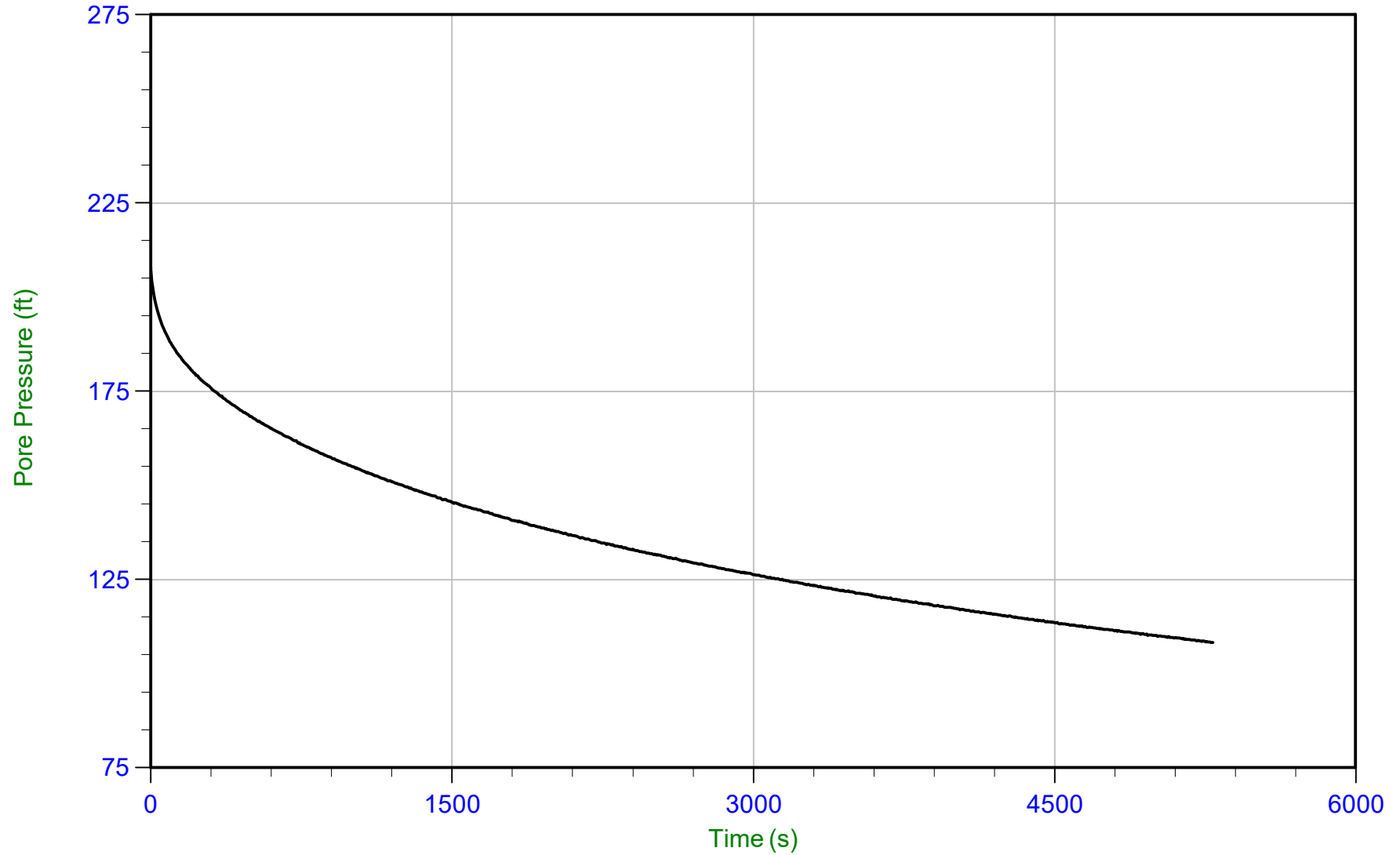

Trace Summary:

Filename: 20-61-21681_CP06B.PPF
Depth: 13.450 m / 44.127 ft
Duration: 5290.0 s

u Min: 108.2 ft
u Max: 208.0 ft
u Final: 108.3 ft

WT: 5.182 m / 17.000 ft
Ueq: 27.1 ft
U(50): 117.58 ft

T(50): 3964.4 s
lr: 100
Ch: 0.2 cm²/min



Geosyntec

Job No: 20-61-21681
Date: 12/10/2020 08:43
Site: DTE Belle River Power Plant

Sounding: CPT20-06B
Cone: 513:T1500F15U500 Area=15 cm²

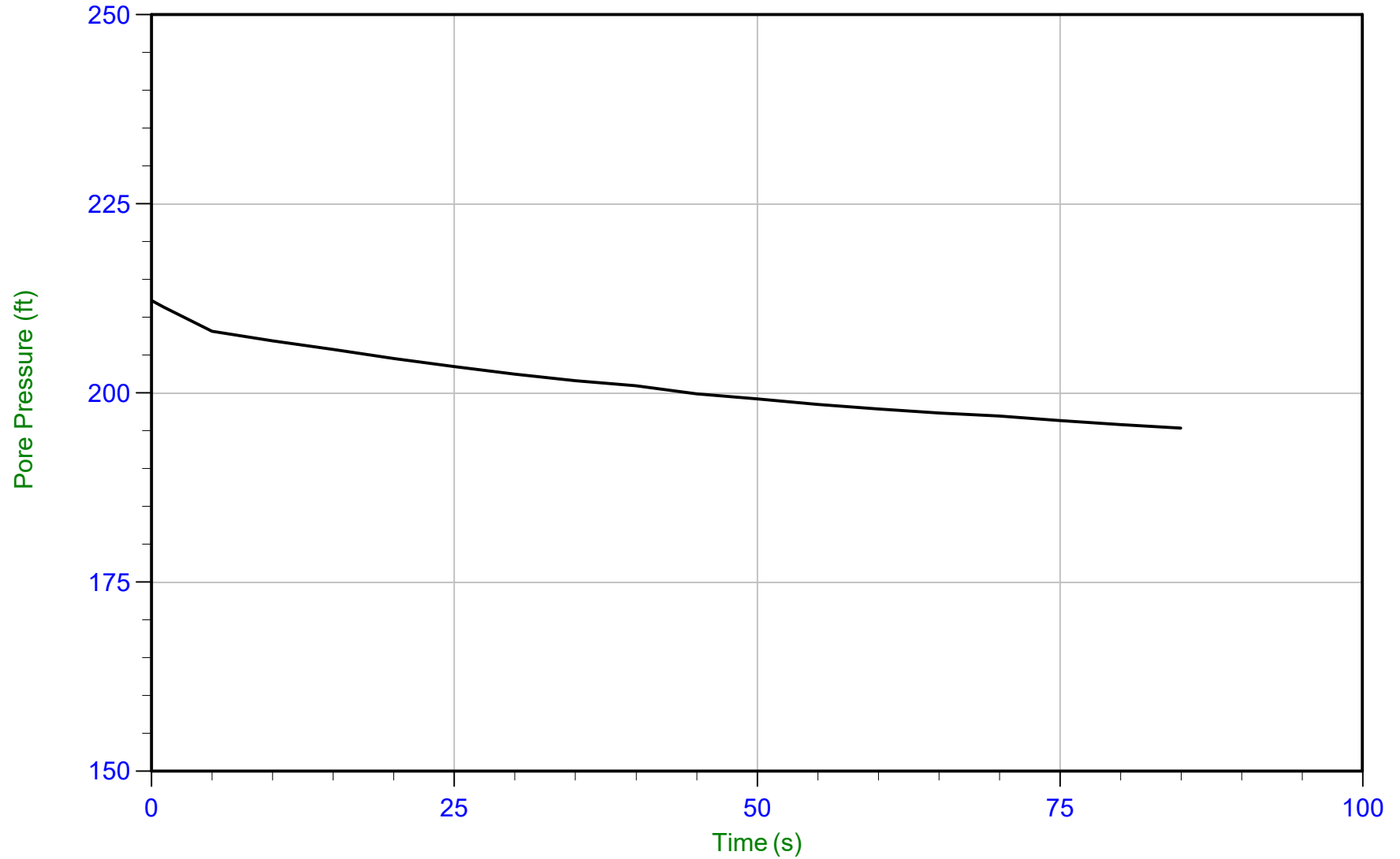

Trace Summary:

Filename: 20-61-21681_CP06B.PPF
Depth: 13.800 m / 45.275 ft
Duration: 85.0 s

u Min: 195.3 ft
u Max: 212.2 ft
u Final: 195.3 ft



Geosyntec

Job No: 20-61-21681
Date: 12/10/2020 08:43
Site: DTE Belle River Power Plant

Sounding: CPT20-06B
Cone: 513:T1500F15U500 Area=15 cm²

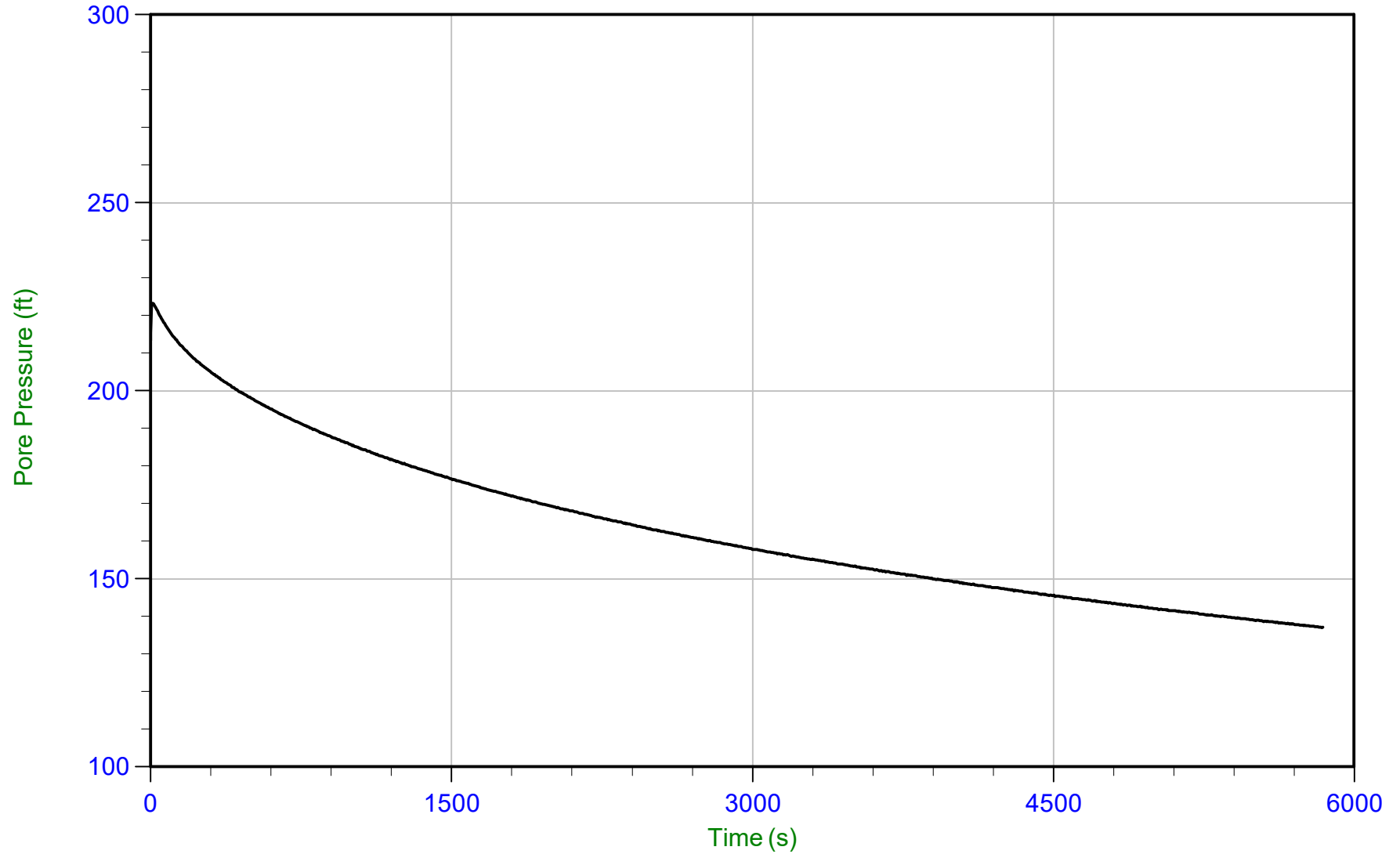

Trace Summary:

Filename: 20-61-21681_CP06B.PPF
Depth: 19.550 m / 64.140 ft
Duration: 5845.0 s

u Min: 137.0 ft
u Max: 223.2 ft
u Final: 137.1 ft



Geosyntec

Job No: 20-61-21681
Date: 12/10/2020 08:43
Site: DTE Belle River Power Plant

Sounding: CPT20-06B
Cone: 513:T1500F15U500 Area=15 cm²

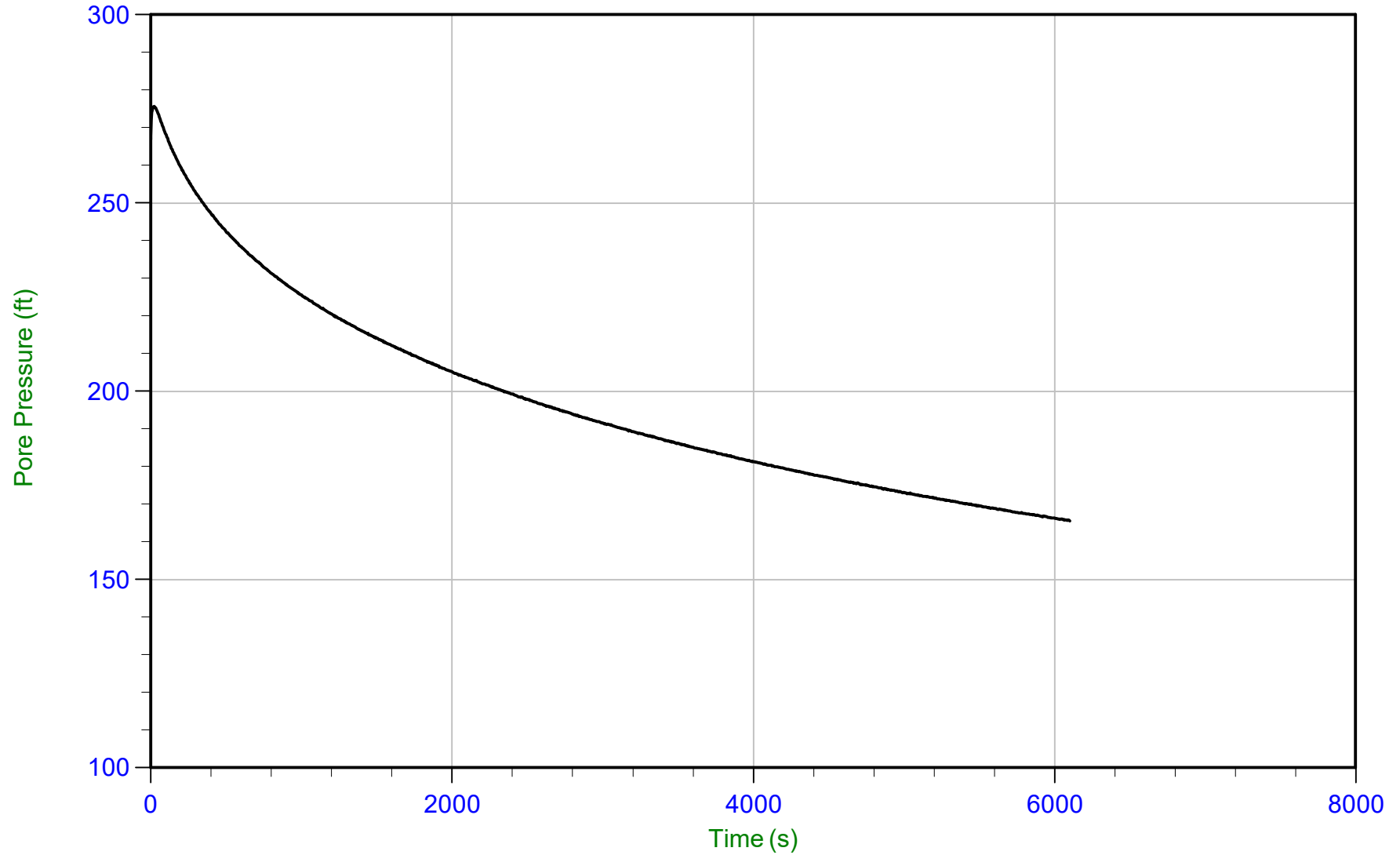

Trace Summary:

Filename: 20-61-21681_CP06B.PPF
Depth: 25.650 m / 84.153 ft
Duration: 6105.0 s

u Min: 165.5 ft
u Max: 275.6 ft
u Final: 165.5 ft

WT: 5.182 m / 17.000 ft
Ueq: 67.2 ft
U(50): 171.39 ft

T(50): 5203.0 s
lr: 100
Ch: 0.1 cm²/min



Geosyntec

Job No: 20-61-21681
Date: 12/10/2020 08:43
Site: DTE Belle River Power Plant

Sounding: CPT20-06B
Cone: 513:T1500F15U500 Area=15 cm²

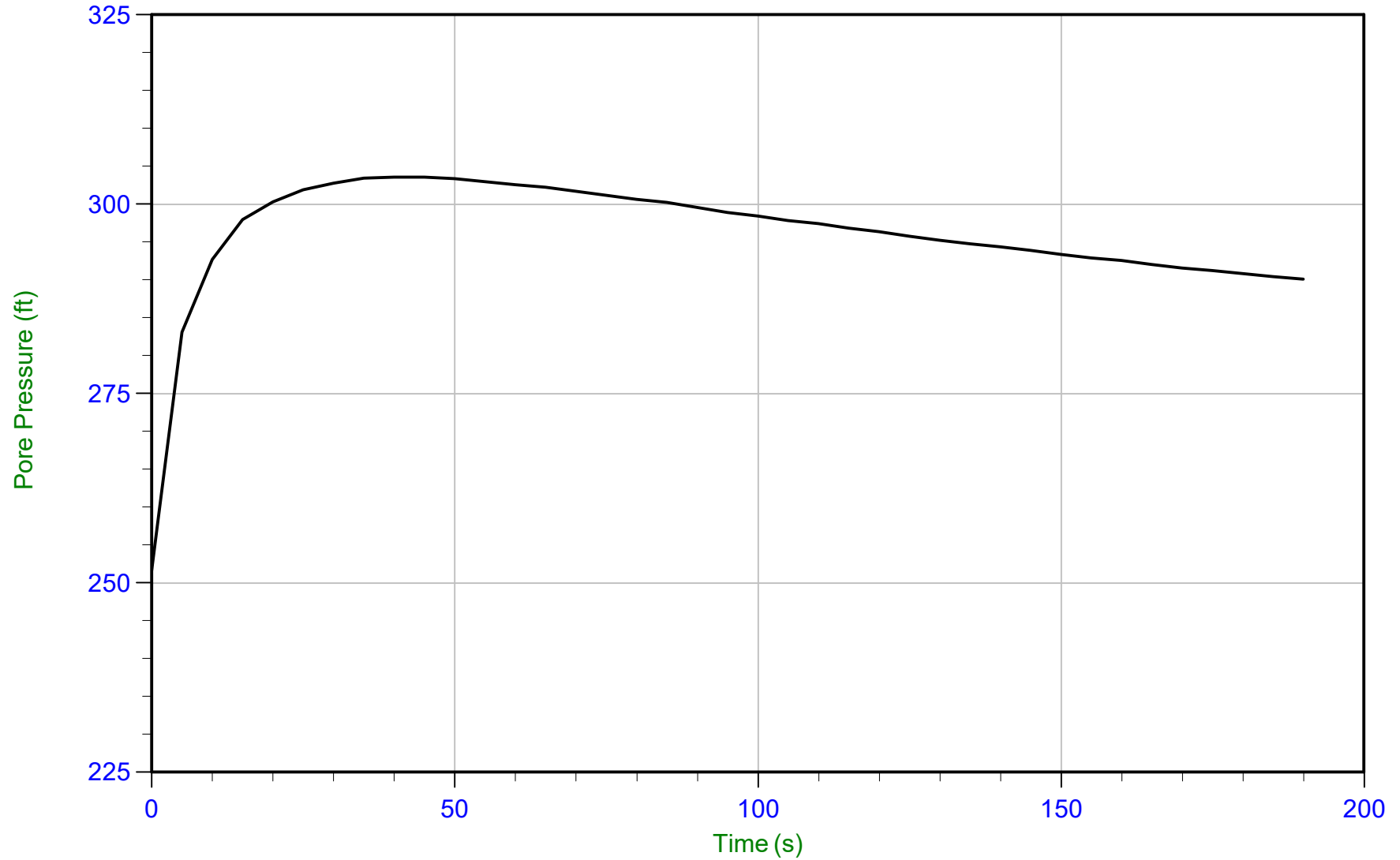

Trace Summary:

Filename: 20-61-21681_CP06B.PPF
Depth: 29.550 m / 96.948 ft
Duration: 190.0 s

u Min: 251.6 ft
u Max: 303.6 ft
u Final: 290.1 ft



Geosyntec

Job No: 20-61-21681
Date: 12/10/2020 08:43
Site: DTE Belle River Power Plant

Sounding: CPT20-06B
Cone: 513:T1500F15U500 Area=15 cm²

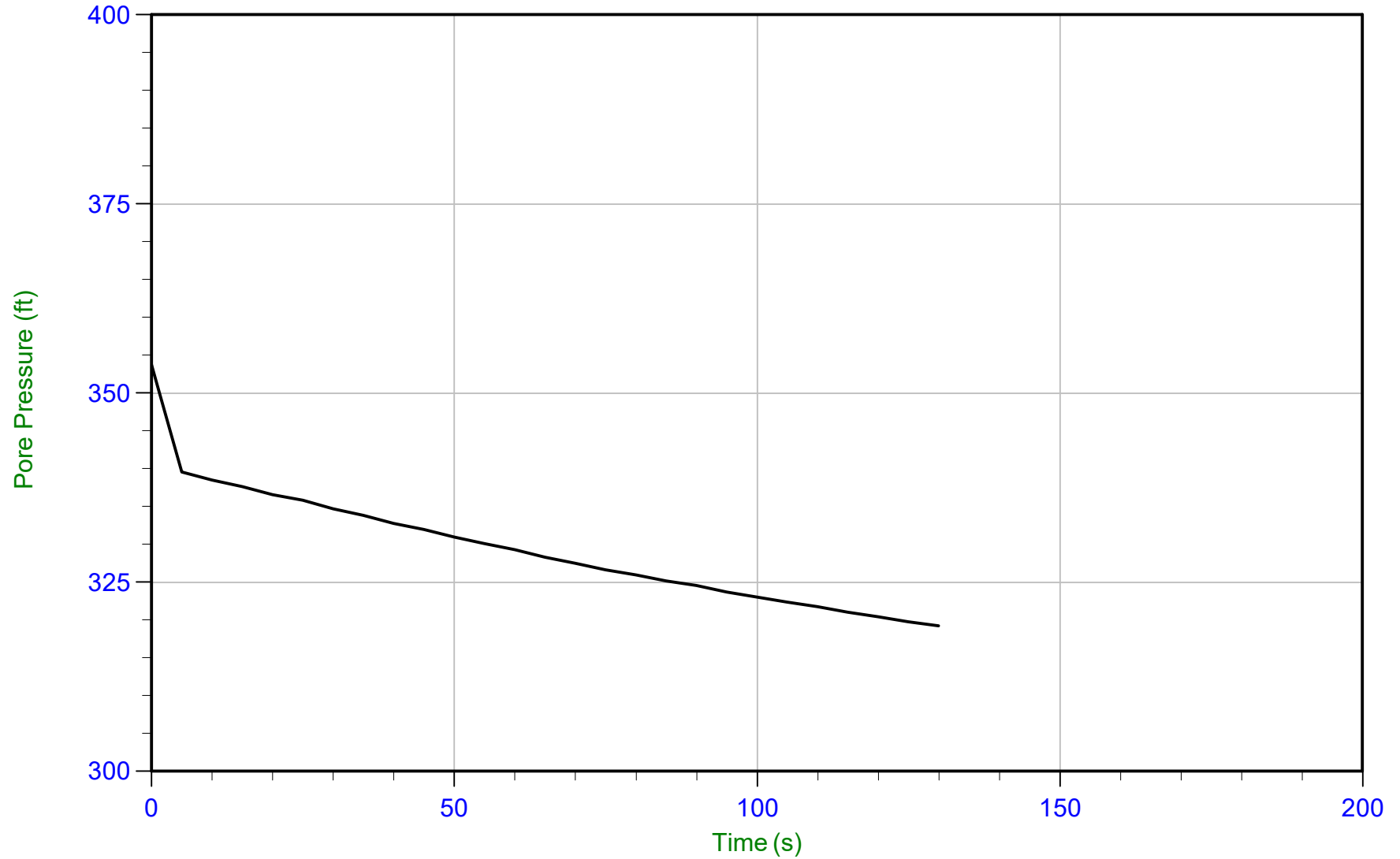

Trace Summary:

Filename: 20-61-21681_CP06B.PPF
Depth: 30.500 m / 100.064 ft
Duration: 130.0 s

u Min: 319.2 ft
u Max: 353.7 ft
u Final: 319.2 ft



Geosyntec

Job No: 20-61-21681
Date: 12/09/2020 11:04
Site: DTE Belle River Power Plant

Sounding: CPT20-07
Cone: 513:T1500F15U500 Area=15 cm²

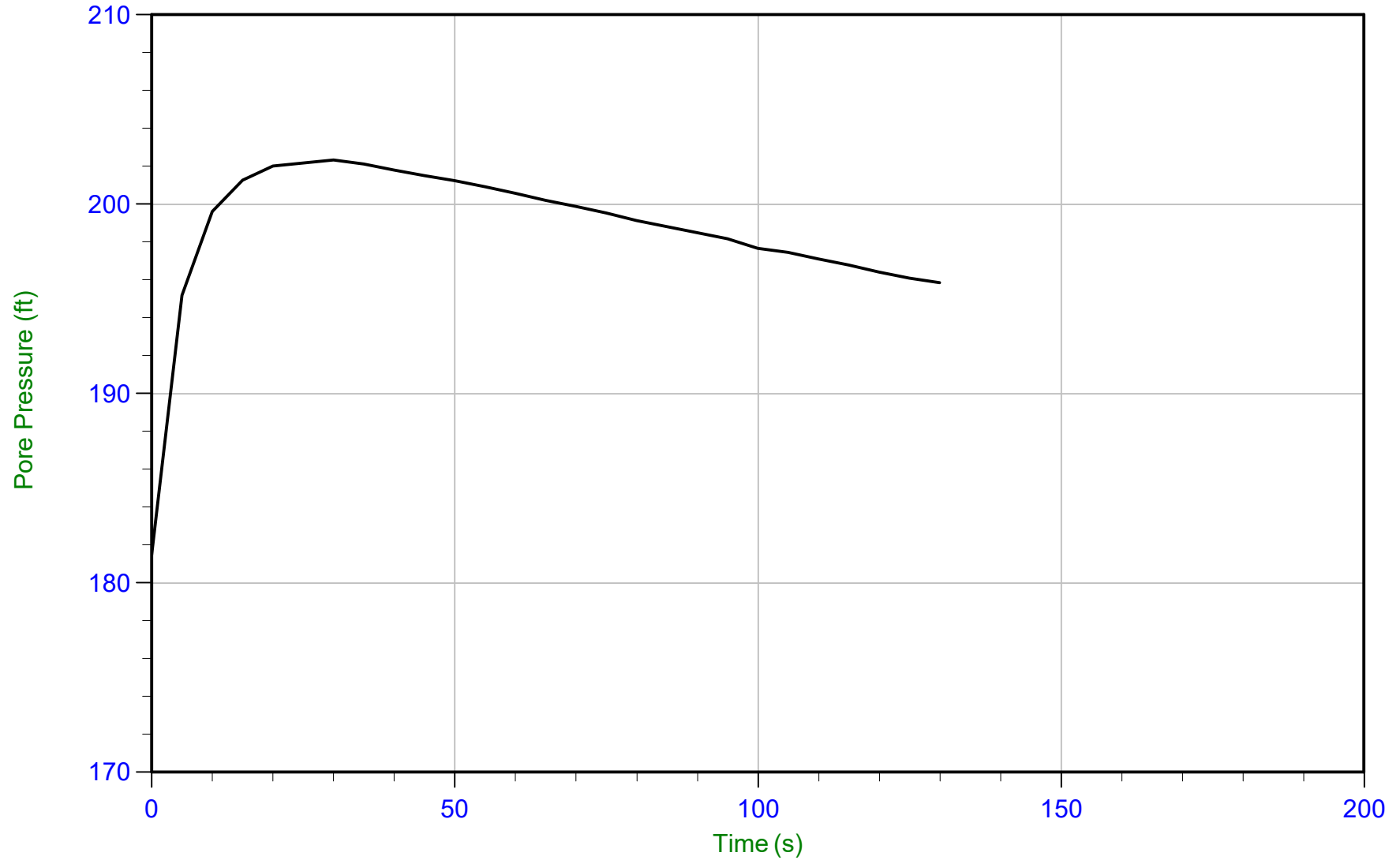

Trace Summary:

Filename: 20-61-21681_CP07.PPF
Depth: 18.800 m / 61.679 ft
Duration: 130.0 s

u Min: 181.5 ft
u Max: 202.3 ft
u Final: 195.9 ft



Geosyntec

Job No: 20-61-21681
Date: 12/11/2020 12:35
Site: DTE Belle River Power Plant

Sounding: CPT20-08B
Cone: 568:T1500F15U500 Area=15 cm²

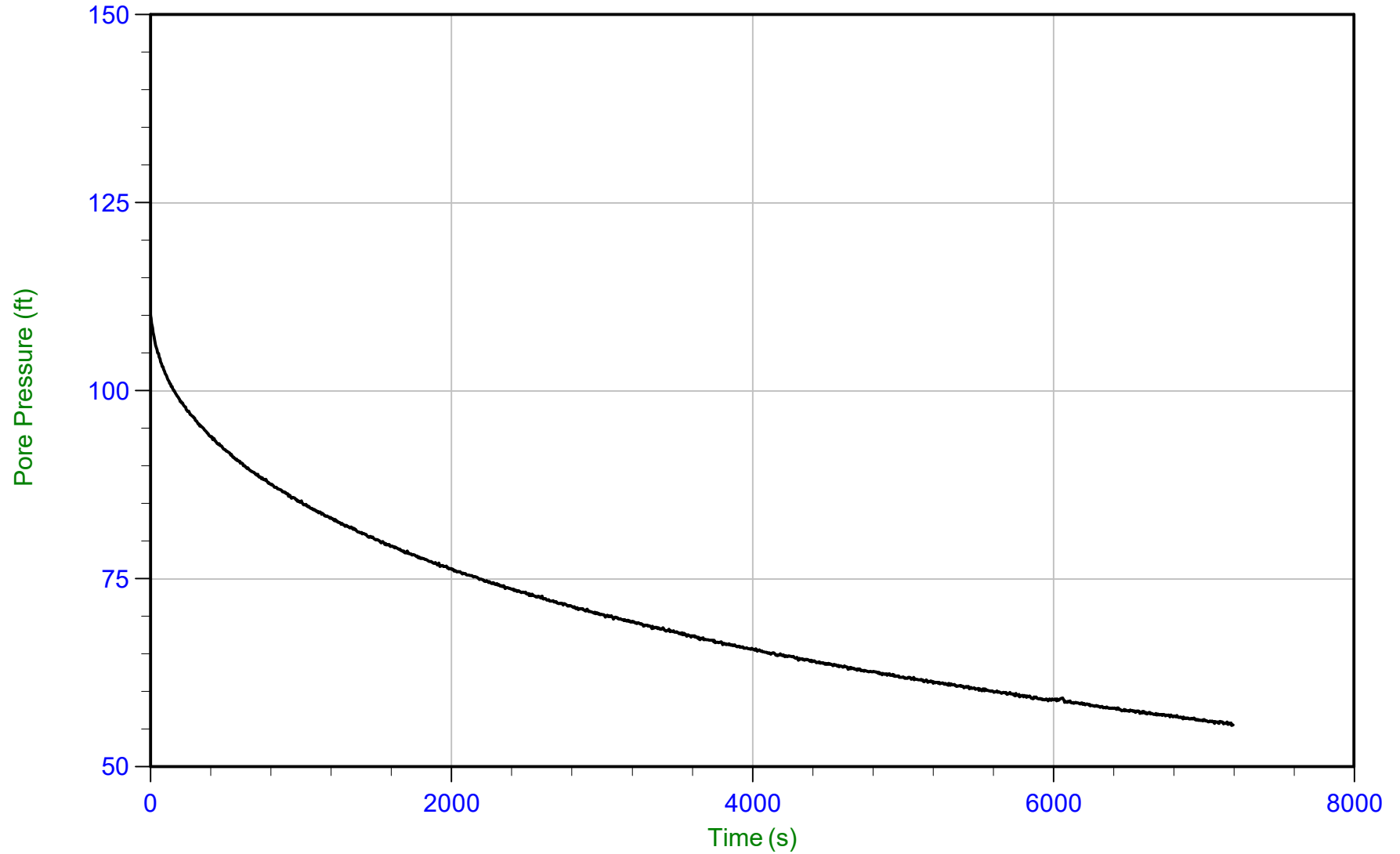

Trace Summary:

Filename: 20-61-21681_CP08B.PPF
Depth: 6.100 m / 20.013 ft
Duration: 7200.0 s

u Min: 55.5 ft
u Max: 110.1 ft
u Final: 55.5 ft

WT: 4.877 m / 16.000 ft
Ueq: 4.0 ft
U(50): 57.04 ft

T(50): 6624.7 s
lr: 100
Ch: 0.1 cm²/min



Geosyntec

Job No: 20-61-21681
Date: 12/11/2020 12:35
Site: DTE Belle River Power Plant

Sounding: CPT20-08B
Cone: 568:T1500F15U500 Area=15 cm²

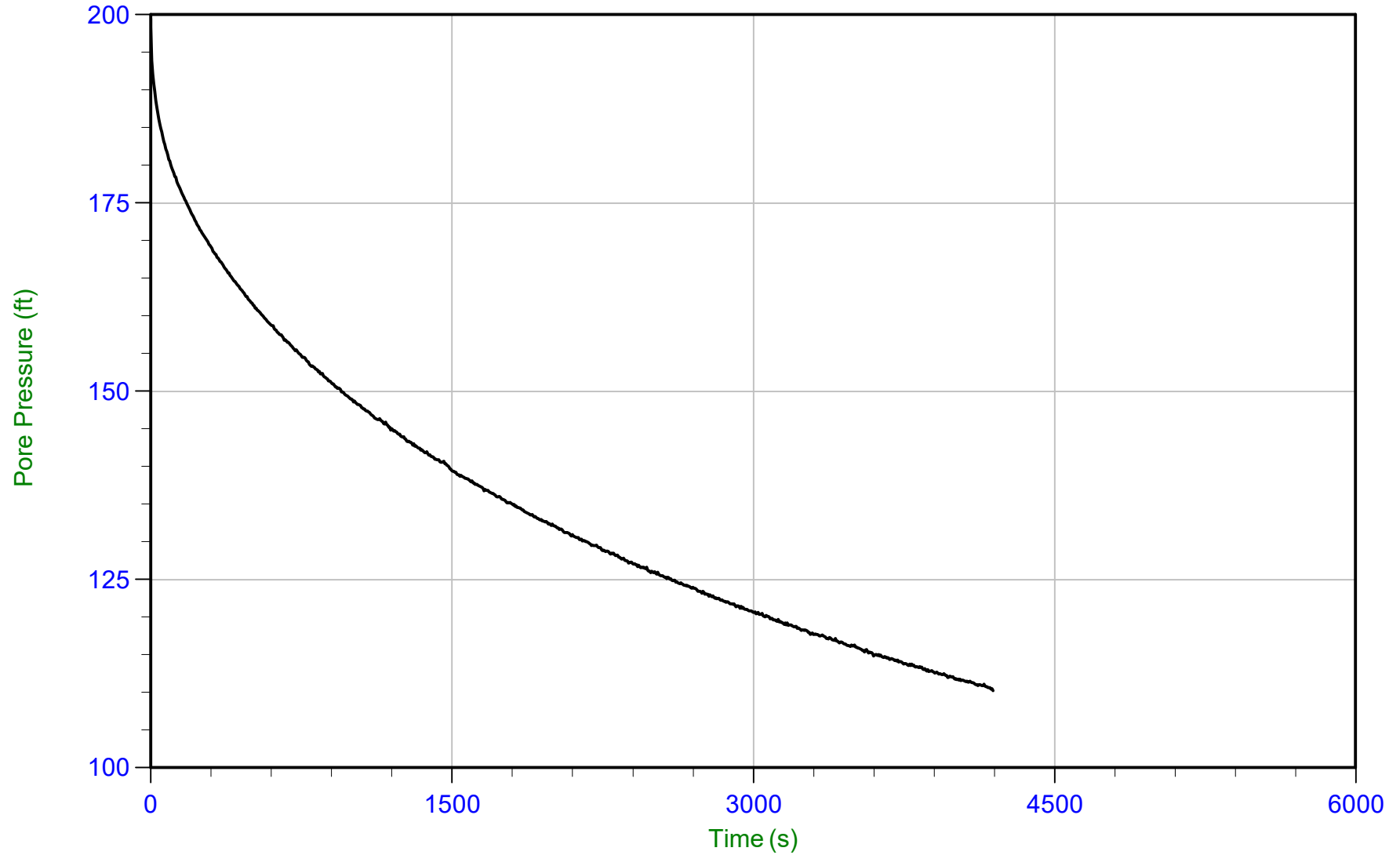

Trace Summary:

Filename: 20-61-21681_CP08B.PPF
Depth: 12.200 m / 40.026 ft
Duration: 4195.0 s

u Min: 110.2 ft
u Max: 199.5 ft
u Final: 110.2 ft

WT: 4.877 m / 16.000 ft
Ueq: 24.0 ft
U(50): 111.76 ft

T(50): 4004.2 s
lr: 100
Ch: 0.2 cm²/min



Geosyntec

Job No: 20-61-21681
Date: 12/15/2020 08:41
Site: DTE Belle River Power Plant

Sounding: CPT20-08C
Cone: 568:T1500F15U500 Area=15 cm²

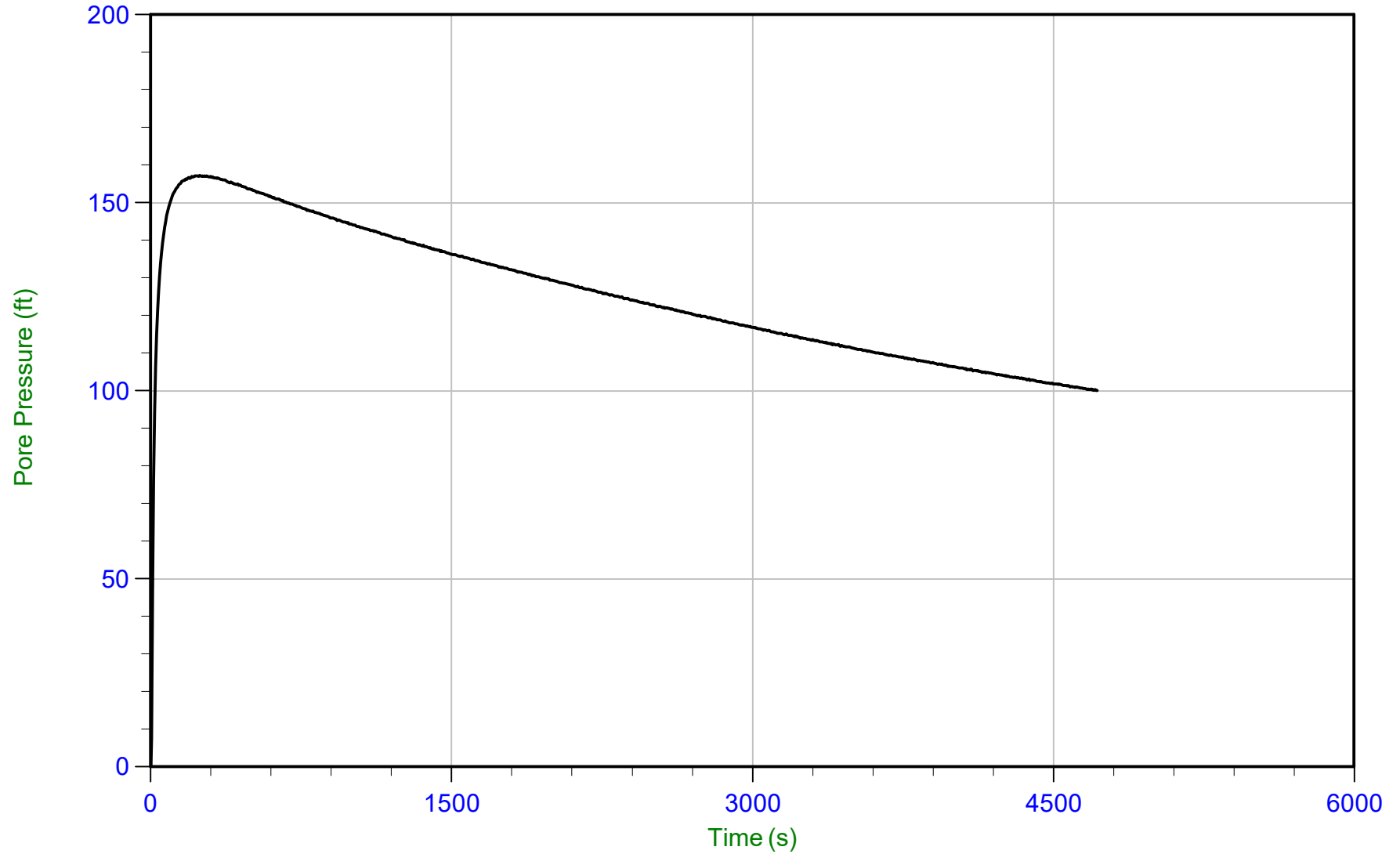

Trace Summary:

Filename: 20-61-21681_CP08C.PPF
Depth: 18.300 m / 60.039 ft
Duration: 4720.0 s

u Min: -7.2 ft
u Max: 157.2 ft
u Final: 100.1 ft

WT: 4.877 m / 16.000 ft
Ueq: 44.0 ft
U(50): 100.63 ft

T(50): 4406.0 s
lr: 100
Ch: 0.2 cm²/min



Geosyntec

Job No: 20-61-21681
Date: 12/15/2020 08:41
Site: DTE Belle River Power Plant

Sounding: CPT20-08C
Cone: 568:T1500F15U500 Area=15 cm²

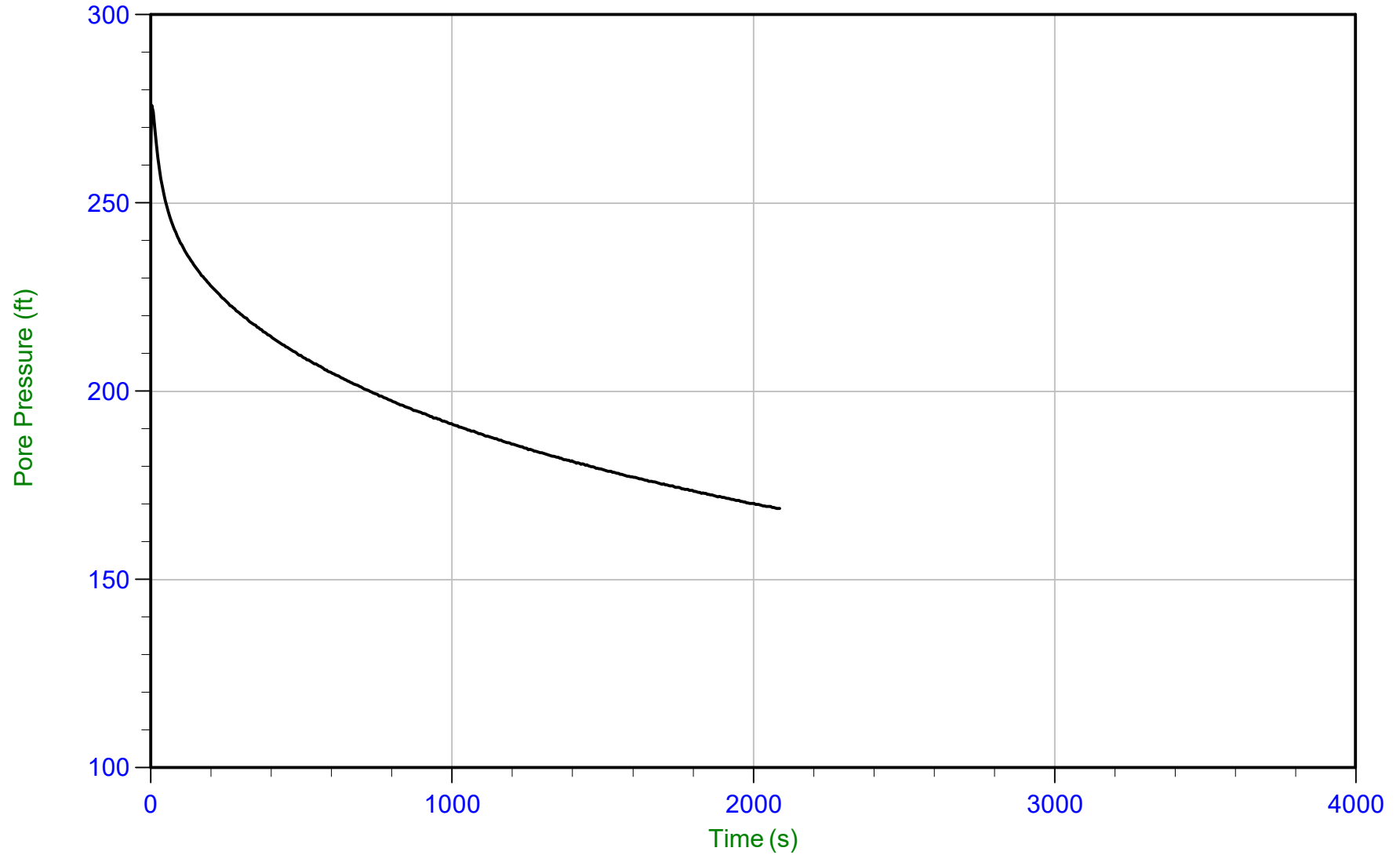

Trace Summary:

Filename: 20-61-21681_CP08C.PPF
Depth: 24.400 m / 80.052 ft
Duration: 2090.0 s

u Min: 168.8 ft
u Max: 276.0 ft
u Final: 168.8 ft

WT: 4.877 m / 16.000 ft
Ueq: 64.1 ft
U(50): 170.02 ft

T(50): 2003.9 s
lr: 100
Ch: 0.4 cm²/min



Geosyntec

Job No: 20-61-21681
Date: 12/15/2020 08:41
Site: DTE Belle River Power Plant

Sounding: CPT20-08C
Cone: 568:T1500F15U500 Area=15 cm²

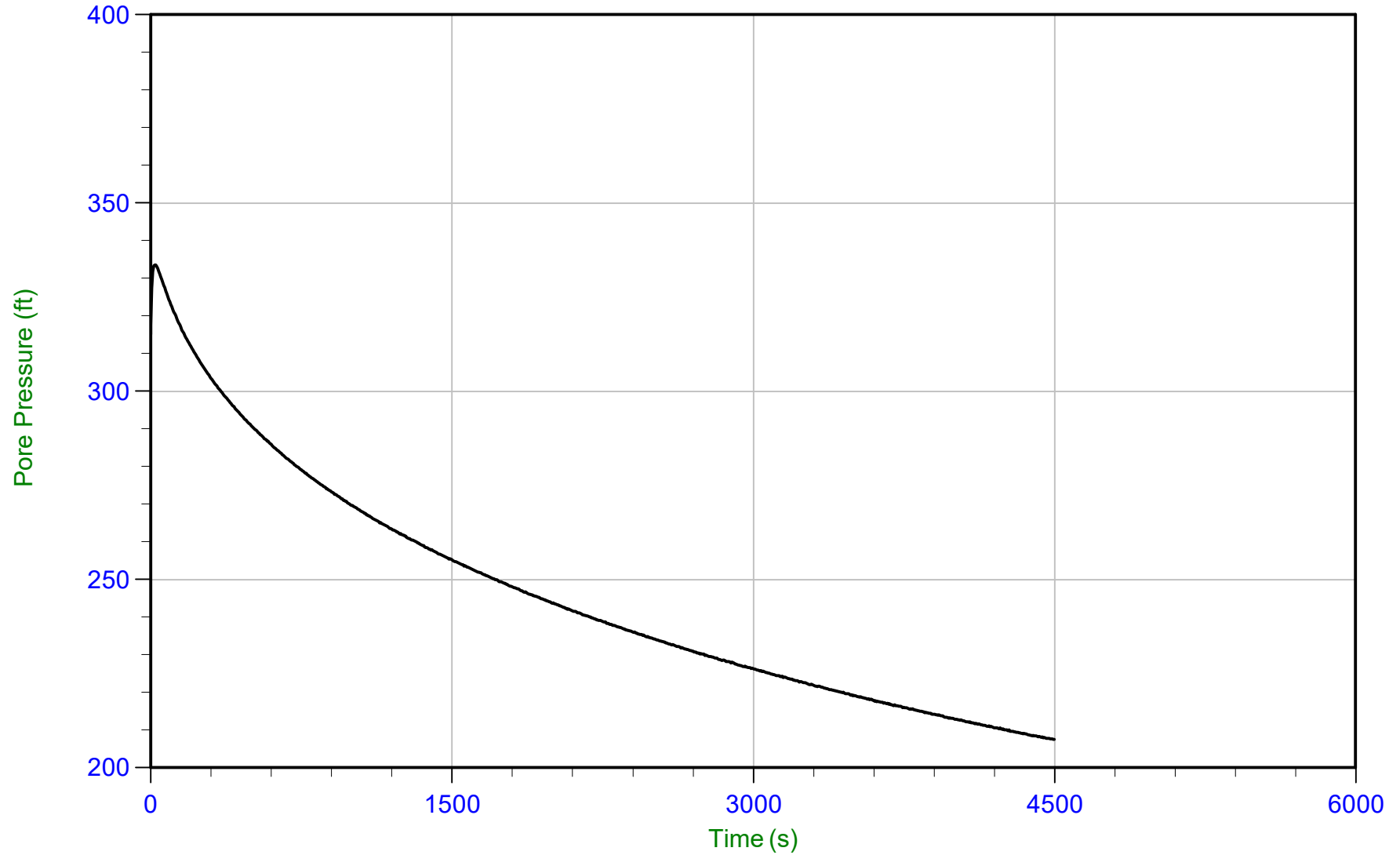

Trace Summary:

Filename: 20-61-21681_CP08C.PPF
Depth: 30.500 m / 100.064 ft
Duration: 4500.0 s

u Min: 207.5 ft
u Max: 333.6 ft
u Final: 207.5 ft

WT: 4.877 m / 16.000 ft
Ueq: 84.1 ft
U(50): 208.83 ft

T(50): 4346.6 s
lr: 100
Ch: 0.2 cm²/min



Geosyntec

Job No: 20-61-21681
Date: 12/10/2020 15:00
Site: DTE Belle River Power Plant

Sounding: CPT20-13
Cone: 513:T1500F15U500 Area=15 cm²

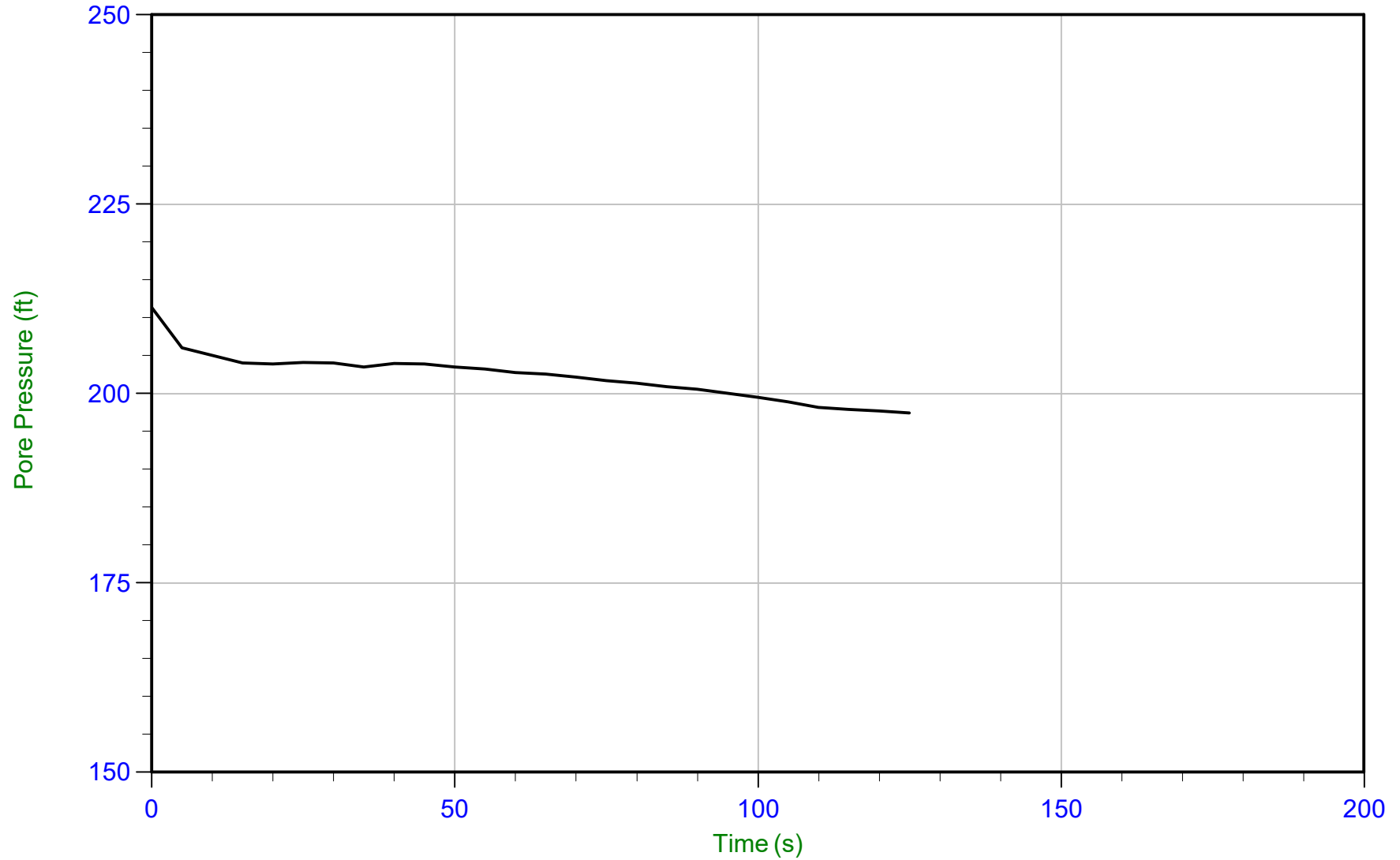

Trace Summary:

Filename: 20-61-21681_CP13.PPF
Depth: 17.200 m / 56.430 ft
Duration: 125.0 s

u Min: 197.4 ft
u Max: 211.4 ft
u Final: 197.4 ft



Geosyntec

Job No: 20-61-21681
Date: 12/11/2020 09:09
Site: DTE Belle River Power Plant

Sounding: CPT20-13B
Cone: 568:T1500F15U500 Area=15 cm²

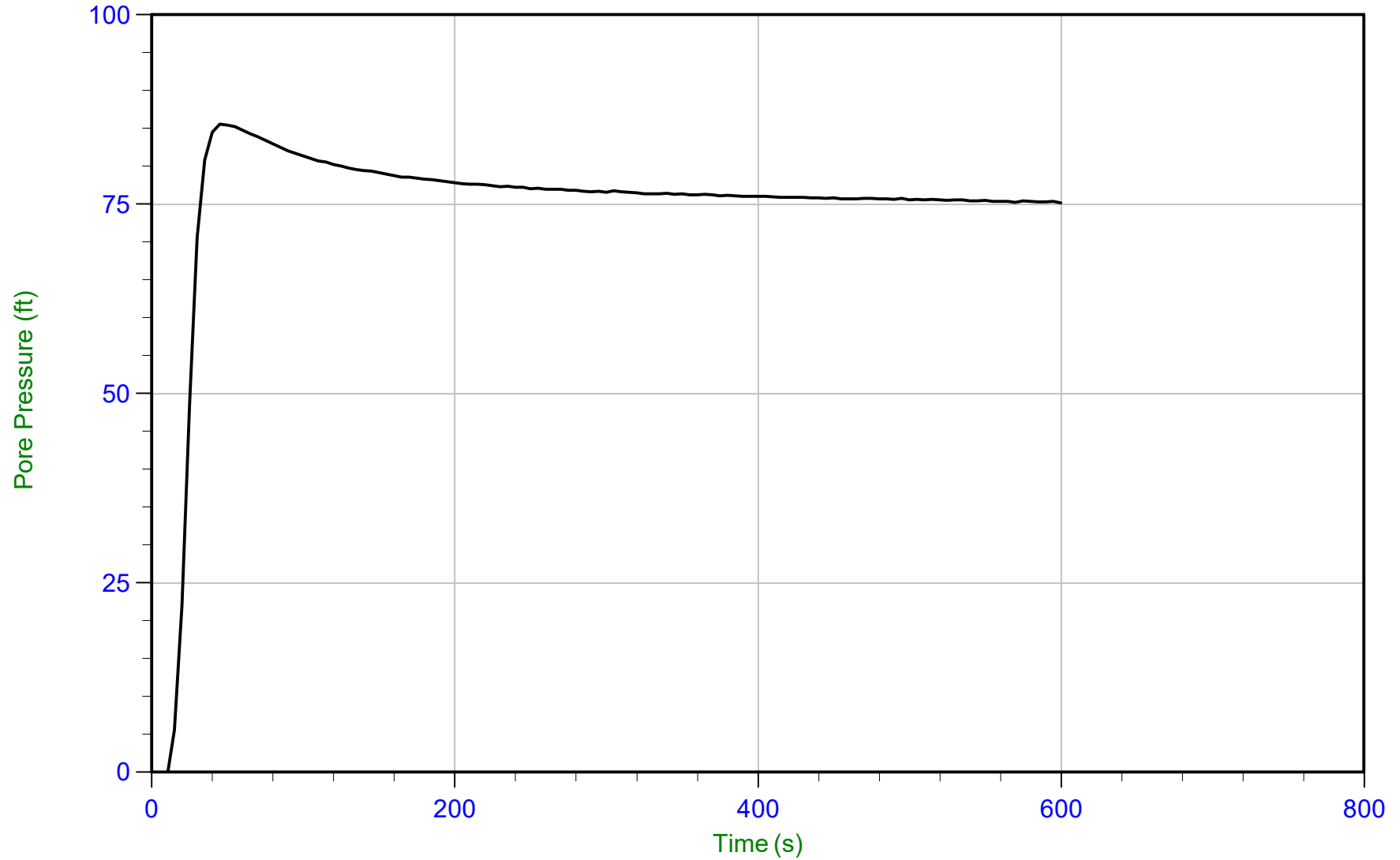

Trace Summary:

Filename: 20-61-21681_CP13B.PPF
Depth: 25.200 m / 82.676 ft
Duration: 600.0 s

u Min: -3.9 ft
u Max: 85.6 ft
u Final: 75.2 ft

WT: 3.962 m / 13.000 ft
Ueq: 69.7 ft
U(50): 77.63 ft

T(50): 171.6 s
lr: 100
Ch: 4.1 cm²/min

APPENDIX J – CHEMISTRY ANALYSIS OF SITE-SPECIFIC WATER



05-Jan-2021

Michael Coram
Geosyntec Consultants
2100 Commonwealth Blvd.
Suite 100
Ann Arbor, MI 48105

Re: **DTE- Belle River (GLP-8017)**

Work Order: **20121752**

Dear Michael,

ALS Environmental received 3 samples on 18-Dec-2020 10:00 AM for the analyses presented in the following report.

The analytical data provided relates directly to the samples received by ALS Environmental - Holland and for only the analyses requested.

Sample results are compliant with industry accepted practices and Quality Control results achieved laboratory specifications. Any exceptions are noted in the Case Narrative, or noted with qualifiers in the report or QC batch information. Should this laboratory report need to be reproduced, it should be reproduced in full unless written approval has been obtained from ALS Environmental. Samples will be disposed in 30 days unless storage arrangements are made.

The total number of pages in this report is 21.

If you have any questions regarding this report, please feel free to contact me:

ADDRESS: 3352 128th Avenue, Holland, MI, USA
PHONE: +1 (616) 399-6070 FAX: +1 (616) 399-6185

Sincerely,

A handwritten signature in black ink, appearing to read "Chad Whelton", is written over a light blue horizontal line.

Electronically approved by: Chad Whelton

Chad Whelton
Project Manager

Report of Laboratory Analysis

Certificate No: MN 026-999-449

ALS GROUP USA, CORP Part of the ALS Laboratory Group A Campbell Brothers Limited Company

Environmental

www.alsglobal.com

RIGHT SOLUTIONS RIGHT PARTNER

Client: Geosyntec Consultants
Project: DTE- Belle River (GLP-8017)
Work Order: 20121752

Work Order Sample Summary

<u>Lab Samp ID</u>	<u>Client Sample ID</u>	<u>Matrix</u>	<u>Tag Number</u>	<u>Collection Date</u>	<u>Date Received</u>	<u>Hold</u>
20121752-01	BAB-E	Groundwater		12/16/2020 15:00	12/18/2020 10:00	<input type="checkbox"/>
20121752-02	BAB-W	Groundwater		12/16/2020 14:00	12/18/2020 10:00	<input type="checkbox"/>
20121752-03	DB	Groundwater		12/16/2020 16:00	12/18/2020 10:00	<input type="checkbox"/>

Client: Geosyntec Consultants
Project: DTE- Belle River (GLP-8017)
Work Order: 20121752

Case Narrative

Samples for the above noted Work Order were received on 12/18/2020. The attached "Sample Receipt Checklist" documents the status of custody seals, container integrity, preservation, and temperature compliance.

Samples were analyzed according to the analytical methodology previously transmitted in the "Work Order Acknowledgement". Methodologies are also documented in the "Analytical Result" section for each sample. Quality control results are listed in the "QC Report" section. Sample association for the reported quality control is located at the end of each batch summary. If applicable, results are appropriately qualified in the Analytical Result and QC Report sections. The "Qualifiers" section documents the various qualifiers, units, and acronyms utilized in reporting. A copy of the laboratory's scope of accreditation is available upon request.

With the following exceptions, all sample analyses achieved analytical criteria.

Metals:

No other deviations or anomalies were noted.

Wet Chemistry:

Batch R306912, Method SW9040C, Sample BAB-E (20121752-01B): pH is considered a "field test" and, as such, the recommended sample holding time expired prior to sample receipt.

Batch R306912, Method SW9040C, Sample BAB-W (20121752-02B): pH is considered a "field test" and, as such, the recommended sample holding time expired prior to sample receipt.

Batch R306912, Method SW9040C, Sample DB (20121752-03B): pH is considered a "field test" and, as such, the recommended sample holding time expired prior to sample receipt.

Batch R307145, Method SW9056A, Sample 20121752-03B MSD: The MSD recovery was outside of the control limit for Sulfate; however, the result in the parent sample is greater than 4x the spike amount. No qualification is required.

<u>Qualifier</u>	<u>Description</u>
*	Value exceeds Regulatory Limit
**	Estimated Value
a	Analyte is non-accredited
B	Analyte detected in the associated Method Blank above the Reporting Limit
E	Value above quantitation range
H	Analyzed outside of Holding Time
Hr	BOD/CBOD - Sample was reset outside Hold Time, value should be considered estimated.
J	Analyte is present at an estimated concentration between the MDL and Report Limit
ND	Not Detected at the Reporting Limit
O	Sample amount is > 4 times amount spiked
P	Dual Column results percent difference > 40%
R	RPD above laboratory control limit
S	Spike Recovery outside laboratory control limits
U	Analyzed but not detected above the MDL
X	Analyte was detected in the Method Blank between the MDL and Reporting Limit, sample results may exhibit background or reagent contamination at the observed level.

<u>Acronym</u>	<u>Description</u>
DUP	Method Duplicate
LCS	Laboratory Control Sample
LCSD	Laboratory Control Sample Duplicate
LOD	Limit of Detection (see MDL)
LOQ	Limit of Quantitation (see PQL)
MBLK	Method Blank
MDL	Method Detection Limit
MS	Matrix Spike
MSD	Matrix Spike Duplicate
PQL	Practical Quantitation Limit
RPD	Relative Percent Difference
TDL	Target Detection Limit
TNTC	Too Numerous To Count
A	APHA Standard Methods
D	ASTM
E	EPA
SW	SW-846 Update III

<u>Units Reported</u>	<u>Description</u>
°C	Degrees Celcius
mg/L	Milligrams per Liter
s.u.	Standard Units

ALS Group, USA

Date: 05-Jan-21

Client: Geosyntec Consultants
Project: DTE- Belle River (GLP-8017)
Sample ID: BAB-E
Collection Date: 12/16/2020 03:00 PM

Work Order: 20121752
Lab ID: 20121752-01
Matrix: GROUNDWATER

Analyses	Result	Qual	Report Limit	Units	Dilution Factor	Date Analyzed
MERCURY BY CVA			SW7470A		Prep: SW7470 12/30/20 13:08	Analyst: MAC
Mercury	ND		0.00020	mg/L	1	12/30/2020 01:26 PM
METALS BY ICP-MS			SW6020B		Prep: SW3005A 12/30/20 15:00	Analyst: STP
Antimony	ND		0.0050	mg/L	1	12/30/2020 09:06 PM
Arsenic	ND		0.0050	mg/L	1	12/30/2020 09:06 PM
Barium	0.21		0.0050	mg/L	1	12/30/2020 09:06 PM
Beryllium	ND		0.0020	mg/L	1	12/30/2020 09:06 PM
Boron	0.26		0.020	mg/L	1	12/30/2020 09:06 PM
Cadmium	ND		0.0020	mg/L	1	12/30/2020 09:06 PM
Calcium	39		0.50	mg/L	1	12/30/2020 09:06 PM
Chromium	ND		0.0050	mg/L	1	12/30/2020 09:06 PM
Cobalt	ND		0.0050	mg/L	1	12/30/2020 09:06 PM
Iron	ND		0.080	mg/L	1	12/30/2020 09:06 PM
Lead	ND		0.0050	mg/L	1	12/30/2020 09:06 PM
Lithium	0.014		0.010	mg/L	1	12/30/2020 09:06 PM
Magnesium	7.9		0.20	mg/L	1	12/30/2020 09:06 PM
Manganese	ND		0.0050	mg/L	1	12/30/2020 09:06 PM
Molybdenum	0.024		0.0050	mg/L	1	12/30/2020 09:06 PM
Potassium	3.0		0.20	mg/L	1	12/30/2020 09:06 PM
Selenium	ND		0.0050	mg/L	1	12/30/2020 09:06 PM
Sodium	29		0.20	mg/L	1	12/30/2020 09:06 PM
Thallium	ND		0.0050	mg/L	1	12/30/2020 09:06 PM
ALKALINITY			A2320 B-11			Analyst: QTN
Alkalinity, Bicarbonate (as CaCO3)	71		10	mg/L	1	12/29/2020 11:55 AM
Alkalinity, Carbonate (as CaCO3)	20		10	mg/L	1	12/29/2020 11:55 AM
Alkalinity, Hydroxide (as CaCO3)	ND		10	mg/L	1	12/29/2020 11:55 AM
Alkalinity, Phenolphthalein (as CaCO3)	10		10	mg/L	1	12/29/2020 11:55 AM
Alkalinity, Total (as CaCO3)	91		10	mg/L	1	12/29/2020 11:55 AM
ANIONS BY ION CHROMATOGRAPHY			SW9056A			Analyst: JDR
Chloride	8.6		1.0	mg/L	1	12/30/2020 07:11 PM
Fluoride	0.25		0.10	mg/L	1	12/30/2020 07:11 PM
Sulfate	94		8.0	mg/L	8	12/31/2020 02:59 PM
PH (LABORATORY)			SW9040C			Analyst: QTN
pH (laboratory)	8.84	H	0.100	s.u.	1	12/29/2020 11:55 AM
Temperature	20.8	H	0.100	°C	1	12/29/2020 11:55 AM
TOTAL DISSOLVED SOLIDS			A2540 C-11		Prep: FILTER 12/22/20 11:40	Analyst: AJS
Total Dissolved Solids	240		50	mg/L	1	12/23/2020 02:50 PM

Note: See Qualifiers page for a list of qualifiers and their definitions.

ALS Group, USA

Date: 05-Jan-21

Client: Geosyntec Consultants
Project: DTE- Belle River (GLP-8017)
Sample ID: BAB-W
Collection Date: 12/16/2020 02:00 PM

Work Order: 20121752
Lab ID: 20121752-02
Matrix: GROUNDWATER

Analyses	Result	Qual	Report Limit	Units	Dilution Factor	Date Analyzed
MERCURY BY CVA			SW7470A		Prep: SW7470 12/30/20 13:08	Analyst: MAC
Mercury	ND		0.00020	mg/L	1	12/30/2020 01:28 PM
METALS BY ICP-MS			SW6020B		Prep: SW3005A 12/30/20 15:00	Analyst: STP
Antimony	ND		0.0050	mg/L	1	12/30/2020 09:08 PM
Arsenic	ND		0.0050	mg/L	1	12/30/2020 09:08 PM
Barium	0.30		0.0050	mg/L	1	12/30/2020 09:08 PM
Beryllium	ND		0.0020	mg/L	1	12/30/2020 09:08 PM
Boron	0.21		0.020	mg/L	1	12/30/2020 09:08 PM
Cadmium	ND		0.0020	mg/L	1	12/30/2020 09:08 PM
Calcium	54		0.50	mg/L	1	12/30/2020 09:08 PM
Chromium	ND		0.0050	mg/L	1	12/30/2020 09:08 PM
Cobalt	ND		0.0050	mg/L	1	12/30/2020 09:08 PM
Iron	0.28		0.080	mg/L	1	12/31/2020 05:14 PM
Lead	ND		0.0050	mg/L	1	12/30/2020 09:08 PM
Lithium	0.013		0.010	mg/L	1	12/30/2020 09:08 PM
Magnesium	10		0.20	mg/L	1	12/30/2020 09:08 PM
Manganese	0.0078		0.0050	mg/L	1	12/30/2020 09:08 PM
Molybdenum	0.016		0.0050	mg/L	1	12/30/2020 09:08 PM
Potassium	3.4		0.20	mg/L	1	12/30/2020 09:08 PM
Selenium	ND		0.0050	mg/L	1	12/30/2020 09:08 PM
Sodium	33		0.20	mg/L	1	12/30/2020 09:08 PM
Thallium	ND		0.0050	mg/L	1	12/30/2020 09:08 PM
ALKALINITY			A2320 B-11			Analyst: QTN
Alkalinity, Bicarbonate (as CaCO3)	83		10	mg/L	1	12/29/2020 11:55 AM
Alkalinity, Carbonate (as CaCO3)	ND		10	mg/L	1	12/29/2020 11:55 AM
Alkalinity, Hydroxide (as CaCO3)	ND		10	mg/L	1	12/29/2020 11:55 AM
Alkalinity, Phenolphthalein (as CaCO3)	ND		10	mg/L	1	12/29/2020 11:55 AM
Alkalinity, Total (as CaCO3)	89		10	mg/L	1	12/29/2020 11:55 AM
ANIONS BY ION CHROMATOGRAPHY			SW9056A			Analyst: JDR
Chloride	9.9		1.0	mg/L	1	12/30/2020 07:30 PM
Fluoride	0.22		0.10	mg/L	1	12/30/2020 07:30 PM
Sulfate	140		8.0	mg/L	8	12/30/2020 06:36 PM
PH (LABORATORY)			SW9040C			Analyst: QTN
pH (laboratory)	8.43	H	0.100	s.u.	1	12/29/2020 11:55 AM
Temperature	20.7	H	0.100	°C	1	12/29/2020 11:55 AM
TOTAL DISSOLVED SOLIDS			A2540 C-11		Prep: FILTER 12/22/20 11:40	Analyst: AJS
Total Dissolved Solids	330		50	mg/L	1	12/23/2020 02:50 PM

Note: See Qualifiers page for a list of qualifiers and their definitions.

ALS Group, USA

Date: 05-Jan-21

Client: Geosyntec Consultants
Project: DTE- Belle River (GLP-8017)
Sample ID: DB
Collection Date: 12/16/2020 04:00 PM

Work Order: 20121752
Lab ID: 20121752-03
Matrix: GROUNDWATER

Analyses	Result	Qual	Report Limit	Units	Dilution Factor	Date Analyzed
MERCURY BY CVA			SW7470A		Prep: SW7470 12/30/20 13:08	Analyst: MAC
Mercury	ND		0.00020	mg/L	1	12/30/2020 01:30 PM
METALS BY ICP-MS			SW6020B		Prep: SW3005A 12/30/20 15:00	Analyst: STP
Antimony	ND		0.0050	mg/L	1	12/30/2020 09:09 PM
Arsenic	0.0057		0.0050	mg/L	1	12/30/2020 09:09 PM
Barium	0.19		0.0050	mg/L	1	12/30/2020 09:09 PM
Beryllium	ND		0.0020	mg/L	1	12/30/2020 09:09 PM
Boron	6.0		0.20	mg/L	10	12/31/2020 05:15 PM
Cadmium	ND		0.0020	mg/L	1	12/30/2020 09:09 PM
Calcium	110		0.50	mg/L	1	12/30/2020 09:09 PM
Chromium	ND		0.0050	mg/L	1	12/30/2020 09:09 PM
Cobalt	ND		0.0050	mg/L	1	12/30/2020 09:09 PM
Iron	0.35		0.080	mg/L	1	12/31/2020 05:17 PM
Lead	ND		0.0050	mg/L	1	12/30/2020 09:09 PM
Lithium	0.061		0.010	mg/L	1	12/30/2020 09:09 PM
Magnesium	18		0.20	mg/L	1	12/30/2020 09:09 PM
Manganese	0.068		0.0050	mg/L	1	12/30/2020 09:09 PM
Molybdenum	0.30		0.0050	mg/L	1	12/30/2020 09:09 PM
Potassium	13		0.20	mg/L	1	12/30/2020 09:09 PM
Selenium	0.0087		0.0050	mg/L	1	12/30/2020 09:09 PM
Sodium	510		2.0	mg/L	10	12/31/2020 05:15 PM
Thallium	ND		0.0050	mg/L	1	12/30/2020 09:09 PM
ALKALINITY			A2320 B-11			Analyst: QTN
Alkalinity, Bicarbonate (as CaCO3)	140		10	mg/L	1	12/29/2020 11:55 AM
Alkalinity, Carbonate (as CaCO3)	ND		10	mg/L	1	12/29/2020 11:55 AM
Alkalinity, Hydroxide (as CaCO3)	ND		10	mg/L	1	12/29/2020 11:55 AM
Alkalinity, Phenolphthalein (as CaCO3)	ND		10	mg/L	1	12/29/2020 11:55 AM
Alkalinity, Total (as CaCO3)	140		10	mg/L	1	12/29/2020 11:55 AM
ANIONS BY ION CHROMATOGRAPHY			SW9056A			Analyst: JDR
Chloride	43		20	mg/L	20	12/30/2020 06:55 PM
Fluoride	0.44		0.10	mg/L	1	12/30/2020 07:49 PM
Sulfate	1,200		100	mg/L	100	12/31/2020 03:21 PM
PH (LABORATORY)			SW9040C			Analyst: QTN
pH (laboratory)	8.32	H	0.100	s.u.	1	12/29/2020 11:55 AM
Temperature	20.1	H	0.100	°C	1	12/29/2020 11:55 AM
TOTAL DISSOLVED SOLIDS			A2540 C-11		Prep: FILTER 12/22/20 11:40	Analyst: AJS
Total Dissolved Solids	2,100		300	mg/L	1	12/23/2020 02:50 PM

Note: See Qualifiers page for a list of qualifiers and their definitions.

Client: Geosyntec Consultants
Work Order: 20121752
Project: DTE- Belle River (GLP-8017)

QC BATCH REPORT

Batch ID: **170071** Instrument ID **HG4** Method: **SW7470A**

MBLK	Sample ID: MBLK-170071-170071				Units: mg/L		Analysis Date: 12/30/2020 01:14 PM			
Client ID:	Run ID: HG4_201230A			SeqNo: 7040771		Prep Date: 12/30/2020		DF: 1		
Analyte	Result	PQL	SPK Val	SPK Ref Value	%REC	Control Limit	RPD Ref Value	%RPD	RPD Limit	Qual

Mercury ND 0.00020

LCS	Sample ID: LCS-170071-170071				Units: mg/L		Analysis Date: 12/30/2020 01:16 PM			
Client ID:	Run ID: HG4_201230A			SeqNo: 7040772		Prep Date: 12/30/2020		DF: 1		
Analyte	Result	PQL	SPK Val	SPK Ref Value	%REC	Control Limit	RPD Ref Value	%RPD	RPD Limit	Qual

Mercury 0.002085 0.00020 0.002 0 104 80-120 0

MS	Sample ID: 20121813-10DMS				Units: mg/L		Analysis Date: 12/30/2020 01:55 PM			
Client ID:	Run ID: HG4_201230A			SeqNo: 7040812		Prep Date: 12/30/2020		DF: 1		
Analyte	Result	PQL	SPK Val	SPK Ref Value	%REC	Control Limit	RPD Ref Value	%RPD	RPD Limit	Qual

Mercury 0.00219 0.00020 0.002 0.000003 109 75-125 0

MSD	Sample ID: 20121813-10DMSD				Units: mg/L		Analysis Date: 12/30/2020 01:57 PM			
Client ID:	Run ID: HG4_201230A			SeqNo: 7040815		Prep Date: 12/30/2020		DF: 1		
Analyte	Result	PQL	SPK Val	SPK Ref Value	%REC	Control Limit	RPD Ref Value	%RPD	RPD Limit	Qual

Mercury 0.002115 0.00020 0.002 0.000003 106 75-125 0.00219 3.48 20

The following samples were analyzed in this batch: 20121752-01A 20121752-02A 20121752-03A

Client: Geosyntec Consultants
Work Order: 20121752
Project: DTE- Belle River (GLP-8017)

QC BATCH REPORT

Batch ID: **170083** Instrument ID **ICPMS4** Method: **SW6020B**

MBLK		Sample ID: MBLK-170083-170083				Units: mg/L		Analysis Date: 12/30/2020 08:51 PM		
Client ID:		Run ID: ICPMS4_201230A		SeqNo: 7043005		Prep Date: 12/30/2020		DF: 1		
Analyte	Result	PQL	SPK Val	SPK Ref Value	%REC	Control Limit	RPD Ref Value	%RPD	RPD Limit	Qual
Antimony	ND	0.0050								
Arsenic	ND	0.0050								
Barium	ND	0.0050								
Beryllium	ND	0.0020								
Boron	ND	0.020								
Cadmium	ND	0.0020								
Calcium	ND	0.50								
Chromium	ND	0.0050								
Cobalt	ND	0.0050								
Iron	ND	0.080								
Lead	ND	0.0050								
Lithium	ND	0.010								
Magnesium	ND	0.20								
Manganese	ND	0.0050								
Molybdenum	ND	0.0050								
Potassium	ND	0.20								
Selenium	ND	0.0050								
Sodium	ND	0.20								
Thallium	ND	0.0050								

Note: See Qualifiers Page for a list of Qualifiers and their explanation.

Client: Geosyntec Consultants
Work Order: 20121752
Project: DTE- Belle River (GLP-8017)

QC BATCH REPORT

Batch ID: **170083** Instrument ID **ICPMS4** Method: **SW6020B**

LCS		Sample ID: LCS-170083-170083				Units: mg/L		Analysis Date: 12/30/2020 08:52 PM		
Client ID:		Run ID: ICPMS4_201230A			SeqNo: 7043006		Prep Date: 12/30/2020		DF: 1	
Analyte	Result	PQL	SPK Val	SPK Ref Value	%REC	Control Limit	RPD Ref Value	%RPD	RPD Limit	Qual
Antimony	0.09984	0.0050	0.1	0	99.8	80-120	0			
Arsenic	0.099	0.0050	0.1	0	99	80-120	0			
Barium	0.1005	0.0050	0.1	0	100	80-120	0			
Beryllium	0.09793	0.0020	0.1	0	97.9	80-120	0			
Boron	0.4459	0.020	0.5	0	89.2	80-120	0			
Cadmium	0.1049	0.0020	0.1	0	105	80-120	0			
Calcium	9.959	0.50	10	0	99.6	80-120	0			
Chromium	0.09764	0.0050	0.1	0	97.6	80-120	0			
Cobalt	0.09865	0.0050	0.1	0	98.6	80-120	0			
Iron	9.742	0.080	10	0	97.4	80-120	0			
Lead	0.09896	0.0050	0.1	0	99	80-120	0			
Lithium	0.09939	0.010	0.1	0	99.4	80-120	0			
Magnesium	10.41	0.20	10	0	104	80-120	0			
Manganese	0.09726	0.0050	0.1	0	97.3	80-120	0			
Molybdenum	0.09949	0.0050	0.1	0	99.5	80-120	0			
Potassium	10.09	0.20	10	0	101	80-120	0			
Selenium	0.09876	0.0050	0.1	0	98.8	80-120	0			
Sodium	10.48	0.20	10	0	105	80-120	0			
Thallium	0.09419	0.0050	0.1	0	94.2	80-120	0			

Note: See Qualifiers Page for a list of Qualifiers and their explanation.

Client: Geosyntec Consultants
 Work Order: 20121752
 Project: DTE- Belle River (GLP-8017)

QC BATCH REPORT

Batch ID: 170083 Instrument ID ICPMS4 Method: SW6020B

MS				Sample ID: 20121813-01DMS			Units: mg/L		Analysis Date: 12/30/2020 09:13 PM		
Client ID:		Run ID: ICPMS4_201230A			SeqNo: 7043018		Prep Date: 12/30/2020		DF: 1		
Analyte	Result	PQL	SPK Val	SPK Ref Value	%REC	Control Limit	RPD Ref Value	%RPD	RPD Limit	Qual	
Antimony	0.0939	0.0050	0.1	0.000019	93.9	75-125	0				
Arsenic	0.09542	0.0050	0.1	0.000523	94.9	75-125	0				
Barium	0.1197	0.0050	0.1	0.01914	101	75-125	0				
Beryllium	0.1028	0.0020	0.1	0.003422	99.4	75-125	0				
Boron	0.5173	0.020	0.5	0.07866	87.7	75-125	0				
Cadmium	0.09866	0.0020	0.1	0.003046	95.6	75-125	0				
Calcium	63.88	0.50	10	53.04	108	75-125	0			O	
Chromium	0.09053	0.0050	0.1	0.000351	90.2	75-125	0				
Cobalt	0.2039	0.0050	0.1	0.1134	90.5	75-125	0				
Iron	8.964	0.080	10	0.02083	89.4	75-125	0				
Lead	0.09794	0.0050	0.1	0.000674	97.3	75-125	0				
Lithium	0.1112	0.010	0.1	0.01095	100	75-125	0				
Magnesium	61.4	0.20	10	51.16	102	75-125	0			O	
Molybdenum	0.09472	0.0050	0.1	0.001008	93.7	75-125	0				
Potassium	12.35	0.20	10	2.605	97.4	75-125	0				
Selenium	0.1012	0.0050	0.1	0.005949	95.3	75-125	0				
Sodium	65.82	0.20	10	55.83	99.9	75-125	0			O	
Thallium	0.09224	0.0050	0.1	0.000037	92.2	75-125	0				

MS				Sample ID: 20121813-10DMS			Units: mg/L		Analysis Date: 12/30/2020 09:35 PM		
Client ID:		Run ID: ICPMS4_201230A			SeqNo: 7043031		Prep Date: 12/30/2020		DF: 1		
Analyte	Result	PQL	SPK Val	SPK Ref Value	%REC	Control Limit	RPD Ref Value	%RPD	RPD Limit	Qual	
Antimony	0.09845	0.0050	0.1	0.000041	98.4	75-125	0				
Arsenic	0.1005	0.0050	0.1	0.00021	100	75-125	0				
Barium	0.125	0.0050	0.1	0.02584	99.1	75-125	0				
Beryllium	0.1046	0.0020	0.1	0.002214	102	75-125	0				
Boron	0.5169	0.020	0.5	0.056	92.2	75-125	0				
Cadmium	0.1056	0.0020	0.1	0.005454	100	75-125	0				
Calcium	34.88	0.50	10	25.15	97.2	75-125	0				
Chromium	0.09457	0.0050	0.1	0.000785	93.8	75-125	0				
Cobalt	0.2768	0.0050	0.1	0.1806	96.2	75-125	0				
Iron	9.488	0.080	10	0.143	93.5	75-125	0				
Lead	0.09729	0.0050	0.1	0.001591	95.7	75-125	0				
Lithium	0.107	0.010	0.1	0.006549	100	75-125	0				
Magnesium	24.92	0.20	10	15.27	96.4	75-125	0				
Molybdenum	0.0977	0.0050	0.1	0.000386	97.3	75-125	0				
Potassium	12.88	0.20	10	3.03	98.5	75-125	0				
Selenium	0.09792	0.0050	0.1	0.001894	96	75-125	0				
Sodium	71.55	0.20	10	61.63	99.1	75-125	0			O	
Thallium	0.09151	0.0050	0.1	0.000106	91.4	75-125	0				

Note: See Qualifiers Page for a list of Qualifiers and their explanation.

Client: Geosyntec Consultants
 Work Order: 20121752
 Project: DTE- Belle River (GLP-8017)

QC BATCH REPORT

Batch ID: 170083 Instrument ID ICPMS4 Method: SW6020B

MS				Sample ID: 20121813-01DMS		Units: mg/L		Analysis Date: 12/31/2020 05:20 PM		
Client ID:		Run ID: ICPMS4_201231A		SeqNo: 7046543		Prep Date: 12/30/2020		DF: 10		
Analyte	Result	PQL	SPK Val	SPK Ref Value	%REC	Control Limit	RPD Ref Value	%RPD	RPD Limit	Qual
Manganese	3.991	0.050	0.1	3.949	41.3	75-125	0			SO

MS				Sample ID: 20121813-10DMS		Units: mg/L		Analysis Date: 12/31/2020 05:39 PM		
Client ID:		Run ID: ICPMS4_201231A		SeqNo: 7046555		Prep Date: 12/30/2020		DF: 10		
Analyte	Result	PQL	SPK Val	SPK Ref Value	%REC	Control Limit	RPD Ref Value	%RPD	RPD Limit	Qual
Manganese	4.091	0.050	0.1	3.865	227	75-125	0			SO

MSD				Sample ID: 20121813-01DMSD		Units: mg/L		Analysis Date: 12/30/2020 09:15 PM		
Client ID:		Run ID: ICPMS4_201230A		SeqNo: 7043019		Prep Date: 12/30/2020		DF: 1		
Analyte	Result	PQL	SPK Val	SPK Ref Value	%REC	Control Limit	RPD Ref Value	%RPD	RPD Limit	Qual
Antimony	0.09655	0.0050	0.1	0.000019	96.5	75-125	0.0939	2.78	20	
Arsenic	0.09753	0.0050	0.1	0.000523	97	75-125	0.09542	2.18	20	
Barium	0.1208	0.0050	0.1	0.01914	102	75-125	0.1197	0.848	20	
Beryllium	0.1044	0.0020	0.1	0.003422	101	75-125	0.1028	1.59	20	
Boron	0.5179	0.020	0.5	0.07866	87.8	75-125	0.5173	0.103	20	
Cadmium	0.1013	0.0020	0.1	0.003046	98.3	75-125	0.09866	2.67	20	
Calcium	62.93	0.50	10	53.04	98.9	75-125	63.88	1.49	20	O
Chromium	0.09296	0.0050	0.1	0.000351	92.6	75-125	0.09053	2.65	20	
Cobalt	0.2064	0.0050	0.1	0.1134	92.9	75-125	0.2039	1.18	20	
Iron	9.236	0.080	10	0.02083	92.1	75-125	8.964	2.99	20	
Lead	0.09947	0.0050	0.1	0.000674	98.8	75-125	0.09794	1.55	20	
Lithium	0.1128	0.010	0.1	0.01095	102	75-125	0.1112	1.45	20	
Magnesium	61.51	0.20	10	51.16	104	75-125	61.4	0.185	20	O
Molybdenum	0.09663	0.0050	0.1	0.001008	95.6	75-125	0.09472	2	20	
Potassium	12.63	0.20	10	2.605	100	75-125	12.35	2.27	20	
Selenium	0.1029	0.0050	0.1	0.005949	96.9	75-125	0.1012	1.62	20	
Sodium	66.86	0.20	10	55.83	110	75-125	65.82	1.56	20	O
Thallium	0.09366	0.0050	0.1	0.000037	93.6	75-125	0.09224	1.53	20	

Note: See Qualifiers Page for a list of Qualifiers and their explanation.

Client: Geosyntec Consultants
 Work Order: 20121752
 Project: DTE- Belle River (GLP-8017)

QC BATCH REPORT

Batch ID: 170083 Instrument ID ICPMS4 Method: SW6020B

MSD				Sample ID: 20121813-10DMSD			Units: mg/L		Analysis Date: 12/30/2020 09:37 PM		
Client ID:		Run ID: ICPMS4_201230A			SeqNo: 7043032		Prep Date: 12/30/2020		DF: 1		
Analyte	Result	PQL	SPK Val	SPK Ref Value	%REC	Control Limit	RPD Ref Value	%RPD	RPD Limit	Qual	
Antimony	0.09824	0.0050	0.1	0.000041	98.2	75-125	0.09845	0.211	20		
Arsenic	0.09954	0.0050	0.1	0.00021	99.3	75-125	0.1005	0.917	20		
Barium	0.1229	0.0050	0.1	0.02584	97	75-125	0.125	1.7	20		
Beryllium	0.1039	0.0020	0.1	0.002214	102	75-125	0.1046	0.636	20		
Boron	0.517	0.020	0.5	0.056	92.2	75-125	0.5169	0.0288	20		
Cadmium	0.1044	0.0020	0.1	0.005454	99	75-125	0.1056	1.11	20		
Calcium	34.42	0.50	10	25.15	92.7	75-125	34.88	1.31	20		
Chromium	0.09402	0.0050	0.1	0.000785	93.2	75-125	0.09457	0.58	20		
Cobalt	0.2727	0.0050	0.1	0.1806	92.2	75-125	0.2768	1.48	20		
Iron	9.402	0.080	10	0.143	92.6	75-125	9.488	0.913	20		
Lead	0.0969	0.0050	0.1	0.001591	95.3	75-125	0.09729	0.394	20		
Lithium	0.1057	0.010	0.1	0.006549	99.1	75-125	0.107	1.23	20		
Magnesium	24.72	0.20	10	15.27	94.4	75-125	24.92	0.809	20		
Molybdenum	0.09638	0.0050	0.1	0.000386	96	75-125	0.0977	1.36	20		
Potassium	12.71	0.20	10	3.03	96.8	75-125	12.88	1.33	20		
Selenium	0.09719	0.0050	0.1	0.001894	95.3	75-125	0.09792	0.75	20		
Sodium	70.5	0.20	10	61.63	88.7	75-125	71.55	1.48	20	O	
Thallium	0.09051	0.0050	0.1	0.000106	90.4	75-125	0.09151	1.1	20		

MSD				Sample ID: 20121813-01DMSD			Units: mg/L		Analysis Date: 12/31/2020 05:22 PM		
Client ID:		Run ID: ICPMS4_201231A			SeqNo: 7046544		Prep Date: 12/30/2020		DF: 10		
Analyte	Result	PQL	SPK Val	SPK Ref Value	%REC	Control Limit	RPD Ref Value	%RPD	RPD Limit	Qual	
Manganese	4.164	0.050	0.1	3.949	215	75-125	3.991	4.26	20	SO	

MSD				Sample ID: 20121813-10DMSD			Units: mg/L		Analysis Date: 12/31/2020 05:41 PM		
Client ID:		Run ID: ICPMS4_201231A			SeqNo: 7046556		Prep Date: 12/30/2020		DF: 10		
Analyte	Result	PQL	SPK Val	SPK Ref Value	%REC	Control Limit	RPD Ref Value	%RPD	RPD Limit	Qual	
Manganese	4.094	0.050	0.1	3.865	229	75-125	4.091	0.0533	20	SO	

The following samples were analyzed in this batch: 20121752-01A 20121752-02A 20121752-03A

Note: See Qualifiers Page for a list of Qualifiers and their explanation.

Client: Geosyntec Consultants
 Work Order: 20121752
 Project: DTE- Belle River (GLP-8017)

QC BATCH REPORT

Batch ID: **169727** Instrument ID **TDS** Method: **A2540 C-11**

MBLK	Sample ID: MBLK-169727-169727				Units: mg/L		Analysis Date: 12/23/2020 02:50 PM			
Client ID:	Run ID: TDS_201223B			SeqNo: 7021476		Prep Date: 12/22/2020		DF: 1		
Analyte	Result	PQL	SPK Val	SPK Ref Value	%REC	Control Limit	RPD Ref Value	%RPD	RPD Limit	Qual

Total Dissolved Solids ND 30

LCS	Sample ID: LCS-169727-169727				Units: mg/L		Analysis Date: 12/23/2020 02:50 PM			
Client ID:	Run ID: TDS_201223B			SeqNo: 7021475		Prep Date: 12/22/2020		DF: 1		
Analyte	Result	PQL	SPK Val	SPK Ref Value	%REC	Control Limit	RPD Ref Value	%RPD	RPD Limit	Qual

Total Dissolved Solids 476 30 495 0 96.2 85-109 0

DUP	Sample ID: 20121752-03B DUP				Units: mg/L		Analysis Date: 12/23/2020 02:50 PM			
Client ID: DB	Run ID: TDS_201223B			SeqNo: 7021469		Prep Date: 12/22/2020		DF: 1		
Analyte	Result	PQL	SPK Val	SPK Ref Value	%REC	Control Limit	RPD Ref Value	%RPD	RPD Limit	Qual

Total Dissolved Solids 1940 300 0 0 0 0-0 2100 7.92 10

The following samples were analyzed in this batch: 20121752-01B 20121752-02B 20121752-03B

Note: See Qualifiers Page for a list of Qualifiers and their explanation.

Client: Geosyntec Consultants
 Work Order: 20121752
 Project: DTE- Belle River (GLP-8017)

QC BATCH REPORT

Batch ID: **R306910** Instrument ID **Titrator 1** Method: **A2320 B-11**

MBLK		Sample ID: MB-R306910-R306910				Units: mg/L		Analysis Date: 12/29/2020 11:55 AM		
Client ID:		Run ID: TITRATOR 1_201229A				SeqNo: 7033262		Prep Date:		DF: 1
Analyte	Result	PQL	SPK Val	SPK Ref Value	%REC	Control Limit	RPD Ref Value	%RPD	RPD Limit	Qual
Alkalinity, Bicarbonate (as CaCO3)	ND	10								
Alkalinity, Carbonate (as CaCO3)	ND	10								
Alkalinity, Hydroxide (as CaCO3)	ND	10								
Alkalinity, Phenolphthalein (as CaCO3)	ND	10								
Alkalinity, Total (as CaCO3)	ND	10								

LCS		Sample ID: LCS-R306910-R306910				Units: mg/L		Analysis Date: 12/29/2020 11:55 AM		
Client ID:		Run ID: TITRATOR 1_201229A				SeqNo: 7033263		Prep Date:		DF: 1
Analyte	Result	PQL	SPK Val	SPK Ref Value	%REC	Control Limit	RPD Ref Value	%RPD	RPD Limit	Qual
Alkalinity, Carbonate (as CaCO3)	923.7	10	925	0	99.9	88-110	0			
Alkalinity, Total (as CaCO3)	996.2	10	1000	0	99.6	89-103	0			

DUP		Sample ID: 20121803-01E DUP				Units: mg/L		Analysis Date: 12/29/2020 11:55 AM		
Client ID:		Run ID: TITRATOR 1_201229A				SeqNo: 7033273		Prep Date:		DF: 1
Analyte	Result	PQL	SPK Val	SPK Ref Value	%REC	Control Limit	RPD Ref Value	%RPD	RPD Limit	Qual
Alkalinity, Bicarbonate (as CaCO3)	219.1	10	0	0	0	0-0	224.9	2.6	10	
Alkalinity, Carbonate (as CaCO3)	ND	10	0	0	0	0-0	0	0	10	

DUP		Sample ID: 20121990-05A DUP				Units: mg/L		Analysis Date: 12/29/2020 11:55 AM		
Client ID:		Run ID: TITRATOR 1_201229A				SeqNo: 7033276		Prep Date:		DF: 1
Analyte	Result	PQL	SPK Val	SPK Ref Value	%REC	Control Limit	RPD Ref Value	%RPD	RPD Limit	Qual
Alkalinity, Total (as CaCO3)	66.2	10	0	0	0	0-0	62.95	5.03	10	

DUP		Sample ID: 20122120-08C DUP				Units: mg/L		Analysis Date: 12/29/2020 11:55 AM		
Client ID:		Run ID: TITRATOR 1_201229A				SeqNo: 7033278		Prep Date:		DF: 1
Analyte	Result	PQL	SPK Val	SPK Ref Value	%REC	Control Limit	RPD Ref Value	%RPD	RPD Limit	Qual
Alkalinity, Total (as CaCO3)	127.7	10	0	0	0	0-0	127.9	0.11	10	

The following samples were analyzed in this batch: 20121752-01B 20121752-02B 20121752-03B

Note: See Qualifiers Page for a list of Qualifiers and their explanation.

Client: Geosyntec Consultants
 Work Order: 20121752
 Project: DTE- Belle River (GLP-8017)

QC BATCH REPORT

Batch ID: **R306912** Instrument ID **Titrator 1** Method: **A4500-H B-11**

LCS		Sample ID: LCS-R306912-R306912				Units: s.u.		Analysis Date: 12/29/2020 11:55 AM			
Client ID:		Run ID: TITRATOR 1_201229B				SeqNo: 7033301		Prep Date:		DF: 1	
Analyte	Result	PQL	SPK Val	SPK Ref Value	%REC	Control Limit	RPD Ref Value	%RPD	RPD Limit	Qual	

pH (laboratory) 3.99 0.10 4 0 99.8 92-108 0

LCS		Sample ID: LCS-R306912-R306912				Units: s.u.		Analysis Date: 12/29/2020 11:55 AM			
Client ID:		Run ID: TITRATOR 1_201229B				SeqNo: 7033308		Prep Date:		DF: 1	
Analyte	Result	PQL	SPK Val	SPK Ref Value	%REC	Control Limit	RPD Ref Value	%RPD	RPD Limit	Qual	

pH (laboratory) 3.99 0.10 4 0 99.8 92-108 0

DUP		Sample ID: 20122120-08C DUP				Units: s.u.		Analysis Date: 12/29/2020 11:55 AM			
Client ID:		Run ID: TITRATOR 1_201229B				SeqNo: 7033305		Prep Date:		DF: 1	
Analyte	Result	PQL	SPK Val	SPK Ref Value	%REC	Control Limit	RPD Ref Value	%RPD	RPD Limit	Qual	

pH (laboratory) 8.05 0.10 0 0 0 0-0 7.99 0.748 5 H

Temperature 20.95 0.10 0 0 0 0-0 20.76 0.911 H

DUP		Sample ID: 20121990-05A DUP				Units: s.u.		Analysis Date: 12/29/2020 11:55 AM			
Client ID:		Run ID: TITRATOR 1_201229B				SeqNo: 7033315		Prep Date:		DF: 1	
Analyte	Result	PQL	SPK Val	SPK Ref Value	%REC	Control Limit	RPD Ref Value	%RPD	RPD Limit	Qual	

pH (laboratory) 7.51 0.10 0 0 0 0-0 7.56 0.664 5 H

Temperature 20.63 0.10 0 0 0 0 19.96 3.3 H

The following samples were analyzed in this batch:

20121752-01B	20121752-02B	20121752-03B
--------------	--------------	--------------

Note: See Qualifiers Page for a list of Qualifiers and their explanation.

Client: Geosyntec Consultants
 Work Order: 20121752
 Project: DTE- Belle River (GLP-8017)

QC BATCH REPORT

Batch ID: **R307142** Instrument ID **IC3** Method: **SW9056A**

MBLK		Sample ID: MBLK-R307142				Units: mg/L		Analysis Date: 12/30/2020 04:56 PM			
Client ID:		Run ID: IC3_201230A				SeqNo: 7043048		Prep Date:		DF: 1	
Analyte	Result	PQL	SPK Val	SPK Ref Value	%REC	Control Limit	RPD Ref Value	%RPD	RPD Limit	Qual	
Chloride	ND	1.0									
Fluoride	ND	0.10									

LCS		Sample ID: LCS-R307142				Units: mg/L		Analysis Date: 12/30/2020 05:15 PM			
Client ID:		Run ID: IC3_201230A				SeqNo: 7043049		Prep Date:		DF: 1	
Analyte	Result	PQL	SPK Val	SPK Ref Value	%REC	Control Limit	RPD Ref Value	%RPD	RPD Limit	Qual	
Chloride	9.321	1.0	10	0	93.2	88-110	0				
Fluoride	2.135	0.10	2	0	107	82-116	0				

MS		Sample ID: 20122223-01D MS				Units: mg/L		Analysis Date: 12/31/2020			
Client ID:		Run ID: IC3_201230A				SeqNo: 7043070		Prep Date:		DF: 40	
Analyte	Result	PQL	SPK Val	SPK Ref Value	%REC	Control Limit	RPD Ref Value	%RPD	RPD Limit	Qual	
Chloride	405	40	400	28.42	94.1	88-110	0				
Fluoride	84.26	4.0	80	0	105	82-116	0				

MSD		Sample ID: 20122223-01D MSD				Units: mg/L		Analysis Date: 12/31/2020 12:19 AM			
Client ID:		Run ID: IC3_201230A				SeqNo: 7043071		Prep Date:		DF: 40	
Analyte	Result	PQL	SPK Val	SPK Ref Value	%REC	Control Limit	RPD Ref Value	%RPD	RPD Limit	Qual	
Chloride	406.1	40	400	28.42	94.4	88-110	405	0.286	20		
Fluoride	83.74	4.0	80	0	105	82-116	84.26	0.614	20		

The following samples were analyzed in this batch: 20121752-01B 20121752-02B 20121752-03B

Note: See Qualifiers Page for a list of Qualifiers and their explanation.

Client: Geosyntec Consultants
 Work Order: 20121752
 Project: DTE- Belle River (GLP-8017)

QC BATCH REPORT

Batch ID: **R307145** Instrument ID **IC4** Method: **SW9056A**

MBLK		Sample ID: MBLK-R307145				Units: mg/L		Analysis Date: 12/30/2020 01:43 PM			
Client ID:		Run ID: IC4_201230A				SeqNo: 7043217		Prep Date:		DF: 1	
Analyte	Result	PQL	SPK Val	SPK Ref Value	%REC	Control Limit	RPD Ref Value	%RPD	RPD Limit	Qual	
Chloride	ND	1.0									
Sulfate	ND	1.0									

LCS		Sample ID: LCS-R307145				Units: mg/L		Analysis Date: 12/30/2020 02:39 PM			
Client ID:		Run ID: IC4_201230A				SeqNo: 7043218		Prep Date:		DF: 1	
Analyte	Result	PQL	SPK Val	SPK Ref Value	%REC	Control Limit	RPD Ref Value	%RPD	RPD Limit	Qual	
Chloride	9.353	1.0	10	0	93.5	88-110	0				
Sulfate	9.647	1.0	10	0	96.5	90-110	0				

MS		Sample ID: 20121752-03B MS				Units: mg/L		Analysis Date: 12/30/2020 07:14 PM			
Client ID: DB		Run ID: IC4_201230A				SeqNo: 7043233		Prep Date:		DF: 20	
Analyte	Result	PQL	SPK Val	SPK Ref Value	%REC	Control Limit	RPD Ref Value	%RPD	RPD Limit	Qual	
Chloride	228.2	20	200	42.57	92.8	88-110	0				
Sulfate	1470	20	200	1251	109	90-110	0			EO	

MSD		Sample ID: 20121752-03B MSD				Units: mg/L		Analysis Date: 12/30/2020 07:34 PM			
Client ID: DB		Run ID: IC4_201230A				SeqNo: 7043234		Prep Date:		DF: 20	
Analyte	Result	PQL	SPK Val	SPK Ref Value	%REC	Control Limit	RPD Ref Value	%RPD	RPD Limit	Qual	
Chloride	229.3	20	200	42.57	93.4	88-110	228.2	0.476	20		
Sulfate	1480	20	200	1251	114	90-110	1470	0.669	20	SEO	

The following samples were analyzed in this batch:

20121752-01B	20121752-02B	20121752-03B
--------------	--------------	--------------

Note: See Qualifiers Page for a list of Qualifiers and their explanation.

Client: Geosyntec Consultants
 Work Order: 20121752
 Project: DTE- Belle River (GLP-8017)

QC BATCH REPORT

Batch ID: **R307276** Instrument ID **IC3** Method: **SW9056A**

MBLK		Sample ID: MBLK-R307276				Units: mg/L		Analysis Date: 12/31/2020 01:42 PM			
Client ID:		Run ID: IC3_201231A				SeqNo: 7047811		Prep Date:		DF: 1	
Analyte	Result	PQL	SPK Val	SPK Ref Value	%REC	Control Limit	RPD Ref Value	%RPD	RPD Limit	Qual	
Sulfate	ND	1.0									

LCS		Sample ID: LCS-R307276				Units: mg/L		Analysis Date: 12/31/2020 02:01 PM			
Client ID:		Run ID: IC3_201231A				SeqNo: 7047812		Prep Date:		DF: 1	
Analyte	Result	PQL	SPK Val	SPK Ref Value	%REC	Control Limit	RPD Ref Value	%RPD	RPD Limit	Qual	
Sulfate	9.654	1.0	10	0	96.5	90-110	0				

MS		Sample ID: 20122530-06A MS				Units: mg/L		Analysis Date: 12/31/2020 06:35 PM			
Client ID:		Run ID: IC3_201231A				SeqNo: 7047826		Prep Date:		DF: 40	
Analyte	Result	PQL	SPK Val	SPK Ref Value	%REC	Control Limit	RPD Ref Value	%RPD	RPD Limit	Qual	
Sulfate	424.4	40	400	43.11	95.3	90-110	0				

MSD		Sample ID: 20122530-06A MSD				Units: mg/L		Analysis Date: 12/31/2020 06:54 PM			
Client ID:		Run ID: IC3_201231A				SeqNo: 7047827		Prep Date:		DF: 40	
Analyte	Result	PQL	SPK Val	SPK Ref Value	%REC	Control Limit	RPD Ref Value	%RPD	RPD Limit	Qual	
Sulfate	425.5	40	400	43.11	95.6	90-110	424.4	0.255	20		

The following samples were analyzed in this batch:

20121752-01B	20121752-03B
--------------	--------------

Note: See Qualifiers Page for a list of Qualifiers and their explanation.



Chain of Custody Form

Page 1 of 1

ALS Environmental
 3352 128th Avenue
 Holland, Michigan 49424
 (Tel) 616.399.6070
 (Fax) 616.399.6185

20121752

Customer Information			Project Information				Parameter/Method Request for Analysis										
Purchase Order		Project Name	DTE Belle River		A	Metals											
Work Order		Project Number	GLP 8017		B	pH, Anions, TDS, Alkalinity											
Company Name	Geosyntec Consultants	Bill To Company	Geosyntec Consultants		C												
Send Report To	Michael Coram	Invoice Attn.	Michael Coram		D												
Address	2100 Commonwealth Blvd.	Address	2100 Commonwealth Blvd.		E												
	Suite 100		Suite 100		F												
City/State/Zip	Ann Arbor, MI 48105	City/State/Zip	Ann Arbor, MI 48105		G												
Phone	734-794-1547	Phone	734-794-1547		H												
Fax	734-332-8063	Fax	734-332-8063		I												
e-Mail Address					J												
No.	Sample Description	Date	Time	Matrix	Pres. Key Numbers	# Bottles	A	B	C	D	E	F	G	H	I	J	Hold
1	BAB-E	12/16/2020	3:00	GW	2	2	x	x									
2	BAB-W	12/16/2020	2:00	GW	2	2	x	x									
3	DB	12/16/2020	4:00	GW	2	2	x	x									
4																	
5																	
6																	
7																	
8																	
9																	
10																	
11																	
12																	
13																	
14																	
15																	
16																	
Sampler(s): Please Print & Sign <i>Mike Coram</i>		Shipment Method: Carrier <i>FedEx</i>		Turnaround Time: (Business Days) <input checked="" type="checkbox"/> 10 BD <input type="checkbox"/> 5 BD <input type="checkbox"/> 3 BD <input type="checkbox"/> 2 BD <input type="checkbox"/> 1 BD <input type="checkbox"/> Other _____				Results Due Date:									
Relinquished by: <i>[Signature]</i>	Date: 12/17	Time: 3:00	Received by:		Date:	Time:	Notes: Separate Report										
Relinquished by: <i>Fedex</i>	Date: 12/18/20	Time: 10:00	Received by (Laboratory): <i>[Signature]</i>		Date:	Time:	ALS Cooler ID	Cooler Temp	QC Package: (Check Box Below)								
Logged by (Laboratory): <i>MTG</i>	Date: 12/18/20	Time: 13:46	Checked by (Laboratory): <i>[Signature]</i>					5.8°C	<input type="checkbox"/> Level II: Standard QC		<input type="checkbox"/> Level III: Raw Data						
								PA23	<input type="checkbox"/> TRRP LRC		<input type="checkbox"/> TRRP Level IV						
									<input type="checkbox"/> Level IV: SW846 Methods/CLP like		<input type="checkbox"/> Other: _____						

Preservative Key: 1-HCl 2-HNO₃ 3-H₂SO₄ 4-NaOH 5-Na₂S₂O₃ 6-NaHSO₄ 7-Other 8-4°C

Note: Any changes must be made in writing once samples and COC Form have been submitted to ALS.

Sample Receipt Checklist

Client Name: GEOSYNTEC - AA

Date/Time Received: 18-Dec-20 10:00

Work Order: 20121752

Received by: MJG

Checklist completed by Matthew Gaylord 18-Dec-20
eSignature Date

Reviewed by: Chad Whelton 18-Dec-20
eSignature Date

Matrices: Groundwater

Carrier name: FedEx

Shipping container/cooler in good condition? Yes No Not Present

Custody seals intact on shipping container/cooler? Yes No Not Present

Custody seals intact on sample bottles? Yes No Not Present

Chain of custody present? Yes No

Chain of custody signed when relinquished and received? Yes No

Chain of custody agrees with sample labels? Yes No

Samples in proper container/bottle? Yes No

Sample containers intact? Yes No

Sufficient sample volume for indicated test? Yes No

All samples received within holding time? Yes No

Container/Temp Blank temperature in compliance? Yes No

Sample(s) received on ice? Yes No

Temperature(s)/Thermometer(s): 5.8/5.8C IR1

Cooler(s)/Kit(s):

Date/Time sample(s) sent to storage: 12/18/2020 1:47:53 PM

Water - VOA vials have zero headspace? Yes No No VOA vials submitted

Water - pH acceptable upon receipt? Yes No N/A

pH adjusted? Yes No N/A

pH adjusted by:

Login Notes:

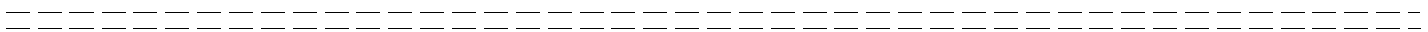

Client Contacted: Date Contacted: Person Contacted:

Contacted By: Regarding:

Comments:

CorrectiveAction:



Tuesday, January 19, 2021

Michael Coram
Geosyntec Consultants
2100 Commonwealth Blvd. Suite 100
Ann Arbor, MI 48105

Re: ALS Workorder: 2012397
Project Name: DTE - Belle River
Project Number: GLP-8017

Dear Mr. Coram:

Three water samples were received from Geosyntec Consultants, on 12/18/2020. The samples were scheduled for the following analyses:

Radium-226

Radium-228

The results for these analyses are contained in the enclosed reports.

The data contained in the following report have been reviewed and approved by the personnel listed below. In addition, ALS certifies that the analyses reported herein are true, complete and correct within the limits of the methods employed. Should this laboratory report need to be reproduced, it should be reproduced in full unless written approval has been obtained from ALS Environmental.

Thank you for your confidence in ALS Environmental. Should you have any questions, please call.

Sincerely,

ALS Environmental
Julie Ellingson
Project Manager

Accreditations: ALS Environmental – Fort Collins is accredited by the following accreditation bodies for various testing scopes in accordance with requirements of each accreditation body. All testing is performed under the laboratory management system, which is maintained to meet these requirement and regulations. Please contact the laboratory or accreditation body for the current scope testing parameters.

ALS Environmental – Fort Collins	
Accreditation Body	License or Certification Number
California (CA)	2926
Colorado (CO)	CO01099
Florida (FL)	E87914
Idaho (ID)	CO01099
Kansas (KS)	E-10381
Kentucky (KY)	90137
PJ-LA (DoD ELAP/ISO 170250)	95377
Maryland (MD)	285
Missouri (MO)	175
Nebraska(NE)	NE-OS-24-13
Nevada (NV)	CO010992018-1
New York (NY)	12036
North Dakota (ND)	R-057
Oklahoma (OK)	1301
Pennsylvania (PA)	68-03116
Tennessee (TN)	TN02976
Texas (TX)	T104704241
Utah (UT)	CO01099
Washington (WA)	C1280

40 CFR Part 136: All analyses for Clean Water Act samples are analyzed using the 40 CFR Part 136 specified method and include all the QC requirements.



2012397

Radium-228:

The samples were analyzed for the presence of ^{228}Ra by low background gas flow proportional counting of ^{228}Ac , which is the ingrown progeny of ^{228}Ra , according to the current revision of SOP 724.

All remaining acceptance criteria were met.

Radium-226:

The samples were prepared and analyzed according to the current revision of SOP 783.

Sample 2012397-2 has a calculated yield as determined by ICP-AES above the 110% control limit at 132%. It is believed that there was native barium present in the sediment portion of the sample that was unaccounted for in the initial ICP aliquot. The result has been calculated conservatively, assuming a quantitative yield of 100%. This sample is identified with a "Y2" flag in the final reports, and the results are submitted without further qualification.

All remaining acceptance criteria were met.

ALS -- Fort Collins

Sample Number(s) Cross-Reference Table

OrderNum: 2012397

Client Name: Geosyntec Consultants

Client Project Name: DTE - Belle River

Client Project Number: GLP-8017

Client PO Number:

Client Sample Number	Lab Sample Number	COC Number	Matrix	Date Collected	Time Collected
BAB-E	2012397-1		WATER	16-Dec-20	15:00
BAB-W	2012397-2		WATER	16-Dec-20	14:00
DB	2012397-3		WATER	16-Dec-20	16:00



Cincinnati, OH
+1 513 733 5336
Everett, WA
+1 425 356 2600

Fort Collins, CO
+1 970 490 1511
Holland, MI
+1 616 399 6070

Houston, TX
+1 281 530 5656
Middletown, PA
+1 717 944 5541
Spring City, PA
+1 610 948 4903
Salt Lake City, UT
+1 801 266 7700
South Charleston, WV
+1 304 356 3168
York, PA
+1 717 505 5280

Page 1 of 1
COC ID: 230240
ALS Work Order #: 33730

Parameter/Method Request for Analysis
Radium 226 and 228 combined

ALS Project Manager: *Report Separate*

Purchase Order	Project Name	Project Information
Work Order	<i>DTE - Belle River</i>	
Company Name	Project Number	
Send Report To	<i>GP-8017</i>	
Address	Bill To Company	
City/State/Zip	Invoice Attn	
Phone	Address	
Fax	City/State/Zip	
e-Mail Address	Phone	
	Fax	
	e-Mail Address	

No.	Sample Description	Date	Time	Matrix	Pres.	# Bottles	A	B	C	D	E	F	G	H	I	J	Hold
1	<i>BAB-F</i>	<i>12/16</i>	<i>3:00</i>	<i>SW</i>	<i>2</i>	<i>2</i>	X										
2	<i>BAB-W</i>	<i>12/16</i>	<i>2:00</i>	<i>SW</i>	<i>2</i>	<i>2</i>	X										
3	<i>DB</i>	<i>12/16</i>	<i>4:00</i>	<i>SW</i>	<i>2</i>	<i>2</i>	X										
4																	
5																	
6																	
7																	
8																	
9																	
10																	

Sampler(s) Please Print & Sign
Mike Coram

Shipment Method
Fed Ex

Required Turnaround Time: (Check Box)
 5 WK Days
 Std. 10 WK Days
 2 WK Days
 24 Hour

Results Due Date:

Relinquished by: *MC* **Date:** *12/17* **Time:** *3:00*

Received by (Laboratory): *MC* **Date:** *12/17* **Time:** *3:00*

Checked by (Laboratory):

QC Package: (Check One Box Below)
 Level III Std. CC
 Level III Std. CC/Pres. Data
 Level IV SW/826-CLP
 Other

Preservative Key: 1-HCl 2-HNO₃ 3-H₂SO₄ 4-NaOH 5-Na₂S₂O₃ 6-NaHSO₄ 7-Other 8-4°C 9-5035

Note: 1. Any changes must be made in writing once samples and COC Form have been submitted to ALS Environmental.
 2. Unless otherwise agreed in a formal contract, services provided by ALS Environmental are expressly limited to the terms and conditions stated on the reverse.
 3. The Chain of Custody is a legal document. All information must be completed accurately.



ALS Environmental - Fort Collins
CONDITION OF SAMPLE UPON RECEIPT FORM

Client Name/ID:

Geosyntec MI

Workorder No:

2012397

Project Manager:

Initials:

RGA

Date: 12/18/2020

1. Are airbills / shipping documents present and/or removable?	<input type="checkbox"/> Drop Off	<input checked="" type="checkbox"/> YES	<input type="checkbox"/> NO
2. Are custody seals on shipping containers intact?	<input type="checkbox"/> NONE	<input checked="" type="checkbox"/> YES	<input type="checkbox"/> NO*
3. Are custody seals on sample containers intact?	<input checked="" type="checkbox"/> NONE	<input type="checkbox"/> YES	<input type="checkbox"/> NO*
4. Is there a COC (chain-of-custody) present?		<input checked="" type="checkbox"/> YES	<input type="checkbox"/> NO*
5. Is the COC in agreement with samples received? (IDs, dates, times, # of samples, # of containers, matrix, requested analyses, etc.)		<input checked="" type="checkbox"/> YES	<input type="checkbox"/> NO*
6. Are short-hold samples present?		<input type="checkbox"/> YES	<input checked="" type="checkbox"/> NO
7. Are all samples within holding times for the requested analyses?		<input checked="" type="checkbox"/> YES	<input type="checkbox"/> NO*
8. Were all sample containers received intact? (not broken or leaking)		<input checked="" type="checkbox"/> YES	<input type="checkbox"/> NO*
9. Is there sufficient sample for the requested analyses?		<input checked="" type="checkbox"/> YES	<input type="checkbox"/> NO*
10. Are samples in proper containers for requested analyses? (form 250, Sample Handling Guidelines)		<input checked="" type="checkbox"/> YES	<input type="checkbox"/> NO*
11. Are all aqueous samples preserved correctly, if required?	<input type="checkbox"/> N/A	<input type="checkbox"/> YES	<input checked="" type="checkbox"/> NO*
12. Were unpreserved samples pH checked, if required?	<input checked="" type="checkbox"/> N/A	<input type="checkbox"/> YES	<input type="checkbox"/> NO
13. Are all samples requiring no headspace (VOC, GRO, RSK/MEE, radon) free of bubbles > 6 mm in diameter?	<input checked="" type="checkbox"/> N/A	<input type="checkbox"/> YES	<input type="checkbox"/> NO
14. Were the samples shipped on ice?		<input checked="" type="checkbox"/> YES	<input type="checkbox"/> NO
15. Were cooler temperatures measured at 0.1 - 6.0°C?	IR gun used: <input type="checkbox"/> #3 <input checked="" type="checkbox"/> #5	<input type="checkbox"/> Rad Only	<input checked="" type="checkbox"/> YES <input type="checkbox"/> NO

Cooler #: 1

Temperature (°C): 3.2

of custody seals on cooler: 1

External mR/hr reading: 12

Background mR/hr reading: 9

Were external mR/hr readings ≤ two times background and within DOT acceptance criteria? (If no, see Form 008)

N/A YES NO

* Please provide details below for 'NO' responses in gray boxes above - for 2 thru 5 & 7 thru 12, notify PM & continue w/ login.

11) Sample 2012397-1-2 had a pH of 4, 0.5mL of HNO3 was added to achieve a pH<2

All client bottle ID's vs ALS lab ID's double-checked by: RGA

If applicable, was the client contacted? YES N/A

Contact Name

Date:

Project Manager Signature / Date:

RGA 12/21/20

ORIGIN ID:DEDA (248) 390-5748
MIKE CORAM

SUITE 100
2100 COMMONWEALTH BLVD STE 100
ANN ARBOR, MI 48105
UNITED STATES US

SHIP DATE: 17DEC20
ACTWTG: 56.90 LB
CAD: 6997566/SSFO2121
DIMS: 25x14x13 IN

BILL THIRD PARTY

Part # 159297-355 RHD8 Exp 11/21

TO **ALS FT. COLLINS**
ATTN: SAMPLE RECEIVING
225 COMMERCE DR

12-1
3.2

FORT COLLINS CO 80524

(616) 682-5201

REF:

THU:

DEPT:

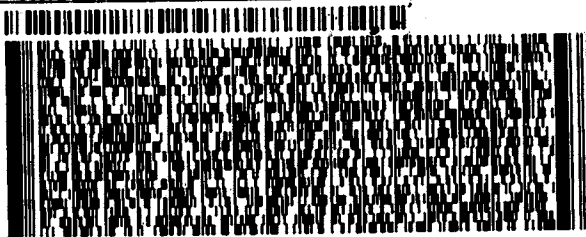

FedEx
Express



14107-10002027

TRK# 7816 0264 9731
0201

FRI - 18 DEC 10:30A
PRIORITY OVERNIGHT

NA FTCA

DSR
80524
CO-US DEN

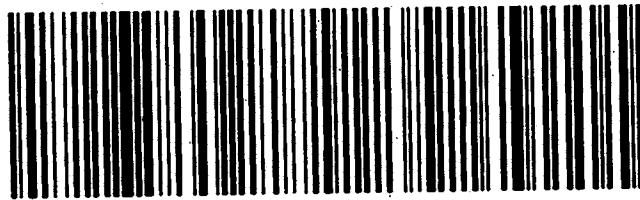

Client: Geosyntec Consultants
Project: GLP-8017 DTE - Belle River
Sample ID: BAB-E
Legal Location:
Collection Date: 12/16/2020 15:00

Date: 19-Jan-21
Work Order: 2012397
Lab ID: 2012397-1
Matrix: WATER
Percent Moisture:

Analyses	Result	Qual	Report Limit	Units	Dilution Factor	Date Analyzed
Radium-226 by Radon Emanation - Method 903.1						
			SOP 783		Prep Date: 1/4/2021	PrepBy: TRB
Ra-226	0.57 (+/- 0.35)	Y1	0.41	pCi/l	NA	1/12/2021 11:32
<i>Carr: BARIUM</i>	101	Y1	40-110	%REC	DL = NA	1/12/2021 11:32
Radium-228 Analysis by GFPC						
			SOP 724		Prep Date: 1/11/2021	PrepBy: RGS
COMBINED RADIUM (226+228)	1.49 (+/- 0)		0.78	pCi/l	NA	1/15/2021 07:48
Ra-228	0.92 (+/- 0.45)		0.78	pCi/l	NA	1/15/2021 07:48
<i>Carr: BARIUM</i>	99.2		40-110	%REC	DL = NA	1/15/2021 07:48

Client: Geosyntec Consultants
Project: GLP-8017 DTE - Belle River
Sample ID: BAB-W
Legal Location:
Collection Date: 12/16/2020 14:00

Date: 19-Jan-21
Work Order: 2012397
Lab ID: 2012397-2
Matrix: WATER
Percent Moisture:

Analyses	Result	Qual	Report Limit	Units	Dilution Factor	Date Analyzed
Radium-226 by Radon Emanation - Method 903.1						
			SOP 783		Prep Date: 1/4/2021	PrepBy: TRB
Ra-226	1.78 (+/- 0.66)	Y2	0.3	pCi/l	NA	1/12/2021 11:32
<i>Carr: BARIUM</i>	132	Y2	40-110	%REC	DL = NA	1/12/2021 11:32
Radium-228 Analysis by GFPC						
			SOP 724		Prep Date: 1/11/2021	PrepBy: RGS
COMBINED RADIUM (226+228)	1.78 (+/- 0)		1.32	pCi/l	NA	1/15/2021 07:48
Ra-228	ND (+/- 0.69)	U,M	1.32	pCi/l	NA	1/15/2021 07:48
<i>Carr: BARIUM</i>	57		40-110	%REC	DL = NA	1/15/2021 07:48

Client: Geosyntec Consultants
Project: GLP-8017 DTE - Belle River
Sample ID: DB
Legal Location:
Collection Date: 12/16/2020 16:00

Date: 19-Jan-21
Work Order: 2012397
Lab ID: 2012397-3
Matrix: WATER
Percent Moisture:

Analyses	Result	Qual	Report Limit	Units	Dilution Factor	Date Analyzed
Radium-226 by Radon Emanation - Method 903.1						
			SOP 783		Prep Date: 1/4/2021	PrepBy: TRB
Ra-226	ND (+/- 0.21)	U	0.3	pCi/l	NA	1/12/2021 11:32
Carr: BARIUM	95		40-110	%REC	DL = NA	1/12/2021 11:32
Radium-228 Analysis by GFPC						
			SOP 724		Prep Date: 1/11/2021	PrepBy: RGS
COMBINED RADIUM (226+228)	ND (+/- 0)	U	1.8	pCi/l	NA	1/15/2021 07:48
Ra-228	ND (+/- 0.83)	U,M	1.8	pCi/l	NA	1/15/2021 07:48
Carr: BARIUM	45		40-110	%REC	DL = NA	1/15/2021 07:48

Client: Geosyntec Consultants
Project: GLP-8017 DTE - Belle River
Sample ID: DB
Legal Location:
Collection Date: 12/16/2020 16:00

Date: 19-Jan-21
Work Order: 2012397
Lab ID: 2012397-3
Matrix: WATER
Percent Moisture:

Analyses	Result	Qual	Report Limit	Units	Dilution Factor	Date Analyzed
----------	--------	------	--------------	-------	-----------------	---------------

Explanation of Qualifiers

Radiochemistry:

- "Report Limit" is the MDC
- U or ND - Result is less than the sample specific MDC.
- Y1 - Chemical Yield is in control at 100-110%. Quantitative yield is assumed.
- Y2 - Chemical Yield outside default limits.
- W - DER is greater than Warning Limit of 1.42
- * - Aliquot Basis is 'As Received' while the Report Basis is 'Dry Weight'.
- # - Aliquot Basis is 'Dry Weight' while the Report Basis is 'As Received'.
- G - Sample density differs by more than 15% of LCS density.
- D - DER is greater than Control Limit
- M - Requested MDC not met.
- M3 - The requested MDC was not met, but the reported activity is greater than the reported MDC.
- L - LCS Recovery below lower control limit.
- H - LCS Recovery above upper control limit.
- P - LCS, Matrix Spike Recovery within control limits.
- N - Matrix Spike Recovery outside control limits
- NC - Not Calculated for duplicate results less than 5 times MDC
- B - Analyte concentration greater than MDC.
- B3 - Analyte concentration greater than MDC but less than Requested MDC.

Inorganics:

- B - Result is less than the requested reporting limit but greater than the instrument method detection limit (MDL).
- U or ND - Indicates that the compound was analyzed for but not detected.
- E - The reported value is estimated because of the presence of interference. An explanatory note may be included in the narrative.
- M - Duplicate injection precision was not met.
- N - Spiked sample recovery not within control limits. A post spike is analyzed for all ICP analyses when the matrix spike and or spike duplicate fail and the native sample concentration is less than four times the spike added concentration.
- Z - Spiked recovery not within control limits. An explanatory note may be included in the narrative.
- * - Duplicate analysis (relative percent difference) not within control limits.
- S - SAR value is estimated as one or more analytes used in the calculation were not detected above the detection limit.

Organics:

- U or ND - Indicates that the compound was analyzed for but not detected.
- B - Analyte is detected in the associated method blank as well as in the sample. It indicates probable blank contamination and warns the data user.
- E - Analyte concentration exceeds the upper level of the calibration range.
- J - Estimated value. The result is less than the reporting limit but greater than the instrument method detection limit (MDL).
- A - A tentatively identified compound is a suspected aldol-condensation product.
- X - The analyte was diluted below an accurate quantitation level.
- * - The spike recovery is equal to or outside the control criteria used.
- + - The relative percent difference (RPD) equals or exceeds the control criteria.
- G - A pattern resembling gasoline was detected in this sample.
- D - A pattern resembling diesel was detected in this sample.
- M - A pattern resembling motor oil was detected in this sample.
- C - A pattern resembling crude oil was detected in this sample.
- 4 - A pattern resembling JP-4 was detected in this sample.
- 5 - A pattern resembling JP-5 was detected in this sample.
- H - Indicates that the fuel pattern was in the heavier end of the retention time window for the analyte of interest.
- L - Indicates that the fuel pattern was in the lighter end of the retention time window for the analyte of interest.
- Z - This flag indicates that a significant fraction of the reported result did not resemble the patterns of any of the following petroleum hydrocarbon products:
 - gasoline
 - JP-8
 - diesel
 - mineral spirits
 - motor oil
 - Stoddard solvent
 - bunker C

ALS -- Fort Collins

Date: 1/19/2021 1:00:4

Client: Geosyntec Consultants

QC BATCH REPORT

Work Order: 2012397

Project: GLP-8017 DTE - Belle River

Batch ID: RE210104-1-3

Instrument ID: Alpha Scin

Method: Radium-226 by Radon Emanation

LCS		Sample ID: RE210104-1			Units: pCi/l		Analysis Date: 1/12/2021 12:16				
Client ID:		Run ID: RE210104-1A			Prep Date: 1/4/2021		DF: NA				
Analyte	Result	ReportLimit	SPK Val	SPK Ref Value	%REC	Control Limit	Decision Level	DER Ref Value	DER	DER Limit	Qual
Ra-226	46 (+/- 12)	0	46.8		98.8	67-120					P
Carr: BARIUM	15230		15490		98.3	40-110					

MB		Sample ID: RE210104-1			Units: pCi/l		Analysis Date: 1/12/2021 12:16				
Client ID:		Run ID: RE210104-1A			Prep Date: 1/4/2021		DF: NA				
Analyte	Result	ReportLimit	SPK Val	SPK Ref Value	%REC	Control Limit	Decision Level	DER Ref Value	DER	DER Limit	Qual
Ra-226	ND	0.31									U
Carr: BARIUM	15370		15490		99.2	40-110					

The following samples were analyzed in this batch:

2012397-1	2012397-2	2012397-3
-----------	-----------	-----------

Client: Geosyntec Consultants
 Work Order: 2012397
 Project: GLP-8017 DTE - Belle River

QC BATCH REPORT

Batch ID: RA210111-1-5 Instrument ID: GASPROP Method: Radium-228 Analysis by GFPC

LCS		Sample ID: RA210111-1		Units: ug			Analysis Date: 1/15/2021 07:48				
Client ID:		Run ID: RA210111-1A			Prep Date: 1/11/2021			DF: NA			
Analyte	Result	ReportLimit	SPK Val	SPK Ref Value	%REC	Control Limit	Decision Level	DER Ref Value	DER	DER Limit	Qual
Carr: BARIUM	34290		36030		95.2	40-110					
Ra-228	17.3 (+/- 4.1)	0.7	22.86		75.6	70-130					P

LCSD		Sample ID: RA210111-1		Units: ug			Analysis Date: 1/15/2021 07:48				
Client ID:		Run ID: RA210111-1A			Prep Date: 1/11/2021			DF: NA			
Analyte	Result	ReportLimit	SPK Val	SPK Ref Value	%REC	Control Limit	Decision Level	DER Ref Value	DER	DER Limit	Qual
Carr: BARIUM	33960		36030		94.2	40-110		34290			
Ra-228	22.7 (+/- 5.3)	0.7	22.86		99.3	70-130		17.3	0.81	2.13	P

MB		Sample ID: RA210111-1		Units: ug			Analysis Date: 1/15/2021 07:48				
Client ID:		Run ID: RA210111-1A			Prep Date: 1/11/2021			DF: NA			
Analyte	Result	ReportLimit	SPK Val	SPK Ref Value	%REC	Control Limit	Decision Level	DER Ref Value	DER	DER Limit	Qual
Carr: BARIUM	34280		36150		94.8	40-110					
Ra-228	ND	0.77									U

The following samples were analyzed in this batch: 2012397-1 2012397-2 2012397-3

**APPENDIX K – ALD HYDRAULIC
CONDUCTIVITY TEST RESULTS**



Excel Geotechnical Testing, Inc.
"Excellence in Testing"

953 Forrest Street, Roswell, Georgia 30075
 Tel: (770) 910 7537, www.excelgeotesting.com

Test Results Summary (Page 1)

Compatibility Test Results

Project Name: Belle River ALD Support

Project No.: PN1017

Site ID	Lab No.	Test Information												Remarks
		Initial Conditions		Final Conditions		Date	Number of Days After Injection	Permeability	Pore Volumes Passed After Injection	pH		Electrical Conductivity		
		Moisture Content	Dry Unit Weight	Moisture Content	Dry Unit Weight					In Flow	Out Flow	In Flow	Out Flow	
(-)	(-)	(%)	(pcf)	(%)	(pcf)	(-)	(-)	(cm/s)	(-)	(-)	(-)	(-)	(µs/cm)	(µs/cm)
B1-ST-1 (7-9')	20L143	26.7	98.1	28.7	96.6	3/15/2021	0	1.2E-08	0.0000	-	-	-	-	
						3/22/2021	7	9.3E-09	0.0417	-	-	-	-	
						3/29/2021	14	7.3E-09	0.0681	8.3	8.4	-	-	
						4/05/2021	21	7.0E-09	0.1077	-	-	-	-	
						4/12/2021	28	7.1E-09	0.1345	-	-	-	-	
						4/14/2021	30	6.9E-09	0.1408	8.2	8.5	-	-	
						4/19/2021	35	7.8E-09	0.1725	-	-	-	-	
						4/26/2021	42	6.4E-09	0.2022	-	-	-	-	
						4/27/2021	43	6.9E-09	0.2059	8.2	8.4	656	1614	
						5/3/2021	49	7.7E-09	0.2434	-	-	-	-	
						5/04/2021	50	7.8E-09	0.2487	-	-	-	-	
						5/07/2021	53	7.7E-09	0.2619	-	-	-	-	
						5/10/2021	56	6.9E-09	0.2728	8.3	8.2	-	-	
						5/14/2021	60	8.1E-09	0.2987	-	-	-	-	
						5/21/2021	67	7.2E-09	0.3323	-	-	-	-	
						5/24/2021	70	6.9E-09	0.3423	8.5	8.6	-	-	
						5/28/2021	74	8.1E-09	0.3684	-	-	-	-	
						6/04/2021	81	7.0E-09	0.4006	8.4	8.6	660	1411	
6/11/2021	88	7.6E-09	0.4404	-	-	-	-							
6/17/2021	94	6.5E-09	0.4634	8.3	8.2	-	-							
6/18/2021	95	7.3E-09	0.4729	-	-	-	-							
6/25/2021	102	7.6E-09	0.5139	-	-	-	-							
7/01/2021	108	6.4E-09	0.5375	8.5	8.2	-	-							

Notes: 1- Based on Specimen Final Conditions. 2- Based on average of four readings.

3-29-2023
 Approved By: NSR



Excel Geotechnical Testing, Inc.
 "Excellence in Testing"

953 Forrest Street, Roswell, Georgia 30075
 Tel: (770) 910 7537, www.excelgeotesting.com

Test Results Summary (Page 2)

Compatibility Test Results

Project Name: Belle River ALD Support

Project No.: PN1017

Site ID	Lab No.	Test Information												Remarks
		Initial Conditions		Final Conditions		Date	Number of Days After Injection	Permeability	Pore Volumes Passed After Injection	pH		Electrical Conductivity		
		Moisture Content	Dry Unit Weight	Moisture Content	Dry Unit Weight					In Flow	Out Flow	In Flow	Out Flow	
(-)	(-)	(%)	(pcf)	(%)	(pcf)	(-)	(-)	(cm/s)	(-)	(-)	(-)	(-)	(µs/cm)	(µs/cm)
B1-ST-1 (7-9')	20L143	26.7	98.1	28.7	96.6	7/02/2021	109	7.6E-09	0.5460	-	-	-	-	
						7/09/2021	116	7.0E-09	0.5870	-	-	-	-	
						7/16/2021	123	6.9E-09	0.6139	8.5	8.2	656	1230	
						7/23/2021	130	7.6E-09	0.6560	-	-	-	-	
						7/30/2021	137	7.0E-09	0.6827	8.6	8.5	-	-	
						8/06/2021	144	6.9E-09	0.7216	-	-	-	-	
						8/13/2021	151	6.8E-09	0.7489	8.5	8.1	-	-	
						8/20/2021	158	8.2E-09	0.7906	-	-	-	-	
						8/27/2021	165	6.0E-09	0.8165	-	-	-	-	
						8/30/2021	168	7.4E-09	0.8265	8.3	8.3	653	1141	
						9/03/2021	172	7.2E-09	0.8517	-	-	-	-	
						9/10/2021	179	6.5E-09	0.8827	-	-	-	-	
						9/14/2021	183	5.8E-09	0.8948	8.1	8.3	-	-	
						9/17/2021	186	6.9E-09	0.9131	-	-	-	-	
						9/24/2021	193	6.6E-09	0.9453	-	-	-	-	
						10/01/2021	200	5.7E-09	0.9663	-	-	-	-	
						10/04/2021	203	5.8E-09	0.9733	8.4	8.4	-	-	
						10/08/2021	207	7.2E-09	0.9990	-	-	-	-	
10/15/2021	214	6.3E-09	1.0291	-	-	-	-							
10/22/2021	221	5.5E-09	1.0485	8.2	8.3	622	1200							
10/29/2021	228	6.8E-09	1.0886	-	-	-	-							
11/05/2021	235	8.1E-09	1.1118	-	-	-	-							
11/12/2021	242	8.2E-09	1.1185	-	-	-	-							

3-29-2023
 Approved By: NSR

Notes: 1- Based on Specimen Initial Conditions. 2- Based on average of four readings.



Excel Geotechnical Testing, Inc.
 "Excellence in Testing"

953 Forrest Street, Roswell, Georgia 30075
 Tel: (770) 910 7537, www.excelgeotesting.com

Test Results Summary (Page 3)

Compatibility Test Results

Project Name: Belle River ALD Support

Project No.: PN1017

Site ID	Lab No.	Test Information												Remarks
		Initial Conditions		Final Conditions		Date	Number of Days After Injection	Permeability	Pore Volumes Passed After Injection	pH		Electrical Conductivity		
		Moisture Content	Dry Unit Weight	Moisture Content	Dry Unit Weight					In Flow	Out Flow	In Flow	Out Flow	
(-)	(-)	(%)	(pcf)	(%)	(pcf)	(-)	(-)	(cm/s)	(-)	(-)	(-)	(-)	(µs/cm)	(µs/cm)
B1-ST-1 (7-9')	20L143	26.7	98.1	28.7	96.6	11/19/2021	249	7.7E-09	1.1187	-	-	-	-	
						11/21/2021	251	8.0E-09	1.1178	8.0	8.3	-	-	
						11/26/2021	256	8.1E-09	1.1372	-	-	-	-	
						12/03/2021	263	7.9E-09	1.1516	-	-	-	-	
						12/10/2021	270	6.7E-09	1.1553	-	-	-	-	
						12/17/2021	277	7.5E-09	1.1541	-	-	-	-	
						12/21/2021	281	6.2E-09	1.1606	8.8	8.6	-	-	
						12/24/2021	284	6.7E-09	1.1782	-	-	-	-	
						12/31/2021	291	6.5E-09	1.2109	-	-	-	-	
						1/7/2022	298	5.7E-09	1.2333	8.8	8.8	719	1274	
						1/14/2022	305	6.3E-09	1.2688	-	-	-	-	
						1/21/2022	312	5.8E-09	1.2956	-	-	-	-	
						1/26/2022	317	4.9E-09	1.3070	8.0	8.2	-	-	
						1/28/2022	319	5.3E-09	1.3176	-	-	-	-	
						2/4/2022	326	6.0E-09	1.3494	-	-	-	-	
						2/11/2022	333	5.2E-09	1.3714	8.7	8.7	1091	-	
						2/18/2022	340	6.4E-09	1.4082	-	-	-	-	
						2/25/2022	347	6.3E-09	1.4346	8.9	9.0	964	1310	
3/4/2022	354	6.8E-09	1.4730	-	-	-	-							
3/11/2022	361	6.7E-09	1.5008	-	-	-	-							
3/14/2022	364	6.8E-09	1.5103	8.4	9.0	1220	-							
3/18/2022	368	6.9E-09	1.5337	-	-	-	-							
3/25/2022	375	6.8E-09	1.5649	-	-	-	-							

Notes: 1- Based on Specimen Initial Conditions. 2- Based on average of four readings.

3-29-2023
 Approved By: NSR



Excel Geotechnical Testing, Inc.
 "Excellence in Testing"

953 Forrest Street, Roswell, Georgia 30075
 Tel: (770) 910 7537, www.excelgeotesting.com

Test Results Summary (Page 4)

Compatibility Test Results

Project Name: Belle River ALD Support

Project No.: PN1017

Site ID	Lab No.	Test Information												Remarks
		Initial Conditions		Final Conditions		Date	Number of Days After Injection	Permeability	Pore Volumes Passed After Injection	pH		Electrical Conductivity		
		Moisture Content	Dry Unit Weight	Moisture Content	Dry Unit Weight					In Flow	Out Flow	In Flow	Out Flow	
(-)	(-)	(%)	(pcf)	(%)	(pcf)	(-)	(-)	(cm/s)	(-)	(-)	(-)	(-)	(µs/cm)	(µs/cm)
B1-ST-1 (7-9')	20L143	26.7	98.1	28.7	96.6	3/29/2022	379	6.4E-09	1.5786	9.1	9.1	1210	-	
						4/1/2022	382	7.2E-09	1.5978	-	-	-	-	
						4/8/2022	389	6.6E-09	1.6302	-	-	-	-	
						4/15/2022	396	6.1E-09	1.6525	8.3	8.3	1236	1256	
						4/22/2022	403	6.6E-09	1.6942	-	-	-	-	
						4/29/2022	410	6.3E-09	1.7236	-	-	-	-	
						5/2/2022	413	7.0E-09	1.7342	8.2	8.3	1257	-	
						5/6/2022	417	7.6E-09	1.7604	-	-	-	-	
						5/13/2022	424	7.1E-09	1.7937	-	-	-	-	
						5/17/2022	428	6.8E-09	1.8081	7.8	8.2	1252	-	
						5/20/2022	431	7.1E-09	1.8278	-	-	-	-	
						5/27/2022	438	7.1E-09	1.8623	-	-	-	-	
						6/1/2022	443	6.3E-09	1.8792	8.1	8.4	1254	-	
						6/3/2022	445	6.8E-09	1.8931	-	-	-	-	
						6/10/2022	452	7.0E-09	1.9301	-	-	-	-	
						6/16/2022	458	6.6E-09	1.9533	8.0	8.3	1294	-	
						6/17/2022	459	7.0E-09	1.9605	-	-	-	-	
						6/24/2022	466	7.1E-09	1.9994	-	-	-	-	
7/1/2022	473	7.0E-09	2.0260	8.3	8.3	1315	-							
7/8/2022	480	7.3E-09	2.0702	-	-	-	-							
7/15/2022	487	6.7E-09	2.0976	-	-	-	-							
7/18/2022	490	6.5E-09	2.1068	8.2	8.3	1257	1377							
7/22/2022	494	7.7E-09	2.1330	-	-	-	-							

3-29-2023
 Approved By: NSR

Notes: 1- Based on Specimen Initial Conditions. 2- Based on average of four readings.



Excel Geotechnical Testing, Inc.
 "Excellence in Testing"

953 Forrest Street, Roswell, Georgia 30075
 Tel: (770) 910 7537, www.excelgeotesting.com

Test Results Summary (Page 5)

Compatibility Test Results

Project Name: Belle River ALD Support

Project No.: PN1017

Site ID	Lab No.	Test Information												Remarks
		Initial Conditions		Final Conditions		Date	Number of Days After Injection	Permeability	Pore Volumes Passed After Injection	pH		Electrical Conductivity		
		Moisture Content	Dry Unit Weight	Moisture Content	Dry Unit Weight					In Flow	Out Flow	In Flow	Out Flow	
(-)	(-)	(%)	(pcf)	(%)	(pcf)	(-)	(-)	(cm/s)	(-)	(-)	(-)	(-)	(µs/cm)	(µs/cm)
B1-ST-1 (7-9')	20L143	26.7	98.1	28.7	96.6	7/29/2022	501	7.1E-09	2.1668	-	-	-	-	
						8/3/2022	506	6.3E-09	2.1828	8.1	8.3	1253	-	
						8/5/2022	508	7.3E-09	2.1974	-	-	-	-	
						8/12/2022	515	7.5E-09	2.2351	-	-	-	-	
						8/18/2022	521	6.3E-09	2.2562	9.1	8.3	1315	-	
						8/19/2022	522	6.6E-09	2.2629	-	-	-	-	
						8/26/2022	529	7.1E-09	2.3023	-	-	-	-	
						8/31/2022	534	6.7E-09	2.3224	7.9	8.2	1256	1233	
						9/2/2022	536	7.4E-09	2.3356	-	-	-	-	
						9/9/2022	543	6.8E-09	2.3720	-	-	-	-	
						9/15/2022	549	6.7E-09	2.3940	8.5	8.6	1309	-	
						9/16/2022	550	7.0E-09	2.4009	-	-	-	-	
						9/23/2022	557	7.0E-09	2.4393	-	-	-	-	
						9/30/2022	564	6.5E-09	2.4657	8.7	8.6	1253	-	
						10/7/2022	571	7.1E-09	2.5058	-	-	-	-	
						10/14/2022	578	7.0E-09	2.5343	8.5	8.3	1209	1197	
						10/21/2022	585	6.6E-09	2.5730	-	-	-	-	
						10/28/2022	592	6.3E-09	2.6010	-	-	-	-	
10/31/2022	595	5.9E-09	2.6098	8.5	8.3	1209	1197							
11/4/2022	599	7.3E-09	2.6346	-	-	-	-							
11/11/2022	606	6.9E-09	2.6681	-	-	-	-							
11/18/2022	613	6.1E-09	2.6945	-	-	-	-							
11/25/2022	620	6.0E-09	2.7244	-	-	-	-							

3-29-2023
 Approved By: NSR

Notes: 1- Based on Specimen Initial Conditions. 2- Based on average of four readings.



Excel Geotechnical Testing, Inc.
 "Excellence in Testing"

953 Forrest Street, Roswell, Georgia 30075
 Tel: (770) 910 7537, www.excelgeotesting.com

Test Results Summary (Page 6)

Compatibility Test Results

Project Name: Belle River ALD Support

Project No.: PN1017

Site ID	Lab No.	Test Information												Remarks
		Initial Conditions		Final Conditions		Date	Number of Days After Injection	Permeability	Pore Volumes Passed After Injection	pH		Electrical Conductivity		
		Moisture Content	Dry Unit Weight	Moisture Content	Dry Unit Weight					In Flow	Out Flow	In Flow	Out Flow	
(-)	(-)	(%)	(pcf)	(%)	(pcf)	(-)	(-)	(cm/s)	(-)	(-)	(-)	(-)	(µs/cm)	(µs/cm)
B1-ST-1 (7-9)	20L143	26.7	98.1	28.7	96.6	12/2/2022	627	5.0E-09	2.7459	-	-	-	-	
						12/5/2022	630	5.0E-09	2.7534	8.5	8.5	1242	1200	
						12/9/2022	634	6.5E-09	2.7749	-	-	-	-	
						12/16/2022	641	5.1E-09	2.8008	-	-	-	-	
						12/23/2022	648	4.4E-09	2.8182	-	-	-	-	
						12/31/2022	656	4.9E-09	2.8525	-	-	-	-	

3-29-2023
 Approved By: NSR

Notes: 1- Based on Specimen Initial Conditions. 2- Based on average of four readings.



Excel Geotechnical Testing, Inc.
 "Excellence in Testing"

953 Forrest Street, Roswell, Georgia 30075
 Tel: (770) 910 7537, www.excelgeotesting.com

Test Results Summary (Page 1)

Compatibility Test Results

Project Name: Belle River ALD Support

Project No.: PN1017

Site ID	Lab No.	Test Information												Remarks
		Initial Conditions		Final Conditions		Date	Number of Days After Injection	Permeability	Pore Volumes Passed After Injection	pH		Electrical Conductivity		
		Moisture Content	Dry Unit Weight	Moisture Content	Dry Unit Weight					In Flow	Out Flow	In Flow	Out Flow	
(-)	(-)	(%)	(pcf)	(%)	(pcf)	(-)	(-)	(cm/s)	(-)	(-)	(-)	(-)	(µs/cm)	(µs/cm)
B2-ST-1 (1-3)	20L149	20.4	105.7	26.0	101.6	3/15/2021	0	1.8E-08		-	-	-	-	
						3/22/2021	7	1.6E-08	0.0846	8.5	8.1	-	-	
						3/29/2021	14	1.3E-08	0.1548	-	-	-	-	
						3/30/2021	15	1.3E-08	0.1595	8.5	8.3	-	-	
						4/05/2021	21	1.4E-08	0.2036	-	-	-	-	
						4/09/2021	25	1.3E-08	0.2270	8.0	8.1	782	3050	
						4/12/2021	28	1.4E-08	0.2608	-	-	-	-	
						4/16/2021	32	1.3E-08	0.2939	8.2	8.5	-	-	
						4/19/2021	35	1.3E-08	0.3273	-	-	-	-	
						4/26/2021	42	1.1E-08	0.3737	8.0	7.9	-	-	
						5/03/2021	49	1.3E-08	0.4429	8.2	8.5	560	2300	
						5/07/2021	53	1.3E-08	0.4826	-	-	-	-	
						5/12/2021	58	1.2E-08	0.5197	8.1	8.3	-	-	
						5/14/2021	60	1.3E-08	0.5444	-	-	-	-	
						5/21/2021	67	1.2E-08	0.6038	8.3	8.1	-	-	
						5/28/2021	74	1.2E-08	0.6683	8.4	8.2	621	1790	
						6/04/2021	81	1.2E-08	0.7309	-	-	-	-	
						6/11/2021	88	1.2E-08	0.7967	-	-	-	-	
6/14/2021	91	1.1E-08	0.8129	8.3	8.2	-	-							
6/18/2021	95	1.2E-08	0.8553	-	-	-	-							
6/22/2021	99	1.1E-08	0.8823	8.3	8.1	595	1982							
6/25/2021	102	1.3E-08	0.9169	-	-	-	-							
7/01/2021	108	1.1E-08	0.9601	8.5	8.5	-	-							

Notes: 1- Based on Specimen Final Conditions. 2- Based on average of four readings.

3-29-2023
 Approved By: NSR



Excel Geotechnical Testing, Inc.
 "Excellence in Testing"

953 Forrest Street, Roswell, Georgia 30075
 Tel: (770) 910 7537, www.excelgeotesting.com

Test Results Summary (Page 2)

Compatibility Test Results

Project Name: Belle River ALD Support

Project No.: PN1017

Site ID	Lab No.	Test Information												Remarks
		Initial Conditions		Final Conditions		Date	Number of Days After Injection	Permeability	Pore Volumes Passed After Injection	pH		Electrical Conductivity		
		Moisture Content	Dry Unit Weight	Moisture Content	Dry Unit Weight					In Flow	Out Flow	In Flow	Out Flow	
(-)	(-)	(%)	(pcf)	(%)	(pcf)	(-)	(-)	(cm/s)	(-)	(-)	(-)	(-)	(µs/cm)	(µs/cm)
B2-ST-1 (1-3)	20L149	20.4	105.7	26.0	101.6	7/02/2021	109	1.1E-08	0.9719	-	-	-	-	
						7/09/2021	116	1.1E-08	1.0337	8.8	8.4	-	-	
						7/16/2021	123	1.2E-08	1.0975	8.7	8.1	657	1988	
						7/23/2021	130	1.2E-08	1.1654	8.3	8.4	-	-	
						7/30/2021	137	1.2E-08	1.2287	-	-	-	-	
						8/02/2021	140	1.1E-08	1.2452	8.7	8.1	-	-	
						8/06/2021	144	1.2E-08	1.2857	-	-	-	-	
						8/13/2021	151	1.1E-08	1.3313	8.2	8.1	652	1764	
						8/20/2021	158	1.2E-08	1.3978	-	-	-	-	
						8/23/2021	161	1.1E-08	1.4132	8.1	8.3	-	-	
						8/27/2021	165	1.2E-08	1.4535	-	-	-	-	
						8/31/2021	169	1.2E-08	1.4815	8.4	8.2	-	-	
						9/03/2021	172	1.2E-08	1.5143	-	-	-	-	
						9/08/2021	177	1.1E-08	1.5516	8.1	8.0	596	1523	
						9/10/2021	179	1.1E-08	1.5740	-	-	-	-	
						9/17/2021	186	9.8E-09	1.6213	-	-	-	-	
						9/20/2021	189	1.0E-08	1.6353	8.2	8.3	-	-	
						9/24/2021	193	1.2E-08	1.6763	-	-	-	-	
						10/01/2021	200	9.0E-09	1.7155	8.3	8.3	-	-	
10/08/2021	207	1.1E-08	1.7778	-	-	-	-							
10/12/2021	211	1.2E-08	1.7970	8.3	8.4	585	1524							
10/15/2021	214	1.1E-08	1.8259	-	-	-	-							
10/22/2021	221	9.4E-09	1.8672	8.5	8.3	-	-							

Notes: 1- Based on Specimen Initial Conditions. 2- Based on average of four readings.

3-29-2023
 Approved By: NSR



Excel Geotechnical Testing, Inc.
 "Excellence in Testing"

953 Forrest Street, Roswell, Georgia 30075
 Tel: (770) 910 7537, www.excelgeotesting.com

Test Results Summary (Page 3)

Compatibility Test Results

Project Name: Belle River ALD Support

Project No.: PN1017

Site ID	Lab No.	Test Information												Remarks
		Initial Conditions		Final Conditions		Date	Number of Days After Injection	Permeability	Pore Volumes Passed After Injection	pH		Electrical Conductivity		
		Moisture Content	Dry Unit Weight	Moisture Content	Dry Unit Weight					In Flow	Out Flow	In Flow	Out Flow	
(-)	(-)	(%)	(pcf)	(%)	(pcf)	(-)	(-)	(cm/s)	(-)	(-)	(-)	(-)	(µs/cm)	(µs/cm)
B2-ST-1 (1-3)	20L149	20.4	105.7	26.0	101.6	10/29/2021	228	1.1E-08	1.9280	-	-	-	-	
						11/01/2021	231	1.1E-08	1.9439	8.1	8.1	-	-	
						11/05/2021	235	1.2E-08	1.9864	-	-	-	-	
						11/12/2021	242	9.3E-09	2.0274	8.2	8.2	591	1510	
						11/19/2021	249	1.2E-08	2.0850	-	-	-	-	
						11/24/2021	254	9.8E-09	2.1108	8.2	8.1	-	-	
						11/26/2021	256	1.1E-08	2.1339	-	-	-	-	
						12/03/2021	263	1.0E-08	2.1827	-	-	-	-	
						12/08/2021	268	9.4E-09	2.2043	8.3	8.1	-	-	
						12/10/2021	270	9.9E-09	2.2227	-	-	-	-	
						12/14/2021	274	1.1E-08	2.2543	8.1	7.9	653	1120	
						12/17/2021	277	1.1E-08	2.2847	-	-	-	-	
						12/21/2021	281	1.1E-08	2.3157	8.5	8.3	-	-	
						12/24/2021	284	1.1E-08	2.3456	-	-	-	-	
						12/30/2021	290	1.1E-08	2.3880	8.3	8.2	-	-	
						12/31/2021	291	1.1E-08	2.3996	-	-	-	-	
						01/07/2022	298	1.0E-08	2.4543	8.7	8.2	609	1010	
						01/14/2022	305	1.1E-08	2.5129	-	-	-	-	
						1/18/2022	309	9.6E-09	2.5343	8.0	8.1	-	-	
						1/21/2022	312	1.0E-08	2.5652	-	-	-	-	
1/28/2022	319	9.0E-09	2.6069	8.3	8.5	-	-							
2/4/2022	326	1.0E-08	2.6650	-	-	-	-							
2/7/2022	329	9.8E-09	2.6820	8.5	8.7	-	-							

3-29-2023
 Approved By: NSR

Notes: 1- Based on Specimen Initial Conditions. 2- Based on average of four readings.



Excel Geotechnical Testing, Inc.
 "Excellence in Testing"

953 Forrest Street, Roswell, Georgia 30075
 Tel: (770) 910 7537, www.excelgeotesting.com

Test Results Summary (Page 4)

Compatibility Test Results

Project Name: Belle River ALD Support

Project No.: PN1017

Site ID	Lab No.	Test Information												Remarks
		Initial Conditions		Final Conditions		Date	Number of Days After Injection	Permeability	Pore Volumes Passed After Injection	pH		Electrical Conductivity		
		Moisture Content	Dry Unit Weight	Moisture Content	Dry Unit Weight					In Flow	Out Flow	In Flow	Out Flow	
(-)	(-)	(%)	(pcf)	(%)	(pcf)	(-)	(-)	(cm/s)	(-)	(-)	(-)	(-)	(µs/cm)	(µs/cm)
B2-ST-1 (1-3)	20L149	20.4	105.7	26.0	101.6	2/11/2022	333	1.0E-08	2.7173	-	-	-	-	
						2/17/2022	339	9.8E-09	2.7561	8.5	8.8	1213	-	
						2/18/2022	340	1.0E-08	2.7674	-	-	-	-	
						2/25/2022	347	1.1E-08	2.8240	8.9	9.1	1224	856	
						3/4/2022	354	1.1E-08	2.8832	-	-	-	-	
						3/7/2022	357	1.1E-08	2.9016	8.7	8.6	1226	-	
						3/11/2022	361	1.1E-08	2.9381	-	-	-	-	
						3/17/2022	367	9.7E-09	2.9759	8.9	8.8	1198	-	
						3/18/2022	368	1.0E-08	2.9860	-	-	-	-	
						3/25/2022	375	1.2E-08	3.0436	-	-	-	-	
						3/28/2022	378	1.1E-08	3.0694	8.3	8.5	1229	903	
						4/1/2022	382	1.1E-08	3.0983	-	-	-	-	
						4/7/2022	388	1.0E-08	3.1386	8.6	8.5	1238	-	
						4/8/2022	389	1.1E-08	3.1494	-	-	-	-	
						4/16/2022	397	1.1E-08	3.2061	7.8	8.0	1261	-	
						4/22/2022	403	9.9E-09	3.2603	-	-	-	-	
						4/27/2022	408	9.8E-09	3.2895	7.9	8.0	1237	972	
						4/29/2022	410	1.0E-08	3.3101	-	-	-	-	
						5/6/2022	417	1.1E-08	3.3638	-	-	-	-	
						5/7/2022	418	1.1E-08	3.3704	7.9	8.0	1345	-	
5/13/2022	424	1.1E-08	3.4264	-	-	-	-							
5/17/2022	428	1.1E-08	3.4517	7.8	8.0	1267	-							
5/20/2022	431	1.1E-08	3.4836	-	-	-	-							

3-29-2023
 Approved By: NSR

Notes: 1- Based on Specimen Initial Conditions. 2- Based on average of four readings.



Excel Geotechnical Testing, Inc.
 "Excellence in Testing"

953 Forrest Street, Roswell, Georgia 30075
 Tel: (770) 910 7537, www.excelgeotesting.com

Test Results Summary (Page 5)

Compatibility Test Results

Project Name: Belle River ALD Support

Project No.: PN1017

Site ID	Lab No.	Test Information												Remarks
		Initial Conditions		Final Conditions		Date	Number of Days After Injection	Permeability	Pore Volumes Passed After Injection	pH		Electrical Conductivity		
		Moisture Content	Dry Unit Weight	Moisture Content	Dry Unit Weight					In Flow	Out Flow	In Flow	Out Flow	
(-)	(-)	(%)	(pcf)	(%)	(pcf)	(-)	(-)	(cm/s)	(-)	(-)	(-)	(-)	(µs/cm)	(µs/cm)
B2-ST-1 (1-3)	20L149	20.4	105.7	26.0	101.6	5/26/2022	437	1.1E-08	3.5267	8.1	8.3	1262	942	
						5/27/2022	438	1.1E-08	3.5385	-	-	-	-	
						6/3/2022	445	1.1E-08	3.5964	-	-	-	-	
						6/6/2022	448	1.1E-08	3.6124	8.0	8.2	1304	-	
						6/10/2022	452	1.1E-08	3.6501	-	-	-	-	
						6/16/2022	458	1.1E-08	3.6906	7.9	8.0	1281	-	
						6/17/2022	459	1.1E-08	3.7017	-	-	-	-	
						6/24/2022	466	1.1E-08	3.7603	-	-	-	-	
						6/27/2022	469	9.9E-09	3.7753	8.2	8.3	1253	945	
						7/1/2022	473	1.2E-08	3.8170	-	-	-	-	
						7/6/2022	478	1.2E-08	3.8543	8.1	8.1	1245	-	
						7/8/2022	480	1.2E-08	3.8776	-	-	-	-	
						7/15/2022	487	1.1E-08	3.9311	8.0	8.0	1250	-	
						7/22/2022	494	1.2E-08	3.9951	-	-	-	-	
						7/25/2022	497	1.2E-08	4.0130	8.2	8.3	1191	1046	
						7/29/2022	501	1.2E-08	4.0552	-	-	-	-	
						8/3/2022	506	1.1E-08	4.0903	8.0	8.1	1259	-	
						8/5/2022	508	1.2E-08	4.1136	-	-	-	-	
8/12/2022	515	1.1E-08	4.1683	8.0	8.1	1271	-							
8/19/2022	522	1.1E-08	4.2329	-	-	-	-							
8/22/2022	525	1.1E-08	4.2503	8.1	8.2	1246	1109							
8/26/2022	529	1.2E-08	4.2918	-	-	-	-							
8/31/2022	534	1.1E-08	4.3273	8.2	8.2	1248	-							

3-29-2023
 Approved By: NSR

Notes: 1- Based on Specimen Initial Conditions. 2- Based on average of four readings.



Excel Geotechnical Testing, Inc.
 "Excellence in Testing"

953 Forrest Street, Roswell, Georgia 30075
 Tel: (770) 910 7537, www.excelgeotesting.com

Test Results Summary (Page 6)

Compatibility Test Results

Project Name: Belle River ALD Support

Project No.: PN1017

Site ID	Lab No.	Test Information												Remarks
		Initial Conditions		Final Conditions		Date	Number of Days After Injection	Permeability	Pore Volumes Passed After Injection	pH		Electrical Conductivity		
		Moisture Content	Dry Unit Weight	Moisture Content	Dry Unit Weight					In Flow	Out Flow	In Flow	Out Flow	
(-)	(-)	(%)	(pcf)	(%)	(pcf)	(-)	(-)	(cm/s)	(-)	(-)	(-)	(-)	(µs/cm)	(µs/cm)
B2-ST-1 (1-3)	20L149	20.4	105.7	26.0	101.6	9/2/2022	536	1.1E-08	4.3504	-	-	-	-	
						9/9/2022	543	1.1E-08	4.4039	8.5	8.4	1290	-	
						9/16/2022	550	1.2E-08	4.4677	-	-	-	-	
						9/20/2022	554	1.1E-08	4.4846	8.2	8.3	1264	1136	
						9/23/2022	557	1.2E-08	4.5256	-	-	-	-	
						9/28/2022	562	1.1E-08	4.5602	8.4	8.4	1140	-	
						9/30/2022	564	1.1E-08	4.5827	-	-	-	-	
						10/7/2022	571	1.1E-08	4.6360	8.0	8.1	1240	-	
						10/14/2022	578	1.1E-08	4.7000	8.3	8.3	1200	1101	
						10/21/2022	585	1.1E-08	4.7606	-	-	-	-	
						10/24/2022	588	1.1E-08	4.7785	8.4	8.2	1253	-	
						10/28/2022	592	1.1E-08	4.8193	-	-	-	-	
						11/3/2022	598	1.1E-08	4.8590	8.3	8.3	1207	-	
						11/4/2022	599	1.1E-08	4.8705	-	-	-	-	
						11/11/2022	606	1.1E-08	4.9299	8.5	8.4	1224	926	
						11/18/2022	613	9.7E-09	4.9876	-	-	-	-	
						11/23/2022	618	8.3E-09	5.0109	8.5	8.7	-	-	
						11/25/2022	620	9.8E-09	5.0305	-	-	-	-	
12/2/2022	627	8.9E-09	5.0759	-	-	-	-							
12/5/2022	630	8.8E-09	5.0894	8.4	8.5	1257	-							
12/9/2022	634	1.0E-08	5.1250	-	-	-	-							
12/16/2022	641	7.9E-09	5.1618	8.4	8.5	1190	894							
12/23/2022	648	8.8E-09	5.2138	-	-	-	-							

Notes: 1- Based on Specimen Initial Conditions. 2- Based on average of four readings.

2-29-2023
 Approved By: NSR



Excel Geotechnical Testing, Inc.
"Excellence in Testing"

953 Forrest Street, Roswell, Georgia 30075
 Tel: (770) 910 7537, www.excelgeotesting.com

Test Results Summary (Page 7)

Compatibility Test Results

Project Name: Belle River ALD Support

Project No.: PN1017

Site ID	Lab No.	Test Information												Remarks
		Initial Conditions		Final Conditions		Date	Number of Days After Injection	Permeability	Pore Volumes Passed After Injection	pH		Electrical Conductivity		
		Moisture Content	Dry Unit Weight	Moisture Content	Dry Unit Weight					In Flow	Out Flow	In Flow	Out Flow	
(-)	(-)	(%)	(pcf)	(%)	(pcf)	(-)	(-)	(cm/s)	(-)	(-)	(-)	(-)	(µs/cm)	(µs/cm)
B2-ST-1 (1-3)	20L149	20.4	105.7	26.0	101.6	12/31/2022	656	8.7E-09	5.2624	-	-	-	-	

Notes: 1- Based on Specimen Initial Conditions. 2- Based on average of four readings.

3-29-2023
 Approved By: NSR



Excel Geotechnical Testing, Inc.
"Excellence in Testing"

953 Forrest Street, Roswell, Georgia 30075
 Tel: (770) 910 7537, www.excelgeotesting.com

Test Results Summary (Page 1)

Compatibility Test Results

Project Name: Belle River ALD Support

Project No.: PN1017

Site ID	Lab No.	Test Information												Remarks
		Initial Conditions		Final Conditions		Date	Number of Days After Injection	Permeability	Pore Volumes Passed After Injection	pH		Electrical Conductivity		
		Moisture Content	Dry Unit Weight	Moisture Content	Dry Unit Weight					In Flow	Out Flow	In Flow	Out Flow	
(-)	(-)	(%)	(pcf)	(%)	(pcf)	(-)	(-)	(cm/s)	(-)	(-)	(-)	(-)	(µs/cm)	(µs/cm)
B2-ST-4 (47-49')	20L152	36.6	84.2	39.0	83.2	3/15/2021	0	2.4E-08	0.0000	-	-	-	-	
						3/22/2021	7	1.9E-08	0.0762	8.2	8.0	-	-	
						3/29/2021	14	2.0E-08	0.1547	8.2	8.1	-	-	
						4/05/2021	21	1.8E-08	0.2164	8.1	8.2	523	1271	
						4/12/2021	28	2.0E-08	0.2904	-	-	-	-	
						4/13/2021	29	2.0E-08	0.2961	8.3	8.3	-	-	
						4/19/2021	35	2.0E-08	0.3672	8.2	8.1	-	-	
						4/26/2021	42	1.9E-08	0.4413	8.1	8.0	578	1313	
						4/30/2021	46	2.1E-08	0.4969	8.4	8.1	-	-	
						5/05/2021	51	2.1E-08	0.5617	8.4	8.2	-	-	
						5/07/2021	53	2.0E-08	0.5909	-	-	-	-	
						5/10/2021	56	1.9E-08	0.6224	8.3	8.0	607	1081	
						5/14/2021	60	2.1E-08	0.6759	-	-	-	-	
						5/19/2021	65	2.0E-08	0.7406	8.0	8.2	-	-	
						5/21/2021	67	2.1E-08	0.7738	-	-	-	-	
						5/24/2021	70	2.1E-08	0.8050	8.2	8.2	666	1197	
						5/28/2021	74	2.1E-08	0.8595	8.3	8.1	-	-	
						6/02/2021	79	2.0E-08	0.9233	8.2	8.2	-	-	
6/04/2021	81	2.1E-08	0.9549	-	-	-	-							
6/07/2021	84	2.1E-08	0.9865	8.6	8.3	598	1074							
6/11/2021	88	2.2E-08	1.0419	8.4	8.1	-	-							
6/16/2021	93	2.1E-08	1.1071	8.4	8.0	-	-							
6/18/2021	95	2.1E-08	1.1396	-	-	-	-							

Notes: 1- Based on Specimen Final Conditions. 2- Based on average of four readings.

3-29-2023
 Approved By: NSR



Excel Geotechnical Testing, Inc.
 "Excellence in Testing"

953 Forrest Street, Roswell, Georgia 30075
 Tel: (770) 910 7537, www.excelgeotesting.com

Test Results Summary (Page 2)

Compatibility Test Results

Project Name: Belle River ALD Support

Project No.: PN1017

Site ID	Lab No.	Test Information												Remarks
		Initial Conditions		Final Conditions		Date	Number of Days After Injection	Permeability	Pore Volumes Passed After Injection	pH		Electrical Conductivity		
		Moisture Content	Dry Unit Weight	Moisture Content	Dry Unit Weight					In Flow	Out Flow	In Flow	Out Flow	
(-)	(-)	(%)	(pcf)	(%)	(pcf)	(-)	(-)	(cm/s)	(-)	(-)	(-)	(-)	(µs/cm)	(µs/cm)
B2-ST-4 (47-49')	20L152	36.6	84.2	39.0	83.2	6/21/2021	98	2.0E-08	1.1710	8.4	8.2	665	944	
						6/25/2021	102	2.2E-08	1.2298	-	-	-	-	
						6/29/2021	106	2.1E-08	1.2848	8.6	8.4	-	-	
						7/02/2021	109	1.9E-08	1.3242	8.6	8.1	618	1000	
						7/07/2021	114	2.0E-08	1.3932	8.1	8.1	-	-	
						7/09/2021	116	1.9E-08	1.4223	-	-	-	-	
						7/13/2021	120	2.0E-08	1.4630	8.3	8.4	-	-	
						7/16/2021	123	2.1E-08	1.5068	-	-	-	-	
						7/19/2021	126	2.0E-08	1.5349	8.2	8.4	612	974	
						7/23/2021	130	2.1E-08	1.5898	8.2	8.1	-	-	
						7/29/2021	136	2.0E-08	1.6629	8.2	8.1	-	-	
						7/30/2021	137	2.1E-08	1.6798	-	-	-	-	
						8/04/2021	142	1.8E-08	1.7315	8.3	8.2	610	933	
						8/06/2021	144	1.8E-08	1.7593	-	-	-	-	
						8/10/2021	148	2.0E-08	1.8002	8.2	8.1	-	-	
						8/13/2021	151	2.1E-08	1.8459	-	-	-	-	
						8/16/2021	154	2.1E-08	1.8754	8.3	8.1	-	-	
						8/20/2021	158	2.2E-08	1.9341	-	-	-	-	
						8/23/2021	161	1.9E-08	1.9568	8.1	8.3	582	857	
8/27/2021	165	2.1E-08	2.0127	-	-	-	-							
8/30/2021	168	2.1E-08	2.0365	8.5	8.3	-	-							
9/03/2021	172	2.0E-08	2.0908	8.7	8.2	-	-							
9/08/2021	177	2.1E-08	2.1424	8.2	8.1	622	844							

3-29-2023
 Approved By: NSR

Notes: 1- Based on Specimen Initial Conditions. 2- Based on average of four readings.



Excel Geotechnical Testing, Inc.
"Excellence in Testing"

953 Forrest Street, Roswell, Georgia 30075
 Tel: (770) 910 7537, www.excelgeotesting.com

Test Results Summary (Page 3)

Compatibility Test Results

Project Name: Belle River ALD Support

Project No.: PN1017

Site ID	Lab No.	Test Information												Remarks
		Initial Conditions		Final Conditions		Date	Number of Days After Injection	Permeability	Pore Volumes Passed After Injection	pH		Electrical Conductivity		
		Moisture Content	Dry Unit Weight	Moisture Content	Dry Unit Weight					In Flow	Out Flow	In Flow	Out Flow	
(-)	(-)	(%)	(pcf)	(%)	(pcf)	(-)	(-)	(cm/s)	(-)	(-)	(-)	(-)	(µs/cm)	(µs/cm)
B2-ST-4 (47-49')	20L152	36.6	84.2	39.0	83.2	9/10/2021	179	2.1E-08	2.1734	-	-	-	-	
						9/13/2021	182	1.9E-08	2.2019	8.2	8.2	-	-	
						9/17/2021	186	2.0E-08	2.2564	-	-	-	-	
						9/20/2021	189	1.9E-08	2.2802	8.2	8.3	-	-	
						9/24/2021	193	2.1E-08	2.3353	8.2	8.2	597	879	
						10/01/2021	200	1.7E-08	2.4097	8.4	8.4	-	-	
						10/07/2021	206	2.0E-08	2.4809	8.3	8.2	-	-	
						10/08/2021	207	1.9E-08	2.4941	-	-	-	-	
						10/14/2021	213	1.8E-08	2.5518	8.4	8.4	589	818	
						10/15/2021	214	1.8E-08	2.5654	-	-	-	-	
						10/22/2021	221	1.7E-08	2.6261	8.7	8.5	-	-	
						10/27/2021	226	2.0E-08	2.6889	8.6	8.4	-	-	
						10/29/2021	228	2.0E-08	2.7223	-	-	-	-	
						11/01/2021	231	2.1E-08	2.7543	8.1	8.1	610	831	
						11/05/2021	235	2.1E-08	2.8085	-	-	-	-	
						11/09/2021	239	1.8E-08	2.8361	8.8	8.5	-	-	
						11/12/2021	242	1.9E-08	2.8770	-	-	-	-	
						11/16/2021	246	1.8E-08	2.9080	8.8	8.3	-	-	
11/19/2021	249	2.2E-08	2.9551	-	-	-	-							
11/23/2021	253	2.2E-08	2.9935	8.8	8.3	661	783							
11/26/2021	256	2.2E-08	3.0400	-	-	-	-							
11/30/2021	260	1.9E-08	3.0726	8.8	8.3	-	-							
12/03/2021	263	2.1E-08	3.1182	-	-	-	-							

3-29-2023
 Approved By: NSR

Notes: 1- Based on Specimen Initial Conditions. 2- Based on average of four readings.



Excel Geotechnical Testing, Inc.
 "Excellence in Testing"

953 Forrest Street, Roswell, Georgia 30075
 Tel: (770) 910 7537, www.excelgeotesting.com

Test Results Summary (Page 4)

Compatibility Test Results

Project Name: Belle River ALD Support

Project No.: PN1017

Site ID	Lab No.	Test Information												Remarks
		Initial Conditions		Final Conditions		Date	Number of Days After Injection	Permeability	Pore Volumes Passed After Injection	pH		Electrical Conductivity		
		Moisture Content	Dry Unit Weight	Moisture Content	Dry Unit Weight					In Flow	Out Flow	In Flow	Out Flow	
(-)	(-)	(%)	(pcf)	(%)	(pcf)	(-)	(-)	(cm/s)	(-)	(-)	(-)	(-)	(µs/cm)	(µs/cm)
B2-ST-4 (47-49')	20L152	36.6	84.2	39.0	83.2	12/06/2021	266	2.0E-08	3.1463	8.3	8.1	-	-	
						12/10/2021	270	1.9E-08	3.1951	8.4	8.1	671	741	
						12/14/2021	274	1.9E-08	3.2281	7.8	8.0	-	-	
						12/17/2021	277	2.0E-08	3.2715	-	-	-	-	
						12/20/2021	280	2.1E-08	3.3014	8.3	8.1	-	-	
						12/24/2021	284	2.0E-08	3.3522	8.6	8.1	645	721	
						12/30/2021	290	2.0E-08	3.4220	8.6	8.4	-	-	
						12/31/2021	291	2.0E-08	3.4396	-	-	-	-	
						01/04/2022	295	2.0E-08	3.4863	8.1	8.0	-	-	
						01/07/2022	298	1.9E-08	3.5276	-	-	-	-	
						1/10/2022	301	1.7E-08	3.5536	8.2	8.0	649	720	
						1/14/2022	305	2.0E-08	3.6060	8.4	8.0	-	-	
						1/19/2022	310	1.9E-08	3.6684	8.5	8.1	-	-	
						1/21/2022	312	2.0E-08	3.7025	-	-	-	-	
						1/26/2022	317	1.8E-08	3.7442	8.3	8.4	1149	760	
						1/28/2022	319	1.8E-08	3.7723	-	-	-	-	
						2/1/2022	323	1.8E-08	3.8105	8.5	8.4	-	-	
						2/4/2022	326	1.9E-08	3.8526	-	-	-	-	
2/7/2022	329	1.9E-08	3.8801	8.7	8.5	-	-							
2/11/2022	333	1.9E-08	3.9313	-	-	-	-							
2/14/2022	336	1.8E-08	3.9571	8.8	8.2	1191	770							
2/18/2022	340	2.0E-08	4.0110	8.5	8.4	-	-							
2/23/2022	345	2.0E-08	4.0726	8.8	8.4	1180	-							

Notes: 1- Based on Specimen Initial Conditions. 2- Based on average of four readings.

3-29-2023
 Approved By: NSR



Excel Geotechnical Testing, Inc.
 "Excellence in Testing"

953 Forrest Street, Roswell, Georgia 30075
 Tel: (770) 910 7537, www.excelgeotesting.com

Test Results Summary (Page 5)

Compatibility Test Results

Project Name: Belle River ALD Support

Project No.: PN1017

Site ID	Lab No.	Test Information												Remarks
		Initial Conditions		Final Conditions		Date	Number of Days After Injection	Permeability	Pore Volumes Passed After Injection	pH		Electrical Conductivity		
		Moisture Content	Dry Unit Weight	Moisture Content	Dry Unit Weight					In Flow	Out Flow	In Flow	Out Flow	
(-)	(-)	(%)	(pcf)	(%)	(pcf)	(-)	(-)	(cm/s)	(-)	(-)	(-)	(-)	(µs/cm)	(µs/cm)
B2-ST-4 (47-49')	20L152	36.6	84.2	39.0	83.2	2/25/2022	347	2.0E-08	4.1040	-	-	-	-	
						2/28/2022	350	2.0E-08	4.1370	8.9	8.7	1200	765	
						3/4/2022	354	2.1E-08	4.1917	-	-	-	-	
						3/7/2022	357	2.2E-08	4.2179	8.6	8.7	-	-	
						3/11/2022	361	2.1E-08	4.2733	-	-	-	-	
						3/14/2022	364	1.9E-08	4.2968	8.5	8.6	-	-	
						3/18/2022	368	2.0E-08	4.3514	-	-	-	-	
						3/21/2022	371	1.8E-08	4.3743	8.8	8.8	1211	800	
						3/25/2022	375	2.2E-08	4.4317	8.9	8.2	1230	-	
						3/30/2022	380	2.1E-08	4.4978	8.2	8.6	1220	-	
						4/1/2022	382	2.1E-08	4.5292	-	-	-	-	
						4/4/2022	385	2.1E-08	4.5628	8.1	8.6	1225	836	
						4/8/2022	389	2.1E-08	4.6180	-	-	-	-	
						4/9/2022	390	2.1E-08	4.6287	8.2	8.7	1222	-	
						4/14/2022	395	2.1E-08	4.6911	7.9	8.0	1278	-	
						4/15/2022	396	2.0E-08	4.7047	-	-	-	-	
						4/20/2022	401	1.8E-08	4.7578	7.8	7.9	1210	-	
						4/22/2022	403	1.9E-08	4.7842	-	-	-	-	
4/27/2022	408	1.9E-08	4.8344	7.9	8.0	1214	-							
4/29/2022	410	1.9E-08	4.8652	-	-	-	-							
5/2/2022	413	2.0E-08	4.8997	7.9	8.0	1220	-							
5/6/2022	417	2.1E-08	4.9558	-	-	-	-							
5/7/2022	418	2.1E-08	4.9674	7.8	7.8	1236	873							

3-29-2023
 Approved By: NSR

Notes: 1- Based on Specimen Initial Conditions. 2- Based on average of four readings.



Excel Geotechnical Testing, Inc.
 "Excellence in Testing"

953 Forrest Street, Roswell, Georgia 30075
 Tel: (770) 910 7537, www.excelgeotesting.com

Test Results Summary (Page 6)

Compatibility Test Results

Project Name: Belle River ALD Support

Project No.: PN1017

Site ID	Lab No.	Test Information												Remarks
		Initial Conditions		Final Conditions		Date	Number of Days After Injection	Permeability	Pore Volumes Passed After Injection	pH		Electrical Conductivity		
		Moisture Content	Dry Unit Weight	Moisture Content	Dry Unit Weight					In Flow	Out Flow	In Flow	Out Flow	
(-)	(-)	(%)	(pcf)	(%)	(pcf)	(-)	(-)	(cm/s)	(-)	(-)	(-)	(-)	(µs/cm)	(µs/cm)
B2-ST-4 (47-49')	20L152	36.6	84.2	39.0	83.2	5/12/2022	423	2.1E-08	5.0318	7.7	7.9	1196	-	
						5/13/2022	424	2.1E-08	5.0504	-	-	-	-	
						5/17/2022	428	2.2E-08	5.1006	7.8	8.0	1239		
						5/20/2022	431	2.1E-08	5.1460	-	-	-	-	
						5/23/2022	434	2.1E-08	5.1748	7.9	8.3	1247	956	
						5/27/2022	438	2.2E-08	5.2328	-	-	-	-	
						5/28/2022	439	2.1E-08	5.2441	7.8	7.8	-	-	
						6/3/2022	445	2.1E-08	5.3162	8.0	8.1	1289	-	
						6/8/2022	450	2.1E-08	5.3852	8.0	8.1	1270	1536	
						6/10/2022	452	2.2E-08	5.4180	-	-	-	-	
						6/13/2022	455	2.2E-08	5.4529	8.2	8.3	1277	-	
						6/17/2022	459	2.2E-08	5.5106	8.1	8.1	1264	-	
						6/22/2022	464	2.1E-08	5.5783	7.9	8.1	1250	1771	
						6/24/2022	466	2.1E-08	5.6113	-	-	-	-	
						6/27/2022	469	2.1E-08	5.6448	8.4	8.3	1199	-	
						7/1/2022	473	2.2E-08	5.7032	-	-	-	-	
						7/5/2022	477	2.3E-08	5.7361	8.2	8.2	1276	-	
						7/8/2022	480	2.1E-08	5.7838	-	-	-	-	
7/11/2022	483	2.1E-08	5.8123	8.1	8.2	1271	1013							
7/15/2022	487	2.2E-08	5.8711	-	-	-	-							
7/18/2022	490	2.1E-08	5.8961	8.1	8.3	1251	-							
7/22/2022	494	2.3E-08	5.9550	-	-	-	-							
7/27/2022	499	2.2E-08	6.0271	8.5	8.6	1152	-							

3-29-2023
 Approved By: NSR

Notes: 1- Based on Specimen Initial Conditions. 2- Based on average of four readings.



Excel Geotechnical Testing, Inc.
 "Excellence in Testing"

953 Forrest Street, Roswell, Georgia 30075
 Tel: (770) 910 7537, www.excelgeotesting.com

Test Results Summary (Page 7)

Compatibility Test Results

Project Name: Belle River ALD Support

Project No.: PN1017

Site ID	Lab No.	Test Information												Remarks
		Initial Conditions		Final Conditions		Date	Number of Days After Injection	Permeability	Pore Volumes Passed After Injection	pH		Electrical Conductivity		
		Moisture Content	Dry Unit Weight	Moisture Content	Dry Unit Weight					In Flow	Out Flow	In Flow	Out Flow	
(-)	(-)	(%)	(pcf)	(%)	(pcf)	(-)	(-)	(cm/s)	(-)	(-)	(-)	(-)	(µs/cm)	(µs/cm)
B2-ST-4 (47-49')	20L152	36.6	84.2	39.0	83.2	7/29/2022	501	2.2E-08	6.0446	8.0	8.2	1164	977	
						8/2/2022	505	2.2E-08	6.0952	7.9	8.2	1261	-	
						8/5/2022	508	2.2E-08	6.1437	-	-	-	-	
						8/8/2022	511	2.1E-08	6.1722	8.4	8.3	1264	-	
						8/12/2022	515	2.1E-08	6.2321	-	-	-	-	
						8/15/2022	518	2.2E-08	6.2569	8.9	8.4	1221	2090	
						8/19/2022	522	2.2E-08	6.3160	8.3	8.6	-	-	
						8/24/2022	527	2.1E-08	6.3850	7.9	8.1	1224	-	
						8/26/2022	529	2.2E-08	6.4180	-	-	-	-	
						8/29/2022	532	2.2E-08	6.4531	8.2	8.2	1244	1244	
						9/2/2022	536	2.2E-08	6.5122	8.3	8.3	1253	-	
						9/7/2022	541	2.1E-08	6.5807	8.1	8.1	1250	-	
						9/9/2022	543	2.1E-08	6.6150	-	-	-	-	
						9/12/2022	546	2.1E-08	6.6491	8.0	8.1	1168	1783	
						9/16/2022	550	2.2E-08	6.7092	8.6	8.5	1283	-	
						9/21/2022	555	2.1E-08	6.7757	8.5	8.6	1191	-	
						9/23/2022	557	2.1E-08	6.8100	-	-	-	-	
						9/26/2022	560	2.2E-08	6.8445	8.4	8.2	1239	1059	
9/30/2022	564	2.2E-08	6.9031	8.2	8.2	1196	-							
10/7/2022	571	2.1E-08	7.0035	-	-	-	-							
10/10/2022	574	2.1E-08	7.0365	8.9	8.3	1213	1045							
10/14/2022	578	2.2E-08	7.0950	8.2	8.1	1207	-							
10/19/2022	583	2.0E-08	7.1600	8.4	8.3	1201	-							

Notes: 1- Based on Specimen Initial Conditions. 2- Based on average of four readings.

3-29-2023
 Approved By: NSR



Excel Geotechnical Testing, Inc.
 "Excellence in Testing"

953 Forrest Street, Roswell, Georgia 30075
 Tel: (770) 910 7537, www.excelgeotesting.com

Test Results Summary (Page 8)

Compatibility Test Results

Project Name: Belle River ALD Support

Project No.: PN1017

Site ID	Lab No.	Test Information												Remarks
		Initial Conditions		Final Conditions		Date	Number of Days After Injection	Permeability	Pore Volumes Passed After Injection	pH		Electrical Conductivity		
		Moisture Content	Dry Unit Weight	Moisture Content	Dry Unit Weight					In Flow	Out Flow	In Flow	Out Flow	
(-)	(-)	(%)	(pcf)	(%)	(pcf)	(-)	(-)	(cm/s)	(-)	(-)	(-)	(-)	(µs/cm)	(µs/cm)
B2-ST-4 (47-49')	20L152	36.6	84.2	39.0	83.2	10/21/2022	585	1.9E-08	7.1910	-	-	-	-	
						10/24/2022	588	2.1E-08	7.2276	8.2	8.1	1190	-	
						10/28/2022	592	2.1E-08	7.2259	8.6	8.3	1231	-	
						11/2/2022	597	2.1E-08	7.3513	7.9	8.1	1312	-	
						11/4/2022	599	2.2E-08	7.3849	-	-	-	-	
						11/7/2022	602	2.2E-08	7.4202	8.3	8.2	1218	997	
						11/11/2022	606	2.2E-08	7.4791	8.1	8.3	-	-	
						11/18/2022	613	1.9E-08	7.5493	8.2	8.4	1215	-	
						11/23/2022	618	1.7E-08	7.5999	8.6	8.7	1193	1011	
						11/25/2022	620	1.9E-08	7.6286	-	-	-	-	
						12/2/2022	627	1.8E-08	7.7056	-	-	-	-	
						12/3/2022	628	1.7E-08	7.7151	8.8	8.8	-	-	
						12/5/2022	630	1.7E-08	7.7292	8.6	8.6	1194	-	
						12/9/2022	634	1.9E-08	7.7785	-	-	-	-	
						12/13/2022	638	1.7E-08	7.8139	8.6	8.9	1238	1043	
						12/16/2022	641	1.8E-08	7.8475	-	-	-	-	
12/20/2022	645	1.6E-08	7.8684	9.4	9.0	1290	-							
12/23/2022	648	1.8E-08	7.9165	-	-	-	-							
12/31/2022	656	1.6E-08	7.9960	-	-	-	-							

3-29-2023
 Approved By: NSR

Notes: 1- Based on Specimen Initial Conditions. 2- Based on average of four readings.



Excel Geotechnical Testing, Inc.
 "Excellence in Testing"

953 Forrest Street, Roswell, Georgia 30075
 Tel: (770) 910 7537, www.excelgeotesting.com

Test Results Summary (Page 1)

Compatibility Test Results

Project Name: Belle River ALD Support

Project No.: PN1017

Site ID	Lab No.	Test Information												Remarks
		Initial Conditions		Final Conditions		Date	Number of Days After Injection	Permeability	Pore Volumes Passed After Injection	pH		Electrical Conductivity		
		Moisture Content	Dry Unit Weight	Moisture Content	Dry Unit Weight					In Flow	Out Flow	In Flow	Out Flow	
(-)	(-)	(%)	(pcf)	(%)	(pcf)	(-)	(-)	(cm/s)	(-)	(-)	(-)	(-)	(µs/cm)	(µs/cm)
B3-ST-5 (77-79')	20L160	20.5	106.6	19.5	111.0	3/15/2021	0	2.2E-08	0.0000	-	-	-	-	
						3/22/2021	7	2.0E-08	0.1144	8.5	8.2	-	-	
						3/29/2021	14	1.9E-08	0.2120	8.1	8.2	-	-	
						4/05/2021	21	1.7E-08	0.3126	8.2	8.2	633	1118	
						4/12/2021	28	1.9E-08	0.4132	-	-	-	-	
						4/13/2021	29	1.9E-08	0.4221	8.3	8.1	-	-	
						4/19/2021	35	1.9E-08	0.5181	8.2	8.1	-	-	
						4/26/2021	42	1.7E-08	0.6197	8.4	8.0	648	1027	
						5/03/2021	49	1.9E-08	0.7283	8.5	8.1	-	-	
						5/10/2021	56	1.8E-08	0.8335	8.1	7.8	-	-	
						5/14/2021	60	1.9E-08	0.9042	8.5	8.1	719	980	
						5/20/2021	66	1.8E-08	1.0021	8.6	8.4	-	-	
						5/21/2021	67	1.8E-08	1.0259	-	-	-	-	
						5/25/2021	71	1.9E-08	1.0878	8.1	8.1	-	-	
						5/28/2021	74	1.9E-08	1.1473	8.3	8.2	611	1024	
						6/04/2021	81	1.8E-08	1.2549	8.6	8.0	-	-	
						6/10/2021	87	1.9E-08	1.3556	8.8	8.6	-	-	
						6/11/2021	88	1.9E-08	1.3775	-	-	-	-	
6/16/2021	93	1.8E-08	1.4522	8.5	8.1	699	927							
6/18/2021	95	1.8E-08	1.4956	-	-	-	-							
6/22/2021	99	1.8E-08	1.5517	8.2	7.9	-	-							
6/25/2021	102	2.0E-08	1.6200	-	-	-	-							
6/28/2021	105	1.9E-08	1.6642	8.3	8.6	-	-							

3-29-2023
 Approved By: NSR

Notes: 1- Based on Specimen Final Conditions. 2- Based on average of four readings.



Excel Geotechnical Testing, Inc.
 "Excellence in Testing"

953 Forrest Street, Roswell, Georgia 30075
 Tel: (770) 910 7537, www.excelgeotesting.com

Test Results Summary (Page 2)

Compatibility Test Results

Project Name: Belle River ALD Support

Project No.: PN1017

Site ID	Lab No.	Test Information												Remarks
		Initial Conditions		Final Conditions		Date	Number of Days After Injection	Permeability	Pore Volumes Passed After Injection	pH		Electrical Conductivity		
		Moisture Content	Dry Unit Weight	Moisture Content	Dry Unit Weight					In Flow	Out Flow	In Flow	Out Flow	
(-)	(-)	(%)	(pcf)	(%)	(pcf)	(-)	(-)	(cm/s)	(-)	(-)	(-)	(-)	(µs/cm)	(µs/cm)
B3-ST-5 (77-79')	20L160	20.5	106.6	19.5	111.0	7/02/2021	109	2.0E-08	1.7456	8.2	7.8	-	-	
						7/08/2021	115	1.8E-08	1.8481	8.2	8.2	735	816	
						7/09/2021	116	1.8E-08	1.8697	-	-	-	-	
						7/14/2021	121	1.9E-08	1.9475	8.3	8.1	-	-	
						7/16/2021	123	1.8E-08	1.9823	-	-	-	-	
						7/20/2021	127	1.9E-08	2.0134	8.2	8.2	-	-	
						7/23/2021	130	1.9E-08	2.0741	-	-	-	-	
						7/27/2021	134	1.8E-08	2.1274	8.7	8.2	681	862	
						7/30/2021	137	1.8E-08	2.1826	-	-	-	-	
						8/03/2021	141	1.6E-08	2.2278	8.4	8.3	-	-	
						8/06/2021	144	1.6E-08	2.2787	-	-	-	-	
						8/10/2021	148	1.7E-08	2.3263	8.1	8.1	-	-	
						8/13/2021	151	1.8E-08	2.3830	-	-	-	-	
						8/16/2021	154	1.9E-08	2.4223	8.1	8.1	714	817	
						8/20/2021	158	1.8E-08	2.4934	-	-	-	-	
						8/23/2021	161	1.6E-08	2.5242	8.1	8.1	-	-	
						8/27/2021	165	1.8E-08	2.5950	-	-	-	-	
						8/30/2021	168	1.9E-08	2.6279	8.1	8.2	-	-	
9/03/2021	172	1.8E-08	2.6980	8.4	8.1	647	811							
9/09/2021	178	1.7E-08	2.7929	8.1	8.0	-	-							
9/10/2021	179	1.7E-08	2.8139	-	-	-	-							
9/14/2021	183	1.8E-08	2.8731	8.0	7.9	-	-							
9/17/2021	186	1.7E-08	2.9252	-	-	-	-							

Notes: 1- Based on Specimen Initial Conditions. 2- Based on average of four readings.

3-29-2023
 Approved By: NSR



Excel Geotechnical Testing, Inc.
 "Excellence in Testing"

953 Forrest Street, Roswell, Georgia 30075
 Tel: (770) 910 7537, www.excelgeotesting.com

Test Results Summary (Page 3)

Compatibility Test Results

Project Name: Belle River ALD Support

Project No.: PN1017

Site ID	Lab No.	Test Information												Remarks
		Initial Conditions		Final Conditions		Date	Number of Days After Injection	Permeability	Pore Volumes Passed After Injection	pH		Electrical Conductivity		
		Moisture Content	Dry Unit Weight	Moisture Content	Dry Unit Weight					In Flow	Out Flow	In Flow	Out Flow	
(-)	(-)	(%)	(pcf)	(%)	(pcf)	(-)	(-)	(cm/s)	(-)	(-)	(-)	(-)	(µs/cm)	(µs/cm)
B3-ST-5 (77-79')	20L160	20.5	106.6	19.5	111.0	9/21/2021	190	1.8E-08	2.9740	8.3	8.1	600	792	
						9/24/2021	193	1.8E-08	3.0317	-	-	-	-	
						9/28/2021	197	1.6E-08	3.0759	8.1	8.0	-	-	
						10/01/2021	200	1.6E-08	3.1277	-	-	-	-	
						10/05/2021	204	1.8E-08	3.1790	8.2	8.1	-	-	
						10/08/2021	207	1.8E-08	3.2357	-	-	-	-	
						10/12/2021	211	1.7E-08	3.2808	8.1	8.0	580	777	
						10/15/2021	214	1.8E-08	3.3342	-	-	-	-	
						10/19/2021	218	1.4E-08	3.3741	8.1	8.2	-	-	
						10/22/2021	221	1.6E-08	3.4245	-	-	-	-	
						10/26/2021	225	1.7E-08	3.4754	8.5	8.2	-	-	
						10/29/2021	228	1.8E-08	3.5315	-	-	-	-	
						11/01/2021	231	1.9E-08	3.5702	8.1	8.0	669	672	
						11/05/2021	235	1.9E-08	3.6440	-	-	-	-	
						11/09/2021	239	1.6E-08	3.6822	8.0	8.0	-	-	
						11/12/2021	242	1.7E-08	3.7371	-	-	-	-	
						11/16/2021	246	1.6E-08	3.7819	8.2	8.1	-	-	
						11/19/2021	249	2.1E-08	3.8441	-	-	-	-	
						11/24/2021	254	2.0E-08	3.9063	8.5	8.2	601	800	
						11/26/2021	256	2.1E-08	3.9536	-	-	-	-	
12/02/2021	262	1.7E-08	4.0228	8.1	8.2	-	-							
12/03/2021	263	1.7E-08	4.0475	-	-	-	-							
12/08/2021	268	1.8E-08	4.1201	8.1	7.9	-	-							

3-29-2023
 Approved By: NSR

Notes: 1- Based on Specimen Initial Conditions. 2- Based on average of four readings.



Excel Geotechnical Testing, Inc.
"Excellence in Testing"

953 Forrest Street, Roswell, Georgia 30075
Tel: (770) 910 7537, www.excelgeotesting.com

Test Results Summary (Page 4)

Compatibility Test Results

Project Name: Belle River ALD Support

Project No.: PN1017

Site ID	Lab No.	Test Information												Remarks
		Initial Conditions		Final Conditions		Date	Number of Days After Injection	Permeability	Pore Volumes Passed After Injection	pH		Electrical Conductivity		
		Moisture Content	Dry Unit Weight	Moisture Content	Dry Unit Weight					In Flow	Out Flow	In Flow	Out Flow	
(-)	(-)	(%)	(pcf)	(%)	(pcf)	(-)	(-)	(cm/s)	(-)	(-)	(-)	(-)	(µs/cm)	(µs/cm)
B3-ST-5 (77-79')	20L160	20.5	106.6	19.5	111.0	12/10/2021	270	1.8E-08	4.1674	-	-	-	-	
						12/14/2021	274	1.8E-08	4.2369	7.9	7.7	579	758	
						12/17/2021	277	1.8E-08	4.2936	-	-	-	-	
						12/20/2021	280	1.8E-08	4.3333	8.3	7.9	-	-	
						12/24/2021	284	1.8E-08	4.4010	-	-	-	-	
						12/28/2021	288	1.8E-08	4.4449	8.8	8.5	-	-	
						12/31/2021	291	1.9E-08	4.5034	-	-	-	-	
						01/04/2022	295	1.8E-08	4.5510	8.1	7.8	652	786	
						01/07/2022	298	1.8E-08	4.6086	-	-	-	-	
						1/10/2022	301	1.7E-08	4.6449	8.4	7.9	-	-	
						01/14/2022	305	1.8E-08	4.7178	-	-	-	-	
						1/18/2022	309	1.6E-08	4.7602	8.0	7.9	-	-	
						1/21/2022	312	1.8E-08	4.8233	-	-	-	-	
						1/24/2022	315	1.8E-08	4.8581	8.2	7.9	1051	790	
						1/28/2022	319	1.8E-08	4.9267	-	-	-	-	
						1/31/2022	322	1.6E-08	5.0304	8.2	8.3	-	-	
						2/7/2022	329	1.7E-08	5.0640	8.4	8.2	-	-	
						2/11/2022	333	1.7E-08	5.1323	-	-	-	-	
						2/14/2022	336	1.7E-08	5.1676	8.5	8.5	1183	849	
						2/18/2022	340	1.9E-08	5.2408	8.5	8.0	-	-	
2/23/2022	345	1.9E-08	5.3296	8.5	8.5	-	-							
2/25/2022	347	1.9E-08	5.3705	-	-	-	-							
2/28/2022	350	1.9E-08	5.4168	8.5	8.5	1177	729							

3-29-2023
Approved By: NSR

Notes: 1- Based on Specimen Initial Conditions. 2- Based on average of four readings.



Excel Geotechnical Testing, Inc.
 "Excellence in Testing"

953 Forrest Street, Roswell, Georgia 30075
 Tel: (770) 910 7537, www.excelgeotesting.com

Test Results Summary (Page 5)

Compatibility Test Results

Project Name: Belle River ALD Support

Project No.: PN1017

Site ID	Lab No.	Test Information												Remarks
		Initial Conditions		Final Conditions		Date	Number of Days After Injection	Permeability	Pore Volumes Passed After Injection	pH		Electrical Conductivity		
		Moisture Content	Dry Unit Weight	Moisture Content	Dry Unit Weight					In Flow	Out Flow	In Flow	Out Flow	
(-)	(-)	(%)	(pcf)	(%)	(pcf)	(-)	(-)	(cm/s)	(-)	(-)	(-)	(-)	(µs/cm)	(µs/cm)
B3-ST-5 (77-79')	20L160	20.5	106.6	19.5	111.0	3/4/2022	354	1.9E-08	5.4927	-	-	-	-	
						3/7/2022	357	2.0E-08	5.5306	8.6	8.5	-	-	
						3/11/2022	361	2.0E-08	5.6092	-	-	-	-	
						3/14/2022	364	1.8E-08	5.6440	8.5	8.8	-	-	
						3/18/2022	368	1.9E-08	5.7181	-	-	-	-	
						3/21/2022	371	1.7E-08	5.7507	8.1	8.4	1150	783	
						3/25/2022	375	2.1E-08	5.8285	9.1	8.9	1230	-	
						3/31/2022	381	2.0E-08	5.9182	8.6	7.9	1208	-	
						4/1/2022	382	2.1E-08	5.9426	-	-	-	-	
						4/5/2022	386	1.9E-08	6.0087	8.2	8.6	1274	741	
						4/8/2022	389	2.0E-08	6.0719	-	-	-	-	
						4/11/2022	392	1.8E-08	6.1097	7.5	7.6	1249	-	
						4/16/2022	397	2.0E-08	6.2036	7.7	8.1	1223	-	
						4/22/2022	403	1.7E-08	6.2945	-	-	-	-	
						4/23/2022	404	1.8E-08	6.3079	7.9	7.9	1261	972	
						4/29/2022	410	1.9E-08	6.4110	8.3	8.0	1241	-	
						5/5/2022	416	1.9E-08	6.5156	8.2	8.1	1294	-	
						5/6/2022	417	2.0E-08	6.5409	-	-	-	-	
5/11/2022	422	1.9E-08	6.6190	7.9	8.0	1247	925							
5/13/2022	424	2.0E-08	6.6666	-	-	-	-							
5/16/2022	427	2.1E-08	6.7160	8.0	8.1	1284	-							
5/20/2022	431	2.0E-08	6.7928	-	-	-	-							
5/23/2022	434	1.9E-08	6.8273	7.9	8.1	1290	-							

Notes: 1- Based on Specimen Initial Conditions. 2- Based on average of four readings.

3-29-2023
 Approved By: NSR



Excel Geotechnical Testing, Inc.
 "Excellence in Testing"

953 Forrest Street, Roswell, Georgia 30075
 Tel: (770) 910 7537, www.excelgeotesting.com

Test Results Summary (Page 6)

Compatibility Test Results

Project Name: Belle River ALD Support

Project No.: PN1017

Site ID	Lab No.	Test Information												Remarks
		Initial Conditions		Final Conditions		Date	Number of Days After Injection	Permeability	Pore Volumes Passed After Injection	pH		Electrical Conductivity		
		Moisture Content	Dry Unit Weight	Moisture Content	Dry Unit Weight					In Flow	Out Flow	In Flow	Out Flow	
(-)	(-)	(%)	(pcf)	(%)	(pcf)	(-)	(-)	(cm/s)	(-)	(-)	(-)	(-)	(µs/cm)	(µs/cm)
B3-ST-5 (77-79')	20L160	20.5	106.6	19.5	111.0	5/27/2022	438	2.1E-08	6.9063	-	-	-	-	
						5/28/2022	439	2.0E-08	6.9218	7.9	8.0	1250	-	
						6/3/2022	445	2.0E-08	7.0243	8.1	8.1	1241	-	
						6/8/2022	450	2.1E-08	7.1197	8.4	8.1	1247	-	
						6/10/2022	452	2.1E-08	7.1652	-	-	-	-	
						6/13/2022	455	2.1E-08	7.2155	8.2	8.2	1249	813	
						6/17/2022	459	2.1E-08	7.2969	-	-	-	-	
						6/20/2022	462	2.0E-08	7.3329	8.2	8.1	1287	-	
						6/24/2022	466	2.1E-08	7.4128	-	-	-	-	
						6/27/2022	469	1.9E-08	7.4476	8.2	8.3	1210	-	
						7/1/2022	473	2.1E-08	7.5290	-	-	-	-	
						7/5/2022	477	2.2E-08	7.5766	8.2	8.5	1183	1104	
						7/8/2022	480	2.1E-08	7.6424	-	-	-	-	
						7/11/2022	483	2.0E-08	7.6827	8.2	8.2	1250	-	
						7/15/2022	487	2.2E-08	7.7647	-	-	-	-	
						7/18/2022	490	2.0E-08	7.8010	8.1	8.2	1152	-	
						7/22/2022	494	2.2E-08	7.8825	-	-	-	-	
						7/25/2022	497	2.0E-08	7.9184	8.0	8.1	1118	834	
7/28/2022	500	2.1E-08	7.9828	8.3	8.2	1191	-							
7/29/2022	501	2.1E-08	8.0033	-	-	-	-							
8/2/2022	505	2.1E-08	8.0774	7.9	8.1	1249	-							
8/5/2022	508	2.1E-08	8.1445	-	-	-	-							
8/8/2022	511	2.0E-08	8.1856	8.2	8.3	1203	-							

Notes: 1- Based on Specimen Initial Conditions. 2- Based on average of four readings.

3-29-2023
 Approved By: NSR



Excel Geotechnical Testing, Inc.
 "Excellence in Testing"

953 Forrest Street, Roswell, Georgia 30075
 Tel: (770) 910 7537, www.excelgeotesting.com

Test Results Summary (Page 7)

Compatibility Test Results

Project Name: Belle River ALD Support

Project No.: PN1017

Site ID	Lab No.	Test Information												Remarks
		Initial Conditions		Final Conditions		Date	Number of Days After Injection	Permeability	Pore Volumes Passed After Injection	pH		Electrical Conductivity		
		Moisture Content	Dry Unit Weight	Moisture Content	Dry Unit Weight					In Flow	Out Flow	In Flow	Out Flow	
(-)	(-)	(%)	(pcf)	(%)	(pcf)	(-)	(-)	(cm/s)	(-)	(-)	(-)	(-)	(µs/cm)	(µs/cm)
B3-ST-5 (77-79')	20L160	20.5	106.6	19.5	111.0	8/12/2022	515	2.2E-08	8.2683	-	-	-	-	
						8/15/2022	518	2.0E-08	8.3036	8.2	8.1	1224	-	
						8/19/2022	522	2.1E-08	8.3839	8.4	8.3	1178	-	
						8/24/2022	527	2.1E-08	8.4790	8.1	8.2	1231	801	
						8/26/2022	529	2.1E-08	8.5254	-	-	-	-	
						8/29/2022	532	2.1E-08	8.5751	8.1	8.3	1242	-	
						9/2/2022	536	2.2E-08	8.6559	8.1	8.3	1237	-	
						9/7/2022	541	2.0E-08	8.7501	8.1	8.2	1218	922	
						9/9/2022	543	2.0E-08	8.7965	-	-	-	-	
						9/12/2022	546	2.1E-08	8.8447	8.1	8.2	1194	-	
						9/16/2022	550	2.1E-08	8.9270	8.2	8.2	1179	-	
						9/22/2022	556	1.9E-08	9.0316	7.9	8.0	1238	1133	
						9/23/2022	557	2.0E-08	9.0584	-	-	-	-	
						9/27/2022	561	2.1E-08	9.1280	8.1	8.1	1224	-	
						9/30/2022	564	2.1E-08	9.1938	-	-	-	-	
						10/3/2022	567	2.0E-08	9.2344	8.4	8.3	1212	-	
						10/7/2022	571	2.1E-08	9.3149	8.2	8.2	1195	982	
						10/12/2022	576	1.9E-08	9.4067	8.8	8.3	1250	-	
10/14/2022	578	2.1E-08	9.4537	-	-	-	-							
10/18/2022	582	1.9E-08	9.5122	8.5	8.2	1191	-							
10/21/2022	585	1.9E-08	9.5717	-	-	-	-							
10/24/2022	588	2.0E-08	9.6153	8.6	8.3	1186	870							
10/28/2022	592	2.0E-08	9.6949	-	-	-	-							

Notes: 1- Based on Specimen Initial Conditions. 2- Based on average of four readings.

3-29-2023
 Approved By: NSR



Excel Geotechnical Testing, Inc.
 "Excellence in Testing"

953 Forrest Street, Roswell, Georgia 30075
 Tel: (770) 910 7537, www.excelgeotesting.com

Test Results Summary (Page 8)

Compatibility Test Results

Project Name: Belle River ALD Support

Project No.: PN1017

Site ID	Lab No.	Test Information												Remarks
		Initial Conditions		Final Conditions		Date	Number of Days After Injection	Permeability	Pore Volumes Passed After Injection	pH		Electrical Conductivity		
		Moisture Content	Dry Unit Weight	Moisture Content	Dry Unit Weight					In Flow	Out Flow	In Flow	Out Flow	
(-)	(-)	(%)	(pcf)	(%)	(pcf)	(-)	(-)	(cm/s)	(-)	(-)	(-)	(-)	(µs/cm)	(µs/cm)
B3-ST-5 (77-79)	20L160	20.5	106.6	19.5	111.0	10/31/2022	595	2.0E-08	9.7324	8.0	8.1	1236	-	
						11/4/2022	599	2.1E-08	9.8135	-	-	-	-	
						11/7/2022	602	2.0E-08	9.8507	8.2	8.3	1195	-	
						11/11/2022	606	2.1E-08	9.9319	8.1	8.3	1331	907	
						11/18/2022	613	1.7E-08	10.0270	8.3	8.4	1397	-	
						11/25/2022	620	1.6E-08	10.1139	-	-	-	-	
						11/30/2022	625	1.6E-08	10.1911	8.6	8.8	1256	-	
						12/1/2022	626	1.6E-08	10.2008	8.5	8.6	1161	931	
						12/2/2022	627	1.5E-08	10.2170	-	-	-	-	
						12/8/2022	633	1.4E-08	10.2911	8.3	8.5	1376	-	
						12/9/2022	634	1.5E-08	10.3122	-	-	-	-	
						12/16/2022	641	1.5E-08	10.4070	8.6	8.7	1213	-	
						12/22/2022	647	1.3E-08	10.4771	8.6	8.6	1273	955	
						12/23/2022	648	1.5E-08	10.4994	-	-	-	-	
12/31/2022	656	1.6E-08	10.6189	-	-	-	-							

3-29-2023
 Approved By: NSR

Notes: 1- Based on Specimen Initial Conditions. 2- Based on average of four readings.



Excel Geotechnical Testing, Inc.
"Excellence in Testing"

953 Forrest Street, Roswell, Georgia 30075
 Tel: (770) 910 7537, www.excelgeotesting.com

Test Results Summary (Page 1)

Compatibility Test Results

Project Name: Belle River ALD Support

Project No.: PN1017

Site ID	Lab No.	Test Information												Remarks
		Initial Conditions		Final Conditions		Date	Number of Days After Injection	Permeability	Pore Volumes Passed After Injection	pH		Electrical Conductivity		
		Moisture Content	Dry Unit Weight	Moisture Content	Dry Unit Weight					In Flow	Out Flow	In Flow	Out Flow	
(-)	(-)	(%)	(pcf)	(%)	(pcf)	(-)	(-)	(cm/s)	(-)	(-)	(-)	(-)	(µs/cm)	(µs/cm)
B4-ST-3 (47-49')	20L164	42.1	80.7	38.8	84.3	3/15/2021	0	2.7E-08	0.0000	-	-	-	-	
						3/19/2021	4	3.0E-08	0.0694	8.6	8.4	-	-	
						3/22/2021	7	2.9E-08	0.1236	-	-	-	-	
						3/24/2021	9	3.0E-08	0.1481	8.7	8.2	-	-	
						3/29/2021	14	2.5E-08	0.2201	8.4	8.3	565	910	
						4/02/2021	18	2.3E-08	0.2835	8.5	8.1	-	-	
						4/05/2021	21	2.3E-08	0.3313	-	-	-	-	
						4/07/2021	23	2.4E-08	0.3526	7.9	8.0	-	-	
						4/12/2021	28	2.6E-08	0.4258	-	-	-	-	
						4/13/2021	29	2.5E-08	0.4337	7.7	8.0	661	930	
						4/19/2021	35	2.4E-08	0.5144	8.0	8.0	-	-	
						4/23/2021	39	2.5E-08	0.5782	8.5	8.7	-	-	
						4/26/2021	42	2.5E-08	0.6278	-	-	-	-	
						4/27/2021	43	2.5E-08	0.6412	8.1	8.0	586	823	
						5/03/2021	49	2.6E-08	0.7411	8.4	8.1	-	-	
						5/07/2021	53	2.7E-08	0.8047	8.7	8.1	-	-	
						5/12/2021	58	2.5E-08	0.8788	8.3	8.1	518	788	
						5/14/2021	60	2.6E-08	0.9138	-	-	-	-	
5/17/2021	63	2.5E-08	0.9507	8.2	8.2	-	-							
5/21/2021	67	2.6E-08	1.0152	7.7	7.8	-	-							
5/25/2021	71	2.6E-08	1.0790	7.8	7.8	584	746							
5/28/2021	74	2.7E-08	1.1324	7.8	8.0	-	-							
6/01/2021	78	2.7E-08	1.1968	7.9	7.9	-	-							

Notes: 1- Based on Specimen Final Conditions. 2- Based on average of four readings.

3-29-2023
 Approved By: NSR



Excel Geotechnical Testing, Inc.
 "Excellence in Testing"

953 Forrest Street, Roswell, Georgia 30075
 Tel: (770) 910 7537, www.excelgeotesting.com

Test Results Summary (Page 2)

Compatibility Test Results

Project Name: Belle River ALD Support

Project No.: PN1017

Site ID	Lab No.	Test Information												Remarks
		Initial Conditions		Final Conditions		Date	Number of Days After Injection	Permeability	Pore Volumes Passed After Injection	pH		Electrical Conductivity		
		Moisture Content	Dry Unit Weight	Moisture Content	Dry Unit Weight					In Flow	Out Flow	In Flow	Out Flow	
(-)	(-)	(%)	(pcf)	(%)	(pcf)	(-)	(-)	(cm/s)	(-)	(-)	(-)	(-)	(µs/cm)	(µs/cm)
B4-ST-3 (47-49')	20L164	42.1	80.7	38.8	84.3	6/04/2021	81	2.6E-08	1.2483	8.0	7.9	586	778	
						6/08/2021	85	2.6E-08	1.3136	8.1	8.2	-	-	
						6/11/2021	88	2.6E-08	1.3669	8.2	8.1	-	-	
						6/15/2021	92	2.6E-08	1.4316	8.2	8.2	597	730	
						6/18/2021	95	2.6E-08	1.4863	8.1	8.2	-	-	
						6/23/2021	100	2.5E-08	1.5629	8.4	8.3	-	-	
						6/25/2021	102	2.7E-08	1.6056	-	-	-	-	
						6/28/2021	105	2.6E-08	1.6453	8.5	8.3	650	774	
						7/02/2021	109	2.7E-08	1.7123	8.2	7.8	-	-	
						7/06/2021	113	2.7E-08	1.7795	8.3	8.4	-	-	
						7/09/2021	116	2.5E-08	1.8314	8.5	8.1	710	830	
						7/14/2021	121	2.6E-08	1.9130	8.3	8.2	-	-	
						7/16/2021	123	2.8E-08	1.9569	-	-	-	-	
						7/19/2021	126	2.7E-08	1.9941	8.3	8.2	-	-	
						7/23/2021	130	2.6E-08	2.0575	8.4	8.2	651	734	
						7/28/2021	135	2.6E-08	2.1330	8.2	8.2	-	-	
						7/30/2021	137	2.6E-08	2.1727	-	-	-	-	
						8/03/2021	141	2.3E-08	2.2186	8.3	8.2	-	-	
8/06/2021	144	2.4E-08	2.2681	-	-	-	-							
8/09/2021	147	2.5E-08	2.3002	8.3	8.2	651	749							
8/13/2021	151	2.7E-08	2.3653	8.1	8.1	-	-							
8/17/2021	155	2.8E-08	2.4344	8.3	8.3	-	-							
8/20/2021	158	2.7E-08	2.4869	8.3	8.2	611	671							

3-29-2023
 Approved By: NSR

Notes: 1- Based on Specimen Initial Conditions. 2- Based on average of four readings.



Excel Geotechnical Testing, Inc.
 "Excellence in Testing"

953 Forrest Street, Roswell, Georgia 30075
 Tel: (770) 910 7537, www.excelgeotesting.com

Test Results Summary (Page 3)

Compatibility Test Results

Project Name: Belle River ALD Support

Project No.: PN1017

Site ID	Lab No.	Test Information												Remarks
		Initial Conditions		Final Conditions		Date	Number of Days After Injection	Permeability	Pore Volumes Passed After Injection	pH		Electrical Conductivity		
		Moisture Content	Dry Unit Weight	Moisture Content	Dry Unit Weight					In Flow	Out Flow	In Flow	Out Flow	
(-)	(-)	(%)	(pcf)	(%)	(pcf)	(-)	(-)	(cm/s)	(-)	(-)	(-)	(-)	(µs/cm)	(µs/cm)
B4-ST-3 (47-49')	20L164	42.1	80.7	38.8	84.3	8/25/2021	163	2.5E-08	2.5687	8.0	8.0	-	-	
						8/27/2021	165	2.5E-08	2.6071	-	-	-	-	
						8/30/2021	168	2.7E-08	2.6423	7.9	8.0	-	-	
						9/03/2021	172	2.5E-08	2.7066	8.1	8.1	571	696	
						9/07/2021	176	2.7E-08	2.7704	8.2	8.2	-	-	
						9/10/2021	179	2.6E-08	2.8255	8.4	8.2	-	-	
						9/14/2021	183	2.5E-08	2.8889	8.0	8.0	631	651	
						9/17/2021	186	2.4E-08	2.9386	-	-	-	-	
						9/20/2021	189	2.5E-08	2.9693	8.1	8.2	-	-	
						9/24/2021	193	2.6E-08	3.0364	8.0	8.0	-	-	
						9/28/2021	197	2.5E-08	3.0976	8.1	8.2	571	632	
						10/01/2021	200	2.4E-08	3.1463	-	-	-	-	
						10/07/2021	206	2.6E-08	3.2321	8.2	8.1	-	-	
						10/08/2021	207	2.6E-08	3.2511	-	-	-	-	
						10/12/2021	211	2.4E-08	3.3017	8.1	8.1	568	659	
						10/15/2021	214	2.4E-08	3.3497	-	-	-	-	
						10/18/2021	217	2.1E-08	3.3766	8.4	8.2	-	-	
						10/22/2021	221	2.4E-08	3.4364	-	-	-	-	
						10/26/2021	225	2.6E-08	3.5019	8.2	8.1	527	653	
10/29/2021	228	2.5E-08	3.5514	-	-	-	-							
11/01/2021	231	2.5E-08	3.5824	8.2	8.2	-	-							
11/05/2021	235	2.5E-08	3.6451	8.4	8.3	-	-							
11/09/2021	239	2.4E-08	3.7083	8.5	8.2	667	662							

3-29-2023
 Approved By: NSR

Notes: 1- Based on Specimen Initial Conditions. 2- Based on average of four readings.



Excel Geotechnical Testing, Inc.
"Excellence in Testing"

953 Forrest Street, Roswell, Georgia 30075
 Tel: (770) 910 7537, www.excelgeotesting.com

Test Results Summary (Page 4)

Compatibility Test Results

Project Name: Belle River ALD Support

Project No.: PN1017

Site ID	Lab No.	Test Information												Remarks
		Initial Conditions		Final Conditions		Date	Number of Days After Injection	Permeability	Pore Volumes Passed After Injection	pH		Electrical Conductivity		
		Moisture Content	Dry Unit Weight	Moisture Content	Dry Unit Weight					In Flow	Out Flow	In Flow	Out Flow	
(-)	(-)	(%)	(pcf)	(%)	(pcf)	(-)	(-)	(cm/s)	(-)	(-)	(-)	(-)	(µs/cm)	(µs/cm)
B4-ST-3 (47-49')	20L164	42.1	80.7	38.8	84.3	11/12/2021	242	2.4E-08	3.7578	-	-	-	-	
						11/16/2021	246	2.2E-08	3.7928	8.4	8.2	-	-	
						11/19/2021	249	2.7E-08	3.8436	-	-	-	-	
						11/21/2021	251	2.6E-08	3.8675	8.5	8.2	-	-	
						11/26/2021	256	2.5E-08	3.9386	-	-	-	-	
						11/30/2021	260	2.3E-08	3.9661	8.4	8.2	669	665	
						12/03/2021	263	2.5E-08	4.0184	-	-	-	-	
						12/07/2021	267	2.4E-08	4.0560	8.6	8.4	-	-	
						12/10/2021	270	2.4E-08	4.0703	-	-	-	-	
						12/14/2021	274	2.3E-08	4.1083	8.7	8.2	-	-	
						12/17/2021	277	2.5E-08	4.1600	-	-	-	-	
						12/20/2021	280	2.5E-08	4.1905	8.2	8.0	580	688	
						12/24/2021	284	2.5E-08	4.2524	-	-	-	-	
						12/28/2021	288	2.4E-08	4.2850	8.2	8.1	-	-	
						12/31/2021	291	2.5E-08	4.3382	-	-	-	-	
						01/03/2022	294	2.5E-08	4.3687	8.9	8.5	-	-	
						01/07/2022	298	2.5E-08	4.4328	8.3	7.8	645	689	
						1/12/2022	303	2.5E-08	4.5079	8.7	8.8	-	-	
						1/14/2022	305	2.5E-08	4.5459	-	-	-	-	
						1/18/2022	309	2.5E-08	4.5933	8.1	8.0	-	-	
1/22/2022	313	2.5E-08	4.6599	7.7	8.0	1072	668							
1/28/2022	319	2.4E-08	4.7378	7.9	7.9	-	-							
2/2/2022	324	2.3E-08	4.8125	9.0	8.6	-	-							

3-29-2023
 Approved By: NSR

Notes: 1- Based on Specimen Initial Conditions. 2- Based on average of four readings.



Excel Geotechnical Testing, Inc.
 "Excellence in Testing"

953 Forrest Street, Roswell, Georgia 30075
 Tel: (770) 910 7537, www.excelgeotesting.com

Test Results Summary (Page 5)

Compatibility Test Results

Project Name: Belle River ALD Support

Project No.: PN1017

Site ID	Lab No.	Test Information												Remarks
		Initial Conditions		Final Conditions		Date	Number of Days After Injection	Permeability	Pore Volumes Passed After Injection	pH		Electrical Conductivity		
		Moisture Content	Dry Unit Weight	Moisture Content	Dry Unit Weight					In Flow	Out Flow	In Flow	Out Flow	
(-)	(-)	(%)	(pcf)	(%)	(pcf)	(-)	(-)	(cm/s)	(-)	(-)	(-)	(-)	(µs/cm)	(µs/cm)
B4-ST-3 (47-49')	20L164	42.1	80.7	38.8	84.3	2/4/2022	326	2.4E-08	4.8490	-	-	-	-	
						2/7/2022	329	2.4E-08	4.8863	8.4	8.5	1148	672	
						2/11/2022	333	2.3E-08	4.9476	8.6	8.6	-	-	
						2/16/2022	338	2.4E-08	5.0232	8.2	8.3	-	-	
						2/18/2022	340	2.5E-08	5.0614	-	-	-	-	
						2/21/2022	343	2.5E-08	5.0994	8.3	8.6	1167	696	
						2/25/2022	347	2.6E-08	5.1632	8.9	8.6	-	-	
						3/3/2022	353	2.5E-08	5.2479	8.4	8.5	-	-	
						3/4/2022	354	2.5E-08	5.2686	-	-	-	-	
						3/7/2022	357	2.8E-08	5.3156	8.6	8.7	1167	697	
						3/11/2022	361	2.7E-08	5.3830	8.8	8.6	-	-	
						3/16/2022	366	2.4E-08	5.4466	8.8	8.8	-	-	
						3/18/2022	368	2.6E-08	5.4857	-	-	-	-	
						3/21/2022	371	2.4E-08	5.5222	8.8	8.6	1174	726	
						3/25/2022	375	2.8E-08	5.5901	8.7	8.8	-	-	
						3/29/2022	379	2.6E-08	5.6584	8.6	8.8	-	-	
						4/1/2022	382	2.7E-08	5.7124	8.2	8.7	1196	811	
						4/5/2022	386	2.6E-08	5.7786	7.9	8.6	1232	-	
4/8/2022	389	2.7E-08	5.8324	-	-	-	-							
4/9/2022	390	2.7E-08	5.8467	7.9	8.3	1228	-							
4/14/2022	395	2.6E-08	5.9226	8.1	8.2	1228	923							
4/15/2022	396	2.6E-08	5.9412	-	-	-	-							
4/20/2022	401	2.2E-08	6.0010	7.7	7.7	1246	-							

Notes: 1- Based on Specimen Initial Conditions. 2- Based on average of four readings.

3-29-2023
 Approved By: NSR



Excel Geotechnical Testing, Inc.
"Excellence in Testing"

953 Forrest Street, Roswell, Georgia 30075
Tel: (770) 910 7537, www.excelgeotesting.com

Test Results Summary (Page 6)

Compatibility Test Results

Project Name: Belle River ALD Support

Project No.: PN1017

Site ID	Lab No.	Test Information												Remarks
		Initial Conditions		Final Conditions		Date	Number of Days After Injection	Permeability	Pore Volumes Passed After Injection	pH		Electrical Conductivity		
		Moisture Content	Dry Unit Weight	Moisture Content	Dry Unit Weight					In Flow	Out Flow	In Flow	Out Flow	
(-)	(-)	(%)	(pcf)	(%)	(pcf)	(-)	(-)	(cm/s)	(-)	(-)	(-)	(-)	(µs/cm)	(µs/cm)
B4-ST-3 (47-49')	20L164	42.1	80.7	38.8	84.3	4/22/2022	403	2.0E-08	6.0228	-	-	-	-	
						4/27/2022	408	2.2E-08	6.0866	7.9	7.8	1228	-	
						4/29/2022	410	2.3E-08	6.1250	-	-	-	-	
						5/2/2022	413	2.6E-08	6.1651	7.8	8.0	1186	874	
						5/6/2022	417	2.7E-08	6.2322	8.0	8.0	1254	-	
						5/11/2022	422	2.6E-08	6.3207	7.9	8.0	1226	-	
						5/13/2022	424	2.6E-08	6.3694	-	-	-	-	
						5/17/2022	428	2.6E-08	6.4304	7.8	7.9	1214	871	
						5/20/2022	431	2.6E-08	6.4855	-	-	-	-	
						5/23/2022	434	2.5E-08	6.5173	8.1	8.1	1228	-	
						5/27/2022	438	2.8E-08	6.5863	7.9	8.0	1239	-	
						5/31/2022	442	2.6E-08	6.6531	8.0	8.0	1246	-	
						6/3/2022	445	2.7E-08	6.7084	-	-	-	-	
						6/4/2022	446	2.7E-08	6.7244	7.9	7.9	1282	-	
						6/9/2022	451	2.5E-08	6.7984	7.9	8.0	1228	-	
						6/10/2022	452	2.6E-08	6.8198	-	-	-	-	
						6/13/2022	455	2.8E-08	6.8685	8.3	8.2	1212	1296	
						6/17/2022	459	2.8E-08	6.9374	7.9	8.1	1251	-	
						6/21/2022	463	2.8E-08	7.0059	7.9	8.1	1259	-	
						6/24/2022	466	2.7E-08	7.0614	-	-	-	-	
6/27/2022	469	2.5E-08	7.0921	8.1	8.2	1229	1237							
7/1/2022	473	2.8E-08	7.1605	8.1	8.2	1222	-							
7/5/2022	477	3.0E-08	7.2337	8.0	8.2	1215	-							

3-29-2023
Approved By: NSR

Notes: 1- Based on Specimen Initial Conditions. 2- Based on average of four readings.



Excel Geotechnical Testing, Inc.
 "Excellence in Testing"

953 Forrest Street, Roswell, Georgia 30075
 Tel: (770) 910 7537, www.excelgeotesting.com

Test Results Summary (Page 7)

Compatibility Test Results

Project Name: Belle River ALD Support

Project No.: PN1017

Site ID	Lab No.	Test Information												Remarks
		Initial Conditions		Final Conditions		Date	Number of Days After Injection	Permeability	Pore Volumes Passed After Injection	pH		Electrical Conductivity		
		Moisture Content	Dry Unit Weight	Moisture Content	Dry Unit Weight					In Flow	Out Flow	In Flow	Out Flow	
(-)	(-)	(%)	(pcf)	(%)	(pcf)	(-)	(-)	(cm/s)	(-)	(-)	(-)	(-)	(µs/cm)	(µs/cm)
B4-ST-3 (47-49')	20L164	42.1	80.7	38.8	84.3	7/8/2022	480	2.8E-08	7.2913	-	-	-	-	
						7/11/2022	483	2.6E-08	7.3233	8.1	8.2	1203	938	
						7/15/2022	487	2.8E-08	7.3925	8.3	8.3	1242	-	
						7/19/2022	491	2.8E-08	7.4631	8.0	8.0	1228	-	
						7/22/2022	494	2.8E-08	7.5214	-	-	-	-	
						7/25/2022	497	2.8E-08	7.5536	8.1	8.2	1176	1521	
						7/28/2022	500	2.7E-08	7.6087	8.1	8.2	1187	-	
						7/29/2022	501	2.8E-08	7.6296	-	-	-	-	
						8/1/2022	504	2.8E-08	7.6770	8.2	8.3	1266	-	
						8/5/2022	508	2.8E-08	7.7479	7.9	8.0	1174	1637	
						8/9/2022	512	2.7E-08	7.8162	8.3	8.5	1245	-	
						8/12/2022	515	2.8E-08	7.8744	-	-	-	-	
						8/15/2022	518	2.7E-08	7.9059	8.1	8.2	1223	-	
						8/19/2022	522	2.7E-08	7.9746	8.2	8.3	1230	987	
						8/23/2022	526	2.8E-08	8.0433	8.1	8.2	1213	-	
						8/26/2022	529	2.7E-08	8.0997	8.3	8.3	1276	-	
						8/30/2022	533	2.8E-08	8.1695	7.9	8.0	1192	1371	
						9/2/2022	536	2.8E-08	8.2265	8.1	8.1	1228	-	
9/6/2022	540	2.7E-08	8.2946	8.3	8.3	1275	-							
9/9/2022	543	2.7E-08	8.3511	8.3	8.4	1208	977							
9/13/2022	547	2.4E-08	8.4179	8.1	8.2	1218	-							
9/16/2022	550	2.7E-08	8.4749	8.2	8.2	1204	-							
9/20/2022	554	2.6E-08	8.5417	8.3	8.3	1222	1156							

Notes: 1- Based on Specimen Initial Conditions. 2- Based on average of four readings.

3-29-2023
 Approved By: NSR



Excel Geotechnical Testing, Inc.
 "Excellence in Testing"

953 Forrest Street, Roswell, Georgia 30075
 Tel: (770) 910 7537, www.excelgeotesting.com

Test Results Summary (Page 8)

Compatibility Test Results

Project Name: Belle River ALD Support

Project No.: PN1017

Site ID	Lab No.	Test Information												Remarks
		Initial Conditions		Final Conditions		Date	Number of Days After Injection	Permeability	Pore Volumes Passed After Injection	pH		Electrical Conductivity		
		Moisture Content	Dry Unit Weight	Moisture Content	Dry Unit Weight					In Flow	Out Flow	In Flow	Out Flow	
(-)	(-)	(%)	(pcf)	(%)	(pcf)	(-)	(-)	(cm/s)	(-)	(-)	(-)	(-)	(µs/cm)	(µs/cm)
B4-ST-3 (47-49')	20L164	42.1	80.7	38.8	84.3	9/23/2022	557	2.6E-08	8.5957	-	-	-	-	
						9/26/2022	560	2.7E-08	8.6288	8.2	8.1	1201	-	
						9/30/2022	564	2.7E-08	8.6993	8.3	8.2	1118	-	
						10/5/2022	569	2.6E-08	8.7768	8.2	8.2	1143	973	
						10/7/2022	571	2.6E-08	8.8152	-	-	-	-	
						10/14/2022	578	2.7E-08	8.9223	-	-	-	-	
						10/19/2022	583	2.4E-08	8.9966	8.2	8.3	1172	1000	
						10/21/2022	585	2.4E-08	9.0314	-	-	-	-	
						10/28/2022	592	2.4E-08	9.1356	-	-	-	-	
						11/1/2022	596	2.5E-08	9.2011	8.4	8.4	1214	1062	
						11/4/2022	599	2.6E-08	9.2557	-	-	-	-	
						11/11/2022	606	2.6E-08	9.3554	-	-	-	-	
						11/18/2022	613	2.2E-08	9.4592	8.0	8.1	1283	1042	
						11/25/2022	620	2.3E-08	9.5448	-	-	-	-	
						12/2/2022	627	2.1E-08	9.6363	-	-	-	-	
						12/9/2022	634	2.2E-08	9.7330	-	-	-	-	
						12/13/2022	638	2.1E-08	9.7763	-	-	-	-	
12/16/2022	641	2.1E-08	9.8143	-	-	-	-							
12/20/2022	645	1.9E-08	9.8368	8.5	8.5	1243	1090							
12/23/2022	648	2.1E-08	9.8920	-	-	-	-							
12/31/2022	656	2.1E-08	10.0045	-	-	-	-							

3-29-2023
 Approved By: NSR

Notes: 1- Based on Specimen Initial Conditions. 2- Based on average of four readings.



Excel Geotechnical Testing, Inc.
 "Excellence in Testing"

953 Forrest Street, Roswell, Georgia 30075
 Tel: (770) 910 7537, www.excelgeotesting.com

Test Results Summary (Page 1)

Compatibility Test Results

Project Name: Belle River ALD Support

Project No.: PN1017

Site ID	Lab No.	Test Information												Remarks
		Initial Conditions		Final Conditions		Date	Number of Days After Injection	Permeability	Pore Volumes Passed After Injection	pH		Electrical Conductivity		
		Moisture Content	Dry Unit Weight	Moisture Content	Dry Unit Weight					In Flow	Out Flow	In Flow	Out Flow	
(-)	(-)	(%)	(pcf)	(%)	(pcf)	(-)	(-)	(cm/s)	(-)	(-)	(-)	(-)	(µs/cm)	(µs/cm)
B5-ST-5 (87-89')	20L172	21.6	107.5	20.1	110.9	3/15/2021	0	1.7E-08	0.0000	-	-	-	-	
						3/22/2021	7	1.6E-08	0.0979	8.4	8.0	-	-	
						3/29/2021	14	1.4E-08	0.1870	-	-	-	-	
						3/30/2021	15	1.4E-08	0.1939	8.4	8.3	-	-	
						4/02/2021	18	1.5E-08	0.2308	8.5	8.4	605	2010	
						4/05/2021	21	1.6E-08	0.2786	-	-	-	-	
						4/09/2021	25	1.5E-08	0.3212	7.9	8.0	-	-	
						4/12/2021	28	1.6E-08	0.3695	-	-	-	-	
						4/16/2021	32	1.5E-08	0.4124	8.6	8.5	-	-	
						4/19/2021	35	1.6E-08	0.4650	-	-	-	-	
						4/23/2021	39	1.3E-08	0.5034	8.5	8.3	676	1372	
						4/26/2021	42	1.1E-08	0.5235	-	-	-	-	
						5/05/2021	51	7.7E-09	0.5955	8.5	8.2	-	-	
						5/07/2021	53	1.2E-08	0.6300	-	-	-	-	
						5/12/2021	58	1.5E-08	0.6886	8.5	8.3	-	-	
						5/14/2021	60	1.6E-08	0.7225	-	-	-	-	
						5/18/2021	64	1.6E-08	0.7744	8.3	8.2	697	1569	
						5/21/2021	67	1.4E-08	0.8261	-	-	-	-	
5/24/2021	70	1.3E-08	0.8612	8.4	8.3	-	-							
5/28/2021	74	1.8E-08	0.9284	8.5	8.1	-	-							
6/04/2021	81	1.5E-08	1.0236	8.3	8.2	760	1192							
6/11/2021	88	1.6E-08	1.1178	8.2	8.5	-	-							
6/18/2021	95	1.5E-08	1.2151	8.1	8.4	-	-							

3-29-2023
 Approved By: NSR

Notes: 1- Based on Specimen Final Conditions. 2- Based on average of four readings.



Excel Geotechnical Testing, Inc.
 "Excellence in Testing"

953 Forrest Street, Roswell, Georgia 30075
 Tel: (770) 910 7537, www.excelgeotesting.com

Test Results Summary (Page 2)

Compatibility Test Results

Project Name: Belle River ALD Support

Project No.: PN1017

Site ID	Lab No.	Test Information												Remarks
		Initial Conditions		Final Conditions		Date	Number of Days After Injection	Permeability	Pore Volumes Passed After Injection	pH		Electrical Conductivity		
		Moisture Content	Dry Unit Weight	Moisture Content	Dry Unit Weight					In Flow	Out Flow	In Flow	Out Flow	
(-)	(-)	(%)	(pcf)	(%)	(pcf)	(-)	(-)	(cm/s)	(-)	(-)	(-)	(-)	(µs/cm)	(µs/cm)
B5-ST-5 (87-89')	20L172	21.6	107.5	20.1	110.9	6/24/2021	101	1.6E-08	1.3021	8.6	8.0	679	1067	
						6/25/2021	102	1.6E-08	1.3213	-	-	-	-	
						6/29/2021	106	1.6E-08	1.3805	8.3	8.0	-	-	
						7/02/2021	109	1.6E-08	1.4321	-	-	-	-	
						7/06/2021	113	1.6E-08	1.4840	8.6	8.1	-	-	
						7/09/2021	116	1.5E-08	1.5320	-	-	-	-	
						7/13/2021	120	1.5E-08	1.5750	8.3	8.3	598	1134	
						7/16/2021	123	1.6E-08	1.6254	-	-	-	-	
						7/21/2021	128	1.4E-08	1.6776	8.2	8.1	-	-	
						7/23/2021	130	1.5E-08	1.7109	-	-	-	-	
						7/28/2021	135	1.5E-08	1.7692	8.1	8.1	-	-	
						7/30/2021	137	1.3E-08	1.7980	-	-	-	-	
						8/06/2021	144	1.3E-08	1.8751	8.6	8.4	733	1040	
						8/13/2021	151	1.4E-08	1.9154	8.1	8.1	-	-	
						8/20/2021	158	1.4E-08	2.0174	8.2	8.1	-	-	
						8/26/2021	164	1.4E-08	2.1000	8.5	8.1	695	1100	
						8/27/2021	165	1.4E-08	2.1204	-	-	-	-	
						9/01/2021	170	1.5E-08	2.1843	8.1	8.2	-	-	
9/03/2021	172	1.4E-08	2.2170	-	-	-	-							
9/08/2021	177	1.4E-08	2.2738	8.1	8.1	-	-							
9/10/2021	179	1.4E-08	2.3071	-	-	-	-							
9/14/2021	183	1.4E-08	2.3527	8.2	8.1	569	832							
9/17/2021	186	1.4E-08	2.3959	-	-	-	-							

3-29-2023
 Approved By: NSR

Notes: 1- Based on Specimen Initial Conditions. 2- Based on average of four readings.



Excel Geotechnical Testing, Inc.
 "Excellence in Testing"

953 Forrest Street, Roswell, Georgia 30075
 Tel: (770) 910 7537, www.excelgeotesting.com

Test Results Summary (Page 3)

Compatibility Test Results

Project Name: Belle River ALD Support

Project No.: PN1017

Site ID	Lab No.	Test Information												Remarks
		Initial Conditions		Final Conditions		Date	Number of Days After Injection	Permeability	Pore Volumes Passed After Injection	pH		Electrical Conductivity		
		Moisture Content	Dry Unit Weight	Moisture Content	Dry Unit Weight					In Flow	Out Flow	In Flow	Out Flow	
(-)	(-)	(%)	(pcf)	(%)	(pcf)	(-)	(-)	(cm/s)	(-)	(-)	(-)	(-)	(µs/cm)	(µs/cm)
B5-ST-5 (87-89')	20L172	21.6	107.5	20.1	110.9	9/21/2021	190	1.5E-08	2.4412	8.1	8.1	-	-	
						9/24/2021	193	1.5E-08	2.4917	-	-	-	-	
						9/28/2021	197	1.4E-08	2.5334	8.2	8.1	-	-	
						10/01/2021	200	1.4E-08	2.5769	-	-	-	-	
						10/05/2021	204	1.5E-08	2.6225	8.1	8.1	555	771	
						10/08/2021	207	1.5E-08	2.6685	-	-	-	-	
						10/14/2021	213	1.3E-08	2.7240	8.0	8.1	-	-	
						10/15/2021	214	1.4E-08	2.7402	-	-	-	-	
						10/22/2021	221	1.2E-08	2.8132	8.5	8.1	-	-	
						10/28/2021	227	1.4E-08	2.8936	8.0	8.0	578	725	
						10/29/2021	228	1.4E-08	2.9101	-	-	-	-	
						11/04/2021	234	1.4E-08	2.9821	8.2	8.1	-	-	
						11/05/2021	235	1.4E-08	2.9999	-	-	-	-	
						11/12/2021	242	1.2E-08	3.0737	8.3	8.3	-	-	
						11/19/2021	249	1.5E-08	3.1592	8.5	8.4	625	720	
						11/26/2021	256	1.1E-08	3.2346	-	-	-	-	
						12/02/2021	262	9.3E-09	3.2661	8.4	8.2	-	-	
						12/03/2021	263	1.1E-08	3.2826	-	-	-	-	
						12/08/2021	268	1.4E-08	3.3435	8.6	8.1	-	-	
						12/10/2021	270	1.3E-08	3.3706	-	-	-	-	
12/14/2021	274	1.4E-08	3.4204	8.0	8.0	626	655							
12/17/2021	277	1.4E-08	3.4663	-	-	-	-							
1/0/1900	280	1.5E-08	3.5011	8.1	8.0	-	-							

3-29-2023
 Approved By: NSR

Notes: 1- Based on Specimen Initial Conditions. 2- Based on average of four readings.



Excel Geotechnical Testing, Inc.
 "Excellence in Testing"

953 Forrest Street, Roswell, Georgia 30075
 Tel: (770) 910 7537, www.excelgeotesting.com

Test Results Summary (Page 4)

Compatibility Test Results

Project Name: Belle River ALD Support

Project No.: PN1017

Site ID	Lab No.	Test Information												Remarks
		Initial Conditions		Final Conditions		Date	Number of Days After Injection	Permeability	Pore Volumes Passed After Injection	pH		Electrical Conductivity		
		Moisture Content	Dry Unit Weight	Moisture Content	Dry Unit Weight					In Flow	Out Flow	In Flow	Out Flow	
(-)	(-)	(%)	(pcf)	(%)	(pcf)	(-)	(-)	(cm/s)	(-)	(-)	(-)	(-)	(µs/cm)	(µs/cm)
B5-ST-5 (87-89')	20L172	21.6	107.5	20.1	110.9	12/24/2021	284	1.4E-08	3.5588	-	-	-	-	
						12/28/2021	288	1.4E-08	3.5990	8.3	8.1	-	-	
						12/31/2021	291	1.5E-08	3.6488	-	-	-	-	
						1/3/2022	294	1.5E-08	3.6845	8.3	8.2	623	693	
						1/7/2022	298	1.4E-08	3.7440	-	-	-	-	
						1/11/2022	302	1.3E-08	3.7812	8.9	8.6	-	-	
						1/14/2022	305	1.5E-08	3.8292	-	-	-	-	
						1/18/2022	309	1.4E-08	3.8721	8.9	8.2	-	-	
						1/21/2022	312	1.4E-08	3.9238	-	-	-	-	
						1/26/2022	317	1.3E-08	3.9709	8.0	8.1	1120	720	
						2/2/2022	324	1.3E-08	4.0573	8.6	8.5	-	-	
						2/4/2022	326	1.4E-08	4.0895	-	-	-	-	
						2/9/2022	331	1.3E-08	4.1462	8.2	8.4	1149	-	
						2/11/2022	333	1.3E-08	4.1762	-	-	-	-	
						2/16/2022	338	1.3E-08	4.2338	8.1	8.7	1192	715	
						2/18/2022	340	1.4E-08	4.2678	-	-	-	-	
						2/23/2022	345	1.4E-08	4.3260	8.7	8.3	-	-	
						2/25/2022	347	1.4E-08	4.3599	-	-	-	-	
						3/3/2022	353	1.3E-08	4.4259	8.3	8.4	-	-	
						3/4/2022	354	1.4E-08	4.4428	-	-	-	-	
3/10/2022	360	1.5E-08	4.5205	8.8	9.1	1204	690							
3/11/2022	361	1.5E-08	4.5388	-	-	-	-							
1/0/1900	368	1.3E-08	4.6205	8.5	9.2	1186	-							

3-29-2023
 Approved By: NSR

Notes: 1- Based on Specimen Initial Conditions. 2- Based on average of four readings.



Excel Geotechnical Testing, Inc.
 "Excellence in Testing"

953 Forrest Street, Roswell, Georgia 30075
 Tel: (770) 910 7537, www.excelgeotesting.com

Test Results Summary (Page 5)

Compatibility Test Results

Project Name: Belle River ALD Support

Project No.: PN1017

Site ID	Lab No.	Test Information												Remarks
		Initial Conditions		Final Conditions		Date	Number of Days After Injection	Permeability	Pore Volumes Passed After Injection	pH		Electrical Conductivity		
		Moisture Content	Dry Unit Weight	Moisture Content	Dry Unit Weight					In Flow	Out Flow	In Flow	Out Flow	
(-)	(-)	(%)	(pcf)	(%)	(pcf)	(-)	(-)	(cm/s)	(-)	(-)	(-)	(-)	(µs/cm)	(µs/cm)
B5-ST-5 (87-89')	20L172	21.6	107.5	20.1	110.9	3/25/2022	375	1.5E-08	4.7141	7.6	8.4	-	-	
						4/1/2022	382	1.4E-08	4.8069	7.8	8.1	1223	685	
						4/8/2022	389	1.4E-08	4.9002	8.1	8.4	1227	-	
						4/15/2022	396	1.5E-08	4.9936	8.0	8.2	1242	-	
						4/22/2022	403	1.3E-08	5.0797	-	-	-	-	
						4/24/2022	405	1.3E-08	5.0977	7.7	7.9	1224	731	
						4/29/2022	410	1.4E-08	5.1686	-	-	-	-	
						5/2/2022	413	1.4E-08	5.1974	7.9	7.7	1206	-	
						5/6/2022	417	1.5E-08	5.2595	-	-	-	-	
						5/9/2022	420	1.4E-08	5.2913	8.0	8.0	1218	-	
						5/13/2022	424	1.6E-08	5.3559	-	-	-	-	
						5/16/2022	427	1.5E-08	5.3892	7.9	8.0	1246	754	
						5/20/2022	431	1.5E-08	5.4522	-	-	-	-	
						5/23/2022	434	1.4E-08	5.4840	7.9	8.0	1260	-	
						5/27/2022	438	1.5E-08	5.5468	-	-	-	-	
						5/31/2022	442	1.3E-08	5.5849	7.8	7.9	1244	-	
						6/3/2022	445	1.4E-08	5.6347	-	-	-	-	
						6/7/2022	449	1.4E-08	5.6785	7.9	8.1	1250	-	
						6/10/2022	452	1.5E-08	5.7287	-	-	-	-	
6/14/2022	456	1.5E-08	5.7743	8.3	8.2	1286	-							
6/17/2022	459	1.6E-08	5.8244	-	-	-	-							
6/21/2022	463	1.4E-08	5.8685	7.9	8.1	1213	-							
1/0/1900	466	1.5E-08	5.9184	-	-	-	-							

3-29-2023
 Approved By: NSR

Notes: 1- Based on Specimen Initial Conditions. 2- Based on average of four readings.



Excel Geotechnical Testing, Inc.
 "Excellence in Testing"

953 Forrest Street, Roswell, Georgia 30075
 Tel: (770) 910 7537, www.excelgeotesting.com

Test Results Summary (Page 6)

Compatibility Test Results

Project Name: Belle River ALD Support

Project No.: PN1017

Site ID	Lab No.	Test Information												Remarks
		Initial Conditions		Final Conditions		Date	Number of Days After Injection	Permeability	Pore Volumes Passed After Injection	pH		Electrical Conductivity		
		Moisture Content	Dry Unit Weight	Moisture Content	Dry Unit Weight					In Flow	Out Flow	In Flow	Out Flow	
(-)	(-)	(%)	(pcf)	(%)	(pcf)	(-)	(-)	(cm/s)	(-)	(-)	(-)	(-)	(µs/cm)	(µs/cm)
B5-ST-5 (87-89')	20L172	21.6	107.5	20.1	110.9	6/29/2022	471	1.4E-08	5.9709	8.2	8.2	1231	782	
						7/1/2022	473	1.5E-08	6.0063	-	-	-	-	
						7/6/2022	478	1.5E-08	6.0694	7.9	8.1	1241	-	
						7/8/2022	480	1.5E-08	6.1057	-	-	-	-	
						7/13/2022	485	1.4E-08	6.1651	8.0	8.1	1271	-	
						7/15/2022	487	1.4E-08	6.1651	-	-	-	-	
						7/22/2022	494	1.6E-08	6.3104	-	-	-	-	
						7/27/2022	499	1.4E-08	6.3650	8.9	8.2	1178	1219	
						7/29/2022	501	1.5E-08	6.4016	-	-	-	-	
						8/3/2022	506	1.4E-08	6.4599	8.0	8.1	1218	-	
						8/5/2022	508	1.5E-08	6.4953	-	-	-	-	
						8/10/2022	513	1.4E-08	6.5550	8.3	8.2	1291	-	
						8/12/2022	515	1.5E-08	6.5901	-	-	-	-	
						8/16/2022	519	1.5E-08	6.6409	7.8	7.9	1215	1021	
						8/19/2022	522	1.5E-08	6.6928	-	-	-	-	
						8/23/2022	526	1.4E-08	6.7393	8.0	8.1	1199	-	
						8/26/2022	529	1.5E-08	6.7931	-	-	-	-	
						8/30/2022	533	1.4E-08	6.8354	8.0	8.1	1246	-	
9/1/2022	535	1.5E-08	6.8882	-	-	-	-							
9/6/2022	540	1.4E-08	6.9314	8.4	8.2	1198	768							
9/9/2022	543	1.4E-08	6.9801	-	-	-	-							
9/12/2022	546	1.4E-08	7.0155	8.0	8.1	1112	-							
9/16/2022	550	1.5E-08	7.0797	-	-	-	-							

3-29-2023
 Approved By: NSR

Notes: 1- Based on Specimen Initial Conditions. 2- Based on average of four readings.



Excel Geotechnical Testing, Inc.
 "Excellence in Testing"

953 Forrest Street, Roswell, Georgia 30075
 Tel: (770) 910 7537, www.excelgeotesting.com

Test Results Summary (Page 7)

Compatibility Test Results

Project Name: Belle River ALD Support

Project No.: PN1017

Site ID	Lab No.	Test Information												Remarks
		Initial Conditions		Final Conditions		Date	Number of Days After Injection	Permeability	Pore Volumes Passed After Injection	pH		Electrical Conductivity		
		Moisture Content	Dry Unit Weight	Moisture Content	Dry Unit Weight					In Flow	Out Flow	In Flow	Out Flow	
(-)	(-)	(%)	(pcf)	(%)	(pcf)	(-)	(-)	(cm/s)	(-)	(-)	(-)	(-)	(µs/cm)	(µs/cm)
B5-ST-5 (87-89')	20L172	21.6	107.5	20.1	110.9	9/19/2022	553	1.4E-08	7.1115	8.3	8.2	1213	-	
						9/23/2022	557	1.6E-08	7.1767	-	-	-	-	
						9/26/2022	560	1.5E-08	7.2082	8.2	8.2	1210	777	
						9/30/2022	564	1.5E-08	7.2718	-	-	-	-	
						10/3/2022	567	1.4E-08	7.3024	8.3	8.2	1218	-	
						10/7/2022	571	1.5E-08	7.3643	-	-	-	-	
						10/11/2022	575	1.3E-08	7.4012	8.8	8.3	1210	-	
						10/14/2022	578	1.4E-08	7.4510	-	-	-	-	
						10/19/2022	583	1.3E-08	7.5011	8.4	8.3	1200	755	
						10/21/2022	585	1.3E-08	7.5309	-	-	-	-	
						10/27/2022	591	1.3E-08	7.5975	8.6	8.4	1250	-	
						10/28/2022	592	1.3E-08	7.6149	-	-	-	-	
						11/3/2022	598	1.3E-08	7.6878	8.4	8.2	1193	-	
						11/4/2022	599	1.4E-08	7.7056	-	-	-	-	
						11/11/2022	606	1.4E-08	7.7986	8.0	8.0	1210	777	
						11/18/2022	613	1.1E-08	7.8742	8.4	8.3	1248	-	
						11/25/2022	620	1.3E-08	7.9526	-	-	-	-	
						11/30/2022	625	1.3E-08	8.0135	8.4	8.8	1203	-	
12/2/2022	627	1.2E-08	8.0318	-	-	-	-							
12/5/2022	630	1.2E-08	8.0552	8.5	8.5	1155	804							
12/9/2022	634	1.3E-08	8.1093	-	-	-	-							
12/13/2022	638	1.1E-08	8.1426	8.5	8.7	1204	-							
12/16/2022	641	1.2E-08	8.1834	-	-	-	-							

3-29-2023
 Approved By: NSR

Notes: 1- Based on Specimen Initial Conditions. 2- Based on average of four readings.



Excel Geotechnical Testing, Inc.
 "Excellence in Testing"

953 Forrest Street, Roswell, Georgia 30075
 Tel: (770) 910 7537, www.excelgeotesting.com

Test Results Summary (Page 8)

Compatibility Test Results

Project Name: Belle River ALD Support

Project No.: PN1017

Site ID	Lab No.	Test Information												Remarks	
		Initial Conditions		Final Conditions		Date	Number of Days After Injection	Permeability	Pore Volumes Passed After Injection	pH		Electrical Conductivity			
		Moisture Content	Dry Unit Weight	Moisture Content	Dry Unit Weight					In Flow	Out Flow	In Flow	Out Flow		
(-)	(-)	(%)	(pcf)	(%)	(pcf)	(-)	(-)	(cm/s)	(-)	(-)	(-)	(-)	(µs/cm)	(µs/cm)	
B5-ST-5 (87-89')	20L172	21.6	107.5	20.1	110.9	12/22/2022	647	9.4E-09	8.2299	8.7	8.4	1244	-		
						12/23/2022	648	1.0E-08	8.2456	-	-	-	-		
						12/31/2022	656	9.7E-09	8.3209	-	-	-	-		

3-29-2023
 Approved By: NSR

Notes: 1- Based on Specimen Initial Conditions. 2- Based on average of four readings.

**APPENDIX L – GROUNDWATER PROTECTION
STANDARD CALCULATIONS**

Technical Memorandum

Date: November 24, 2021

To: Chris Scieszka, DTE Electric Company

From: Vince Buening, TRC
Sarah Holmstrom, TRC
Kristin Lowery, TRC

Project No.: 413591.0003.0000 Phase 1 Task 1

Subject: Groundwater Protection Standard Calculation – DTE Electric Company, Belle River Power Plant Diversion Basin

DTE Electric Company (DTE Electric) is pursuing an Alternate Liner Demonstration (ALD) for the Belle River Power Plant (BRPP) Diversion Basin (DB) coal combustion residual (CCR) unit. On November 12, 2020, the U.S. EPA published the Part B: Alternate Demonstration for Unlined Surface Impoundments amendments to the CCR Rule¹ (“Part B”) that allows a facility to prepare demonstration to request approval to operate an existing CCR surface impoundment with an alternate liner. Although the BRPP DB remains in detection monitoring, per § 257.71(d)(1)(ii)(C)(2), the ALD must demonstrate that, for each Appendix IV constituent, there is no reasonable probability that the peak groundwater concentration that may result from releases that occur over the active life of the CCR surface impoundment will exceed the groundwater protection standard (GWPS) at the waste boundary.

GWPSs are set as either specific regulatory standards identified in the CCR Rule or background groundwater concentrations, whichever is higher, for the Appendix IV constituents. Per the CCR Rule §257.95(h)², the EPA maximum contaminant levels (MCLs) will be the GWPSs for those constituents that have established MCLs. For Appendix IV constituents that do not have established MCLs, the GWPSs are based upon the EPA Regional Screening Levels (RSLs). For constituents that have statistically derived background levels higher than the MCL and/or RSL, the GWPS becomes equal to the background level.

This memorandum presents the background statistical limits and GWPS derived for the Appendix IV parameters for the BRPP DB CCR unit using the aforementioned approach pursuant to §257.95(h). Per 40 CFR §257.94, a minimum of eight rounds of background sampling for the Appendix IV constituents were completed at the BRPP DB from August 2016 through September 2017, as part of initiating the

¹ On April 17, 2015, the U.S. EPA issued the Final Rule: Disposal of CCR from Electric Utilities (CCR Rule), 40 CFR 257, Subpart D, to regulate the disposal of CCR materials generated at coal-fired units.

² As amended per Phase One, Part One of the CCR Rule (83 FR 36435).

Technical Memorandum

detection monitoring program. Since fluoride is in both the Appendix III and Appendix IV constituent lists, additional fluoride data were collected under the detection monitoring program subsequent to September 2017 and were also used in the development of the GWPS. All of the Appendix IV data used in this analysis (August 2016 through December 2020) and details on how the data were collected are included in the annual reports prepared in accordance with the CCR Rule through January 2021.

The background data for the BRPP DB were evaluated in accordance with the *Groundwater Statistical Evaluation Plan (Stats Plan)* (TRC, October 2017). Per the Stats Plan, the BRPP DB CCR unit uses an intra-well statistical approach. For intra-well methods, the background data set is comprised of the historical data established at each individual monitoring well, which accounts for natural spatial variability that occurs in background encountered across the site. Background data were evaluated utilizing ChemStat™ statistical software. ChemStat™ is a software tool that is commercially available for performing statistical evaluation consistent with procedures outlined in U.S. EPA's *Statistical Analysis of Groundwater Monitoring Data at RCRA Facilities* (Unified Guidance; UG). Within the ChemStat™ statistical program (and the UG), tolerance limits were selected to perform the statistical calculation for background limits. Use of tolerance limits is a streamlined approach that offers adequate statistical power and is an acceptable approach under the CCR Rule. As such, upper tolerance limits (UTLs) were calculated for each of the CCR Appendix IV parameters, and, given that intra-well methods have been established for this site, a background UTL was calculated for each monitoring well and used to compare to the respective MCL or RSL. The following narrative describes the methods employed and the results obtained for the UTL calculations and the resulting GWPSs. The ChemStat™ output files are included as an attachment.

The set of background wells utilized for BRPP DB includes MW-16-05, MW-16-06, MW-16-07, MW-16-08, MW-16-10, and MW-16-11/A³. The background data evaluation included the following steps:

- Review of data quality checklists for the baseline/background data sets for CCR Appendix IV constituents;
- Graphical representation of the baseline data as time versus concentration (T v. C) by well/constituent pair;
- Outlier testing of individual data points that appear from the graphical representations as potential outliers;
- Evaluation of percentage of non-detects for each baseline/background well-constituent (w/c) pair;
- Distribution of the data;
- Calculation of the UTLs for each cumulative baseline/background data set; and
- Establishment of GWPS as the higher of the MCL/RSL or the UTL for each Appendix IV constituent.

The results of these evaluations are presented and discussed below.

³ Monitoring well MW-16-11 was decommissioned and replaced by monitoring well MW-16-11A in May 2017 to repair a damaged casing. For the purposes of statistical evaluation, the data sets for the original and replacement well have been combined and referred to as "MW-16-11A"

Technical Memorandum

Data Quality

Data from each sampling round were evaluated for completeness, overall quality and usability, method-specified sample holding times, precision and accuracy, and potential sample contamination. The review was completed using the following quality control (QC) information which at a minimum included chain-of-custody forms, investigative sample results including blind field duplicates, and, as provided by the laboratory, method blanks, laboratory control spikes, laboratory duplicates. The data were found to be complete and usable for the purposes of the CCR monitoring program.

Time versus Concentration Graphs

The time versus concentration (T v. C) graphs (Attachment A) indicated potential or suspect outliers for arsenic, chromium, cobalt, and lead at MW-16-07 on 8/3/2016, radium 226/228 at MW-16-11A on 8/2/2016, and chromium, cobalt, and lead at MW-16-11A on 9/22/2016. In addition, multiple sampling events were performed within a two to three-week timeframe during the background data collection in order to verify results and/or collect an adequate number of data points within the constraints of the limited CCR Rule implementation timeline. In order to maximize temporal independence within the background data set, several data points were removed from the MW-16-10 and MW-16-11A data sets as noted on Table 1. Data for the additional sampling events conducted in August 2017 for MW-16-10 were similar to the July and September results. Data for the additional sampling event conducted in June 2017 for MW-16-11A were similar to the May and July results. Thus, the June 2017 and August 2017 data were removed to avoid potential biasing of the two data sets for that time-frame.

While variations in results are present, the graphs show consistent baseline data and do not suggest that data sets, as a whole, likely have overall trending or seasonality. However, due to limitations on CCR Rule implementation timelines, the data sets, with the exception of fluoride, are of relatively short duration for making such observations regarding overall trending or seasonality.

Outlier Testing

Outlier removal from the background data set is summarized in Table 1. Probability plots of data residuals (Attachment A) were used to further evaluate the potential outliers for MW-16-07 that were identified in the T v. C graphs. In general, probability plots of the data residuals for MW-16-07 show that arsenic, chromium, cobalt, and lead data collected on 8/3/2016 were from a different distribution than the remaining data. Prior to outlier removal, many of the parameters exhibited a non-normal distribution. Subsequent to outlier removal, the data sets for the majority of the parameters exhibited a normal distribution. As such, data collected from monitoring well MW-16-07 on 8/3/2016 were removed from the data set.

After the removal of the data collected on 6/6/2017 from the background data set for MW-16-11A, probability plots of the data residuals for MW-16-11A show the radium 226/228 data collected on 8/2/2016, and the chromium, cobalt, and lead data collected on 9/22/2016 were from a different distribution than the remaining data. Prior to outlier removal, many of the parameters exhibited a non-normal distribution. Subsequent to outlier removal, the data sets for the majority of the parameters exhibited a normal distribution. As such, these data points were removed from the data set.

Technical Memorandum

Distribution of the Data Sets

ChemStat™ was utilized to evaluate each data set for normality. If the skewness coefficient was calculated to be between negative one and one, then the data were assumed to be approximately normally distributed. If the skewness coefficient was calculated as greater than one (or less than negative one) then the calculation was performed on the natural log (Ln) of the data. If the Ln of the data still determined that the data appeared to be skewed, then the Shapiro-Wilk test of normality (Shapiro-Wilk) was performed. The Shapiro-Wilk statistic was calculated on both non-transformed data and the Ln-transformed data. If the Shapiro-Wilk statistic indicated that normal distributional assumptions were not valid, then the parameter was considered a candidate for non-parametric statistical evaluation. The data distributions are summarized in Table 2.

Tolerance Limits

Table 2 presents the calculated UTLs for the background/baseline data sets. As discussed above, the BRPP DB CCR unit uses intra-well statistical methods; therefore, UTLs were calculated for each individual monitoring well. For normal and lognormal distributions, UTLs are calculated for 95 percent confidence using parametric methods. For nonnormal background datasets, a nonparametric UTL is utilized, resulting in the highest value from the background dataset as the UTL. The achieved confidence levels for nonparametric tolerance limits depend entirely on the number of background data points, which are shown in the ChemStat™ outputs. The intra-well tolerance limits for each parameter were compared to the MCL/RSL and the higher value was established as the GWPS for that well.

Groundwater Protection Standards

The resulting GWPSs were established as the higher of the MCL/RSL or the UTL for each Appendix IV constituent at each monitoring well. The GWPSs are summarized in Table 3.

Attachments

Table 1 – Summary of Outlier Evaluation and Data Removal

Table 2 – Summary of Descriptive Statistics and Tolerance Limit Calculations

Table 3 – Summary of Groundwater Protection Standards

Attachment A – ChemStat™ Outputs

Technical Memorandum

Tables

Table 1
 Summary of Outlier Evaluation and Data Removal
 DTE Electric Company – Belle River Power Plant Diversion Basin

Parameter	Units	Monitoring Well	Sample Date	Data Outlier	Basis for Removal of Outlier
Antimony	ug/L	MW-16-10	04/18/17	< 1.0	Anomalous concentrations observed for multiple parameters.
		MW-16-10	06/06/17	< 1.0	Anomalous concentrations observed for multiple parameters.
		MW-16-10	08/09/17	< 1.0	Removed to maintain temporal independence.
		MW-16-10	08/30/17	< 1.0	Removed to maintain temporal independence.
		MW-16-11A	06/06/17	2.4	Removed to maintain temporal independence.
Arsenic	ug/L	MW-16-07	08/03/16	28	Anomalously high value, failed Dixon's Test for outliers at 1% significance
		MW-16-10	04/18/17	< 5.0	Anomalous concentrations observed for multiple parameters.
		MW-16-10	06/06/17	< 5.0	Anomalous concentrations observed for multiple parameters.
		MW-16-10	08/09/17	< 5.0	Removed to maintain temporal independence.
		MW-16-10	08/30/17	< 5.0	Removed to maintain temporal independence.
MW-16-11A	06/06/17	< 5.0	Removed to maintain temporal independence.		
Barium	ug/L	MW-16-10	04/18/17	75	Anomalous concentrations observed for multiple parameters.
		MW-16-10	06/06/17	65	Anomalous concentrations observed for multiple parameters.
		MW-16-10	08/09/17	115	Removed to maintain temporal independence.
		MW-16-10	08/30/17	99.5	Removed to maintain temporal independence.
		MW-16-11A	06/06/17	260	Removed to maintain temporal independence.
Beryllium	ug/L	MW-16-10	04/18/17	< 1.0	Anomalous concentrations observed for multiple parameters.
		MW-16-10	06/06/17	< 1.0	Anomalous concentrations observed for multiple parameters.
		MW-16-10	08/09/17	< 1.0	Removed to maintain temporal independence.
		MW-16-10	08/30/17	< 1.0	Removed to maintain temporal independence.
		MW-16-11A	06/06/17	< 1.0	Removed to maintain temporal independence.
Cadmium	ug/L	MW-16-10	04/18/17	< 1.0	Anomalous concentrations observed for multiple parameters.
		MW-16-10	06/06/17	< 1.0	Anomalous concentrations observed for multiple parameters.
		MW-16-10	08/09/17	< 1.0	Removed to maintain temporal independence.
		MW-16-10	08/30/17	< 1.0	Removed to maintain temporal independence.
		MW-16-11A	06/06/17	< 1.0	Removed to maintain temporal independence.
Chromium	ug/L	MW-16-07	08/03/16	53	Anomalously high value, failed Dixon's Test for outliers at 1% significance
		MW-16-10	04/18/17	< 2.0	Anomalous concentrations observed for multiple parameters.
		MW-16-10	06/06/17	< 2.0	Anomalous concentrations observed for multiple parameters.
		MW-16-10	08/09/17	7.35	Removed to maintain temporal independence.
		MW-16-10	08/30/17	8.7	Removed to maintain temporal independence.
		MW-16-11A	09/22/16	39	Anomalously high value, failed Dixon's Test for outliers at 1% significance
MW-16-11A	06/06/17	3	Removed to maintain temporal independence.		

Notes:

ug/L = micrograms per liter
 mg/L = milligrams per liter
 pCi/L = picocuries per liter

Table 1
 Summary of Outlier Evaluation and Data Removal
 DTE Electric Company – Belle River Power Plant Diversion Basin

Parameter	Units	Monitoring Well	Sample Date	Data Outlier	Basis for Removal of Outlier
Cobalt	ug/L	MW-16-07	08/03/16	21	Anomalously high value, failed Dixon's Test for outliers at 1% significance
		MW-16-10	04/18/17	< 1.0	Anomalous concentrations observed for multiple parameters.
		MW-16-10	06/06/17	< 1.0	Anomalous concentrations observed for multiple parameters.
		MW-16-10	08/09/17	3.6	Removed to maintain temporal independence.
		MW-16-10	08/30/17	2.95	Removed to maintain temporal independence.
		MW-16-11A	09/22/16	14	Anomalously high value, failed Dixon's Test for outliers at 1% significance
Fluoride	mg/L	MW-16-10	04/18/17	< 1.0	Anomalous concentrations observed for multiple parameters.
		MW-16-10	06/06/17	< 1.0	Anomalous concentrations observed for multiple parameters.
		MW-16-10	08/09/17	< 1.0	Removed to maintain temporal independence.
		MW-16-10	08/30/17	1.1	Removed to maintain temporal independence.
		MW-16-11A	06/06/17	< 1.0	Removed to maintain temporal independence.
Lead	ug/L	MW-16-07	08/03/16	23	Anomalously high value, failed Dixon's Test for outliers at 1% significance
		MW-16-10	04/18/17	< 1.0	Anomalous concentrations observed for multiple parameters.
		MW-16-10	06/06/17	< 1.0	Anomalous concentrations observed for multiple parameters.
		MW-16-10	08/09/17	2.45	Removed to maintain temporal independence.
		MW-16-10	08/30/17	1.7	Removed to maintain temporal independence.
		MW-16-11A	09/22/16	26	Anomalously high value, failed Dixon's Test for outliers at 1% significance
Lithium	ug/L	MW-16-10	04/18/17	120	Anomalous concentrations observed for multiple parameters.
		MW-16-10	06/06/17	130	Anomalous concentrations observed for multiple parameters.
		MW-16-10	08/09/17	86	Removed to maintain temporal independence.
		MW-16-10	08/30/17	73	Removed to maintain temporal independence.
		MW-16-11A	06/06/17	34	Removed to maintain temporal independence.
Mercury	ug/L	MW-16-10	04/18/17	< 0.20	Anomalous concentrations observed for multiple parameters.
		MW-16-10	06/06/17	< 0.20	Anomalous concentrations observed for multiple parameters.
		MW-16-10	08/09/17	< 0.20	Removed to maintain temporal independence.
		MW-16-10	08/30/17	< 0.20	Removed to maintain temporal independence.
		MW-16-11A	06/06/17	< 0.20	Removed to maintain temporal independence.

Notes:

ug/L = micrograms per liter

mg/L = milligrams per liter

pCi/L = picocuries per liter

Table 1
 Summary of Outlier Evaluation and Data Removal
 DTE Electric Company – Belle River Power Plant Diversion Basin

Parameter	Units	Monitoring Well	Sample Date	Data Outlier	Basis for Removal of Outlier
Molybdenum	ug/L	MW-16-10	04/18/17	23	Anomalous concentrations observed for multiple parameters.
		MW-16-10	06/06/17	21	Anomalous concentrations observed for multiple parameters.
		MW-16-10	08/09/17	18	Removed to maintain temporal independence.
		MW-16-10	08/30/17	15.5	Removed to maintain temporal independence.
		MW-16-11A	06/06/17	17	Removed to maintain temporal independence.
Radium 226/228	pCi/L	MW-16-10	04/18/17	0.900	Anomalous concentrations observed for multiple parameters.
		MW-16-10	06/06/17	1.32	Anomalous concentrations observed for multiple parameters.
		MW-16-10	08/09/17	1.48	Removed to maintain temporal independence.
		MW-16-10	08/30/17	1.375	Removed to maintain temporal independence.
		MW-16-11A	08/02/16	6.94	Anomalously high value, failed Dixon's Test for outliers at 1% significance
MW-16-11A	06/06/17	1.45	Removed to maintain temporal independence.		
Selenium	ug/L	MW-16-10	04/18/17	< 5.0	Anomalous concentrations observed for multiple parameters.
		MW-16-10	06/06/17	< 5.0	Anomalous concentrations observed for multiple parameters.
		MW-16-10	08/09/17	< 5.0	Removed to maintain temporal independence.
		MW-16-10	08/30/17	< 5.0	Removed to maintain temporal independence.
		MW-16-11A	06/06/17	< 5.0	Removed to maintain temporal independence.
Thallium	ug/L	MW-16-10	04/18/17	< 1.0	Anomalous concentrations observed for multiple parameters.
		MW-16-10	06/06/17	< 1.0	Anomalous concentrations observed for multiple parameters.
		MW-16-10	08/09/17	< 1.0	Removed to maintain temporal independence.
		MW-16-10	08/30/17	< 1.0	Removed to maintain temporal independence.
		MW-16-11A	06/06/17	< 1.0	Removed to maintain temporal independence.

Notes:

ug/L = micrograms per liter
 mg/L = milligrams per liter
 pCi/L = picocuries per liter

Table 2
 Summary of Descriptive Statistics and Tolerance Limit Calculations
 DTE Electric Company – Belle River Power Plant Diversion Pond

Monitoring Well	Skewness Test		Shapiro-Wilks Test (5% Critical Value)		Outliers Removed	Tolerance Limit Test	95% Tolerance Limit
	Un-Transformed Data	Natural Log Transformed Data	Un-Transformed Data	Natural Log Transformed Data			
Antimony (ug/L)							
MW-16-05	100% Non-Detect				N	PQL	2.0
MW-16-06	100% Non-Detect				N	PQL	2.0
MW-16-07	100% Non-Detect				N	PQL	2.0
MW-16-08	> 50% Non-Detect				N	Non-Parametric	2.1
MW-16-10	> 50% Non-Detect				Y	Non-Parametric	2.1
MW-16-11/A	> 50% Non-Detect				Y	Non-Parametric	3.2
Arsenic (ug/L)							
MW-16-05	> 50% Non-Detect				N	Non-Parametric	14
MW-16-06	> 50% Non-Detect				N	Non-Parametric	7.5
MW-16-07	-1 < 0.373835 < 1	--	--	--	Y	Parametric	19
MW-16-08	-1 < 0.897249 < 1	--	--	--	N	Parametric	30
MW-16-10	> 50% Non-Detect				Y	Non-Parametric	11
MW-16-11/A	-1 < 0.148067 < 1	--	--	--	Y	Parametric	24
Barium (ug/L)							
MW-16-05	1 < 1.01157	-1 < 0.95611 < 1	--	--	N	Parametric	370
MW-16-06	-1 < 0.516938 < 1	--	--	--	N	Parametric	330
MW-16-07	1 < 1.44883	1 < 1.21299	0.829 > 0.8055999	0.829 < 0.847205	N	Parametric	500
MW-16-08	-1 < 0.431717 < 1	--	--	--	N	Parametric	490
MW-16-10	-1 < 0.134164 < 1	--	--	--	Y	Parametric	200
MW-16-11/A	-1 < -0.0523964 < 1	--	--	--	Y	Parametric	620
Beryllium (ug/L)							
MW-16-05	100% Non-Detect				N	PQL	1.0
MW-16-06	100% Non-Detect				N	PQL	1.0
MW-16-07	> 50% Non-Detect				N	Non-Parametric	1.7
MW-16-08	> 50% Non-Detect				N	Non-Parametric	1.6
MW-16-10	100% Non-Detect				Y	PQL	1.0
MW-16-11/A	> 50% Non-Detect				Y	Non-Parametric	1.6

Notes:

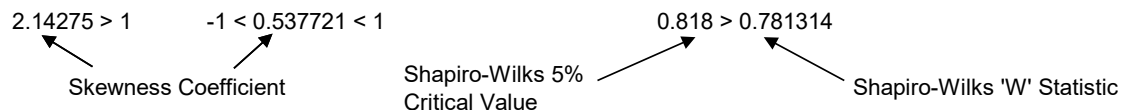

PQL = Practical Quantitation Limit
 ug/L = micrograms per liter
 mg/L = milligrams per liter
 pCi/L = picocuries per liter

Table 2
 Summary of Descriptive Statistics and Tolerance Limit Calculations
 DTE Electric Company – Belle River Power Plant Diversion Pond

Monitoring Well	Skewness Test		Shapiro-Wilks Test (5% Critical Value)		Outliers Removed	Tolerance Limit Test	95% Tolerance Limit
	Un-Transformed Data	Natural Log Transformed Data	Un-Transformed Data	Natural Log Transformed Data			
Cadmium (ug/L)							
MW-16-05		100% Non-Detect			N	PQL	1.0
MW-16-06		100% Non-Detect			N	PQL	1.0
MW-16-07		> 50% Non-Detect			N	Non-Parametric	1.3
MW-16-08		> 50% Non-Detect			N	Non-Parametric	1.5
MW-16-10		100% Non-Detect			Y	PQL	1.0
MW-16-11/A		100% Non-Detect			Y	PQL	1.0
Chromium (ug/L)							
MW-16-05	1 < 1.71747	-1 < 0.673789 < 1	--	--	N	Parametric	47
MW-16-06		> 50% Non-Detect			N	Non-Parametric	14
MW-16-07	-1 < 0.320197 < 1	--	--	--	Y	Parametric	27
MW-16-08	-1 < 0.995955 < 1	--	--	--	N	Parametric	55
MW-16-10	-1 < 0.236403 < 1	--	--	--	Y	Parametric	32
MW-16-11/A	-1 < -0.755706 < 1	--	--	--	Y	Parametric	18
Cobalt (ug/L)							
MW-16-05	1 < 1.66974	-1 < 0.486789 < 1	--	--	N	Parametric	21
MW-16-06		> 50% Non-detect			N	Non-Parametric	4.7
MW-16-07	-1 < 0.377399 < 1	--	--	--	Y	Parametric	13
MW-16-08	-1 < 0.710724 < 1	--	--	--	N	Parametric	22
MW-16-10	-1 < 0.989395 < 1	--	--	--	Y	Parametric	17
MW-16-11/A	-1 < 0.168083 < 1	--	--	--	Y	Parametric	7.1
Fluoride (mg/L)							
MW-16-05	-2.36014 < -1	-2.90896 < -1	0.887 > 0.696028	0.887 > 0.582757	N	Non-Parametric	1.3
MW-16-06	-2.19557 < -1	-2.80843 < -1	0.887 > 0.739569	0.887 > 0.617868	N	Non-Parametric	1.3
MW-16-07	-1.77484 < -1	-2.0008 < -1	0.887 > 0.68499	0.887 > 0.609979	N	Non-Parametric	1.2
MW-16-08	-1 < 0.229585 < 1	--	--	--	N	Parametric	1.3
MW-16-10	-1 < 0.281128 < 1	--	--	--	Y	Parametric	2.1
MW-16-11/A	-1 < 0.411854 < 1	--	--	--	Y	Parametric	1.9

Notes:

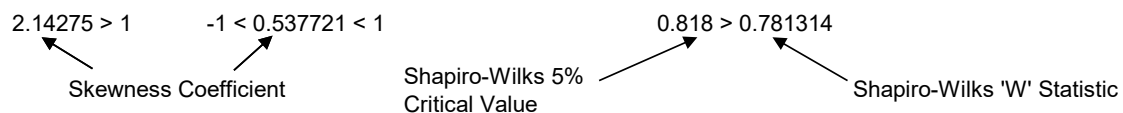

PQL = Practical Quantitation Limit
 ug/L = micrograms per liter
 mg/L = milligrams per liter
 pCi/L = picocuries per liter

Table 2
 Summary of Descriptive Statistics and Tolerance Limit Calculations
 DTE Electric Company – Belle River Power Plant Diversion Pond

Monitoring Well	Skewness Test		Shapiro-Wilks Test (5% Critical Value)		Outliers Removed	Tolerance Limit Test	95% Tolerance Limit
	Un-Transformed Data	Natural Log Transformed Data	Un-Transformed Data	Natural Log Transformed Data			
Lead (ug/L)							
MW-16-05	1 < 1.81739	-1 < 0.489817 < 1	--	--	N	Parametric	23
MW-16-06	> 50% Non-Detect				N	Non-Parametric	4.4
MW-16-07	-1 < 0.114555 < 1	--	--	--	Y	Parametric	12
MW-16-08	-1 < 0.878446 < 1	--	--	--	N	Parametric	22
MW-16-10	1 < 1.1556	-1 < -0.336561 < 1	--	--	Y	Parametric	35
MW-16-11/A	-1 < 0.741547 < 1	--	--	--	Y	Parametric	7.7
Lithium (ug/L)							
MW-16-05	-1 < 0.20306 < 1	--	--	--	N	Parametric	67
MW-16-06	-1 < 0.493967 < 1	--	--	--	N	Parametric	55
MW-16-07	-1 < 0.351593 < 1	--	--	--	N	Parametric	92
MW-16-08	-1 < 0.949387 < 1	--	--	--	N	Parametric	110
MW-16-10	-1 < -0.119962 < 1	--	--	--	Y	Parametric	120
MW-16-11/A	1 < 1.67414	1 < 1.10921	0.818 > 0.764918	0.818 < 0.87926	Y	Parametric	150
Mercury (ug/L)							
MW-16-05	100% Non-Detect				N	PQL	0.20
MW-16-06	100% Non-Detect				N	PQL	0.20
MW-16-07	100% Non-Detect				N	PQL	0.20
MW-16-08	100% Non-Detect				N	PQL	0.20
MW-16-10	100% Non-Detect				Y	PQL	0.20
MW-16-11/A	100% Non-Detect				Y	PQL	0.20
Molybdenum (ug/L)							
MW-16-05	1 < 2.11944	1 < 1.8128	0.829 > 0.650199	0.829 > 0.746132	N	Non-Parametric	43
MW-16-06	1 < 1.79557	1 < 1.57811	0.829 > 0.688295	0.829 > 0.73398	N	Non-Parametric	30
MW-16-07	1 < 1.90393	1 < 1.32689	0.829 > 0.697642	0.829 < 0.832132	N	Parametric	100
MW-16-08	-1 < 0.851996 < 1	--	--	--	N	Parametric	67
MW-16-10	1 < 1.25926	-1 < 0.873361 < 1	--	--	Y	Parametric	50
MW-16-11/A	1 < 1.04371	-1 < 0.974189 < 1	--	--	Y	Parametric	49

Notes:

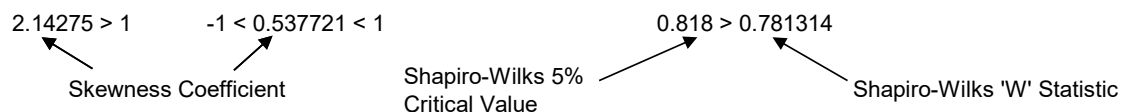

PQL = Practical Quantitation Limit
 ug/L = micrograms per liter
 mg/L = milligrams per liter
 pCi/L = picocuries per liter

Table 2
 Summary of Descriptive Statistics and Tolerance Limit Calculations
 DTE Electric Company – Belle River Power Plant Diversion Pond

Monitoring Well	Skewness Test		Shapiro-Wilks Test (5% Critical Value)		Outliers Removed	Tolerance Limit Test	95% Tolerance Limit
	Un-Transformed Data	Natural Log Transformed Data	Un-Transformed Data	Natural Log Transformed Data			
Radium 226/228 (pCi/L)							
MW-16-05	1 < 1.7901	1 < 1.07063	0.829 > 0.760667	0.829 < 0.907933	N	Parametric	5.49
MW-16-06	-1 < 0.713621 < 1	--	--	--	N	Parametric	2.60
MW-16-07	-1 < 0.761539 < 1	--	--	--	N	Parametric	5.80
MW-16-08	1 < 1.49391	-1 < -0.879177 < 1	--	--	N	Parametric	7.57
MW-16-10	-1 < -0.170195 < 1	--	--	--	Y	Parametric	3.15
MW-16-11/A	-1 < 0.818505 < 1	--	--	--	Y	Parametric	2.58
Selenium (ug/L)							
MW-16-05		100% Non-Detect			N	PQL	5.0
MW-16-06		100% Non-Detect			N	PQL	5.0
MW-16-07		> 50% Non-detect			N	Non-Parametric	5.3
MW-16-08		100% Non-Detect			N	PQL	5.0
MW-16-10		100% Non-Detect			Y	PQL	5.0
MW-16-11/A		100% Non-Detect			Y	PQL	5.0
Thallium (ug/L)							
MW-16-05		> 50% Non-detect			N	Non-Parametric	1.1
MW-16-06		100% Non-Detect			N	PQL	1.0
MW-16-07		> 50% Non-detect			N	Non-Parametric	2.3
MW-16-08		> 50% Non-detect			N	Non-Parametric	1.3
MW-16-10		100% Non-Detect			Y	PQL	1.0
MW-16-11/A		100% Non-Detect			Y	PQL	1.0

Notes:

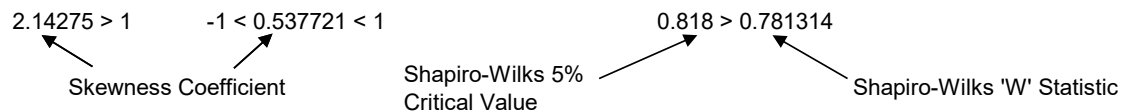

PQL = Practical Quantitation Limit
 ug/L = micrograms per liter
 mg/L = milligrams per liter
 pCi/L = picocuries per liter

Table 3
 Summary of Groundwater Protection Standards
 DTE Electric Company – Belle River Power Plant Diversion Pond

Constituent	Unit	GWPS Selection	MCL/RSL	MW-16-05		MW-16-06		MW-16-07		MW-16-08		MW-16-10		MW-16-11/A	
				UTL	GWPS	UTL	GWPS	UTL	GWPS	UTL	GWPS	UTL	GWPS	UTL	GWPS
Antimony	ug/L	MCL	6	2.0	6.0	2.0	6.0	2.0	6.0	2.1	6.0	2.1	6.0	3.2	6.0
Arsenic	ug/L	Background or MCL	10	14	14	7.5	10	19	19	30	30	11	11	24	24
Barium	ug/L	MCL	2000	370	2,000	330	2,000	500	2,000	490	2,000	200	2,000	620	2,000
Beryllium	ug/L	MCL	4	1.0	4.0	1.0	4.0	1.7	4.0	1.6	4.0	1.0	4.0	1.6	4.0
Cadmium	ug/L	MCL	5	1.0	5.0	1.0	5.0	1.3	5.0	1.5	5.0	1.0	5.0	1.0	5.0
Chromium	ug/L	MCL	100	47	100	14	100	27	100	55	100	32	100	18	100
Cobalt	ug/L	Background or RSL	6	21	21	4.7	6.0	13	13	22	22	17	17	7.1	7.1
Fluoride	mg/L	MCL	4	1.3	4.0	1.3	4.0	1.2	4.0	1.3	4.0	2.1	4.0	1.9	4.0
Lead	ug/L	Background or RSL	15	23	23	4.4	15	12	15	22	22	35	35	7.7	15
Lithium	ug/L	Background	40	67	67	55	55	92	92	110	110	120	120	150	150
Mercury	ug/L	MCL	2	0.20	2.0	0.20	2.0	0.20	2.0	0.20	2.0	0.20	2.0	0.20	2.0
Molybdenum	ug/L	RSL	100	43	100	30	100	100	100	67	100	50	100	49	100
Radium-226/228	pCi/L	Background or MCL	5	5.49	5.49	2.60	5.00	5.80	5.80	7.57	7.57	3.15	5.00	2.58	5.00
Selenium	ug/L	MCL	50	5.0	50	5.0	50	5.3	50	5.0	50	5.0	50	5.0	50
Thallium	ug/L	Background or MCL	2	1.1	2.0	1.0	2.0	2.3	2.3	1.3	2.0	1.0	2.0	1.0	2.0

Notes:

- MCL - Maximum Contaminant Level, EPA Drinking Water Standards and Health Advisories, April 2012.
- RSL - Regional Screening Level from 83 FR 36435.
- UTL - Upper Tolerance Limit (95%) of the background data set.
- GWPS - Groundwater Protection Standard. Appendix IV GWPS is the higher of the MCL/RSL and UTL.
- ug/L = micrograms per liter
- mg/L = milligrams per liter
- pCi/L = picocuries per liter

Technical Memorandum

Attachment A ChemStat™ Outputs

Antimony Multi-Well Time-Series Graph

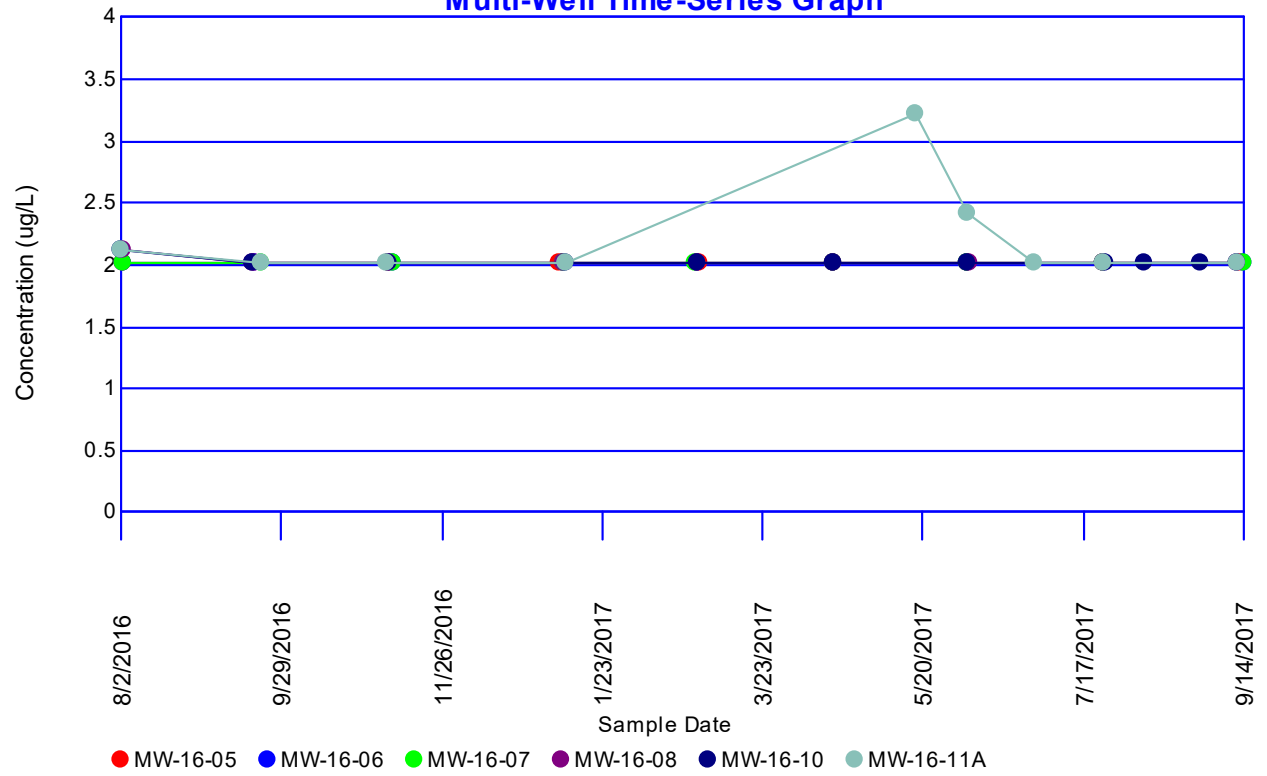

Arsenic Multi-Well Time-Series Graph

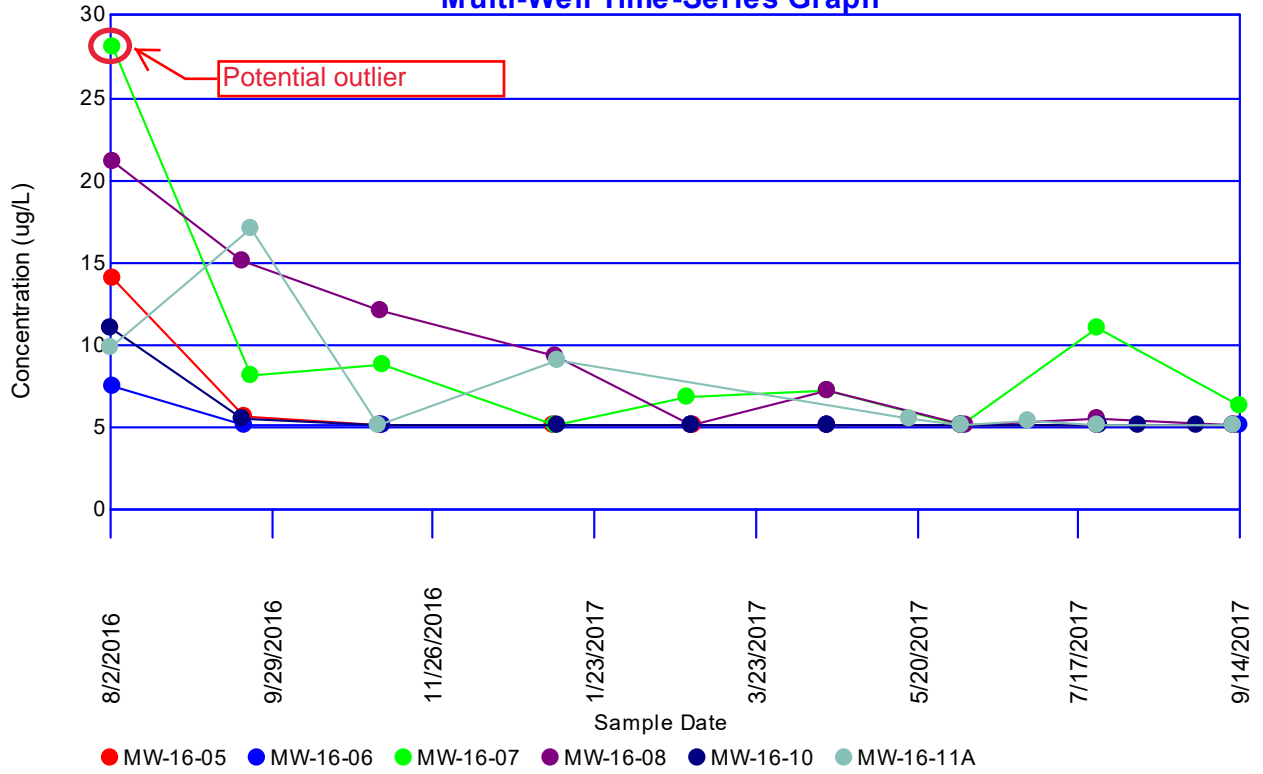

Barium Multi-Well Time-Series Graph

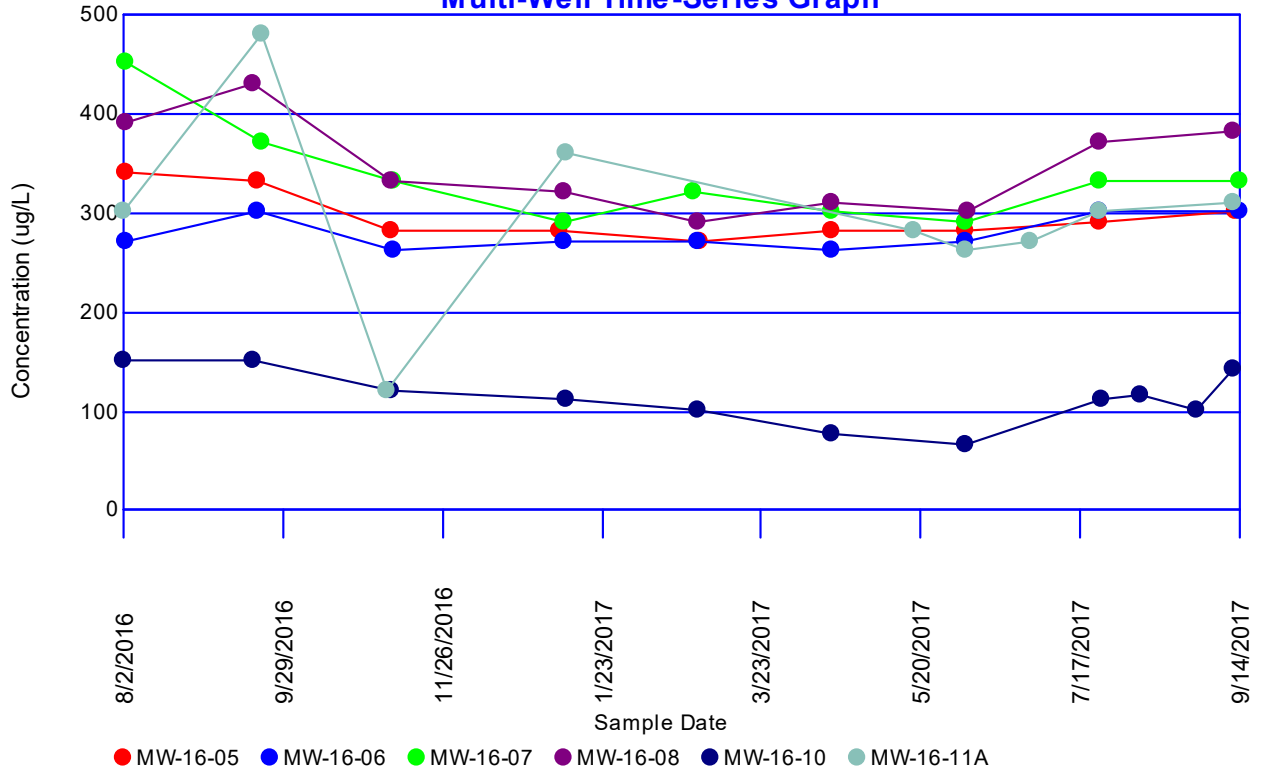

Beryllium Multi-Well Time-Series Graph

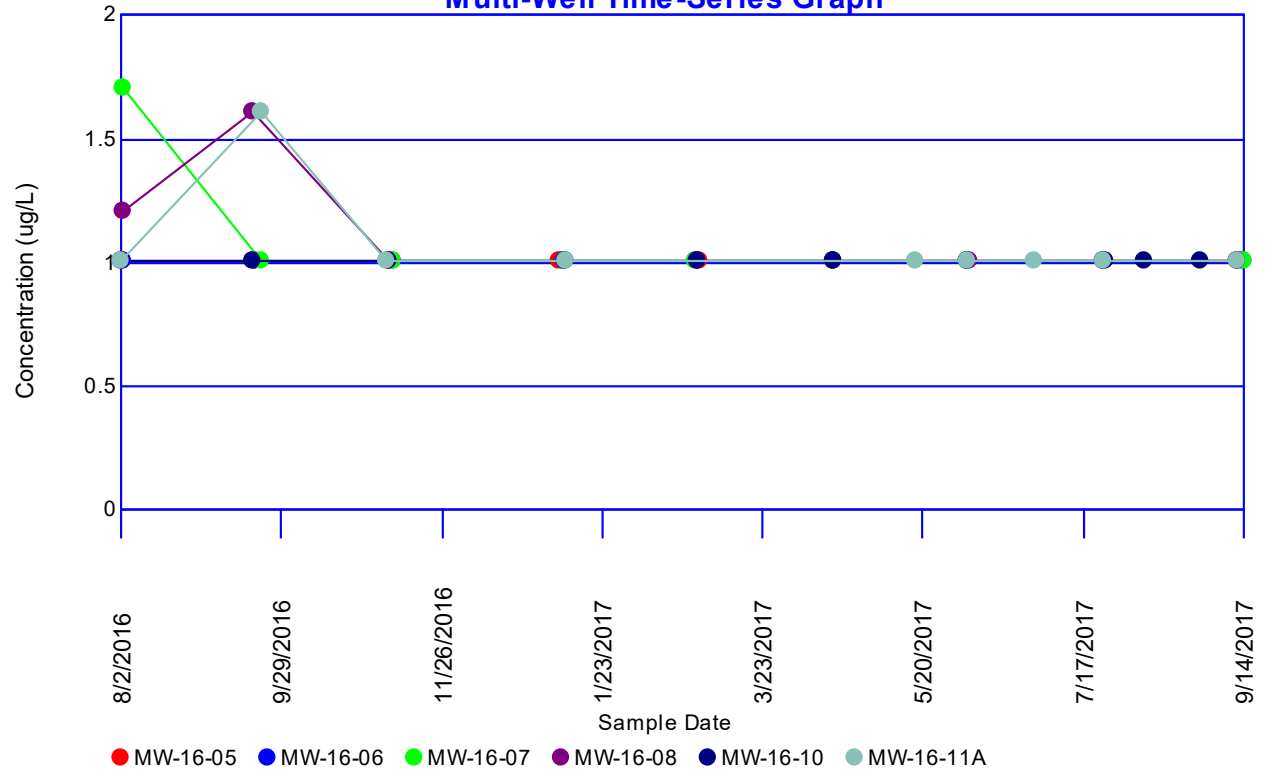

Cadmium Multi-Well Time-Series Graph

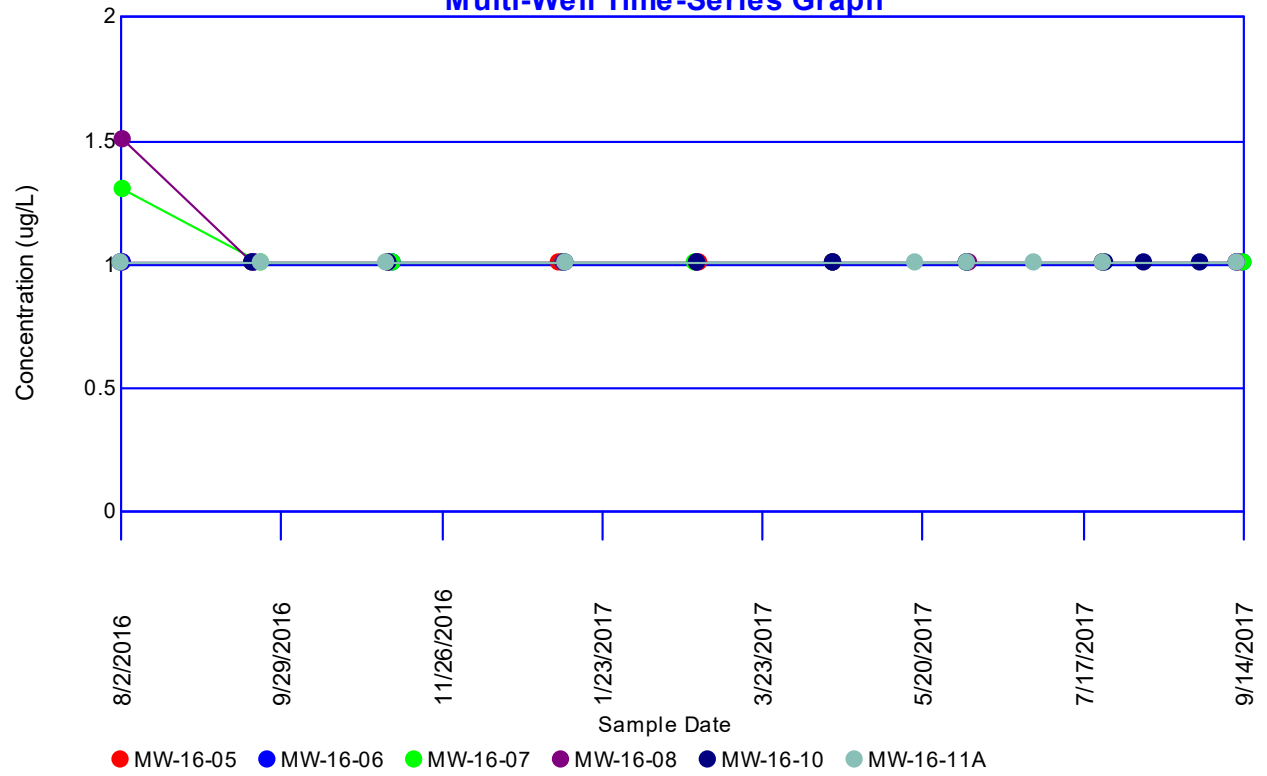

Chromium Multi-Well Time-Series Graph

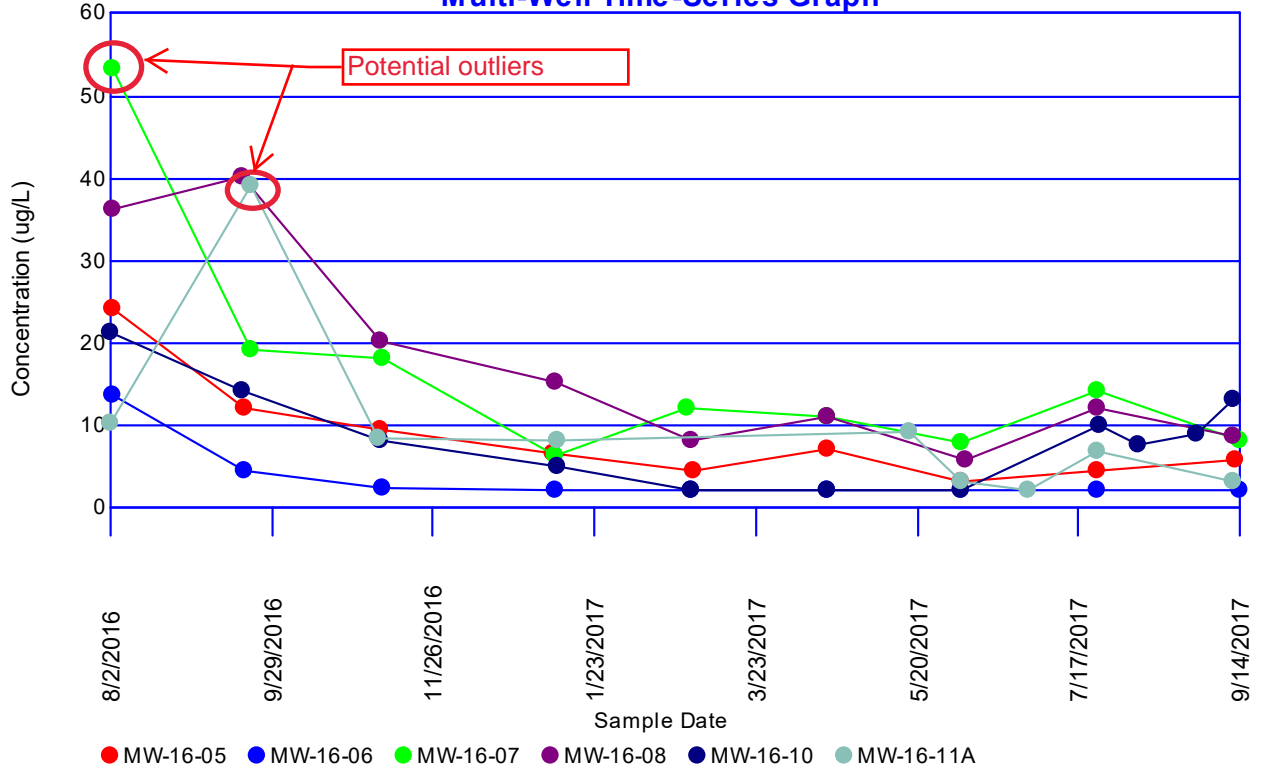

Cobalt Multi-Well Time-Series Graph

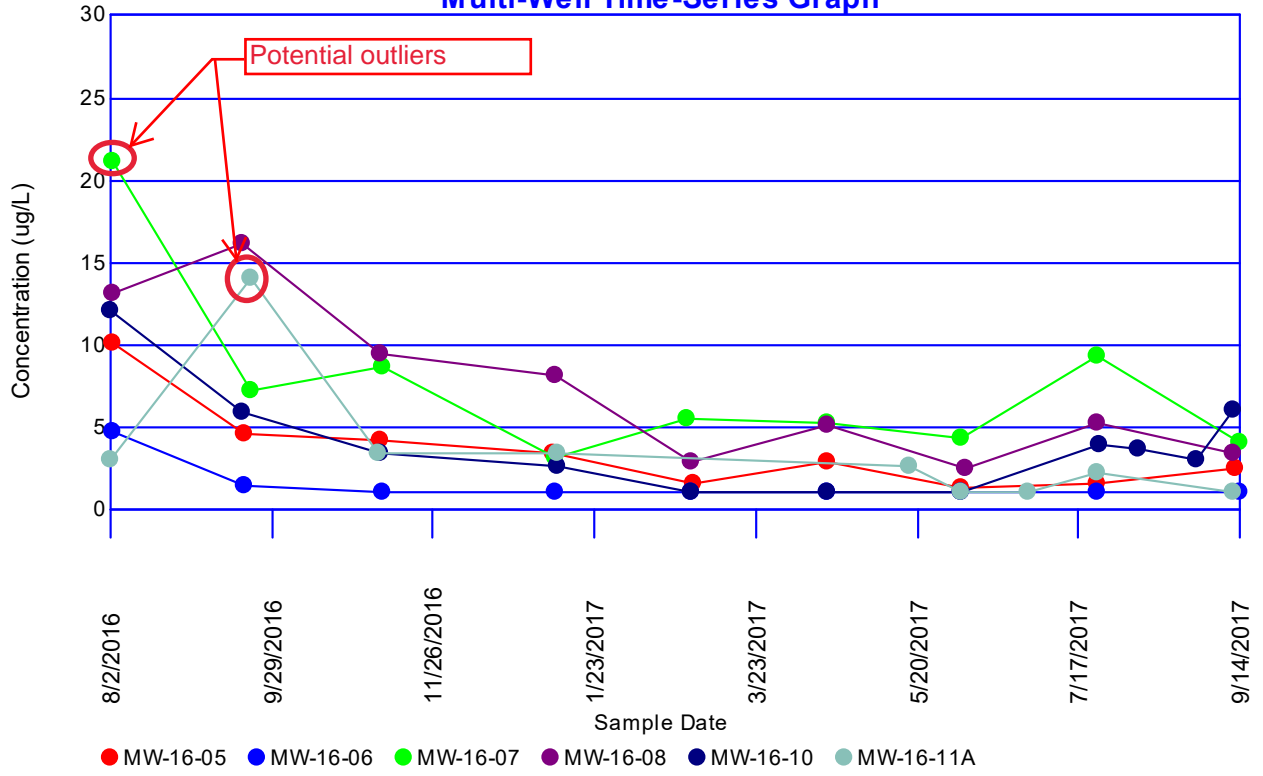

Fluoride Multi-Well Time-Series Graph

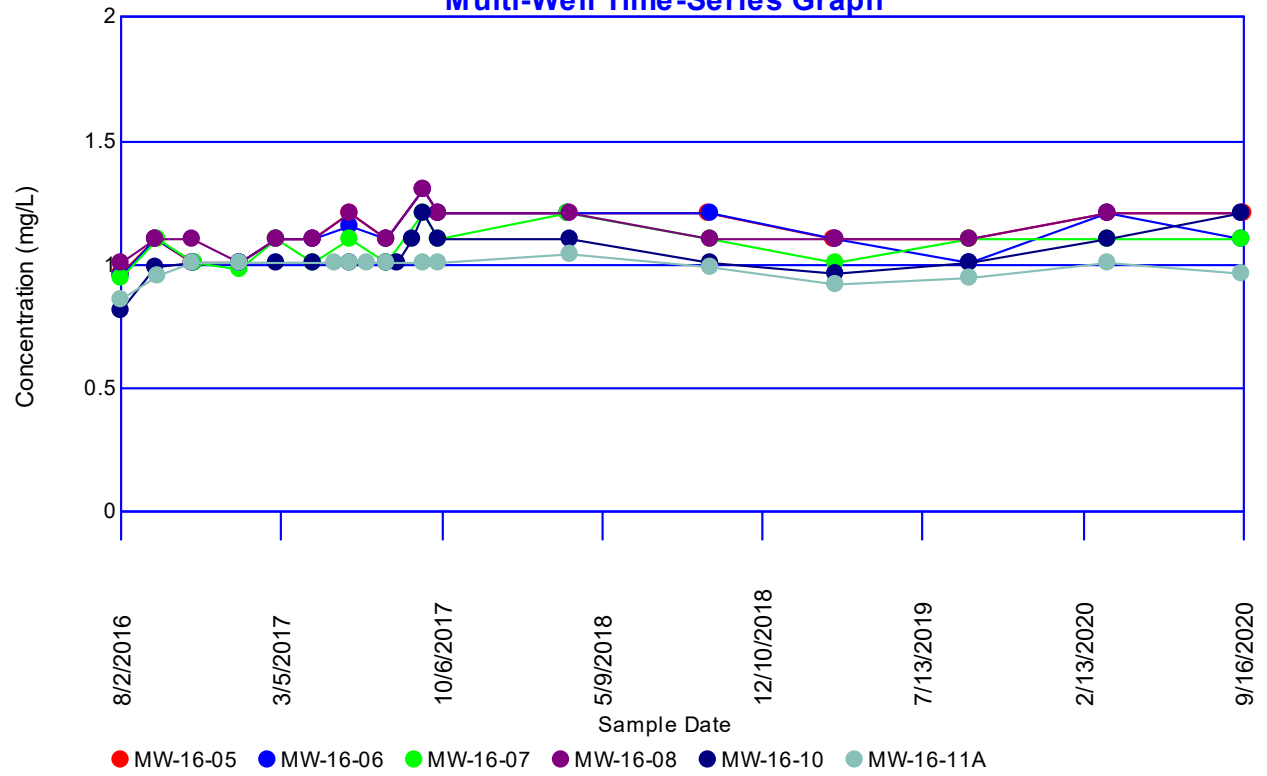

Lead Multi-Well Time-Series Graph

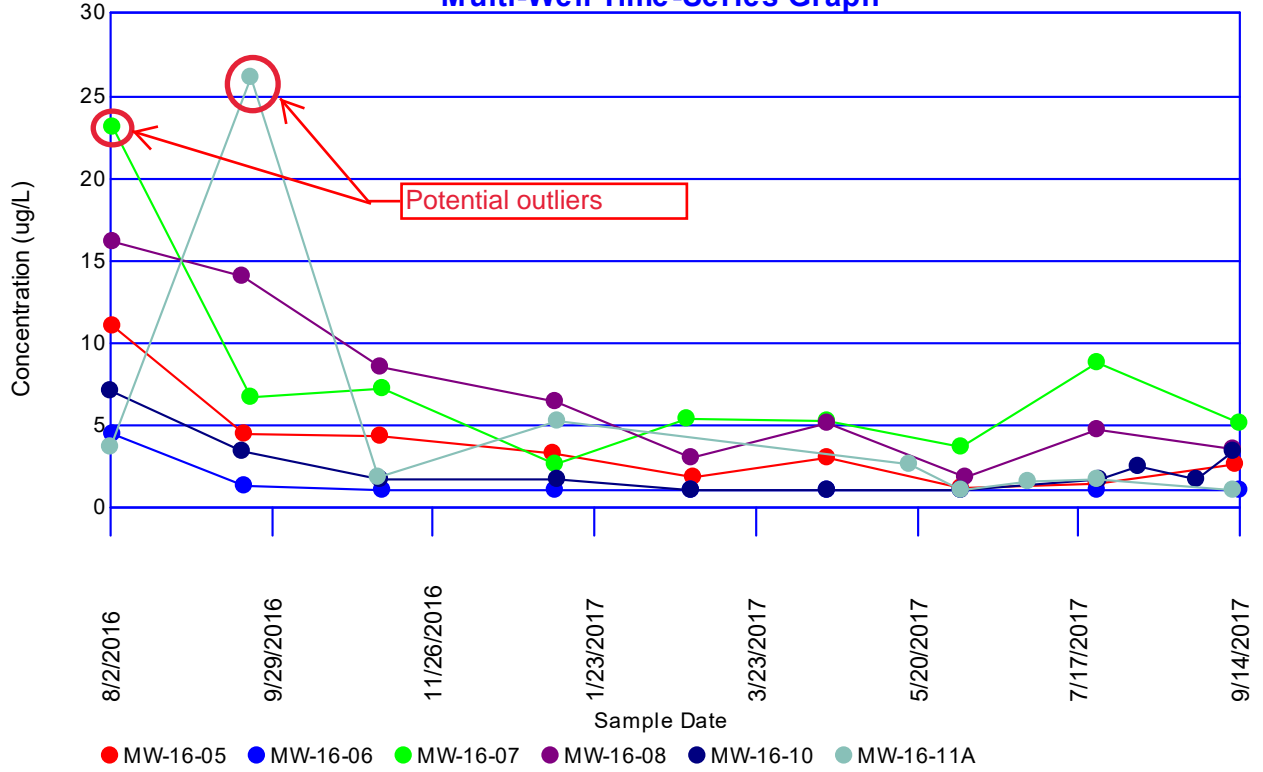

Lithium Multi-Well Time-Series Graph

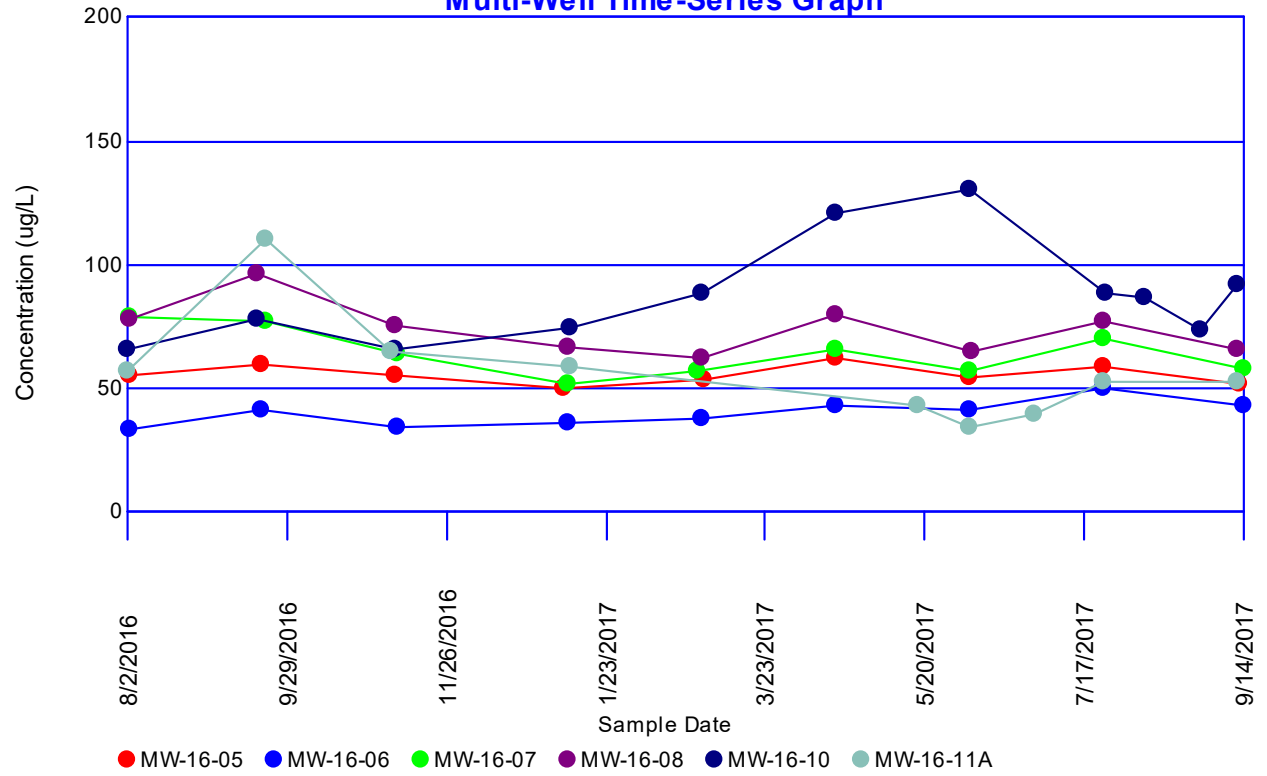

Mercury

Multi-Well Time-Series Graph

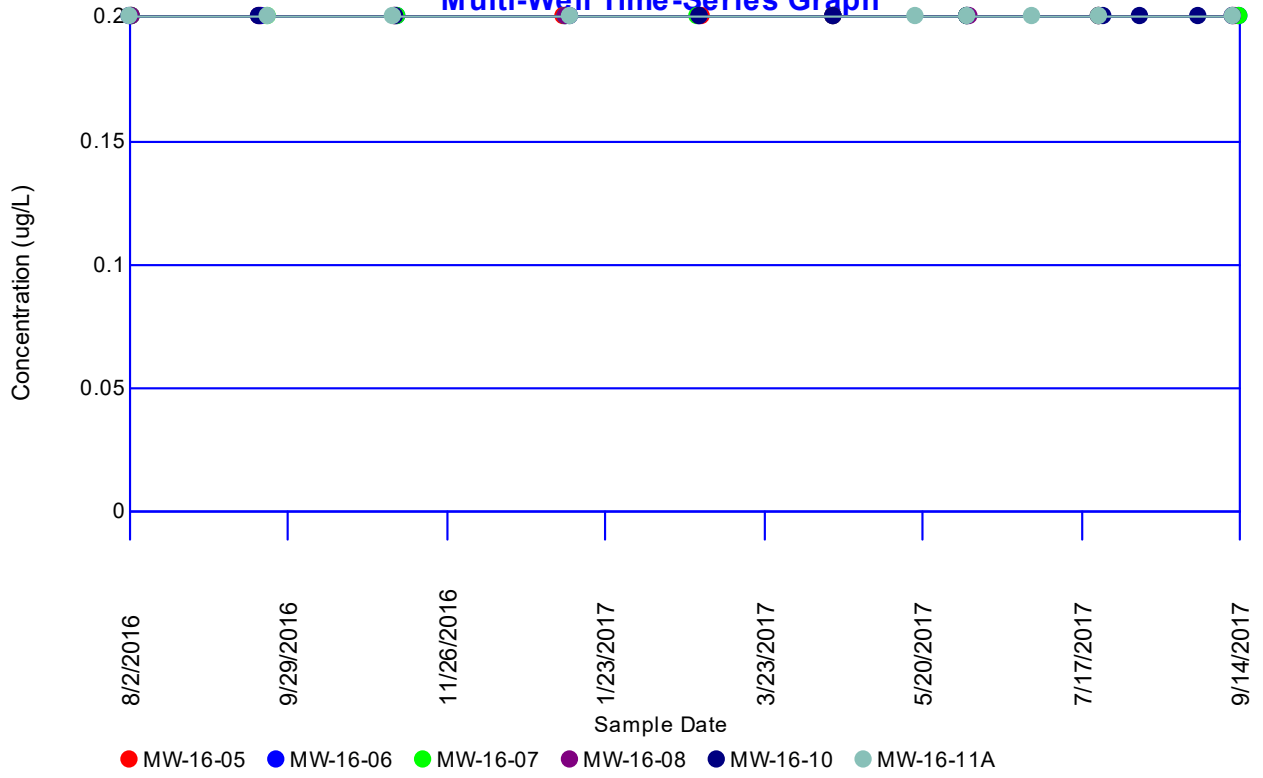

Molybdenum Multi-Well Time-Series Graph

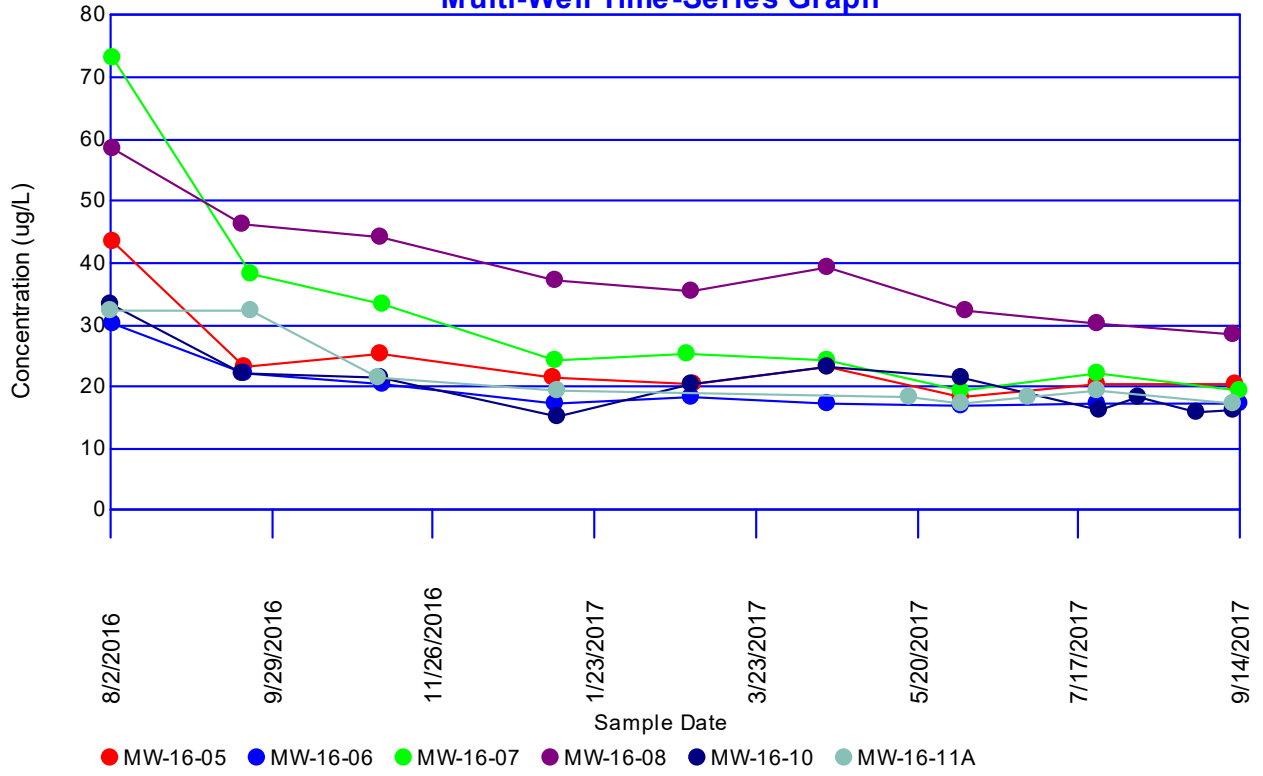

Radium-226/228 Multi-Well Time-Series Graph

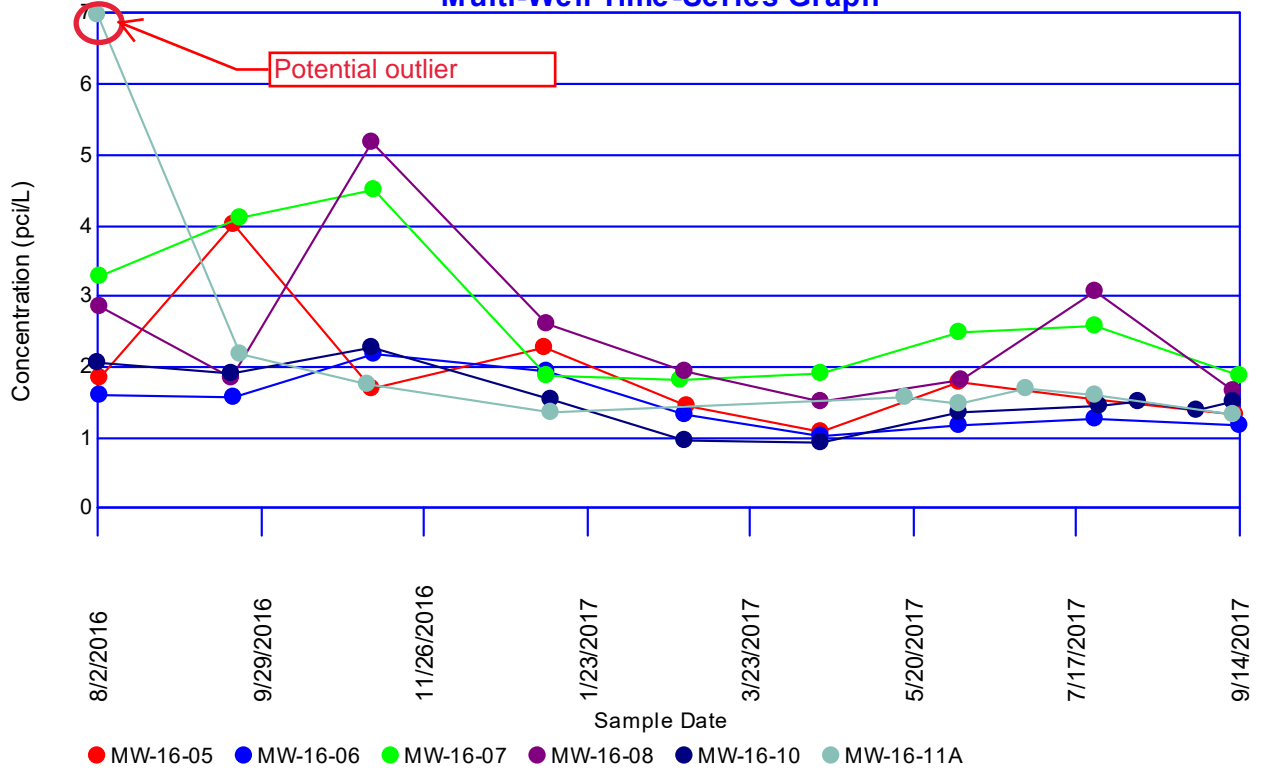

Selenium Multi-Well Time-Series Graph

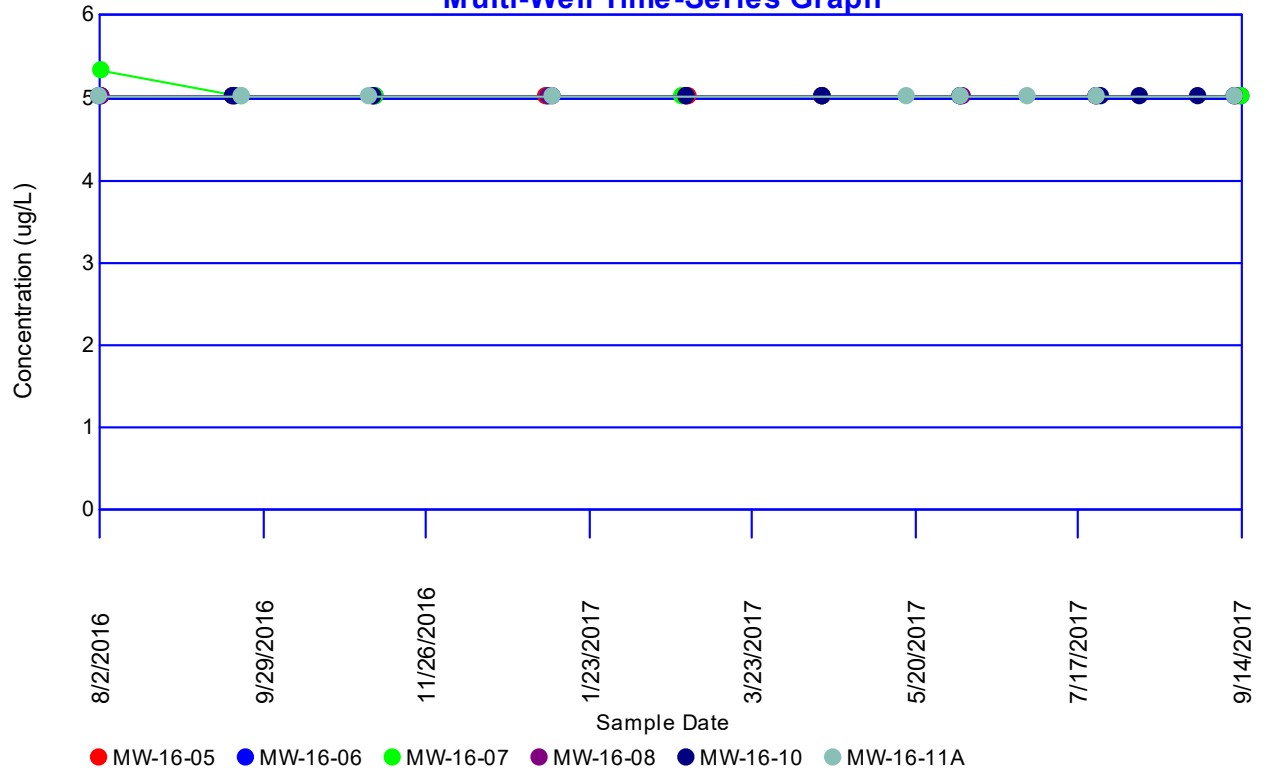

Thallium Multi-Well Time-Series Graph

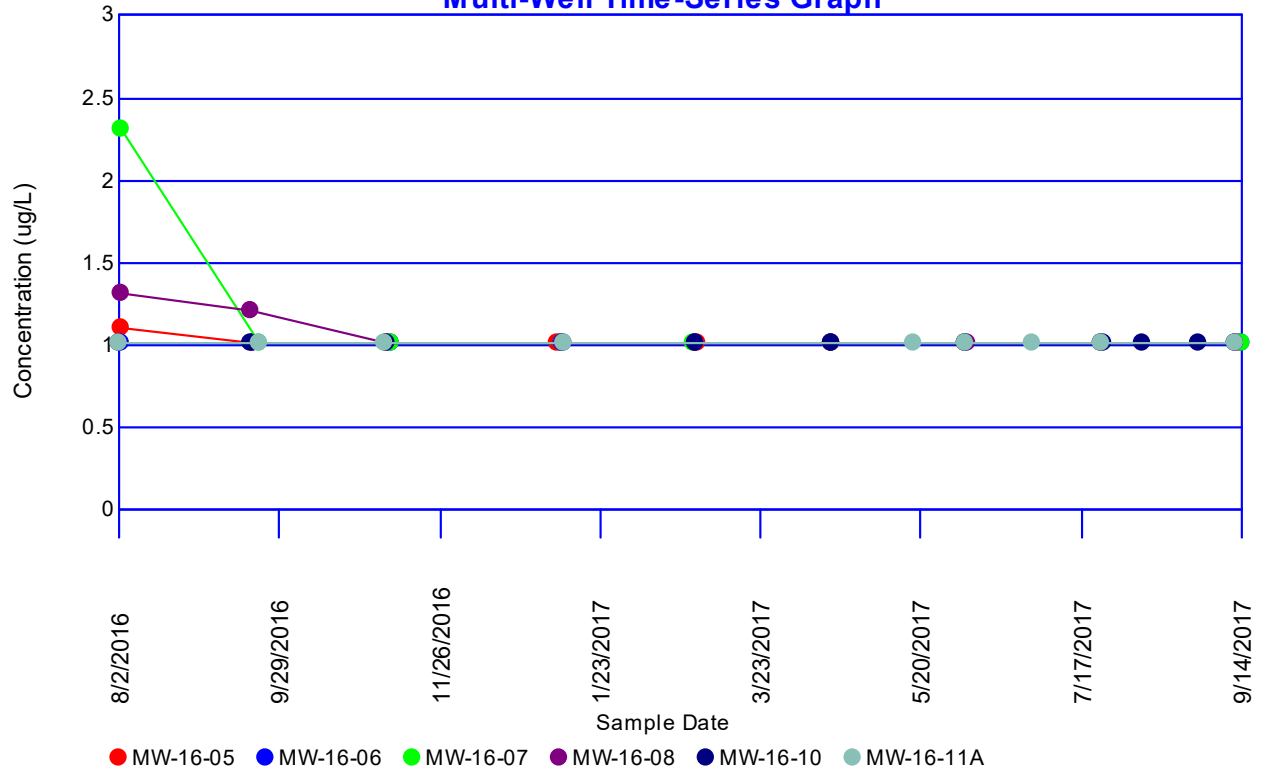

Arsenic
Probability Plot of Residuals for MW-16-07
Correlation Coefficient = 0.833735
0.833735 < 0.912 -- Normality test fails at 95% level

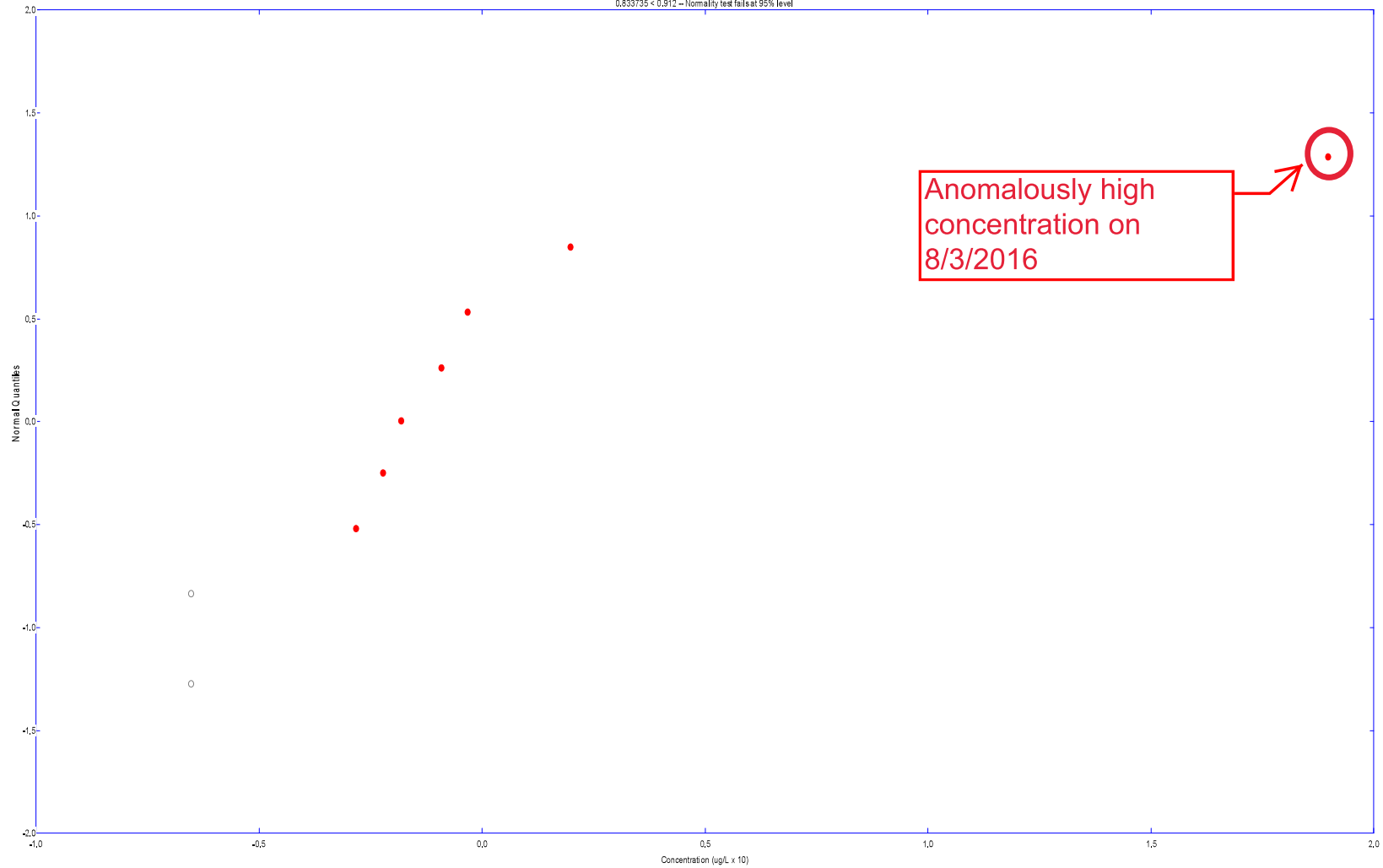

Arsenic
Probability Plot of Residuals for MW-16-07
Correlation Coefficient = 0.833735
0.833735 < 0.912 -- Normality test fails at 95% level

Dixon's Test for Outliers

Parameter: Arsenic

Location: MW-16-07

Original Data (Not Transformed)

Non-Detects Replaced with 1/2 DL

For 9 Measurements...

1% Level of Significance

Iteration	Highest	Lowest	Critical	Outlier
1	0.666667	0	0.635	28
2	0.270588	0	0.683	None

Loc.	Date	Conc.	Outlier
------	------	-------	---------

MW-16-07	8/3/2016	28	TRUE
	9/22/2016	8.1	FALSE
	11/9/2016	8.7	FALSE
	1/10/2017	ND<2.5 U	FALSE
	2/27/2017	6.8	FALSE
	4/18/2017	7.2	FALSE
	6/6/2017	ND<2.5 U	FALSE
	7/25/2017	11	FALSE
	9/14/2017	6.2	FALSE

with outliers removed

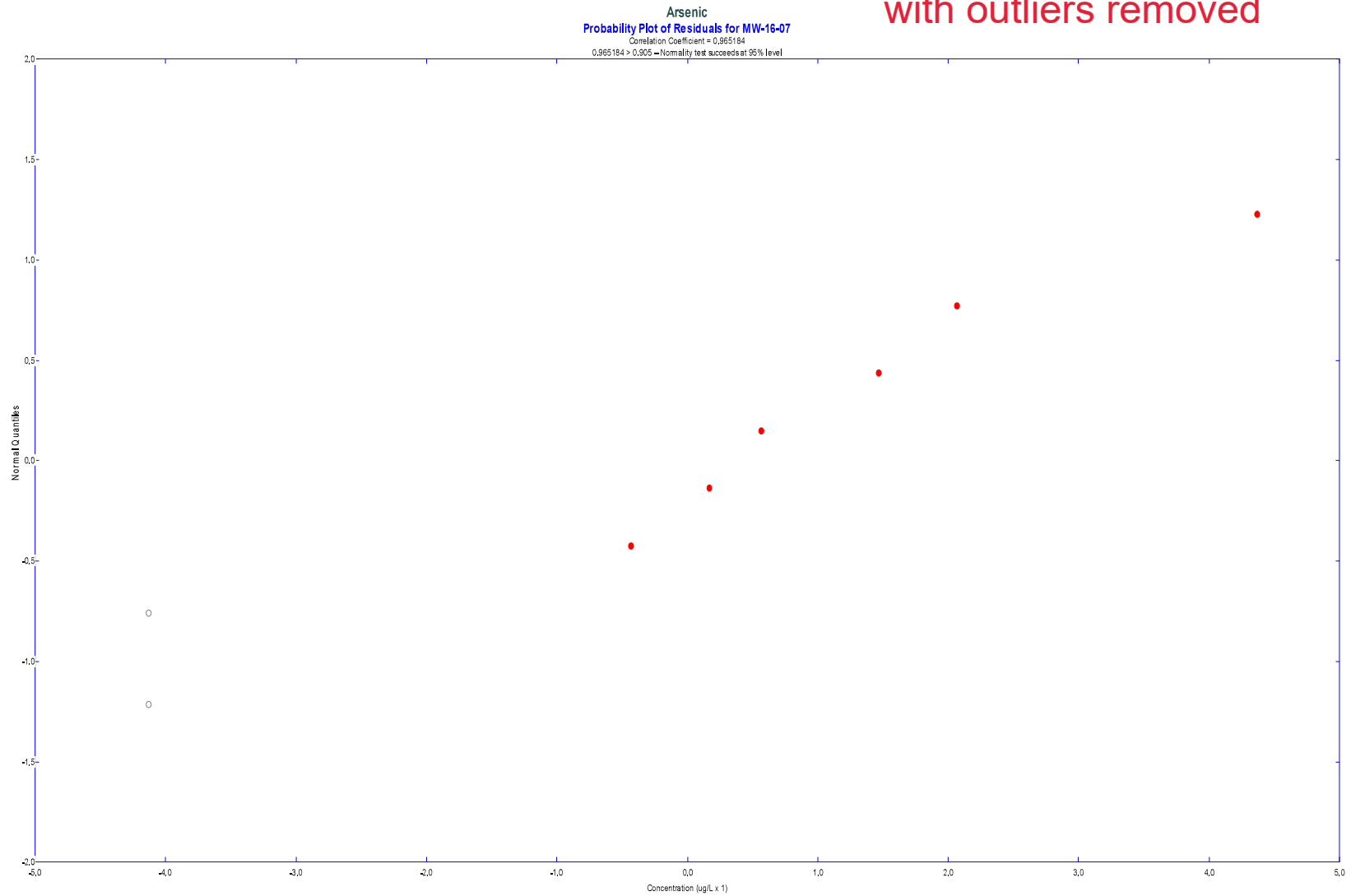

Arsenic
Probability Plot of Residuals for MW-16-07
Correlation Coefficient = 0.965184
0.965184 > 0.905 – Normality test succeeds at 95% level

Chromium
Probability Plot of Residuals for MW-16-07
Correlation Coefficient = 0,807034
0,807034 < 0,912 – Normality test fails at 95% level

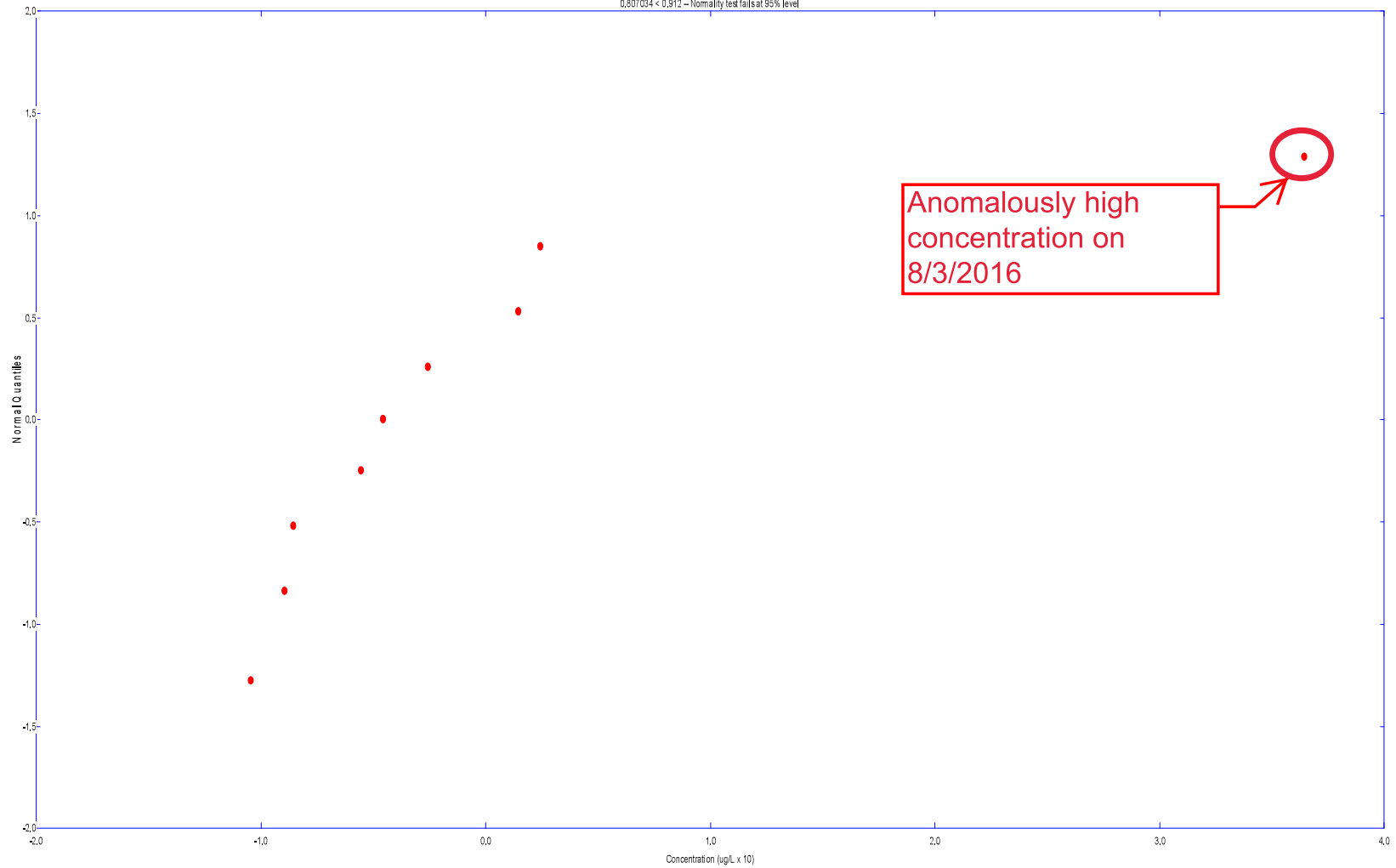

Chromium
Probability Plot of Residuals for MW-16-07
Correlation Coefficient = 0,807034
0,807034 < 0,912 – Normality test fails at 95% level

Dixon's Test for Outliers

Parameter: Chromium

Location: MW-16-07

Original Data (Not Transformed)

Non-Detects Replaced with 1/2 DL

For 9 Measurements...

1% Level of Significance

Iteration	Highest	Lowest	Critical	Outlier
1	0.748899	0.116279	0.635	53
2	0.0877193	0.12605	0.683	None

Loc.	Date	Conc.	Outlier
------	------	-------	---------

MW-16-07	8/3/2016	53	TRUE
	9/22/2016	19	FALSE
	11/9/2016	18	FALSE
	1/10/2017	6.1	FALSE
	2/27/2017	12	FALSE
	4/18/2017	11	FALSE
	6/6/2017	7.6	FALSE
	7/25/2017	14	FALSE
	9/14/2017	8	FALSE

Chromium
Probability Plot of Residuals for MW-16-07
Correlation Coefficient = 0,975283
0,975283 > 0,905 – Normality test succeeds at 95% level

with outliers removed

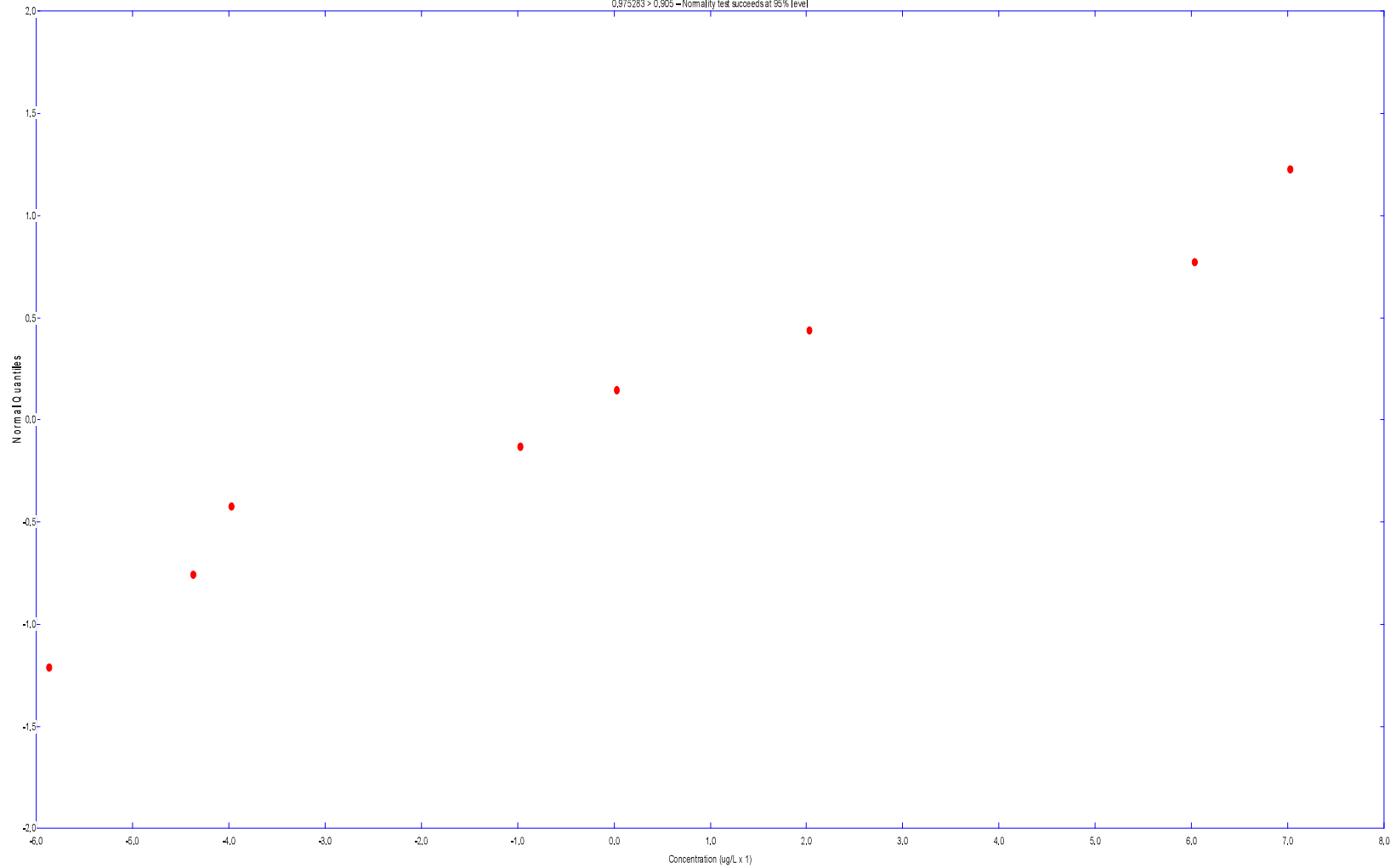

Chromium
Probability Plot of Residuals for MW-16-07
Correlation Coefficient = 0,975283
0,975283 > 0,905 – Normality test succeeds at 95% level

Chromium
Probability Plot of Residuals for MW-16-11A

Correlation Coefficient = 0.793531
0.793531 < 0.905 -- Normality test fails at 95% level

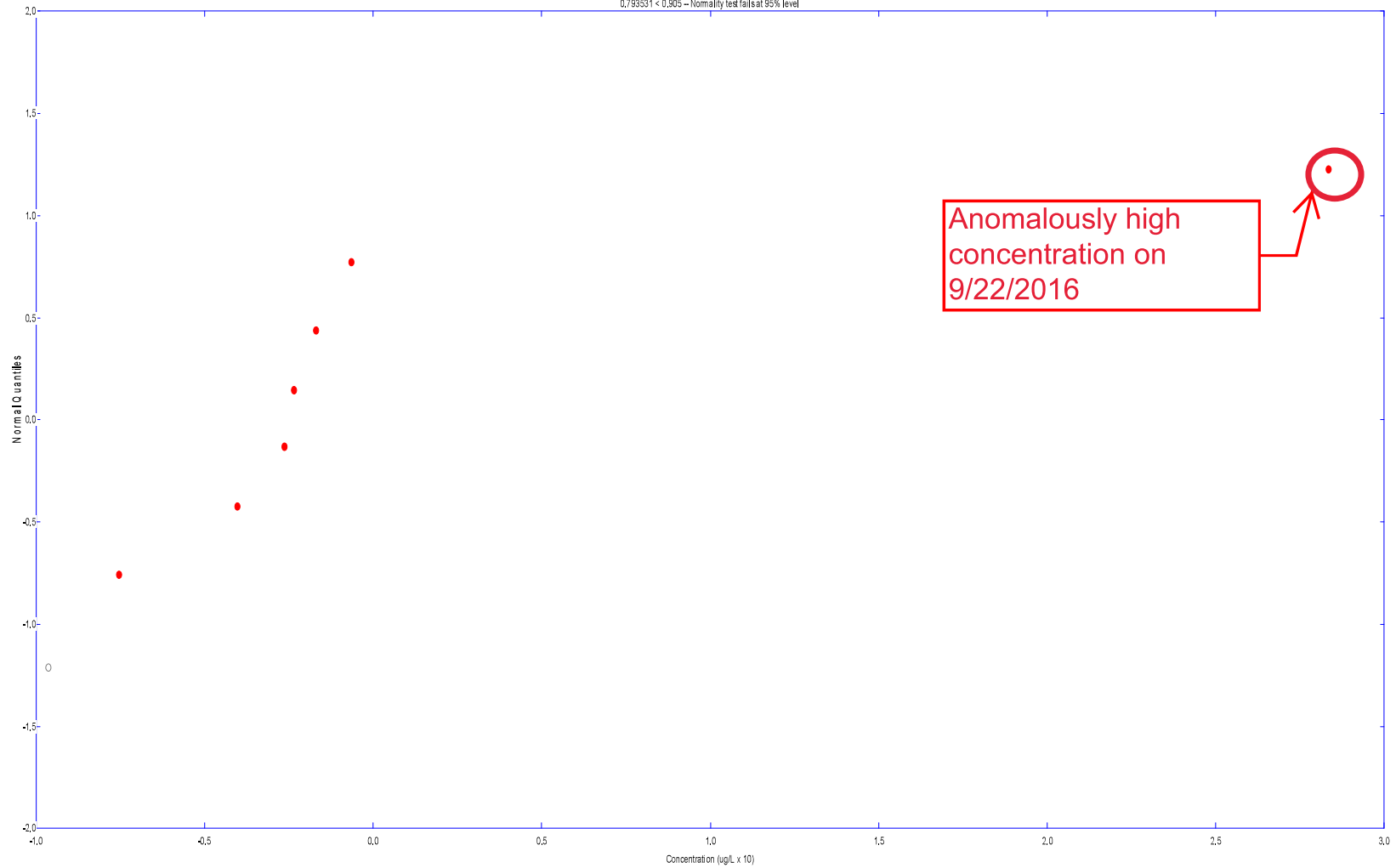

Chromium
Probability Plot of Residuals for MW-16-11A

Correlation Coefficient = 0.793531
0.793531 < 0.905 -- Normality test fails at 95% level

Dixon's Test for Outliers

Parameter: Chromium

Location: MW-16-11A

Original Data (Not Transformed)

Non-Detects Replaced with 1/2 DL

For 8 Measurements...

1% Level of Significance

Iteration	Highest	Lowest	Critical	Outlier
1	0.807799	0.233333	0.683	39
2	0.116667	0.233333	0.637	None

Loc.	Date	Conc.	Outlier
------	------	-------	---------

MW-16-11A	8/2/2016	10	FALSE
	9/22/2016	39	TRUE
	11/7/2016	8.3	FALSE
	1/11/2017	8	FALSE
	5/18/2017 ~	8.95	FALSE
	6/30/2017 ~	ND<1 U	FALSE
	7/25/2017	6.6	FALSE
	9/12/2017	3.1	FALSE

Chromium
Probability Plot of Residuals for MW-16-11A
Correlation Coefficient = 0,945335
0,945335 > 0,899 – Normality test succeeds at 95% level

with outliers removed

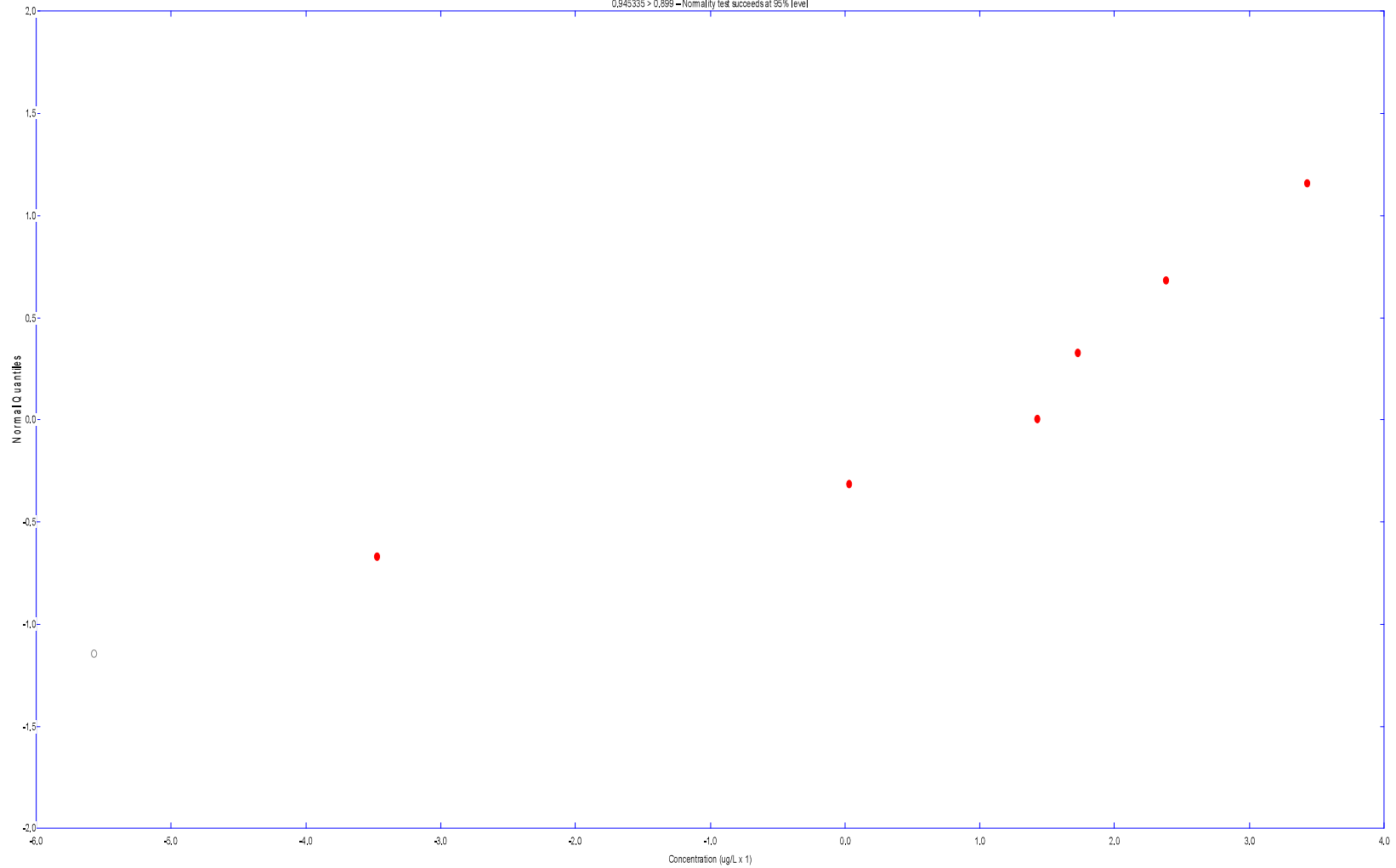

Chromium
Probability Plot of Residuals for MW-16-11A
Correlation Coefficient = 0,945335
0,945335 > 0,899 – Normality test succeeds at 95% level

Cobalt
Probability Plot of Residuals for MW-16-07
Correlation Coefficient = 0,845361
0,845361 < 0,912 -- Normality test fails at 95% level

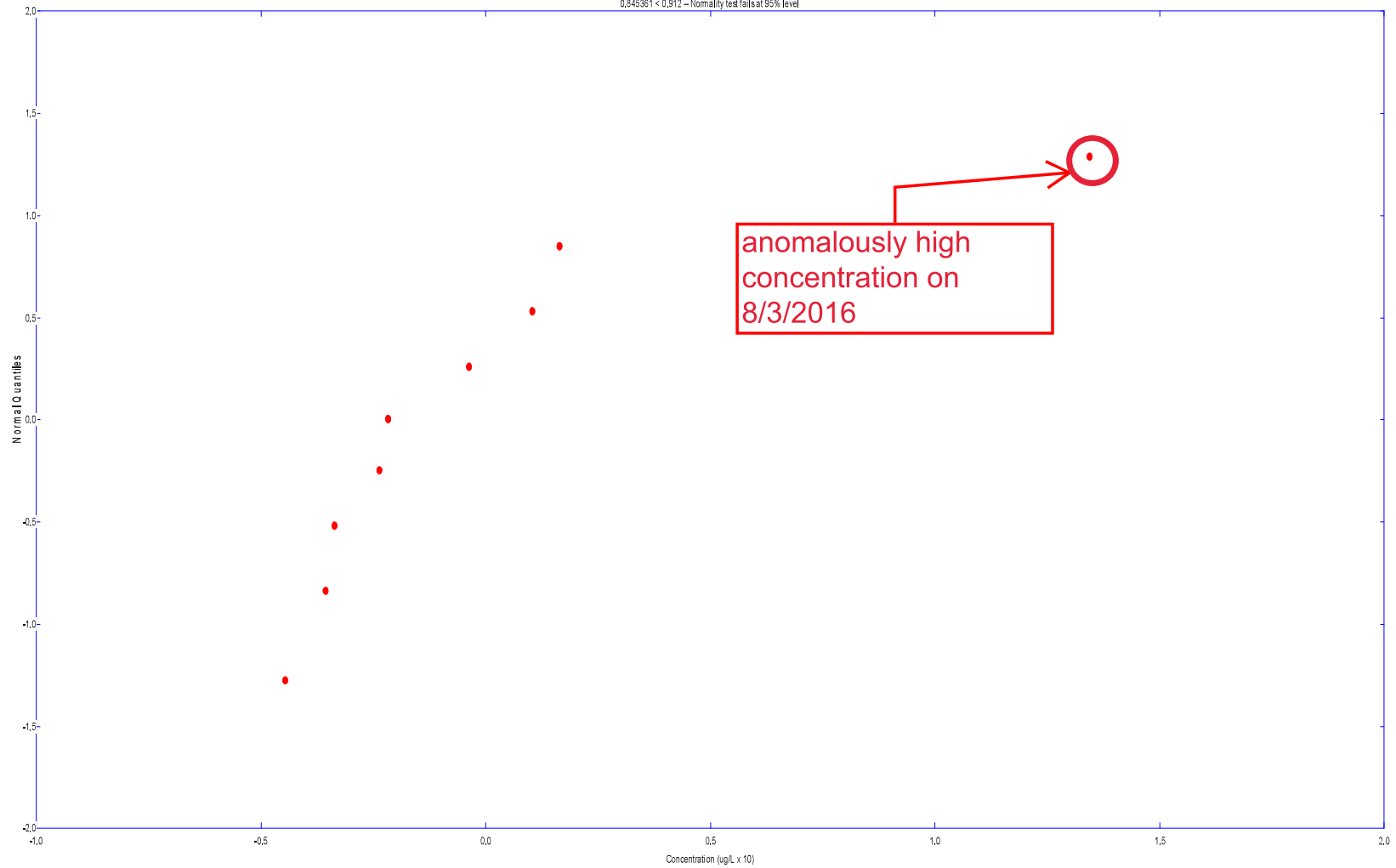

Cobalt
Probability Plot of Residuals for MW-16-07
Correlation Coefficient = 0,845361
0,845361 < 0,912 -- Normality test fails at 95% level

Dixon's Test for Outliers

Parameter: Cobalt

Location: MW-16-07

Original Data (Not Transformed)

Non-Detects Replaced with 1/2 DL

For 9 Measurements...

1% Level of Significance

Iteration	Highest	Lowest	Critical	Outlier
1	0.694118	0.147541	0.635	21
2	0.115385	0.163636	0.683	None

Loc.	Date	Conc.	Outlier
------	------	-------	---------

MW-16-07	8/3/2016	21	TRUE
	9/22/2016	7.2	FALSE
	11/9/2016	8.6	FALSE
	1/10/2017	3.1	FALSE
	2/27/2017	5.4	FALSE
	4/18/2017	5.2	FALSE
	6/6/2017	4.2	FALSE
	7/25/2017	9.2	FALSE
	9/14/2017	4	FALSE

Cobalt
Probability Plot of Residuals for MW-16-07
Correlation Coefficient = 0,971088
0,971088 > 0,905 – Normality test succeeds at 95% level

with outliers removed

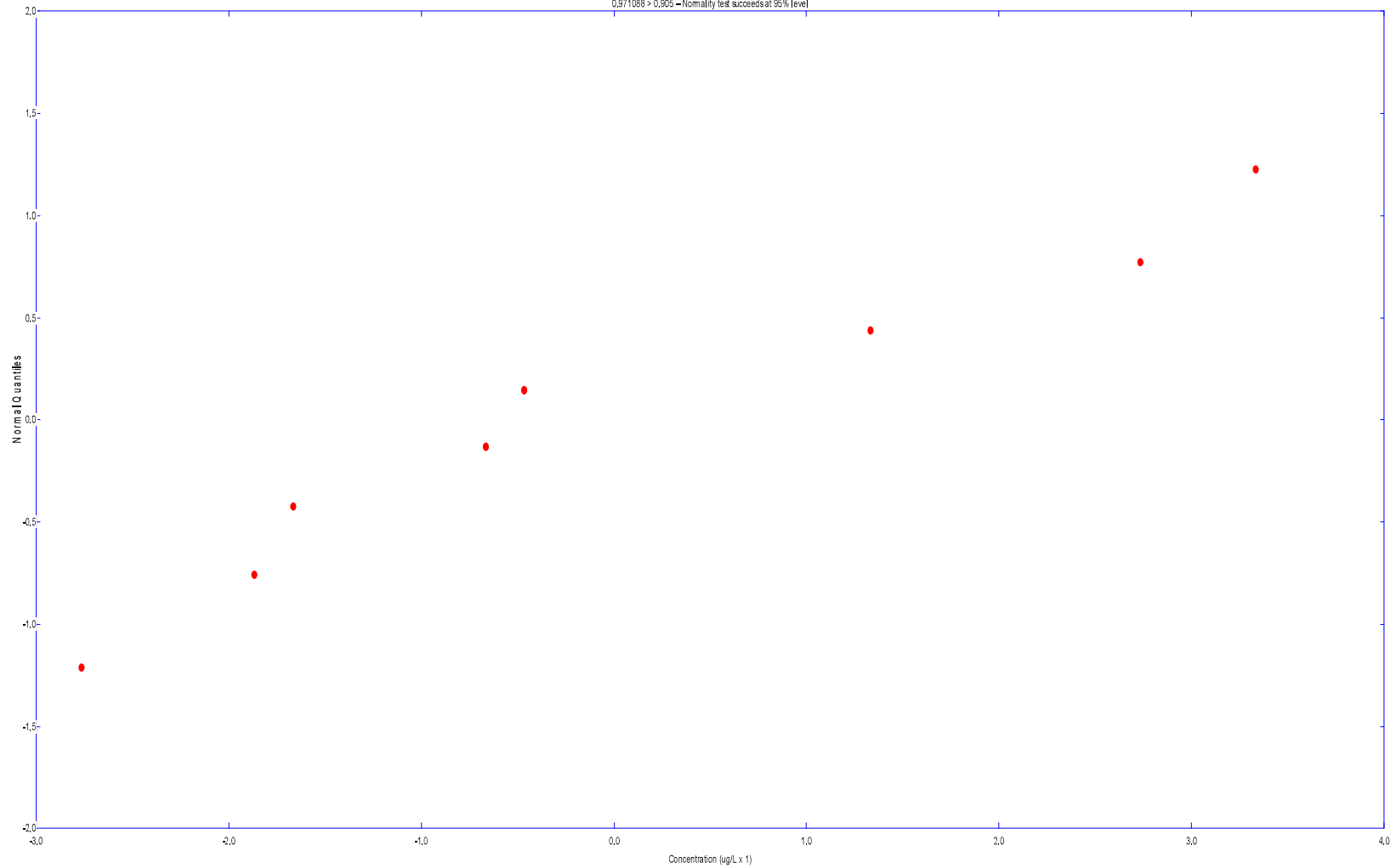

Cobalt
Probability Plot of Residuals for MW-16-07
Correlation Coefficient = 0,971088
0,971088 > 0,905 – Normality test succeeds at 95% level

Cobalt
Probability Plot of Residuals for MW-16-11A

Correlation Coefficient = 0,794749
0,794749 < 0,905 – Normality test fails at 95% level

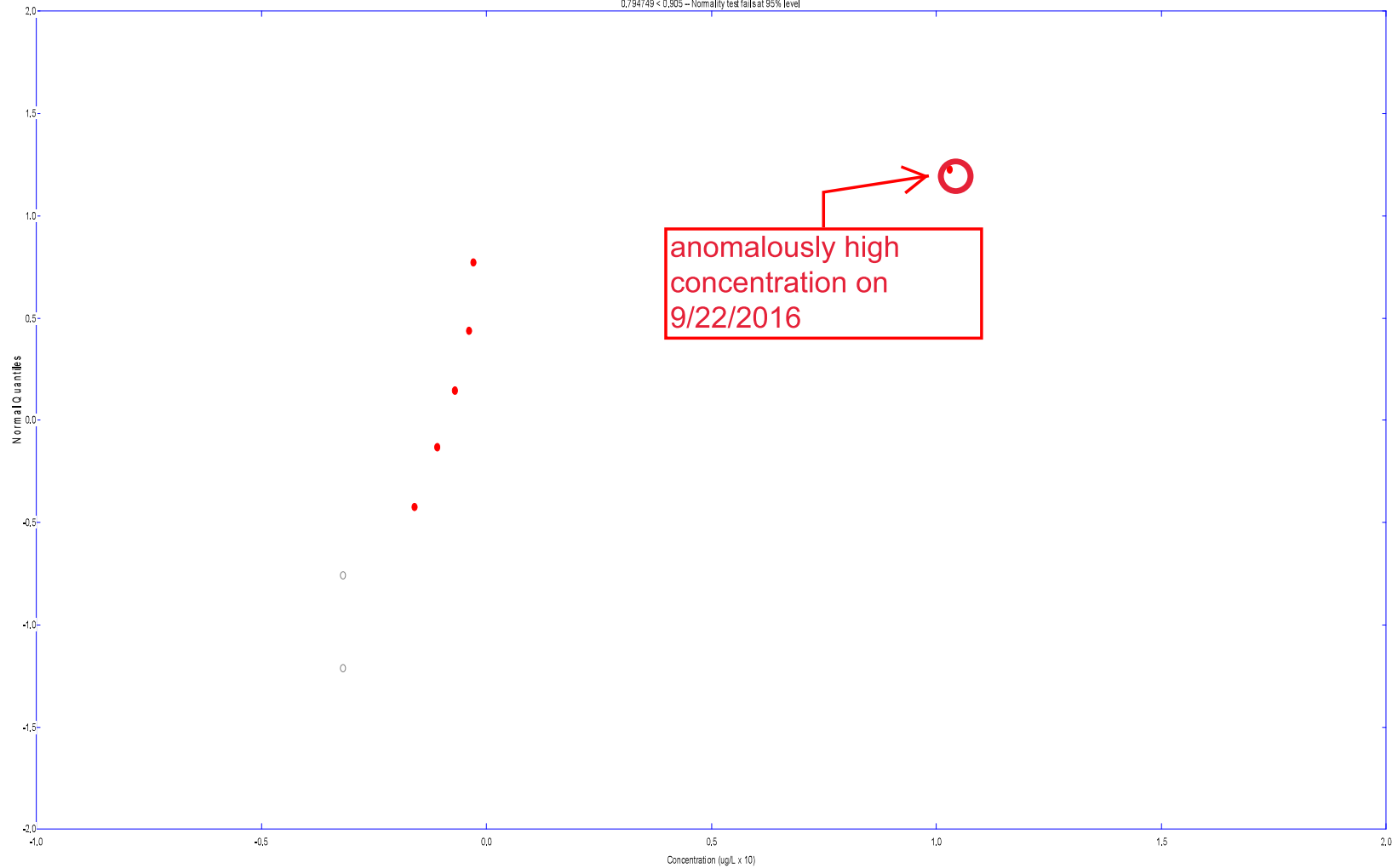

Cobalt

Probability Plot of Residuals for MW-16-11A

Correlation Coefficient = 0,794749
0,794749 < 0,905 – Normality test fails at 95% level

Dixon's Test for Outliers

Parameter: Cobalt

Location: MW-16-11A

Original Data (Not Transformed)

Non-Detects Replaced with 1/2 DL

For 8 Measurements...

1% Level of Significance

Iteration	Highest	Lowest	Critical	Outlier
1	0.785185	0	0.683	14
2	0.0344828	0	0.637	None

Loc.	Date	Conc.	Outlier
------	------	-------	---------

MW-16-11A	8/2/2016	3	FALSE
	9/22/2016	14	TRUE
	11/7/2016	3.3	FALSE
	1/11/2017	3.4	FALSE
	5/18/2017 ~	2.6	FALSE
	6/30/2017 ~	ND<0.5 U	FALSE
	7/25/2017	2.1	FALSE
	9/12/2017	ND<0.5 U	FALSE

Cobalt
Probability Plot of Residuals for MW-16-11A
Correlation Coefficient = 0,931783
0,931783 > 0,899 – Normality test succeeds at 95% level

with outliers removed

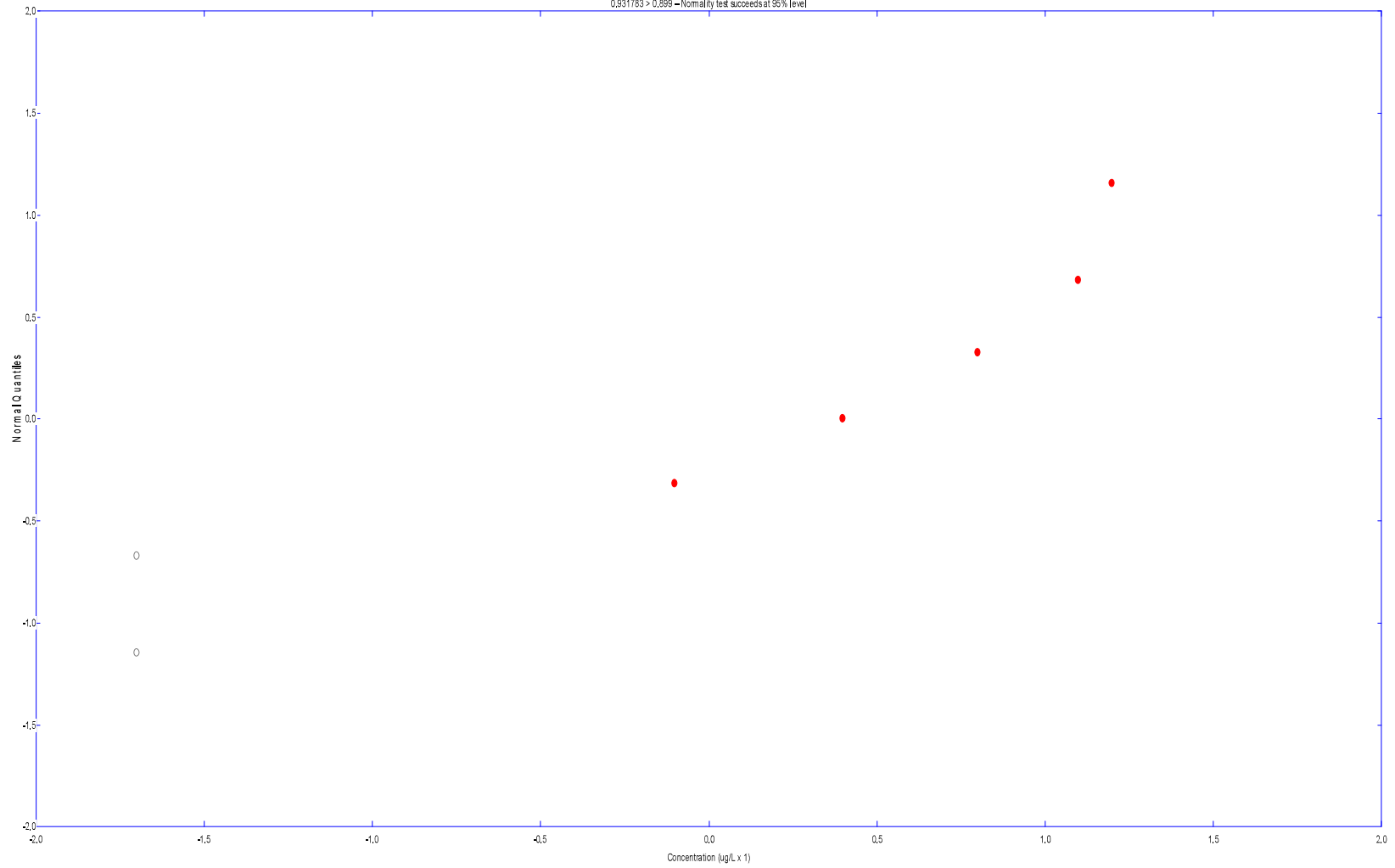

Cobalt
Probability Plot of Residuals for MW-16-11A
Correlation Coefficient = 0,931783
0,931783 > 0,899 – Normality test succeeds at 95% level

Lead
Probability Plot of Residuals for MW-16-07
Correlation Coefficient = 0,803773
0,803773 < 0,912 -- Normality test fails at 95% level

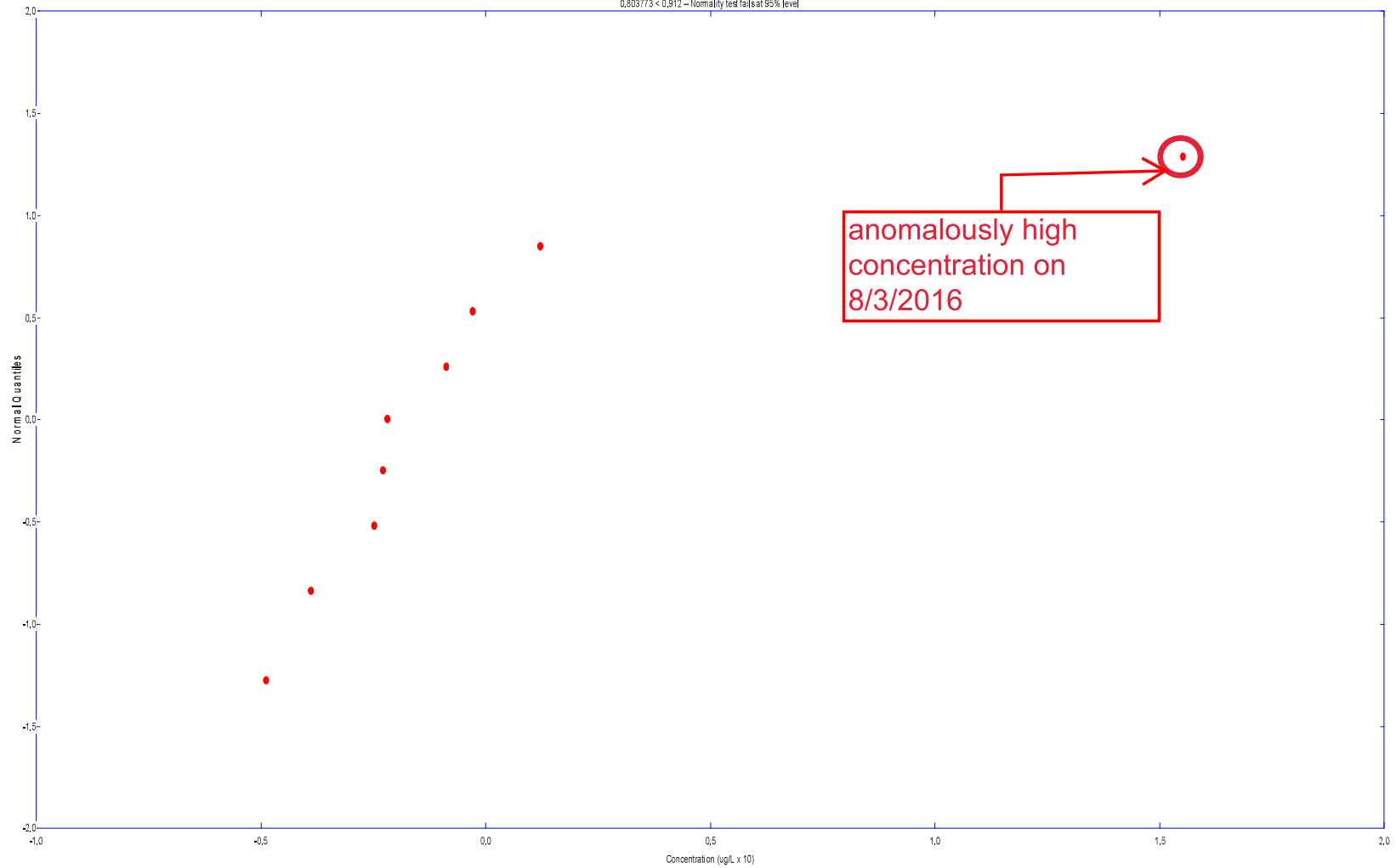

Lead
Probability Plot of Residuals for MW-16-07
Correlation Coefficient = 0,803773
0,803773 < 0,912 -- Normality test fails at 95% level

Dixon's Test for Outliers

Parameter: Lead

Location: MW-16-07

Original Data (Not Transformed)

Non-Detects Replaced with 1/2 DL

For 9 Measurements...

1% Level of Significance

Iteration	Highest	Lowest	Critical	Outlier
1	0.737113	0.163934	0.635	23
2	0.294118	0.217391	0.683	None

Loc.	Date	Conc.	Outlier
------	------	-------	---------

MW-16-07	8/3/2016	23	TRUE
	9/22/2016	6.6	FALSE
	11/9/2016	7.2	FALSE
	1/10/2017	2.6	FALSE
	2/27/2017	5.3	FALSE
	4/18/2017	5.2	FALSE
	6/6/2017	3.6	FALSE
	7/25/2017	8.7	FALSE
	9/14/2017	5	FALSE

Lead
Probability Plot of Residuals for MW-16-07
Correlation Coefficient = 0,988629
0,988629 > 0,905 – Normality test succeeds at 95% level

with outliers removed

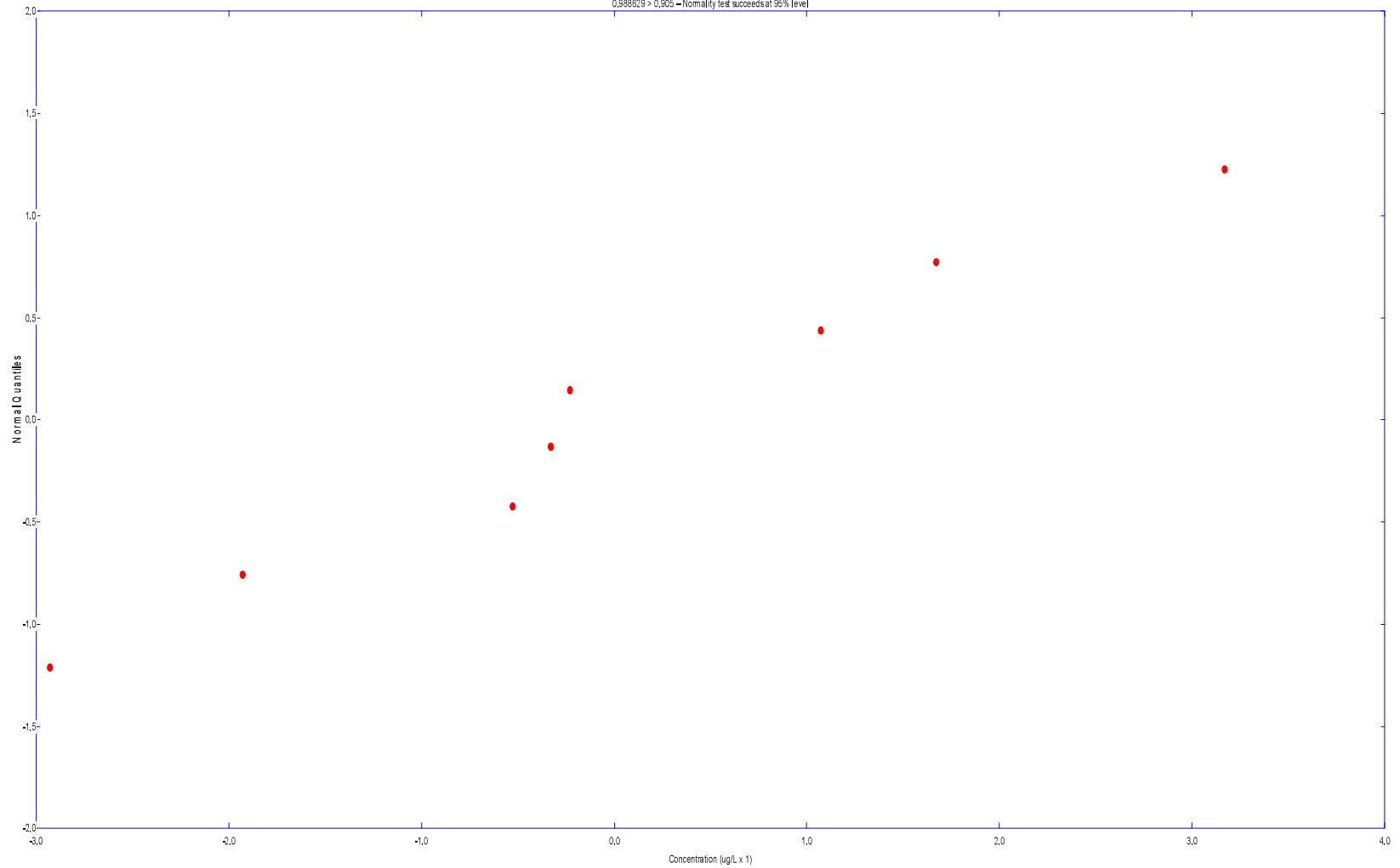

Lead
Probability Plot of Residuals for MW-16-07
Correlation Coefficient = 0,988629
0,988629 > 0,905 – Normality test succeeds at 95% level

Lead
Probability Plot of Residuals for MW-16-11A
Correlation Coefficient = 0.736608
0.736608 < 0.905 -- Normality test fails at 95% level

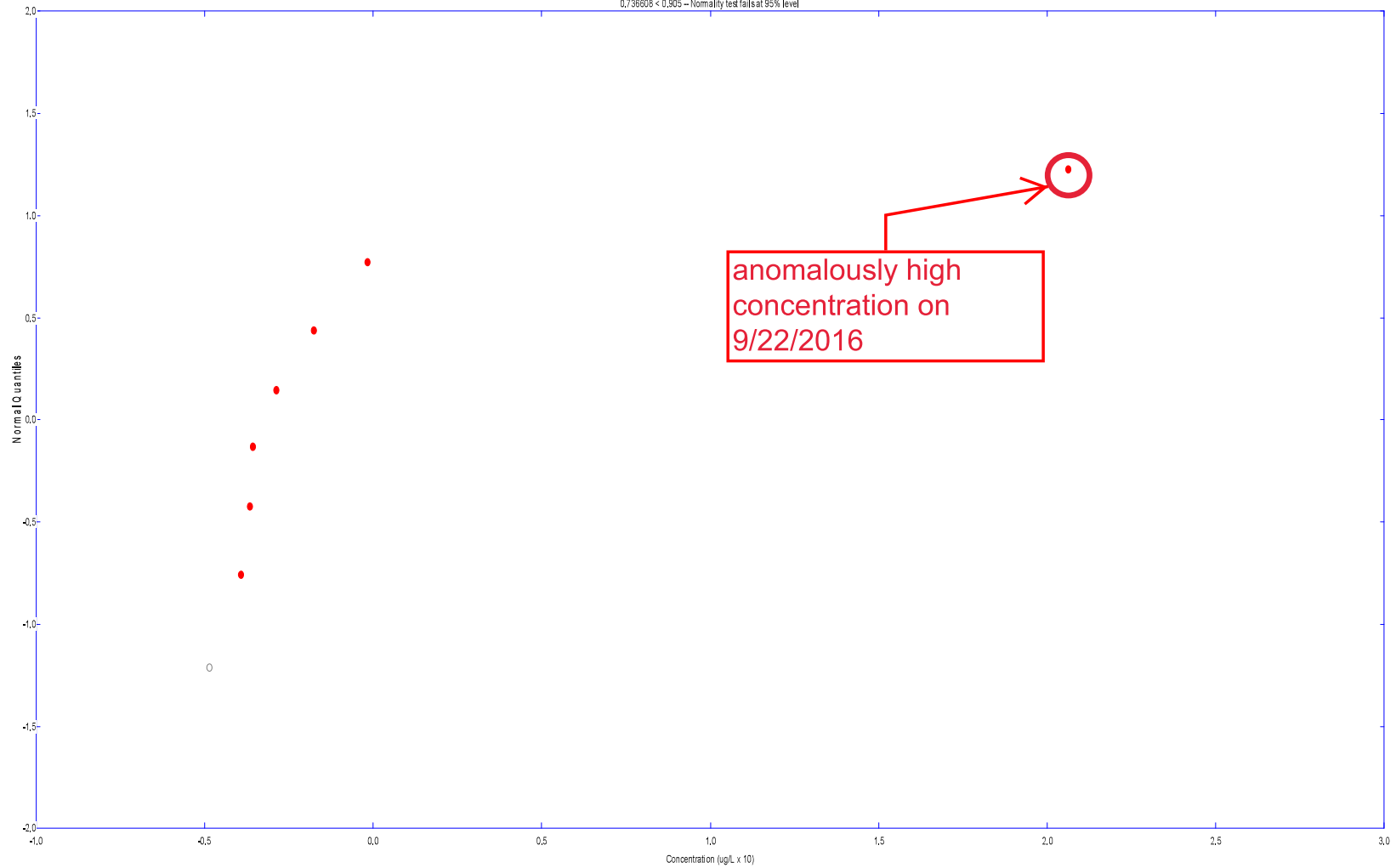

Lead
Probability Plot of Residuals for MW-16-11A
Correlation Coefficient = 0.736608
0.736608 < 0.905 -- Normality test fails at 95% level

Dixon's Test for Outliers

Parameter: Lead

Location: MW-16-11A

Original Data (Not Transformed)

Non-Detects Replaced with 1/2 DL

For 8 Measurements...

1% Level of Significance

Iteration	Highest	Lowest	Critical	Outlier
1	0.847251	0.202128	0.683	26
2	0.340426	0.202128	0.637	None

Loc.	Date	Conc.	Outlier
------	------	-------	---------

MW-16-11A	8/2/2016	3.6	FALSE
	9/22/2016	26	TRUE
	11/7/2016	1.8	FALSE
	1/11/2017	5.2	FALSE
	5/18/2017 ~	2.5	FALSE
	6/30/2017 ~	1.45	FALSE
	7/25/2017	1.7	FALSE
	9/12/2017	ND<0.5 U	FALSE

Lead
Probability Plot of Residuals for MW-16-11A
Correlation Coefficient = 0,96014
0,96014 > 0,899 – Normality test succeeds at 95% level

with outliers removed

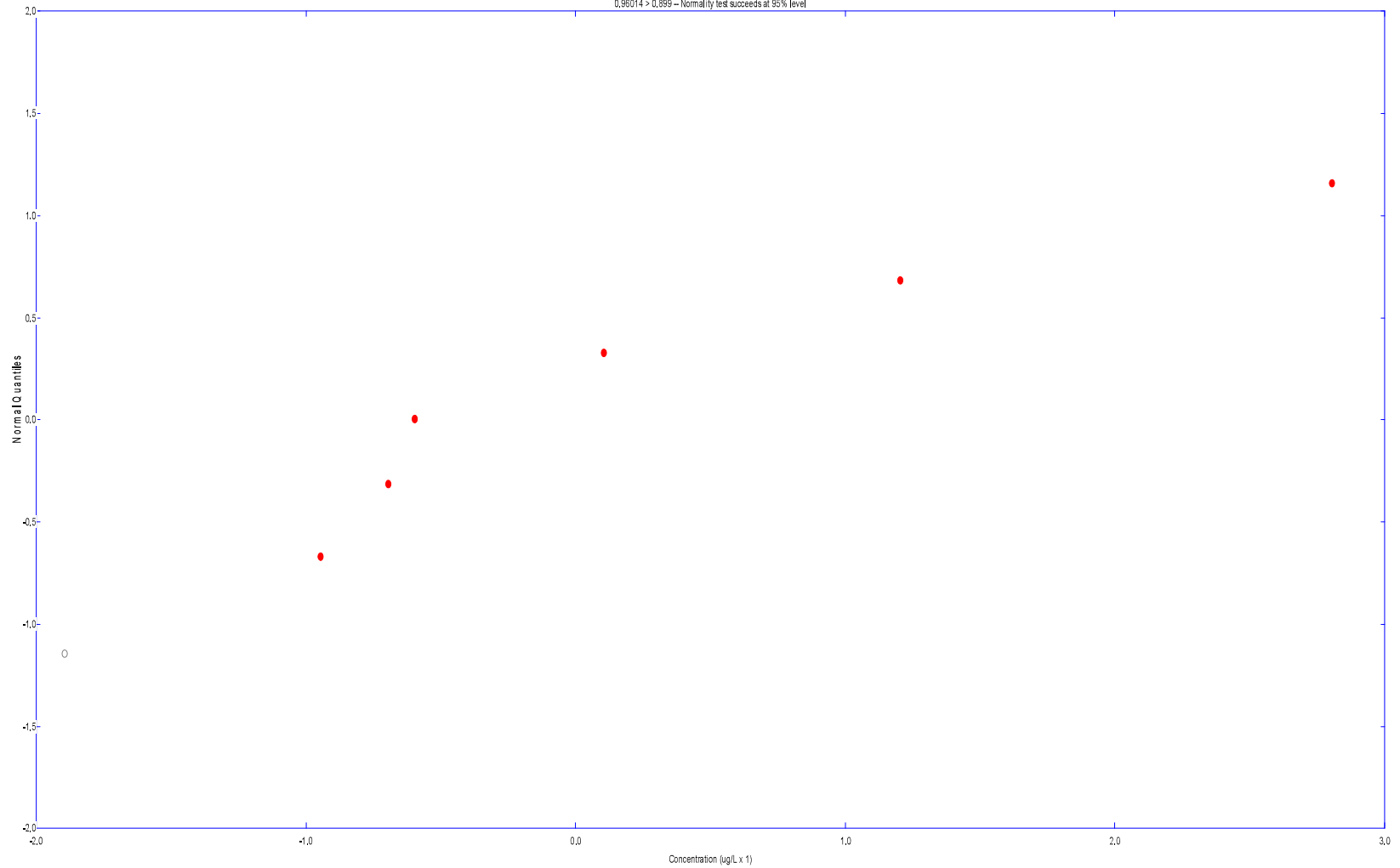

Lead
Probability Plot of Residuals for MW-16-11A
Correlation Coefficient = 0,96014
0,96014 > 0,899 – Normality test succeeds at 95% level

Radium-226/228
Probability Plot of Residuals for MW-16-11A

Correlation Coefficient = 0,714919
0,714919 < 0,905 – Normality test fails at 95% level

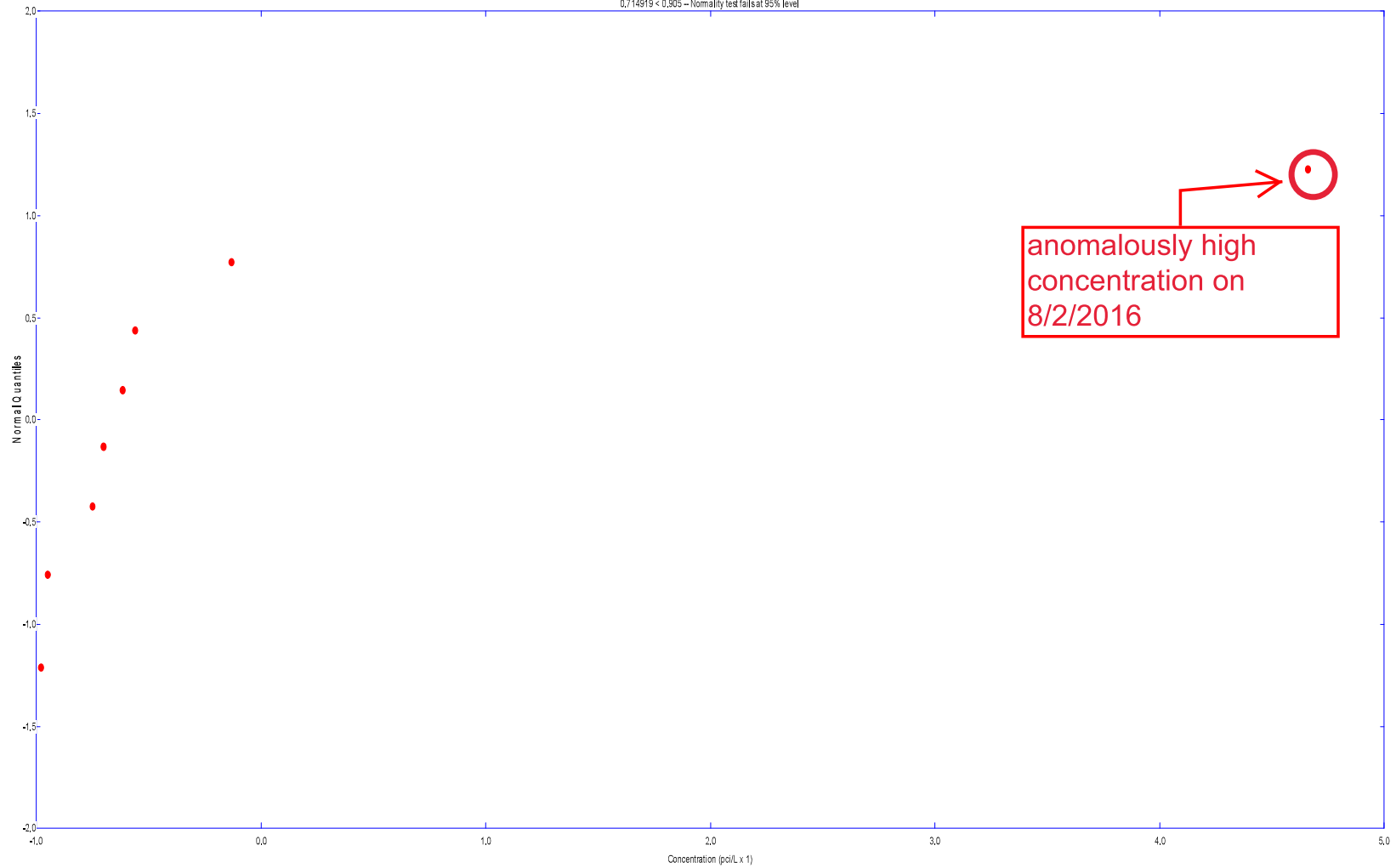

anomalously high
concentration on
8/2/2016

Radium-226/228
Probability Plot of Residuals for MW-16-11A

Correlation Coefficient = 0,714919
0,714919 < 0,905 – Normality test fails at 95% level

Dixon's Test for Outliers

Parameter: Radium-226/228

Location: MW-16-11A

Original Data (Not Transformed)

Non-Detects Replaced with 1/2 DL

For 8 Measurements...

1% Level of Significance

Iteration	Highest	Lowest	Critical	Outlier
1	0.853832	0.0352941	0.683	6.94
2	0.505882	0.0352941	0.637	None

Loc.	Date	Conc.	Outlier
------	------	-------	---------

MW-16-11A	8/2/2016	6.94	TRUE
	9/22/2016	2.15	FALSE
	11/7/2016	1.72	FALSE
	1/11/2017	1.33	FALSE
	5/18/2017 ~	1.53	FALSE
	6/30/2017 ~	1.665	FALSE
	7/25/2017	1.58	FALSE
	9/12/2017	1.3	FALSE

Radium-226/228
Probability Plot of Residuals for MW-16-11A
Correlation Coefficient = 0,949339
0,949339 > 0,899 – Normality test succeeds at 95% level

with outliers removed

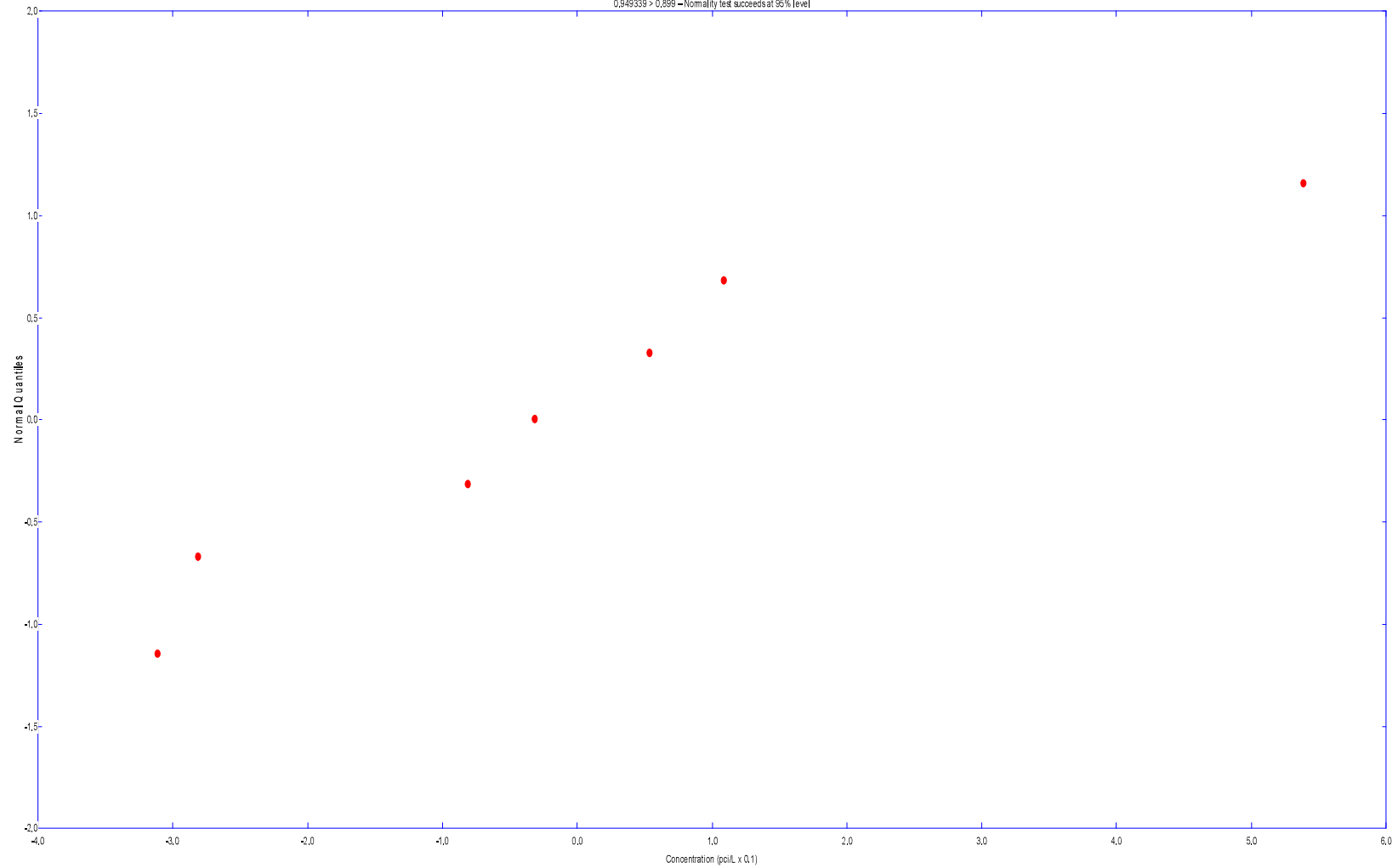

Radium-226/228
Probability Plot of Residuals for MW-16-11A
Correlation Coefficient = 0,949339
0,949339 > 0,899 – Normality test succeeds at 95% level

Concentrations (ug/L)

Parameter: Antimony

Original Data (Not Transformed)

Non-Detects Replaced with 1/2 DL

Total Measurements: 51

Total Non-Detect: 46

Percent Non-Detects: 90.1961%

Total Background Measurements: 0

There are 0 background locations

Loc.	Meas.	ND	Date	Conc.	Original
------	-------	----	------	-------	----------

There are 6 compliance locations

Loc.	Meas.	ND	Date	Conc.	Original
------	-------	----	------	-------	----------

MW-16-05	9	9 (100%)	8/3/2016	ND<1 U	ND<2 U
			9/20/2016	ND<1 U	ND<2 U
			11/8/2016	ND<1 U	ND<2 U
			1/9/2017	ND<1 U	ND<2 U
			3/1/2017	ND<1 U	ND<2 U
			4/18/2017	ND<1 U	ND<2 U
			6/6/2017	ND<1 U	ND<2 U
			7/25/2017	ND<1 U	ND<2 U
			9/13/2017	ND<1 U	ND<2 U

MW-16-06	9	9 (100%)	8/3/2016 ~	ND<1 U	ND<2 U
			9/20/2016	ND<1 U	ND<2 U
			11/9/2016	ND<1 U	ND<2 U
			1/10/2017	ND<1 U	ND<2 U
			2/28/2017	ND<1 U	ND<2 U
			4/18/2017	ND<1 U	ND<2 U
			6/6/2017 ~	ND<1 U	ND<2 U
			7/25/2017	ND<1 U	ND<2 U
			9/14/2017 ~	ND<1 U	ND<2 U

MW-16-07	9	9 (100%)	8/3/2016	ND<1 U	ND<2 U
			9/22/2016	ND<1 U	ND<2 U
			11/9/2016	ND<1 U	ND<2 U
			1/10/2017	ND<1 U	ND<2 U
			2/27/2017	ND<1 U	ND<2 U
			4/18/2017	ND<1 U	ND<2 U
			6/6/2017	ND<1 U	ND<2 U
			7/25/2017	ND<1 U	ND<2 U
			9/14/2017	ND<1 U	ND<2 U

MW-16-08	9	8 (88.8889%)	8/3/2016	2.1	2.1
			9/19/2016	ND<1 U	ND<2 U
			11/8/2016	ND<1 U	ND<2 U
			1/10/2017	ND<1 U	ND<2 U
			2/28/2017	ND<1 U	ND<2 U
			4/18/2017	ND<1 U	ND<2 U
			6/7/2017	ND<1 U	ND<2 U
			7/25/2017	ND<1 U	ND<2 U
			9/12/2017	ND<1 U	ND<2 U

MW-16-10	7	6 (85.7143%)	8/2/2016	2.1	2.1
			9/19/2016	ND<1 U	ND<2 U
			11/8/2016	ND<1 U	ND<2 U
			1/11/2017	ND<1 U	ND<2 U
			2/28/2017	ND<1 U	ND<2 U
			7/26/2017	ND<1 U	ND<2 U
			9/12/2017	ND<1 U	ND<2 U
			4/18/2017	ND<1 U	ND<2 U
			6/6/2017	ND<1 U	ND<2 U
8/9/2017 ~	ND<1 U	ND<2 U			

			8/30/2017 ~	ND<1 U	ND<2 U
MW-16-11A	8	5 (62.5%)	8/2/2016	2.1	2.1
			9/22/2016	ND<1 U	ND<2 U
			11/7/2016	ND<1 U	ND<2 U
			1/11/2017	ND<1 U	ND<2 U
			5/18/2017 ~	3.2	3.2
			6/30/2017 ~	2	2
			7/25/2017	ND<1 U	ND<2 U
			9/12/2017	ND<1 U	ND<2 U
			6/6/2017	2.4	2.4

There are 0 unused locations

Loc.	Meas.	ND	Date	Conc.	Original
------	-------	----	------	-------	----------

Concentrations (ug/L)

Parameter: Arsenic

Original Data (Not Transformed)

Non-Detects Replaced with 1/2 DL

Total Measurements: 50

Total Non-Detect: 27

Percent Non-Detects: 54%

Total Background Measurements: 0

There are 0 background locations

Loc.	Meas.	ND	Date	Conc.	Original
------	-------	----	------	-------	----------

There are 6 compliance locations

Loc.	Meas.	ND	Date	Conc.	Original
------	-------	----	------	-------	----------

MW-16-05	9	6 (66.6667%)	8/3/2016	14	14
			9/20/2016	5.6	5.6
			11/8/2016	5.1	5.1
			1/9/2017	ND<2.5 U	ND<5 U
			3/1/2017	ND<2.5 U	ND<5 U
			4/18/2017	ND<2.5 U	ND<5 U
			6/6/2017	ND<2.5 U	ND<5 U
			7/25/2017	ND<2.5 U	ND<5 U
			9/13/2017	ND<2.5 U	ND<5 U

MW-16-06	9	8 (88.8889%)	8/3/2016 ~	7.45	7.45
			9/20/2016	ND<2.5 U	ND<5 U
			11/9/2016	ND<2.5 U	ND<5 U
			1/10/2017	ND<2.5 U	ND<5 U
			2/28/2017	ND<2.5 U	ND<5 U
			4/18/2017	ND<2.5 U	ND<5 U
			6/6/2017 ~	ND<2.5 U	ND<5 U
			7/25/2017	ND<2.5 U	ND<5 U
9/14/2017 ~	ND<2.5 U	ND<5 U			

MW-16-07	8	2 (25%)	9/22/2016	8.1	8.1
			11/9/2016	8.7	8.7
			1/10/2017	ND<2.5 U	ND<5 U
			2/27/2017	6.8	6.8
			4/18/2017	7.2	7.2
			6/6/2017	ND<2.5 U	ND<5 U
			7/25/2017	11	11
			9/14/2017	6.2	6.2
			8/3/2016	28	28

MW-16-08	9	3 (33.3333%)	8/3/2016	21	21
			9/19/2016	15	15
			11/8/2016	12	12
			1/10/2017	9.2	9.2
			2/28/2017	ND<2.5 U	ND<5 U
			4/18/2017	7.2	7.2
			6/7/2017	ND<2.5 U	ND<5 U
			7/25/2017	5.4	5.4
			9/12/2017	ND<2.5 U	ND<5 U

MW-16-10	7	5 (71.4286%)	8/2/2016	11	11
			9/19/2016	5.5	5.5
			11/8/2016	ND<2.5 U	ND<5 U
			1/11/2017	ND<2.5 U	ND<5 U
			2/28/2017	ND<2.5 U	ND<5 U
			7/26/2017	ND<2.5 U	ND<5 U
			9/12/2017	ND<2.5 U	ND<5 U
			4/18/2017	ND<2.5 U	ND<5 U
			6/6/2017	ND<2.5 U	ND<5 U
8/9/2017 ~	ND<2.5 U	ND<5 U			

			8/30/2017 ~	ND<2.5 U	ND<5 U
MW-16-11A	8	3 (37.5%)	8/2/2016	9.7	9.7
			9/22/2016	17	17
			11/7/2016	ND<2.5 U	ND<5 U
			1/11/2017	9	9
			5/18/2017 ~	5.4	5.4
			6/30/2017 ~	5.25	5.25
			7/25/2017	ND<2.5 U	ND<5 U
			9/12/2017	ND<2.5 U	ND<5 U
			6/6/2017	ND<2.5 U	ND<5 U

There are 0 unused locations

Loc.	Meas.	ND	Date	Conc.	Original
------	-------	----	------	-------	----------

Concentrations (ug/L)

Parameter: Barium

Original Data (Not Transformed)

Non-Detects Replaced with 1/2 DL

Total Measurements: 51

Total Non-Detect: 0

Percent Non-Detects: 0%

Total Background Measurements: 0

There are 0 background locations

Loc.	Meas.	ND	Date	Conc.	Original
There are 6 compliance locations					
Loc.	Meas.	ND	Date	Conc.	Original
MW-16-05	9	0 (0%)	8/3/2016	340	340
			9/20/2016	330	330
			11/8/2016	280	280
			1/9/2017	280	280
			3/1/2017	270	270
			4/18/2017	280	280
			6/6/2017	280	280
			7/25/2017	290	290
			9/13/2017	300	300
MW-16-06	9	0 (0%)	8/3/2016 ~	270	270
			9/20/2016	300	300
			11/9/2016	260	260
			1/10/2017	270	270
			2/28/2017	270	270
			4/18/2017	260	260
			6/6/2017 ~	270	270
			7/25/2017	300	300
			9/14/2017 ~	300	300
MW-16-07	9	0 (0%)	8/3/2016	450	450
			9/22/2016	370	370
			11/9/2016	330	330
			1/10/2017	290	290
			2/27/2017	320	320
			4/18/2017	300	300
			6/6/2017	290	290
			7/25/2017	330	330
			9/14/2017	330	330
MW-16-08	9	0 (0%)	8/3/2016	390	390
			9/19/2016	430	430
			11/8/2016	330	330
			1/10/2017	320	320
			2/28/2017	290	290
			4/18/2017	310	310
			6/7/2017	300	300
			7/25/2017	370	370
			9/12/2017	380	380
MW-16-10	7	0 (0%)	8/2/2016	150	150
			9/19/2016	150	150
			11/8/2016	120	120
			1/11/2017	110	110
			2/28/2017	100	100
			7/26/2017	110	110
			9/12/2017	140	140
			4/18/2017	75	75
			6/6/2017	65	65
8/9/2017 ~	115	115			

			8/30/2017 ~	99.5	99.5
MW-16-11A	8	0 (0%)	8/2/2016	300	300
			9/22/2016	480	480
			11/7/2016	120	120
			1/11/2017	360	360
			5/18/2017 ~	280	280
			6/30/2017 ~	270	270
			7/25/2017	300	300
			9/12/2017	310	310
			6/6/2017	260	260

There are 0 unused locations

Loc.	Meas.	ND	Date	Conc.	Original
------	-------	----	------	-------	----------

Concentrations (ug/L)

Parameter: Beryllium

Original Data (Not Transformed)

Non-Detects Replaced with 1/2 DL

Total Measurements: 51

Total Non-Detect: 47

Percent Non-Detects: 92.1569%

Total Background Measurements: 0

There are 0 background locations

Loc.	Meas.	ND	Date	Conc.	Original
------	-------	----	------	-------	----------

There are 6 compliance locations

Loc.	Meas.	ND	Date	Conc.	Original
------	-------	----	------	-------	----------

MW-16-05	9	9 (100%)	8/3/2016	ND<0.5 U	ND<1 U
			9/20/2016	ND<0.5 U	ND<1 U
			11/8/2016	ND<0.5 U	ND<1 U
			1/9/2017	ND<0.5 U^	ND<1 U^
			3/1/2017	ND<0.5 U	ND<1 U
			4/18/2017	ND<0.5 U	ND<1 U
			6/6/2017	ND<0.5 U	ND<1 U
			7/25/2017	ND<0.5 U	ND<1 U
			9/13/2017	ND<0.5 U	ND<1 U

MW-16-06	9	9 (100%)	8/3/2016 ~	ND<0.5 U	ND<1 U
			9/20/2016	ND<0.5 U	ND<1 U
			11/9/2016	ND<0.5 U	ND<1 U
			1/10/2017	ND<0.5 U^	ND<1 U^
			2/28/2017	ND<0.5 U	ND<1 U
			4/18/2017	ND<0.5 U	ND<1 U
			6/6/2017 ~	ND<0.5 U	ND<1 U
			7/25/2017	ND<0.5 U	ND<1 U
			9/14/2017 ~	ND<0.5 U	ND<1 U

MW-16-07	9	8 (88.8889%)	8/3/2016	1.7	1.7
			9/22/2016	ND<0.5 U	ND<1 U
			11/9/2016	ND<0.5 U	ND<1 U
			1/10/2017	ND<0.5 U^	ND<1 U^
			2/27/2017	ND<0.5 U	ND<1 U
			4/18/2017	ND<0.5 U	ND<1 U
			6/6/2017	ND<0.5 U	ND<1 U
			7/25/2017	ND<0.5 U	ND<1 U
			9/14/2017	ND<0.5 U	ND<1 U

MW-16-08	9	7 (77.7778%)	8/3/2016	1.2	1.2
			9/19/2016	1.6	1.6
			11/8/2016	ND<0.5 U	ND<1 U
			1/10/2017	ND<0.5 U^	ND<1 U^
			2/28/2017	ND<0.5 U	ND<1 U
			4/18/2017	ND<0.5 U	ND<1 U
			6/7/2017	ND<0.5 U	ND<1 U
			7/25/2017	ND<0.5 U	ND<1 U
			9/12/2017	ND<0.5 U	ND<1 U

MW-16-10	7	7 (100%)	8/2/2016	ND<0.5 U	ND<1 U
			9/19/2016	ND<0.5 U	ND<1 U
			11/8/2016	ND<0.5 U	ND<1 U
			1/11/2017	ND<0.5 U	ND<1 U
			2/28/2017	ND<0.5 U	ND<1 U
			7/26/2017	ND<0.5 U	ND<1 U
			9/12/2017	ND<0.5 U	ND<1 U
			4/18/2017	ND<0.5 U	ND<1 U
			6/6/2017	ND<0.5 U	ND<1 U
			8/9/2017 ~	ND<0.5 U	ND<1 U

			8/30/2017 ~	ND<0.5 U	ND<1 U
MW-16-11A	8	7 (87.5%)	8/2/2016	ND<0.5 U	ND<1 U
			9/22/2016	1.6	1.6
			11/7/2016	ND<0.5 U	ND<1 U
			1/11/2017	ND<0.5 U	ND<1 U
			5/18/2017 ~	ND<0.5 U	ND<1 U
			6/30/2017 ~	ND<0.5 U	ND<1 U
			7/25/2017	ND<0.5 U	ND<1 U
			9/12/2017	ND<0.5 U	ND<1 U
			6/6/2017	ND<0.5 U	ND<1 U

There are 0 unused locations

Loc.	Meas.	ND	Date	Conc.	Original
------	-------	----	------	-------	----------

Concentrations (ug/L)

Parameter: Cadmium

Original Data (Not Transformed)

Non-Detects Replaced with 1/2 DL

Total Measurements: 51

Total Non-Detect: 49

Percent Non-Detects: 96.0784%

Total Background Measurements: 0

There are 0 background locations

Loc.	Meas.	ND	Date	Conc.	Original
------	-------	----	------	-------	----------

There are 6 compliance locations

Loc.	Meas.	ND	Date	Conc.	Original
------	-------	----	------	-------	----------

MW-16-05	9	9 (100%)	8/3/2016	ND<0.5 U	ND<1 U
			9/20/2016	ND<0.5 U	ND<1 U
			11/8/2016	ND<0.5 U	ND<1 U
			1/9/2017	ND<0.5 U	ND<1 U
			3/1/2017	ND<0.5 U	ND<1 U
			4/18/2017	ND<0.5 U	ND<1 U
			6/6/2017	ND<0.5 U	ND<1 U
			7/25/2017	ND<0.5 U	ND<1 U
			9/13/2017	ND<0.5 U	ND<1 U

MW-16-06	9	9 (100%)	8/3/2016 ~	ND<0.5 U	ND<1 U
			9/20/2016	ND<0.5 U	ND<1 U
			11/9/2016	ND<0.5 U	ND<1 U
			1/10/2017	ND<0.5 U	ND<1 U
			2/28/2017	ND<0.5 U	ND<1 U
			4/18/2017	ND<0.5 U	ND<1 U
			6/6/2017 ~	ND<0.5 U	ND<1 U
			7/25/2017	ND<0.5 U	ND<1 U
			9/14/2017 ~	ND<0.5 U	ND<1 U

MW-16-07	9	8 (88.8889%)	8/3/2016	1.3	1.3
			9/22/2016	ND<0.5 U	ND<1 U
			11/9/2016	ND<0.5 U	ND<1 U
			1/10/2017	ND<0.5 U	ND<1 U
			2/27/2017	ND<0.5 U	ND<1 U
			4/18/2017	ND<0.5 U	ND<1 U
			6/6/2017	ND<0.5 U	ND<1 U
			7/25/2017	ND<0.5 U	ND<1 U
			9/14/2017	ND<0.5 U	ND<1 U

MW-16-08	9	8 (88.8889%)	8/3/2016	1.5	1.5
			9/19/2016	ND<0.5 U	ND<1 U
			11/8/2016	ND<0.5 U	ND<1 U
			1/10/2017	ND<0.5 U	ND<1 U
			2/28/2017	ND<0.5 U	ND<1 U
			4/18/2017	ND<0.5 U	ND<1 U
			6/7/2017	ND<0.5 U	ND<1 U
			7/25/2017	ND<0.5 U	ND<1 U
			9/12/2017	ND<0.5 U	ND<1 U

MW-16-10	7	7 (100%)	8/2/2016	ND<0.5 U	ND<1 U
			9/19/2016	ND<0.5 U	ND<1 U
			11/8/2016	ND<0.5 U	ND<1 U
			1/11/2017	ND<0.5 U	ND<1 U
			2/28/2017	ND<0.5 U	ND<1 U
			7/26/2017	ND<0.5 U	ND<1 U
			9/12/2017	ND<0.5 U	ND<1 U
			4/18/2017	ND<0.5 U	ND<1 U
			6/6/2017	ND<0.5 U	ND<1 U
8/9/2017 ~	ND<0.5 U	ND<1 U			

			8/30/2017 ~	ND<0.5 U	ND<1 U
MW-16-11A	8	8 (100%)	8/2/2016	ND<0.5 U	ND<1 U
			9/22/2016	ND<0.5 U	ND<1 U
			11/7/2016	ND<0.5 U	ND<1 U
			1/11/2017	ND<0.5 U	ND<1 U
			5/18/2017 ~	ND<0.5 U	ND<1 U
			6/30/2017 ~	ND<0.5 U	ND<1 U
			7/25/2017	ND<0.5 U	ND<1 U
			9/12/2017	ND<0.5 U	ND<1 U
			6/6/2017	ND<0.5 U	ND<1 U

There are 0 unused locations

Loc.	Meas.	ND	Date	Conc.	Original
------	-------	----	------	-------	----------

Concentrations (ug/L)

Parameter: Chromium

Original Data (Not Transformed)

Non-Detects Replaced with 1/2 DL

Total Measurements: 49

Total Non-Detect: 8

Percent Non-Detects: 16.3265%

Total Background Measurements: 0

There are 0 background locations

Loc.	Meas.	ND	Date	Conc.	Original
------	-------	----	------	-------	----------

There are 6 compliance locations

Loc.	Meas.	ND	Date	Conc.	Original
------	-------	----	------	-------	----------

MW-16-05	9	0 (0%)	8/3/2016	24	24
			9/20/2016	12	12
			11/8/2016	9.2	9.2
			1/9/2017	6.3	6.3
			3/1/2017	4.2	4.2
			4/18/2017	6.9	6.9
			6/6/2017	2.9	2.9
			7/25/2017	4.4	4.4
			9/13/2017	5.6	5.6

MW-16-06	9	6 (66.6667%)	8/3/2016 ~	13.5	13.5
			9/20/2016	4.3	4.3
			11/9/2016	2.2	2.2
			1/10/2017	ND<1 U	ND<2 U
			2/28/2017	ND<1 U	ND<2 U
			4/18/2017	ND<1 U	ND<2 U
			6/6/2017 ~	ND<1 U	ND<2 U
			7/25/2017	ND<1 U	ND<2 U
			9/14/2017 ~	ND<1 U	ND<2 U

MW-16-07	8	0 (0%)	9/22/2016	19	19
			11/9/2016	18	18
			1/10/2017	6.1	6.1
			2/27/2017	12	12
			4/18/2017	11	11
			6/6/2017	7.6	7.6
			7/25/2017	14	14
			9/14/2017	8	8
			8/3/2016	53	53

MW-16-08	9	0 (0%)	8/3/2016	36	36
			9/19/2016	40	40
			11/8/2016	20	20
			1/10/2017	15	15
			2/28/2017	8	8
			4/18/2017	11	11
			6/7/2017	5.6	5.6
			7/25/2017	12	12
			9/12/2017	8.6	8.6

MW-16-10	7	1 (14.2857%)	8/2/2016	21	21
			9/19/2016	14	14
			11/8/2016	8.1	8.1
			1/11/2017	4.8	4.8
			2/28/2017	ND<1 U	ND<2 U
			7/26/2017	9.7	9.7
			9/12/2017	13	13
			4/18/2017	ND<1 U	ND<2 U
			6/6/2017	ND<1 U	ND<2 U
			8/9/2017 ~	7.35	7.35

			8/30/2017 ~	8.7	8.7
MW-16-11A	7	1 (14.2857%)	8/2/2016	10	10
			11/7/2016	8.3	8.3
			1/11/2017	8	8
			5/18/2017 ~	8.95	8.95
			6/30/2017 ~	ND<1 U	ND<2 U
			7/25/2017	6.6	6.6
			9/12/2017	3.1	3.1
			9/22/2016	39	39
			6/6/2017	3	3

There are 0 unused locations

Loc.	Meas.	ND	Date	Conc.	Original
------	-------	----	------	-------	----------

Concentrations (ug/L)

Parameter: Cobalt

Original Data (Not Transformed)

Non-Detects Replaced with 1/2 DL

Total Measurements: 49

Total Non-Detect: 10

Percent Non-Detects: 20.4082%

Total Background Measurements: 0

There are 0 background locations

Loc.	Meas.	ND	Date	Conc.	Original
There are 6 compliance locations					
Loc.	Meas.	ND	Date	Conc.	Original
MW-16-05	9	0 (0%)	8/3/2016	10	10
			9/20/2016	4.5	4.5
			11/8/2016	4.1	4.1
			1/9/2017	3.3	3.3
			3/1/2017	1.5	1.5
			4/18/2017	2.8	2.8
			6/6/2017	1.2	1.2
			7/25/2017	1.5	1.5
			9/13/2017	2.4	2.4
MW-16-06	9	7 (77.7778%)	8/3/2016 ~	4.7	4.7
			9/20/2016	1.4	1.4
			11/9/2016	ND<0.5 U	ND<1 U
			1/10/2017	ND<0.5 U	ND<1 U
			2/28/2017	ND<0.5 U	ND<1 U
			4/18/2017	ND<0.5 U	ND<1 U
			6/6/2017 ~	ND<0.5 U	ND<1 U
			7/25/2017	ND<0.5 U	ND<1 U
			9/14/2017 ~	ND<0.5 U	ND<1 U
MW-16-07	8	0 (0%)	9/22/2016	7.2	7.2
			11/9/2016	8.6	8.6
			1/10/2017	3.1	3.1
			2/27/2017	5.4	5.4
			4/18/2017	5.2	5.2
			6/6/2017	4.2	4.2
			7/25/2017	9.2	9.2
			9/14/2017	4	4
			8/3/2016	21	21
MW-16-08	9	0 (0%)	8/3/2016	13	13
			9/19/2016	16	16
			11/8/2016	9.4	9.4
			1/10/2017	8.1	8.1
			2/28/2017	2.8	2.8
			4/18/2017	5.1	5.1
			6/7/2017	2.4	2.4
			7/25/2017	5.2	5.2
			9/12/2017	3.3	3.3
MW-16-10	7	1 (14.2857%)	8/2/2016	12	12
			9/19/2016	5.8	5.8
			11/8/2016	3.3	3.3
			1/11/2017	2.6	2.6
			2/28/2017	ND<0.5 U	ND<1 U
			7/26/2017	3.8	3.8
			9/12/2017	5.9	5.9
			4/18/2017	ND<0.5 U	ND<1 U
			6/6/2017	ND<0.5 U	ND<1 U
8/9/2017 ~	3.6	3.6			

			8/30/2017 ~	2.95	2.95
MW-16-11A	7	2 (28.5714%)	8/2/2016	3	3
			11/7/2016	3.3	3.3
			1/11/2017	3.4	3.4
			5/18/2017 ~	2.6	2.6
			6/30/2017 ~	ND<0.5 U	ND<1 U
			7/25/2017	2.1	2.1
			9/12/2017	ND<0.5 U	ND<1 U
			9/22/2016	14	14
			6/6/2017	ND<0.5 U	ND<1 U

There are 0 unused locations

Loc.	Meas.	ND	Date	Conc.	Original
------	-------	----	------	-------	----------

Concentrations (mg/L)

Parameter: Fluoride

Original Data (Not Transformed)

Non-Detects Replaced with 1/2 DL

Total Measurements: 93

Total Non-Detect: 13

Percent Non-Detects: 13.9785%

Total Background Measurements: 0

There are 0 background locations

Loc.	Meas.	ND	Date	Conc.	Original
There are 6 compliance locations					
Loc.	Meas.	ND	Date	Conc.	Original
MW-16-05	16	1 (6.25%)	8/3/2016	0.96	0.96
			9/20/2016	1.1	1.1
			11/8/2016	ND<0.5 U	ND<1 U
			1/9/2017	1	1
			3/1/2017	1.1	1.1
			4/18/2017	1.1	1.1
			6/6/2017	1.2	1.2
			7/25/2017	1.1	1.1
			9/13/2017	1.3	1.3
			10/2/2017	1.2	1.2
			3/27/2018	1.2	1.2
			10/1/2018	1.2	1.2
			3/18/2019	1.1	1.1
			9/17/2019	1.1	1.1
			3/19/2020	1.2	1.2
			9/16/2020	1.2	1.2
MW-16-06	16	1 (6.25%)	8/3/2016 ~	0.95	0.95
			9/20/2016	1.1	1.1
			11/9/2016	ND<0.5 U	ND<1 U
			1/10/2017	1	1
			2/28/2017	1.1	1.1
			4/18/2017	1.1	1.1
			6/6/2017 ~	1.15	1.15
			7/25/2017	1.1	1.1
			9/14/2017 ~	1.3	1.3
			10/2/2017	1.2	1.2
			3/27/2018 ~	1.2	1.2
			10/2/2018	1.2	1.2
			3/20/2019	1.1	1.1
			9/17/2019	1	1
			3/19/2020	1.2	1.2
			9/15/2020	1.1	1.1
MW-16-07	16	2 (12.5%)	8/3/2016	0.94	0.94
			9/22/2016	1.1	1.1
			11/9/2016	ND<0.5 U	ND<1 U
			1/10/2017	0.97	0.97
			2/27/2017	1.1	1.1
			4/18/2017	1	1
			6/6/2017	1.1	1.1
			7/25/2017	ND<0.5 U	ND<1 U
			9/14/2017	1.2	1.2
			10/3/2017	1.1	1.1
			3/27/2018	1.2	1.2
			10/2/2018	1.1	1.1
			3/20/2019	1	1
			9/17/2019	1.1	1.1
			3/19/2020	1.1	1.1
			9/15/2020	1.1	1.1

MW-16-08	16	0 (0%)	8/3/2016	1	1
			9/19/2016	1.1	1.1
			11/8/2016	1.1	1.1
			1/10/2017	1	1
			2/28/2017	1.1	1.1
			4/18/2017	1.1	1.1
			6/7/2017	1.2	1.2
			7/25/2017	1.1	1.1
			9/12/2017	1.3	1.3
			10/4/2017	1.2	1.2
			3/28/2018	1.2	1.2
			10/4/2018	1.1	1.1
			3/19/2019	1.1	1.1
			9/17/2019	1.1	1.1
			3/18/2020	1.2	1.2
			9/15/2020	1.2	1.2

MW-16-10	14	4 (28.5714%)	8/2/2016	0.81	0.81
			9/19/2016	0.98	0.98
			11/8/2016	ND<0.5 U	ND<1 U
			1/11/2017	ND<0.5 U	ND<1 U
			2/28/2017	ND<0.5 U	ND<1 U
			7/26/2017	ND<0.5 U	ND<1 U
			9/12/2017	1.2	1.2
			10/4/2017	1.1	1.1
			3/28/2018	1.1	1.1
			10/3/2018	1	1
			3/19/2019	0.96	0.96
			9/17/2019	1	1
			3/18/2020	1.1	1.1
			9/15/2020	1.2	1.2
			4/18/2017	ND<0.5 U	ND<1 U
			6/6/2017	ND<0.5 U	ND<1 U
			8/9/2017 ~	ND<0.5 U	ND<1 U
			8/30/2017 ~	1.1	1.1

MW-16-11A	15	5 (33.3333%)	8/2/2016	0.85	0.85
			9/22/2016	0.95	0.95
			11/7/2016	ND<0.5 U	ND<1 U
			1/11/2017	ND<0.5 U	ND<1 U
			5/18/2017 ~	ND<0.5 U	ND<1 U
			6/30/2017 ~	ND<0.5 U	ND<1 U
			7/25/2017	ND<0.5 UF1	ND<1 UF1
			9/12/2017	1	1
			10/4/2017	1	1
			3/28/2018 ~	1.03333	1.03333
			10/4/2018	0.98	0.98
			3/19/2019	0.91	0.91
			9/17/2019	0.94	0.94
			3/18/2020	1	1
			9/15/2020	0.96	0.96
			6/6/2017	ND<0.5 U	ND<1 U

There are 0 unused locations

Loc.	Meas.	ND	Date	Conc.	Original
------	-------	----	------	-------	----------

Concentrations (ug/L)

Parameter: Lead

Original Data (Not Transformed)

Non-Detects Replaced with 1/2 DL

Total Measurements: 49

Total Non-Detect: 9

Percent Non-Detects: 18.3673%

Total Background Measurements: 0

There are 0 background locations

Loc.	Meas.	ND	Date	Conc.	Original
There are 6 compliance locations					
Loc.	Meas.	ND	Date	Conc.	Original
MW-16-05	9	0 (0%)	8/3/2016	11	11
			9/20/2016	4.4	4.4
			11/8/2016	4.2	4.2
			1/9/2017	3.2	3.2
			3/1/2017	1.8	1.8
			4/18/2017	2.9	2.9
			6/6/2017	1.1	1.1
			7/25/2017	1.4	1.4
			9/13/2017	2.5	2.5
MW-16-06	9	7 (77.7778%)	8/3/2016 ~	4.4	4.4
			9/20/2016	1.3	1.3
			11/9/2016	ND<0.5 U	ND<1 U
			1/10/2017	ND<0.5 U	ND<1 U
			2/28/2017	ND<0.5 U	ND<1 U
			4/18/2017	ND<0.5 U	ND<1 U
			6/6/2017 ~	ND<0.5 U	ND<1 U
			7/25/2017	ND<0.5 U	ND<1 U
			9/14/2017 ~	ND<0.5 U	ND<1 U
MW-16-07	8	0 (0%)	9/22/2016	6.6	6.6
			11/9/2016	7.2	7.2
			1/10/2017	2.6	2.6
			2/27/2017	5.3	5.3
			4/18/2017	5.2	5.2
			6/6/2017	3.6	3.6
			7/25/2017	8.7	8.7
			9/14/2017	5	5
			8/3/2016	23	23
MW-16-08	9	0 (0%)	8/3/2016	16	16
			9/19/2016	14	14
			11/8/2016	8.5	8.5
			1/10/2017	6.4	6.4
			2/28/2017	2.9	2.9
			4/18/2017	5	5
			6/7/2017	1.8	1.8
			7/25/2017	4.7	4.7
			9/12/2017	3.5	3.5
MW-16-10	7	1 (14.2857%)	8/2/2016	7	7
			9/19/2016	3.3	3.3
			11/8/2016	1.7	1.7
			1/11/2017	1.6	1.6
			2/28/2017	ND<0.5 U	ND<1 U
			7/26/2017	1.7	1.7
			9/12/2017	3.4	3.4
			4/18/2017	ND<0.5 U	ND<1 U
			6/6/2017	ND<0.5 U	ND<1 U
8/9/2017 ~	2.45	2.45			

			8/30/2017 ~	1.7	1.7
MW-16-11A	7	1 (14.2857%)	8/2/2016	3.6	3.6
			11/7/2016	1.8	1.8
			1/11/2017	5.2	5.2
			5/18/2017 ~	2.5	2.5
			6/30/2017 ~	1.45	1.45
			7/25/2017	1.7	1.7
			9/12/2017	ND<0.5 U	ND<1 U
			9/22/2016	26	26
			6/6/2017	ND<0.5 U	ND<1 U

There are 0 unused locations

Loc.	Meas.	ND	Date	Conc.	Original
------	-------	----	------	-------	----------

Concentrations (ug/L)

Parameter: Lithium

Original Data (Not Transformed)

Non-Detects Replaced with 1/2 DL

Total Measurements: 51

Total Non-Detect: 0

Percent Non-Detects: 0%

Total Background Measurements: 0

There are 0 background locations

Loc.	Meas.	ND	Date	Conc.	Original
There are 6 compliance locations					
Loc.	Meas.	ND	Date	Conc.	Original
MW-16-05	9	0 (0%)	8/3/2016	55	55
			9/20/2016	59	59
			11/8/2016	55	55
			1/9/2017	49	49
			3/1/2017	53	53
			4/18/2017	62	62
			6/6/2017	54	54
			7/25/2017	58	58
			9/13/2017	51	51
MW-16-06	9	0 (0%)	8/3/2016 ~	33	33
			9/20/2016	41	41
			11/9/2016	34	34
			1/10/2017	35	35
			2/28/2017	37	37
			4/18/2017	42	42
			6/6/2017 ~	40.5	40.5
			7/25/2017	49	49
			9/14/2017 ~	42	42
MW-16-07	9	0 (0%)	8/3/2016	78	78
			9/22/2016	76	76
			11/9/2016	63	63
			1/10/2017	51	51
			2/27/2017	56	56
			4/18/2017	65	65
			6/6/2017	56	56
			7/25/2017	69	69
			9/14/2017	57	57
MW-16-08	9	0 (0%)	8/3/2016	77	77
			9/19/2016	96	96
			11/8/2016	75	75
			1/10/2017	66	66
			2/28/2017	62	62
			4/18/2017	79	79
			6/7/2017	64	64
			7/25/2017	76	76
			9/12/2017	65	65
MW-16-10	7	0 (0%)	8/2/2016	65	65
			9/19/2016	77	77
			11/8/2016	65	65
			1/11/2017	74	74
			2/28/2017	88	88
			7/26/2017	88	88
			9/12/2017	91	91
			4/18/2017	120	120
			6/6/2017	130	130
8/9/2017 ~	86	86			

			8/30/2017 ~	73	73
MW-16-11A	8	0 (0%)	8/2/2016	56	56
			9/22/2016	110	110
			11/7/2016	64	64
			1/11/2017	58	58
			5/18/2017 ~	42.5	42.5
			6/30/2017 ~	39	39
			7/25/2017	52	52
			9/12/2017	52	52
			6/6/2017	34	34

There are 0 unused locations

Loc.	Meas.	ND	Date	Conc.	Original
------	-------	----	------	-------	----------

Concentrations (ug/L)

Parameter: Mercury

Original Data (Not Transformed)

Non-Detects Replaced with 1/2 DL

Total Measurements: 51

Total Non-Detect: 51

Percent Non-Detects: 100%

Total Background Measurements: 0

There are 0 background locations

Loc.	Meas.	ND	Date	Conc.	Original
------	-------	----	------	-------	----------

There are 6 compliance locations

Loc.	Meas.	ND	Date	Conc.	Original
------	-------	----	------	-------	----------

MW-16-05	9	9 (100%)	8/3/2016	ND<0.1 U	ND<0.2 U
			9/20/2016	ND<0.1 U	ND<0.2 U
			11/8/2016	ND<0.1 U	ND<0.2 U
			1/9/2017	ND<0.1 U	ND<0.2 U
			3/1/2017	ND<0.1 U	ND<0.2 U
			4/18/2017	ND<0.1 U	ND<0.2 U
			6/6/2017	ND<0.1 U	ND<0.2 U
			7/25/2017	ND<0.1 U	ND<0.2 U
			9/13/2017	ND<0.1 U	ND<0.2 U

MW-16-06	9	9 (100%)	8/3/2016 ~	ND<0.1 U	ND<0.2 U
			9/20/2016	ND<0.1 U	ND<0.2 U
			11/9/2016	ND<0.1 U	ND<0.2 U
			1/10/2017	ND<0.1 U	ND<0.2 U
			2/28/2017	ND<0.1 U	ND<0.2 U
			4/18/2017	ND<0.1 U	ND<0.2 U
			6/6/2017 ~	ND<0.1 U	ND<0.2 U
			7/25/2017	ND<0.1 U	ND<0.2 U
9/14/2017 ~	ND<0.1 U	ND<0.2 U			

MW-16-07	9	9 (100%)	8/3/2016	ND<0.1 U	ND<0.2 U
			9/22/2016	ND<0.1 U	ND<0.2 U
			11/9/2016	ND<0.1 U	ND<0.2 U
			1/10/2017	ND<0.1 U	ND<0.2 U
			2/27/2017	ND<0.1 U	ND<0.2 U
			4/18/2017	ND<0.1 U	ND<0.2 U
			6/6/2017	ND<0.1 U	ND<0.2 U
			7/25/2017	ND<0.1 U	ND<0.2 U
			9/14/2017	ND<0.1 U	ND<0.2 U

MW-16-08	9	9 (100%)	8/3/2016	ND<0.1 U	ND<0.2 U
			9/19/2016	ND<0.1 U	ND<0.2 U
			11/8/2016	ND<0.1 U	ND<0.2 U
			1/10/2017	ND<0.1 U	ND<0.2 U
			2/28/2017	ND<0.1 U	ND<0.2 U
			4/18/2017	ND<0.1 U	ND<0.2 U
			6/7/2017	ND<0.1 U	ND<0.2 U
			7/25/2017	ND<0.1 U	ND<0.2 U
			9/12/2017	ND<0.1 U	ND<0.2 U

MW-16-10	7	7 (100%)	8/2/2016	ND<0.1 U	ND<0.2 U
			9/19/2016	ND<0.1 U	ND<0.2 U
			11/8/2016	ND<0.1 U	ND<0.2 U
			1/11/2017	ND<0.1 U	ND<0.2 U
			2/28/2017	ND<0.1 U	ND<0.2 U
			7/26/2017	ND<0.1 U	ND<0.2 U
			9/12/2017	ND<0.1 U	ND<0.2 U
			4/18/2017	ND<0.1 U	ND<0.2 U
			6/6/2017	ND<0.1 U	ND<0.2 U
			8/9/2017 ~	ND<0.1 U	ND<0.2 U

			8/30/2017 ~	ND<0.1 U	ND<0.2 U
MW-16-11A	8	8 (100%)	8/2/2016	ND<0.1 U	ND<0.2 U
			9/22/2016	ND<0.1 U	ND<0.2 U
			11/7/2016	ND<0.1 U	ND<0.2 U
			1/11/2017	ND<0.1 U	ND<0.2 U
			5/18/2017 ~	ND<0.1 U	ND<0.2 U
			6/30/2017 ~	ND<0.1 U	ND<0.2 U
			7/25/2017	ND<0.1 U	ND<0.2 U
			9/12/2017	ND<0.1 U	ND<0.2 U
			6/6/2017	ND<0.1 U	ND<0.2 U

There are 0 unused locations

Loc.	Meas.	ND	Date	Conc.	Original
------	-------	----	------	-------	----------

Concentrations (ug/L)

Parameter: Molybdenum

Original Data (Not Transformed)

Non-Detects Replaced with 1/2 DL

Total Measurements: 51

Total Non-Detect: 0

Percent Non-Detects: 0%

Total Background Measurements: 0

There are 0 background locations

Loc.	Meas.	ND	Date	Conc.	Original
There are 6 compliance locations					
Loc.	Meas.	ND	Date	Conc.	Original
MW-16-05	9	0 (0%)	8/3/2016	43	43
			9/20/2016	23	23
			11/8/2016	25	25
			1/9/2017	21	21
			3/1/2017	20	20
			4/18/2017	23	23
			6/6/2017	18	18
			7/25/2017	20	20
			9/13/2017	20	20
MW-16-06	9	0 (0%)	8/3/2016 ~	30	30
			9/20/2016	22	22
			11/9/2016	20	20
			1/10/2017	17	17
			2/28/2017	18	18
			4/18/2017	17	17
			6/6/2017 ~	16.5	16.5
			7/25/2017	17	17
9/14/2017 ~	17	17			
MW-16-07	9	0 (0%)	8/3/2016	73	73
			9/22/2016	38	38
			11/9/2016	33	33
			1/10/2017	24	24
			2/27/2017	25	25
			4/18/2017	24	24
			6/6/2017	19	19
			7/25/2017	22	22
			9/14/2017	19	19
MW-16-08	9	0 (0%)	8/3/2016	58	58
			9/19/2016	46	46
			11/8/2016	44	44
			1/10/2017	37	37
			2/28/2017	35	35
			4/18/2017	39	39
			6/7/2017	32	32
			7/25/2017	30	30
			9/12/2017	28	28
MW-16-10	7	0 (0%)	8/2/2016	33	33
			9/19/2016	22	22
			11/8/2016	21	21
			1/11/2017	15	15
			2/28/2017	20	20
			7/26/2017	16	16
			9/12/2017	16	16
			4/18/2017	23	23
			6/6/2017	21	21
8/9/2017 ~	18	18			

			8/30/2017 ~	15.5	15.5
MW-16-11A	8	0 (0%)	8/2/2016	32	32
			9/22/2016	32	32
			11/7/2016	21	21
			1/11/2017	19	19
			5/18/2017 ~	18	18
			6/30/2017 ~	18	18
			7/25/2017	19	19
			9/12/2017	17	17
			6/6/2017	17	17

There are 0 unused locations

Loc.	Meas.	ND	Date	Conc.	Original
------	-------	----	------	-------	----------

Concentrations (pci/L)

Parameter: Radium-226/228

Original Data (Not Transformed)

Non-Detects Replaced with 1/2 DL

Total Measurements: 50

Total Non-Detect: 0

Percent Non-Detects: 0%

Total Background Measurements: 0

There are 0 background locations

Loc.	Meas.	ND	Date	Conc.	Original
There are 6 compliance locations					
Loc.	Meas.	ND	Date	Conc.	Original
MW-16-05	9	0 (0%)	8/3/2016	1.81	1.81
			9/20/2016	3.99	3.99
			11/8/2016	1.67	1.67
			1/9/2017	2.26	2.26
			3/1/2017	1.41	1.41
			4/18/2017	1.06	1.06
			6/6/2017	1.77	1.77
			7/25/2017	1.51	1.51
			9/13/2017	1.3	1.3
MW-16-06	9	0 (0%)	8/3/2016 ~	1.56	1.56
			9/20/2016	1.53	1.53
			11/9/2016	2.15	2.15
			1/10/2017	1.9	1.9
			2/28/2017	1.31	1.31
			4/18/2017	0.99	0.99
			6/6/2017 ~	1.145	1.145
			7/25/2017	1.23	1.23
			9/14/2017 ~	1.14	1.14
MW-16-07	9	0 (0%)	8/3/2016	3.26	3.26
			9/22/2016	4.09	4.09
			11/9/2016	4.48	4.48
			1/10/2017	1.85	1.85
			2/27/2017	1.78	1.78
			4/18/2017	1.88	1.88
			6/6/2017	2.46	2.46
			7/25/2017	2.54	2.54
			9/14/2017	1.86	1.86
MW-16-08	9	0 (0%)	8/3/2016	2.84	2.84
			9/19/2016	1.82	1.82
			11/8/2016	5.14	5.14
			1/10/2017	2.58	2.58
			2/28/2017	1.91	1.91
			4/18/2017	1.47	1.47
			6/7/2017	1.8	1.8
			7/25/2017	3.05	3.05
			9/12/2017	1.65	1.65
MW-16-10	7	0 (0%)	8/2/2016	2.04	2.04
			9/19/2016	1.89	1.89
			11/8/2016	2.24	2.24
			1/11/2017	1.5	1.5
			2/28/2017	0.934	0.934
			7/26/2017	1.41	1.41
			9/12/2017	1.48	1.48
			4/18/2017	0.9	0.9
			6/6/2017	1.32	1.32
8/9/2017 ~	1.48	1.48			

			8/30/2017 ~	1.375	1.375
MW-16-11A	7	0 (0%)	9/22/2016	2.15	2.15
			11/7/2016	1.72	1.72
			1/11/2017	1.33	1.33
			5/18/2017 ~	1.53	1.53
			6/30/2017 ~	1.665	1.665
			7/25/2017	1.58	1.58
			9/12/2017	1.3	1.3
			8/2/2016	6.94	6.94
			6/6/2017	1.45	1.45

There are 0 unused locations

Loc.	Meas.	ND	Date	Conc.	Original
-------------	--------------	-----------	-------------	--------------	-----------------

Concentrations (ug/L)

Parameter: Selenium

Original Data (Not Transformed)

Non-Detects Replaced with 1/2 DL

Total Measurements: 51

Total Non-Detect: 50

Percent Non-Detects: 98.0392%

Total Background Measurements: 0

There are 0 background locations

Loc.	Meas.	ND	Date	Conc.	Original
------	-------	----	------	-------	----------

There are 6 compliance locations

Loc.	Meas.	ND	Date	Conc.	Original
------	-------	----	------	-------	----------

MW-16-05	9	9 (100%)	8/3/2016	ND<2.5 U	ND<5 U
			9/20/2016	ND<2.5 U	ND<5 U
			11/8/2016	ND<2.5 U	ND<5 U
			1/9/2017	ND<2.5 U	ND<5 U
			3/1/2017	ND<2.5 U	ND<5 U
			4/18/2017	ND<2.5 U	ND<5 U
			6/6/2017	ND<2.5 U	ND<5 U
			7/25/2017	ND<2.5 U	ND<5 U
			9/13/2017	ND<2.5 U	ND<5 U

MW-16-06	9	9 (100%)	8/3/2016 ~	ND<2.5 U	ND<5 U
			9/20/2016	ND<2.5 U	ND<5 U
			11/9/2016	ND<2.5 U	ND<5 U
			1/10/2017	ND<2.5 U	ND<5 U
			2/28/2017	ND<2.5 U	ND<5 U
			4/18/2017	ND<2.5 U	ND<5 U
			6/6/2017 ~	ND<2.5 U	ND<5 U
			7/25/2017	ND<2.5 U	ND<5 U
			9/14/2017 ~	ND<2.5 U	ND<5 U

MW-16-07	9	8 (88.8889%)	8/3/2016	5.3	5.3
			9/22/2016	ND<2.5 U	ND<5 U
			11/9/2016	ND<2.5 U	ND<5 U
			1/10/2017	ND<2.5 U	ND<5 U
			2/27/2017	ND<2.5 U	ND<5 U
			4/18/2017	ND<2.5 U	ND<5 U
			6/6/2017	ND<2.5 U	ND<5 U
			7/25/2017	ND<2.5 U	ND<5 U
			9/14/2017	ND<2.5 U	ND<5 U

MW-16-08	9	9 (100%)	8/3/2016	ND<2.5 U	ND<5 U
			9/19/2016	ND<2.5 U	ND<5 U
			11/8/2016	ND<2.5 U	ND<5 U
			1/10/2017	ND<2.5 U	ND<5 U
			2/28/2017	ND<2.5 U	ND<5 U
			4/18/2017	ND<2.5 U	ND<5 U
			6/7/2017	ND<2.5 U	ND<5 U
			7/25/2017	ND<2.5 U	ND<5 U
			9/12/2017	ND<2.5 U	ND<5 U

MW-16-10	7	7 (100%)	8/2/2016	ND<2.5 U	ND<5 U
			9/19/2016	ND<2.5 U	ND<5 U
			11/8/2016	ND<2.5 U	ND<5 U
			1/11/2017	ND<2.5 U	ND<5 U
			2/28/2017	ND<2.5 U	ND<5 U
			7/26/2017	ND<2.5 U	ND<5 U
			9/12/2017	ND<2.5 U	ND<5 U
			4/18/2017	ND<2.5 U	ND<5 U
			6/6/2017	ND<2.5 U	ND<5 U
8/9/2017 ~	ND<2.5 U	ND<5 U			

			8/30/2017 ~	ND<2.5 U	ND<5 U
MW-16-11A	8	8 (100%)	8/2/2016	ND<2.5 U	ND<5 U
			9/22/2016	ND<2.5 U	ND<5 U
			11/7/2016	ND<2.5 U	ND<5 U
			1/11/2017	ND<2.5 U	ND<5 U
			5/18/2017 ~	ND<2.5 U	ND<5 U
			6/30/2017 ~	ND<2.5 U	ND<5 U
			7/25/2017	ND<2.5 U	ND<5 U
			9/12/2017	ND<2.5 U	ND<5 U
			6/6/2017	ND<2.5 U	ND<5 U

There are 0 unused locations

Loc.	Meas.	ND	Date	Conc.	Original
------	-------	----	------	-------	----------

Concentrations (ug/L)

Parameter: Thallium

Original Data (Not Transformed)

Non-Detects Replaced with 1/2 DL

Total Measurements: 51

Total Non-Detect: 46

Percent Non-Detects: 90.1961%

Total Background Measurements: 0

There are 0 background locations

Loc.	Meas.	ND	Date	Conc.	Original
There are 6 compliance locations					
Loc.	Meas.	ND	Date	Conc.	Original
MW-16-05	9	8 (88.8889%)	8/3/2016	1.1	1.1
			9/20/2016	ND<0.5 U	ND<1 U
			11/8/2016	ND<0.5 U	ND<1 U
			1/9/2017	ND<0.5 U	ND<1 U
			3/1/2017	ND<0.5 U	ND<1 U
			4/18/2017	ND<0.5 U	ND<1 U
			6/6/2017	ND<0.5 U	ND<1 U
			7/25/2017	ND<0.5 U	ND<1 U
			9/13/2017	ND<0.5 U	ND<1 U
MW-16-06	9	9 (100%)	8/3/2016 ~	ND<0.5 U	ND<1 U
			9/20/2016	ND<0.5 U	ND<1 U
			11/9/2016	ND<0.5 U	ND<1 U
			1/10/2017	ND<0.5 U	ND<1 U
			2/28/2017	ND<0.5 U	ND<1 U
			4/18/2017	ND<0.5 U	ND<1 U
			6/6/2017 ~	ND<0.5 U	ND<1 U
			7/25/2017	ND<0.5 U	ND<1 U
			9/14/2017 ~	ND<0.5 U	ND<1 U
MW-16-07	9	7 (77.7778%)	8/3/2016	2.3	2.3
			9/22/2016	ND<0.5 U	ND<1 U
			11/9/2016	ND<0.5 U	ND<1 U
			1/10/2017	ND<0.5 U	ND<1 U
			2/27/2017	ND<0.5 U	ND<1 U
			4/18/2017	ND<0.5 U	ND<1 U
			6/6/2017	ND<0.5 U	ND<1 U
			7/25/2017	1	1
			9/14/2017	ND<0.5 U	ND<1 U
MW-16-08	9	7 (77.7778%)	8/3/2016	1.3	1.3
			9/19/2016	1.2	1.2
			11/8/2016	ND<0.5 U	ND<1 U
			1/10/2017	ND<0.5 U	ND<1 U
			2/28/2017	ND<0.5 U	ND<1 U
			4/18/2017	ND<0.5 U	ND<1 U
			6/7/2017	ND<0.5 U	ND<1 U
			7/25/2017	ND<0.5 U	ND<1 U
			9/12/2017	ND<0.5 U	ND<1 U
MW-16-10	7	7 (100%)	8/2/2016	ND<0.5 U	ND<1 U
			9/19/2016	ND<0.5 U	ND<1 U
			11/8/2016	ND<0.5 U	ND<1 U
			1/11/2017	ND<0.5 U	ND<1 U
			2/28/2017	ND<0.5 U	ND<1 U
			7/26/2017	ND<0.5 U	ND<1 U
			9/12/2017	ND<0.5 U	ND<1 U
			4/18/2017	ND<0.5 U	ND<1 U
			6/6/2017	ND<0.5 U	ND<1 U
8/9/2017 ~	ND<0.5 U^	ND<1 U^			

			8/30/2017 ~	ND<0.5 U	ND<1 U
MW-16-11A	8	8 (100%)	8/2/2016	ND<0.5 U	ND<1 U
			9/22/2016	ND<0.5 U	ND<1 U
			11/7/2016	ND<0.5 U	ND<1 U
			1/11/2017	ND<0.5 U	ND<1 U
			5/18/2017 ~	ND<0.5 U	ND<1 U
			6/30/2017 ~	ND<0.5 U	ND<1 U
			7/25/2017	ND<0.5 U	ND<1 U
			9/12/2017	ND<0.5 U	ND<1 U
			6/6/2017	ND<0.5 U	ND<1 U

There are 0 unused locations

Loc.	Meas.	ND	Date	Conc.	Original
------	-------	----	------	-------	----------

Skewness Coefficient

Parameter: Arsenic

Original Data (Not Transformed)

Aitchison's Adjustment

Skewness > 1 indicates positively skewed data

Skewness < -1 indicates negatively skewed data

Compliance Locations

Location	Obs.	Mean	Std. Dev.	Skewness
MW-16-05	9	2.74444	4.81641	1.81691
MW-16-06	9	0.827778	2.48333	7.54422
MW-16-07	8	6	3.97887	0.373835
MW-16-08	9	7.75556	7.36802	0.897249
MW-16-10	7	2.35714	4.32738	1.70824
MW-16-11A	8	5.79375	6.00324	1.05752

All Locations

Obs.	Mean	Std. Dev.	Skewness
50	4.256	5.43931	1.36665

Skewness Coefficient

Parameter: Arsenic

Original Data (Not Transformed)

Cohen's Adjustment

Skewness > 1 indicates positively skewed data

Skewness < -1 indicates negatively skewed data

Compliance Locations

Location	Obs.	Mean	Std. Dev.	Skewness
MW-16-11A	8	9.27	4.77357	0.148067
MW-16-05	9	8.23333	5.00033	-0.0637032
MW-16-06	9	-0.292	4.35522	2.64762
MW-16-07	8	6.88705	2.51055	0.613695
MW-16-08	9	7.66396	7.68485	0.813109
MW-16-10	7	8.25	3.88909	-0.52529

All Locations

Obs.	Mean	Std. Dev.	Skewness
50	4.03884	6.30378	0.931901

Skewness Coefficient

Parameter: Barium

Original Data (Not Transformed)

Non-Detects Replaced with 1/2 DL

Skewness > 1 indicates positively skewed data

Skewness < -1 indicates negatively skewed data

Compliance Locations

Location	Obs.	Mean	Std. Dev.	Skewness
MW-16-05	9	294.444	24.5515	1.01157
MW-16-06	9	277.778	17.1594	0.519638
MW-16-07	9	334.444	50.0278	1.44883
MW-16-08	9	346.667	47.697	0.431717
MW-16-10	7	125.714	20.702	0.134164
MW-16-11A	8	302.5	99.8213	-0.0523964

All Locations

Obs.	Mean	Std. Dev.	Skewness
51	285.882	84.2894	-0.526493

Skewness Coefficient

Parameter: Barium

Natural Logarithm Transformation

Non-Detects Replaced with 1/2 DL

Skewness > 1 indicates positively skewed data

Skewness < -1 indicates negatively skewed data

Compliance Locations

Location	Obs.	Mean	Std. Dev.	Skewness
MW-16-05	9	5.68214	0.0804871	0.95611
MW-16-06	9	5.62516	0.0609499	0.49528
MW-16-07	9	5.80354	0.13808	1.21299
MW-16-08	9	5.84014	0.135293	0.297747
MW-16-10	7	4.82236	0.164934	0.0455551
MW-16-11A	8	5.65309	0.394627	-1.22778

All Locations

Obs.	Mean	Std. Dev.	Skewness
51	5.59883	0.370072	-1.40006

Shapiro-Wilks Test of Normality

Parameter: Barium

Location: MW-16-07

Normality Test of Parameter Concentrations

Original Data (Not Transformed)

Non-Detects Replaced with 1/2 DL

K = 4 for 9 measurements

i	x(i)	x(n-i+1)	x(n-1+1)-x(i)	a(n-i+1)	b(i)
1	290	450	160	0.5888	94.208
2	290	370	80	0.3244	25.952
3	300	330	30	0.1976	5.928
4	320	330	10	0.0947	0.947
5	330	330	0		
6	330	320	-10		
7	330	300	-30		
8	370	290	-80		
9	450	290	-160		

Sum of b values = 127.035

Sample Standard Deviation = 50.0278

W Statistic = 0.805999

5% Critical value of 0.829 exceeds 0.805999
Evidence of non-normality at 95% level of significance

1% Critical value of 0.764 is less than 0.805999
Data is normally distributed at 99% level of significance

Shapiro-Wilks Test of Normality

Parameter: Barium

Location: MW-16-07

Normality Test of Parameter Concentrations

Natural Logarithm Transformation

Non-Detects Replaced with 1/2 DL

K = 4 for 9 measurements

i	x(i)	x(n-i+1)	x(n-1+1)-x(i)	a(n-i+1)	b(i)
1	5.66988	6.10925	0.439367	0.5888	0.258699
2	5.66988	5.9135	0.243622	0.3244	0.079031
3	5.70378	5.79909	0.0953102	0.1976	0.0188333
4	5.76832	5.79909	0.0307717	0.0947	0.00291408
5	5.79909	5.79909	0		
6	5.79909	5.76832	-0.0307717		
7	5.79909	5.70378	-0.0953102		
8	5.9135	5.66988	-0.243622		
9	6.10925	5.66988	-0.439367		

Sum of b values = 0.359477

Sample Standard Deviation = 0.13808

W Statistic = 0.847205

5% Critical value of 0.829 is less than 0.847205

Data is normally distributed at 95% level of significance

1% Critical value of 0.764 is less than 0.847205

Data is normally distributed at 99% level of significance

Skewness Coefficient

Parameter: Chromium

Original Data (Not Transformed)

Non-Detects Replaced with 1/2 DL

Skewness > 1 indicates positively skewed data

Skewness < -1 indicates negatively skewed data

Compliance Locations

Location	Obs.	Mean	Std. Dev.	Skewness
MW-16-11A	7	6.56429	3.30488	-0.755706
MW-16-05	9	8.38889	6.47446	1.71747
MW-16-06	9	2.88889	4.13021	2.17688
MW-16-07	8	11.9625	4.78329	0.320197
MW-16-08	9	17.3556	12.4719	0.995955
MW-16-10	7	10.2286	6.54948	0.236403

All Locations

Obs.	Mean	Std. Dev.	Skewness
49	9.61122	8.25515	1.7573

Skewness Coefficient

Parameter: Chromium

Natural Logarithm Transformation

Non-Detects Replaced with 1/2 DL

Skewness > 1 indicates positively skewed data

Skewness < -1 indicates negatively skewed data

Compliance Locations

Location	Obs.	Mean	Std. Dev.	Skewness
MW-16-05	9	1.92871	0.631947	0.673789
MW-16-06	9	0.538862	0.929372	1.42792
MW-16-07	8	2.40907	0.412611	-0.0660623
MW-16-08	9	2.64588	0.670618	0.392812
MW-16-10	7	2.02588	1.00685	-1.22591
MW-16-11A	7	1.67263	0.83318	-1.3333

All Locations

Obs.	Mean	Std. Dev.	Skewness
49	1.86088	1.01347	-0.631762

Skewness Coefficient

Parameter: Cobalt

Original Data (Not Transformed)

Non-Detects Replaced with 1/2 DL

Skewness > 1 indicates positively skewed data

Skewness < -1 indicates negatively skewed data

Compliance Locations

Location	Obs.	Mean	Std. Dev.	Skewness
MW-16-05	9	3.47778	2.70729	1.66974
MW-16-06	9	1.06667	1.39463	2.2839
MW-16-07	8	5.8625	2.23411	0.377399
MW-16-08	9	7.25556	4.77915	0.710724
MW-16-10	7	4.84286	3.66554	0.989395
MW-16-11A	7	2.2	1.24097	-0.583273

All Locations

Obs.	Mean	Std. Dev.	Skewness
49	4.13061	3.56944	1.35901

Skewness Coefficient

Parameter: Cobalt

Natural Logarithm Transformation

Non-Detects Replaced with 1/2 DL

Skewness > 1 indicates positively skewed data

Skewness < -1 indicates negatively skewed data

Compliance Locations

Location	Obs.	Mean	Std. Dev.	Skewness
MW-16-05	9	1.03443	0.665075	0.486789
MW-16-06	9	-0.329777	0.782029	1.82308
MW-16-07	8	1.70411	0.386072	0.0171255
MW-16-08	9	1.783	0.67782	0.0796129
MW-16-10	7	1.25843	0.994225	-0.980572
MW-16-11A	7	0.546781	0.862325	-0.838728

All Locations

Obs.	Mean	Std. Dev.	Skewness
49	0.993026	1.02931	-0.459192

Skewness Coefficient

Parameter: Cobalt

Original Data (Not Transformed)

Aitchison's Adjustment

Skewness > 1 indicates positively skewed data

Skewness < -1 indicates negatively skewed data

Compliance Locations

Location	Obs.	Mean	Std. Dev.	Skewness
MW-16-05	9	3.47778	2.70729	1.66974
MW-16-06	9	0.677778	1.5778	2.21712
MW-16-07	8	5.8625	2.23411	0.377399
MW-16-08	9	7.25556	4.77915	0.710724
MW-16-10	7	4.77143	3.76772	1.05097
MW-16-11A	7	2.05714	1.4718	0.168083

All Locations

Obs.	Mean	Std. Dev.	Skewness
49	4.02857	3.6795	1.38805

Skewness Coefficient

Parameter: Fluoride

Original Data (Not Transformed)

Non-Detects Replaced with 1/2 DL

Skewness > 1 indicates positively skewed data

Skewness < -1 indicates negatively skewed data

Compliance Locations

Location	Obs.	Mean	Std. Dev.	Skewness
MW-16-05	16	1.0975	0.180647	-2.36014
MW-16-06	16	1.08125	0.178769	-2.19557
MW-16-07	16	1.00687	0.210356	-1.77484
MW-16-08	16	1.13125	0.07932	0.229585
MW-16-10	14	0.889286	0.274071	-0.560684
MW-16-11A	15	0.808222	0.229616	-0.604672

All Locations

Obs.	Mean	Std. Dev.	Skewness
93	1.00692	0.225893	-1.39077

Skewness Coefficient

Parameter: Fluoride

Natural Logarithm Transformation

Non-Detects Replaced with 1/2 DL

Skewness > 1 indicates positively skewed data

Skewness < -1 indicates negatively skewed data

Compliance Locations

Location	Obs.	Mean	Std. Dev.	Skewness
MW-16-05	16	0.0746366	0.218445	-2.90896
MW-16-06	16	0.0599271	0.21625	-2.80843
MW-16-07	16	-0.021969	0.270443	-2.0008
MW-16-08	16	0.121028	0.0699272	0.0589912
MW-16-10	14	-0.170983	0.356557	-0.720364
MW-16-11A	15	-0.257598	0.322028	-0.647146

All Locations

Obs.	Mean	Std. Dev.	Skewness
93	-0.0270942	0.283941	-1.6905

Shapiro-Wilks Test of Normality

Parameter: Fluoride

Location: MW-16-05

Normality Test of Parameter Concentrations

Original Data (Not Transformed)

Non-Detects Replaced with 1/2 DL

K = 8 for 16 measurements

i	x(i)	x(n-i+1)	x(n-1+1)-x(i)	a(n-i+1)	b(i)
1	0.5	1.3	0.8	0.5056	0.40448
2	0.96	1.2	0.24	0.329	0.07896
3	1	1.2	0.2	0.2521	0.05042
4	1.1	1.2	0.1	0.1939	0.01939
5	1.1	1.2	0.1	0.1447	0.01447
6	1.1	1.2	0.1	0.1005	0.01005
7	1.1	1.2	0.1	0.0593	0.00593
8	1.1	1.1	0	0.0196	0
9	1.1	1.1	0		
10	1.2	1.1	-0.1		
11	1.2	1.1	-0.1		
12	1.2	1.1	-0.1		
13	1.2	1.1	-0.1		
14	1.2	1	-0.2		
15	1.2	0.96	-0.24		
16	1.3	0.5	-0.8		

Sum of b values = 0.5837

Sample Standard Deviation = 0.180647

W Statistic = 0.696028

5% Critical value of 0.887 exceeds 0.696028

Evidence of non-normality at 95% level of significance

1% Critical value of 0.844 exceeds 0.696028

Evidence of non-normality at 99% level of significance

Shapiro-Wilks Test of Normality

Parameter: Fluoride

Location: MW-16-05

Normality Test of Parameter Concentrations

Natural Logarithm Transformation

Non-Detects Replaced with 1/2 DL

K = 8 for 16 measurements

i	x(i)	x(n-i+1)	x(n-1+1)-x(i)	a(n-i+1)	b(i)
1	-0.693147	0.262364	0.955511	0.5056	0.483107
2	-0.040822	0.182322	0.223144	0.329	0.0734142
3	0	0.182322	0.182322	0.2521	0.0459633
4	0.0953102	0.182322	0.0870114	0.1939	0.0168715
5	0.0953102	0.182322	0.0870114	0.1447	0.0125905
6	0.0953102	0.182322	0.0870114	0.1005	0.00874464
7	0.0953102	0.182322	0.0870114	0.0593	0.00515977
8	0.0953102	0.0953102	0	0.0196	0
9	0.0953102	0.0953102	0		
10	0.182322	0.0953102	-0.0870114		
11	0.182322	0.0953102	-0.0870114		
12	0.182322	0.0953102	-0.0870114		
13	0.182322	0.0953102	-0.0870114		
14	0.182322	0	-0.182322		
15	0.182322	-0.040822	-0.223144		
16	0.262364	-0.693147	-0.955511		

Sum of b values = 0.645851

Sample Standard Deviation = 0.218445

W Statistic = 0.582757

5% Critical value of 0.887 exceeds 0.582757

Evidence of non-normality at 95% level of significance

1% Critical value of 0.844 exceeds 0.582757

Evidence of non-normality at 99% level of significance

Shapiro-Wilks Test of Normality

Parameter: Fluoride

Location: MW-16-06

Normality Test of Parameter Concentrations

Original Data (Not Transformed)

Non-Detects Replaced with 1/2 DL

K = 8 for 16 measurements

i	x(i)	x(n-i+1)	x(n-1+1)-x(i)	a(n-i+1)	b(i)
1	0.5	1.3	0.8	0.5056	0.40448
2	0.95	1.2	0.25	0.329	0.08225
3	1	1.2	0.2	0.2521	0.05042
4	1	1.2	0.2	0.1939	0.03878
5	1.1	1.2	0.1	0.1447	0.01447
6	1.1	1.15	0.05	0.1005	0.005025
7	1.1	1.1	0	0.0593	0
8	1.1	1.1	0	0.0196	0
9	1.1	1.1	0		
10	1.1	1.1	0		
11	1.15	1.1	-0.05		
12	1.2	1.1	-0.1		
13	1.2	1	-0.2		
14	1.2	1	-0.2		
15	1.2	0.95	-0.25		
16	1.3	0.5	-0.8		

Sum of b values = 0.595425

Sample Standard Deviation = 0.178769

W Statistic = 0.739569

5% Critical value of 0.887 exceeds 0.739569

Evidence of non-normality at 95% level of significance

1% Critical value of 0.844 exceeds 0.739569

Evidence of non-normality at 99% level of significance

Shapiro-Wilks Test of Normality

Parameter: Fluoride

Location: MW-16-06

Normality Test of Parameter Concentrations

Natural Logarithm Transformation

Non-Detects Replaced with 1/2 DL

K = 8 for 16 measurements

i	x(i)	x(n-i+1)	x(n-1+1)-x(i)	a(n-i+1)	b(i)
1	-0.693147	0.262364	0.955511	0.5056	0.483107
2	-0.0512933	0.182322	0.233615	0.329	0.0768593
3	0	0.182322	0.182322	0.2521	0.0459633
4	0	0.182322	0.182322	0.1939	0.0353521
5	0.0953102	0.182322	0.0870114	0.1447	0.0125905
6	0.0953102	0.139762	0.0444518	0.1005	0.0044674
7	0.0953102	0.0953102	0	0.0593	0
8	0.0953102	0.0953102	0	0.0196	0
9	0.0953102	0.0953102	0		
10	0.0953102	0.0953102	0		
11	0.139762	0.0953102	-0.0444518		
12	0.182322	0.0953102	-0.0870114		
13	0.182322	0	-0.182322		
14	0.182322	0	-0.182322		
15	0.182322	-0.0512933	-0.233615		
16	0.262364	-0.693147	-0.955511		

Sum of b values = 0.658339

Sample Standard Deviation = 0.21625

W Statistic = 0.617868

5% Critical value of 0.887 exceeds 0.617868

Evidence of non-normality at 95% level of significance

1% Critical value of 0.844 exceeds 0.617868

Evidence of non-normality at 99% level of significance

Shapiro-Wilks Test of Normality

Parameter: Fluoride

Location: MW-16-07

Normality Test of Parameter Concentrations

Original Data (Not Transformed)

Non-Detects Replaced with 1/2 DL

K = 8 for 16 measurements

i	x(i)	x(n-i+1)	x(n-1+1)-x(i)	a(n-i+1)	b(i)
1	0.5	1.2	0.7	0.5056	0.35392
2	0.5	1.2	0.7	0.329	0.2303
3	0.94	1.1	0.16	0.2521	0.040336
4	0.97	1.1	0.13	0.1939	0.025207
5	1	1.1	0.1	0.1447	0.01447
6	1	1.1	0.1	0.1005	0.01005
7	1.1	1.1	0	0.0593	0
8	1.1	1.1	0	0.0196	0
9	1.1	1.1	0		
10	1.1	1.1	0		
11	1.1	1	-0.1		
12	1.1	1	-0.1		
13	1.1	0.97	-0.13		
14	1.1	0.94	-0.16		
15	1.2	0.5	-0.7		
16	1.2	0.5	-0.7		

Sum of b values = 0.674283

Sample Standard Deviation = 0.210356

W Statistic = 0.68499

5% Critical value of 0.887 exceeds 0.68499

Evidence of non-normality at 95% level of significance

1% Critical value of 0.844 exceeds 0.68499

Evidence of non-normality at 99% level of significance

Shapiro-Wilks Test of Normality

Parameter: Fluoride

Location: MW-16-07

Normality Test of Parameter Concentrations

Natural Logarithm Transformation

Non-Detects Replaced with 1/2 DL

K = 8 for 16 measurements

i	x(i)	x(n-i+1)	x(n-1+1)-x(i)	a(n-i+1)	b(i)
1	-0.693147	0.182322	0.875469	0.5056	0.442637
2	-0.693147	0.182322	0.875469	0.329	0.288029
3	-0.0618754	0.0953102	0.157186	0.2521	0.0396265
4	-0.0304592	0.0953102	0.125769	0.1939	0.0243867
5	0	0.0953102	0.0953102	0.1447	0.0137914
6	0	0.0953102	0.0953102	0.1005	0.00957867
7	0.0953102	0.0953102	0	0.0593	0
8	0.0953102	0.0953102	0	0.0196	0
9	0.0953102	0.0953102	0		
10	0.0953102	0.0953102	0		
11	0.0953102	0	-0.0953102		
12	0.0953102	0	-0.0953102		
13	0.0953102	-0.0304592	-0.125769		
14	0.0953102	-0.0618754	-0.157186		
15	0.182322	-0.693147	-0.875469		
16	0.182322	-0.693147	-0.875469		

Sum of b values = 0.818049

Sample Standard Deviation = 0.270443

W Statistic = 0.609979

5% Critical value of 0.887 exceeds 0.609979

Evidence of non-normality at 95% level of significance

1% Critical value of 0.844 exceeds 0.609979

Evidence of non-normality at 99% level of significance

Skewness Coefficient

Parameter: Fluoride

Original Data (Not Transformed)

Aitchison's Adjustment

Skewness > 1 indicates positively skewed data

Skewness < -1 indicates negatively skewed data

Compliance Locations

Location	Obs.	Mean	Std. Dev.	Skewness
MW-16-05	16	1.06625	0.296802	0.0673564
MW-16-06	16	1.05	0.293825	0.0800714
MW-16-07	16	0.944375	0.375499	0.0835742
MW-16-08	16	1.13125	0.07932	0.229585
MW-16-10	14	0.746429	0.49984	0.281128
MW-16-11A	15	0.641556	0.471515	0.411854

All Locations

Obs.	Mean	Std. Dev.	Skewness
93	0.937025	0.39121	0.116362

Skewness Coefficient

Parameter: Lead

Original Data (Not Transformed)

Non-Detects Replaced with 1/2 DL

Skewness > 1 indicates positively skewed data

Skewness < -1 indicates negatively skewed data

Compliance Locations

Location	Obs.	Mean	Std. Dev.	Skewness
MW-16-05	9	3.61111	2.99893	1.81739
MW-16-06	9	1.02222	1.294	2.29847
MW-16-07	8	5.525	1.9543	0.114555
MW-16-08	9	6.97778	4.97488	0.878446
MW-16-10	7	2.74286	2.13608	1.1556
MW-16-11A	7	2.39286	1.5627	0.741547

All Locations

Obs.	Mean	Std. Dev.	Skewness
49	3.76837	3.41014	1.69528

Skewness Coefficient

Parameter: Lead

Natural Logarithm Transformation

Non-Detects Replaced with 1/2 DL

Skewness > 1 indicates positively skewed data

Skewness < -1 indicates negatively skewed data

Compliance Locations

Location	Obs.	Mean	Std. Dev.	Skewness
MW-16-05	9	1.05315	0.690688	0.489817
MW-16-06	9	-0.34534	0.754472	1.86086
MW-16-07	8	1.64834	0.386411	-0.52269
MW-16-08	9	1.71892	0.717566	0.068632
MW-16-10	7	0.743103	0.827518	-0.336561
MW-16-11A	7	0.663245	0.748863	-0.563398

All Locations

Obs.	Mean	Std. Dev.	Skewness
49	0.915748	0.981552	-0.302976

Skewness Coefficient

Parameter: Lithium

Original Data (Not Transformed)

Non-Detects Replaced with 1/2 DL

Skewness > 1 indicates positively skewed data

Skewness < -1 indicates negatively skewed data

Compliance Locations

Location	Obs.	Mean	Std. Dev.	Skewness
MW-16-05	9	55.1111	4.04489	0.20306
MW-16-06	9	39.2778	5.05662	0.493967
MW-16-07	9	63.4444	9.4222	0.351593
MW-16-08	9	73.3333	10.6536	0.949387
MW-16-10	7	78.2857	10.9805	-0.119962
MW-16-11A	8	59.1875	22.0583	1.67414

All Locations

Obs.	Mean	Std. Dev.	Skewness
51	60.8235	16.841	0.579078

Skewness Coefficient

Parameter: Lithium

Natural Logarithm Transformation

Non-Detects Replaced with 1/2 DL

Skewness > 1 indicates positively skewed data
Skewness < -1 indicates negatively skewed data

Compliance Locations

Location	Obs.	Mean	Std. Dev.	Skewness
MW-16-05	9	4.00697	0.0731896	0.0789647
MW-16-06	9	3.66346	0.126602	0.278714
MW-16-07	9	4.14052	0.146804	0.200143
MW-16-08	9	4.28621	0.138705	0.696363
MW-16-10	7	4.35174	0.14266	-0.203025
MW-16-11A	8	4.03259	0.314509	1.10921

All Locations

Obs.	Mean	Std. Dev.	Skewness
51	4.07054	0.278116	-0.112333

Shapiro-Wilks Test of Normality

Parameter: Lithium

Location: MW-16-11A

Normality Test of Parameter Concentrations

Original Data (Not Transformed)

Non-Detects Replaced with 1/2 DL

K = 4 for 8 measurements

i	x(i)	x(n-i+1)	x(n-1+1)-x(i)	a(n-i+1)	b(i)
1	39	110	71	0.6052	42.9692
2	42.5	64	21.5	0.3164	6.8026
3	52	58	6	0.1743	1.0458
4	52	56	4	0.0561	0.2244
5	56	52	-4		
6	58	52	-6		
7	64	42.5	-21.5		
8	110	39	-71		

Sum of b values = 51.042

Sample Standard Deviation = 22.0583

W Statistic = 0.764918

5% Critical value of 0.818 exceeds 0.764918
Evidence of non-normality at 95% level of significance

1% Critical value of 0.749 is less than 0.764918
Data is normally distributed at 99% level of significance

Shapiro-Wilks Test of Normality

Parameter: Lithium

Location: MW-16-11A

Normality Test of Parameter Concentrations

Natural Logarithm Transformation

Non-Detects Replaced with 1/2 DL

K = 4 for 8 measurements

i	x(i)	x(n-i+1)	x(n-1+1)-x(i)	a(n-i+1)	b(i)
1	3.66356	4.70048	1.03692	0.6052	0.627543
2	3.7495	4.15888	0.409379	0.3164	0.129528
3	3.95124	4.06044	0.109199	0.1743	0.0190334
4	3.95124	4.02535	0.074108	0.0561	0.00415746
5	4.02535	3.95124	-0.074108		
6	4.06044	3.95124	-0.109199		
7	4.15888	3.7495	-0.409379		
8	4.70048	3.66356	-1.03692		

Sum of b values = 0.780262

Sample Standard Deviation = 0.314509

W Statistic = 0.87926

5% Critical value of 0.818 is less than 0.87926
Data is normally distributed at 95% level of significance

1% Critical value of 0.749 is less than 0.87926
Data is normally distributed at 99% level of significance

Skewness Coefficient

Parameter: Molybdenum

Original Data (Not Transformed)

Non-Detects Replaced with 1/2 DL

Skewness > 1 indicates positively skewed data

Skewness < -1 indicates negatively skewed data

Compliance Locations

Location	Obs.	Mean	Std. Dev.	Skewness
MW-16-05	9	23.6667	7.54983	2.11944
MW-16-06	9	19.3889	4.37163	1.79557
MW-16-07	9	30.7778	17.0278	1.90393
MW-16-08	9	38.7778	9.39119	0.851996
MW-16-10	7	20.4286	6.18755	1.25926
MW-16-11A	8	22	6.27922	1.04371

All Locations

Obs.	Mean	Std. Dev.	Skewness
51	26.1275	11.4904	1.96117

Skewness Coefficient

Parameter: Molybdenum

Natural Logarithm Transformation

Non-Detects Replaced with 1/2 DL

Skewness > 1 indicates positively skewed data
Skewness < -1 indicates negatively skewed data

Compliance Locations

Location	Obs.	Mean	Std. Dev.	Skewness
MW-16-05	9	3.13035	0.256218	1.8128
MW-16-06	9	2.94606	0.195269	1.57811
MW-16-07	9	3.33105	0.42687	1.32689
MW-16-08	9	3.63358	0.230075	0.47356
MW-16-10	7	2.983	0.271862	0.873361
MW-16-11A	8	3.05985	0.257785	0.974189

All Locations

Obs.	Mean	Std. Dev.	Skewness
51	3.19077	0.362574	0.990304

Shapiro-Wilks Test of Normality

Parameter: Molybdenum

Location: MW-16-05

Normality Test of Parameter Concentrations

Original Data (Not Transformed)

Non-Detects Replaced with 1/2 DL

K = 4 for 9 measurements

i	x(i)	x(n-i+1)	x(n-1+1)-x(i)	a(n-i+1)	b(i)
1	18	43	25	0.5888	14.72
2	20	25	5	0.3244	1.622
3	20	23	3	0.1976	0.5928
4	20	23	3	0.0947	0.2841
5	21	21	0		
6	23	20	-3		
7	23	20	-3		
8	25	20	-5		
9	43	18	-25		

Sum of b values = 17.2189

Sample Standard Deviation = 7.54983

W Statistic = 0.650199

5% Critical value of 0.829 exceeds 0.650199
Evidence of non-normality at 95% level of significance

1% Critical value of 0.764 exceeds 0.650199
Evidence of non-normality at 99% level of significance

Shapiro-Wilks Test of Normality

Parameter: Molybdenum

Location: MW-16-05

Normality Test of Parameter Concentrations

Natural Logarithm Transformation

Non-Detects Replaced with 1/2 DL

K = 4 for 9 measurements

i	x(i)	x(n-i+1)	x(n-1+1)-x(i)	a(n-i+1)	b(i)
1	2.89037	3.7612	0.870828	0.5888	0.512744
2	2.99573	3.21888	0.223144	0.3244	0.0723878
3	2.99573	3.13549	0.139762	0.1976	0.027617
4	2.99573	3.13549	0.139762	0.0947	0.0132355
5	3.04452	3.04452	0		
6	3.13549	2.99573	-0.139762		
7	3.13549	2.99573	-0.139762		
8	3.21888	2.99573	-0.223144		
9	3.7612	2.89037	-0.870828		

Sum of b values = 0.625984

Sample Standard Deviation = 0.256218

W Statistic = 0.746132

5% Critical value of 0.829 exceeds 0.746132
Evidence of non-normality at 95% level of significance

1% Critical value of 0.764 exceeds 0.746132
Evidence of non-normality at 99% level of significance

Shapiro-Wilks Test of Normality

Parameter: Molybdenum

Location: MW-16-06

Normality Test of Parameter Concentrations

Original Data (Not Transformed)

Non-Detects Replaced with 1/2 DL

K = 4 for 9 measurements

i	x(i)	x(n-i+1)	x(n-1+1)-x(i)	a(n-i+1)	b(i)
1	16.5	30	13.5	0.5888	7.9488
2	17	22	5	0.3244	1.622
3	17	20	3	0.1976	0.5928
4	17	18	1	0.0947	0.0947
5	17	17	0		
6	18	17	-1		
7	20	17	-3		
8	22	17	-5		
9	30	16.5	-13.5		

Sum of b values = 10.2583

Sample Standard Deviation = 4.37163

W Statistic = 0.688295

5% Critical value of 0.829 exceeds 0.688295
Evidence of non-normality at 95% level of significance

1% Critical value of 0.764 exceeds 0.688295
Evidence of non-normality at 99% level of significance

Shapiro-Wilks Test of Normality

Parameter: Molybdenum

Location: MW-16-06

Normality Test of Parameter Concentrations

Natural Logarithm Transformation

Non-Detects Replaced with 1/2 DL

K = 4 for 9 measurements

i	x(i)	x(n-i+1)	x(n-1+1)-x(i)	a(n-i+1)	b(i)
1	2.80336	3.4012	0.597837	0.5888	0.352006
2	2.83321	3.09104	0.257829	0.3244	0.0836398
3	2.83321	2.99573	0.162519	0.1976	0.0321137
4	2.83321	2.89037	0.0571584	0.0947	0.0054129
5	2.83321	2.83321	0		
6	2.89037	2.83321	-0.0571584		
7	2.99573	2.83321	-0.162519		
8	3.09104	2.83321	-0.257829		
9	3.4012	2.80336	-0.597837		

Sum of b values = 0.473173

Sample Standard Deviation = 0.195269

W Statistic = 0.73398

5% Critical value of 0.829 exceeds 0.73398
Evidence of non-normality at 95% level of significance

1% Critical value of 0.764 exceeds 0.73398
Evidence of non-normality at 99% level of significance

Shapiro-Wilks Test of Normality

Parameter: Molybdenum

Location: MW-16-07

Normality Test of Parameter Concentrations

Original Data (Not Transformed)

Non-Detects Replaced with 1/2 DL

K = 4 for 9 measurements

i	x(i)	x(n-i+1)	x(n-1+1)-x(i)	a(n-i+1)	b(i)
1	19	73	54	0.5888	31.7952
2	19	38	19	0.3244	6.1636
3	22	33	11	0.1976	2.1736
4	24	25	1	0.0947	0.0947
5	24	24	0		
6	25	24	-1		
7	33	22	-11		
8	38	19	-19		
9	73	19	-54		

Sum of b values = 40.2271

Sample Standard Deviation = 17.0278

W Statistic = 0.697642

5% Critical value of 0.829 exceeds 0.697642
Evidence of non-normality at 95% level of significance

1% Critical value of 0.764 exceeds 0.697642
Evidence of non-normality at 99% level of significance

Shapiro-Wilks Test of Normality

Parameter: Molybdenum

Location: MW-16-07

Normality Test of Parameter Concentrations

Natural Logarithm Transformation

Non-Detects Replaced with 1/2 DL

K = 4 for 9 measurements

i	x(i)	x(n-i+1)	x(n-1+1)-x(i)	a(n-i+1)	b(i)
1	2.94444	4.29046	1.34602	0.5888	0.792537
2	2.94444	3.63759	0.693147	0.3244	0.224857
3	3.09104	3.49651	0.405465	0.1976	0.0801199
4	3.17805	3.21888	0.040822	0.0947	0.00386584
5	3.17805	3.17805	0		
6	3.21888	3.17805	-0.040822		
7	3.49651	3.09104	-0.405465		
8	3.63759	2.94444	-0.693147		
9	4.29046	2.94444	-1.34602		

Sum of b values = 1.10138

Sample Standard Deviation = 0.42687

W Statistic = 0.832132

5% Critical value of 0.829 is less than 0.832132
Data is normally distributed at 95% level of significance

1% Critical value of 0.764 is less than 0.832132
Data is normally distributed at 99% level of significance

Skewness Coefficient

Parameter: Radium-226/228

Original Data (Not Transformed)

Non-Detects Replaced with 1/2 DL

Skewness > 1 indicates positively skewed data
Skewness < -1 indicates negatively skewed data

Compliance Locations

Location	Obs.	Mean	Std. Dev.	Skewness
MW-16-05	9	1.86444	0.867613	1.7901
MW-16-06	9	1.43944	0.383849	0.713621
MW-16-07	9	2.68889	1.02732	0.761539
MW-16-08	9	2.47333	1.14409	1.49391
MW-16-10	7	1.642	0.443285	-0.170195
MW-16-11A	7	1.61071	0.285342	0.818505

All Locations

Obs.	Mean	Std. Dev.	Skewness
50	1.97928	0.892146	1.80807

Skewness Coefficient

Parameter: Radium-226/228

Natural Logarithm Transformation

Non-Detects Replaced with 1/2 DL

Skewness > 1 indicates positively skewed data
Skewness < -1 indicates negatively skewed data

Compliance Locations

Location	Obs.	Mean	Std. Dev.	Skewness
MW-16-05	9	0.550291	0.380046	1.07063
MW-16-06	9	0.334522	0.255133	0.411715
MW-16-07	9	0.929541	0.358243	0.519467
MW-16-08	9	0.829284	0.394328	0.879177
MW-16-10	7	0.46126	0.293093	-0.630276
MW-16-11A	7	0.463979	0.169948	0.513871

All Locations

Obs.	Mean	Std. Dev.	Skewness
50	0.605388	0.378112	0.807454

Shapiro-Wilks Test of Normality

Parameter: Radium-226/228

Location: MW-16-05

Normality Test of Parameter Concentrations

Original Data (Not Transformed)

Non-Detects Replaced with 1/2 DL

K = 4 for 9 measurements

i	x(i)	x(n-i+1)	x(n-1+1)-x(i)	a(n-i+1)	b(i)
1	1.06	3.99	2.93	0.5888	1.72518
2	1.3	2.26	0.96	0.3244	0.311424
3	1.41	1.81	0.4	0.1976	0.07904
4	1.51	1.77	0.26	0.0947	0.024622
5	1.67	1.67	0		
6	1.77	1.51	-0.26		
7	1.81	1.41	-0.4		
8	2.26	1.3	-0.96		
9	3.99	1.06	-2.93		

Sum of b values = 2.14027

Sample Standard Deviation = 0.867613

W Statistic = 0.760667

5% Critical value of 0.829 exceeds 0.760667
Evidence of non-normality at 95% level of significance

1% Critical value of 0.764 exceeds 0.760667
Evidence of non-normality at 99% level of significance

Shapiro-Wilks Test of Normality

Parameter: Radium-226/228

Location: MW-16-05

Normality Test of Parameter Concentrations

Natural Logarithm Transformation

Non-Detects Replaced with 1/2 DL

K = 4 for 9 measurements

i	x(i)	x(n-i+1)	x(n-1+1)-x(i)	a(n-i+1)	b(i)
1	0.0582689	1.38379	1.32552	0.5888	0.780468
2	0.262364	0.815365	0.553001	0.3244	0.179393
3	0.34359	0.593327	0.249737	0.1976	0.0493481
4	0.41211	0.57098	0.15887	0.0947	0.015045
5	0.512824	0.512824	0		
6	0.57098	0.41211	-0.15887		
7	0.593327	0.34359	-0.249737		
8	0.815365	0.262364	-0.553001		
9	1.38379	0.0582689	-1.32552		

Sum of b values = 1.02425

Sample Standard Deviation = 0.380046

W Statistic = 0.907933

5% Critical value of 0.829 is less than 0.907933

Data is normally distributed at 95% level of significance

1% Critical value of 0.764 is less than 0.907933

Data is normally distributed at 99% level of significance

Non-Parametric Tolerance Interval MW-16-05

Parameter: Arsenic

Original Data (Not Transformed)

Non-Detects Replaced with 1/2 DL

Total Percent Non-Detects = 66.6667%

Background measurements (n) = 9

Maximum Background Concentration = 14

Minimum Coverage = 71.7%

Average Coverage = 90%

Location	Date	Value	Significant
----------	------	-------	-------------

Parametric Tolerance Interval Analysis MW-16-05

Parameter: Barium

Natural Logarithm Transformation

Non-Detects Replaced with 1/2 DL

USEPA 1989 Guidance Tolerance Limit Formula (One-Tailed)

Background observations = 9

Background mean = 5.68214

Background standard deviation = 0.0804871

One-sided normal tolerance factor (K) at 95% confidence = 3.031

Upper tolerance limit = 5.9261

Location	Date	Value	Significant
----------	------	-------	-------------

Parametric Tolerance Interval Analysis MW-16-05

Parameter: Chromium

Natural Logarithm Transformation

Non-Detects Replaced with 1/2 DL

USEPA 1989 Guidance Tolerance Limit Formula (One-Tailed)

Background observations = 9

Background mean = 1.92871

Background standard deviation = 0.631947

One-sided normal tolerance factor (K) at 95% confidence = 3.031

Upper tolerance limit = 3.84414

Location	Date	Value	Significant
----------	------	-------	-------------

Parametric Tolerance Interval Analysis MW-16-05

Parameter: Cobalt

Natural Logarithm Transformation

Non-Detects Replaced with 1/2 DL

USEPA 1989 Guidance Tolerance Limit Formula (One-Tailed)

Background observations = 9

Background mean = 1.03443

Background standard deviation = 0.665075

One-sided normal tolerance factor (K) at 95% confidence = 3.031

Upper tolerance limit = 3.05028

Location	Date	Value	Significant
----------	------	-------	-------------

Non-Parametric Tolerance Interval

MW-16-05

Parameter: Fluoride

Original Data (Not Transformed)

Non-Detects Replaced with 1/2 DL

Total Percent Non-Detects = 6.25%

Background measurements (n) = 16

Maximum Background Concentration = 1.3

Minimum Coverage = 82.9%

Average Coverage = 94.1176%

Location	Date	Value	Significant
----------	------	-------	-------------

Parametric Tolerance Interval Analysis

MW-16-05

Parameter: Lead

Natural Logarithm Transformation

Non-Detects Replaced with 1/2 DL

USEPA 1989 Guidance Tolerance Limit Formula (One-Tailed)

Background observations = 9

Background mean = 1.05315

Background standard deviation = 0.690688

One-sided normal tolerance factor (K) at 95% confidence = 3.031

Upper tolerance limit = 3.14662

Location	Date	Value	Significant
----------	------	-------	-------------

Parametric Tolerance Interval Analysis MW-16-05

Parameter: Lithium

Original Data (Not Transformed)

Non-Detects Replaced with 1/2 DL

USEPA 1989 Guidance Tolerance Limit Formula (One-Tailed)

Background observations = 9

Background mean = 55.1111

Background standard deviation = 4.04489

One-sided normal tolerance factor (K) at 95% confidence = 3.031

Upper tolerance limit = 67.3712

Location	Date	Value	Significant
----------	------	-------	-------------

Non-Parametric Tolerance Interval

MW-16-05

Parameter: Molybdenum

Original Data (Not Transformed)

Non-Detects Replaced with 1/2 DL

Total Percent Non-Detects = 0%

Background measurements (n) = 9

Maximum Background Concentration = 43

Minimum Coverage = 71.7%

Average Coverage = 90%

Location	Date	Value	Significant
----------	------	-------	-------------

Parametric Tolerance Interval Analysis

MW-16-05

Parameter: Radium-226/228

Natural Logarithm Transformation

Non-Detects Replaced with 1/2 DL

USEPA 1989 Guidance Tolerance Limit Formula (One-Tailed)

Background observations = 9

Background mean = 0.550291

Background standard deviation = 0.380046

One-sided normal tolerance factor (K) at 95% confidence = 3.031

Upper tolerance limit = 1.70221

Location	Date	Value	Significant
----------	------	-------	-------------

Non-Parametric Tolerance Interval

MW-16-05

Parameter: Thallium

Original Data (Not Transformed)

Non-Detects Replaced with 1/2 DL

Total Percent Non-Detects = 88.8889%

Background measurements (n) = 9

Maximum Background Concentration = 1.1

Minimum Coverage = 71.7%

Average Coverage = 90%

Location	Date	Value	Significant
----------	------	-------	-------------

Non-Parametric Tolerance Interval

MW-16-06

Parameter: Arsenic

Original Data (Not Transformed)

Non-Detects Replaced with 1/2 DL

Total Percent Non-Detects = 88.8889%

Background measurements (n) = 9

Maximum Background Concentration = 7.45

Minimum Coverage = 71.7%

Average Coverage = 90%

Location	Date	Value	Significant
-----------------	-------------	--------------	--------------------

Parametric Tolerance Interval Analysis MW-16-06

Parameter: Barium

Original Data (Not Transformed)

Non-Detects Replaced with 1/2 DL

USEPA 1989 Guidance Tolerance Limit Formula (One-Tailed)

Background observations = 9

Background mean = 277.778

Background standard deviation = 17.1594

One-sided normal tolerance factor (K) at 95% confidence = 3.031

Upper tolerance limit = 329.788

Location	Date	Value	Significant
----------	------	-------	-------------

Non-Parametric Tolerance Interval MW-16-06

Parameter: Chromium

Original Data (Not Transformed)

Non-Detects Replaced with 1/2 DL

Total Percent Non-Detects = 66.6667%

Background measurements (n) = 9

Maximum Background Concentration = 13.5

Minimum Coverage = 71.7%

Average Coverage = 90%

Location	Date	Value	Significant
----------	------	-------	-------------

Non-Parametric Tolerance Interval MW-16-06

Parameter: Cobalt

Original Data (Not Transformed)

Non-Detects Replaced with 1/2 DL

Total Percent Non-Detects = 77.7778%

Background measurements (n) = 9

Maximum Background Concentration = 4.7

Minimum Coverage = 71.7%

Average Coverage = 90%

Location	Date	Value	Significant
----------	------	-------	-------------

Non-Parametric Tolerance Interval MW-16-06

Parameter: Fluoride

Original Data (Not Transformed)

Non-Detects Replaced with 1/2 DL

Total Percent Non-Detects = 6.25%

Background measurements (n) = 16

Maximum Background Concentration = 1.3

Minimum Coverage = 82.9%

Average Coverage = 94.1176%

Location	Date	Value	Significant
-----------------	-------------	--------------	--------------------

Non-Parametric Tolerance Interval

MW-16-06

Parameter: Lead

Original Data (Not Transformed)

Non-Detects Replaced with 1/2 DL

Total Percent Non-Detects = 77.7778%

Background measurements (n) = 9

Maximum Background Concentration = 4.4

Minimum Coverage = 71.7%

Average Coverage = 90%

Location	Date	Value	Significant
----------	------	-------	-------------

Parametric Tolerance Interval Analysis MW-16-06

Parameter: Lithium

Original Data (Not Transformed)

Non-Detects Replaced with 1/2 DL

USEPA 1989 Guidance Tolerance Limit Formula (One-Tailed)

Background observations = 9

Background mean = 39.2778

Background standard deviation = 5.05662

One-sided normal tolerance factor (K) at 95% confidence = 3.031

Upper tolerance limit = 54.6044

Location	Date	Value	Significant
----------	------	-------	-------------

Non-Parametric Tolerance Interval

MW-16-06

Parameter: Molybdenum

Original Data (Not Transformed)

Non-Detects Replaced with 1/2 DL

Total Percent Non-Detects = 0%

Background measurements (n) = 9

Maximum Background Concentration = 30

Minimum Coverage = 71.7%

Average Coverage = 90%

Location	Date	Value	Significant
----------	------	-------	-------------

Parametric Tolerance Interval Analysis

MW-16-06

Parameter: Radium-226/228

Original Data (Not Transformed)

Non-Detects Replaced with 1/2 DL

USEPA 1989 Guidance Tolerance Limit Formula (One-Tailed)

Background observations = 9

Background mean = 1.43944

Background standard deviation = 0.383849

One-sided normal tolerance factor (K) at 95% confidence = 3.031

Upper tolerance limit = 2.60289

Location	Date	Value	Significant
----------	------	-------	-------------

Parametric Tolerance Interval Analysis

MW-16-07

Parameter: Arsenic

Original Data (Not Transformed)

Aitchison's Adjustment

USEPA 1989 Guidance Tolerance Limit Formula (One-Tailed)

Background observations = 8

Background mean = 6

Background standard deviation = 3.97887

One-sided normal tolerance factor (K) at 95% confidence = 3.188

Upper tolerance limit = 18.6846

Location	Date	Value	Significant
----------	------	-------	-------------

Parametric Tolerance Interval Analysis

MW-16-07

Parameter: Barium

Natural Logarithm Transformation

Non-Detects Replaced with 1/2 DL

USEPA 1989 Guidance Tolerance Limit Formula (One-Tailed)

Background observations = 9

Background mean = 5.80354

Background standard deviation = 0.13808

One-sided normal tolerance factor (K) at 95% confidence = 3.031

Upper tolerance limit = 6.22207

Location	Date	Value	Significant
----------	------	-------	-------------

Non-Parametric Tolerance Interval

MW-16-07

Parameter: **Beryllium**

Original Data (Not Transformed)

Non-Detects Replaced with 1/2 DL

Total Percent Non-Detects = 88.8889%

Background measurements (n) = 9

Maximum Background Concentration = 1.7

Minimum Coverage = 71.7%

Average Coverage = 90%

Location	Date	Value	Significant
----------	------	-------	-------------

Non-Parametric Tolerance Interval

MW-16-07

Parameter: Cadmium

Original Data (Not Transformed)

Non-Detects Replaced with 1/2 DL

Total Percent Non-Detects = 88.8889%

Background measurements (n) = 9

Maximum Background Concentration = 1.3

Minimum Coverage = 71.7%

Average Coverage = 90%

Location	Date	Value	Significant
----------	------	-------	-------------

Parametric Tolerance Interval Analysis

MW-16-07

Parameter: Chromium

Original Data (Not Transformed)

Non-Detects Replaced with 1/2 DL

USEPA 1989 Guidance Tolerance Limit Formula (One-Tailed)

Background observations = 8

Background mean = 11.9625

Background standard deviation = 4.78329

One-sided normal tolerance factor (K) at 95% confidence = 3.188

Upper tolerance limit = 27.2116

Location	Date	Value	Significant
----------	------	-------	-------------

Parametric Tolerance Interval Analysis

MW-16-07

Parameter: Cobalt

Original Data (Not Transformed)

Non-Detects Replaced with 1/2 DL

USEPA 1989 Guidance Tolerance Limit Formula (One-Tailed)

Background observations = 8

Background mean = 5.8625

Background standard deviation = 2.23411

One-sided normal tolerance factor (K) at 95% confidence = 3.188

Upper tolerance limit = 12.9848

Location	Date	Value	Significant
----------	------	-------	-------------

Non-Parametric Tolerance Interval

MW-16-07

Parameter: Fluoride

Original Data (Not Transformed)

Non-Detects Replaced with 1/2 DL

Total Percent Non-Detects = 12.5%

Background measurements (n) = 16

Maximum Background Concentration = 1.2

Minimum Coverage = 82.9%

Average Coverage = 94.1176%

Location	Date	Value	Significant
----------	------	-------	-------------

Parametric Tolerance Interval Analysis

MW-16-07

Parameter: Lead

Original Data (Not Transformed)

Non-Detects Replaced with 1/2 DL

USEPA 1989 Guidance Tolerance Limit Formula (One-Tailed)

Background observations = 8

Background mean = 5.525

Background standard deviation = 1.9543

One-sided normal tolerance factor (K) at 95% confidence = 3.188

Upper tolerance limit = 11.7553

Location	Date	Value	Significant
----------	------	-------	-------------

Parametric Tolerance Interval Analysis

MW-16-07

Parameter: Lithium

Original Data (Not Transformed)

Non-Detects Replaced with 1/2 DL

USEPA 1989 Guidance Tolerance Limit Formula (One-Tailed)

Background observations = 9

Background mean = 63.4444

Background standard deviation = 9.4222

One-sided normal tolerance factor (K) at 95% confidence = 3.031

Upper tolerance limit = 92.0031

Location	Date	Value	Significant
----------	------	-------	-------------

Parametric Tolerance Interval Analysis

MW-16-07

Parameter: Molybdenum

Natural Logarithm Transformation

Non-Detects Replaced with 1/2 DL

USEPA 1989 Guidance Tolerance Limit Formula (One-Tailed)

Background observations = 9

Background mean = 3.33105

Background standard deviation = 0.42687

One-sided normal tolerance factor (K) at 95% confidence = 3.031

Upper tolerance limit = 4.62489

Location	Date	Value	Significant
----------	------	-------	-------------

Parametric Tolerance Interval Analysis

MW-16-07

Parameter: Radium-226/228

Original Data (Not Transformed)

Non-Detects Replaced with 1/2 DL

USEPA 1989 Guidance Tolerance Limit Formula (One-Tailed)

Background observations = 9

Background mean = 2.68889

Background standard deviation = 1.02732

One-sided normal tolerance factor (K) at 95% confidence = 3.031

Upper tolerance limit = 5.8027

Location	Date	Value	Significant
----------	------	-------	-------------

Non-Parametric Tolerance Interval

MW-16-07

Parameter: Selenium

Original Data (Not Transformed)

Non-Detects Replaced with 1/2 DL

Total Percent Non-Detects = 88.8889%

Background measurements (n) = 9

Maximum Background Concentration = 5.3

Minimum Coverage = 71.7%

Average Coverage = 90%

Location	Date	Value	Significant
----------	------	-------	-------------

Non-Parametric Tolerance Interval

MW-16-07

Parameter: Thallium

Original Data (Not Transformed)

Non-Detects Replaced with 1/2 DL

Total Percent Non-Detects = 77.7778%

Background measurements (n) = 9

Maximum Background Concentration = 2.3

Minimum Coverage = 71.7%

Average Coverage = 90%

Location	Date	Value	Significant
----------	------	-------	-------------

Non-Parametric Tolerance Interval

MW-16-08

Parameter: Antimony

Original Data (Not Transformed)

Non-Detects Replaced with 1/2 DL

Total Percent Non-Detects = 88.8889%

Background measurements (n) = 9

Maximum Background Concentration = 2.1

Minimum Coverage = 71.7%

Average Coverage = 90%

Location	Date	Value	Significant
----------	------	-------	-------------

Parametric Tolerance Interval Analysis

MW-16-08

Parameter: Arsenic

Original Data (Not Transformed)

Aitchison's Adjustment

USEPA 1989 Guidance Tolerance Limit Formula (One-Tailed)

Background observations = 9

Background mean = 7.75556

Background standard deviation = 7.36802

One-sided normal tolerance factor (K) at 95% confidence = 3.031

Upper tolerance limit = 30.088

Location	Date	Value	Significant
----------	------	-------	-------------

Parametric Tolerance Interval Analysis

MW-16-08

Parameter: Barium

Original Data (Not Transformed)

Non-Detects Replaced with 1/2 DL

USEPA 1989 Guidance Tolerance Limit Formula (One-Tailed)

Background observations = 9

Background mean = 346.667

Background standard deviation = 47.697

One-sided normal tolerance factor (K) at 95% confidence = 3.031

Upper tolerance limit = 491.236

Location	Date	Value	Significant
----------	------	-------	-------------

Non-Parametric Tolerance Interval

MW-16-08

Parameter: Beryllium

Original Data (Not Transformed)

Non-Detects Replaced with 1/2 DL

Total Percent Non-Detects = 77.7778%

Background measurements (n) = 9

Maximum Background Concentration = 1.6

Minimum Coverage = 71.7%

Average Coverage = 90%

Location	Date	Value	Significant
----------	------	-------	-------------

Non-Parametric Tolerance Interval

MW-16-08

Parameter: Cadmium

Original Data (Not Transformed)

Non-Detects Replaced with 1/2 DL

Total Percent Non-Detects = 88.8889%

Background measurements (n) = 9

Maximum Background Concentration = 1.5

Minimum Coverage = 71.7%

Average Coverage = 90%

Location	Date	Value	Significant
-----------------	-------------	--------------	--------------------

Parametric Tolerance Interval Analysis

MW-16-08

Parameter: Chromium

Original Data (Not Transformed)

Non-Detects Replaced with 1/2 DL

USEPA 1989 Guidance Tolerance Limit Formula (One-Tailed)

Background observations = 9

Background mean = 17.3556

Background standard deviation = 12.4719

One-sided normal tolerance factor (K) at 95% confidence = 3.031

Upper tolerance limit = 55.1578

Location	Date	Value	Significant
----------	------	-------	-------------

Parametric Tolerance Interval Analysis

MW-16-08

Parameter: Cobalt

Original Data (Not Transformed)

Non-Detects Replaced with 1/2 DL

USEPA 1989 Guidance Tolerance Limit Formula (One-Tailed)

Background observations = 9

Background mean = 7.25556

Background standard deviation = 4.77915

One-sided normal tolerance factor (K) at 95% confidence = 3.031

Upper tolerance limit = 21.7412

Location	Date	Value	Significant
----------	------	-------	-------------

Parametric Tolerance Interval Analysis

MW-16-08

Parameter: Fluoride

Original Data (Not Transformed)

Non-Detects Replaced with 1/2 DL

USEPA 1989 Guidance Tolerance Limit Formula (One-Tailed)

Background observations = 16

Background mean = 1.13125

Background standard deviation = 0.07932

One-sided normal tolerance factor (K) at 95% confidence = 2.523

Upper tolerance limit = 1.33137

Location	Date	Value	Significant
----------	------	-------	-------------

Parametric Tolerance Interval Analysis

MW-16-08

Parameter: Lead

Original Data (Not Transformed)

Non-Detects Replaced with 1/2 DL

USEPA 1989 Guidance Tolerance Limit Formula (One-Tailed)

Background observations = 9

Background mean = 6.97778

Background standard deviation = 4.97488

One-sided normal tolerance factor (K) at 95% confidence = 3.031

Upper tolerance limit = 22.0566

Location	Date	Value	Significant
----------	------	-------	-------------

Parametric Tolerance Interval Analysis

MW-16-08

Parameter: Lithium

Original Data (Not Transformed)

Non-Detects Replaced with 1/2 DL

USEPA 1989 Guidance Tolerance Limit Formula (One-Tailed)

Background observations = 9

Background mean = 73.3333

Background standard deviation = 10.6536

One-sided normal tolerance factor (K) at 95% confidence = 3.031

Upper tolerance limit = 105.625

Location	Date	Value	Significant
----------	------	-------	-------------

Parametric Tolerance Interval Analysis

Parameter: Molybdenum

Original Data (Not Transformed)

Non-Detects Replaced with 1/2 DL

USEPA 1989 Guidance Tolerance Limit Formula (One-Tailed)

Background observations = 9

Background mean = 38.7778

Background standard deviation = 9.39119

One-sided normal tolerance factor (K) at 95% confidence = 3.031

Upper tolerance limit = 67.2425

Location	Date	Value	Significant
----------	------	-------	-------------

Parametric Tolerance Interval Analysis

MW-16-08

Parameter: Radium-226/228

Natural Logarithm Transformation

Non-Detects Replaced with 1/2 DL

USEPA 1989 Guidance Tolerance Limit Formula (One-Tailed)

Background observations = 9

Background mean = 0.829284

Background standard deviation = 0.394328

One-sided normal tolerance factor (K) at 95% confidence = 3.031

Upper tolerance limit = 2.02449

Location	Date	Value	Significant
----------	------	-------	-------------

Non-Parametric Tolerance Interval

MW-16-08

Parameter: Thallium

Original Data (Not Transformed)

Non-Detects Replaced with 1/2 DL

Total Percent Non-Detects = 77.7778%

Background measurements (n) = 9

Maximum Background Concentration = 1.3

Minimum Coverage = 71.7%

Average Coverage = 90%

Location	Date	Value	Significant
----------	------	-------	-------------

Non-Parametric Tolerance Interval

MW-16-10

Parameter: Antimony

Original Data (Not Transformed)

Non-Detects Replaced with 1/2 DL

Total Percent Non-Detects = 85.7143%

Background measurements (n) = 7

Maximum Background Concentration = 2.1

Minimum Coverage = 65.2%

Average Coverage = 87.5%

Location	Date	Value	Significant
----------	------	-------	-------------

Non-Parametric Tolerance Interval

MW-16-10

Parameter: Arsenic

Original Data (Not Transformed)

Non-Detects Replaced with 1/2 DL

Total Percent Non-Detects = 71.4286%

Background measurements (n) = 7

Maximum Background Concentration = 11

Minimum Coverage = 65.2%

Average Coverage = 87.5%

Location	Date	Value	Significant
-----------------	-------------	--------------	--------------------

Parametric Tolerance Interval Analysis

MW-16-10

Parameter: Barium

Original Data (Not Transformed)

Non-Detects Replaced with 1/2 DL

USEPA 1989 Guidance Tolerance Limit Formula (One-Tailed)

Background observations = 7

Background mean = 125.714

Background standard deviation = 20.702

One-sided normal tolerance factor (K) at 95% confidence = 3.399

Upper tolerance limit = 196.08

Location	Date	Value	Significant
----------	------	-------	-------------

Parametric Tolerance Interval Analysis

MW-16-10

Parameter: Chromium

Original Data (Not Transformed)

Non-Detects Replaced with 1/2 DL

USEPA 1989 Guidance Tolerance Limit Formula (One-Tailed)

Background observations = 7

Background mean = 10.2286

Background standard deviation = 6.54948

One-sided normal tolerance factor (K) at 95% confidence = 3.399

Upper tolerance limit = 32.4903

Location	Date	Value	Significant
----------	------	-------	-------------

Parametric Tolerance Interval Analysis

MW-16-10

Parameter: Cobalt

Original Data (Not Transformed)

Non-Detects Replaced with 1/2 DL

USEPA 1989 Guidance Tolerance Limit Formula (One-Tailed)

Background observations = 7

Background mean = 4.84286

Background standard deviation = 3.66554

One-sided normal tolerance factor (K) at 95% confidence = 3.399

Upper tolerance limit = 17.302

Location	Date	Value	Significant
----------	------	-------	-------------

Parametric Tolerance Interval Analysis

MW-16-10

Parameter: Fluoride

Original Data (Not Transformed)

Aitchison's Adjustment

USEPA 1989 Guidance Tolerance Limit Formula (One-Tailed)

Background observations = 14

Background mean = 0.746429

Background standard deviation = 0.49984

One-sided normal tolerance factor (K) at 95% confidence = 2.614

Upper tolerance limit = 2.05301

Location	Date	Value	Significant
----------	------	-------	-------------

Parametric Tolerance Interval Analysis

MW-16-10

Parameter: Lead

Natural Logarithm Transformation

Non-Detects Replaced with 1/2 DL

USEPA 1989 Guidance Tolerance Limit Formula (One-Tailed)

Background observations = 7

Background mean = 0.743103

Background standard deviation = 0.827518

One-sided normal tolerance factor (K) at 95% confidence = 3.399

Upper tolerance limit = 3.55584

Location	Date	Value	Significant
----------	------	-------	-------------

Parametric Tolerance Interval Analysis

MW-16-10

Parameter: Lithium

Original Data (Not Transformed)

Non-Detects Replaced with 1/2 DL

USEPA 1989 Guidance Tolerance Limit Formula (One-Tailed)

Background observations = 7

Background mean = 78.2857

Background standard deviation = 10.9805

One-sided normal tolerance factor (K) at 95% confidence = 3.399

Upper tolerance limit = 115.608

Location	Date	Value	Significant
----------	------	-------	-------------

Parametric Tolerance Interval Analysis

MW-16-10

Parameter: Molybdenum

Natural Logarithm Transformation

Non-Detects Replaced with 1/2 DL

USEPA 1989 Guidance Tolerance Limit Formula (One-Tailed)

Background observations = 7

Background mean = 2.983

Background standard deviation = 0.271862

One-sided normal tolerance factor (K) at 95% confidence = 3.399

Upper tolerance limit = 3.90706

Location	Date	Value	Significant
----------	------	-------	-------------

Parametric Tolerance Interval Analysis

MW-16-10

Parameter: Radium-226/228

Original Data (Not Transformed)

Non-Detects Replaced with 1/2 DL

USEPA 1989 Guidance Tolerance Limit Formula (One-Tailed)

Background observations = 7

Background mean = 1.642

Background standard deviation = 0.443285

One-sided normal tolerance factor (K) at 95% confidence = 3.399

Upper tolerance limit = 3.14872

Location	Date	Value	Significant
----------	------	-------	-------------

Non-Parametric Tolerance Interval

MW-16-11/MW-16-11A

Parameter: Antimony

Original Data (Not Transformed)

Non-Detects Replaced with 1/2 DL

Total Percent Non-Detects = 62.5%

Background measurements (n) = 8

Maximum Background Concentration = 3.2

Minimum Coverage = 68.8%

Average Coverage = 88.8889%

Location	Date	Value	Significant
----------	------	-------	-------------

Parametric Tolerance Interval Analysis MW-16-11/MW-16-11A

Parameter: Arsenic

Original Data (Not Transformed)

Cohen's Adjustment

USEPA 1989 Guidance Tolerance Limit Formula (One-Tailed)

Background observations = 8

Background mean = 9.27

Background standard deviation = 4.77357

One-sided normal tolerance factor (K) at 95% confidence = 3.188

Upper tolerance limit = 24.4882

Location	Date	Value	Significant
----------	------	-------	-------------

Parametric Tolerance Interval Analysis MW-16-11/MW-16-11A

Parameter: Barium

Original Data (Not Transformed)

Non-Detects Replaced with 1/2 DL

USEPA 1989 Guidance Tolerance Limit Formula (One-Tailed)

Background observations = 8

Background mean = 302.5

Background standard deviation = 99.8213

One-sided normal tolerance factor (K) at 95% confidence = 3.188

Upper tolerance limit = 620.73

Location	Date	Value	Significant
----------	------	-------	-------------

Non-Parametric Tolerance Interval MW-16-11/MW-16-11A

Parameter: **Beryllium**

Original Data (Not Transformed)

Non-Detects Replaced with 1/2 DL

Total Percent Non-Detects = 87.5%

Background measurements (n) = 8

Maximum Background Concentration = 1.6

Minimum Coverage = 68.8%

Average Coverage = 88.8889%

Location	Date	Value	Significant
----------	------	-------	-------------

Parametric Tolerance Interval Analysis MW-16-11/MW-16-11A

Parameter: Chromium

Original Data (Not Transformed)

Non-Detects Replaced with 1/2 DL

USEPA 1989 Guidance Tolerance Limit Formula (One-Tailed)

Background observations = 7

Background mean = 6.56429

Background standard deviation = 3.30488

One-sided normal tolerance factor (K) at 95% confidence = 3.399

Upper tolerance limit = 17.7976

Location	Date	Value	Significant
----------	------	-------	-------------

Parametric Tolerance Interval Analysis MW-16-11/MW-16-11A

Parameter: Cobalt

Original Data (Not Transformed)

Aitchison's Adjustment

USEPA 1989 Guidance Tolerance Limit Formula (One-Tailed)

Background observations = 7

Background mean = 2.05714

Background standard deviation = 1.4718

One-sided normal tolerance factor (K) at 95% confidence = 3.399

Upper tolerance limit = 7.05979

Location	Date	Value	Significant
----------	------	-------	-------------

Parametric Tolerance Interval Analysis MW-16-11/MW-16-11A

Parameter: Fluoride

Original Data (Not Transformed)

Aitchison's Adjustment

USEPA 1989 Guidance Tolerance Limit Formula (One-Tailed)

Background observations = 15

Background mean = 0.641556

Background standard deviation = 0.471515

One-sided normal tolerance factor (K) at 95% confidence = 2.566

Upper tolerance limit = 1.85146

Location	Date	Value	Significant
----------	------	-------	-------------

Parametric Tolerance Interval Analysis MW-16-11/MW-16-11A

Parameter: Lead

Original Data (Not Transformed)

Non-Detects Replaced with 1/2 DL

USEPA 1989 Guidance Tolerance Limit Formula (One-Tailed)

Background observations = 7

Background mean = 2.39286

Background standard deviation = 1.5627

One-sided normal tolerance factor (K) at 95% confidence = 3.399

Upper tolerance limit = 7.70447

Location	Date	Value	Significant
----------	------	-------	-------------

Parametric Tolerance Interval Analysis MW-16-11/MW-16-11A

Parameter: Lithium

Natural Logarithm Transformation

Non-Detects Replaced with 1/2 DL

USEPA 1989 Guidance Tolerance Limit Formula (One-Tailed)

Background observations = 8

Background mean = 4.03259

Background standard deviation = 0.314509

One-sided normal tolerance factor (K) at 95% confidence = 3.188

Upper tolerance limit = 5.03524

Location	Date	Value	Significant
----------	------	-------	-------------

Parametric Tolerance Interval Analysis MW-16-11/MW-16-11A

Parameter: Molybdenum

Natural Logarithm Transformation

Non-Detects Replaced with 1/2 DL

USEPA 1989 Guidance Tolerance Limit Formula (One-Tailed)

Background observations = 8

Background mean = 3.05985

Background standard deviation = 0.257785

One-sided normal tolerance factor (K) at 95% confidence = 3.188

Upper tolerance limit = 3.88167

Location	Date	Value	Significant
----------	------	-------	-------------

Parametric Tolerance Interval Analysis MW-16-11/MW-16-11A

Parameter: Radium-226/228

Original Data (Not Transformed)

Non-Detects Replaced with 1/2 DL

USEPA 1989 Guidance Tolerance Limit Formula (One-Tailed)

Background observations = 7

Background mean = 1.61071

Background standard deviation = 0.285342

One-sided normal tolerance factor (K) at 95% confidence = 3.399

Upper tolerance limit = 2.58059

Location	Date	Value	Significant
----------	------	-------	-------------

**APPENDIX M – FATE AND TRANSPORT
MODEL INPUTS**

Calculation Package

COMPUTATION COVER SHEET

Client: DTE Project: BRPP ALD Project/
Proposal No.: GLP8017
Task No.

Title of Computations Vertical Darcy Velocity and Travel Time Calculations

Computations by: Signature *Nick Williams* 11/17/2021
Printed Name Nick Williams Date
Title Senior Staff Professional

Assumptions and Procedures Checked by: Signature *Jesse Varsho* 11/17/2021
Printed Name Jesse Varsho Date
(peer reviewer) Title _____

Computations Checked by: Signature *Isaiah Vaught* 11/17/2021
Printed Name Isaiah Vaught Date
Title _____

Computations backchecked by: Signature *Nick Williams* 11/17/2021
(originator) Printed Name Nick Williams Date
Title _____

Approved by: Signature *Omer Bozok* 11/24/2021
(pm or designate) Printed Name Omer Bozok Date
Title _____

Approval notes: _____

Revisions (number and initial all revisions)

No.	Sheet	Date	By	Checked by	Approval
_____	_____	_____	_____	_____	_____
_____	_____	_____	_____	_____	_____
_____	_____	_____	_____	_____	_____

TABLE OF CONTENTS

1. PURPOSE.....	3
2. ASSUMPTIONS.....	3
3. DARCY VELOCITY SOLUTION	3
4. TRAVEL TIME SOLUTION.....	4

1. PURPOSE

The purpose of this calculation package is to calculate the vertical Darcy velocity of the model lithology for input in Fate and Transport numerical model at the Belle River Power Plant Diversion Basin (DB). Following Darcy velocity calculation, the solution is used to calculate the time of travel from the DB to the Uppermost Aquifer.

2. ASSUMPTIONS

- Vertical flow is the dominant influence on contaminant transport; horizontal flow is not considered since a one-dimensional model was selected.
- Vertical hydraulic conductivity calculated in the laboratory using samples collected from borings is representative of subsurface conditions.

3. SOLUTION

The Darcy velocity (q) through the model lithologies or layers is expressed in m/year =

$$= K(i) = K \left(\frac{H_1 - H_2}{l_1 - l_2} \right)$$

Where,

K = vertical hydraulic conductivity (laboratory measured)

i = vertical gradient

$H_1 - H_2$ = difference in hydraulic head between the DB water level and the uppermost aquifer potentiometric surface

$l_1 - l_2$ = distance in direction of flow

Thus:

K = Geomean of Clay with Sand hydraulic conductivity value (data provided in Attachment 1) = Total 2.15×10^{-8} cm/s

H_1 = head at the bottom of DB = 579 ft

H_2 = Average water level elevation from monitoring wells (data provided in Attachment 2) = 575.16¹ ft

l_1 = Bottom of ash pond = 574 ft

l_2 = Average elevation of well screen midpoints = 449.88¹ ft

q = **Darcy velocity in m/year (= cm/s * 315360) = 2.03×10^{-4} m/year**

¹ Value is an average taken from all monitoring wells

4. TRAVEL TIME SOLUTION

Travel time (T) through the model lithology is expressed in years =

$$T = t / \left(\frac{K * i}{n} \right)$$

Where:

t = minimum model thickness

K = vertical hydraulic conductivity (laboratory measured)

i = vertical gradient

n = effective porosity

Thus:

t = Minimum model thickness per EVS model = 35.36 m

K = Hydraulic conductivity = 2.15×10^{-8} cm/s

i = Calculated using variables in Section 3 = 0.03

n = Average of porosity data from Clay with Sand layer, converted to effective porosity using Sara (1994) = 0.34

T = **Travel time in years (= s / 31536000) = 59,105 years**

Note: Time travel is not an input to Pollute model. It has been calculated to provide time estimate for the travel of water molecule from the bottom of DB to top of uppermost aquifer.

Attachment 1

Location ID	Layer	Elevation (ft)	Vertical Hydraulic Conductivity, k_v (cm/s)		Vertical Hydraulic Conductivity, k_v (cm/s)		
			DDW	Site Water	Clay	Clay with Sand	Dike
B1-ST-3 (36-38)	Clay	555.8	2.20E-08		2.20E-08		
	Clay	555.8	2.60E-09		2.60E-09		
B2-ST-2 (7-9)	Dike	584.0	2.10E-08				2.10E-08
	Dike	584.0	1.90E-08				1.90E-08
B2-ST-7 (97-99)	Clay with Sand	494.0	3.30E-08			3.30E-08	
	Clay with Sand	494.0	2.00E-08			2.00E-08	
B3-ST-1 (1-3)	Dike	590.0	9.50E-09				9.50E-09
B4-ST-4 (67-69)	Clay with Sand	518.0	2.80E-08			2.80E-08	
	Clay with Sand	518.0	1.80E-08			1.80E-08	
B5-ST-2 (27-29)	Clay	563.3	3.40E-08		3.40E-08		
	Clay	563.3	2.30E-08		2.30E-08		
B6-ST-4 (47-49)	Clay	541.3	2.50E-08		2.50E-08		
	Clay	541.3	1.80E-08		1.80E-08		
B6-ST-7 (97-99)	Clay with Sand	491.3	2.40E-08			2.40E-08	
	Clay with Sand	491.3	1.20E-08			1.20E-08	
B1-ST-1 (7-9)	Dike	584.8		8.20E-09			8.20E-09
B2-ST-1 (1-3)	Dike	590.0		1.20E-08			1.20E-08
B2-ST-4 (47-49)	Clay	544.0		2.20E-08	2.20E-08		
B3-ST-5 (77-79)	Clay with Sand	514.0		1.90E-08		1.90E-08	
B4-ST-3 (47-49)	Clay	538.0		2.80E-08	2.80E-08		
B5-ST-5 (87-89)	Clay with Sand	503.3		1.50E-08		1.50E-08	
MW-16-01	Clay with Sand	537.2	2.90E-08			2.90E-08	
MW-16-05	Clay with Sand	537.3	2.70E-08			2.70E-08	
MW-16-07	Clay	538.9	2.90E-08		2.90E-08		
MW-16-02	Sand	491.7					
MW-16-03	Sand	453.7					
MW-16-06	Sand	452.5					
MW-16-08	Sand	453.8					
MW-16-09	Sand	449.9					
MW-16-10	Sand	441.8					
MW-16-11A	Sand	450.0					
SB-16-01	Clay	537.7	2.10E-08		2.10E-08		
Statistical Parameter					Clay	Clay with Sand	Dike
Mean					2.25E-08	2.25E-08	1.39E-08
GeoMean					1.94E-08	2.15E-08	1.30E-08
Maximum					3.40E-08	3.30E-08	2.10E-08
Minimum					2.60E-09	1.20E-08	8.20E-09
Count					10	10	5
Standard Deviation					8.37E-09	6.75E-09	5.74E-09

Attachment 2

Table 1

Summary of Groundwater Elevation Data – March and September 2020
 Belle River Power Plant Diversion Basin – RCRA CCR Monitoring Program
 China Township, Michigan

Well ID	MW-16-05		MW-16-06		MW-16-07		MW-16-08		MW-16-10		MW-16-11A	
Date Installed	3/4/2016		3/11/2016		3/9/2016		3/10/2016		6/6/2016		5/12/2017	
TOC Elevation	590.82		593.21		592.58		591.88		592.26		591.66	
Geologic Unit of Screened Interval	Clayey Silt/Shale Interface		Silt/Shale Interface		Silt/Shale Interface		Silt/Shale Interface		Gravelly Silt and Silty Clay		Silt and Silty Clay	
Screened Interval Elevation	449.3 to 444.3		455.0 to 450.0		456.9 to 451.9		456.3 to 451.3		444.3 to 439.3		452.5 to 447.5	
Unit	ft BTOC	ft	ft BTOC	ft	ft BTOC	ft	ft BTOC	ft	ft BTOC	ft	ft BTOC	ft
Measurement Date	Depth to Water	GW Elevation	Depth to Water	GW Elevation	Depth to Water	GW Elevation	Depth to Water	GW Elevation	Depth to Water	GW Elevation	Depth to Water	GW Elevation
03/17/2020	16.76	574.06	17.50	575.71	16.62	575.96	15.57	576.31	17.74	574.52	16.81	574.85
09/14/2020	16.85	573.97	17.60	575.61	16.71	575.87	15.60	576.28	17.83	574.43	16.88	574.78

Notes:

Elevations are reported in feet relative to the North American Vertical Datum of 1988.

ft BTOC - feet Below top of casing

Well ID	MW-16-05	MW-16-06	MW-16-07	MW-16-08	MW-16-10	MW-16-11A
Screen Mid Point Elevation, I_2 (ft)	446.8	452.5	454.4	453.8	441.8	450
Aquifer Water Level, H_2 (ft)	574.0	575.6	575.9	576.3	574.4	574.8
Total Head Difference, $H_1 - H_2$ (ft)	5.03	3.4	3.1	2.7	4.6	4.22
Flow Distance, $I_1 - I_2$ (ft)	127.2	121.5	119.6	120.2	132.2	124
Gradient, i	0.04	0.03	0.03	0.02	0.03	0.03

Pond Water Elevation, H_1 (ft)	579
Elevation of Pond Outflow, I_1 (ft)	574

Average Gradient	0.03
------------------	------

POLLUTE Model Inputs

Basin	Layer	Darcy Velocity (m/year)	Darcy Velocity for Sensitivity (m/year)	Thickness (m)	Max Thickness (m)	Min Thickness (m)	Sublayers	Kv (cm/s)	CoHD	CoHD +25%	CoHD -25%	Effective Porosity	Eff. Porosity Max	Eff. Porosity Min	Dist. Coeff.	Dry Density (kg/m ³)
DB	Clay	2.03E-04	4.07E-04	11.13	12.13	10.70	20	1.94E-08	0.019	0.02375	0.01425	0.37	0.45	0.28	0	1509.084
	Clay with Sand	2.03E-04	4.07E-04	25.66	26.82	24.66	50	2.15E-08	0.019	0.02375	0.01425	0.34	0.45	0.20	0	1509.084

Notes:

1. Kv = vertical hydraulic conductivity as determined by the analysis of field and laboratory data summarized in Table M-1
2. Analysis of vertical hydraulic conductivity includes data from long term tests updated on 8/20/2021
3. Kv of Clay with Sand selected for the calculation of the Darcy velocity as the higher and thus more conservative value of the two layers; POLLUTE only allows one input for Darcy velocity
4. CoHD = Coefficient of Hydrodynamic Dispersion
5. Effective Porosity determined by multiplying estimated porosity from field and lab data by 0.81, based on data provided by Sara, 1994

Model Thickness

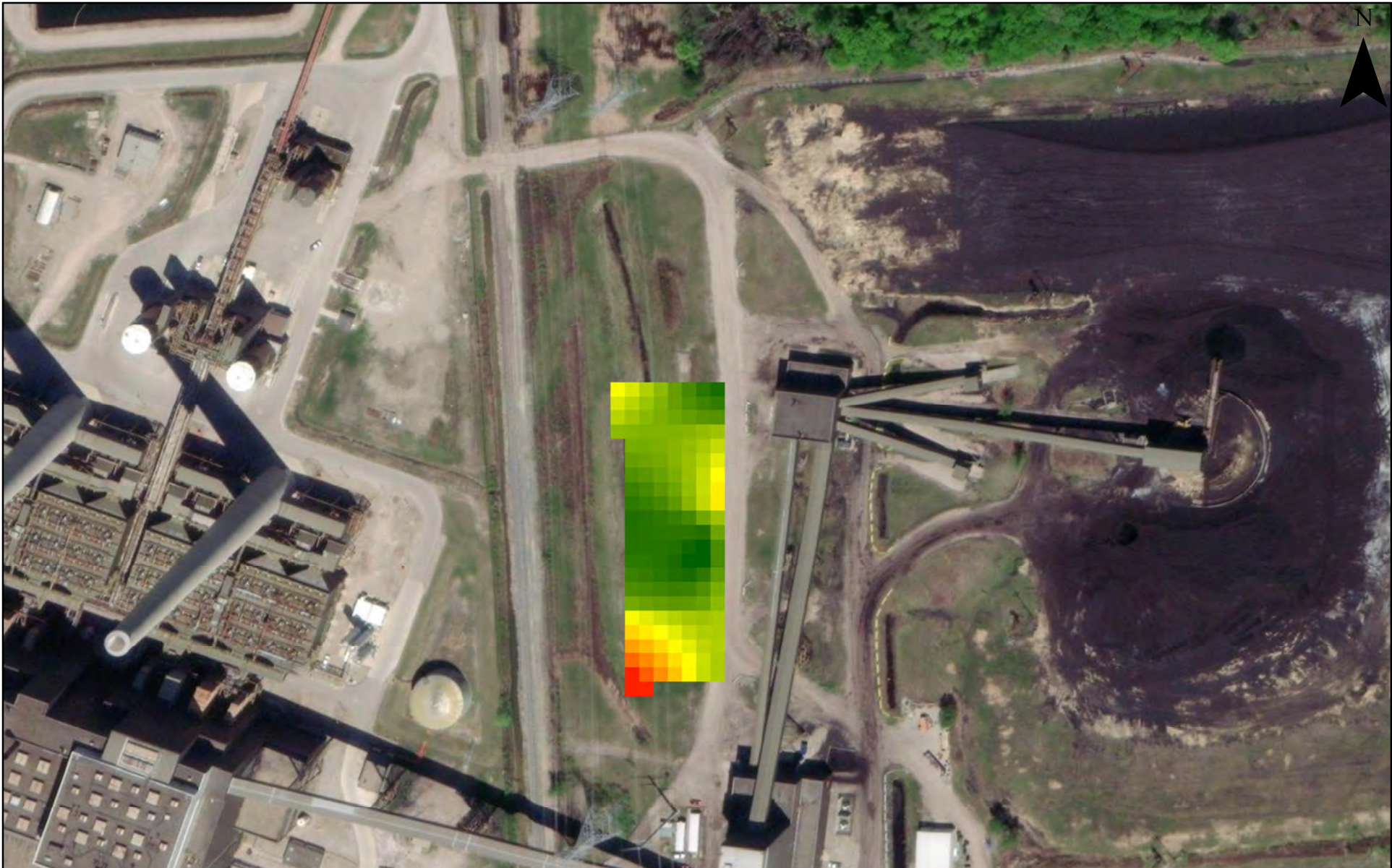

DB Clay Thickness (ft)

Value

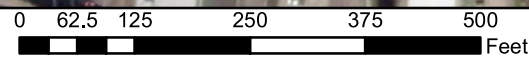
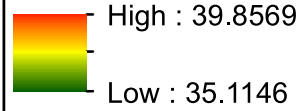

Diversion Basin Clay Thickness		Figure M-1
		
10/13/2021	Chicago, IL	

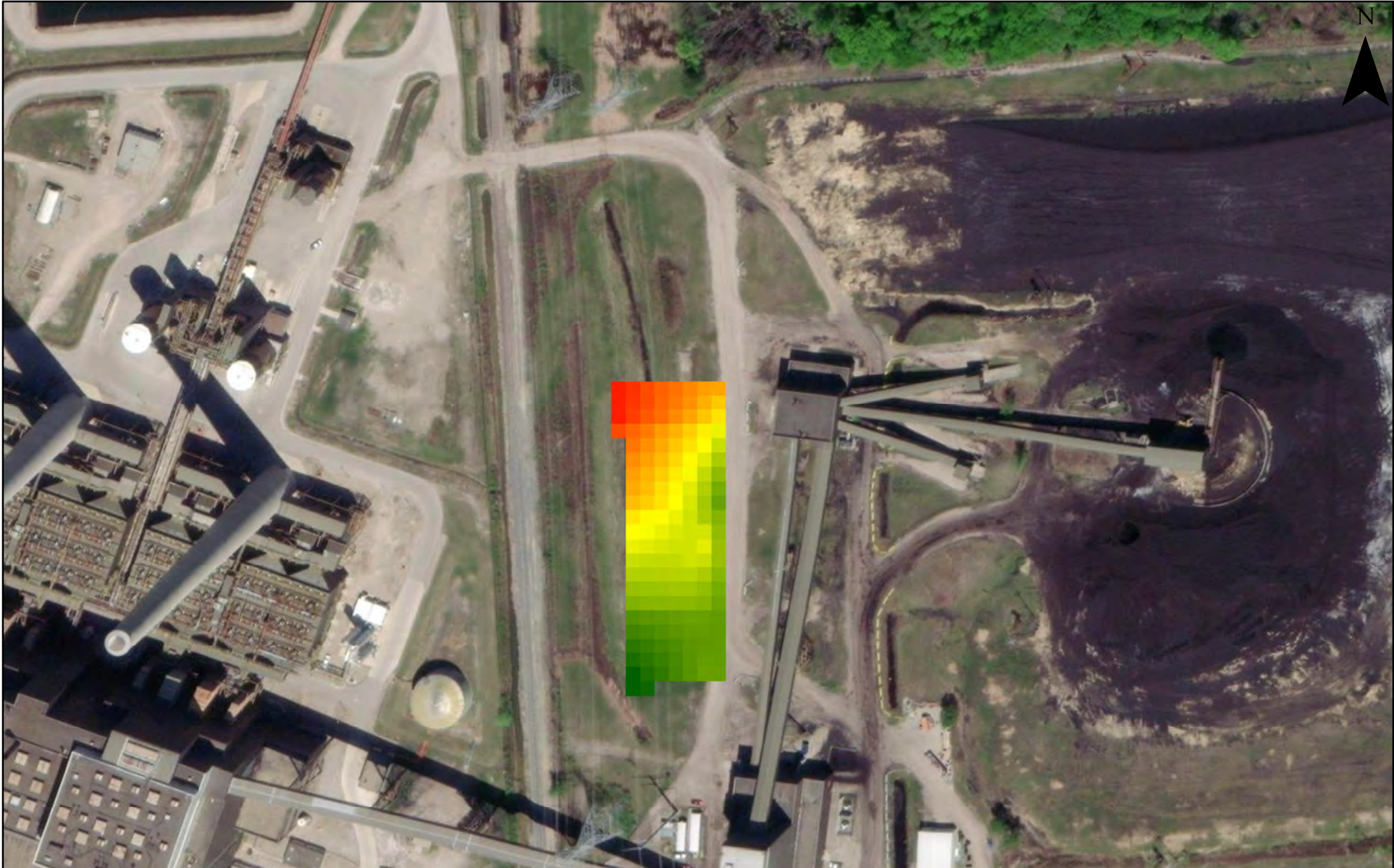

DB Clay with Sand Thickness (ft)

Value

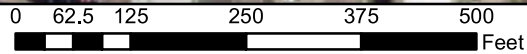
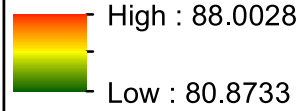

**Diversion Basin
Clay with Sand Thickness**



10/13/2021

Chicago, IL

**Figure
M-2**



Model Interval Thickness

Value

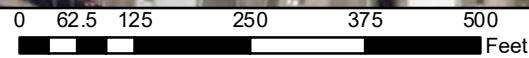
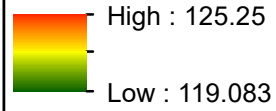

**Diversion Basin
Model Interval Thickness**



11/11/2021 | Chicago, IL

**Figure
M-3**

Reference Material

 **CRC Press**
Taylor & Francis Group
A CHAPMAN & HALL BOOK

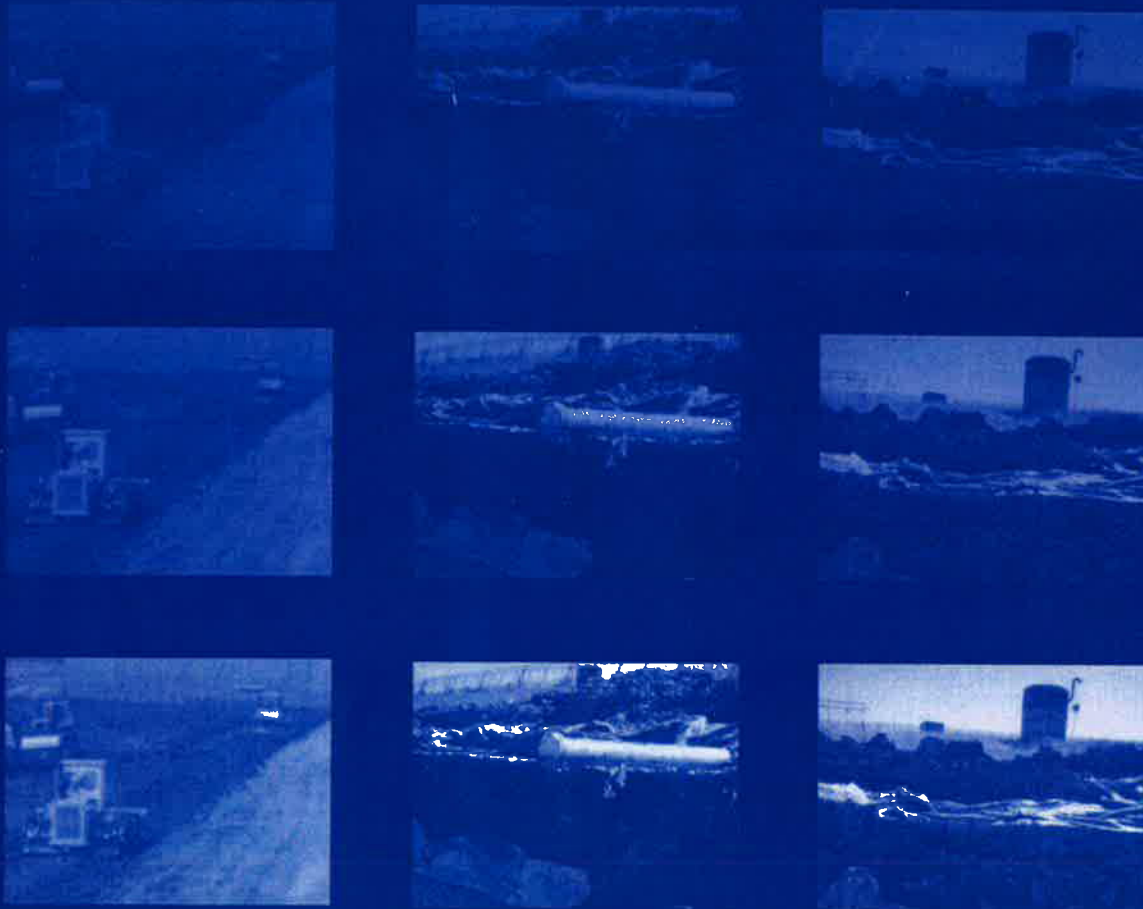

BARRIER SYSTEMS FOR WASTE DISPOSAL FACILITIES

2ND EDITION

R. Kerry Rowe, Robert M. Quigley,
Richard W.I. Brachman & John R. Booker

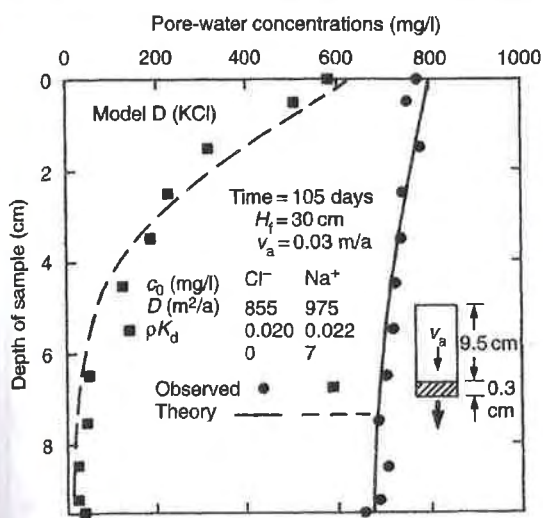

Figure 8.10 Chloride and potassium concentration versus depth in sample for model D (modified from Rowe et al., 1988).

variation in concentration with depth in the soil at the end of each test. The consistency of results demonstrates the power of the analytical model (program POLLUTE) and provides some con-

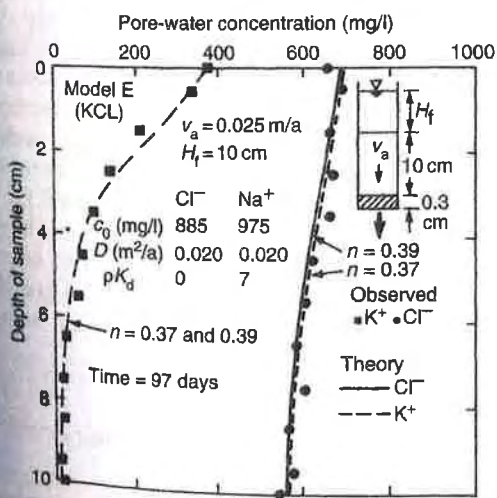

Figure 8.11 Chloride and potassium concentration versus depth in sample for model E (modified from Rowe et al., 1988).

fidence in the parameters D and ρK_d for the clay and source fluids examined.

To provide an indication of parameter variation that might be expected for a given soil, a number of tests were duplicated. The diffusion coefficient, D , for chloride was deduced for each model and ranged between 0.018 and 0.02 m²/a with an average value of 0.019 m²/a. This small variation in D does not appear to be related to small differences in Darcy velocity, nor does it appear to be particularly related to the nature of the associated cation (see Table 8.3). Rather, the variability from 0.018 to 0.02 m²/a is seen as an indication of the level of repeatability that may be achieved for this type of test.

The application of an effective stress to the soil sample adopted in these tests is not an essential part of the proposed technique for determining the parameters D and K_d . Tests performed for the particular combination of clay and permeants considered herein gave similar results both with and without the application of the effective stress. However, for some combinations of clay and permeant, shrinkage of the clay may occur in the absence of a confining stress and this can give quite misleading results (e.g., see Quigley and Fernandez, 1989). For these clays, and for GCLs (see Chapter 12), tests should be performed at an effective stress similar to that anticipated in the field.

8.3.2 Pure diffusion tests

In many cases, it is not necessary to perform an advection-diffusion test. Under these circumstances, a simple diffusion test can be performed for boundary conditions shown in Figure 8.2. In this test, the soil sample is placed in a Plexiglass cylinder by trimming the sample to a size marginally greater than the specimen and then pressing the specimen into the cylinder, using a cutting shoe attached to the cylinder, to perform the final trim. This procedure is found to work well for many clays. However, it does not work well for clays with a significant stone content because the

SITE ASSESSMENT and REMEDIATION Handbook **Second Edition**

Martin N. Sara



 **LEWIS PUBLISHERS**

Table 5-9 Porosity, Residual Saturation and Effective Porosity of Common Soils

Texture Class	Sample Size	Total	Residual	Effective
		Porosity (ϕ) cm ³ /cm ³	Saturation (ϕ_r) cm ³ /cm ³	Porosity (ϕ_c) cm ³ /cm ³
Sand	762	0.437 (0.374: 0.500)	0.020 (0.001: 0.039)	0.417 (0.354: 0.480)
Loamy Sand	338	0.437 (0.368: 0.506)	0.035 (0.003: 0.067)	0.401 (0.329: 0.473)
Sandy Loam	666	0.453 (0.351: 0.555)	0.041 (0.0: 0.106)	0.412 (0.283: 0.541)
Loam	383	0.463 (0.375: 0.551)	0.027 (0.0: 0.074)	0.434 (0.334: 0.534)
Silt Loam	1206	0.501 (0.420: 0.582)	0.015 (0.0: 0.058)	0.486 (0.394: 0.578)
Sandy Clay Loam	498	0.398 (0.332: 0.464)	0.068 (0.0: 0.137)	0.330 (0.235: 0.425)
Clay Loam	366	0.464 (0.409: 0.519)	0.076 (0.0: 0.174)	0.390 (0.279: 0.501)
Silty Clay Loam	689	0.471 (0.428: 0.524)	0.040 (0.0: 0.118)	0.432 (0.347: 0.517)
Sandy Clay	45	0.430 (0.370: 0.490)	0.109 (0.0: 0.205)	0.321 (0.207: 0.435)
Silty Clay	127	0.479 (0.425: 0.533)	0.056 (0.0: 0.136)	0.423 (0.334: 0.512)
Clay	291	0.475 (0.427: 0.523)	0.090 (0.0: 0.195)	0.385 (0.269: 0.501)

First line is the mean value

Second line is + one standard deviation about the mean

Adapted from: Rawls, W.J., D.C. Brakensiek, K.E. Saxton, 1982

The ratio of effective porosity to total porosity is 0.81 for Clay, and 0.88 for Silty Clay. Use 0.81 to be conservative.

**APPENDIX N – FATE AND TRANSPORT
MODEL OUTPUTS**

POLLUTEv7

Version 7.13

Copyright (c) 2007.

GAEA Technologies Ltd., R.K. Rowe and J.R. Booker

DB Baseline

THE DARCY VELOCITY (Flux) THROUGH THE LAYERS $V_a = 0.000203$ m/year

Layer Properties

Layer	Thickness	Number of Sublayers	Coefficient of Hydrodynamic Dispersion	Matrix Porosity	Distribution Coefficient	Dry Density
Clay	11.12 m	20	0.019 m ² /a	0.37	0 m ³ /kg	1510 kg/m ³
Clay with Sand	25.66 m	50	0.019 m ² /a	0.34	0 m ³ /kg	1510 kg/m ³

Boundary Conditions

Constant Concentration

Source Concentration = 1 mg/L

Infinite Thickness Bottom Boundary

Laplace Transform Parameters

TAU = 7 N = 20 SIG = 0 RNU = 2

Calculated Concentrations at Selected Times and Depths

Time year	Depth m	Concentration mg/L
5	0.000E+00	1.000E+00
	5.560E-01	2.037E-01
	1.112E+00	1.091E-02
	1.668E+00	1.331E-04
	2.224E+00	3.467E-07

2.780E+00	1.878E-10
3.336E+00	1.005E-13
3.892E+00	5.956E-15
4.448E+00	2.947E-16
5.004E+00	9.449E-18
5.560E+00	1.904E-19
6.116E+00	2.329E-21
6.672E+00	1.657E-23
7.228E+00	6.570E-26
7.784E+00	1.471E-28
8.340E+00	5.331E-31
8.896E+00	1.130E-32
9.452E+00	2.457E-34
1.001E+01	4.021E-36
1.056E+01	4.849E-38
1.112E+01	4.414E-40
1.163E+01	4.115E-42
1.215E+01	2.886E-44
1.266E+01	1.729E-46
1.317E+01	1.611E-48
1.369E+01	3.150E-50
1.420E+01	0.000E+00
1.471E+01	0.000E+00
1.523E+01	0.000E+00
1.574E+01	0.000E+00
1.625E+01	0.000E+00
1.677E+01	0.000E+00
1.728E+01	0.000E+00
1.779E+01	0.000E+00
1.830E+01	0.000E+00
1.882E+01	0.000E+00
1.933E+01	0.000E+00
1.984E+01	0.000E+00
2.036E+01	0.000E+00
2.087E+01	0.000E+00
2.138E+01	0.000E+00
2.190E+01	0.000E+00
2.241E+01	0.000E+00
2.292E+01	0.000E+00
2.344E+01	0.000E+00
2.395E+01	0.000E+00
2.446E+01	0.000E+00
2.498E+01	0.000E+00
2.549E+01	0.000E+00
2.600E+01	0.000E+00
2.652E+01	0.000E+00
2.703E+01	0.000E+00
2.754E+01	0.000E+00
2.806E+01	0.000E+00
2.857E+01	0.000E+00
2.908E+01	0.000E+00
2.960E+01	0.000E+00
3.011E+01	0.000E+00
3.062E+01	0.000E+00
3.113E+01	0.000E+00
3.165E+01	0.000E+00
3.216E+01	0.000E+00

	3.267E+01	0.000E+00
	3.319E+01	0.000E+00
	3.370E+01	0.000E+00
	3.421E+01	0.000E+00
	3.473E+01	0.000E+00
	3.524E+01	0.000E+00
	3.575E+01	0.000E+00
	3.627E+01	0.000E+00
	3.678E+01	0.000E+00
10	0.000E+00	1.000E+00
	5.560E-01	3.700E-01
	1.112E+00	7.240E-02
	1.668E+00	6.979E-03
	2.224E+00	3.189E-04
	2.780E+00	6.756E-06
	3.336E+00	6.551E-08
	3.892E+00	2.891E-10
	4.448E+00	7.541E-13
	5.004E+00	3.374E-14
	5.560E+00	4.993E-15
	6.116E+00	6.111E-16
	6.672E+00	6.039E-17
	7.228E+00	4.770E-18
	7.784E+00	2.978E-19
	8.340E+00	1.451E-20
	8.896E+00	5.443E-22
	9.452E+00	1.547E-23
	1.001E+01	3.277E-25
	1.056E+01	5.130E-27
	1.112E+01	6.604E-29
	1.163E+01	1.536E-30
	1.215E+01	9.625E-32
	1.266E+01	8.577E-33
	1.317E+01	7.168E-34
	1.369E+01	5.323E-35
	1.420E+01	3.484E-36
	1.471E+01	2.002E-37
	1.523E+01	1.004E-38
	1.574E+01	4.381E-40
	1.625E+01	1.654E-41
	1.677E+01	5.396E-43
	1.728E+01	1.540E-44
	1.779E+01	4.101E-46
	1.830E+01	1.269E-47
	1.882E+01	6.022E-49
	1.933E+01	3.898E-50
	1.984E+01	0.000E+00
	2.036E+01	0.000E+00
	2.087E+01	0.000E+00
	2.138E+01	0.000E+00
	2.190E+01	0.000E+00
	2.241E+01	0.000E+00
	2.292E+01	0.000E+00
	2.344E+01	0.000E+00
	2.395E+01	0.000E+00
	2.446E+01	0.000E+00

	2.498E+01 2.549E+01 2.600E+01 2.652E+01 2.703E+01 2.754E+01 2.806E+01 2.857E+01 2.908E+01 2.960E+01 3.011E+01 3.062E+01 3.113E+01 3.165E+01 3.216E+01 3.267E+01 3.319E+01 3.370E+01 3.421E+01 3.473E+01 3.524E+01 3.575E+01 3.627E+01 3.678E+01	0.000E+00 0.000E+00
15	0.000E+00 5.560E-01 1.112E+00 1.668E+00 2.224E+00 2.780E+00 3.336E+00 3.892E+00 4.448E+00 5.004E+00 5.560E+00 6.116E+00 6.672E+00 7.228E+00 7.784E+00 8.340E+00 8.896E+00 9.452E+00 1.001E+01 1.056E+01 1.112E+01 1.163E+01 1.215E+01 1.266E+01 1.317E+01 1.369E+01 1.420E+01 1.471E+01 1.523E+01 1.574E+01 1.625E+01 1.677E+01	1.000E+00 4.652E-01 1.431E-01 2.781E-02 3.327E-03 2.407E-04 1.042E-05 2.682E-07 4.082E-09 3.709E-11 3.339E-13 3.550E-14 7.575E-15 1.435E-15 2.363E-16 3.365E-17 4.119E-18 4.309E-19 3.825E-20 2.861E-21 1.862E-22 1.219E-23 6.752E-25 3.146E-26 1.242E-27 4.465E-29 2.066E-30 1.929E-31 2.619E-32 3.607E-33 4.641E-34 5.507E-35

	9.452E+00	5.974E-17
	1.001E+01	1.015E-17
	1.056E+01	1.538E-18
	1.112E+01	2.150E-19
	1.163E+01	3.018E-20
	1.215E+01	3.793E-21
	1.266E+01	4.251E-22
	1.317E+01	4.231E-23
	1.369E+01	3.723E-24
	1.420E+01	2.882E-25
	1.471E+01	1.960E-26
	1.523E+01	1.179E-27
	1.574E+01	6.610E-29
	1.625E+01	4.258E-30
	1.677E+01	4.525E-31
	1.728E+01	7.420E-32
	1.779E+01	1.352E-32
	1.830E+01	2.396E-33
	1.882E+01	4.020E-34
	1.933E+01	6.345E-35
	1.984E+01	9.404E-36
	2.036E+01	1.307E-36
	2.087E+01	1.699E-37
	2.138E+01	2.065E-38
	2.190E+01	2.340E-39
	2.241E+01	2.470E-40
	2.292E+01	2.425E-41
	2.344E+01	2.212E-42
	2.395E+01	1.879E-43
	2.446E+01	1.500E-44
	2.498E+01	1.155E-45
	2.549E+01	9.196E-47
	2.600E+01	8.513E-48
	2.652E+01	9.956E-49
	2.703E+01	1.392E-49
	2.754E+01	2.081E-50
	2.806E+01	0.000E+00
	2.857E+01	0.000E+00
	2.908E+01	0.000E+00
	2.960E+01	0.000E+00
	3.011E+01	0.000E+00
	3.062E+01	0.000E+00
	3.113E+01	0.000E+00
	3.165E+01	0.000E+00
	3.216E+01	0.000E+00
	3.267E+01	0.000E+00
	3.319E+01	0.000E+00
	3.370E+01	0.000E+00
	3.421E+01	0.000E+00
	3.473E+01	0.000E+00
	3.524E+01	0.000E+00
	3.575E+01	0.000E+00
	3.627E+01	0.000E+00
	3.678E+01	0.000E+00
25	0.000E+00	1.000E+00
	5.560E-01	5.729E-01

1.112E+00
1.668E+00
2.224E+00
2.780E+00
3.336E+00
3.892E+00
4.448E+00
5.004E+00
5.560E+00
6.116E+00
6.672E+00
7.228E+00
7.784E+00
8.340E+00
8.896E+00
9.452E+00
1.001E+01
1.056E+01
1.112E+01
1.163E+01
1.215E+01
1.266E+01
1.317E+01
1.369E+01
1.420E+01
1.471E+01
1.523E+01
1.574E+01
1.625E+01
1.677E+01
1.728E+01
1.779E+01
1.830E+01
1.882E+01
1.933E+01
1.984E+01
2.036E+01
2.087E+01
2.138E+01
2.190E+01
2.241E+01
2.292E+01
2.344E+01
2.395E+01
2.446E+01
2.498E+01
2.549E+01
2.600E+01
2.652E+01
2.703E+01
2.754E+01
2.806E+01
2.857E+01
2.908E+01
2.960E+01
3.011E+01
3.062E+01

2.580E-01
8.913E-02
2.324E-02
4.519E-03
6.506E-04
6.898E-05
5.363E-06
3.049E-07
1.265E-08
3.831E-10
8.758E-12
2.658E-13
4.643E-14
1.416E-14
4.118E-15
1.103E-15
2.717E-16
6.142E-17
1.319E-17
2.833E-18
5.612E-19
1.023E-19
1.709E-20
2.613E-21
3.643E-22
4.617E-23
5.301E-24
5.499E-25
5.141E-26
4.340E-27
3.367E-28
2.590E-29
2.459E-30
3.638E-31
7.360E-32
1.607E-32
3.443E-33
7.069E-34
1.383E-34
2.575E-35
4.556E-36
7.651E-37
1.218E-37
1.836E-38
2.618E-39
3.526E-40
4.482E-41
5.372E-42
6.077E-43
6.509E-44
6.675E-45
6.741E-46
7.118E-47
8.587E-48
1.252E-48
2.124E-49
3.859E-50

	3.113E+01	0.000E+00
	3.165E+01	0.000E+00
	3.216E+01	0.000E+00
	3.267E+01	0.000E+00
	3.319E+01	0.000E+00
	3.370E+01	0.000E+00
	3.421E+01	0.000E+00
	3.473E+01	0.000E+00
	3.524E+01	0.000E+00
	3.575E+01	0.000E+00
	3.627E+01	0.000E+00
	3.678E+01	0.000E+00
30	0.000E+00	1.000E+00
	5.560E-01	6.074E-01
	1.112E+00	3.024E-01
	1.668E+00	1.211E-01
	2.224E+00	3.847E-02
	2.780E+00	9.599E-03
	3.336E+00	1.869E-03
	3.892E+00	2.826E-04
	4.448E+00	3.306E-05
	5.004E+00	2.985E-06
	5.560E+00	2.075E-07
	6.116E+00	1.109E-08
	6.672E+00	4.560E-10
	7.228E+00	1.474E-11
	7.784E+00	5.124E-13
	8.340E+00	7.000E-14
	8.896E+00	2.285E-14
	9.452E+00	7.625E-15
	1.001E+01	2.386E-15
	1.056E+01	6.986E-16
	1.112E+01	1.974E-16
	1.163E+01	5.564E-17
	1.215E+01	1.472E-17
	1.266E+01	3.645E-18
	1.317E+01	8.441E-19
	1.369E+01	1.824E-19
	1.420E+01	3.672E-20
	1.471E+01	6.868E-21
	1.523E+01	1.191E-21
	1.574E+01	1.911E-22
	1.625E+01	2.829E-23
	1.677E+01	3.855E-24
	1.728E+01	4.824E-25
	1.779E+01	5.537E-26
	1.830E+01	5.835E-27
	1.882E+01	5.711E-28
	1.933E+01	5.434E-29
	1.984E+01	5.762E-30
	2.036E+01	8.459E-31
	2.087E+01	1.766E-31
	2.138E+01	4.314E-32
	2.190E+01	1.076E-32
	2.241E+01	2.615E-33
	2.292E+01	6.129E-34

	2.344E+01 2.395E+01 2.446E+01 2.498E+01 2.549E+01 2.600E+01 2.652E+01 2.703E+01 2.754E+01 2.806E+01 2.857E+01 2.908E+01 2.960E+01 3.011E+01 3.062E+01 3.113E+01 3.165E+01 3.216E+01 3.267E+01 3.319E+01 3.370E+01 3.421E+01 3.473E+01 3.524E+01 3.575E+01 3.627E+01 3.678E+01	1.379E-34 2.978E-35 6.163E-36 1.221E-36 2.316E-37 4.197E-38 7.265E-39 1.200E-39 1.889E-40 2.833E-41 4.046E-42 5.506E-43 7.163E-44 8.983E-45 1.108E-45 1.399E-46 1.933E-47 3.100E-48 5.784E-49 1.187E-49 2.521E-50 0.000E+00 0.000E+00 0.000E+00 0.000E+00 0.000E+00 0.000E+00
35	0.000E+00 5.560E-01 1.112E+00 1.668E+00 2.224E+00 2.780E+00 3.336E+00 3.892E+00 4.448E+00 5.004E+00 5.560E+00 6.116E+00 6.672E+00 7.228E+00 7.784E+00 8.340E+00 8.896E+00 9.452E+00 1.001E+01 1.056E+01 1.112E+01 1.163E+01 1.215E+01 1.266E+01 1.317E+01 1.369E+01 1.420E+01 1.471E+01 1.523E+01	1.000E+00 6.348E-01 3.403E-01 1.517E-01 5.555E-02 1.658E-02 4.008E-03 7.813E-04 1.224E-04 1.538E-05 1.547E-06 1.243E-07 7.968E-09 4.082E-10 1.702E-11 7.245E-13 9.112E-14 3.054E-14 1.121E-14 3.931E-15 1.344E-15 4.576E-16 1.478E-16 4.524E-17 1.311E-17 3.590E-18 9.281E-19 2.262E-19 5.186E-20

	1.574E+01 1.625E+01 1.677E+01 1.728E+01 1.779E+01 1.830E+01 1.882E+01 1.933E+01 1.984E+01 2.036E+01 2.087E+01 2.138E+01 2.190E+01 2.241E+01 2.292E+01 2.344E+01 2.395E+01 2.446E+01 2.498E+01 2.549E+01 2.600E+01 2.652E+01 2.703E+01 2.754E+01 2.806E+01 2.857E+01 2.908E+01 2.960E+01 3.011E+01 3.062E+01 3.113E+01 3.165E+01 3.216E+01 3.267E+01 3.319E+01 3.370E+01 3.421E+01 3.473E+01 3.524E+01 3.575E+01 3.627E+01 3.678E+01	1.117E-20 2.257E-21 4.268E-22 7.542E-23 1.242E-23 1.905E-24 2.713E-25 3.588E-26 4.414E-27 5.109E-28 5.789E-29 7.168E-30 1.158E-30 2.579E-31 6.848E-32 1.897E-32 5.189E-33 1.379E-33 3.545E-34 8.797E-35 2.107E-35 4.863E-36 1.082E-36 2.316E-37 4.771E-38 9.449E-39 1.798E-39 3.283E-40 5.752E-41 9.665E-42 1.558E-42 2.411E-43 3.598E-44 5.226E-45 7.536E-46 1.120E-46 1.812E-47 3.340E-48 7.017E-49 1.608E-49 3.823E-50 0.000E+00
40	0.000E+00 5.560E-01 1.112E+00 1.668E+00 2.224E+00 2.780E+00 3.336E+00 3.892E+00 4.448E+00 5.004E+00 5.560E+00 6.116E+00 6.672E+00 7.228E+00	1.000E+00 6.572E-01 3.730E-01 1.804E-01 7.356E-02 2.513E-02 7.148E-03 1.687E-03 3.292E-04 5.302E-05 7.032E-06 7.670E-07 6.873E-08 5.056E-09

7.784E+00	3.058E-10
8.340E+00	1.549E-11
8.896E+00	8.040E-13
9.452E+00	1.054E-13
1.001E+01	3.628E-14
1.056E+01	1.434E-14
1.112E+01	5.636E-15
1.163E+01	2.204E-15
1.215E+01	8.241E-16
1.266E+01	2.945E-16
1.317E+01	1.005E-16
1.369E+01	3.270E-17
1.420E+01	1.014E-17
1.471E+01	2.992E-18
1.523E+01	8.391E-19
1.574E+01	2.235E-19
1.625E+01	5.643E-20
1.677E+01	1.349E-20
1.728E+01	3.050E-21
1.779E+01	6.511E-22
1.830E+01	1.310E-22
1.882E+01	2.480E-23
1.933E+01	4.413E-24
1.984E+01	7.366E-25
2.036E+01	1.152E-25
2.087E+01	1.689E-26
2.138E+01	2.330E-27
2.190E+01	3.067E-28
2.241E+01	4.023E-29
2.292E+01	5.849E-30
2.344E+01	1.092E-30
2.395E+01	2.694E-31
2.446E+01	7.770E-32
2.498E+01	2.338E-32
2.549E+01	6.985E-33
2.600E+01	2.038E-33
2.652E+01	5.777E-34
2.703E+01	1.589E-34
2.754E+01	4.236E-35
2.806E+01	1.094E-35
2.857E+01	2.737E-36
2.908E+01	6.623E-37
2.960E+01	1.550E-37
3.011E+01	3.507E-38
3.062E+01	7.664E-39
3.113E+01	1.617E-39
3.165E+01	3.291E-40
3.216E+01	6.460E-41
3.267E+01	1.222E-41
3.319E+01	2.230E-42
3.370E+01	3.926E-43
3.421E+01	6.687E-44
3.473E+01	1.108E-44
3.524E+01	1.811E-45
3.575E+01	2.989E-46
3.627E+01	5.181E-47
3.678E+01	9.874E-48

45

0.000E+00	1.000E+00
5.560E-01	6.761E-01
1.112E+00	4.015E-01
1.668E+00	2.070E-01
2.224E+00	9.189E-02
2.780E+00	3.488E-02
3.336E+00	1.127E-02
3.892E+00	3.086E-03
4.448E+00	7.146E-04
5.004E+00	1.396E-04
5.560E+00	2.297E-05
6.116E+00	3.179E-06
6.672E+00	3.696E-07
7.228E+00	3.608E-08
7.784E+00	2.955E-09
8.340E+00	2.035E-10
8.896E+00	1.205E-11
9.452E+00	7.520E-13
1.001E+01	1.107E-13
1.056E+01	3.994E-14
1.112E+01	1.718E-14
1.163E+01	7.460E-15
1.215E+01	3.121E-15
1.266E+01	1.255E-15
1.317E+01	4.851E-16
1.369E+01	1.800E-16
1.420E+01	6.405E-17
1.471E+01	2.185E-17
1.523E+01	7.135E-18
1.574E+01	2.230E-18
1.625E+01	6.658E-19
1.677E+01	1.898E-19
1.728E+01	5.161E-20
1.779E+01	1.337E-20
1.830E+01	3.294E-21
1.882E+01	7.712E-22
1.933E+01	1.714E-22
1.984E+01	3.608E-23
2.036E+01	7.190E-24
2.087E+01	1.354E-24
2.138E+01	2.409E-25
2.190E+01	4.043E-26
2.241E+01	6.414E-27
2.292E+01	9.679E-28
2.344E+01	1.418E-28
2.395E+01	2.131E-29
2.446E+01	3.665E-30
2.498E+01	8.075E-31
2.549E+01	2.246E-31
2.600E+01	7.029E-32
2.652E+01	2.268E-32
2.703E+01	7.262E-33
2.754E+01	2.277E-33
2.806E+01	6.959E-34
2.857E+01	2.071E-34
2.908E+01	5.995E-35

	2.960E+01 3.011E+01 3.062E+01 3.113E+01 3.165E+01 3.216E+01 3.267E+01 3.319E+01 3.370E+01 3.421E+01 3.473E+01 3.524E+01 3.575E+01 3.627E+01 3.678E+01	1.688E-35 4.617E-36 1.227E-36 3.166E-37 7.928E-38 1.925E-38 4.534E-39 1.034E-39 2.286E-40 4.891E-41 1.013E-41 2.031E-42 3.944E-43 7.439E-44 1.369E-44
50	0.000E+00 5.560E-01 1.112E+00 1.668E+00 2.224E+00 2.780E+00 3.336E+00 3.892E+00 4.448E+00 5.004E+00 5.560E+00 6.116E+00 6.672E+00 7.228E+00 7.784E+00 8.340E+00 8.896E+00 9.452E+00 1.001E+01 1.056E+01 1.112E+01 1.163E+01 1.215E+01 1.266E+01 1.317E+01 1.369E+01 1.420E+01 1.471E+01 1.523E+01 1.574E+01 1.625E+01 1.677E+01 1.728E+01 1.779E+01 1.830E+01 1.882E+01 1.933E+01 1.984E+01 2.036E+01 2.087E+01 2.138E+01	1.000E+00 6.922E-01 4.266E-01 2.317E-01 1.101E-01 4.550E-02 1.628E-02 5.023E-03 1.334E-03 3.043E-04 5.950E-05 9.962E-06 1.427E-06 1.746E-07 1.826E-08 1.630E-09 1.247E-10 8.412E-12 6.270E-13 1.087E-13 4.267E-14 1.980E-14 9.036E-15 3.989E-15 1.701E-15 6.995E-16 2.774E-16 1.060E-16 3.900E-17 1.381E-17 4.698E-18 1.536E-18 4.819E-19 1.450E-19 4.179E-20 1.153E-20 3.040E-21 7.656E-22 1.839E-22 4.210E-23 9.173E-24

	2.190E+01 2.241E+01 2.292E+01 2.344E+01 2.395E+01 2.446E+01 2.498E+01 2.549E+01 2.600E+01 2.652E+01 2.703E+01 2.754E+01 2.806E+01 2.857E+01 2.908E+01 2.960E+01 3.011E+01 3.062E+01 3.113E+01 3.165E+01 3.216E+01 3.267E+01 3.319E+01 3.370E+01 3.421E+01 3.473E+01 3.524E+01 3.575E+01 3.627E+01 3.678E+01	1.900E-24 3.737E-25 6.979E-26 1.238E-26 2.093E-27 3.412E-28 5.533E-29 9.586E-30 1.978E-30 5.170E-31 1.613E-31 5.437E-32 1.861E-32 6.301E-33 2.092E-33 6.787E-34 2.149E-34 6.640E-35 2.000E-35 5.873E-36 1.680E-36 4.681E-37 1.270E-37 3.351E-38 8.601E-39 2.147E-39 5.206E-40 1.227E-40 2.807E-41 6.237E-42
55	0.000E+00 5.560E-01 1.112E+00 1.668E+00 2.224E+00 2.780E+00 3.336E+00 3.892E+00 4.448E+00 5.004E+00 5.560E+00 6.116E+00 6.672E+00 7.228E+00 7.784E+00 8.340E+00 8.896E+00 9.452E+00 1.001E+01 1.056E+01 1.112E+01 1.163E+01 1.215E+01 1.266E+01 1.317E+01 1.369E+01	1.000E+00 7.061E-01 4.489E-01 2.546E-01 1.280E-01 5.671E-02 2.206E-02 7.508E-03 2.231E-03 5.777E-04 1.301E-04 2.546E-05 4.325E-06 6.372E-07 8.136E-08 9.000E-09 8.628E-10 7.203E-11 5.449E-12 4.873E-13 1.044E-13 4.492E-14 2.160E-14 1.026E-14 4.735E-15 2.116E-15

1.420E+01	9.159E-16
1.471E+01	3.835E-16
1.523E+01	1.553E-16
1.574E+01	6.075E-17
1.625E+01	2.296E-17
1.677E+01	8.374E-18
1.728E+01	2.946E-18
1.779E+01	9.988E-19
1.830E+01	3.262E-19
1.882E+01	1.025E-19
1.933E+01	3.096E-20
1.984E+01	8.985E-21
2.036E+01	2.503E-21
2.087E+01	6.684E-22
2.138E+01	1.710E-22
2.190E+01	4.187E-23
2.241E+01	9.800E-24
2.292E+01	2.191E-24
2.344E+01	4.674E-25
2.395E+01	9.510E-26
2.446E+01	1.846E-26
2.498E+01	3.427E-27
2.549E+01	6.130E-28
2.600E+01	1.078E-28
2.652E+01	1.957E-29
2.703E+01	3.996E-30
2.754E+01	9.996E-31
2.806E+01	3.055E-31
2.857E+01	1.050E-31
2.908E+01	3.764E-32
2.960E+01	1.352E-32
3.011E+01	4.794E-33
3.062E+01	1.667E-33
3.113E+01	5.676E-34
3.165E+01	1.890E-34
3.216E+01	6.155E-35
3.267E+01	1.958E-35
3.319E+01	6.088E-36
3.370E+01	1.848E-36
3.421E+01	5.478E-37
3.473E+01	1.584E-37
3.524E+01	4.471E-38
3.575E+01	1.230E-38
3.627E+01	3.300E-39
3.678E+01	8.626E-40

NOTICE

Although this program has been tested and experience would indicate that it is accurate within the limits given by the assumptions of the theory used, we make no warranty as to workability of this software or any other licensed material. No warranties either expressed or implied (including warranties of fitness) shall apply. No responsibility is assumed for any errors, mistakes or misrepresentations that may occur from the use of this computer program. The user accepts full responsibility for assessing the validity and applicability of the results obtained with this program for any specific case.

POLLUTEv7

Version 7.13

Copyright (c) 2007.
GAEA Technologies Ltd., R.K. Rowe and J.R. Booker

DB_ExtendedRun

THE DARCY VELOCITY (Flux) THROUGH THE LAYERS $V_a = 0.000203$ m/year

Layer Properties

Layer	Thickness	Number of Sublayers	Coefficient of Hydrodynamic Dispersion	Matrix Porosity	Distribution Coefficient	Dry Density
Clay	11.12 m	20	0.019 m ² /a	0.37	0 m ³ /kg	1510 kg/m ³
Clay with Sand	25.66 m	50	0.019 m ² /a	0.34	0 m ³ /kg	1510 kg/m ³

Boundary Conditions

Constant Concentration

Source Concentration = 1 mg/L

Infinite Thickness Bottom Boundary

Laplace Transform Parameters

TAU = 7 N = 20 SIG = 0 RNU = 2

Calculated Concentrations at Selected Times and Depths

Time year	Depth m	Concentration mg/L
5	0.000E+00	1.000E+00
	5.560E-01	2.037E-01
	1.112E+00	1.091E-02
	1.668E+00	1.331E-04
	2.224E+00	3.467E-07

2.780E+00	1.878E-10
3.336E+00	1.005E-13
3.892E+00	5.956E-15
4.448E+00	2.947E-16
5.004E+00	9.449E-18
5.560E+00	1.904E-19
6.116E+00	2.329E-21
6.672E+00	1.657E-23
7.228E+00	6.570E-26
7.784E+00	1.471E-28
8.340E+00	5.331E-31
8.896E+00	1.130E-32
9.452E+00	2.457E-34
1.001E+01	4.021E-36
1.056E+01	4.849E-38
1.112E+01	4.414E-40
1.163E+01	4.115E-42
1.215E+01	2.886E-44
1.266E+01	1.729E-46
1.317E+01	1.611E-48
1.369E+01	3.150E-50
1.420E+01	0.000E+00
1.471E+01	0.000E+00
1.523E+01	0.000E+00
1.574E+01	0.000E+00
1.625E+01	0.000E+00
1.677E+01	0.000E+00
1.728E+01	0.000E+00
1.779E+01	0.000E+00
1.830E+01	0.000E+00
1.882E+01	0.000E+00
1.933E+01	0.000E+00
1.984E+01	0.000E+00
2.036E+01	0.000E+00
2.087E+01	0.000E+00
2.138E+01	0.000E+00
2.190E+01	0.000E+00
2.241E+01	0.000E+00
2.292E+01	0.000E+00
2.344E+01	0.000E+00
2.395E+01	0.000E+00
2.446E+01	0.000E+00
2.498E+01	0.000E+00
2.549E+01	0.000E+00
2.600E+01	0.000E+00
2.652E+01	0.000E+00
2.703E+01	0.000E+00
2.754E+01	0.000E+00
2.806E+01	0.000E+00
2.857E+01	0.000E+00
2.908E+01	0.000E+00
2.960E+01	0.000E+00
3.011E+01	0.000E+00
3.062E+01	0.000E+00
3.113E+01	0.000E+00
3.165E+01	0.000E+00
3.216E+01	0.000E+00

	3.267E+01	0.000E+00
	3.319E+01	0.000E+00
	3.370E+01	0.000E+00
	3.421E+01	0.000E+00
	3.473E+01	0.000E+00
	3.524E+01	0.000E+00
	3.575E+01	0.000E+00
	3.627E+01	0.000E+00
	3.678E+01	0.000E+00
15	0.000E+00	1.000E+00
	5.560E-01	4.652E-01
	1.112E+00	1.431E-01
	1.668E+00	2.781E-02
	2.224E+00	3.327E-03
	2.780E+00	2.407E-04
	3.336E+00	1.042E-05
	3.892E+00	2.682E-07
	4.448E+00	4.082E-09
	5.004E+00	3.709E-11
	5.560E+00	3.339E-13
	6.116E+00	3.550E-14
	6.672E+00	7.575E-15
	7.228E+00	1.435E-15
	7.784E+00	2.363E-16
	8.340E+00	3.365E-17
	8.896E+00	4.119E-18
	9.452E+00	4.309E-19
	1.001E+01	3.825E-20
	1.056E+01	2.861E-21
	1.112E+01	1.862E-22
	1.163E+01	1.219E-23
	1.215E+01	6.752E-25
	1.266E+01	3.146E-26
	1.317E+01	1.242E-27
	1.369E+01	4.465E-29
	1.420E+01	2.066E-30
	1.471E+01	1.929E-31
	1.523E+01	2.619E-32
	1.574E+01	3.607E-33
	1.625E+01	4.641E-34
	1.677E+01	5.507E-35
	1.728E+01	6.009E-36
	1.779E+01	6.013E-37
	1.830E+01	5.504E-38
	1.882E+01	4.597E-39
	1.933E+01	3.494E-40
	1.984E+01	2.411E-41
	2.036E+01	1.510E-42
	2.087E+01	8.602E-44
	2.138E+01	4.545E-45
	2.190E+01	2.370E-46
	2.241E+01	1.414E-47
	2.292E+01	1.132E-48
	2.344E+01	1.162E-49
	2.395E+01	1.295E-50
	2.446E+01	0.000E+00

	2.498E+01 2.549E+01 2.600E+01 2.652E+01 2.703E+01 2.754E+01 2.806E+01 2.857E+01 2.908E+01 2.960E+01 3.011E+01 3.062E+01 3.113E+01 3.165E+01 3.216E+01 3.267E+01 3.319E+01 3.370E+01 3.421E+01 3.473E+01 3.524E+01 3.575E+01 3.627E+01 3.678E+01	0.000E+00 0.000E+00
25	0.000E+00 5.560E-01 1.112E+00 1.668E+00 2.224E+00 2.780E+00 3.336E+00 3.892E+00 4.448E+00 5.004E+00 5.560E+00 6.116E+00 6.672E+00 7.228E+00 7.784E+00 8.340E+00 8.896E+00 9.452E+00 1.001E+01 1.056E+01 1.112E+01 1.163E+01 1.215E+01 1.266E+01 1.317E+01 1.369E+01 1.420E+01 1.471E+01 1.523E+01 1.574E+01 1.625E+01 1.677E+01	1.000E+00 5.729E-01 2.580E-01 8.913E-02 2.324E-02 4.519E-03 6.506E-04 6.898E-05 5.363E-06 3.049E-07 1.265E-08 3.831E-10 8.758E-12 2.658E-13 4.643E-14 1.416E-14 4.118E-15 1.103E-15 2.717E-16 6.142E-17 1.319E-17 2.833E-18 5.612E-19 1.023E-19 1.709E-20 2.613E-21 3.643E-22 4.617E-23 5.301E-24 5.499E-25 5.141E-26 4.340E-27

	1.728E+01 1.779E+01 1.830E+01 1.882E+01 1.933E+01 1.984E+01 2.036E+01 2.087E+01 2.138E+01 2.190E+01 2.241E+01 2.292E+01 2.344E+01 2.395E+01 2.446E+01 2.498E+01 2.549E+01 2.600E+01 2.652E+01 2.703E+01 2.754E+01 2.806E+01 2.857E+01 2.908E+01 2.960E+01 3.011E+01 3.062E+01 3.113E+01 3.165E+01 3.216E+01 3.267E+01 3.319E+01 3.370E+01 3.421E+01 3.473E+01 3.524E+01 3.575E+01 3.627E+01 3.678E+01	3.367E-28 2.590E-29 2.459E-30 3.638E-31 7.360E-32 1.607E-32 3.443E-33 7.069E-34 1.383E-34 2.575E-35 4.556E-36 7.651E-37 1.218E-37 1.836E-38 2.618E-39 3.526E-40 4.482E-41 5.372E-42 6.077E-43 6.509E-44 6.675E-45 6.741E-46 7.118E-47 8.587E-48 1.252E-48 2.124E-49 3.859E-50 0.000E+00
35	0.000E+00 5.560E-01 1.112E+00 1.668E+00 2.224E+00 2.780E+00 3.336E+00 3.892E+00 4.448E+00 5.004E+00 5.560E+00 6.116E+00 6.672E+00 7.228E+00 7.784E+00 8.340E+00 8.896E+00	1.000E+00 6.348E-01 3.403E-01 1.517E-01 5.555E-02 1.658E-02 4.008E-03 7.813E-04 1.224E-04 1.538E-05 1.547E-06 1.243E-07 7.968E-09 4.082E-10 1.702E-11 7.245E-13 9.112E-14

9.452E+00	3.054E-14
1.001E+01	1.121E-14
1.056E+01	3.931E-15
1.112E+01	1.344E-15
1.163E+01	4.576E-16
1.215E+01	1.478E-16
1.266E+01	4.524E-17
1.317E+01	1.311E-17
1.369E+01	3.590E-18
1.420E+01	9.281E-19
1.471E+01	2.262E-19
1.523E+01	5.186E-20
1.574E+01	1.117E-20
1.625E+01	2.257E-21
1.677E+01	4.268E-22
1.728E+01	7.542E-23
1.779E+01	1.242E-23
1.830E+01	1.905E-24
1.882E+01	2.713E-25
1.933E+01	3.588E-26
1.984E+01	4.414E-27
2.036E+01	5.109E-28
2.087E+01	5.789E-29
2.138E+01	7.168E-30
2.190E+01	1.158E-30
2.241E+01	2.579E-31
2.292E+01	6.848E-32
2.344E+01	1.897E-32
2.395E+01	5.189E-33
2.446E+01	1.379E-33
2.498E+01	3.545E-34
2.549E+01	8.797E-35
2.600E+01	2.107E-35
2.652E+01	4.863E-36
2.703E+01	1.082E-36
2.754E+01	2.316E-37
2.806E+01	4.771E-38
2.857E+01	9.449E-39
2.908E+01	1.798E-39
2.960E+01	3.283E-40
3.011E+01	5.752E-41
3.062E+01	9.665E-42
3.113E+01	1.558E-42
3.165E+01	2.411E-43
3.216E+01	3.598E-44
3.267E+01	5.226E-45
3.319E+01	7.536E-46
3.370E+01	1.120E-46
3.421E+01	1.812E-47
3.473E+01	3.340E-48
3.524E+01	7.017E-49
3.575E+01	1.608E-49
3.627E+01	3.823E-50
3.678E+01	0.000E+00

1.112E+00	4.015E-01
1.668E+00	2.070E-01
2.224E+00	9.189E-02
2.780E+00	3.488E-02
3.336E+00	1.127E-02
3.892E+00	3.086E-03
4.448E+00	7.146E-04
5.004E+00	1.396E-04
5.560E+00	2.297E-05
6.116E+00	3.179E-06
6.672E+00	3.696E-07
7.228E+00	3.608E-08
7.784E+00	2.955E-09
8.340E+00	2.035E-10
8.896E+00	1.205E-11
9.452E+00	7.520E-13
1.001E+01	1.107E-13
1.056E+01	3.994E-14
1.112E+01	1.718E-14
1.163E+01	7.460E-15
1.215E+01	3.121E-15
1.266E+01	1.255E-15
1.317E+01	4.851E-16
1.369E+01	1.800E-16
1.420E+01	6.405E-17
1.471E+01	2.185E-17
1.523E+01	7.135E-18
1.574E+01	2.230E-18
1.625E+01	6.658E-19
1.677E+01	1.898E-19
1.728E+01	5.161E-20
1.779E+01	1.337E-20
1.830E+01	3.294E-21
1.882E+01	7.712E-22
1.933E+01	1.714E-22
1.984E+01	3.608E-23
2.036E+01	7.190E-24
2.087E+01	1.354E-24
2.138E+01	2.409E-25
2.190E+01	4.043E-26
2.241E+01	6.414E-27
2.292E+01	9.679E-28
2.344E+01	1.418E-28
2.395E+01	2.131E-29
2.446E+01	3.665E-30
2.498E+01	8.075E-31
2.549E+01	2.246E-31
2.600E+01	7.029E-32
2.652E+01	2.268E-32
2.703E+01	7.262E-33
2.754E+01	2.277E-33
2.806E+01	6.959E-34
2.857E+01	2.071E-34
2.908E+01	5.995E-35
2.960E+01	1.688E-35
3.011E+01	4.617E-36
3.062E+01	1.227E-36

	3.113E+01 3.165E+01 3.216E+01 3.267E+01 3.319E+01 3.370E+01 3.421E+01 3.473E+01 3.524E+01 3.575E+01 3.627E+01 3.678E+01	3.166E-37 7.928E-38 1.925E-38 4.534E-39 1.034E-39 2.286E-40 4.891E-41 1.013E-41 2.031E-42 3.944E-43 7.439E-44 1.369E-44
55	0.000E+00 5.560E-01 1.112E+00 1.668E+00 2.224E+00 2.780E+00 3.336E+00 3.892E+00 4.448E+00 5.004E+00 5.560E+00 6.116E+00 6.672E+00 7.228E+00 7.784E+00 8.340E+00 8.896E+00 9.452E+00 1.001E+01 1.056E+01 1.112E+01 1.163E+01 1.215E+01 1.266E+01 1.317E+01 1.369E+01 1.420E+01 1.471E+01 1.523E+01 1.574E+01 1.625E+01 1.677E+01 1.728E+01 1.779E+01 1.830E+01 1.882E+01 1.933E+01 1.984E+01 2.036E+01 2.087E+01 2.138E+01 2.190E+01 2.241E+01 2.292E+01	1.000E+00 7.061E-01 4.489E-01 2.546E-01 1.280E-01 5.671E-02 2.206E-02 7.508E-03 2.231E-03 5.777E-04 1.301E-04 2.546E-05 4.325E-06 6.372E-07 8.136E-08 9.000E-09 8.628E-10 7.203E-11 5.449E-12 4.873E-13 1.044E-13 4.492E-14 2.160E-14 1.026E-14 4.735E-15 2.116E-15 9.159E-16 3.835E-16 1.553E-16 6.075E-17 2.296E-17 8.374E-18 2.946E-18 9.988E-19 3.262E-19 1.025E-19 3.096E-20 8.985E-21 2.503E-21 6.684E-22 1.710E-22 4.187E-23 9.800E-24 2.191E-24

	2.344E+01 2.395E+01 2.446E+01 2.498E+01 2.549E+01 2.600E+01 2.652E+01 2.703E+01 2.754E+01 2.806E+01 2.857E+01 2.908E+01 2.960E+01 3.011E+01 3.062E+01 3.113E+01 3.165E+01 3.216E+01 3.267E+01 3.319E+01 3.370E+01 3.421E+01 3.473E+01 3.524E+01 3.575E+01 3.627E+01 3.678E+01	4.674E-25 9.510E-26 1.846E-26 3.427E-27 6.130E-28 1.078E-28 1.957E-29 3.996E-30 9.996E-31 3.055E-31 1.050E-31 3.764E-32 1.352E-32 4.794E-33 1.667E-33 5.676E-34 1.890E-34 6.155E-35 1.958E-35 6.088E-36 1.848E-36 5.478E-37 1.584E-37 4.471E-38 1.230E-38 3.300E-39 8.626E-40
85	0.000E+00 5.560E-01 1.112E+00 1.668E+00 2.224E+00 2.780E+00 3.336E+00 3.892E+00 4.448E+00 5.004E+00 5.560E+00 6.116E+00 6.672E+00 7.228E+00 7.784E+00 8.340E+00 8.896E+00 9.452E+00 1.001E+01 1.056E+01 1.112E+01 1.163E+01 1.215E+01 1.266E+01 1.317E+01 1.369E+01 1.420E+01 1.471E+01 1.523E+01	1.000E+00 7.631E-01 5.447E-01 3.619E-01 2.229E-01 1.269E-01 6.654E-02 3.209E-02 1.421E-02 5.765E-03 2.142E-03 7.277E-04 2.260E-04 6.410E-05 1.659E-05 3.919E-06 8.442E-07 1.658E-07 2.967E-08 4.842E-09 7.497E-10 1.193E-10 1.781E-11 2.630E-12 4.669E-13 1.378E-13 6.441E-14 3.518E-14 1.958E-14

1.574E+01	1.075E-14
1.625E+01	5.796E-15
1.677E+01	3.060E-15
1.728E+01	1.583E-15
1.779E+01	8.013E-16
1.830E+01	3.971E-16
1.882E+01	1.926E-16
1.933E+01	9.136E-17
1.984E+01	4.238E-17
2.036E+01	1.922E-17
2.087E+01	8.518E-18
2.138E+01	3.687E-18
2.190E+01	1.559E-18
2.241E+01	6.432E-19
2.292E+01	2.590E-19
2.344E+01	1.017E-19
2.395E+01	3.892E-20
2.446E+01	1.452E-20
2.498E+01	5.274E-21
2.549E+01	1.865E-21
2.600E+01	6.418E-22
2.652E+01	2.148E-22
2.703E+01	6.987E-23
2.754E+01	2.208E-23
2.806E+01	6.775E-24
2.857E+01	2.018E-24
2.908E+01	5.829E-25
2.960E+01	1.633E-25
3.011E+01	4.439E-26
3.062E+01	1.171E-26
3.113E+01	3.002E-27
3.165E+01	7.523E-28
3.216E+01	1.862E-28
3.267E+01	4.649E-29
3.319E+01	1.217E-29
3.370E+01	3.519E-30
3.421E+01	1.168E-30
3.473E+01	4.429E-31
3.524E+01	1.837E-31
3.575E+01	7.970E-32
3.627E+01	3.507E-32
3.678E+01	1.541E-32

NOTICE

Although this program has been tested and experience would indicate that it is accurate within the limits given by the assumptions of the theory used, we make no warranty as to workability of this software or any other licensed material. No warranties either expressed or implied (including warranties of fitness) shall apply. No responsibility is assumed for any errors, mistakes or misrepresentations that may occur from the use of this computer program. The user accepts full responsibility for assessing the validity and applicability of the results obtained with this program for any specific case.

POLLUTEv7

Version 7.13

Copyright (c) 2007.

GAEA Technologies Ltd., R.K. Rowe and J.R. Booker

DB Darcy

THE DARCY VELOCITY (Flux) THROUGH THE LAYERS $V_a = 0.000407$ m/year

Layer Properties

Layer	Thickness	Number of Sublayers	Coefficient of Hydrodynamic Dispersion	Matrix Porosity	Distribution Coefficient	Dry Density
Clay	11.12 m	20	0.019 m ² /a	0.37	0 m ³ /kg	1510 kg/m ³
Clay with Sand	25.66 m	50	0.019 m ² /a	0.34	0 m ³ /kg	1510 kg/m ³

Boundary Conditions

Constant Concentration

Source Concentration = 1 mg/L

Infinite Thickness Bottom Boundary

Laplace Transform Parameters

TAU = 7 N = 20 SIG = 0 RNU = 2

Calculated Concentrations at Selected Times and Depths

Time year	Depth m	Concentration mg/L
5	0.000E+00	1.000E+00
	5.560E-01	2.054E-01
	1.112E+00	1.109E-02
	1.668E+00	1.363E-04
	2.224E+00	3.580E-07

2.780E+00	1.955E-10
3.336E+00	1.055E-13
3.892E+00	6.301E-15
4.448E+00	3.143E-16
5.004E+00	1.016E-17
5.560E+00	2.064E-19
6.116E+00	2.544E-21
6.672E+00	1.826E-23
7.228E+00	7.295E-26
7.784E+00	1.647E-28
8.340E+00	6.015E-31
8.896E+00	1.285E-32
9.452E+00	2.817E-34
1.001E+01	4.648E-36
1.056E+01	5.650E-38
1.112E+01	5.184E-40
1.163E+01	4.873E-42
1.215E+01	3.446E-44
1.266E+01	2.081E-46
1.317E+01	1.954E-48
1.369E+01	3.852E-50
1.420E+01	0.000E+00
1.471E+01	0.000E+00
1.523E+01	0.000E+00
1.574E+01	0.000E+00
1.625E+01	0.000E+00
1.677E+01	0.000E+00
1.728E+01	0.000E+00
1.779E+01	0.000E+00
1.830E+01	0.000E+00
1.882E+01	0.000E+00
1.933E+01	0.000E+00
1.984E+01	0.000E+00
2.036E+01	0.000E+00
2.087E+01	0.000E+00
2.138E+01	0.000E+00
2.190E+01	0.000E+00
2.241E+01	0.000E+00
2.292E+01	0.000E+00
2.344E+01	0.000E+00
2.395E+01	0.000E+00
2.446E+01	0.000E+00
2.498E+01	0.000E+00
2.549E+01	0.000E+00
2.600E+01	0.000E+00
2.652E+01	0.000E+00
2.703E+01	0.000E+00
2.754E+01	0.000E+00
2.806E+01	0.000E+00
2.857E+01	0.000E+00
2.908E+01	0.000E+00
2.960E+01	0.000E+00
3.011E+01	0.000E+00
3.062E+01	0.000E+00
3.113E+01	0.000E+00
3.165E+01	0.000E+00
3.216E+01	0.000E+00

	3.267E+01	0.000E+00
	3.319E+01	0.000E+00
	3.370E+01	0.000E+00
	3.421E+01	0.000E+00
	3.473E+01	0.000E+00
	3.524E+01	0.000E+00
	3.575E+01	0.000E+00
	3.627E+01	0.000E+00
	3.678E+01	0.000E+00
10	0.000E+00	1.000E+00
	5.560E-01	3.730E-01
	1.112E+00	7.357E-02
	1.668E+00	7.149E-03
	2.224E+00	3.293E-04
	2.780E+00	7.033E-06
	3.336E+00	6.875E-08
	3.892E+00	3.058E-10
	4.448E+00	8.042E-13
	5.004E+00	3.626E-14
	5.560E+00	5.410E-15
	6.116E+00	6.675E-16
	6.672E+00	6.649E-17
	7.228E+00	5.295E-18
	7.784E+00	3.333E-19
	8.340E+00	1.637E-20
	8.896E+00	6.191E-22
	9.452E+00	1.773E-23
	1.001E+01	3.788E-25
	1.056E+01	5.977E-27
	1.112E+01	7.757E-29
	1.163E+01	1.818E-30
	1.215E+01	1.149E-31
	1.266E+01	1.032E-32
	1.317E+01	8.694E-34
	1.369E+01	6.508E-35
	1.420E+01	4.295E-36
	1.471E+01	2.487E-37
	1.523E+01	1.258E-38
	1.574E+01	5.534E-40
	1.625E+01	2.106E-41
	1.677E+01	6.927E-43
	1.728E+01	1.992E-44
	1.779E+01	5.350E-46
	1.830E+01	1.669E-47
	1.882E+01	7.981E-49
	1.933E+01	5.208E-50
	1.984E+01	0.000E+00
	2.036E+01	0.000E+00
	2.087E+01	0.000E+00
	2.138E+01	0.000E+00
	2.190E+01	0.000E+00
	2.241E+01	0.000E+00
	2.292E+01	0.000E+00
	2.344E+01	0.000E+00
	2.395E+01	0.000E+00
	2.446E+01	0.000E+00

	2.498E+01 2.549E+01 2.600E+01 2.652E+01 2.703E+01 2.754E+01 2.806E+01 2.857E+01 2.908E+01 2.960E+01 3.011E+01 3.062E+01 3.113E+01 3.165E+01 3.216E+01 3.267E+01 3.319E+01 3.370E+01 3.421E+01 3.473E+01 3.524E+01 3.575E+01 3.627E+01 3.678E+01	0.000E+00 0.000E+00
15	0.000E+00 5.560E-01 1.112E+00 1.668E+00 2.224E+00 2.780E+00 3.336E+00 3.892E+00 4.448E+00 5.004E+00 5.560E+00 6.116E+00 6.672E+00 7.228E+00 7.784E+00 8.340E+00 8.896E+00 9.452E+00 1.001E+01 1.056E+01 1.112E+01 1.163E+01 1.215E+01 1.266E+01 1.317E+01 1.369E+01 1.420E+01 1.471E+01 1.523E+01 1.574E+01 1.625E+01 1.677E+01	1.000E+00 4.689E-01 1.454E-01 2.849E-02 3.435E-03 2.506E-04 1.094E-05 2.837E-07 4.353E-09 3.987E-11 3.618E-13 3.877E-14 8.340E-15 1.593E-15 2.644E-16 3.795E-17 4.683E-18 4.939E-19 4.420E-20 3.332E-21 2.187E-22 1.443E-23 8.059E-25 3.786E-26 1.506E-27 5.460E-29 2.546E-30 2.396E-31 3.280E-32 4.554E-33 5.906E-34 7.065E-35

	9.452E+00	6.846E-17
	1.001E+01	1.173E-17
	1.056E+01	1.791E-18
	1.112E+01	2.524E-19
	1.163E+01	3.572E-20
	1.215E+01	4.525E-21
	1.266E+01	5.114E-22
	1.317E+01	5.131E-23
	1.369E+01	4.551E-24
	1.420E+01	3.553E-25
	1.471E+01	2.436E-26
	1.523E+01	1.477E-27
	1.574E+01	8.347E-29
	1.625E+01	5.419E-30
	1.677E+01	5.804E-31
	1.728E+01	9.593E-32
	1.779E+01	1.762E-32
	1.830E+01	3.149E-33
	1.882E+01	5.325E-34
	1.933E+01	8.473E-35
	1.984E+01	1.266E-35
	2.036E+01	1.773E-36
	2.087E+01	2.325E-37
	2.138E+01	2.848E-38
	2.190E+01	3.255E-39
	2.241E+01	3.464E-40
	2.292E+01	3.427E-41
	2.344E+01	3.152E-42
	2.395E+01	2.700E-43
	2.446E+01	2.172E-44
	2.498E+01	1.686E-45
	2.549E+01	1.353E-46
	2.600E+01	1.263E-47
	2.652E+01	1.488E-48
	2.703E+01	2.098E-49
	2.754E+01	3.160E-50
	2.806E+01	0.000E+00
	2.857E+01	0.000E+00
	2.908E+01	0.000E+00
	2.960E+01	0.000E+00
	3.011E+01	0.000E+00
	3.062E+01	0.000E+00
	3.113E+01	0.000E+00
	3.165E+01	0.000E+00
	3.216E+01	0.000E+00
	3.267E+01	0.000E+00
	3.319E+01	0.000E+00
	3.370E+01	0.000E+00
	3.421E+01	0.000E+00
	3.473E+01	0.000E+00
	3.524E+01	0.000E+00
	3.575E+01	0.000E+00
	3.627E+01	0.000E+00
	3.678E+01	0.000E+00
25	0.000E+00	1.000E+00
	5.560E-01	5.775E-01

1.112E+00
1.668E+00
2.224E+00
2.780E+00
3.336E+00
3.892E+00
4.448E+00
5.004E+00
5.560E+00
6.116E+00
6.672E+00
7.228E+00
7.784E+00
8.340E+00
8.896E+00
9.452E+00
1.001E+01
1.056E+01
1.112E+01
1.163E+01
1.215E+01
1.266E+01
1.317E+01
1.369E+01
1.420E+01
1.471E+01
1.523E+01
1.574E+01
1.625E+01
1.677E+01
1.728E+01
1.779E+01
1.830E+01
1.882E+01
1.933E+01
1.984E+01
2.036E+01
2.087E+01
2.138E+01
2.190E+01
2.241E+01
2.292E+01
2.344E+01
2.395E+01
2.446E+01
2.498E+01
2.549E+01
2.600E+01
2.652E+01
2.703E+01
2.754E+01
2.806E+01
2.857E+01
2.908E+01
2.960E+01
3.011E+01
3.062E+01

2.622E-01
9.130E-02
2.399E-02
4.704E-03
6.827E-04
7.296E-05
5.719E-06
3.278E-07
1.371E-08
4.185E-10
9.645E-12
2.950E-13
5.192E-14
1.597E-14
4.680E-15
1.264E-15
3.138E-16
7.151E-17
1.548E-17
3.352E-18
6.695E-19
1.230E-19
2.072E-20
3.194E-21
4.489E-22
5.735E-23
6.639E-24
6.943E-25
6.544E-26
5.570E-27
4.356E-28
3.377E-29
3.231E-30
4.817E-31
9.825E-32
2.163E-32
4.671E-33
9.668E-34
1.907E-34
3.580E-35
6.384E-36
1.081E-36
1.735E-37
2.637E-38
3.790E-39
5.146E-40
6.594E-41
7.968E-42
9.086E-43
9.812E-44
1.014E-44
1.033E-45
1.099E-46
1.336E-47
1.964E-48
3.358E-49
6.150E-50

	3.113E+01	1.136E-50
	3.165E+01	0.000E+00
	3.216E+01	0.000E+00
	3.267E+01	0.000E+00
	3.319E+01	0.000E+00
	3.370E+01	0.000E+00
	3.421E+01	0.000E+00
	3.473E+01	0.000E+00
	3.524E+01	0.000E+00
	3.575E+01	0.000E+00
	3.627E+01	0.000E+00
	3.678E+01	0.000E+00
30	0.000E+00	1.000E+00
	5.560E-01	6.122E-01
	1.112E+00	3.073E-01
	1.668E+00	1.240E-01
	2.224E+00	3.972E-02
	2.780E+00	9.991E-03
	3.336E+00	1.961E-03
	3.892E+00	2.989E-04
	4.448E+00	3.525E-05
	5.004E+00	3.208E-06
	5.560E+00	2.248E-07
	6.116E+00	1.212E-08
	6.672E+00	5.022E-10
	7.228E+00	1.636E-11
	7.784E+00	5.732E-13
	8.340E+00	7.890E-14
	8.896E+00	2.597E-14
	9.452E+00	8.734E-15
	1.001E+01	2.756E-15
	1.056E+01	8.132E-16
	1.112E+01	2.316E-16
	1.163E+01	6.583E-17
	1.215E+01	1.755E-17
	1.266E+01	4.382E-18
	1.317E+01	1.023E-18
	1.369E+01	2.229E-19
	1.420E+01	4.523E-20
	1.471E+01	8.529E-21
	1.523E+01	1.491E-21
	1.574E+01	2.412E-22
	1.625E+01	3.600E-23
	1.677E+01	4.945E-24
	1.728E+01	6.239E-25
	1.779E+01	7.219E-26
	1.830E+01	7.670E-27
	1.882E+01	7.568E-28
	1.933E+01	7.259E-29
	1.984E+01	7.756E-30
	2.036E+01	1.148E-30
	2.087E+01	2.414E-31
	2.138E+01	5.945E-32
	2.190E+01	1.494E-32
	2.241E+01	3.663E-33
	2.292E+01	8.654E-34

	2.344E+01 2.395E+01 2.446E+01 2.498E+01 2.549E+01 2.600E+01 2.652E+01 2.703E+01 2.754E+01 2.806E+01 2.857E+01 2.908E+01 2.960E+01 3.011E+01 3.062E+01 3.113E+01 3.165E+01 3.216E+01 3.267E+01 3.319E+01 3.370E+01 3.421E+01 3.473E+01 3.524E+01 3.575E+01 3.627E+01 3.678E+01	1.964E-34 4.274E-35 8.917E-36 1.782E-36 3.405E-37 6.222E-38 1.086E-38 1.808E-39 2.869E-40 4.338E-41 6.246E-42 8.570E-43 1.124E-43 1.421E-44 1.766E-45 2.249E-46 3.131E-47 5.061E-48 9.517E-49 1.968E-49 4.215E-50 0.000E+00 0.000E+00 0.000E+00 0.000E+00 0.000E+00 0.000E+00
35	0.000E+00 5.560E-01 1.112E+00 1.668E+00 2.224E+00 2.780E+00 3.336E+00 3.892E+00 4.448E+00 5.004E+00 5.560E+00 6.116E+00 6.672E+00 7.228E+00 7.784E+00 8.340E+00 8.896E+00 9.452E+00 1.001E+01 1.056E+01 1.112E+01 1.163E+01 1.215E+01 1.266E+01 1.317E+01 1.369E+01 1.420E+01 1.471E+01 1.523E+01	1.000E+00 6.398E-01 3.458E-01 1.554E-01 5.735E-02 1.725E-02 4.205E-03 8.264E-04 1.305E-04 1.653E-05 1.676E-06 1.357E-07 8.775E-09 4.531E-10 1.904E-11 8.171E-13 1.035E-13 3.498E-14 1.294E-14 4.575E-15 1.577E-15 5.412E-16 1.762E-16 5.437E-17 1.588E-17 4.385E-18 1.143E-18 2.808E-19 6.491E-20

	1.574E+01 1.625E+01 1.677E+01 1.728E+01 1.779E+01 1.830E+01 1.882E+01 1.933E+01 1.984E+01 2.036E+01 2.087E+01 2.138E+01 2.190E+01 2.241E+01 2.292E+01 2.344E+01 2.395E+01 2.446E+01 2.498E+01 2.549E+01 2.600E+01 2.652E+01 2.703E+01 2.754E+01 2.806E+01 2.857E+01 2.908E+01 2.960E+01 3.011E+01 3.062E+01 3.113E+01 3.165E+01 3.216E+01 3.267E+01 3.319E+01 3.370E+01 3.421E+01 3.473E+01 3.524E+01 3.575E+01 3.627E+01 3.678E+01	1.410E-20 2.871E-21 5.474E-22 9.751E-23 1.620E-23 2.503E-24 3.595E-25 4.792E-26 5.943E-27 6.935E-28 7.922E-29 9.885E-30 1.609E-30 3.612E-31 9.666E-32 2.699E-32 7.443E-33 1.994E-33 5.168E-34 1.293E-34 3.121E-35 7.264E-36 1.629E-36 3.516E-37 7.303E-38 1.458E-38 2.796E-39 5.149E-40 9.095E-41 1.541E-41 2.503E-42 3.906E-43 5.877E-44 8.604E-45 1.251E-45 1.874E-46 3.055E-47 5.675E-48 1.202E-48 2.775E-49 6.651E-50 1.601E-50
40	0.000E+00 5.560E-01 1.112E+00 1.668E+00 2.224E+00 2.780E+00 3.336E+00 3.892E+00 4.448E+00 5.004E+00 5.560E+00 6.116E+00 6.672E+00 7.228E+00	1.000E+00 6.625E-01 3.790E-01 1.847E-01 7.595E-02 2.615E-02 7.500E-03 1.784E-03 3.510E-04 5.699E-05 7.619E-06 8.378E-07 7.569E-08 5.613E-09

7.784E+00	3.422E-10
8.340E+00	1.748E-11
8.896E+00	9.140E-13
9.452E+00	1.207E-13
1.001E+01	4.187E-14
1.056E+01	1.669E-14
1.112E+01	6.611E-15
1.163E+01	2.606E-15
1.215E+01	9.824E-16
1.266E+01	3.539E-16
1.317E+01	1.217E-16
1.369E+01	3.994E-17
1.420E+01	1.248E-17
1.471E+01	3.713E-18
1.523E+01	1.050E-18
1.574E+01	2.819E-19
1.625E+01	7.177E-20
1.677E+01	1.730E-20
1.728E+01	3.943E-21
1.779E+01	8.485E-22
1.830E+01	1.721E-22
1.882E+01	3.285E-23
1.933E+01	5.892E-24
1.984E+01	9.915E-25
2.036E+01	1.564E-25
2.087E+01	2.311E-26
2.138E+01	3.214E-27
2.190E+01	4.264E-28
2.241E+01	5.639E-29
2.292E+01	8.261E-30
2.344E+01	1.554E-30
2.395E+01	3.864E-31
2.446E+01	1.123E-31
2.498E+01	3.407E-32
2.549E+01	1.026E-32
2.600E+01	3.018E-33
2.652E+01	8.625E-34
2.703E+01	2.392E-34
2.754E+01	6.428E-35
2.806E+01	1.674E-35
2.857E+01	4.221E-36
2.908E+01	1.030E-36
2.960E+01	2.430E-37
3.011E+01	5.542E-38
3.062E+01	1.221E-38
3.113E+01	2.597E-39
3.165E+01	5.329E-40
3.216E+01	1.055E-40
3.267E+01	2.012E-41
3.319E+01	3.700E-42
3.370E+01	6.567E-43
3.421E+01	1.128E-43
3.473E+01	1.884E-44
3.524E+01	3.104E-45
3.575E+01	5.163E-46
3.627E+01	9.019E-47
3.678E+01	1.732E-47

45

0.000E+00	1.000E+00
5.560E-01	6.814E-01
1.112E+00	4.079E-01
1.668E+00	2.120E-01
2.224E+00	9.486E-02
2.780E+00	3.630E-02
3.336E+00	1.182E-02
3.892E+00	3.264E-03
4.448E+00	7.619E-04
5.004E+00	1.500E-04
5.560E+00	2.489E-05
6.116E+00	3.472E-06
6.672E+00	4.070E-07
7.228E+00	4.004E-08
7.784E+00	3.306E-09
8.340E+00	2.295E-10
8.896E+00	1.370E-11
9.452E+00	8.618E-13
1.001E+01	1.278E-13
1.056E+01	4.646E-14
1.112E+01	2.014E-14
1.163E+01	8.819E-15
1.215E+01	3.719E-15
1.266E+01	1.508E-15
1.317E+01	5.875E-16
1.369E+01	2.197E-16
1.420E+01	7.884E-17
1.471E+01	2.711E-17
1.523E+01	8.927E-18
1.574E+01	2.812E-18
1.625E+01	8.466E-19
1.677E+01	2.433E-19
1.728E+01	6.670E-20
1.779E+01	1.741E-20
1.830E+01	4.326E-21
1.882E+01	1.021E-21
1.933E+01	2.287E-22
1.984E+01	4.856E-23
2.036E+01	9.755E-24
2.087E+01	1.853E-24
2.138E+01	3.322E-25
2.190E+01	5.621E-26
2.241E+01	8.989E-27
2.292E+01	1.367E-27
2.344E+01	2.020E-28
2.395E+01	3.058E-29
2.446E+01	5.300E-30
2.498E+01	1.177E-30
2.549E+01	3.298E-31
2.600E+01	1.040E-31
2.652E+01	3.385E-32
2.703E+01	1.092E-32
2.754E+01	3.453E-33
2.806E+01	1.064E-33
2.857E+01	3.192E-34
2.908E+01	9.317E-35

	2.960E+01 3.011E+01 3.062E+01 3.113E+01 3.165E+01 3.216E+01 3.267E+01 3.319E+01 3.370E+01 3.421E+01 3.473E+01 3.524E+01 3.575E+01 3.627E+01 3.678E+01	2.644E-35 7.292E-36 1.954E-36 5.082E-37 1.283E-37 3.142E-38 7.458E-39 1.716E-39 3.822E-40 8.244E-41 1.721E-41 3.479E-42 6.812E-43 1.295E-43 2.403E-44
50	0.000E+00 5.560E-01 1.112E+00 1.668E+00 2.224E+00 2.780E+00 3.336E+00 3.892E+00 4.448E+00 5.004E+00 5.560E+00 6.116E+00 6.672E+00 7.228E+00 7.784E+00 8.340E+00 8.896E+00 9.452E+00 1.001E+01 1.056E+01 1.112E+01 1.163E+01 1.215E+01 1.266E+01 1.317E+01 1.369E+01 1.420E+01 1.471E+01 1.523E+01 1.574E+01 1.625E+01 1.677E+01 1.728E+01 1.779E+01 1.830E+01 1.882E+01 1.933E+01 1.984E+01 2.036E+01 2.087E+01 2.138E+01	1.000E+00 6.977E-01 4.334E-01 2.373E-01 1.137E-01 4.735E-02 1.707E-02 5.312E-03 1.422E-03 3.270E-04 6.446E-05 1.088E-05 1.571E-06 1.938E-07 2.043E-08 1.839E-09 1.418E-10 9.642E-12 7.243E-13 1.265E-13 5.003E-14 2.341E-14 1.077E-14 4.792E-15 2.059E-15 8.539E-16 3.414E-16 1.315E-16 4.878E-17 1.741E-17 5.972E-18 1.968E-18 6.226E-19 1.889E-19 5.487E-20 1.526E-20 4.057E-21 1.030E-21 2.495E-22 5.757E-23 1.265E-23

	2.190E+01 2.241E+01 2.292E+01 2.344E+01 2.395E+01 2.446E+01 2.498E+01 2.549E+01 2.600E+01 2.652E+01 2.703E+01 2.754E+01 2.806E+01 2.857E+01 2.908E+01 2.960E+01 3.011E+01 3.062E+01 3.113E+01 3.165E+01 3.216E+01 3.267E+01 3.319E+01 3.370E+01 3.421E+01 3.473E+01 3.524E+01 3.575E+01 3.627E+01 3.678E+01	2.640E-24 5.236E-25 9.858E-26 1.763E-26 3.004E-27 4.937E-28 8.071E-29 1.409E-29 2.929E-30 7.715E-31 2.426E-31 8.242E-32 2.844E-32 9.708E-33 3.249E-33 1.063E-33 3.393E-34 1.057E-34 3.210E-35 9.501E-36 2.740E-36 7.696E-37 2.104E-37 5.599E-38 1.449E-38 3.646E-39 8.914E-40 2.118E-40 4.885E-41 1.094E-41
55	0.000E+00 5.560E-01 1.112E+00 1.668E+00 2.224E+00 2.780E+00 3.336E+00 3.892E+00 4.448E+00 5.004E+00 5.560E+00 6.116E+00 6.672E+00 7.228E+00 7.784E+00 8.340E+00 8.896E+00 9.452E+00 1.001E+01 1.056E+01 1.112E+01 1.163E+01 1.215E+01 1.266E+01 1.317E+01 1.369E+01	1.000E+00 7.117E-01 4.561E-01 2.608E-01 1.321E-01 5.901E-02 2.314E-02 7.940E-03 2.379E-03 6.208E-04 1.410E-04 2.781E-05 4.762E-06 7.072E-07 9.103E-08 1.015E-08 9.810E-10 8.256E-11 6.296E-12 5.673E-13 1.224E-13 5.308E-14 2.573E-14 1.232E-14 5.732E-15 2.583E-15

1.420E+01	1.127E-15
1.471E+01	4.756E-16
1.523E+01	1.941E-16
1.574E+01	7.658E-17
1.625E+01	2.918E-17
1.677E+01	1.073E-17
1.728E+01	3.805E-18
1.779E+01	1.301E-18
1.830E+01	4.281E-19
1.882E+01	1.356E-19
1.933E+01	4.131E-20
1.984E+01	1.209E-20
2.036E+01	3.394E-21
2.087E+01	9.138E-22
2.138E+01	2.357E-22
2.190E+01	5.817E-23
2.241E+01	1.373E-23
2.292E+01	3.094E-24
2.344E+01	6.654E-25
2.395E+01	1.365E-25
2.446E+01	2.671E-26
2.498E+01	4.999E-27
2.549E+01	9.014E-28
2.600E+01	1.598E-28
2.652E+01	2.924E-29
2.703E+01	6.015E-30
2.754E+01	1.516E-30
2.806E+01	4.668E-31
2.857E+01	1.617E-31
2.908E+01	5.843E-32
2.960E+01	2.116E-32
3.011E+01	7.564E-33
3.062E+01	2.652E-33
3.113E+01	9.103E-34
3.165E+01	3.056E-34
3.216E+01	1.003E-34
3.267E+01	3.218E-35
3.319E+01	1.009E-35
3.370E+01	3.087E-36
3.421E+01	9.223E-37
3.473E+01	2.690E-37
3.524E+01	7.651E-38
3.575E+01	2.123E-38
3.627E+01	5.740E-39
3.678E+01	1.513E-39

NOTICE

Although this program has been tested and experience would indicate that it is accurate within the limits given by the assumptions of the theory used, we make no warranty as to workability of this software or any other licensed material. No warranties either expressed or implied (including warranties of fitness) shall apply. No responsibility is assumed for any errors, mistakes or misrepresentations that may occur from the use of this computer program. The user accepts full responsibility for assessing the validity and applicability of the results obtained with this program for any specific case.

POLLUTEv7

Version 7.13

Copyright (c) 2007.

GAEA Technologies Ltd., R.K. Rowe and J.R. Booker

DB CoHD High

THE DARCY VELOCITY (Flux) THROUGH THE LAYERS $V_a = 0.000203$ m/year

Layer Properties

Layer	Thickness	Number of Sublayers	Coefficient of Hydrodynamic Dispersion	Matrix Porosity	Distribution Coefficient	Dry Density
Clay	11.12 m	20	0.02375 m ² /a	0.37	0 m ³ /kg	1510 kg/m ³
Clay with Sand	25.66 m	50	0.02375 m ² /a	0.34	0 m ³ /kg	1510 kg/m ³

Boundary Conditions

Constant Concentration

Source Concentration = 1 mg/L

Infinite Thickness Bottom Boundary

Laplace Transform Parameters

TAU = 7 N = 20 SIG = 0 RNU = 2

Calculated Concentrations at Selected Times and Depths

Time year	Depth m	Concentration mg/L
5	0.000E+00	1.000E+00
	5.560E-01	2.556E-01
	1.112E+00	2.279E-02
	1.668E+00	6.322E-04
	2.224E+00	5.160E-06

2.780E+00	1.206E-08
3.336E+00	8.267E-12
3.892E+00	4.341E-14
4.448E+00	3.814E-15
5.004E+00	2.492E-16
5.560E+00	1.150E-17
6.116E+00	3.663E-19
6.672E+00	7.867E-21
7.228E+00	1.106E-22
7.784E+00	9.861E-25
8.340E+00	5.432E-27
8.896E+00	2.108E-29
9.452E+00	2.215E-31
1.001E+01	7.694E-33
1.056E+01	2.479E-34
1.112E+01	6.626E-36
1.163E+01	1.818E-37
1.215E+01	4.015E-39
1.266E+01	7.073E-41
1.317E+01	9.870E-43
1.369E+01	1.106E-44
1.420E+01	1.141E-46
1.471E+01	1.768E-48
1.523E+01	5.105E-50
1.574E+01	0.000E+00
1.625E+01	0.000E+00
1.677E+01	0.000E+00
1.728E+01	0.000E+00
1.779E+01	0.000E+00
1.830E+01	0.000E+00
1.882E+01	0.000E+00
1.933E+01	0.000E+00
1.984E+01	0.000E+00
2.036E+01	0.000E+00
2.087E+01	0.000E+00
2.138E+01	0.000E+00
2.190E+01	0.000E+00
2.241E+01	0.000E+00
2.292E+01	0.000E+00
2.344E+01	0.000E+00
2.395E+01	0.000E+00
2.446E+01	0.000E+00
2.498E+01	0.000E+00
2.549E+01	0.000E+00
2.600E+01	0.000E+00
2.652E+01	0.000E+00
2.703E+01	0.000E+00
2.754E+01	0.000E+00
2.806E+01	0.000E+00
2.857E+01	0.000E+00
2.908E+01	0.000E+00
2.960E+01	0.000E+00
3.011E+01	0.000E+00
3.062E+01	0.000E+00
3.113E+01	0.000E+00
3.165E+01	0.000E+00
3.216E+01	0.000E+00

	3.267E+01	0.000E+00
	3.319E+01	0.000E+00
	3.370E+01	0.000E+00
	3.421E+01	0.000E+00
	3.473E+01	0.000E+00
	3.524E+01	0.000E+00
	3.575E+01	0.000E+00
	3.627E+01	0.000E+00
	3.678E+01	0.000E+00
10	0.000E+00	1.000E+00
	5.560E-01	4.225E-01
	1.112E+00	1.080E-01
	1.668E+00	1.581E-02
	2.224E+00	1.284E-03
	2.780E+00	5.671E-05
	3.336E+00	1.347E-06
	3.892E+00	1.707E-08
	4.448E+00	1.155E-10
	5.004E+00	5.749E-13
	5.560E+00	3.720E-14
	6.116E+00	6.815E-15
	6.672E+00	1.083E-15
	7.228E+00	1.453E-16
	7.784E+00	1.634E-17
	8.340E+00	1.530E-18
	8.896E+00	1.182E-19
	9.452E+00	7.465E-21
	1.001E+01	3.813E-22
	1.056E+01	1.558E-23
	1.112E+01	5.248E-25
	1.163E+01	1.781E-26
	1.215E+01	4.986E-28
	1.266E+01	1.338E-29
	1.317E+01	6.167E-31
	1.369E+01	6.029E-32
	1.420E+01	6.949E-33
	1.471E+01	7.524E-34
	1.523E+01	7.411E-35
	1.574E+01	6.603E-36
	1.625E+01	5.304E-37
	1.677E+01	3.829E-38
	1.728E+01	2.475E-39
	1.779E+01	1.428E-40
	1.830E+01	7.331E-42
	1.882E+01	3.351E-43
	1.933E+01	1.379E-44
	1.984E+01	5.375E-46
	2.036E+01	2.308E-47
	2.087E+01	1.368E-48
	2.138E+01	1.110E-49
	2.190E+01	1.001E-50
	2.241E+01	0.000E+00
	2.292E+01	0.000E+00
	2.344E+01	0.000E+00
	2.395E+01	0.000E+00
	2.446E+01	0.000E+00

	2.498E+01 2.549E+01 2.600E+01 2.652E+01 2.703E+01 2.754E+01 2.806E+01 2.857E+01 2.908E+01 2.960E+01 3.011E+01 3.062E+01 3.113E+01 3.165E+01 3.216E+01 3.267E+01 3.319E+01 3.370E+01 3.421E+01 3.473E+01 3.524E+01 3.575E+01 3.627E+01 3.678E+01	0.000E+00 0.000E+00
15	0.000E+00 5.560E-01 1.112E+00 1.668E+00 2.224E+00 2.780E+00 3.336E+00 3.892E+00 4.448E+00 5.004E+00 5.560E+00 6.116E+00 6.672E+00 7.228E+00 7.784E+00 8.340E+00 8.896E+00 9.452E+00 1.001E+01 1.056E+01 1.112E+01 1.163E+01 1.215E+01 1.266E+01 1.317E+01 1.369E+01 1.420E+01 1.471E+01 1.523E+01 1.574E+01 1.625E+01 1.677E+01	1.000E+00 5.134E-01 1.901E-01 4.908E-02 8.638E-03 1.022E-03 8.049E-05 4.195E-06 1.440E-07 3.246E-09 4.841E-11 6.352E-13 5.377E-14 1.347E-14 3.200E-15 6.812E-16 1.294E-16 2.186E-17 3.268E-18 4.308E-19 5.187E-20 6.274E-21 6.724E-22 6.355E-23 5.270E-24 3.817E-25 2.407E-26 1.330E-27 6.776E-29 3.973E-30 3.966E-31 6.194E-32

	1.728E+01	1.065E-32
	1.779E+01	1.770E-33
	1.830E+01	2.769E-34
	1.882E+01	4.056E-35
	1.933E+01	5.556E-36
	1.984E+01	7.100E-37
	2.036E+01	8.451E-38
	2.087E+01	9.351E-39
	2.138E+01	9.602E-40
	2.190E+01	9.132E-41
	2.241E+01	8.035E-42
	2.292E+01	6.540E-43
	2.344E+01	4.949E-44
	2.395E+01	3.542E-45
	2.446E+01	2.520E-46
	2.498E+01	1.986E-47
	2.549E+01	1.965E-48
	2.600E+01	2.440E-49
	2.652E+01	3.380E-50
	2.703E+01	0.000E+00
	2.754E+01	0.000E+00
	2.806E+01	0.000E+00
	2.857E+01	0.000E+00
	2.908E+01	0.000E+00
	2.960E+01	0.000E+00
	3.011E+01	0.000E+00
	3.062E+01	0.000E+00
	3.113E+01	0.000E+00
	3.165E+01	0.000E+00
	3.216E+01	0.000E+00
	3.267E+01	0.000E+00
	3.319E+01	0.000E+00
	3.370E+01	0.000E+00
	3.421E+01	0.000E+00
	3.473E+01	0.000E+00
	3.524E+01	0.000E+00
	3.575E+01	0.000E+00
	3.627E+01	0.000E+00
	3.678E+01	0.000E+00
20	0.000E+00	1.000E+00
	5.560E-01	5.720E-01
	1.112E+00	2.572E-01
	1.668E+00	8.871E-02
	2.224E+00	2.309E-02
	2.780E+00	4.483E-03
	3.336E+00	6.444E-04
	3.892E+00	6.821E-05
	4.448E+00	5.294E-06
	5.004E+00	3.005E-07
	5.560E+00	1.245E-08
	6.116E+00	3.764E-10
	6.672E+00	8.591E-12
	7.228E+00	2.603E-13
	7.784E+00	4.540E-14
	8.340E+00	1.383E-14
	8.896E+00	4.014E-15

	9.452E+00	1.074E-15
	1.001E+01	2.640E-16
	1.056E+01	5.959E-17
	1.112E+01	1.277E-17
	1.163E+01	2.740E-18
	1.215E+01	5.418E-19
	1.266E+01	9.856E-20
	1.317E+01	1.645E-20
	1.369E+01	2.510E-21
	1.420E+01	3.494E-22
	1.471E+01	4.421E-23
	1.523E+01	5.069E-24
	1.574E+01	5.249E-25
	1.625E+01	4.900E-26
	1.677E+01	4.130E-27
	1.728E+01	3.199E-28
	1.779E+01	2.456E-29
	1.830E+01	2.328E-30
	1.882E+01	3.439E-31
	1.933E+01	6.948E-32
	1.984E+01	1.515E-32
	2.036E+01	3.240E-33
	2.087E+01	6.641E-34
	2.138E+01	1.297E-34
	2.190E+01	2.411E-35
	2.241E+01	4.259E-36
	2.292E+01	7.141E-37
	2.344E+01	1.135E-37
	2.395E+01	1.708E-38
	2.446E+01	2.432E-39
	2.498E+01	3.270E-40
	2.549E+01	4.150E-41
	2.600E+01	4.966E-42
	2.652E+01	5.608E-43
	2.703E+01	5.997E-44
	2.754E+01	6.141E-45
	2.806E+01	6.192E-46
	2.857E+01	6.527E-47
	2.908E+01	7.862E-48
	2.960E+01	1.145E-48
	3.011E+01	1.939E-49
	3.062E+01	3.516E-50
	3.113E+01	0.000E+00
	3.165E+01	0.000E+00
	3.216E+01	0.000E+00
	3.267E+01	0.000E+00
	3.319E+01	0.000E+00
	3.370E+01	0.000E+00
	3.421E+01	0.000E+00
	3.473E+01	0.000E+00
	3.524E+01	0.000E+00
	3.575E+01	0.000E+00
	3.627E+01	0.000E+00
	3.678E+01	0.000E+00
25	0.000E+00	1.000E+00
	5.560E-01	6.138E-01

1.112E+00
1.668E+00
2.224E+00
2.780E+00
3.336E+00
3.892E+00
4.448E+00
5.004E+00
5.560E+00
6.116E+00
6.672E+00
7.228E+00
7.784E+00
8.340E+00
8.896E+00
9.452E+00
1.001E+01
1.056E+01
1.112E+01
1.163E+01
1.215E+01
1.266E+01
1.317E+01
1.369E+01
1.420E+01
1.471E+01
1.523E+01
1.574E+01
1.625E+01
1.677E+01
1.728E+01
1.779E+01
1.830E+01
1.882E+01
1.933E+01
1.984E+01
2.036E+01
2.087E+01
2.138E+01
2.190E+01
2.241E+01
2.292E+01
2.344E+01
2.395E+01
2.446E+01
2.498E+01
2.549E+01
2.600E+01
2.652E+01
2.703E+01
2.754E+01
2.806E+01
2.857E+01
2.908E+01
2.960E+01
3.011E+01
3.062E+01

3.115E-01
1.283E-01
4.233E-02
1.109E-02
2.290E-03
3.712E-04
4.705E-05
4.651E-06
3.580E-07
2.141E-08
9.951E-10
3.629E-11
1.210E-12
1.055E-13
3.160E-14
1.092E-14
3.577E-15
1.100E-15
3.275E-16
9.721E-17
2.716E-17
7.131E-18
1.757E-18
4.054E-19
8.746E-20
1.761E-20
3.301E-21
5.750E-22
9.286E-23
1.387E-23
1.912E-24
2.428E-25
2.836E-26
3.057E-27
3.090E-28
3.103E-29
3.612E-30
5.923E-31
1.327E-31
3.360E-32
8.589E-33
2.138E-33
5.135E-34
1.186E-34
2.633E-35
5.610E-36
1.147E-36
2.246E-37
4.215E-38
7.566E-39
1.298E-39
2.128E-40
3.330E-41
4.971E-42
7.085E-43
9.662E-44
1.269E-44

	3.113E+01	1.632E-45
	3.165E+01	2.123E-46
	3.216E+01	2.960E-47
	3.267E+01	4.710E-48
	3.319E+01	8.724E-49
	3.370E+01	1.805E-49
	3.421E+01	3.926E-50
	3.473E+01	0.000E+00
	3.524E+01	0.000E+00
	3.575E+01	0.000E+00
	3.627E+01	0.000E+00
	3.678E+01	0.000E+00
30	0.000E+00	1.000E+00
	5.560E-01	6.455E-01
	1.112E+00	3.561E-01
	1.668E+00	1.655E-01
	2.224E+00	6.407E-02
	2.780E+00	2.051E-02
	3.336E+00	5.400E-03
	3.892E+00	1.164E-03
	4.448E+00	2.047E-04
	5.004E+00	2.931E-05
	5.560E+00	3.410E-06
	6.116E+00	3.220E-07
	6.672E+00	2.464E-08
	7.228E+00	1.528E-09
	7.784E+00	7.716E-11
	8.340E+00	3.384E-12
	8.896E+00	2.245E-13
	9.452E+00	5.382E-14
	1.001E+01	2.027E-14
	1.056E+01	7.604E-15
	1.112E+01	2.798E-15
	1.163E+01	1.024E-15
	1.215E+01	3.572E-16
	1.266E+01	1.186E-16
	1.317E+01	3.745E-17
	1.369E+01	1.123E-17
	1.420E+01	3.197E-18
	1.471E+01	8.619E-19
	1.523E+01	2.199E-19
	1.574E+01	5.301E-20
	1.625E+01	1.206E-20
	1.677E+01	2.582E-21
	1.728E+01	5.202E-22
	1.779E+01	9.838E-23
	1.830E+01	1.743E-23
	1.882E+01	2.890E-24
	1.933E+01	4.475E-25
	1.984E+01	6.464E-26
	2.036E+01	8.719E-27
	2.087E+01	1.105E-27
	2.138E+01	1.346E-28
	2.190E+01	1.689E-29
	2.241E+01	2.522E-30
	2.292E+01	5.106E-31

	2.344E+01 2.395E+01 2.446E+01 2.498E+01 2.549E+01 2.600E+01 2.652E+01 2.703E+01 2.754E+01 2.806E+01 2.857E+01 2.908E+01 2.960E+01 3.011E+01 3.062E+01 3.113E+01 3.165E+01 3.216E+01 3.267E+01 3.319E+01 3.370E+01 3.421E+01 3.473E+01 3.524E+01 3.575E+01 3.627E+01 3.678E+01	1.322E-31 3.773E-32 1.089E-32 3.079E-33 8.459E-34 2.251E-34 5.796E-35 1.443E-35 3.472E-36 8.068E-37 1.809E-37 3.912E-38 8.155E-39 1.637E-39 3.164E-40 5.883E-41 1.052E-41 1.809E-42 2.995E-43 4.788E-44 7.447E-45 1.144E-45 1.788E-46 2.978E-47 5.542E-48 1.173E-48 2.742E-49
35	0.000E+00 5.560E-01 1.112E+00 1.668E+00 2.224E+00 2.780E+00 3.336E+00 3.892E+00 4.448E+00 5.004E+00 5.560E+00 6.116E+00 6.672E+00 7.228E+00 7.784E+00 8.340E+00 8.896E+00 9.452E+00 1.001E+01 1.056E+01 1.112E+01 1.163E+01 1.215E+01 1.266E+01 1.317E+01 1.369E+01 1.420E+01 1.471E+01 1.523E+01	1.000E+00 6.706E-01 3.935E-01 1.996E-01 8.675E-02 3.209E-02 1.005E-02 2.657E-03 5.907E-04 1.102E-04 1.724E-05 2.256E-06 2.467E-07 2.254E-08 1.719E-09 1.098E-10 6.113E-12 4.098E-13 7.905E-14 3.049E-14 1.289E-14 5.460E-15 2.223E-15 8.691E-16 3.260E-16 1.172E-16 4.036E-17 1.330E-17 4.191E-18

	1.574E+01 1.625E+01 1.677E+01 1.728E+01 1.779E+01 1.830E+01 1.882E+01 1.933E+01 1.984E+01 2.036E+01 2.087E+01 2.138E+01 2.190E+01 2.241E+01 2.292E+01 2.344E+01 2.395E+01 2.446E+01 2.498E+01 2.549E+01 2.600E+01 2.652E+01 2.703E+01 2.754E+01 2.806E+01 2.857E+01 2.908E+01 2.960E+01 3.011E+01 3.062E+01 3.113E+01 3.165E+01 3.216E+01 3.267E+01 3.319E+01 3.370E+01 3.421E+01 3.473E+01 3.524E+01 3.575E+01 3.627E+01 3.678E+01	1.261E-18 3.619E-19 9.901E-20 2.578E-20 6.382E-21 1.500E-21 3.343E-22 7.053E-23 1.407E-23 2.651E-24 4.710E-25 7.885E-26 1.244E-26 1.859E-27 2.664E-28 3.818E-29 6.006E-30 1.182E-30 3.023E-31 9.068E-32 2.865E-32 9.049E-33 2.803E-33 8.466E-34 2.488E-34 7.108E-35 1.973E-35 5.320E-36 1.392E-36 3.535E-37 8.704E-38 2.077E-38 4.801E-39 1.074E-39 2.327E-40 4.874E-41 9.874E-42 1.935E-42 3.669E-43 6.750E-44 1.211E-44 2.141E-45
40	0.000E+00 5.560E-01 1.112E+00 1.668E+00 2.224E+00 2.780E+00 3.336E+00 3.892E+00 4.448E+00 5.004E+00 5.560E+00 6.116E+00 6.672E+00 7.228E+00	1.000E+00 6.911E-01 4.252E-01 2.306E-01 1.094E-01 4.514E-02 1.612E-02 4.967E-03 1.317E-03 2.999E-04 5.855E-05 9.788E-06 1.400E-06 1.710E-07

7.784E+00	1.785E-08
8.340E+00	1.591E-09
8.896E+00	1.215E-10
9.452E+00	8.186E-12
1.001E+01	6.093E-13
1.056E+01	1.055E-13
1.112E+01	4.133E-14
1.163E+01	1.915E-14
1.215E+01	8.725E-15
1.266E+01	3.846E-15
1.317E+01	1.637E-15
1.369E+01	6.721E-16
1.420E+01	2.661E-16
1.471E+01	1.015E-16
1.523E+01	3.729E-17
1.574E+01	1.318E-17
1.625E+01	4.478E-18
1.677E+01	1.462E-18
1.728E+01	4.579E-19
1.779E+01	1.375E-19
1.830E+01	3.958E-20
1.882E+01	1.090E-20
1.933E+01	2.870E-21
1.984E+01	7.216E-22
2.036E+01	1.731E-22
2.087E+01	3.955E-23
2.138E+01	8.603E-24
2.190E+01	1.779E-24
2.241E+01	3.494E-25
2.292E+01	6.514E-26
2.344E+01	1.153E-26
2.395E+01	1.947E-27
2.446E+01	3.169E-28
2.498E+01	5.132E-29
2.549E+01	8.876E-30
2.600E+01	1.829E-30
2.652E+01	4.772E-31
2.703E+01	1.487E-31
2.754E+01	5.003E-32
2.806E+01	1.709E-32
2.857E+01	5.780E-33
2.908E+01	1.916E-33
2.960E+01	6.205E-34
3.011E+01	1.962E-34
3.062E+01	6.052E-35
3.113E+01	1.820E-35
3.165E+01	5.335E-36
3.216E+01	1.524E-36
3.267E+01	4.239E-37
3.319E+01	1.148E-37
3.370E+01	3.024E-38
3.421E+01	7.751E-39
3.473E+01	1.931E-39
3.524E+01	4.676E-40
3.575E+01	1.100E-40
3.627E+01	2.513E-41
3.678E+01	5.575E-42

45

0.000E+00	1.000E+00
5.560E-01	7.082E-01
1.112E+00	4.526E-01
1.668E+00	2.588E-01
2.224E+00	1.315E-01
2.780E+00	5.910E-02
3.336E+00	2.338E-02
3.892E+00	8.122E-03
4.448E+00	2.471E-03
5.004E+00	6.569E-04
5.560E+00	1.524E-04
6.116E+00	3.084E-05
6.672E+00	5.432E-06
7.228E+00	8.325E-07
7.784E+00	1.110E-07
8.340E+00	1.285E-08
8.896E+00	1.294E-09
9.452E+00	1.136E-10
1.001E+01	8.929E-12
1.056E+01	7.543E-13
1.112E+01	1.322E-13
1.163E+01	5.276E-14
1.215E+01	2.535E-14
1.266E+01	1.221E-14
1.317E+01	5.720E-15
1.369E+01	2.600E-15
1.420E+01	1.145E-15
1.471E+01	4.884E-16
1.523E+01	2.017E-16
1.574E+01	8.053E-17
1.625E+01	3.109E-17
1.677E+01	1.160E-17
1.728E+01	4.177E-18
1.779E+01	1.451E-18
1.830E+01	4.863E-19
1.882E+01	1.570E-19
1.933E+01	4.877E-20
1.984E+01	1.458E-20
2.036E+01	4.186E-21
2.087E+01	1.154E-21
2.138E+01	3.054E-22
2.190E+01	7.741E-23
2.241E+01	1.879E-23
2.292E+01	4.362E-24
2.344E+01	9.677E-25
2.395E+01	2.050E-25
2.446E+01	4.147E-26
2.498E+01	8.018E-27
2.549E+01	1.487E-27
2.600E+01	2.679E-28
2.652E+01	4.822E-29
2.703E+01	9.237E-30
2.754E+01	2.065E-30
2.806E+01	5.702E-31
2.857E+01	1.864E-31
2.908E+01	6.621E-32

	2.960E+01 3.011E+01 3.062E+01 3.113E+01 3.165E+01 3.216E+01 3.267E+01 3.319E+01 3.370E+01 3.421E+01 3.473E+01 3.524E+01 3.575E+01 3.627E+01 3.678E+01	2.406E-32 8.698E-33 3.096E-33 1.081E-33 3.692E-34 1.235E-34 4.037E-35 1.291E-35 4.033E-36 1.231E-36 3.672E-37 1.069E-37 3.038E-38 8.422E-39 2.277E-39
50	0.000E+00 5.560E-01 1.112E+00 1.668E+00 2.224E+00 2.780E+00 3.336E+00 3.892E+00 4.448E+00 5.004E+00 5.560E+00 6.116E+00 6.672E+00 7.228E+00 7.784E+00 8.340E+00 8.896E+00 9.452E+00 1.001E+01 1.056E+01 1.112E+01 1.163E+01 1.215E+01 1.266E+01 1.317E+01 1.369E+01 1.420E+01 1.471E+01 1.523E+01 1.574E+01 1.625E+01 1.677E+01 1.728E+01 1.779E+01 1.830E+01 1.882E+01 1.933E+01 1.984E+01 2.036E+01 2.087E+01 2.138E+01	1.000E+00 7.229E-01 4.766E-01 2.845E-01 1.528E-01 7.356E-02 3.160E-02 1.208E-02 4.104E-03 1.235E-03 3.292E-04 7.758E-05 1.615E-05 2.967E-06 4.810E-07 6.873E-08 8.657E-09 9.612E-10 9.444E-11 8.432E-12 8.379E-13 1.630E-13 6.293E-14 3.097E-14 1.556E-14 7.657E-15 3.667E-15 1.708E-15 7.729E-16 3.398E-16 1.450E-16 6.005E-17 2.412E-17 9.390E-18 3.542E-18 1.293E-18 4.570E-19 1.561E-19 5.155E-20 1.643E-20 5.055E-21

	2.190E+01 2.241E+01 2.292E+01 2.344E+01 2.395E+01 2.446E+01 2.498E+01 2.549E+01 2.600E+01 2.652E+01 2.703E+01 2.754E+01 2.806E+01 2.857E+01 2.908E+01 2.960E+01 3.011E+01 3.062E+01 3.113E+01 3.165E+01 3.216E+01 3.267E+01 3.319E+01 3.370E+01 3.421E+01 3.473E+01 3.524E+01 3.575E+01 3.627E+01 3.678E+01	1.499E-21 4.284E-22 1.178E-22 3.118E-23 7.927E-24 1.935E-24 4.535E-25 1.019E-25 2.198E-26 4.553E-27 9.113E-28 1.785E-28 3.533E-29 7.502E-30 1.853E-30 5.538E-31 1.922E-31 7.191E-32 2.752E-32 1.050E-32 3.956E-33 1.465E-33 5.322E-34 1.897E-34 6.626E-35 2.269E-35 7.610E-36 2.500E-36 8.043E-37 2.533E-37
55	0.000E+00 5.560E-01 1.112E+00 1.668E+00 2.224E+00 2.780E+00 3.336E+00 3.892E+00 4.448E+00 5.004E+00 5.560E+00 6.116E+00 6.672E+00 7.228E+00 7.784E+00 8.340E+00 8.896E+00 9.452E+00 1.001E+01 1.056E+01 1.112E+01 1.163E+01 1.215E+01 1.266E+01 1.317E+01 1.369E+01	1.000E+00 7.355E-01 4.978E-01 3.079E-01 1.732E-01 8.822E-02 4.055E-02 1.678E-02 6.236E-03 2.078E-03 6.204E-04 1.657E-04 3.954E-05 8.427E-06 1.603E-06 2.721E-07 4.118E-08 5.555E-09 6.685E-10 7.210E-11 7.464E-12 9.420E-13 1.869E-13 7.117E-14 3.566E-14 1.854E-14

1.420E+01	9.492E-15
1.471E+01	4.745E-15
1.523E+01	2.313E-15
1.574E+01	1.098E-15
1.625E+01	5.081E-16
1.677E+01	2.289E-16
1.728E+01	1.003E-16
1.779E+01	4.280E-17
1.830E+01	1.775E-17
1.882E+01	7.154E-18
1.933E+01	2.801E-18
1.984E+01	1.065E-18
2.036E+01	3.928E-19
2.087E+01	1.405E-19
2.138E+01	4.873E-20
2.190E+01	1.637E-20
2.241E+01	5.323E-21
2.292E+01	1.674E-21
2.344E+01	5.092E-22
2.395E+01	1.496E-22
2.446E+01	4.242E-23
2.498E+01	1.161E-23
2.549E+01	3.061E-24
2.600E+01	7.777E-25
2.652E+01	1.903E-25
2.703E+01	4.482E-26
2.754E+01	1.017E-26
2.806E+01	2.231E-27
2.857E+01	4.761E-28
2.908E+01	1.005E-28
2.960E+01	2.177E-29
3.011E+01	5.142E-30
3.062E+01	1.417E-30
3.113E+01	4.637E-31
3.165E+01	1.718E-31
3.216E+01	6.759E-32
3.267E+01	2.707E-32
3.319E+01	1.081E-32
3.370E+01	4.263E-33
3.421E+01	1.656E-33
3.473E+01	6.324E-34
3.524E+01	2.373E-34
3.575E+01	8.744E-35
3.627E+01	3.164E-35
3.678E+01	1.124E-35

NOTICE

Although this program has been tested and experience would indicate that it is accurate within the limits given by the assumptions of the theory used, we make no warranty as to workability of this software or any other licensed material. No warranties either expressed or implied (including warranties of fitness) shall apply. No responsibility is assumed for any errors, mistakes or misrepresentations that may occur from the use of this computer program. The user accepts full responsibility for assessing the validity and applicability of the results obtained with this program for any specific case.

POLLUTEv7

Version 7.13

Copyright (c) 2007.

GAEA Technologies Ltd., R.K. Rowe and J.R. Booker

DB CoHD Low

THE DARCY VELOCITY (Flux) THROUGH THE LAYERS $V_a = 0.000203$ m/year

Layer Properties

Layer	Thickness	Number of Sublayers	Coefficient of Hydrodynamic Dispersion	Matrix Porosity	Distribution Coefficient	Dry Density
Clay	11.12 m	20	0.01425 m ² /a	0.37	0 m ³ /kg	1510 kg/m ³
Clay with Sand	25.66 m	50	0.01425 m ² /a	0.34	0 m ³ /kg	1510 kg/m ³

Boundary Conditions

Constant Concentration

Source Concentration = 1 mg/L

Infinite Thickness Bottom Boundary

Laplace Transform Parameters

TAU = 7 N = 20 SIG = 0 RNU = 2

Calculated Concentrations at Selected Times and Depths

Time year	Depth m	Concentration mg/L
5	0.000E+00	1.000E+00
	5.560E-01	1.423E-01
	1.112E+00	3.291E-03
	1.668E+00	1.026E-05
	2.224E+00	3.995E-09

2.780E+00	3.251E-13
3.336E+00	7.337E-15
3.892E+00	2.276E-16
4.448E+00	3.947E-18
5.004E+00	3.646E-20
5.560E+00	1.694E-22
6.116E+00	3.702E-25
6.672E+00	3.681E-28
7.228E+00	5.171E-31
7.784E+00	6.216E-33
8.340E+00	6.939E-35
8.896E+00	5.242E-37
9.452E+00	2.607E-39
1.001E+01	8.317E-42
1.056E+01	1.699E-44
1.112E+01	3.109E-47
1.163E+01	2.144E-49
1.215E+01	0.000E+00
1.266E+01	0.000E+00
1.317E+01	0.000E+00
1.369E+01	0.000E+00
1.420E+01	0.000E+00
1.471E+01	0.000E+00
1.523E+01	0.000E+00
1.574E+01	0.000E+00
1.625E+01	0.000E+00
1.677E+01	0.000E+00
1.728E+01	0.000E+00
1.779E+01	0.000E+00
1.830E+01	0.000E+00
1.882E+01	0.000E+00
1.933E+01	0.000E+00
1.984E+01	0.000E+00
2.036E+01	0.000E+00
2.087E+01	0.000E+00
2.138E+01	0.000E+00
2.190E+01	0.000E+00
2.241E+01	0.000E+00
2.292E+01	0.000E+00
2.344E+01	0.000E+00
2.395E+01	0.000E+00
2.446E+01	0.000E+00
2.498E+01	0.000E+00
2.549E+01	0.000E+00
2.600E+01	0.000E+00
2.652E+01	0.000E+00
2.703E+01	0.000E+00
2.754E+01	0.000E+00
2.806E+01	0.000E+00
2.857E+01	0.000E+00
2.908E+01	0.000E+00
2.960E+01	0.000E+00
3.011E+01	0.000E+00
3.062E+01	0.000E+00
3.113E+01	0.000E+00
3.165E+01	0.000E+00
3.216E+01	0.000E+00

	3.267E+01	0.000E+00
	3.319E+01	0.000E+00
	3.370E+01	0.000E+00
	3.421E+01	0.000E+00
	3.473E+01	0.000E+00
	3.524E+01	0.000E+00
	3.575E+01	0.000E+00
	3.627E+01	0.000E+00
	3.678E+01	0.000E+00
10	0.000E+00	1.000E+00
	5.560E-01	3.008E-01
	1.112E+00	3.806E-02
	1.668E+00	1.839E-03
	2.224E+00	3.236E-05
	2.780E+00	2.020E-07
	3.336E+00	4.417E-10
	3.892E+00	4.936E-13
	4.448E+00	2.190E-14
	5.004E+00	2.274E-15
	5.560E+00	1.796E-16
	6.116E+00	1.058E-17
	6.672E+00	4.580E-19
	7.228E+00	1.428E-20
	7.784E+00	3.138E-22
	8.340E+00	4.747E-24
	8.896E+00	4.828E-26
	9.452E+00	3.340E-28
	1.001E+01	2.500E-30
	1.056E+01	7.400E-32
	1.112E+01	3.721E-33
	1.163E+01	2.004E-34
	1.215E+01	9.161E-36
	1.266E+01	3.525E-37
	1.317E+01	1.134E-38
	1.369E+01	3.027E-40
	1.420E+01	6.661E-42
	1.471E+01	1.209E-43
	1.523E+01	1.884E-45
	1.574E+01	3.104E-47
	1.625E+01	8.368E-49
	1.677E+01	3.520E-50
	1.728E+01	0.000E+00
	1.779E+01	0.000E+00
	1.830E+01	0.000E+00
	1.882E+01	0.000E+00
	1.933E+01	0.000E+00
	1.984E+01	0.000E+00
	2.036E+01	0.000E+00
	2.087E+01	0.000E+00
	2.138E+01	0.000E+00
	2.190E+01	0.000E+00
	2.241E+01	0.000E+00
	2.292E+01	0.000E+00
	2.344E+01	0.000E+00
	2.395E+01	0.000E+00
	2.446E+01	0.000E+00

	2.498E+01 2.549E+01 2.600E+01 2.652E+01 2.703E+01 2.754E+01 2.806E+01 2.857E+01 2.908E+01 2.960E+01 3.011E+01 3.062E+01 3.113E+01 3.165E+01 3.216E+01 3.267E+01 3.319E+01 3.370E+01 3.421E+01 3.473E+01 3.524E+01 3.575E+01 3.627E+01 3.678E+01	0.000E+00 0.000E+00
15	0.000E+00 5.560E-01 1.112E+00 1.668E+00 2.224E+00 2.780E+00 3.336E+00 3.892E+00 4.448E+00 5.004E+00 5.560E+00 6.116E+00 6.672E+00 7.228E+00 7.784E+00 8.340E+00 8.896E+00 9.452E+00 1.001E+01 1.056E+01 1.112E+01 1.163E+01 1.215E+01 1.266E+01 1.317E+01 1.369E+01 1.420E+01 1.471E+01 1.523E+01 1.574E+01 1.625E+01 1.677E+01	1.000E+00 3.994E-01 9.091E-02 1.109E-02 6.995E-04 2.237E-05 3.580E-07 2.846E-09 1.155E-11 1.055E-13 1.563E-14 2.429E-15 3.142E-16 3.351E-17 2.922E-18 2.063E-19 1.167E-20 5.220E-22 1.825E-23 4.915E-25 1.054E-26 2.367E-28 5.631E-30 2.940E-31 2.864E-32 2.896E-33 2.667E-34 2.202E-35 1.623E-36 1.064E-37 6.178E-39 3.165E-40

	9.452E+00	4.509E-19
	1.001E+01	4.013E-20
	1.056E+01	3.009E-21
	1.112E+01	1.964E-22
	1.163E+01	1.290E-23
	1.215E+01	7.160E-25
	1.266E+01	3.346E-26
	1.317E+01	1.324E-27
	1.369E+01	4.773E-29
	1.420E+01	2.214E-30
	1.471E+01	2.073E-31
	1.523E+01	2.823E-32
	1.574E+01	3.897E-33
	1.625E+01	5.027E-34
	1.677E+01	5.982E-35
	1.728E+01	6.545E-36
	1.779E+01	6.567E-37
	1.830E+01	6.027E-38
	1.882E+01	5.048E-39
	1.933E+01	3.847E-40
	1.984E+01	2.662E-41
	2.036E+01	1.671E-42
	2.087E+01	9.547E-44
	2.138E+01	5.058E-45
	2.190E+01	2.644E-46
	2.241E+01	1.582E-47
	2.292E+01	1.270E-48
	2.344E+01	1.307E-49
	2.395E+01	1.460E-50
	2.446E+01	0.000E+00
	2.498E+01	0.000E+00
	2.549E+01	0.000E+00
	2.600E+01	0.000E+00
	2.652E+01	0.000E+00
	2.703E+01	0.000E+00
	2.754E+01	0.000E+00
	2.806E+01	0.000E+00
	2.857E+01	0.000E+00
	2.908E+01	0.000E+00
	2.960E+01	0.000E+00
	3.011E+01	0.000E+00
	3.062E+01	0.000E+00
	3.113E+01	0.000E+00
	3.165E+01	0.000E+00
	3.216E+01	0.000E+00
	3.267E+01	0.000E+00
	3.319E+01	0.000E+00
	3.370E+01	0.000E+00
	3.421E+01	0.000E+00
	3.473E+01	0.000E+00
	3.524E+01	0.000E+00
	3.575E+01	0.000E+00
	3.627E+01	0.000E+00
	3.678E+01	0.000E+00
25	0.000E+00	1.000E+00
	5.560E-01	5.156E-01

1.112E+00	1.918E-01
1.668E+00	4.971E-02
2.224E+00	8.787E-03
2.780E+00	1.044E-03
3.336E+00	8.258E-05
3.892E+00	4.322E-06
4.448E+00	1.490E-07
5.004E+00	3.373E-09
5.560E+00	5.053E-11
6.116E+00	6.657E-13
6.672E+00	5.659E-14
7.228E+00	1.424E-14
7.784E+00	3.396E-15
8.340E+00	7.261E-16
8.896E+00	1.385E-16
9.452E+00	2.350E-17
1.001E+01	3.529E-18
1.056E+01	4.672E-19
1.112E+01	5.649E-20
1.163E+01	6.862E-21
1.215E+01	7.386E-22
1.266E+01	7.011E-23
1.317E+01	5.839E-24
1.369E+01	4.247E-25
1.420E+01	2.690E-26
1.471E+01	1.493E-27
1.523E+01	7.638E-29
1.574E+01	4.497E-30
1.625E+01	4.508E-31
1.677E+01	7.070E-32
1.728E+01	1.221E-32
1.779E+01	2.038E-33
1.830E+01	3.201E-34
1.882E+01	4.711E-35
1.933E+01	6.480E-36
1.984E+01	8.316E-37
2.036E+01	9.941E-38
2.087E+01	1.105E-38
2.138E+01	1.139E-39
2.190E+01	1.088E-40
2.241E+01	9.616E-42
2.292E+01	7.861E-43
2.344E+01	5.974E-44
2.395E+01	4.293E-45
2.446E+01	3.068E-46
2.498E+01	2.428E-47
2.549E+01	2.412E-48
2.600E+01	3.008E-49
2.652E+01	4.185E-50
2.703E+01	0.000E+00
2.754E+01	0.000E+00
2.806E+01	0.000E+00
2.857E+01	0.000E+00
2.908E+01	0.000E+00
2.960E+01	0.000E+00
3.011E+01	0.000E+00
3.062E+01	0.000E+00

	3.113E+01	0.000E+00
	3.165E+01	0.000E+00
	3.216E+01	0.000E+00
	3.267E+01	0.000E+00
	3.319E+01	0.000E+00
	3.370E+01	0.000E+00
	3.421E+01	0.000E+00
	3.473E+01	0.000E+00
	3.524E+01	0.000E+00
	3.575E+01	0.000E+00
	3.627E+01	0.000E+00
	3.678E+01	0.000E+00
30	0.000E+00	1.000E+00
	5.560E-01	5.535E-01
	1.112E+00	2.341E-01
	1.668E+00	7.356E-02
	2.224E+00	1.687E-02
	2.780E+00	2.788E-03
	3.336E+00	3.292E-04
	3.892E+00	2.763E-05
	4.448E+00	1.641E-06
	5.004E+00	6.873E-08
	5.560E+00	2.028E-09
	6.116E+00	4.252E-11
	6.672E+00	8.040E-13
	7.228E+00	7.030E-14
	7.784E+00	1.950E-14
	8.340E+00	5.408E-15
	8.896E+00	1.372E-15
	9.452E+00	3.169E-16
	1.001E+01	6.646E-17
	1.056E+01	1.263E-17
	1.112E+01	2.254E-18
	1.163E+01	4.028E-19
	1.215E+01	6.558E-20
	1.266E+01	9.692E-21
	1.317E+01	1.296E-21
	1.369E+01	1.562E-22
	1.420E+01	1.690E-23
	1.471E+01	1.636E-24
	1.523E+01	1.413E-25
	1.574E+01	1.087E-26
	1.625E+01	7.540E-28
	1.677E+01	5.001E-29
	1.728E+01	3.904E-30
	1.779E+01	4.853E-31
	1.830E+01	8.844E-32
	1.882E+01	1.781E-32
	1.933E+01	3.516E-33
	1.984E+01	6.621E-34
	2.036E+01	1.181E-34
	2.087E+01	1.994E-35
	2.138E+01	3.180E-36
	2.190E+01	4.785E-37
	2.241E+01	6.782E-38
	2.292E+01	9.042E-39

	2.344E+01	1.133E-39
	2.395E+01	1.331E-40
	2.446E+01	1.466E-41
	2.498E+01	1.512E-42
	2.549E+01	1.466E-43
	2.600E+01	1.347E-44
	2.652E+01	1.205E-45
	2.703E+01	1.113E-46
	2.754E+01	1.174E-47
	2.806E+01	1.524E-48
	2.857E+01	2.349E-49
	2.908E+01	3.904E-50
	2.960E+01	0.000E+00
	3.011E+01	0.000E+00
	3.062E+01	0.000E+00
	3.113E+01	0.000E+00
	3.165E+01	0.000E+00
	3.216E+01	0.000E+00
	3.267E+01	0.000E+00
	3.319E+01	0.000E+00
	3.370E+01	0.000E+00
	3.421E+01	0.000E+00
	3.473E+01	0.000E+00
	3.524E+01	0.000E+00
	3.575E+01	0.000E+00
	3.627E+01	0.000E+00
	3.678E+01	0.000E+00
35	0.000E+00	1.000E+00
	5.560E-01	5.839E-01
	1.112E+00	2.713E-01
	1.668E+00	9.799E-02
	2.224E+00	2.709E-02
	2.780E+00	5.673E-03
	3.336E+00	8.926E-04
	3.892E+00	1.050E-04
	4.448E+00	9.199E-06
	5.004E+00	5.984E-07
	5.560E+00	2.885E-08
	6.116E+00	1.030E-09
	6.672E+00	2.759E-11
	7.228E+00	7.151E-13
	7.784E+00	7.527E-14
	8.340E+00	2.270E-14
	8.896E+00	7.005E-15
	9.452E+00	2.007E-15
	1.001E+01	5.309E-16
	1.056E+01	1.296E-16
	1.112E+01	3.022E-17
	1.163E+01	7.041E-18
	1.215E+01	1.521E-18
	1.266E+01	3.037E-19
	1.317E+01	5.595E-20
	1.369E+01	9.485E-21
	1.420E+01	1.476E-21
	1.471E+01	2.101E-22
	1.523E+01	2.728E-23

	1.574E+01 1.625E+01 1.677E+01 1.728E+01 1.779E+01 1.830E+01 1.882E+01 1.933E+01 1.984E+01 2.036E+01 2.087E+01 2.138E+01 2.190E+01 2.241E+01 2.292E+01 2.344E+01 2.395E+01 2.446E+01 2.498E+01 2.549E+01 2.600E+01 2.652E+01 2.703E+01 2.754E+01 2.806E+01 2.857E+01 2.908E+01 2.960E+01 3.011E+01 3.062E+01 3.113E+01 3.165E+01 3.216E+01 3.267E+01 3.319E+01 3.370E+01 3.421E+01 3.473E+01 3.524E+01 3.575E+01 3.627E+01 3.678E+01	3.222E-24 3.452E-25 3.350E-26 2.954E-27 2.420E-28 2.011E-29 2.125E-30 3.451E-31 7.374E-32 1.676E-32 3.733E-33 7.982E-34 1.631E-34 3.176E-35 5.895E-36 1.041E-36 1.748E-37 2.787E-38 4.213E-39 6.035E-40 8.181E-41 1.049E-41 1.272E-42 1.463E-43 1.607E-44 1.721E-45 1.877E-46 2.251E-47 3.199E-48 5.384E-49 1.001E-49 1.919E-50 0.000E+00 0.000E+00 0.000E+00 0.000E+00 0.000E+00 0.000E+00 0.000E+00 0.000E+00 0.000E+00 0.000E+00 0.000E+00 0.000E+00 0.000E+00 0.000E+00 0.000E+00 0.000E+00 0.000E+00 0.000E+00 0.000E+00
40	0.000E+00 5.560E-01 1.112E+00 1.668E+00 2.224E+00 2.780E+00 3.336E+00 3.892E+00 4.448E+00 5.004E+00 5.560E+00 6.116E+00 6.672E+00 7.228E+00	1.000E+00 6.090E-01 3.041E-01 1.221E-01 3.888E-02 9.727E-03 1.899E-03 2.879E-04 3.377E-05 3.057E-06 2.131E-07 1.142E-08 4.709E-10 1.526E-11

7.784E+00	5.318E-13
8.340E+00	7.284E-14
8.896E+00	2.384E-14
9.452E+00	7.977E-15
1.001E+01	2.503E-15
1.056E+01	7.348E-16
1.112E+01	2.082E-16
1.163E+01	5.884E-17
1.215E+01	1.560E-17
1.266E+01	3.875E-18
1.317E+01	8.998E-19
1.369E+01	1.950E-19
1.420E+01	3.935E-20
1.471E+01	7.380E-21
1.523E+01	1.283E-21
1.574E+01	2.064E-22
1.625E+01	3.064E-23
1.677E+01	4.187E-24
1.728E+01	5.254E-25
1.779E+01	6.047E-26
1.830E+01	6.389E-27
1.882E+01	6.271E-28
1.933E+01	5.983E-29
1.984E+01	6.360E-30
2.036E+01	9.361E-31
2.087E+01	1.959E-31
2.138E+01	4.799E-32
2.190E+01	1.200E-32
2.241E+01	2.925E-33
2.292E+01	6.873E-34
2.344E+01	1.551E-34
2.395E+01	3.358E-35
2.446E+01	6.968E-36
2.498E+01	1.385E-36
2.549E+01	2.632E-37
2.600E+01	4.784E-38
2.652E+01	8.302E-39
2.703E+01	1.375E-39
2.754E+01	2.170E-40
2.806E+01	3.263E-41
2.857E+01	4.673E-42
2.908E+01	6.378E-43
2.960E+01	8.319E-44
3.011E+01	1.046E-44
3.062E+01	1.293E-45
3.113E+01	1.638E-46
3.165E+01	2.269E-47
3.216E+01	3.649E-48
3.267E+01	6.825E-49
3.319E+01	1.404E-49
3.370E+01	2.991E-50
3.421E+01	0.000E+00
3.473E+01	0.000E+00
3.524E+01	0.000E+00
3.575E+01	0.000E+00
3.627E+01	0.000E+00
3.678E+01	0.000E+00

45

0.000E+00	1.000E+00
5.560E-01	6.301E-01
1.112E+00	3.332E-01
1.668E+00	1.454E-01
2.224E+00	5.171E-02
2.780E+00	1.487E-02
3.336E+00	3.435E-03
3.892E+00	6.345E-04
4.448E+00	9.342E-05
5.004E+00	1.093E-05
5.560E+00	1.016E-06
6.116E+00	7.472E-08
6.672E+00	4.352E-09
7.228E+00	2.010E-10
7.784E+00	7.638E-12
8.340E+00	3.617E-13
8.896E+00	6.614E-14
9.452E+00	2.339E-14
1.001E+01	8.339E-15
1.056E+01	2.818E-15
1.112E+01	9.263E-16
1.163E+01	3.033E-16
1.215E+01	9.400E-17
1.266E+01	2.754E-17
1.317E+01	7.617E-18
1.369E+01	1.986E-18
1.420E+01	4.873E-19
1.471E+01	1.124E-19
1.523E+01	2.431E-20
1.574E+01	4.924E-21
1.625E+01	9.322E-22
1.677E+01	1.646E-22
1.728E+01	2.705E-23
1.779E+01	4.129E-24
1.830E+01	5.844E-25
1.882E+01	7.657E-26
1.933E+01	9.297E-27
1.984E+01	1.054E-27
2.036E+01	1.149E-28
2.087E+01	1.319E-29
2.138E+01	1.907E-30
2.190E+01	3.878E-31
2.241E+01	9.842E-32
2.292E+01	2.664E-32
2.344E+01	7.161E-33
2.395E+01	1.872E-33
2.446E+01	4.726E-34
2.498E+01	1.151E-34
2.549E+01	2.702E-35
2.600E+01	6.105E-36
2.652E+01	1.327E-36
2.703E+01	2.774E-37
2.754E+01	5.572E-38
2.806E+01	1.074E-38
2.857E+01	1.986E-39
2.908E+01	3.520E-40

	2.960E+01 3.011E+01 3.062E+01 3.113E+01 3.165E+01 3.216E+01 3.267E+01 3.319E+01 3.370E+01 3.421E+01 3.473E+01 3.524E+01 3.575E+01 3.627E+01 3.678E+01	5.977E-41 9.716E-42 1.513E-42 2.259E-43 3.251E-44 4.557E-45 6.370E-46 9.268E-47 1.488E-47 2.748E-48 5.768E-49 1.307E-49 3.046E-50 0.000E+00 0.000E+00
50	0.000E+00 5.560E-01 1.112E+00 1.668E+00 2.224E+00 2.780E+00 3.336E+00 3.892E+00 4.448E+00 5.004E+00 5.560E+00 6.116E+00 6.672E+00 7.228E+00 7.784E+00 8.340E+00 8.896E+00 9.452E+00 1.001E+01 1.056E+01 1.112E+01 1.163E+01 1.215E+01 1.266E+01 1.317E+01 1.369E+01 1.420E+01 1.471E+01 1.523E+01 1.574E+01 1.625E+01 1.677E+01 1.728E+01 1.779E+01 1.830E+01 1.882E+01 1.933E+01 1.984E+01 2.036E+01 2.087E+01 2.138E+01	1.000E+00 6.482E-01 3.591E-01 1.676E-01 6.517E-02 2.096E-02 5.540E-03 1.199E-03 2.118E-04 3.045E-05 3.559E-06 3.375E-07 2.594E-08 1.615E-09 8.191E-11 3.608E-12 2.403E-13 5.785E-14 2.188E-14 8.243E-15 3.046E-15 1.120E-15 3.922E-16 1.308E-16 4.148E-17 1.250E-17 3.571E-18 9.670E-19 2.478E-19 5.998E-20 1.370E-20 2.948E-21 5.964E-22 1.133E-22 2.016E-23 3.356E-24 5.219E-25 7.571E-26 1.026E-26 1.305E-27 1.597E-28

	2.190E+01 2.241E+01 2.292E+01 2.344E+01 2.395E+01 2.446E+01 2.498E+01 2.549E+01 2.600E+01 2.652E+01 2.703E+01 2.754E+01 2.806E+01 2.857E+01 2.908E+01 2.960E+01 3.011E+01 3.062E+01 3.113E+01 3.165E+01 3.216E+01 3.267E+01 3.319E+01 3.370E+01 3.421E+01 3.473E+01 3.524E+01 3.575E+01 3.627E+01 3.678E+01	2.013E-29 3.017E-30 6.134E-31 1.595E-31 4.571E-32 1.325E-32 3.763E-33 1.038E-33 2.775E-34 7.175E-35 1.794E-35 4.335E-36 1.012E-36 2.278E-37 4.948E-38 1.036E-38 2.089E-39 4.054E-40 7.570E-41 1.359E-41 2.348E-42 3.904E-43 6.268E-44 9.790E-45 1.510E-45 2.371E-46 3.965E-47 7.410E-48 1.574E-48 3.697E-49
55	0.000E+00 5.560E-01 1.112E+00 1.668E+00 2.224E+00 2.780E+00 3.336E+00 3.892E+00 4.448E+00 5.004E+00 5.560E+00 6.116E+00 6.672E+00 7.228E+00 7.784E+00 8.340E+00 8.896E+00 9.452E+00 1.001E+01 1.056E+01 1.112E+01 1.163E+01 1.215E+01 1.266E+01 1.317E+01 1.369E+01	1.000E+00 6.640E-01 3.825E-01 1.887E-01 7.897E-02 2.783E-02 8.219E-03 2.025E-03 4.152E-04 7.068E-05 9.968E-06 1.163E-06 1.122E-07 8.940E-09 5.886E-10 3.237E-11 1.668E-12 1.634E-13 4.951E-14 1.986E-14 8.052E-15 3.250E-15 1.257E-15 4.651E-16 1.647E-16 5.570E-17

1.420E+01	1.798E-17
1.471E+01	5.537E-18
1.523E+01	1.624E-18
1.574E+01	4.532E-19
1.625E+01	1.202E-19
1.677E+01	3.024E-20
1.728E+01	7.214E-21
1.779E+01	1.629E-21
1.830E+01	3.475E-22
1.882E+01	6.997E-23
1.933E+01	1.327E-23
1.984E+01	2.369E-24
2.036E+01	3.972E-25
2.087E+01	6.253E-26
2.138E+01	9.251E-27
2.190E+01	1.294E-27
2.241E+01	1.747E-28
2.292E+01	2.413E-29
2.344E+01	3.855E-30
2.395E+01	8.077E-31
2.446E+01	2.163E-31
2.498E+01	6.499E-32
2.549E+01	1.999E-32
2.600E+01	6.073E-33
2.652E+01	1.800E-33
2.703E+01	5.185E-34
2.754E+01	1.450E-34
2.806E+01	3.936E-35
2.857E+01	1.036E-35
2.908E+01	2.641E-36
2.960E+01	6.522E-37
3.011E+01	1.559E-37
3.062E+01	3.607E-38
3.113E+01	8.068E-39
3.165E+01	1.744E-39
3.216E+01	3.641E-40
3.267E+01	7.337E-41
3.319E+01	1.427E-41
3.370E+01	2.679E-42
3.421E+01	4.859E-43
3.473E+01	8.532E-44
3.524E+01	1.459E-44
3.575E+01	2.458E-45
3.627E+01	4.174E-46
3.678E+01	7.407E-47

NOTICE

Although this program has been tested and experience would indicate that it is accurate within the limits given by the assumptions of the theory used, we make no warranty as to workability of this software or any other licensed material. No warranties either expressed or implied (including warranties of fitness) shall apply. No responsibility is assumed for any errors, mistakes or misrepresentations that may occur from the use of this computer program. The user accepts full responsibility for assessing the validity and applicability of the results obtained with this program for any specific case.

POLLUTEv7

Version 7.13

Copyright (c) 2007.
GAEA Technologies Ltd., R.K. Rowe and J.R. Booker

DB ClayPoro High

THE DARCY VELOCITY (Flux) THROUGH THE LAYERS $V_a = 0.000203$ m/year

Layer Properties

Layer	Thickness	Number of Sublayers	Coefficient of Hydrodynamic Dispersion	Matrix Porosity	Distribution Coefficient	Dry Density
Clay	11.12 m	20	0.019 m ² /a	0.45	0 m ³ /kg	1510 kg/m ³
Clay with Sand	25.66 m	50	0.019 m ² /a	0.34	0 m ³ /kg	1510 kg/m ³

Boundary Conditions

Constant Concentration

Source Concentration = 1 mg/L

Infinite Thickness Bottom Boundary

Laplace Transform Parameters

TAU = 7 N = 20 SIG = 0 RNU = 2

Calculated Concentrations at Selected Times and Depths

Time year	Depth m	Concentration mg/L
5	0.000E+00	1.000E+00
	5.560E-01	2.035E-01
	1.112E+00	1.088E-02
	1.668E+00	1.325E-04
	2.224E+00	3.447E-07

2.780E+00	1.865E-10
3.336E+00	9.968E-14
3.892E+00	5.897E-15
4.448E+00	2.914E-16
5.004E+00	9.329E-18
5.560E+00	1.877E-19
6.116E+00	2.292E-21
6.672E+00	1.629E-23
7.228E+00	6.449E-26
7.784E+00	1.442E-28
8.340E+00	5.218E-31
8.896E+00	1.104E-32
9.452E+00	2.398E-34
1.001E+01	3.920E-36
1.056E+01	4.720E-38
1.112E+01	4.689E-40
1.163E+01	4.372E-42
1.215E+01	3.066E-44
1.266E+01	1.837E-46
1.317E+01	1.711E-48
1.369E+01	3.347E-50
1.420E+01	0.000E+00
1.471E+01	0.000E+00
1.523E+01	0.000E+00
1.574E+01	0.000E+00
1.625E+01	0.000E+00
1.677E+01	0.000E+00
1.728E+01	0.000E+00
1.779E+01	0.000E+00
1.830E+01	0.000E+00
1.882E+01	0.000E+00
1.933E+01	0.000E+00
1.984E+01	0.000E+00
2.036E+01	0.000E+00
2.087E+01	0.000E+00
2.138E+01	0.000E+00
2.190E+01	0.000E+00
2.241E+01	0.000E+00
2.292E+01	0.000E+00
2.344E+01	0.000E+00
2.395E+01	0.000E+00
2.446E+01	0.000E+00
2.498E+01	0.000E+00
2.549E+01	0.000E+00
2.600E+01	0.000E+00
2.652E+01	0.000E+00
2.703E+01	0.000E+00
2.754E+01	0.000E+00
2.806E+01	0.000E+00
2.857E+01	0.000E+00
2.908E+01	0.000E+00
2.960E+01	0.000E+00
3.011E+01	0.000E+00
3.062E+01	0.000E+00
3.113E+01	0.000E+00
3.165E+01	0.000E+00
3.216E+01	0.000E+00

	3.267E+01	0.000E+00
	3.319E+01	0.000E+00
	3.370E+01	0.000E+00
	3.421E+01	0.000E+00
	3.473E+01	0.000E+00
	3.524E+01	0.000E+00
	3.575E+01	0.000E+00
	3.627E+01	0.000E+00
	3.678E+01	0.000E+00
10	0.000E+00	1.000E+00
	5.560E-01	3.695E-01
	1.112E+00	7.219E-02
	1.668E+00	6.949E-03
	2.224E+00	3.171E-04
	2.780E+00	6.708E-06
	3.336E+00	6.495E-08
	3.892E+00	2.862E-10
	4.448E+00	7.456E-13
	5.004E+00	3.331E-14
	5.560E+00	4.922E-15
	6.116E+00	6.016E-16
	6.672E+00	5.936E-17
	7.228E+00	4.682E-18
	7.784E+00	2.919E-19
	8.340E+00	1.421E-20
	8.896E+00	5.321E-22
	9.452E+00	1.510E-23
	1.001E+01	3.194E-25
	1.056E+01	4.993E-27
	1.112E+01	7.016E-29
	1.163E+01	1.632E-30
	1.215E+01	1.023E-31
	1.266E+01	9.112E-33
	1.317E+01	7.616E-34
	1.369E+01	5.655E-35
	1.420E+01	3.702E-36
	1.471E+01	2.127E-37
	1.523E+01	1.067E-38
	1.574E+01	4.655E-40
	1.625E+01	1.757E-41
	1.677E+01	5.733E-43
	1.728E+01	1.636E-44
	1.779E+01	4.357E-46
	1.830E+01	1.348E-47
	1.882E+01	6.397E-49
	1.933E+01	4.141E-50
	1.984E+01	0.000E+00
	2.036E+01	0.000E+00
	2.087E+01	0.000E+00
	2.138E+01	0.000E+00
	2.190E+01	0.000E+00
	2.241E+01	0.000E+00
	2.292E+01	0.000E+00
	2.344E+01	0.000E+00
	2.395E+01	0.000E+00
	2.446E+01	0.000E+00

9.452E+00	5.832E-17
1.001E+01	9.898E-18
1.056E+01	1.499E-18
1.112E+01	2.284E-19
1.163E+01	3.206E-20
1.215E+01	4.029E-21
1.266E+01	4.517E-22
1.317E+01	4.495E-23
1.369E+01	3.955E-24
1.420E+01	3.062E-25
1.471E+01	2.082E-26
1.523E+01	1.253E-27
1.574E+01	7.022E-29
1.625E+01	4.523E-30
1.677E+01	4.807E-31
1.728E+01	7.883E-32
1.779E+01	1.436E-32
1.830E+01	2.546E-33
1.882E+01	4.271E-34
1.933E+01	6.741E-35
1.984E+01	9.990E-36
2.036E+01	1.388E-36
2.087E+01	1.805E-37
2.138E+01	2.194E-38
2.190E+01	2.486E-39
2.241E+01	2.624E-40
2.292E+01	2.576E-41
2.344E+01	2.350E-42
2.395E+01	1.996E-43
2.446E+01	1.593E-44
2.498E+01	1.227E-45
2.549E+01	9.770E-47
2.600E+01	9.045E-48
2.652E+01	1.058E-48
2.703E+01	1.479E-49
2.754E+01	2.210E-50
2.806E+01	0.000E+00
2.857E+01	0.000E+00
2.908E+01	0.000E+00
2.960E+01	0.000E+00
3.011E+01	0.000E+00
3.062E+01	0.000E+00
3.113E+01	0.000E+00
3.165E+01	0.000E+00
3.216E+01	0.000E+00
3.267E+01	0.000E+00
3.319E+01	0.000E+00
3.370E+01	0.000E+00
3.421E+01	0.000E+00
3.473E+01	0.000E+00
3.524E+01	0.000E+00
3.575E+01	0.000E+00
3.627E+01	0.000E+00
3.678E+01	0.000E+00

1.112E+00	2.573E-01
1.668E+00	8.876E-02
2.224E+00	2.310E-02
2.780E+00	4.487E-03
3.336E+00	6.451E-04
3.892E+00	6.829E-05
4.448E+00	5.302E-06
5.004E+00	3.010E-07
5.560E+00	1.247E-08
6.116E+00	3.771E-10
6.672E+00	8.610E-12
7.228E+00	2.609E-13
7.784E+00	4.552E-14
8.340E+00	1.387E-14
8.896E+00	4.025E-15
9.452E+00	1.077E-15
1.001E+01	2.649E-16
1.056E+01	6.001E-17
1.112E+01	1.401E-17
1.163E+01	3.010E-18
1.215E+01	5.962E-19
1.266E+01	1.086E-19
1.317E+01	1.816E-20
1.369E+01	2.776E-21
1.420E+01	3.870E-22
1.471E+01	4.905E-23
1.523E+01	5.632E-24
1.574E+01	5.842E-25
1.625E+01	5.462E-26
1.677E+01	4.611E-27
1.728E+01	3.577E-28
1.779E+01	2.751E-29
1.830E+01	2.612E-30
1.882E+01	3.865E-31
1.933E+01	7.820E-32
1.984E+01	1.708E-32
2.036E+01	3.658E-33
2.087E+01	7.510E-34
2.138E+01	1.470E-34
2.190E+01	2.736E-35
2.241E+01	4.840E-36
2.292E+01	8.128E-37
2.344E+01	1.294E-37
2.395E+01	1.951E-38
2.446E+01	2.782E-39
2.498E+01	3.746E-40
2.549E+01	4.762E-41
2.600E+01	5.708E-42
2.652E+01	6.456E-43
2.703E+01	6.915E-44
2.754E+01	7.092E-45
2.806E+01	7.162E-46
2.857E+01	7.562E-47
2.908E+01	9.123E-48
2.960E+01	1.330E-48
3.011E+01	2.257E-49
3.062E+01	4.100E-50

	3.113E+01	0.000E+00
	3.165E+01	0.000E+00
	3.216E+01	0.000E+00
	3.267E+01	0.000E+00
	3.319E+01	0.000E+00
	3.370E+01	0.000E+00
	3.421E+01	0.000E+00
	3.473E+01	0.000E+00
	3.524E+01	0.000E+00
	3.575E+01	0.000E+00
	3.627E+01	0.000E+00
	3.678E+01	0.000E+00
30	0.000E+00	1.000E+00
	5.560E-01	6.065E-01
	1.112E+00	3.016E-01
	1.668E+00	1.206E-01
	2.224E+00	3.825E-02
	2.780E+00	9.531E-03
	3.336E+00	1.853E-03
	3.892E+00	2.798E-04
	4.448E+00	3.269E-05
	5.004E+00	2.947E-06
	5.560E+00	2.045E-07
	6.116E+00	1.092E-08
	6.672E+00	4.483E-10
	7.228E+00	1.447E-11
	7.784E+00	5.023E-13
	8.340E+00	6.852E-14
	8.896E+00	2.234E-14
	9.452E+00	7.443E-15
	1.001E+01	2.327E-15
	1.056E+01	6.845E-16
	1.112E+01	2.097E-16
	1.163E+01	5.912E-17
	1.215E+01	1.563E-17
	1.266E+01	3.873E-18
	1.317E+01	8.968E-19
	1.369E+01	1.938E-19
	1.420E+01	3.901E-20
	1.471E+01	7.296E-21
	1.523E+01	1.265E-21
	1.574E+01	2.030E-22
	1.625E+01	3.005E-23
	1.677E+01	4.095E-24
	1.728E+01	5.125E-25
	1.779E+01	5.882E-26
	1.830E+01	6.199E-27
	1.882E+01	6.067E-28
	1.933E+01	5.773E-29
	1.984E+01	6.121E-30
	2.036E+01	8.987E-31
	2.087E+01	1.876E-31
	2.138E+01	4.583E-32
	2.190E+01	1.143E-32
	2.241E+01	2.779E-33
	2.292E+01	6.511E-34

	2.344E+01 2.395E+01 2.446E+01 2.498E+01 2.549E+01 2.600E+01 2.652E+01 2.703E+01 2.754E+01 2.806E+01 2.857E+01 2.908E+01 2.960E+01 3.011E+01 3.062E+01 3.113E+01 3.165E+01 3.216E+01 3.267E+01 3.319E+01 3.370E+01 3.421E+01 3.473E+01 3.524E+01 3.575E+01 3.627E+01 3.678E+01	1.465E-34 3.164E-35 6.548E-36 1.298E-36 2.460E-37 4.459E-38 7.718E-39 1.275E-39 2.007E-40 3.009E-41 4.298E-42 5.850E-43 7.610E-44 9.543E-45 1.177E-45 1.486E-46 2.053E-47 3.294E-48 6.145E-49 1.261E-49 2.678E-50 0.000E+00 0.000E+00 0.000E+00 0.000E+00 0.000E+00 0.000E+00
35	0.000E+00 5.560E-01 1.112E+00 1.668E+00 2.224E+00 2.780E+00 3.336E+00 3.892E+00 4.448E+00 5.004E+00 5.560E+00 6.116E+00 6.672E+00 7.228E+00 7.784E+00 8.340E+00 8.896E+00 9.452E+00 1.001E+01 1.056E+01 1.112E+01 1.163E+01 1.215E+01 1.266E+01 1.317E+01 1.369E+01 1.420E+01 1.471E+01 1.523E+01	1.000E+00 6.339E-01 3.394E-01 1.510E-01 5.523E-02 1.646E-02 3.974E-03 7.736E-04 1.210E-04 1.519E-05 1.525E-06 1.223E-07 7.833E-09 4.007E-10 1.668E-11 7.092E-13 8.908E-14 2.982E-14 1.094E-14 3.864E-15 1.428E-15 4.862E-16 1.570E-16 4.806E-17 1.393E-17 3.814E-18 9.860E-19 2.403E-19 5.510E-20

	1.574E+01 1.625E+01 1.677E+01 1.728E+01 1.779E+01 1.830E+01 1.882E+01 1.933E+01 1.984E+01 2.036E+01 2.087E+01 2.138E+01 2.190E+01 2.241E+01 2.292E+01 2.344E+01 2.395E+01 2.446E+01 2.498E+01 2.549E+01 2.600E+01 2.652E+01 2.703E+01 2.754E+01 2.806E+01 2.857E+01 2.908E+01 2.960E+01 3.011E+01 3.062E+01 3.113E+01 3.165E+01 3.216E+01 3.267E+01 3.319E+01 3.370E+01 3.421E+01 3.473E+01 3.524E+01 3.575E+01 3.627E+01 3.678E+01	1.187E-20 2.398E-21 4.535E-22 8.012E-23 1.320E-23 2.024E-24 2.883E-25 3.812E-26 4.689E-27 5.428E-28 6.151E-29 7.616E-30 1.231E-30 2.740E-31 7.276E-32 2.015E-32 5.513E-33 1.465E-33 3.766E-34 9.347E-35 2.238E-35 5.167E-36 1.149E-36 2.461E-37 5.069E-38 1.004E-38 1.910E-39 3.488E-40 6.111E-41 1.027E-41 1.655E-42 2.561E-43 3.823E-44 5.552E-45 8.006E-46 1.190E-46 1.925E-47 3.549E-48 7.455E-49 1.708E-49 4.062E-50 0.000E+00
40	0.000E+00 5.560E-01 1.112E+00 1.668E+00 2.224E+00 2.780E+00 3.336E+00 3.892E+00 4.448E+00 5.004E+00 5.560E+00 6.116E+00 6.672E+00 7.228E+00	1.000E+00 6.563E-01 3.719E-01 1.796E-01 7.315E-02 2.495E-02 7.088E-03 1.670E-03 3.255E-04 5.234E-05 6.932E-06 7.551E-07 6.757E-08 4.964E-09

7.784E+00	2.997E-10
8.340E+00	1.516E-11
8.896E+00	7.859E-13
9.452E+00	1.029E-13
1.001E+01	3.542E-14
1.056E+01	1.414E-14
1.112E+01	5.988E-15
1.163E+01	2.341E-15
1.215E+01	8.756E-16
1.266E+01	3.129E-16
1.317E+01	1.068E-16
1.369E+01	3.474E-17
1.420E+01	1.077E-17
1.471E+01	3.178E-18
1.523E+01	8.915E-19
1.574E+01	2.374E-19
1.625E+01	5.995E-20
1.677E+01	1.433E-20
1.728E+01	3.241E-21
1.779E+01	6.917E-22
1.830E+01	1.392E-22
1.882E+01	2.635E-23
1.933E+01	4.688E-24
1.984E+01	7.825E-25
2.036E+01	1.224E-25
2.087E+01	1.795E-26
2.138E+01	2.475E-27
2.190E+01	3.258E-28
2.241E+01	4.274E-29
2.292E+01	6.214E-30
2.344E+01	1.160E-30
2.395E+01	2.863E-31
2.446E+01	8.255E-32
2.498E+01	2.484E-32
2.549E+01	7.421E-33
2.600E+01	2.165E-33
2.652E+01	6.138E-34
2.703E+01	1.688E-34
2.754E+01	4.501E-35
2.806E+01	1.163E-35
2.857E+01	2.907E-36
2.908E+01	7.037E-37
2.960E+01	1.647E-37
3.011E+01	3.726E-38
3.062E+01	8.143E-39
3.113E+01	1.718E-39
3.165E+01	3.497E-40
3.216E+01	6.863E-41
3.267E+01	1.299E-41
3.319E+01	2.369E-42
3.370E+01	4.171E-43
3.421E+01	7.104E-44
3.473E+01	1.178E-44
3.524E+01	1.924E-45
3.575E+01	3.175E-46
3.627E+01	5.504E-47
3.678E+01	1.049E-47

45

0.000E+00	1.000E+00
5.560E-01	6.751E-01
1.112E+00	4.003E-01
1.668E+00	2.061E-01
2.224E+00	9.137E-02
2.780E+00	3.463E-02
3.336E+00	1.117E-02
3.892E+00	3.055E-03
4.448E+00	7.065E-04
5.004E+00	1.378E-04
5.560E+00	2.265E-05
6.116E+00	3.130E-06
6.672E+00	3.634E-07
7.228E+00	3.541E-08
7.784E+00	2.896E-09
8.340E+00	1.992E-10
8.896E+00	1.178E-11
9.452E+00	7.341E-13
1.001E+01	1.082E-13
1.056E+01	3.950E-14
1.112E+01	1.825E-14
1.163E+01	7.926E-15
1.215E+01	3.316E-15
1.266E+01	1.334E-15
1.317E+01	5.154E-16
1.369E+01	1.912E-16
1.420E+01	6.805E-17
1.471E+01	2.321E-17
1.523E+01	7.581E-18
1.574E+01	2.369E-18
1.625E+01	7.074E-19
1.677E+01	2.017E-19
1.728E+01	5.483E-20
1.779E+01	1.420E-20
1.830E+01	3.499E-21
1.882E+01	8.193E-22
1.933E+01	1.820E-22
1.984E+01	3.833E-23
2.036E+01	7.639E-24
2.087E+01	1.439E-24
2.138E+01	2.559E-25
2.190E+01	4.295E-26
2.241E+01	6.814E-27
2.292E+01	1.028E-27
2.344E+01	1.507E-28
2.395E+01	2.264E-29
2.446E+01	3.893E-30
2.498E+01	8.580E-31
2.549E+01	2.386E-31
2.600E+01	7.468E-32
2.652E+01	2.410E-32
2.703E+01	7.715E-33
2.754E+01	2.419E-33
2.806E+01	7.394E-34
2.857E+01	2.200E-34
2.908E+01	6.370E-35

	2.960E+01 3.011E+01 3.062E+01 3.113E+01 3.165E+01 3.216E+01 3.267E+01 3.319E+01 3.370E+01 3.421E+01 3.473E+01 3.524E+01 3.575E+01 3.627E+01 3.678E+01	1.793E-35 4.905E-36 1.304E-36 3.364E-37 8.423E-38 2.046E-38 4.817E-39 1.099E-39 2.429E-40 5.196E-41 1.076E-41 2.157E-42 4.190E-43 7.904E-44 1.455E-44
50	0.000E+00 5.560E-01 1.112E+00 1.668E+00 2.224E+00 2.780E+00 3.336E+00 3.892E+00 4.448E+00 5.004E+00 5.560E+00 6.116E+00 6.672E+00 7.228E+00 7.784E+00 8.340E+00 8.896E+00 9.452E+00 1.001E+01 1.056E+01 1.112E+01 1.163E+01 1.215E+01 1.266E+01 1.317E+01 1.369E+01 1.420E+01 1.471E+01 1.523E+01 1.574E+01 1.625E+01 1.677E+01 1.728E+01 1.779E+01 1.830E+01 1.882E+01 1.933E+01 1.984E+01 2.036E+01 2.087E+01 2.138E+01	1.000E+00 6.912E-01 4.254E-01 2.307E-01 1.095E-01 4.518E-02 1.614E-02 4.973E-03 1.319E-03 3.004E-04 5.866E-05 9.807E-06 1.403E-06 1.714E-07 1.790E-08 1.596E-09 1.219E-10 8.211E-12 6.119E-13 1.075E-13 4.534E-14 2.104E-14 9.601E-15 4.239E-15 1.807E-15 7.432E-16 2.947E-16 1.126E-16 4.144E-17 1.467E-17 4.992E-18 1.632E-18 5.120E-19 1.541E-19 4.440E-20 1.225E-20 3.230E-21 8.134E-22 1.954E-22 4.473E-23 9.745E-24

	2.190E+01 2.241E+01 2.292E+01 2.344E+01 2.395E+01 2.446E+01 2.498E+01 2.549E+01 2.600E+01 2.652E+01 2.703E+01 2.754E+01 2.806E+01 2.857E+01 2.908E+01 2.960E+01 3.011E+01 3.062E+01 3.113E+01 3.165E+01 3.216E+01 3.267E+01 3.319E+01 3.370E+01 3.421E+01 3.473E+01 3.524E+01 3.575E+01 3.627E+01 3.678E+01	2.018E-24 3.971E-25 7.414E-26 1.315E-26 2.223E-27 3.624E-28 5.878E-29 1.018E-29 2.101E-30 5.493E-31 1.714E-31 5.776E-32 1.977E-32 6.695E-33 2.223E-33 7.211E-34 2.284E-34 7.055E-35 2.125E-35 6.240E-36 1.785E-36 4.974E-37 1.349E-37 3.560E-38 9.139E-39 2.281E-39 5.531E-40 1.303E-40 2.982E-41 6.627E-42
55	0.000E+00 5.560E-01 1.112E+00 1.668E+00 2.224E+00 2.780E+00 3.336E+00 3.892E+00 4.448E+00 5.004E+00 5.560E+00 6.116E+00 6.672E+00 7.228E+00 7.784E+00 8.340E+00 8.896E+00 9.452E+00 1.001E+01 1.056E+01 1.112E+01 1.163E+01 1.215E+01 1.266E+01 1.317E+01 1.369E+01	1.000E+00 7.052E-01 4.476E-01 2.535E-01 1.273E-01 5.631E-02 2.187E-02 7.434E-03 2.206E-03 5.703E-04 1.283E-04 2.507E-05 4.252E-06 6.255E-07 7.976E-08 8.810E-09 8.434E-10 7.031E-11 5.313E-12 4.781E-13 1.109E-13 4.773E-14 2.295E-14 1.090E-14 5.031E-15 2.249E-15

1.420E+01	9.731E-16
1.471E+01	4.074E-16
1.523E+01	1.650E-16
1.574E+01	6.455E-17
1.625E+01	2.439E-17
1.677E+01	8.897E-18
1.728E+01	3.130E-18
1.779E+01	1.061E-18
1.830E+01	3.465E-19
1.882E+01	1.089E-19
1.933E+01	3.289E-20
1.984E+01	9.546E-21
2.036E+01	2.659E-21
2.087E+01	7.102E-22
2.138E+01	1.817E-22
2.190E+01	4.448E-23
2.241E+01	1.041E-23
2.292E+01	2.328E-24
2.344E+01	4.966E-25
2.395E+01	1.010E-25
2.446E+01	1.961E-26
2.498E+01	3.641E-27
2.549E+01	6.513E-28
2.600E+01	1.146E-28
2.652E+01	2.079E-29
2.703E+01	4.245E-30
2.754E+01	1.062E-30
2.806E+01	3.246E-31
2.857E+01	1.116E-31
2.908E+01	3.999E-32
2.960E+01	1.437E-32
3.011E+01	5.093E-33
3.062E+01	1.771E-33
3.113E+01	6.031E-34
3.165E+01	2.008E-34
3.216E+01	6.539E-35
3.267E+01	2.081E-35
3.319E+01	6.468E-36
3.370E+01	1.964E-36
3.421E+01	5.820E-37
3.473E+01	1.683E-37
3.524E+01	4.750E-38
3.575E+01	1.307E-38
3.627E+01	3.506E-39
3.678E+01	9.164E-40

NOTICE

Although this program has been tested and experience would indicate that it is accurate within the limits given by the assumptions of the theory used, we make no warranty as to workability of this software or any other licensed material. No warranties either expressed or implied (including warranties of fitness) shall apply. No responsibility is assumed for any errors, mistakes or misrepresentations that may occur from the use of this computer program. The user accepts full responsibility for assessing the validity and applicability of the results obtained with this program for any specific case.

POLLUTEv7

Version 7.13

Copyright (c) 2007.
GAEA Technologies Ltd., R.K. Rowe and J.R. Booker

DB ClayPoro Low

THE DARCY VELOCITY (Flux) THROUGH THE LAYERS $V_a = 0.000203$ m/year

Layer Properties

Layer	Thickness	Number of Sublayers	Coefficient of Hydrodynamic Dispersion	Matrix Porosity	Distribution Coefficient	Dry Density
Clay	11.12 m	20	0.019 m ² /a	0.28	0 m ³ /kg	1510 kg/m ³
Clay with Sand	25.66 m	50	0.019 m ² /a	0.34	0 m ³ /kg	1510 kg/m ³

Boundary Conditions

Constant Concentration

Source Concentration = 1 mg/L

Infinite Thickness Bottom Boundary

Laplace Transform Parameters

TAU = 7 N = 20 SIG = 0 RNU = 2

Calculated Concentrations at Selected Times and Depths

Time year	Depth m	Concentration mg/L	
5	0.000E+00	1.000E+00	
	5.560E-01	2.043E-01	
	1.112E+00	1.097E-02	
	1.668E+00	1.341E-04	
	2.224E+00	3.503E-07	

2.780E+00	1.902E-10
3.336E+00	1.021E-13
3.892E+00	6.065E-15
4.448E+00	3.009E-16
5.004E+00	9.671E-18
5.560E+00	1.954E-19
6.116E+00	2.395E-21
6.672E+00	1.709E-23
7.228E+00	6.794E-26
7.784E+00	1.525E-28
8.340E+00	5.541E-31
8.896E+00	1.177E-32
9.452E+00	2.567E-34
1.001E+01	4.212E-36
1.056E+01	5.092E-38
1.112E+01	4.027E-40
1.163E+01	3.755E-42
1.215E+01	2.634E-44
1.266E+01	1.578E-46
1.317E+01	1.469E-48
1.369E+01	2.874E-50
1.420E+01	0.000E+00
1.471E+01	0.000E+00
1.523E+01	0.000E+00
1.574E+01	0.000E+00
1.625E+01	0.000E+00
1.677E+01	0.000E+00
1.728E+01	0.000E+00
1.779E+01	0.000E+00
1.830E+01	0.000E+00
1.882E+01	0.000E+00
1.933E+01	0.000E+00
1.984E+01	0.000E+00
2.036E+01	0.000E+00
2.087E+01	0.000E+00
2.138E+01	0.000E+00
2.190E+01	0.000E+00
2.241E+01	0.000E+00
2.292E+01	0.000E+00
2.344E+01	0.000E+00
2.395E+01	0.000E+00
2.446E+01	0.000E+00
2.498E+01	0.000E+00
2.549E+01	0.000E+00
2.600E+01	0.000E+00
2.652E+01	0.000E+00
2.703E+01	0.000E+00
2.754E+01	0.000E+00
2.806E+01	0.000E+00
2.857E+01	0.000E+00
2.908E+01	0.000E+00
2.960E+01	0.000E+00
3.011E+01	0.000E+00
3.062E+01	0.000E+00
3.113E+01	0.000E+00
3.165E+01	0.000E+00
3.216E+01	0.000E+00

	3.267E+01	0.000E+00
	3.319E+01	0.000E+00
	3.370E+01	0.000E+00
	3.421E+01	0.000E+00
	3.473E+01	0.000E+00
	3.524E+01	0.000E+00
	3.575E+01	0.000E+00
	3.627E+01	0.000E+00
	3.678E+01	0.000E+00
10	0.000E+00	1.000E+00
	5.560E-01	3.710E-01
	1.112E+00	7.277E-02
	1.668E+00	7.033E-03
	2.224E+00	3.222E-04
	2.780E+00	6.843E-06
	3.336E+00	6.653E-08
	3.892E+00	2.943E-10
	4.448E+00	7.698E-13
	5.004E+00	3.453E-14
	5.560E+00	5.123E-15
	6.116E+00	6.286E-16
	6.672E+00	6.228E-17
	7.228E+00	4.932E-18
	7.784E+00	3.087E-19
	8.340E+00	1.509E-20
	8.896E+00	5.672E-22
	9.452E+00	1.616E-23
	1.001E+01	3.433E-25
	1.056E+01	5.387E-27
	1.112E+01	6.026E-29
	1.163E+01	1.401E-30
	1.215E+01	8.782E-32
	1.266E+01	7.825E-33
	1.317E+01	6.540E-34
	1.369E+01	4.856E-35
	1.420E+01	3.179E-36
	1.471E+01	1.826E-37
	1.523E+01	9.165E-39
	1.574E+01	3.998E-40
	1.625E+01	1.509E-41
	1.677E+01	4.924E-43
	1.728E+01	1.405E-44
	1.779E+01	3.742E-46
	1.830E+01	1.158E-47
	1.882E+01	5.494E-49
	1.933E+01	3.556E-50
	1.984E+01	0.000E+00
	2.036E+01	0.000E+00
	2.087E+01	0.000E+00
	2.138E+01	0.000E+00
	2.190E+01	0.000E+00
	2.241E+01	0.000E+00
	2.292E+01	0.000E+00
	2.344E+01	0.000E+00
	2.395E+01	0.000E+00
	2.446E+01	0.000E+00

	2.498E+01	0.000E+00
	2.549E+01	0.000E+00
	2.600E+01	0.000E+00
	2.652E+01	0.000E+00
	2.703E+01	0.000E+00
	2.754E+01	0.000E+00
	2.806E+01	0.000E+00
	2.857E+01	0.000E+00
	2.908E+01	0.000E+00
	2.960E+01	0.000E+00
	3.011E+01	0.000E+00
	3.062E+01	0.000E+00
	3.113E+01	0.000E+00
	3.165E+01	0.000E+00
	3.216E+01	0.000E+00
	3.267E+01	0.000E+00
	3.319E+01	0.000E+00
	3.370E+01	0.000E+00
	3.421E+01	0.000E+00
	3.473E+01	0.000E+00
	3.524E+01	0.000E+00
	3.575E+01	0.000E+00
	3.627E+01	0.000E+00
	3.678E+01	0.000E+00
15	0.000E+00	1.000E+00
	5.560E-01	4.664E-01
	1.112E+00	1.438E-01
	1.668E+00	2.803E-02
	2.224E+00	3.361E-03
	2.780E+00	2.438E-04
	3.336E+00	1.058E-05
	3.892E+00	2.730E-07
	4.448E+00	4.167E-09
	5.004E+00	3.796E-11
	5.560E+00	3.426E-13
	6.116E+00	3.652E-14
	6.672E+00	7.812E-15
	7.228E+00	1.484E-15
	7.784E+00	2.450E-16
	8.340E+00	3.497E-17
	8.896E+00	4.292E-18
	9.452E+00	4.501E-19
	1.001E+01	4.006E-20
	1.056E+01	3.003E-21
	1.112E+01	1.699E-22
	1.163E+01	1.112E-23
	1.215E+01	6.160E-25
	1.266E+01	2.871E-26
	1.317E+01	1.133E-27
	1.369E+01	4.074E-29
	1.420E+01	1.885E-30
	1.471E+01	1.760E-31
	1.523E+01	2.390E-32
	1.574E+01	3.291E-33
	1.625E+01	4.234E-34
	1.677E+01	5.024E-35

	9.452E+00	6.241E-17
	1.001E+01	1.063E-17
	1.056E+01	1.611E-18
	1.112E+01	1.962E-19
	1.163E+01	2.753E-20
	1.215E+01	3.460E-21
	1.266E+01	3.879E-22
	1.317E+01	3.860E-23
	1.369E+01	3.396E-24
	1.420E+01	2.630E-25
	1.471E+01	1.788E-26
	1.523E+01	1.076E-27
	1.574E+01	6.031E-29
	1.625E+01	3.884E-30
	1.677E+01	4.128E-31
	1.728E+01	6.769E-32
	1.779E+01	1.233E-32
	1.830E+01	2.186E-33
	1.882E+01	3.667E-34
	1.933E+01	5.788E-35
	1.984E+01	8.579E-36
	2.036E+01	1.192E-36
	2.087E+01	1.550E-37
	2.138E+01	1.884E-38
	2.190E+01	2.135E-39
	2.241E+01	2.254E-40
	2.292E+01	2.212E-41
	2.344E+01	2.018E-42
	2.395E+01	1.714E-43
	2.446E+01	1.368E-44
	2.498E+01	1.054E-45
	2.549E+01	8.390E-47
	2.600E+01	7.767E-48
	2.652E+01	9.083E-49
	2.703E+01	1.270E-49
	2.754E+01	1.898E-50
	2.806E+01	0.000E+00
	2.857E+01	0.000E+00
	2.908E+01	0.000E+00
	2.960E+01	0.000E+00
	3.011E+01	0.000E+00
	3.062E+01	0.000E+00
	3.113E+01	0.000E+00
	3.165E+01	0.000E+00
	3.216E+01	0.000E+00
	3.267E+01	0.000E+00
	3.319E+01	0.000E+00
	3.370E+01	0.000E+00
	3.421E+01	0.000E+00
	3.473E+01	0.000E+00
	3.524E+01	0.000E+00
	3.575E+01	0.000E+00
	3.627E+01	0.000E+00
	3.678E+01	0.000E+00
25	0.000E+00	1.000E+00
	5.560E-01	5.744E-01

1.112E+00
1.668E+00
2.224E+00
2.780E+00
3.336E+00
3.892E+00
4.448E+00
5.004E+00
5.560E+00
6.116E+00
6.672E+00
7.228E+00
7.784E+00
8.340E+00
8.896E+00
9.452E+00
1.001E+01
1.056E+01
1.112E+01
1.163E+01
1.215E+01
1.266E+01
1.317E+01
1.369E+01
1.420E+01
1.471E+01
1.523E+01
1.574E+01
1.625E+01
1.677E+01
1.728E+01
1.779E+01
1.830E+01
1.882E+01
1.933E+01
1.984E+01
2.036E+01
2.087E+01
2.138E+01
2.190E+01
2.241E+01
2.292E+01
2.344E+01
2.395E+01
2.446E+01
2.498E+01
2.549E+01
2.600E+01
2.652E+01
2.703E+01
2.754E+01
2.806E+01
2.857E+01
2.908E+01
2.960E+01
3.011E+01
3.062E+01

2.593E-01
8.982E-02
2.347E-02
4.577E-03
6.608E-04
7.023E-05
5.474E-06
3.120E-07
1.298E-08
3.941E-10
9.033E-12
2.748E-13
4.812E-14
1.472E-14
4.290E-15
1.153E-15
2.845E-16
6.415E-17
1.203E-17
2.585E-18
5.120E-19
9.329E-20
1.559E-20
2.384E-21
3.323E-22
4.212E-23
4.837E-24
5.017E-25
4.690E-26
3.960E-27
3.072E-28
2.363E-29
2.243E-30
3.319E-31
6.714E-32
1.466E-32
3.141E-33
6.449E-34
1.262E-34
2.349E-35
4.156E-36
6.980E-37
1.111E-37
1.675E-38
2.389E-39
3.217E-40
4.089E-41
4.901E-42
5.544E-43
5.938E-44
6.090E-45
6.150E-46
6.494E-47
7.834E-48
1.142E-48
1.938E-49
3.520E-50

	3.113E+01	0.000E+00
	3.165E+01	0.000E+00
	3.216E+01	0.000E+00
	3.267E+01	0.000E+00
	3.319E+01	0.000E+00
	3.370E+01	0.000E+00
	3.421E+01	0.000E+00
	3.473E+01	0.000E+00
	3.524E+01	0.000E+00
	3.575E+01	0.000E+00
	3.627E+01	0.000E+00
	3.678E+01	0.000E+00
30	0.000E+00	1.000E+00
	5.560E-01	6.089E-01
	1.112E+00	3.040E-01
	1.668E+00	1.220E-01
	2.224E+00	3.886E-02
	2.780E+00	9.723E-03
	3.336E+00	1.898E-03
	3.892E+00	2.877E-04
	4.448E+00	3.375E-05
	5.004E+00	3.054E-06
	5.560E+00	2.129E-07
	6.116E+00	1.141E-08
	6.672E+00	4.703E-10
	7.228E+00	1.524E-11
	7.784E+00	5.311E-13
	8.340E+00	7.273E-14
	8.896E+00	2.381E-14
	9.452E+00	7.964E-15
	1.001E+01	2.497E-15
	1.056E+01	7.266E-16
	1.112E+01	1.801E-16
	1.163E+01	5.076E-17
	1.215E+01	1.342E-17
	1.266E+01	3.325E-18
	1.317E+01	7.700E-19
	1.369E+01	1.664E-19
	1.420E+01	3.350E-20
	1.471E+01	6.265E-21
	1.523E+01	1.087E-21
	1.574E+01	1.743E-22
	1.625E+01	2.581E-23
	1.677E+01	3.517E-24
	1.728E+01	4.401E-25
	1.779E+01	5.051E-26
	1.830E+01	5.323E-27
	1.882E+01	5.210E-28
	1.933E+01	4.958E-29
	1.984E+01	5.256E-30
	2.036E+01	7.717E-31
	2.087E+01	1.611E-31
	2.138E+01	3.935E-32
	2.190E+01	9.812E-33
	2.241E+01	2.386E-33
	2.292E+01	5.591E-34

	2.344E+01 2.395E+01 2.446E+01 2.498E+01 2.549E+01 2.600E+01 2.652E+01 2.703E+01 2.754E+01 2.806E+01 2.857E+01 2.908E+01 2.960E+01 3.011E+01 3.062E+01 3.113E+01 3.165E+01 3.216E+01 3.267E+01 3.319E+01 3.370E+01 3.421E+01 3.473E+01 3.524E+01 3.575E+01 3.627E+01 3.678E+01	1.258E-34 2.717E-35 5.622E-36 1.114E-36 2.113E-37 3.829E-38 6.628E-39 1.095E-39 1.723E-40 2.584E-41 3.691E-42 5.023E-43 6.535E-44 8.195E-45 1.010E-45 1.276E-46 1.763E-47 2.828E-48 5.277E-49 1.083E-49 2.300E-50 0.000E+00 0.000E+00 0.000E+00 0.000E+00 0.000E+00 0.000E+00
35	0.000E+00 5.560E-01 1.112E+00 1.668E+00 2.224E+00 2.780E+00 3.336E+00 3.892E+00 4.448E+00 5.004E+00 5.560E+00 6.116E+00 6.672E+00 7.228E+00 7.784E+00 8.340E+00 8.896E+00 9.452E+00 1.001E+01 1.056E+01 1.112E+01 1.163E+01 1.215E+01 1.266E+01 1.317E+01 1.369E+01 1.420E+01 1.471E+01 1.523E+01	1.000E+00 6.364E-01 3.421E-01 1.528E-01 5.612E-02 1.679E-02 4.070E-03 7.955E-04 1.250E-04 1.574E-05 1.587E-06 1.278E-07 8.218E-09 4.221E-10 1.764E-11 7.530E-13 9.493E-14 3.190E-14 1.172E-14 4.070E-15 1.226E-15 4.174E-16 1.348E-16 4.126E-17 1.196E-17 3.275E-18 8.466E-19 2.063E-19 4.731E-20

	1.574E+01 1.625E+01 1.677E+01 1.728E+01 1.779E+01 1.830E+01 1.882E+01 1.933E+01 1.984E+01 2.036E+01 2.087E+01 2.138E+01 2.190E+01 2.241E+01 2.292E+01 2.344E+01 2.395E+01 2.446E+01 2.498E+01 2.549E+01 2.600E+01 2.652E+01 2.703E+01 2.754E+01 2.806E+01 2.857E+01 2.908E+01 2.960E+01 3.011E+01 3.062E+01 3.113E+01 3.165E+01 3.216E+01 3.267E+01 3.319E+01 3.370E+01 3.421E+01 3.473E+01 3.524E+01 3.575E+01 3.627E+01 3.678E+01	1.019E-20 2.059E-21 3.894E-22 6.880E-23 1.133E-23 1.738E-24 2.475E-25 3.273E-26 4.027E-27 4.661E-28 5.282E-29 6.539E-30 1.057E-30 2.353E-31 6.247E-32 1.730E-32 4.733E-33 1.258E-33 3.233E-34 8.025E-35 1.922E-35 4.436E-36 9.867E-37 2.113E-37 4.352E-38 8.620E-39 1.640E-39 2.995E-40 5.248E-41 8.817E-42 1.421E-42 2.200E-43 3.283E-44 4.768E-45 6.875E-46 1.022E-46 1.653E-47 3.047E-48 6.401E-49 1.467E-49 3.487E-50 0.000E+00
40	0.000E+00 5.560E-01 1.112E+00 1.668E+00 2.224E+00 2.780E+00 3.336E+00 3.892E+00 4.448E+00 5.004E+00 5.560E+00 6.116E+00 6.672E+00 7.228E+00	1.000E+00 6.589E-01 3.749E-01 1.817E-01 7.432E-02 2.545E-02 7.259E-03 1.717E-03 3.361E-04 5.426E-05 7.215E-06 7.890E-07 7.089E-08 5.228E-09

7.784E+00	3.170E-10
8.340E+00	1.610E-11
8.896E+00	8.377E-13
9.452E+00	1.101E-13
1.001E+01	3.789E-14
1.056E+01	1.477E-14
1.112E+01	5.141E-15
1.163E+01	2.010E-15
1.215E+01	7.517E-16
1.266E+01	2.686E-16
1.317E+01	9.166E-17
1.369E+01	2.983E-17
1.420E+01	9.248E-18
1.471E+01	2.729E-18
1.523E+01	7.655E-19
1.574E+01	2.039E-19
1.625E+01	5.148E-20
1.677E+01	1.231E-20
1.728E+01	2.783E-21
1.779E+01	5.940E-22
1.830E+01	1.195E-22
1.882E+01	2.263E-23
1.933E+01	4.026E-24
1.984E+01	6.720E-25
2.036E+01	1.051E-25
2.087E+01	1.541E-26
2.138E+01	2.126E-27
2.190E+01	2.798E-28
2.241E+01	3.670E-29
2.292E+01	5.336E-30
2.344E+01	9.959E-31
2.395E+01	2.458E-31
2.446E+01	7.088E-32
2.498E+01	2.133E-32
2.549E+01	6.371E-33
2.600E+01	1.859E-33
2.652E+01	5.270E-34
2.703E+01	1.449E-34
2.754E+01	3.864E-35
2.806E+01	9.982E-36
2.857E+01	2.496E-36
2.908E+01	6.042E-37
2.960E+01	1.414E-37
3.011E+01	3.199E-38
3.062E+01	6.992E-39
3.113E+01	1.475E-39
3.165E+01	3.002E-40
3.216E+01	5.893E-41
3.267E+01	1.115E-41
3.319E+01	2.035E-42
3.370E+01	3.582E-43
3.421E+01	6.100E-44
3.473E+01	1.011E-44
3.524E+01	1.652E-45
3.575E+01	2.727E-46
3.627E+01	4.726E-47
3.678E+01	9.008E-48

45

0.000E+00	1.000E+00
5.560E-01	6.778E-01
1.112E+00	4.035E-01
1.668E+00	2.086E-01
2.224E+00	9.283E-02
2.780E+00	3.533E-02
3.336E+00	1.144E-02
3.892E+00	3.142E-03
4.448E+00	7.294E-04
5.004E+00	1.429E-04
5.560E+00	2.357E-05
6.116E+00	3.270E-06
6.672E+00	3.812E-07
7.228E+00	3.730E-08
7.784E+00	3.063E-09
8.340E+00	2.115E-10
8.896E+00	1.256E-11
9.452E+00	7.854E-13
1.001E+01	1.156E-13
1.056E+01	4.097E-14
1.112E+01	1.567E-14
1.163E+01	6.804E-15
1.215E+01	2.846E-15
1.266E+01	1.145E-15
1.317E+01	4.425E-16
1.369E+01	1.642E-16
1.420E+01	5.842E-17
1.471E+01	1.993E-17
1.523E+01	6.509E-18
1.574E+01	2.034E-18
1.625E+01	6.073E-19
1.677E+01	1.732E-19
1.728E+01	4.708E-20
1.779E+01	1.219E-20
1.830E+01	3.005E-21
1.882E+01	7.035E-22
1.933E+01	1.563E-22
1.984E+01	3.292E-23
2.036E+01	6.560E-24
2.087E+01	1.236E-24
2.138E+01	2.197E-25
2.190E+01	3.689E-26
2.241E+01	5.851E-27
2.292E+01	8.830E-28
2.344E+01	1.294E-28
2.395E+01	1.944E-29
2.446E+01	3.343E-30
2.498E+01	7.366E-31
2.549E+01	2.048E-31
2.600E+01	6.411E-32
2.652E+01	2.069E-32
2.703E+01	6.624E-33
2.754E+01	2.077E-33
2.806E+01	6.348E-34
2.857E+01	1.889E-34
2.908E+01	5.469E-35

	2.960E+01 3.011E+01 3.062E+01 3.113E+01 3.165E+01 3.216E+01 3.267E+01 3.319E+01 3.370E+01 3.421E+01 3.473E+01 3.524E+01 3.575E+01 3.627E+01 3.678E+01	1.539E-35 4.212E-36 1.119E-36 2.888E-37 7.232E-38 1.756E-38 4.136E-39 9.437E-40 2.085E-40 4.462E-41 9.240E-42 1.852E-42 3.598E-43 6.787E-44 1.249E-44
50	0.000E+00 5.560E-01 1.112E+00 1.668E+00 2.224E+00 2.780E+00 3.336E+00 3.892E+00 4.448E+00 5.004E+00 5.560E+00 6.116E+00 6.672E+00 7.228E+00 7.784E+00 8.340E+00 8.896E+00 9.452E+00 1.001E+01 1.056E+01 1.112E+01 1.163E+01 1.215E+01 1.266E+01 1.317E+01 1.369E+01 1.420E+01 1.471E+01 1.523E+01 1.574E+01 1.625E+01 1.677E+01 1.728E+01 1.779E+01 1.830E+01 1.882E+01 1.933E+01 1.984E+01 2.036E+01 2.087E+01 2.138E+01	1.000E+00 6.939E-01 4.288E-01 2.335E-01 1.112E-01 4.608E-02 1.653E-02 5.114E-03 1.362E-03 3.114E-04 6.104E-05 1.025E-05 1.471E-06 1.806E-07 1.893E-08 1.694E-09 1.299E-10 8.787E-12 6.556E-13 1.115E-13 3.891E-14 1.806E-14 8.241E-15 3.639E-15 1.551E-15 6.380E-16 2.530E-16 9.668E-17 3.557E-17 1.259E-17 4.286E-18 1.401E-18 4.396E-19 1.323E-19 3.812E-20 1.052E-20 2.773E-21 6.984E-22 1.678E-22 3.841E-23 8.368E-24

	2.190E+01 2.241E+01 2.292E+01 2.344E+01 2.395E+01 2.446E+01 2.498E+01 2.549E+01 2.600E+01 2.652E+01 2.703E+01 2.754E+01 2.806E+01 2.857E+01 2.908E+01 2.960E+01 3.011E+01 3.062E+01 3.113E+01 3.165E+01 3.216E+01 3.267E+01 3.319E+01 3.370E+01 3.421E+01 3.473E+01 3.524E+01 3.575E+01 3.627E+01 3.678E+01	1.733E-24 3.409E-25 6.367E-26 1.129E-26 1.909E-27 3.112E-28 5.048E-29 8.745E-30 1.804E-30 4.716E-31 1.471E-31 4.959E-32 1.697E-32 5.748E-33 1.908E-33 6.191E-34 1.961E-34 6.057E-35 1.825E-35 5.358E-36 1.533E-36 4.270E-37 1.158E-37 3.057E-38 7.846E-39 1.958E-39 4.749E-40 1.119E-40 2.561E-41 5.690E-42
55	0.000E+00 5.560E-01 1.112E+00 1.668E+00 2.224E+00 2.780E+00 3.336E+00 3.892E+00 4.448E+00 5.004E+00 5.560E+00 6.116E+00 6.672E+00 7.228E+00 7.784E+00 8.340E+00 8.896E+00 9.452E+00 1.001E+01 1.056E+01 1.112E+01 1.163E+01 1.215E+01 1.266E+01 1.317E+01 1.369E+01	1.000E+00 7.079E-01 4.512E-01 2.566E-01 1.293E-01 5.744E-02 2.240E-02 7.644E-03 2.277E-03 5.911E-04 1.335E-04 2.619E-05 4.460E-06 6.588E-07 8.434E-08 9.354E-09 8.990E-10 7.524E-11 5.704E-12 5.058E-13 9.520E-14 4.096E-14 1.970E-14 9.359E-15 4.318E-15 1.930E-15

1.420E+01	8.353E-16
1.471E+01	3.498E-16
1.523E+01	1.416E-16
1.574E+01	5.541E-17
1.625E+01	2.094E-17
1.677E+01	7.638E-18
1.728E+01	2.687E-18
1.779E+01	9.111E-19
1.830E+01	2.975E-19
1.882E+01	9.348E-20
1.933E+01	2.824E-20
1.984E+01	8.196E-21
2.036E+01	2.283E-21
2.087E+01	6.098E-22
2.138E+01	1.560E-22
2.190E+01	3.819E-23
2.241E+01	8.940E-24
2.292E+01	1.999E-24
2.344E+01	4.264E-25
2.395E+01	8.675E-26
2.446E+01	1.684E-26
2.498E+01	3.126E-27
2.549E+01	5.592E-28
2.600E+01	9.837E-29
2.652E+01	1.785E-29
2.703E+01	3.645E-30
2.754E+01	9.118E-31
2.806E+01	2.786E-31
2.857E+01	9.579E-32
2.908E+01	3.433E-32
2.960E+01	1.233E-32
3.011E+01	4.372E-33
3.062E+01	1.521E-33
3.113E+01	5.177E-34
3.165E+01	1.724E-34
3.216E+01	5.614E-35
3.267E+01	1.786E-35
3.319E+01	5.553E-36
3.370E+01	1.686E-36
3.421E+01	4.997E-37
3.473E+01	1.445E-37
3.524E+01	4.078E-38
3.575E+01	1.122E-38
3.627E+01	3.010E-39
3.678E+01	7.868E-40

NOTICE

Although this program has been tested and experience would indicate that it is accurate within the limits given by the assumptions of the theory used, we make no warranty as to workability of this software or any other licensed material. No warranties either expressed or implied (including warranties of fitness) shall apply. No responsibility is assumed for any errors, mistakes or misrepresentations that may occur from the use of this computer program. The user accepts full responsibility for assessing the validity and applicability of the results obtained with this program for any specific case.

POLLUTEv7

Version 7.13

Copyright (c) 2007.

GAEA Technologies Ltd., R.K. Rowe and J.R. Booker

DB SandPoro High

THE DARCY VELOCITY (Flux) THROUGH THE LAYERS $V_a = 0.000203$ m/year

Layer Properties

Layer	Thickness	Number of Sublayers	Coefficient of Hydrodynamic Dispersion	Matrix Porosity	Distribution Coefficient	Dry Density
Clay	11.12 m	20	0.019 m ² /a	0.37	0 m ³ /kg	1510 kg/m ³
Clay with Sand	25.66 m	50	0.019 m ² /a	0.45	0 m ³ /kg	1510 kg/m ³

Boundary Conditions

Constant Concentration

Source Concentration = 1 mg/L

Infinite Thickness Bottom Boundary

Laplace Transform Parameters

TAU = 7 N = 20 SIG = 0 RNU = 2

Calculated Concentrations at Selected Times and Depths

Time year	Depth m	Concentration mg/L
5	0.000E+00	1.000E+00
	5.560E-01	2.037E-01
	1.112E+00	1.091E-02
	1.668E+00	1.331E-04
	2.224E+00	3.467E-07

2.780E+00	1.878E-10
3.336E+00	1.005E-13
3.892E+00	5.956E-15
4.448E+00	2.947E-16
5.004E+00	9.449E-18
5.560E+00	1.904E-19
6.116E+00	2.329E-21
6.672E+00	1.657E-23
7.228E+00	6.570E-26
7.784E+00	1.471E-28
8.340E+00	5.331E-31
8.896E+00	1.130E-32
9.452E+00	2.457E-34
1.001E+01	4.021E-36
1.056E+01	4.849E-38
1.112E+01	3.821E-40
1.163E+01	3.556E-42
1.215E+01	2.489E-44
1.266E+01	1.489E-46
1.317E+01	1.384E-48
1.369E+01	2.701E-50
1.420E+01	0.000E+00
1.471E+01	0.000E+00
1.523E+01	0.000E+00
1.574E+01	0.000E+00
1.625E+01	0.000E+00
1.677E+01	0.000E+00
1.728E+01	0.000E+00
1.779E+01	0.000E+00
1.830E+01	0.000E+00
1.882E+01	0.000E+00
1.933E+01	0.000E+00
1.984E+01	0.000E+00
2.036E+01	0.000E+00
2.087E+01	0.000E+00
2.138E+01	0.000E+00
2.190E+01	0.000E+00
2.241E+01	0.000E+00
2.292E+01	0.000E+00
2.344E+01	0.000E+00
2.395E+01	0.000E+00
2.446E+01	0.000E+00
2.498E+01	0.000E+00
2.549E+01	0.000E+00
2.600E+01	0.000E+00
2.652E+01	0.000E+00
2.703E+01	0.000E+00
2.754E+01	0.000E+00
2.806E+01	0.000E+00
2.857E+01	0.000E+00
2.908E+01	0.000E+00
2.960E+01	0.000E+00
3.011E+01	0.000E+00
3.062E+01	0.000E+00
3.113E+01	0.000E+00
3.165E+01	0.000E+00
3.216E+01	0.000E+00

	3.267E+01	0.000E+00
	3.319E+01	0.000E+00
	3.370E+01	0.000E+00
	3.421E+01	0.000E+00
	3.473E+01	0.000E+00
	3.524E+01	0.000E+00
	3.575E+01	0.000E+00
	3.627E+01	0.000E+00
	3.678E+01	0.000E+00
10	0.000E+00	1.000E+00
	5.560E-01	3.700E-01
	1.112E+00	7.240E-02
	1.668E+00	6.979E-03
	2.224E+00	3.189E-04
	2.780E+00	6.756E-06
	3.336E+00	6.551E-08
	3.892E+00	2.891E-10
	4.448E+00	7.541E-13
	5.004E+00	3.374E-14
	5.560E+00	4.993E-15
	6.116E+00	6.111E-16
	6.672E+00	6.039E-17
	7.228E+00	4.770E-18
	7.784E+00	2.978E-19
	8.340E+00	1.451E-20
	8.896E+00	5.443E-22
	9.452E+00	1.547E-23
	1.001E+01	3.277E-25
	1.056E+01	5.130E-27
	1.112E+01	5.718E-29
	1.163E+01	1.327E-30
	1.215E+01	8.302E-32
	1.266E+01	7.383E-33
	1.317E+01	6.158E-34
	1.369E+01	4.564E-35
	1.420E+01	2.982E-36
	1.471E+01	1.710E-37
	1.523E+01	8.562E-39
	1.574E+01	3.727E-40
	1.625E+01	1.404E-41
	1.677E+01	4.572E-43
	1.728E+01	1.302E-44
	1.779E+01	3.461E-46
	1.830E+01	1.069E-47
	1.882E+01	5.062E-49
	1.933E+01	3.270E-50
	1.984E+01	0.000E+00
	2.036E+01	0.000E+00
	2.087E+01	0.000E+00
	2.138E+01	0.000E+00
	2.190E+01	0.000E+00
	2.241E+01	0.000E+00
	2.292E+01	0.000E+00
	2.344E+01	0.000E+00
	2.395E+01	0.000E+00
	2.446E+01	0.000E+00

	2.498E+01 2.549E+01 2.600E+01 2.652E+01 2.703E+01 2.754E+01 2.806E+01 2.857E+01 2.908E+01 2.960E+01 3.011E+01 3.062E+01 3.113E+01 3.165E+01 3.216E+01 3.267E+01 3.319E+01 3.370E+01 3.421E+01 3.473E+01 3.524E+01 3.575E+01 3.627E+01 3.678E+01	0.000E+00 0.000E+00
15	0.000E+00 5.560E-01 1.112E+00 1.668E+00 2.224E+00 2.780E+00 3.336E+00 3.892E+00 4.448E+00 5.004E+00 5.560E+00 6.116E+00 6.672E+00 7.228E+00 7.784E+00 8.340E+00 8.896E+00 9.452E+00 1.001E+01 1.056E+01 1.112E+01 1.163E+01 1.215E+01 1.266E+01 1.317E+01 1.369E+01 1.420E+01 1.471E+01 1.523E+01 1.574E+01 1.625E+01 1.677E+01	1.000E+00 4.652E-01 1.431E-01 2.781E-02 3.327E-03 2.407E-04 1.042E-05 2.682E-07 4.082E-09 3.709E-11 3.339E-13 3.550E-14 7.575E-15 1.435E-15 2.363E-16 3.365E-17 4.119E-18 4.309E-19 3.825E-20 2.859E-21 1.612E-22 1.054E-23 5.823E-25 2.708E-26 1.067E-27 3.828E-29 1.768E-30 1.647E-31 2.233E-32 3.069E-33 3.940E-34 4.666E-35

	9.452E+00	5.974E-17
	1.001E+01	1.015E-17
	1.056E+01	1.535E-18
	1.112E+01	1.862E-19
	1.163E+01	2.608E-20
	1.215E+01	3.271E-21
	1.266E+01	3.659E-22
	1.317E+01	3.635E-23
	1.369E+01	3.192E-24
	1.420E+01	2.467E-25
	1.471E+01	1.674E-26
	1.523E+01	1.005E-27
	1.574E+01	5.623E-29
	1.625E+01	3.615E-30
	1.677E+01	3.834E-31
	1.728E+01	6.275E-32
	1.779E+01	1.141E-32
	1.830E+01	2.019E-33
	1.882E+01	3.380E-34
	1.933E+01	5.324E-35
	1.984E+01	7.875E-36
	2.036E+01	1.092E-36
	2.087E+01	1.417E-37
	2.138E+01	1.719E-38
	2.190E+01	1.945E-39
	2.241E+01	2.048E-40
	2.292E+01	2.007E-41
	2.344E+01	1.827E-42
	2.395E+01	1.549E-43
	2.446E+01	1.234E-44
	2.498E+01	9.484E-46
	2.549E+01	7.536E-47
	2.600E+01	6.963E-48
	2.652E+01	8.127E-49
	2.703E+01	1.134E-49
	2.754E+01	1.692E-50
	2.806E+01	0.000E+00
	2.857E+01	0.000E+00
	2.908E+01	0.000E+00
	2.960E+01	0.000E+00
	3.011E+01	0.000E+00
	3.062E+01	0.000E+00
	3.113E+01	0.000E+00
	3.165E+01	0.000E+00
	3.216E+01	0.000E+00
	3.267E+01	0.000E+00
	3.319E+01	0.000E+00
	3.370E+01	0.000E+00
	3.421E+01	0.000E+00
	3.473E+01	0.000E+00
	3.524E+01	0.000E+00
	3.575E+01	0.000E+00
	3.627E+01	0.000E+00
	3.678E+01	0.000E+00
25	0.000E+00	1.000E+00
	5.560E-01	5.729E-01

1.112E+00
1.668E+00
2.224E+00
2.780E+00
3.336E+00
3.892E+00
4.448E+00
5.004E+00
5.560E+00
6.116E+00
6.672E+00
7.228E+00
7.784E+00
8.340E+00
8.896E+00
9.452E+00
1.001E+01
1.056E+01
1.112E+01
1.163E+01
1.215E+01
1.266E+01
1.317E+01
1.369E+01
1.420E+01
1.471E+01
1.523E+01
1.574E+01
1.625E+01
1.677E+01
1.728E+01
1.779E+01
1.830E+01
1.882E+01
1.933E+01
1.984E+01
2.036E+01
2.087E+01
2.138E+01
2.190E+01
2.241E+01
2.292E+01
2.344E+01
2.395E+01
2.446E+01
2.498E+01
2.549E+01
2.600E+01
2.652E+01
2.703E+01
2.754E+01
2.806E+01
2.857E+01
2.908E+01
2.960E+01
3.011E+01
3.062E+01

2.580E-01
8.913E-02
2.324E-02
4.519E-03
6.506E-04
6.898E-05
5.363E-06
3.049E-07
1.265E-08
3.831E-10
8.758E-12
2.658E-13
4.643E-14
1.416E-14
4.118E-15
1.103E-15
2.717E-16
6.109E-17
1.142E-17
2.448E-18
4.840E-19
8.802E-20
1.468E-20
2.240E-21
3.117E-22
3.943E-23
4.519E-24
4.678E-25
4.365E-26
3.678E-27
2.848E-28
2.186E-29
2.071E-30
3.058E-31
6.176E-32
1.346E-32
2.878E-33
5.897E-34
1.152E-34
2.140E-35
3.778E-36
6.332E-37
1.006E-37
1.514E-38
2.154E-39
2.896E-40
3.673E-41
4.394E-42
4.960E-43
5.303E-44
5.427E-45
5.471E-46
5.765E-47
6.942E-48
1.010E-48
1.710E-49
3.101E-50

	3.113E+01	0.000E+00
	3.165E+01	0.000E+00
	3.216E+01	0.000E+00
	3.267E+01	0.000E+00
	3.319E+01	0.000E+00
	3.370E+01	0.000E+00
	3.421E+01	0.000E+00
	3.473E+01	0.000E+00
	3.524E+01	0.000E+00
	3.575E+01	0.000E+00
	3.627E+01	0.000E+00
	3.678E+01	0.000E+00
30	0.000E+00	1.000E+00
	5.560E-01	6.074E-01
	1.112E+00	3.024E-01
	1.668E+00	1.211E-01
	2.224E+00	3.847E-02
	2.780E+00	9.599E-03
	3.336E+00	1.869E-03
	3.892E+00	2.826E-04
	4.448E+00	3.306E-05
	5.004E+00	2.985E-06
	5.560E+00	2.075E-07
	6.116E+00	1.109E-08
	6.672E+00	4.560E-10
	7.228E+00	1.474E-11
	7.784E+00	5.124E-13
	8.340E+00	7.000E-14
	8.896E+00	2.285E-14
	9.452E+00	7.625E-15
	1.001E+01	2.385E-15
	1.056E+01	6.920E-16
	1.112E+01	1.709E-16
	1.163E+01	4.809E-17
	1.215E+01	1.269E-17
	1.266E+01	3.138E-18
	1.317E+01	7.252E-19
	1.369E+01	1.564E-19
	1.420E+01	3.142E-20
	1.471E+01	5.865E-21
	1.523E+01	1.015E-21
	1.574E+01	1.626E-22
	1.625E+01	2.402E-23
	1.677E+01	3.266E-24
	1.728E+01	4.080E-25
	1.779E+01	4.673E-26
	1.830E+01	4.915E-27
	1.882E+01	4.801E-28
	1.933E+01	4.560E-29
	1.984E+01	4.825E-30
	2.036E+01	7.070E-31
	2.087E+01	1.473E-31
	2.138E+01	3.591E-32
	2.190E+01	8.938E-33
	2.241E+01	2.169E-33
	2.292E+01	5.072E-34

	2.344E+01 2.395E+01 2.446E+01 2.498E+01 2.549E+01 2.600E+01 2.652E+01 2.703E+01 2.754E+01 2.806E+01 2.857E+01 2.908E+01 2.960E+01 3.011E+01 3.062E+01 3.113E+01 3.165E+01 3.216E+01 3.267E+01 3.319E+01 3.370E+01 3.421E+01 3.473E+01 3.524E+01 3.575E+01 3.627E+01 3.678E+01	1.139E-34 2.455E-35 5.071E-36 1.003E-36 1.898E-37 3.433E-38 5.931E-39 9.775E-40 1.536E-40 2.299E-41 3.277E-42 4.451E-43 5.779E-44 7.233E-45 8.900E-46 1.122E-46 1.547E-47 2.477E-48 4.612E-49 9.443E-50 2.002E-50 0.000E+00 0.000E+00 0.000E+00 0.000E+00 0.000E+00 0.000E+00
35	0.000E+00 5.560E-01 1.112E+00 1.668E+00 2.224E+00 2.780E+00 3.336E+00 3.892E+00 4.448E+00 5.004E+00 5.560E+00 6.116E+00 6.672E+00 7.228E+00 7.784E+00 8.340E+00 8.896E+00 9.452E+00 1.001E+01 1.056E+01 1.112E+01 1.163E+01 1.215E+01 1.266E+01 1.317E+01 1.369E+01 1.420E+01 1.471E+01 1.523E+01	1.000E+00 6.348E-01 3.403E-01 1.517E-01 5.555E-02 1.658E-02 4.008E-03 7.813E-04 1.224E-04 1.538E-05 1.547E-06 1.243E-07 7.968E-09 4.082E-10 1.702E-11 7.245E-13 9.112E-14 3.054E-14 1.120E-14 3.876E-15 1.164E-15 3.954E-16 1.275E-16 3.894E-17 1.126E-17 3.078E-18 7.942E-19 1.931E-19 4.420E-20

	1.574E+01 1.625E+01 1.677E+01 1.728E+01 1.779E+01 1.830E+01 1.882E+01 1.933E+01 1.984E+01 2.036E+01 2.087E+01 2.138E+01 2.190E+01 2.241E+01 2.292E+01 2.344E+01 2.395E+01 2.446E+01 2.498E+01 2.549E+01 2.600E+01 2.652E+01 2.703E+01 2.754E+01 2.806E+01 2.857E+01 2.908E+01 2.960E+01 3.011E+01 3.062E+01 3.113E+01 3.165E+01 3.216E+01 3.267E+01 3.319E+01 3.370E+01 3.421E+01 3.473E+01 3.524E+01 3.575E+01 3.627E+01 3.678E+01	9.504E-21 1.916E-21 3.617E-22 6.378E-23 1.049E-23 1.605E-24 2.281E-25 3.011E-26 3.696E-27 4.270E-28 4.829E-29 5.968E-30 9.624E-31 2.139E-31 5.668E-32 1.567E-32 4.278E-33 1.135E-33 2.911E-34 7.210E-35 1.723E-35 3.970E-36 8.812E-37 1.883E-37 3.872E-38 7.653E-39 1.453E-39 2.649E-40 4.632E-41 7.767E-42 1.249E-42 1.930E-43 2.874E-44 4.167E-45 5.997E-46 8.896E-47 1.436E-47 2.643E-48 5.541E-49 1.267E-49 3.007E-50 0.000E+00
40	0.000E+00 5.560E-01 1.112E+00 1.668E+00 2.224E+00 2.780E+00 3.336E+00 3.892E+00 4.448E+00 5.004E+00 5.560E+00 6.116E+00 6.672E+00 7.228E+00	1.000E+00 6.572E-01 3.730E-01 1.804E-01 7.356E-02 2.513E-02 7.148E-03 1.687E-03 3.292E-04 5.302E-05 7.032E-06 7.670E-07 6.873E-08 5.056E-09

7.784E+00	3.058E-10
8.340E+00	1.549E-11
8.896E+00	8.040E-13
9.452E+00	1.054E-13
1.001E+01	3.619E-14
1.056E+01	1.407E-14
1.112E+01	4.880E-15
1.163E+01	1.904E-15
1.215E+01	7.108E-16
1.266E+01	2.535E-16
1.317E+01	8.633E-17
1.369E+01	2.804E-17
1.420E+01	8.676E-18
1.471E+01	2.555E-18
1.523E+01	7.153E-19
1.574E+01	1.901E-19
1.625E+01	4.791E-20
1.677E+01	1.143E-20
1.728E+01	2.580E-21
1.779E+01	5.495E-22
1.830E+01	1.103E-22
1.882E+01	2.085E-23
1.933E+01	3.703E-24
1.984E+01	6.168E-25
2.036E+01	9.630E-26
2.087E+01	1.409E-26
2.138E+01	1.940E-27
2.190E+01	2.548E-28
2.241E+01	3.336E-29
2.292E+01	4.841E-30
2.344E+01	9.018E-31
2.395E+01	2.221E-31
2.446E+01	6.394E-32
2.498E+01	1.920E-32
2.549E+01	5.725E-33
2.600E+01	1.667E-33
2.652E+01	4.716E-34
2.703E+01	1.295E-34
2.754E+01	3.445E-35
2.806E+01	8.881E-36
2.857E+01	2.217E-36
2.908E+01	5.354E-37
2.960E+01	1.251E-37
3.011E+01	2.824E-38
3.062E+01	6.159E-39
3.113E+01	1.297E-39
3.165E+01	2.634E-40
3.216E+01	5.161E-41
3.267E+01	9.747E-42
3.319E+01	1.775E-42
3.370E+01	3.118E-43
3.421E+01	5.300E-44
3.473E+01	8.769E-45
3.524E+01	1.430E-45
3.575E+01	2.355E-46
3.627E+01	4.075E-47
3.678E+01	7.751E-48

45

0.000E+00	1.000E+00
5.560E-01	6.761E-01
1.112E+00	4.015E-01
1.668E+00	2.070E-01
2.224E+00	9.189E-02
2.780E+00	3.488E-02
3.336E+00	1.127E-02
3.892E+00	3.086E-03
4.448E+00	7.146E-04
5.004E+00	1.396E-04
5.560E+00	2.297E-05
6.116E+00	3.179E-06
6.672E+00	3.696E-07
7.228E+00	3.608E-08
7.784E+00	2.955E-09
8.340E+00	2.035E-10
8.896E+00	1.205E-11
9.452E+00	7.519E-13
1.001E+01	1.104E-13
1.056E+01	3.903E-14
1.112E+01	1.487E-14
1.163E+01	6.447E-15
1.215E+01	2.691E-15
1.266E+01	1.080E-15
1.317E+01	4.167E-16
1.369E+01	1.543E-16
1.420E+01	5.481E-17
1.471E+01	1.866E-17
1.523E+01	6.082E-18
1.574E+01	1.897E-18
1.625E+01	5.653E-19
1.677E+01	1.609E-19
1.728E+01	4.365E-20
1.779E+01	1.128E-20
1.830E+01	2.775E-21
1.882E+01	6.484E-22
1.933E+01	1.438E-22
1.984E+01	3.022E-23
2.036E+01	6.010E-24
2.087E+01	1.130E-24
2.138E+01	2.005E-25
2.190E+01	3.359E-26
2.241E+01	5.319E-27
2.292E+01	8.011E-28
2.344E+01	1.171E-28
2.395E+01	1.757E-29
2.446E+01	3.015E-30
2.498E+01	6.632E-31
2.549E+01	1.841E-31
2.600E+01	5.750E-32
2.652E+01	1.852E-32
2.703E+01	5.917E-33
2.754E+01	1.851E-33
2.806E+01	5.648E-34
2.857E+01	1.678E-34
2.908E+01	4.847E-35

	2.960E+01 3.011E+01 3.062E+01 3.113E+01 3.165E+01 3.216E+01 3.267E+01 3.319E+01 3.370E+01 3.421E+01 3.473E+01 3.524E+01 3.575E+01 3.627E+01 3.678E+01	1.362E-35 3.718E-36 9.861E-37 2.539E-37 6.346E-38 1.538E-38 3.615E-39 8.232E-40 1.816E-40 3.877E-41 8.013E-42 1.603E-42 3.108E-43 5.851E-44 1.075E-44
50	0.000E+00 5.560E-01 1.112E+00 1.668E+00 2.224E+00 2.780E+00 3.336E+00 3.892E+00 4.448E+00 5.004E+00 5.560E+00 6.116E+00 6.672E+00 7.228E+00 7.784E+00 8.340E+00 8.896E+00 9.452E+00 1.001E+01 1.056E+01 1.112E+01 1.163E+01 1.215E+01 1.266E+01 1.317E+01 1.369E+01 1.420E+01 1.471E+01 1.523E+01 1.574E+01 1.625E+01 1.677E+01 1.728E+01 1.779E+01 1.830E+01 1.882E+01 1.933E+01 1.984E+01 2.036E+01 2.087E+01 2.138E+01	1.000E+00 6.922E-01 4.266E-01 2.317E-01 1.101E-01 4.550E-02 1.628E-02 5.023E-03 1.334E-03 3.043E-04 5.950E-05 9.962E-06 1.427E-06 1.746E-07 1.826E-08 1.630E-09 1.247E-10 8.412E-12 6.260E-13 1.062E-13 3.694E-14 1.711E-14 7.793E-15 3.434E-15 1.461E-15 5.998E-16 2.374E-16 9.053E-17 3.324E-17 1.174E-17 3.989E-18 1.302E-18 4.076E-19 1.224E-19 3.521E-20 9.692E-21 2.551E-21 6.412E-22 1.537E-22 3.512E-23 7.637E-24

	2.190E+01 2.241E+01 2.292E+01 2.344E+01 2.395E+01 2.446E+01 2.498E+01 2.549E+01 2.600E+01 2.652E+01 2.703E+01 2.754E+01 2.806E+01 2.857E+01 2.908E+01 2.960E+01 3.011E+01 3.062E+01 3.113E+01 3.165E+01 3.216E+01 3.267E+01 3.319E+01 3.370E+01 3.421E+01 3.473E+01 3.524E+01 3.575E+01 3.627E+01 3.678E+01	1.579E-24 3.099E-25 5.776E-26 1.022E-26 1.725E-27 2.807E-28 4.544E-29 7.856E-30 1.618E-30 4.221E-31 1.314E-31 4.422E-32 1.510E-32 5.104E-33 1.691E-33 5.476E-34 1.731E-34 5.337E-35 1.605E-35 4.702E-36 1.342E-36 3.733E-37 1.010E-37 2.661E-38 6.819E-39 1.698E-39 4.111E-40 9.667E-41 2.208E-41 4.896E-42
55	0.000E+00 5.560E-01 1.112E+00 1.668E+00 2.224E+00 2.780E+00 3.336E+00 3.892E+00 4.448E+00 5.004E+00 5.560E+00 6.116E+00 6.672E+00 7.228E+00 7.784E+00 8.340E+00 8.896E+00 9.452E+00 1.001E+01 1.056E+01 1.112E+01 1.163E+01 1.215E+01 1.266E+01 1.317E+01 1.369E+01	1.000E+00 7.061E-01 4.489E-01 2.546E-01 1.280E-01 5.671E-02 2.206E-02 7.508E-03 2.231E-03 5.777E-04 1.301E-04 2.546E-05 4.325E-06 6.372E-07 8.136E-08 9.000E-09 8.628E-10 7.203E-11 5.446E-12 4.817E-13 9.038E-14 3.882E-14 1.863E-14 8.834E-15 4.068E-15 1.815E-15

1.420E+01	7.837E-16
1.471E+01	3.275E-16
1.523E+01	1.323E-16
1.574E+01	5.168E-17
1.625E+01	1.949E-17
1.677E+01	7.096E-18
1.728E+01	2.492E-18
1.779E+01	8.431E-19
1.830E+01	2.748E-19
1.882E+01	8.616E-20
1.933E+01	2.598E-20
1.984E+01	7.525E-21
2.036E+01	2.092E-21
2.087E+01	5.576E-22
2.138E+01	1.424E-22
2.190E+01	3.479E-23
2.241E+01	8.127E-24
2.292E+01	1.813E-24
2.344E+01	3.861E-25
2.395E+01	7.840E-26
2.446E+01	1.519E-26
2.498E+01	2.814E-27
2.549E+01	5.024E-28
2.600E+01	8.820E-29
2.652E+01	1.598E-29
2.703E+01	3.256E-30
2.754E+01	8.129E-31
2.806E+01	2.480E-31
2.857E+01	8.507E-32
2.908E+01	3.043E-32
2.960E+01	1.091E-32
3.011E+01	3.861E-33
3.062E+01	1.340E-33
3.113E+01	4.553E-34
3.165E+01	1.513E-34
3.216E+01	4.918E-35
3.267E+01	1.562E-35
3.319E+01	4.845E-36
3.370E+01	1.468E-36
3.421E+01	4.343E-37
3.473E+01	1.254E-37
3.524E+01	3.530E-38
3.575E+01	9.695E-39
3.627E+01	2.596E-39
3.678E+01	6.771E-40

NOTICE

Although this program has been tested and experience would indicate that it is accurate within the limits given by the assumptions of the theory used, we make no warranty as to workability of this software or any other licensed material. No warranties either expressed or implied (including warranties of fitness) shall apply. No responsibility is assumed for any errors, mistakes or misrepresentations that may occur from the use of this computer program. The user accepts full responsibility for assessing the validity and applicability of the results obtained with this program for any specific case.

POLLUTEv7

Version 7.13

Copyright (c) 2007.
GAEA Technologies Ltd., R.K. Rowe and J.R. Booker

DB SandPoro Low

THE DARCY VELOCITY (Flux) THROUGH THE LAYERS $V_a = 0.000203$ m/year

Layer Properties

Layer	Thickness	Number of Sublayers	Coefficient of Hydrodynamic Dispersion	Matrix Porosity	Distribution Coefficient	Dry Density
Clay	11.12 m	20	0.019 m ² /a	0.37	0 m ³ /kg	1510 kg/m ³
Clay with Sand	25.66 m	50	0.019 m ² /a	0.2	0 m ³ /kg	1510 kg/m ³

Boundary Conditions

Constant Concentration

Source Concentration = 1 mg/L

Infinite Thickness Bottom Boundary

Laplace Transform Parameters

TAU = 7 N = 20 SIG = 0 RNU = 2

Calculated Concentrations at Selected Times and Depths

Time year	Depth m	Concentration mg/L
5	0.000E+00	1.000E+00
	5.560E-01	2.037E-01
	1.112E+00	1.091E-02
	1.668E+00	1.331E-04
	2.224E+00	3.467E-07

2.780E+00	1.878E-10
3.336E+00	1.005E-13
3.892E+00	5.956E-15
4.448E+00	2.947E-16
5.004E+00	9.449E-18
5.560E+00	1.904E-19
6.116E+00	2.329E-21
6.672E+00	1.657E-23
7.228E+00	6.570E-26
7.784E+00	1.471E-28
8.340E+00	5.331E-31
8.896E+00	1.130E-32
9.452E+00	2.457E-34
1.001E+01	4.021E-36
1.056E+01	4.849E-38
1.112E+01	5.498E-40
1.163E+01	5.155E-42
1.215E+01	3.636E-44
1.266E+01	2.191E-46
1.317E+01	2.052E-48
1.369E+01	4.036E-50
1.420E+01	0.000E+00
1.471E+01	0.000E+00
1.523E+01	0.000E+00
1.574E+01	0.000E+00
1.625E+01	0.000E+00
1.677E+01	0.000E+00
1.728E+01	0.000E+00
1.779E+01	0.000E+00
1.830E+01	0.000E+00
1.882E+01	0.000E+00
1.933E+01	0.000E+00
1.984E+01	0.000E+00
2.036E+01	0.000E+00
2.087E+01	0.000E+00
2.138E+01	0.000E+00
2.190E+01	0.000E+00
2.241E+01	0.000E+00
2.292E+01	0.000E+00
2.344E+01	0.000E+00
2.395E+01	0.000E+00
2.446E+01	0.000E+00
2.498E+01	0.000E+00
2.549E+01	0.000E+00
2.600E+01	0.000E+00
2.652E+01	0.000E+00
2.703E+01	0.000E+00
2.754E+01	0.000E+00
2.806E+01	0.000E+00
2.857E+01	0.000E+00
2.908E+01	0.000E+00
2.960E+01	0.000E+00
3.011E+01	0.000E+00
3.062E+01	0.000E+00
3.113E+01	0.000E+00
3.165E+01	0.000E+00
3.216E+01	0.000E+00

	3.267E+01	0.000E+00
	3.319E+01	0.000E+00
	3.370E+01	0.000E+00
	3.421E+01	0.000E+00
	3.473E+01	0.000E+00
	3.524E+01	0.000E+00
	3.575E+01	0.000E+00
	3.627E+01	0.000E+00
	3.678E+01	0.000E+00
10	0.000E+00	1.000E+00
	5.560E-01	3.700E-01
	1.112E+00	7.240E-02
	1.668E+00	6.979E-03
	2.224E+00	3.189E-04
	2.780E+00	6.756E-06
	3.336E+00	6.551E-08
	3.892E+00	2.891E-10
	4.448E+00	7.541E-13
	5.004E+00	3.374E-14
	5.560E+00	4.993E-15
	6.116E+00	6.111E-16
	6.672E+00	6.039E-17
	7.228E+00	4.770E-18
	7.784E+00	2.978E-19
	8.340E+00	1.451E-20
	8.896E+00	5.443E-22
	9.452E+00	1.547E-23
	1.001E+01	3.277E-25
	1.056E+01	5.130E-27
	1.112E+01	8.226E-29
	1.163E+01	1.924E-30
	1.215E+01	1.213E-31
	1.266E+01	1.087E-32
	1.317E+01	9.132E-34
	1.369E+01	6.819E-35
	1.420E+01	4.489E-36
	1.471E+01	2.594E-37
	1.523E+01	1.309E-38
	1.574E+01	5.741E-40
	1.625E+01	2.180E-41
	1.677E+01	7.151E-43
	1.728E+01	2.052E-44
	1.779E+01	5.496E-46
	1.830E+01	1.710E-47
	1.882E+01	8.161E-49
	1.933E+01	5.312E-50
	1.984E+01	0.000E+00
	2.036E+01	0.000E+00
	2.087E+01	0.000E+00
	2.138E+01	0.000E+00
	2.190E+01	0.000E+00
	2.241E+01	0.000E+00
	2.292E+01	0.000E+00
	2.344E+01	0.000E+00
	2.395E+01	0.000E+00
	2.446E+01	0.000E+00

9.452E+00	5.974E-17
1.001E+01	1.016E-17
1.056E+01	1.544E-18
1.112E+01	2.678E-19
1.163E+01	3.780E-20
1.215E+01	4.778E-21
1.266E+01	5.386E-22
1.317E+01	5.390E-23
1.369E+01	4.769E-24
1.420E+01	3.714E-25
1.471E+01	2.540E-26
1.523E+01	1.537E-27
1.574E+01	8.661E-29
1.625E+01	5.610E-30
1.677E+01	5.995E-31
1.728E+01	9.885E-32
1.779E+01	1.811E-32
1.830E+01	3.229E-33
1.882E+01	5.447E-34
1.933E+01	8.646E-35
1.984E+01	1.289E-35
2.036E+01	1.801E-36
2.087E+01	2.355E-37
2.138E+01	2.878E-38
2.190E+01	3.280E-39
2.241E+01	3.482E-40
2.292E+01	3.437E-41
2.344E+01	3.153E-42
2.395E+01	2.694E-43
2.446E+01	2.162E-44
2.498E+01	1.675E-45
2.549E+01	1.341E-46
2.600E+01	1.248E-47
2.652E+01	1.468E-48
2.703E+01	2.064E-49
2.754E+01	3.101E-50
2.806E+01	0.000E+00
2.857E+01	0.000E+00
2.908E+01	0.000E+00
2.960E+01	0.000E+00
3.011E+01	0.000E+00
3.062E+01	0.000E+00
3.113E+01	0.000E+00
3.165E+01	0.000E+00
3.216E+01	0.000E+00
3.267E+01	0.000E+00
3.319E+01	0.000E+00
3.370E+01	0.000E+00
3.421E+01	0.000E+00
3.473E+01	0.000E+00
3.524E+01	0.000E+00
3.575E+01	0.000E+00
3.627E+01	0.000E+00
3.678E+01	0.000E+00

1.112E+00
1.668E+00
2.224E+00
2.780E+00
3.336E+00
3.892E+00
4.448E+00
5.004E+00
5.560E+00
6.116E+00
6.672E+00
7.228E+00
7.784E+00
8.340E+00
8.896E+00
9.452E+00
1.001E+01
1.056E+01
1.112E+01
1.163E+01
1.215E+01
1.266E+01
1.317E+01
1.369E+01
1.420E+01
1.471E+01
1.523E+01
1.574E+01
1.625E+01
1.677E+01
1.728E+01
1.779E+01
1.830E+01
1.882E+01
1.933E+01
1.984E+01
2.036E+01
2.087E+01
2.138E+01
2.190E+01
2.241E+01
2.292E+01
2.344E+01
2.395E+01
2.446E+01
2.498E+01
2.549E+01
2.600E+01
2.652E+01
2.703E+01
2.754E+01
2.806E+01
2.857E+01
2.908E+01
2.960E+01
3.011E+01
3.062E+01

2.580E-01
8.913E-02
2.324E-02
4.519E-03
6.506E-04
6.898E-05
5.363E-06
3.049E-07
1.265E-08
3.831E-10
8.758E-12
2.658E-13
4.643E-14
1.416E-14
4.118E-15
1.103E-15
2.718E-16
6.202E-17
1.643E-17
3.549E-18
7.069E-19
1.295E-19
2.177E-20
3.347E-21
4.693E-22
5.981E-23
6.907E-24
7.205E-25
6.774E-26
5.751E-27
4.487E-28
3.470E-29
3.313E-30
4.929E-31
1.003E-31
2.202E-32
4.744E-33
9.795E-34
1.928E-34
3.609E-35
6.420E-36
1.084E-36
1.736E-37
2.632E-38
3.774E-39
5.112E-40
6.533E-41
7.876E-42
8.958E-43
9.650E-44
9.952E-45
1.011E-45
1.073E-46
1.302E-47
1.909E-48
3.256E-49
5.948E-50

	3.113E+01	1.096E-50
	3.165E+01	0.000E+00
	3.216E+01	0.000E+00
	3.267E+01	0.000E+00
	3.319E+01	0.000E+00
	3.370E+01	0.000E+00
	3.421E+01	0.000E+00
	3.473E+01	0.000E+00
	3.524E+01	0.000E+00
	3.575E+01	0.000E+00
	3.627E+01	0.000E+00
	3.678E+01	0.000E+00
30	0.000E+00	1.000E+00
	5.560E-01	6.074E-01
	1.112E+00	3.024E-01
	1.668E+00	1.211E-01
	2.224E+00	3.847E-02
	2.780E+00	9.599E-03
	3.336E+00	1.869E-03
	3.892E+00	2.826E-04
	4.448E+00	3.306E-05
	5.004E+00	2.985E-06
	5.560E+00	2.075E-07
	6.116E+00	1.109E-08
	6.672E+00	4.560E-10
	7.228E+00	1.474E-11
	7.784E+00	5.124E-13
	8.340E+00	7.000E-14
	8.896E+00	2.285E-14
	9.452E+00	7.625E-15
	1.001E+01	2.389E-15
	1.056E+01	7.107E-16
	1.112E+01	2.459E-16
	1.163E+01	6.970E-17
	1.215E+01	1.854E-17
	1.266E+01	4.617E-18
	1.317E+01	1.075E-18
	1.369E+01	2.337E-19
	1.420E+01	4.730E-20
	1.471E+01	8.897E-21
	1.523E+01	1.552E-21
	1.574E+01	2.503E-22
	1.625E+01	3.727E-23
	1.677E+01	5.107E-24
	1.728E+01	6.428E-25
	1.779E+01	7.419E-26
	1.830E+01	7.863E-27
	1.882E+01	7.739E-28
	1.933E+01	7.406E-29
	1.984E+01	7.895E-30
	2.036E+01	1.166E-30
	2.087E+01	2.447E-31
	2.138E+01	6.010E-32
	2.190E+01	1.507E-32
	2.241E+01	3.685E-33
	2.292E+01	8.684E-34

	2.344E+01 2.395E+01 2.446E+01 2.498E+01 2.549E+01 2.600E+01 2.652E+01 2.703E+01 2.754E+01 2.806E+01 2.857E+01 2.908E+01 2.960E+01 3.011E+01 3.062E+01 3.113E+01 3.165E+01 3.216E+01 3.267E+01 3.319E+01 3.370E+01 3.421E+01 3.473E+01 3.524E+01 3.575E+01 3.627E+01 3.678E+01	1.965E-34 4.268E-35 8.882E-36 1.770E-36 3.375E-37 6.152E-38 1.071E-38 1.778E-39 2.816E-40 4.246E-41 6.099E-42 8.348E-43 1.092E-43 1.377E-44 1.708E-45 2.169E-46 3.013E-47 4.860E-48 9.117E-49 1.881E-49 4.019E-50 0.000E+00 0.000E+00 0.000E+00 0.000E+00 0.000E+00 0.000E+00
35	0.000E+00 5.560E-01 1.112E+00 1.668E+00 2.224E+00 2.780E+00 3.336E+00 3.892E+00 4.448E+00 5.004E+00 5.560E+00 6.116E+00 6.672E+00 7.228E+00 7.784E+00 8.340E+00 8.896E+00 9.452E+00 1.001E+01 1.056E+01 1.112E+01 1.163E+01 1.215E+01 1.266E+01 1.317E+01 1.369E+01 1.420E+01 1.471E+01 1.523E+01	1.000E+00 6.348E-01 3.403E-01 1.517E-01 5.555E-02 1.658E-02 4.008E-03 7.813E-04 1.224E-04 1.538E-05 1.547E-06 1.243E-07 7.968E-09 4.082E-10 1.702E-11 7.245E-13 9.112E-14 3.055E-14 1.124E-14 4.032E-15 1.674E-15 5.731E-16 1.862E-16 5.730E-17 1.670E-17 4.598E-18 1.196E-18 2.930E-19 6.756E-20

	1.574E+01 1.625E+01 1.677E+01 1.728E+01 1.779E+01 1.830E+01 1.882E+01 1.933E+01 1.984E+01 2.036E+01 2.087E+01 2.138E+01 2.190E+01 2.241E+01 2.292E+01 2.344E+01 2.395E+01 2.446E+01 2.498E+01 2.549E+01 2.600E+01 2.652E+01 2.703E+01 2.754E+01 2.806E+01 2.857E+01 2.908E+01 2.960E+01 3.011E+01 3.062E+01 3.113E+01 3.165E+01 3.216E+01 3.267E+01 3.319E+01 3.370E+01 3.421E+01 3.473E+01 3.524E+01 3.575E+01 3.627E+01 3.678E+01	1.464E-20 2.974E-21 5.655E-22 1.005E-22 1.665E-23 2.567E-24 3.677E-25 4.889E-26 6.049E-27 7.041E-28 8.023E-29 9.989E-30 1.623E-30 3.634E-31 9.702E-32 2.702E-32 7.434E-33 1.987E-33 5.136E-34 1.282E-34 3.087E-35 7.166E-36 1.603E-36 3.452E-37 7.151E-38 1.424E-38 2.725E-39 5.004E-40 8.818E-41 1.490E-41 2.415E-42 3.759E-43 5.642E-44 8.240E-45 1.195E-45 1.786E-46 2.905E-47 5.385E-48 1.137E-48 2.620E-49 6.266E-50 1.504E-50
40	0.000E+00 5.560E-01 1.112E+00 1.668E+00 2.224E+00 2.780E+00 3.336E+00 3.892E+00 4.448E+00 5.004E+00 5.560E+00 6.116E+00 6.672E+00 7.228E+00	1.000E+00 6.572E-01 3.730E-01 1.804E-01 7.356E-02 2.513E-02 7.148E-03 1.687E-03 3.292E-04 5.302E-05 7.032E-06 7.670E-07 6.873E-08 5.056E-09

7.784E+00	3.058E-10
8.340E+00	1.549E-11
8.896E+00	8.040E-13
9.452E+00	1.055E-13
1.001E+01	3.644E-14
1.056E+01	1.483E-14
1.112E+01	7.020E-15
1.163E+01	2.760E-15
1.215E+01	1.038E-15
1.266E+01	3.730E-16
1.317E+01	1.280E-16
1.369E+01	4.189E-17
1.420E+01	1.306E-17
1.471E+01	3.875E-18
1.523E+01	1.093E-18
1.574E+01	2.927E-19
1.625E+01	7.434E-20
1.677E+01	1.787E-20
1.728E+01	4.064E-21
1.779E+01	8.723E-22
1.830E+01	1.765E-22
1.882E+01	3.361E-23
1.933E+01	6.013E-24
1.984E+01	1.009E-24
2.036E+01	1.588E-25
2.087E+01	2.341E-26
2.138E+01	3.247E-27
2.190E+01	4.298E-28
2.241E+01	5.670E-29
2.292E+01	8.289E-30
2.344E+01	1.555E-30
2.395E+01	3.860E-31
2.446E+01	1.119E-31
2.498E+01	3.387E-32
2.549E+01	1.018E-32
2.600E+01	2.985E-33
2.652E+01	8.512E-34
2.703E+01	2.354E-34
2.754E+01	6.312E-35
2.806E+01	1.640E-35
2.857E+01	4.124E-36
2.908E+01	1.004E-36
2.960E+01	2.363E-37
3.011E+01	5.375E-38
3.062E+01	1.181E-38
3.113E+01	2.506E-39
3.165E+01	5.130E-40
3.216E+01	1.013E-40
3.267E+01	1.927E-41
3.319E+01	3.536E-42
3.370E+01	6.260E-43
3.421E+01	1.072E-43
3.473E+01	1.787E-44
3.524E+01	2.937E-45
3.575E+01	4.873E-46
3.627E+01	8.494E-47
3.678E+01	1.628E-47

45

0.000E+00	1.000E+00
5.560E-01	6.761E-01
1.112E+00	4.015E-01
1.668E+00	2.070E-01
2.224E+00	9.189E-02
2.780E+00	3.488E-02
3.336E+00	1.127E-02
3.892E+00	3.086E-03
4.448E+00	7.146E-04
5.004E+00	1.396E-04
5.560E+00	2.297E-05
6.116E+00	3.179E-06
6.672E+00	3.696E-07
7.228E+00	3.608E-08
7.784E+00	2.955E-09
8.340E+00	2.035E-10
8.896E+00	1.205E-11
9.452E+00	7.522E-13
1.001E+01	1.114E-13
1.056E+01	4.162E-14
1.112E+01	2.139E-14
1.163E+01	9.344E-15
1.215E+01	3.931E-15
1.266E+01	1.590E-15
1.317E+01	6.179E-16
1.369E+01	2.305E-16
1.420E+01	8.250E-17
1.471E+01	2.830E-17
1.523E+01	9.294E-18
1.574E+01	2.921E-18
1.625E+01	8.771E-19
1.677E+01	2.515E-19
1.728E+01	6.876E-20
1.779E+01	1.791E-20
1.830E+01	4.437E-21
1.882E+01	1.045E-21
1.933E+01	2.335E-22
1.984E+01	4.944E-23
2.036E+01	9.908E-24
2.087E+01	1.877E-24
2.138E+01	3.357E-25
2.190E+01	5.666E-26
2.241E+01	9.039E-27
2.292E+01	1.372E-27
2.344E+01	2.021E-28
2.395E+01	3.054E-29
2.446E+01	5.280E-30
2.498E+01	1.170E-30
2.549E+01	3.271E-31
2.600E+01	1.030E-31
2.652E+01	3.341E-32
2.703E+01	1.076E-32
2.754E+01	3.392E-33
2.806E+01	1.043E-33
2.857E+01	3.120E-34
2.908E+01	9.084E-35

	2.960E+01 3.011E+01 3.062E+01 3.113E+01 3.165E+01 3.216E+01 3.267E+01 3.319E+01 3.370E+01 3.421E+01 3.473E+01 3.524E+01 3.575E+01 3.627E+01 3.678E+01	2.571E-35 7.075E-36 1.891E-36 4.906E-37 1.235E-37 3.018E-38 7.146E-39 1.640E-39 3.644E-40 7.840E-41 1.633E-41 3.292E-42 6.431E-43 1.220E-43 2.258E-44
50	0.000E+00 5.560E-01 1.112E+00 1.668E+00 2.224E+00 2.780E+00 3.336E+00 3.892E+00 4.448E+00 5.004E+00 5.560E+00 6.116E+00 6.672E+00 7.228E+00 7.784E+00 8.340E+00 8.896E+00 9.452E+00 1.001E+01 1.056E+01 1.112E+01 1.163E+01 1.215E+01 1.266E+01 1.317E+01 1.369E+01 1.420E+01 1.471E+01 1.523E+01 1.574E+01 1.625E+01 1.677E+01 1.728E+01 1.779E+01 1.830E+01 1.882E+01 1.933E+01 1.984E+01 2.036E+01 2.087E+01 2.138E+01	1.000E+00 6.922E-01 4.266E-01 2.317E-01 1.101E-01 4.550E-02 1.628E-02 5.023E-03 1.334E-03 3.043E-04 5.950E-05 9.962E-06 1.427E-06 1.746E-07 1.826E-08 1.630E-09 1.247E-10 8.413E-12 6.289E-13 1.132E-13 5.315E-14 2.480E-14 1.138E-14 5.053E-15 2.166E-15 8.959E-16 3.573E-16 1.373E-16 5.080E-17 1.808E-17 6.189E-18 2.035E-18 6.420E-19 1.942E-19 5.630E-20 1.562E-20 4.142E-21 1.049E-21 2.534E-22 5.834E-23 1.278E-23

	2.190E+01 2.241E+01 2.292E+01 2.344E+01 2.395E+01 2.446E+01 2.498E+01 2.549E+01 2.600E+01 2.652E+01 2.703E+01 2.754E+01 2.806E+01 2.857E+01 2.908E+01 2.960E+01 3.011E+01 3.062E+01 3.113E+01 3.165E+01 3.216E+01 3.267E+01 3.319E+01 3.370E+01 3.421E+01 3.473E+01 3.524E+01 3.575E+01 3.627E+01 3.678E+01	2.662E-24 5.267E-25 9.890E-26 1.764E-26 2.999E-27 4.917E-28 8.019E-29 1.397E-29 2.898E-30 7.615E-31 2.389E-31 8.098E-32 2.787E-32 9.491E-33 3.169E-33 1.034E-33 3.293E-34 1.023E-34 3.099E-35 9.151E-36 2.633E-36 7.376E-37 2.012E-37 5.340E-38 1.378E-38 3.460E-39 8.439E-40 1.999E-40 4.601E-41 1.028E-41
55	0.000E+00 5.560E-01 1.112E+00 1.668E+00 2.224E+00 2.780E+00 3.336E+00 3.892E+00 4.448E+00 5.004E+00 5.560E+00 6.116E+00 6.672E+00 7.228E+00 7.784E+00 8.340E+00 8.896E+00 9.452E+00 1.001E+01 1.056E+01 1.112E+01 1.163E+01 1.215E+01 1.266E+01 1.317E+01 1.369E+01	1.000E+00 7.061E-01 4.489E-01 2.546E-01 1.280E-01 5.671E-02 2.206E-02 7.508E-03 2.231E-03 5.777E-04 1.301E-04 2.546E-05 4.325E-06 6.372E-07 8.136E-08 9.000E-09 8.628E-10 7.203E-11 5.453E-12 4.975E-13 1.300E-13 5.626E-14 2.721E-14 1.300E-14 6.031E-15 2.711E-15

1.420E+01	1.180E-15
1.471E+01	4.967E-16
1.523E+01	2.022E-16
1.574E+01	7.957E-17
1.625E+01	3.024E-17
1.677E+01	1.109E-17
1.728E+01	3.924E-18
1.779E+01	1.338E-18
1.830E+01	4.393E-19
1.882E+01	1.388E-19
1.933E+01	4.218E-20
1.984E+01	1.231E-20
2.036E+01	3.448E-21
2.087E+01	9.261E-22
2.138E+01	2.383E-22
2.190E+01	5.866E-23
2.241E+01	1.381E-23
2.292E+01	3.104E-24
2.344E+01	6.660E-25
2.395E+01	1.363E-25
2.446E+01	2.660E-26
2.498E+01	4.967E-27
2.549E+01	8.934E-28
2.600E+01	1.580E-28
2.652E+01	2.884E-29
2.703E+01	5.921E-30
2.754E+01	1.489E-30
2.806E+01	4.575E-31
2.857E+01	1.582E-31
2.908E+01	5.700E-32
2.960E+01	2.059E-32
3.011E+01	7.342E-33
3.062E+01	2.568E-33
3.113E+01	8.792E-34
3.165E+01	2.945E-34
3.216E+01	9.641E-35
3.267E+01	3.085E-35
3.319E+01	9.645E-36
3.370E+01	2.945E-36
3.421E+01	8.777E-37
3.473E+01	2.553E-37
3.524E+01	7.245E-38
3.575E+01	2.005E-38
3.627E+01	5.408E-39
3.678E+01	1.422E-39

NOTICE

Although this program has been tested and experience would indicate that it is accurate within the limits given by the assumptions of the theory used, we make no warranty as to workability of this software or any other licensed material. No warranties either expressed or implied (including warranties of fitness) shall apply. No responsibility is assumed for any errors, mistakes or misrepresentations that may occur from the use of this computer program. The user accepts full responsibility for assessing the validity and applicability of the results obtained with this program for any specific case.

POLLUTEv7

Version 7.13

Copyright (c) 2007.

GAEA Technologies Ltd., R.K. Rowe and J.R. Booker

DB ClayThick

THE DARCY VELOCITY (Flux) THROUGH THE LAYERS $V_a = 0.000203$ m/year

Layer Properties

Layer	Thickness	Number of Sublayers	Coefficient of Hydrodynamic Dispersion	Matrix Porosity	Distribution Coefficient	Dry Density
Clay	12.13 m	20	0.019 m ² /a	0.37	0 m ³ /kg	1510 kg/m ³
Clay with Sand	25.66 m	50	0.019 m ² /a	0.34	0 m ³ /kg	1510 kg/m ³

Boundary Conditions

Constant Concentration

Source Concentration = 1 mg/L

Infinite Thickness Bottom Boundary

Laplace Transform Parameters

TAU = 7 N = 20 SIG = 0 RNU = 2

Calculated Concentrations at Selected Times and Depths

Time year	Depth m	Concentration mg/L
5	0.000E+00	1.000E+00
	6.065E-01	1.655E-01
	1.213E+00	5.484E-03
	1.820E+00	3.070E-05
	2.426E+00	2.705E-08

3.033E+00	3.911E-12
3.639E+00	2.047E-14
4.245E+00	9.250E-16
4.852E+00	2.531E-17
5.459E+00	4.027E-19
6.065E+00	3.565E-21
6.672E+00	1.665E-23
7.278E+00	3.878E-26
7.885E+00	4.754E-29
8.491E+00	1.723E-31
9.098E+00	2.907E-33
9.704E+00	3.953E-35
1.031E+01	3.779E-37
1.092E+01	2.484E-39
1.152E+01	1.099E-41
1.213E+01	3.391E-44
1.264E+01	2.030E-46
1.316E+01	1.841E-48
1.367E+01	3.552E-50
1.418E+01	0.000E+00
1.470E+01	0.000E+00
1.521E+01	0.000E+00
1.572E+01	0.000E+00
1.624E+01	0.000E+00
1.675E+01	0.000E+00
1.726E+01	0.000E+00
1.778E+01	0.000E+00
1.829E+01	0.000E+00
1.880E+01	0.000E+00
1.931E+01	0.000E+00
1.983E+01	0.000E+00
2.034E+01	0.000E+00
2.085E+01	0.000E+00
2.137E+01	0.000E+00
2.188E+01	0.000E+00
2.239E+01	0.000E+00
2.291E+01	0.000E+00
2.342E+01	0.000E+00
2.393E+01	0.000E+00
2.445E+01	0.000E+00
2.496E+01	0.000E+00
2.547E+01	0.000E+00
2.599E+01	0.000E+00
2.650E+01	0.000E+00
2.701E+01	0.000E+00
2.753E+01	0.000E+00
2.804E+01	0.000E+00
2.855E+01	0.000E+00
2.907E+01	0.000E+00
2.958E+01	0.000E+00
3.009E+01	0.000E+00
3.061E+01	0.000E+00
3.112E+01	0.000E+00
3.163E+01	0.000E+00
3.214E+01	0.000E+00
3.266E+01	0.000E+00
3.317E+01	0.000E+00

	3.368E+01	0.000E+00
	3.420E+01	0.000E+00
	3.471E+01	0.000E+00
	3.522E+01	0.000E+00
	3.574E+01	0.000E+00
	3.625E+01	0.000E+00
	3.676E+01	0.000E+00
	3.728E+01	0.000E+00
	3.779E+01	0.000E+00
10	0.000E+00	1.000E+00
	6.065E-01	3.280E-01
	1.213E+00	4.996E-02
	1.820E+00	3.245E-03
	2.426E+00	8.598E-05
	3.033E+00	9.071E-07
	3.639E+00	3.758E-09
	4.245E+00	6.375E-12
	4.852E+00	5.766E-14
	5.459E+00	7.165E-15
	6.065E+00	7.474E-16
	6.672E+00	6.052E-17
	7.278E+00	3.754E-18
	7.885E+00	1.758E-19
	8.491E+00	6.110E-21
	9.098E+00	1.548E-22
	9.704E+00	2.799E-24
	1.031E+01	3.543E-26
	1.092E+01	3.189E-28
	1.152E+01	3.044E-30
	1.213E+01	1.040E-31
	1.264E+01	9.257E-33
	1.316E+01	7.764E-34
	1.367E+01	5.788E-35
	1.418E+01	3.804E-36
	1.470E+01	2.195E-37
	1.521E+01	1.106E-38
	1.572E+01	4.847E-40
	1.624E+01	1.838E-41
	1.675E+01	6.026E-43
	1.726E+01	1.726E-44
	1.778E+01	4.596E-46
	1.829E+01	1.408E-47
	1.880E+01	6.586E-49
	1.931E+01	4.242E-50
	1.983E+01	0.000E+00
	2.034E+01	0.000E+00
	2.085E+01	0.000E+00
	2.137E+01	0.000E+00
	2.188E+01	0.000E+00
	2.239E+01	0.000E+00
	2.291E+01	0.000E+00
	2.342E+01	0.000E+00
	2.393E+01	0.000E+00
	2.445E+01	0.000E+00
	2.496E+01	0.000E+00
	2.547E+01	0.000E+00

	1.829E+01	5.942E-38
	1.880E+01	4.977E-39
	1.931E+01	3.795E-40
	1.983E+01	2.627E-41
	2.034E+01	1.650E-42
	2.085E+01	9.427E-44
	2.137E+01	4.990E-45
	2.188E+01	2.598E-46
	2.239E+01	1.539E-47
	2.291E+01	1.220E-48
	2.342E+01	1.245E-49
	2.393E+01	1.387E-50
	2.445E+01	0.000E+00
	2.496E+01	0.000E+00
	2.547E+01	0.000E+00
	2.599E+01	0.000E+00
	2.650E+01	0.000E+00
	2.701E+01	0.000E+00
	2.753E+01	0.000E+00
	2.804E+01	0.000E+00
	2.855E+01	0.000E+00
	2.907E+01	0.000E+00
	2.958E+01	0.000E+00
	3.009E+01	0.000E+00
	3.061E+01	0.000E+00
	3.112E+01	0.000E+00
	3.163E+01	0.000E+00
	3.214E+01	0.000E+00
	3.266E+01	0.000E+00
	3.317E+01	0.000E+00
	3.368E+01	0.000E+00
	3.420E+01	0.000E+00
	3.471E+01	0.000E+00
	3.522E+01	0.000E+00
	3.574E+01	0.000E+00
	3.625E+01	0.000E+00
	3.676E+01	0.000E+00
	3.728E+01	0.000E+00
	3.779E+01	0.000E+00
20	0.000E+00	1.000E+00
	6.065E-01	4.909E-01
	1.213E+00	1.670E-01
	1.820E+00	3.786E-02
	2.426E+00	5.581E-03
	3.033E+00	5.267E-04
	3.639E+00	3.151E-05
	4.245E+00	1.187E-06
	4.852E+00	2.802E-08
	5.459E+00	4.139E-10
	6.065E+00	4.085E-12
	6.672E+00	1.057E-13
	7.278E+00	2.157E-14
	7.885E+00	4.887E-15
	8.491E+00	9.832E-16
	9.098E+00	1.744E-16
	9.704E+00	2.714E-17

	1.031E+01	3.689E-18
	1.092E+01	4.356E-19
	1.152E+01	4.445E-20
	1.213E+01	4.054E-21
	1.264E+01	4.562E-22
	1.316E+01	4.558E-23
	1.367E+01	4.026E-24
	1.418E+01	3.130E-25
	1.470E+01	2.138E-26
	1.521E+01	1.291E-27
	1.572E+01	7.236E-29
	1.624E+01	4.613E-30
	1.675E+01	4.813E-31
	1.726E+01	7.828E-32
	1.778E+01	1.426E-32
	1.829E+01	2.531E-33
	1.880E+01	4.254E-34
	1.931E+01	6.728E-35
	1.983E+01	9.992E-36
	2.034E+01	1.391E-36
	2.085E+01	1.813E-37
	2.137E+01	2.208E-38
	2.188E+01	2.509E-39
	2.239E+01	2.654E-40
	2.291E+01	2.611E-41
	2.342E+01	2.388E-42
	2.393E+01	2.033E-43
	2.445E+01	1.625E-44
	2.496E+01	1.252E-45
	2.547E+01	9.942E-47
	2.599E+01	9.142E-48
	2.650E+01	1.061E-48
	2.701E+01	1.478E-49
	2.753E+01	2.208E-50
	2.804E+01	0.000E+00
	2.855E+01	0.000E+00
	2.907E+01	0.000E+00
	2.958E+01	0.000E+00
	3.009E+01	0.000E+00
	3.061E+01	0.000E+00
	3.112E+01	0.000E+00
	3.163E+01	0.000E+00
	3.214E+01	0.000E+00
	3.266E+01	0.000E+00
	3.317E+01	0.000E+00
	3.368E+01	0.000E+00
	3.420E+01	0.000E+00
	3.471E+01	0.000E+00
	3.522E+01	0.000E+00
	3.574E+01	0.000E+00
	3.625E+01	0.000E+00
	3.676E+01	0.000E+00
	3.728E+01	0.000E+00
	3.779E+01	0.000E+00
25	0.000E+00	1.000E+00
	6.065E-01	5.384E-01

1.213E+00	2.171E-01
1.820E+00	6.358E-02
2.426E+00	1.327E-02
3.033E+00	1.946E-03
3.639E+00	1.990E-04
4.245E+00	1.410E-05
4.852E+00	6.888E-07
5.459E+00	2.315E-08
6.065E+00	5.348E-10
6.672E+00	8.789E-12
7.278E+00	2.109E-13
7.885E+00	3.731E-14
8.491E+00	1.020E-14
9.098E+00	2.580E-15
9.704E+00	5.909E-16
1.031E+01	1.222E-16
1.092E+01	2.275E-17
1.152E+01	3.803E-18
1.213E+01	5.910E-19
1.264E+01	1.080E-19
1.316E+01	1.810E-20
1.367E+01	2.775E-21
1.418E+01	3.880E-22
1.470E+01	4.933E-23
1.521E+01	5.683E-24
1.572E+01	5.914E-25
1.624E+01	5.547E-26
1.675E+01	4.698E-27
1.726E+01	3.652E-28
1.778E+01	2.803E-29
1.829E+01	2.630E-30
1.880E+01	3.837E-31
1.931E+01	7.720E-32
1.983E+01	1.685E-32
2.034E+01	3.615E-33
2.085E+01	7.432E-34
2.137E+01	1.457E-34
2.188E+01	2.716E-35
2.239E+01	4.813E-36
2.291E+01	8.096E-37
2.342E+01	1.291E-37
2.393E+01	1.950E-38
2.445E+01	2.785E-39
2.496E+01	3.758E-40
2.547E+01	4.786E-41
2.599E+01	5.747E-42
2.650E+01	6.512E-43
2.701E+01	6.987E-44
2.753E+01	7.173E-45
2.804E+01	7.243E-46
2.855E+01	7.626E-47
2.907E+01	9.150E-48
2.958E+01	1.326E-48
3.009E+01	2.242E-49
3.061E+01	4.068E-50
3.112E+01	0.000E+00
3.163E+01	0.000E+00

	3.214E+01	0.000E+00
	3.266E+01	0.000E+00
	3.317E+01	0.000E+00
	3.368E+01	0.000E+00
	3.420E+01	0.000E+00
	3.471E+01	0.000E+00
	3.522E+01	0.000E+00
	3.574E+01	0.000E+00
	3.625E+01	0.000E+00
	3.676E+01	0.000E+00
	3.728E+01	0.000E+00
	3.779E+01	0.000E+00
30	0.000E+00	1.000E+00
	6.065E-01	5.750E-01
	1.213E+00	2.604E-01
	1.820E+00	9.070E-02
	2.426E+00	2.390E-02
	3.033E+00	4.710E-03
	3.639E+00	6.890E-04
	4.245E+00	7.442E-05
	4.852E+00	5.911E-06
	5.459E+00	3.442E-07
	6.065E+00	1.467E-08
	6.672E+00	4.574E-10
	7.278E+00	1.074E-11
	7.885E+00	3.121E-13
	8.491E+00	5.049E-14
	9.098E+00	1.545E-14
	9.704E+00	4.542E-15
	1.031E+01	1.232E-15
	1.092E+01	3.073E-16
	1.152E+01	7.044E-17
	1.213E+01	1.535E-17
	1.264E+01	3.810E-18
	1.316E+01	8.843E-19
	1.367E+01	1.915E-19
	1.418E+01	3.864E-20
	1.470E+01	7.245E-21
	1.521E+01	1.260E-21
	1.572E+01	2.026E-22
	1.624E+01	3.007E-23
	1.675E+01	4.108E-24
	1.726E+01	5.156E-25
	1.778E+01	5.934E-26
	1.829E+01	6.270E-27
	1.880E+01	6.149E-28
	1.931E+01	5.848E-29
	1.983E+01	6.158E-30
	2.034E+01	8.927E-31
	2.085E+01	1.848E-31
	2.137E+01	4.503E-32
	2.188E+01	1.123E-32
	2.239E+01	2.734E-33
	2.291E+01	6.415E-34
	2.342E+01	1.446E-34
	2.393E+01	3.126E-35

	2.445E+01 2.496E+01 2.547E+01 2.599E+01 2.650E+01 2.701E+01 2.753E+01 2.804E+01 2.855E+01 2.907E+01 2.958E+01 3.009E+01 3.061E+01 3.112E+01 3.163E+01 3.214E+01 3.266E+01 3.317E+01 3.368E+01 3.420E+01 3.471E+01 3.522E+01 3.574E+01 3.625E+01 3.676E+01 3.728E+01 3.779E+01	6.477E-36 1.285E-36 2.441E-37 4.430E-38 7.680E-39 1.270E-39 2.003E-40 3.008E-41 4.303E-42 5.865E-43 7.641E-44 9.591E-45 1.183E-45 1.491E-46 2.052E-47 3.275E-48 6.084E-49 1.246E-49 2.645E-50 0.000E+00 0.000E+00 0.000E+00 0.000E+00 0.000E+00 0.000E+00 0.000E+00 0.000E+00
35	0.000E+00 6.065E-01 1.213E+00 1.820E+00 2.426E+00 3.033E+00 3.639E+00 4.245E+00 4.852E+00 5.459E+00 6.065E+00 6.672E+00 7.278E+00 7.885E+00 8.491E+00 9.098E+00 9.704E+00 1.031E+01 1.092E+01 1.152E+01 1.213E+01 1.264E+01 1.316E+01 1.367E+01 1.418E+01 1.470E+01 1.521E+01 1.572E+01 1.624E+01	1.000E+00 6.042E-01 2.980E-01 1.177E-01 3.667E-02 8.932E-03 1.689E-03 2.467E-04 2.773E-05 2.392E-06 1.581E-07 7.989E-09 3.091E-10 9.447E-12 3.514E-13 5.884E-14 1.947E-14 6.369E-15 1.948E-15 5.564E-16 1.531E-16 4.696E-17 1.363E-17 3.740E-18 9.687E-19 2.365E-19 5.434E-20 1.173E-20 2.375E-21

	1.675E+01 1.726E+01 1.778E+01 1.829E+01 1.880E+01 1.931E+01 1.983E+01 2.034E+01 2.085E+01 2.137E+01 2.188E+01 2.239E+01 2.291E+01 2.342E+01 2.393E+01 2.445E+01 2.496E+01 2.547E+01 2.599E+01 2.650E+01 2.701E+01 2.753E+01 2.804E+01 2.855E+01 2.907E+01 2.958E+01 3.009E+01 3.061E+01 3.112E+01 3.163E+01 3.214E+01 3.266E+01 3.317E+01 3.368E+01 3.420E+01 3.471E+01 3.522E+01 3.574E+01 3.625E+01 3.676E+01 3.728E+01 3.779E+01	4.501E-22 7.969E-23 1.316E-23 2.022E-24 2.887E-25 3.827E-26 4.718E-27 5.470E-28 6.195E-29 7.629E-30 1.220E-30 2.693E-31 7.127E-32 1.974E-32 5.403E-33 1.438E-33 3.699E-34 9.191E-35 2.203E-35 5.093E-36 1.134E-36 2.431E-37 5.015E-38 9.944E-39 1.894E-39 3.464E-40 6.077E-41 1.023E-41 1.650E-42 2.557E-43 3.821E-44 5.553E-45 8.005E-46 1.188E-46 1.915E-47 3.514E-48 7.354E-49 1.682E-49 3.997E-50 0.000E+00 0.000E+00 0.000E+00
40	0.000E+00 6.065E-01 1.213E+00 1.820E+00 2.426E+00 3.033E+00 3.639E+00 4.245E+00 4.852E+00 5.459E+00 6.065E+00 6.672E+00 7.278E+00 7.885E+00	1.000E+00 6.282E-01 3.309E-01 1.437E-01 5.084E-02 1.453E-02 3.331E-03 6.103E-04 8.904E-05 1.032E-05 9.476E-07 6.889E-08 3.960E-09 1.804E-10

8.491E+00	6.777E-12
9.098E+00	3.263E-13
9.704E+00	6.182E-14
1.031E+01	2.186E-14
1.092E+01	7.751E-15
1.152E+01	2.603E-15
1.213E+01	8.499E-16
1.264E+01	3.042E-16
1.316E+01	1.039E-16
1.367E+01	3.388E-17
1.418E+01	1.052E-17
1.470E+01	3.109E-18
1.521E+01	8.735E-19
1.572E+01	2.330E-19
1.624E+01	5.894E-20
1.675E+01	1.412E-20
1.726E+01	3.198E-21
1.778E+01	6.838E-22
1.829E+01	1.378E-22
1.880E+01	2.615E-23
1.931E+01	4.662E-24
1.983E+01	7.797E-25
2.034E+01	1.222E-25
2.085E+01	1.796E-26
2.137E+01	2.481E-27
2.188E+01	3.269E-28
2.239E+01	4.284E-29
2.291E+01	6.193E-30
2.342E+01	1.145E-30
2.393E+01	2.805E-31
2.445E+01	8.066E-32
2.496E+01	2.426E-32
2.547E+01	7.253E-33
2.599E+01	2.118E-33
2.650E+01	6.010E-34
2.701E+01	1.655E-34
2.753E+01	4.416E-35
2.804E+01	1.142E-35
2.855E+01	2.858E-36
2.907E+01	6.925E-37
2.958E+01	1.623E-37
3.009E+01	3.675E-38
3.061E+01	8.040E-39
3.112E+01	1.698E-39
3.163E+01	3.460E-40
3.214E+01	6.800E-41
3.266E+01	1.288E-41
3.317E+01	2.353E-42
3.368E+01	4.147E-43
3.420E+01	7.070E-44
3.471E+01	1.173E-44
3.522E+01	1.917E-45
3.574E+01	3.160E-46
3.625E+01	5.466E-47
3.676E+01	1.038E-47
3.728E+01	2.223E-48
3.779E+01	5.297E-49

45

0.000E+00	1.000E+00
6.065E-01	6.484E-01
1.213E+00	3.598E-01
1.820E+00	1.685E-01
2.426E+00	6.582E-02
3.033E+00	2.130E-02
3.639E+00	5.679E-03
4.245E+00	1.241E-03
4.852E+00	2.219E-04
5.459E+00	3.235E-05
6.065E+00	3.839E-06
6.672E+00	3.704E-07
7.278E+00	2.901E-08
7.885E+00	1.845E-09
8.491E+00	9.561E-11
9.098E+00	4.268E-12
9.704E+00	2.689E-13
1.031E+01	6.041E-14
1.092E+01	2.274E-14
1.152E+01	8.619E-15
1.213E+01	3.207E-15
1.264E+01	1.291E-15
1.316E+01	4.997E-16
1.367E+01	1.856E-16
1.418E+01	6.616E-17
1.470E+01	2.260E-17
1.521E+01	7.391E-18
1.572E+01	2.313E-18
1.624E+01	6.916E-19
1.675E+01	1.975E-19
1.726E+01	5.378E-20
1.778E+01	1.395E-20
1.829E+01	3.443E-21
1.880E+01	8.074E-22
1.931E+01	1.797E-22
1.983E+01	3.791E-23
2.034E+01	7.568E-24
2.085E+01	1.428E-24
2.137E+01	2.544E-25
2.188E+01	4.279E-26
2.239E+01	6.800E-27
2.291E+01	1.028E-27
2.342E+01	1.506E-28
2.393E+01	2.258E-29
2.445E+01	3.858E-30
2.496E+01	8.430E-31
2.547E+01	2.331E-31
2.599E+01	7.280E-32
2.650E+01	2.349E-32
2.701E+01	7.523E-33
2.753E+01	2.361E-33
2.804E+01	7.222E-34
2.855E+01	2.151E-34
2.907E+01	6.232E-35
2.958E+01	1.756E-35
3.009E+01	4.808E-36

	3.061E+01 3.112E+01 3.163E+01 3.214E+01 3.266E+01 3.317E+01 3.368E+01 3.420E+01 3.471E+01 3.522E+01 3.574E+01 3.625E+01 3.676E+01 3.728E+01 3.779E+01	1.279E-36 3.303E-37 8.280E-38 2.013E-38 4.745E-39 1.084E-39 2.397E-40 5.134E-41 1.064E-41 2.136E-42 4.153E-43 7.840E-44 1.444E-44 2.620E-45 4.773E-46
50	0.000E+00 6.065E-01 1.213E+00 1.820E+00 2.426E+00 3.033E+00 3.639E+00 4.245E+00 4.852E+00 5.459E+00 6.065E+00 6.672E+00 7.278E+00 7.885E+00 8.491E+00 9.098E+00 9.704E+00 1.031E+01 1.092E+01 1.152E+01 1.213E+01 1.264E+01 1.316E+01 1.367E+01 1.418E+01 1.470E+01 1.521E+01 1.572E+01 1.624E+01 1.675E+01 1.726E+01 1.778E+01 1.829E+01 1.880E+01 1.931E+01 1.983E+01 2.034E+01 2.085E+01 2.137E+01 2.188E+01 2.239E+01	1.000E+00 6.657E-01 3.855E-01 1.918E-01 8.119E-02 2.905E-02 8.736E-03 2.200E-03 4.628E-04 8.108E-05 1.181E-05 1.429E-06 1.435E-07 1.194E-08 8.232E-10 4.743E-11 2.478E-12 2.084E-13 5.626E-14 2.252E-14 9.258E-15 4.092E-15 1.746E-15 7.191E-16 2.855E-16 1.092E-16 4.024E-17 1.426E-17 4.860E-18 1.591E-18 4.998E-19 1.506E-19 4.346E-20 1.201E-20 3.170E-21 7.997E-22 1.924E-22 4.411E-23 9.626E-24 1.997E-24 3.935E-25

	2.291E+01 2.342E+01 2.393E+01 2.445E+01 2.496E+01 2.547E+01 2.599E+01 2.650E+01 2.701E+01 2.753E+01 2.804E+01 2.855E+01 2.907E+01 2.958E+01 3.009E+01 3.061E+01 3.112E+01 3.163E+01 3.214E+01 3.266E+01 3.317E+01 3.368E+01 3.420E+01 3.471E+01 3.522E+01 3.574E+01 3.625E+01 3.676E+01 3.728E+01 3.779E+01	7.360E-26 1.307E-26 2.214E-27 3.612E-28 5.854E-29 1.010E-29 2.070E-30 5.372E-31 1.669E-31 5.619E-32 1.923E-32 6.516E-33 2.165E-33 7.029E-34 2.228E-34 6.888E-35 2.077E-35 6.103E-36 1.747E-36 4.872E-37 1.323E-37 3.494E-38 8.976E-39 2.242E-39 5.443E-40 1.284E-40 2.940E-41 6.539E-42 1.413E-42 2.967E-43
55	0.000E+00 6.065E-01 1.213E+00 1.820E+00 2.426E+00 3.033E+00 3.639E+00 4.245E+00 4.852E+00 5.459E+00 6.065E+00 6.672E+00 7.278E+00 7.885E+00 8.491E+00 9.098E+00 9.704E+00 1.031E+01 1.092E+01 1.152E+01 1.213E+01 1.264E+01 1.316E+01 1.367E+01 1.418E+01 1.470E+01	1.000E+00 6.807E-01 4.085E-01 2.137E-01 9.664E-02 3.754E-02 1.247E-02 3.527E-03 8.474E-04 1.726E-04 2.975E-05 4.332E-06 5.326E-07 5.523E-08 4.829E-09 3.562E-10 2.249E-11 1.378E-12 1.585E-13 5.100E-14 2.208E-14 1.050E-14 4.850E-15 2.170E-15 9.400E-16 3.940E-16

1.521E+01	1.597E-16
1.572E+01	6.255E-17
1.624E+01	2.367E-17
1.675E+01	8.642E-18
1.726E+01	3.044E-18
1.778E+01	1.033E-18
1.829E+01	3.378E-19
1.880E+01	1.063E-19
1.931E+01	3.215E-20
1.983E+01	9.342E-21
2.034E+01	2.605E-21
2.085E+01	6.968E-22
2.137E+01	1.785E-22
2.188E+01	4.377E-23
2.239E+01	1.026E-23
2.291E+01	2.297E-24
2.342E+01	4.908E-25
2.393E+01	1.000E-25
2.445E+01	1.944E-26
2.496E+01	3.614E-27
2.547E+01	6.471E-28
2.599E+01	1.138E-28
2.650E+01	2.062E-29
2.701E+01	4.187E-30
2.753E+01	1.040E-30
2.804E+01	3.161E-31
2.855E+01	1.084E-31
2.907E+01	3.884E-32
2.958E+01	1.396E-32
3.009E+01	4.950E-33
3.061E+01	1.723E-33
3.112E+01	5.869E-34
3.163E+01	1.956E-34
3.214E+01	6.373E-35
3.266E+01	2.029E-35
3.317E+01	6.314E-36
3.368E+01	1.918E-36
3.420E+01	5.690E-37
3.471E+01	1.647E-37
3.522E+01	4.651E-38
3.574E+01	1.281E-38
3.625E+01	3.439E-39
3.676E+01	8.996E-40
3.728E+01	2.292E-40
3.779E+01	5.689E-41

NOTICE

Although this program has been tested and experience would indicate that it is accurate within the limits given by the assumptions of the theory used, we make no warranty as to workability of this software or any other licensed material. No warranties either expressed or implied (including warranties of fitness) shall apply. No responsibility is assumed for any errors, mistakes or misrepresentations that may occur from the use of this computer program. The user accepts full responsibility for assessing the validity and applicability of the results obtained with this program for any specific case.

POLLUTEv7

Version 7.13

Copyright (c) 2007.
GAEA Technologies Ltd., R.K. Rowe and J.R. Booker

DB ClayThin

THE DARCY VELOCITY (Flux) THROUGH THE LAYERS $V_a = 0.000203$ m/year

Layer Properties

Layer	Thickness	Number of Sublayers	Coefficient of Hydrodynamic Dispersion	Matrix Porosity	Distribution Coefficient	Dry Density
Clay	10.69 m	20	0.019 m ² /a	0.37	0 m ³ /kg	1510 kg/m ³
Clay with Sand	25.66 m	50	0.019 m ² /a	0.34	0 m ³ /kg	1510 kg/m ³

Boundary Conditions

Constant Concentration

Source Concentration = 1 mg/L

Infinite Thickness Bottom Boundary

Laplace Transform Parameters

TAU = 7 N = 20 SIG = 0 RNU = 2

Calculated Concentrations at Selected Times and Depths

Time year	Depth m	Concentration mg/L	
5	0.000E+00	1.000E+00	
	5.345E-01	2.218E-01	
	1.069E+00	1.441E-02	
	1.603E+00	2.399E-04	
	2.138E+00	9.640E-07	

2.672E+00	9.079E-10
3.207E+00	3.346E-13
3.741E+00	1.252E-14
4.276E+00	7.814E-16
4.810E+00	3.292E-17
5.345E+00	9.126E-19
5.879E+00	1.615E-20
6.414E+00	1.764E-22
6.948E+00	1.142E-24
7.483E+00	4.249E-27
8.017E+00	1.106E-29
8.552E+00	1.127E-31
9.086E+00	3.133E-33
9.621E+00	7.263E-35
1.016E+01	1.284E-36
1.069E+01	1.777E-38
1.120E+01	2.111E-40
1.172E+01	1.877E-42
1.223E+01	1.263E-44
1.274E+01	7.682E-47
1.326E+01	8.223E-49
1.377E+01	1.703E-50
1.428E+01	0.000E+00
1.480E+01	0.000E+00
1.531E+01	0.000E+00
1.582E+01	0.000E+00
1.634E+01	0.000E+00
1.685E+01	0.000E+00
1.736E+01	0.000E+00
1.787E+01	0.000E+00
1.839E+01	0.000E+00
1.890E+01	0.000E+00
1.941E+01	0.000E+00
1.993E+01	0.000E+00
2.044E+01	0.000E+00
2.095E+01	0.000E+00
2.147E+01	0.000E+00
2.198E+01	0.000E+00
2.249E+01	0.000E+00
2.301E+01	0.000E+00
2.352E+01	0.000E+00
2.403E+01	0.000E+00
2.455E+01	0.000E+00
2.506E+01	0.000E+00
2.557E+01	0.000E+00
2.609E+01	0.000E+00
2.660E+01	0.000E+00
2.711E+01	0.000E+00
2.763E+01	0.000E+00
2.814E+01	0.000E+00
2.865E+01	0.000E+00
2.917E+01	0.000E+00
2.968E+01	0.000E+00
3.019E+01	0.000E+00
3.070E+01	0.000E+00
3.122E+01	0.000E+00
3.173E+01	0.000E+00

	3.224E+01	0.000E+00
	3.276E+01	0.000E+00
	3.327E+01	0.000E+00
	3.378E+01	0.000E+00
	3.430E+01	0.000E+00
	3.481E+01	0.000E+00
	3.532E+01	0.000E+00
	3.584E+01	0.000E+00
	3.635E+01	0.000E+00
10	0.000E+00	1.000E+00
	5.345E-01	3.889E-01
	1.069E+00	8.418E-02
	1.603E+00	9.507E-03
	2.138E+00	5.402E-04
	2.672E+00	1.512E-05
	3.207E+00	2.060E-07
	3.741E+00	1.355E-09
	4.276E+00	4.568E-12
	4.810E+00	6.778E-14
	5.345E+00	1.065E-14
	5.879E+00	1.532E-15
	6.414E+00	1.816E-16
	6.948E+00	1.758E-17
	7.483E+00	1.377E-18
	8.017E+00	8.637E-20
	8.552E+00	4.284E-21
	9.086E+00	1.659E-22
	9.621E+00	4.948E-24
	1.016E+01	1.120E-25
	1.069E+01	2.003E-27
	1.120E+01	3.431E-29
	1.172E+01	9.202E-31
	1.223E+01	6.482E-32
	1.274E+01	5.780E-33
	1.326E+01	4.745E-34
	1.377E+01	3.453E-35
	1.428E+01	2.214E-36
	1.480E+01	1.245E-37
	1.531E+01	6.107E-39
	1.582E+01	2.603E-40
	1.634E+01	9.596E-42
	1.685E+01	3.059E-43
	1.736E+01	8.570E-45
	1.787E+01	2.292E-46
	1.839E+01	7.502E-48
	1.890E+01	3.817E-49
	1.941E+01	2.524E-50
	1.993E+01	0.000E+00
	2.044E+01	0.000E+00
	2.095E+01	0.000E+00
	2.147E+01	0.000E+00
	2.198E+01	0.000E+00
	2.249E+01	0.000E+00
	2.301E+01	0.000E+00
	2.352E+01	0.000E+00
	2.403E+01	0.000E+00

	9.086E+00	1.801E-16
	9.621E+00	3.528E-17
	1.016E+01	6.230E-18
	1.069E+01	1.027E-18
	1.120E+01	1.576E-19
	1.172E+01	2.174E-20
	1.223E+01	2.682E-21
	1.274E+01	2.950E-22
	1.326E+01	2.879E-23
	1.377E+01	2.482E-24
	1.428E+01	1.882E-25
	1.480E+01	1.253E-26
	1.531E+01	7.412E-28
	1.582E+01	4.161E-29
	1.634E+01	2.844E-30
	1.685E+01	3.312E-31
	1.736E+01	5.625E-32
	1.787E+01	1.025E-32
	1.839E+01	1.802E-33
	1.890E+01	2.994E-34
	1.941E+01	4.679E-35
	1.993E+01	6.863E-36
	2.044E+01	9.435E-37
	2.095E+01	1.214E-37
	2.147E+01	1.458E-38
	2.198E+01	1.634E-39
	2.249E+01	1.705E-40
	2.301E+01	1.654E-41
	2.352E+01	1.491E-42
	2.403E+01	1.253E-43
	2.455E+01	9.914E-45
	2.506E+01	7.631E-46
	2.557E+01	6.171E-47
	2.609E+01	5.919E-48
	2.660E+01	7.176E-49
	2.711E+01	1.021E-49
	2.763E+01	1.531E-50
	2.814E+01	0.000E+00
	2.865E+01	0.000E+00
	2.917E+01	0.000E+00
	2.968E+01	0.000E+00
	3.019E+01	0.000E+00
	3.070E+01	0.000E+00
	3.122E+01	0.000E+00
	3.173E+01	0.000E+00
	3.224E+01	0.000E+00
	3.276E+01	0.000E+00
	3.327E+01	0.000E+00
	3.378E+01	0.000E+00
	3.430E+01	0.000E+00
	3.481E+01	0.000E+00
	3.532E+01	0.000E+00
	3.584E+01	0.000E+00
	3.635E+01	0.000E+00
25	0.000E+00	1.000E+00
	5.345E-01	5.879E-01

1.069E+00
1.603E+00
2.138E+00
2.672E+00
3.207E+00
3.741E+00
4.276E+00
4.810E+00
5.345E+00
5.879E+00
6.414E+00
6.948E+00
7.483E+00
8.017E+00
8.552E+00
9.086E+00
9.621E+00
1.016E+01
1.069E+01
1.120E+01
1.172E+01
1.223E+01
1.274E+01
1.326E+01
1.377E+01
1.428E+01
1.480E+01
1.531E+01
1.582E+01
1.634E+01
1.685E+01
1.736E+01
1.787E+01
1.839E+01
1.890E+01
1.941E+01
1.993E+01
2.044E+01
2.095E+01
2.147E+01
2.198E+01
2.249E+01
2.301E+01
2.352E+01
2.403E+01
2.455E+01
2.506E+01
2.557E+01
2.609E+01
2.660E+01
2.711E+01
2.763E+01
2.814E+01
2.865E+01
2.917E+01
2.968E+01
3.019E+01

2.770E-01
1.023E-01
2.915E-02
6.348E-03
1.048E-03
1.305E-04
1.222E-05
8.570E-07
4.495E-08
1.761E-09
5.194E-11
1.337E-12
9.919E-14
2.812E-14
8.925E-15
2.647E-15
7.273E-16
1.850E-16
4.505E-17
1.034E-17
2.192E-18
4.285E-19
7.701E-20
1.269E-20
1.912E-21
2.625E-22
3.274E-23
3.699E-24
3.773E-25
3.469E-26
2.883E-27
2.216E-28
1.730E-29
1.748E-30
2.771E-31
5.748E-32
1.256E-32
2.674E-33
5.447E-34
1.057E-34
1.953E-35
3.426E-36
5.704E-37
9.001E-38
1.345E-38
1.900E-39
2.535E-40
3.192E-41
3.790E-42
4.248E-43
4.513E-44
4.605E-45
4.661E-46
4.997E-47
6.207E-48
9.320E-49
1.608E-49

	3.070E+01	2.934E-50
	3.122E+01	0.000E+00
	3.173E+01	0.000E+00
	3.224E+01	0.000E+00
	3.276E+01	0.000E+00
	3.327E+01	0.000E+00
	3.378E+01	0.000E+00
	3.430E+01	0.000E+00
	3.481E+01	0.000E+00
	3.532E+01	0.000E+00
	3.584E+01	0.000E+00
	3.635E+01	0.000E+00
30	0.000E+00	1.000E+00
	5.345E-01	6.214E-01
	1.069E+00	3.216E-01
	1.603E+00	1.363E-01
	2.138E+00	4.665E-02
	2.672E+00	1.280E-02
	3.207E+00	2.794E-03
	3.741E+00	4.833E-04
	4.276E+00	6.600E-05
	4.810E+00	7.099E-06
	5.345E+00	6.001E-07
	5.879E+00	3.981E-08
	6.414E+00	2.071E-09
	6.948E+00	8.489E-11
	7.483E+00	2.957E-12
	8.017E+00	1.789E-13
	8.552E+00	4.462E-14
	9.086E+00	1.579E-14
	9.621E+00	5.397E-15
	1.016E+01	1.739E-15
	1.069E+01	5.439E-16
	1.120E+01	1.615E-16
	1.172E+01	4.507E-17
	1.223E+01	1.180E-17
	1.274E+01	2.890E-18
	1.326E+01	6.620E-19
	1.377E+01	1.414E-19
	1.428E+01	2.814E-20
	1.480E+01	5.199E-21
	1.531E+01	8.905E-22
	1.582E+01	1.410E-22
	1.634E+01	2.061E-23
	1.685E+01	2.770E-24
	1.736E+01	3.418E-25
	1.787E+01	3.868E-26
	1.839E+01	4.023E-27
	1.890E+01	3.902E-28
	1.941E+01	3.731E-29
	1.993E+01	4.111E-30
	2.044E+01	6.437E-31
	2.095E+01	1.398E-31
	2.147E+01	3.448E-32
	2.198E+01	8.576E-33
	2.249E+01	2.074E-33

	2.301E+01 2.352E+01 2.403E+01 2.455E+01 2.506E+01 2.557E+01 2.609E+01 2.660E+01 2.711E+01 2.763E+01 2.814E+01 2.865E+01 2.917E+01 2.968E+01 3.019E+01 3.070E+01 3.122E+01 3.173E+01 3.224E+01 3.276E+01 3.327E+01 3.378E+01 3.430E+01 3.481E+01 3.532E+01 3.584E+01 3.635E+01	4.828E-34 1.079E-34 2.315E-35 4.757E-36 9.361E-37 1.762E-37 3.170E-38 5.446E-39 8.925E-40 1.394E-40 2.074E-41 2.939E-42 3.970E-43 5.130E-44 6.404E-45 7.899E-46 1.007E-46 1.421E-47 2.341E-48 4.456E-49 9.226E-50 1.963E-50 0.000E+00 0.000E+00 0.000E+00 0.000E+00 0.000E+00
35	0.000E+00 5.345E-01 1.069E+00 1.603E+00 2.138E+00 2.672E+00 3.207E+00 3.741E+00 4.276E+00 4.810E+00 5.345E+00 5.879E+00 6.414E+00 6.948E+00 7.483E+00 8.017E+00 8.552E+00 9.086E+00 9.621E+00 1.016E+01 1.069E+01 1.120E+01 1.172E+01 1.223E+01 1.274E+01 1.326E+01 1.377E+01 1.428E+01 1.480E+01	1.000E+00 6.480E-01 3.594E-01 1.682E-01 6.575E-02 2.129E-02 5.678E-03 1.243E-03 2.224E-04 3.247E-05 3.861E-06 3.733E-07 2.932E-08 1.869E-09 9.717E-11 4.345E-12 2.712E-13 6.015E-14 2.260E-14 8.569E-15 3.189E-15 1.133E-15 3.825E-16 1.225E-16 3.717E-17 1.067E-17 2.896E-18 7.416E-19 1.790E-19

	1.531E+01 1.582E+01 1.634E+01 1.685E+01 1.736E+01 1.787E+01 1.839E+01 1.890E+01 1.941E+01 1.993E+01 2.044E+01 2.095E+01 2.147E+01 2.198E+01 2.249E+01 2.301E+01 2.352E+01 2.403E+01 2.455E+01 2.506E+01 2.557E+01 2.609E+01 2.660E+01 2.711E+01 2.763E+01 2.814E+01 2.865E+01 2.917E+01 2.968E+01 3.019E+01 3.070E+01 3.122E+01 3.173E+01 3.224E+01 3.276E+01 3.327E+01 3.378E+01 3.430E+01 3.481E+01 3.532E+01 3.584E+01 3.635E+01	4.063E-20 8.663E-21 1.732E-21 3.240E-22 5.660E-23 9.218E-24 1.397E-24 1.966E-25 2.568E-26 3.125E-27 3.590E-28 4.086E-29 5.219E-30 8.910E-31 2.066E-31 5.561E-32 1.540E-32 4.197E-33 1.110E-33 2.836E-34 6.999E-35 1.666E-35 3.823E-36 8.451E-37 1.798E-37 3.681E-38 7.244E-39 1.369E-39 2.484E-40 4.322E-41 7.214E-42 1.155E-42 1.776E-43 2.637E-44 3.819E-45 5.517E-46 8.282E-47 1.365E-47 2.574E-48 5.504E-49 1.273E-49 3.033E-50
40	0.000E+00 5.345E-01 1.069E+00 1.603E+00 2.138E+00 2.672E+00 3.207E+00 3.741E+00 4.276E+00 4.810E+00 5.345E+00 5.879E+00 6.414E+00 6.948E+00	1.000E+00 6.697E-01 3.919E-01 1.979E-01 8.548E-02 3.137E-02 9.728E-03 2.541E-03 5.571E-04 1.023E-04 1.572E-05 2.016E-06 2.157E-07 1.924E-08

7.483E+00	1.430E-09
8.017E+00	8.900E-11
8.552E+00	4.858E-12
9.086E+00	3.412E-13
9.621E+00	7.269E-14
1.016E+01	2.851E-14
1.069E+01	1.198E-14
1.120E+01	4.857E-15
1.172E+01	1.886E-15
1.223E+01	7.000E-16
1.274E+01	2.483E-16
1.326E+01	8.408E-17
1.377E+01	2.715E-17
1.428E+01	8.351E-18
1.480E+01	2.444E-18
1.531E+01	6.799E-19
1.582E+01	1.795E-19
1.634E+01	4.494E-20
1.685E+01	1.065E-20
1.736E+01	2.385E-21
1.787E+01	5.044E-22
1.839E+01	1.005E-22
1.890E+01	1.884E-23
1.941E+01	3.317E-24
1.993E+01	5.480E-25
2.044E+01	8.482E-26
2.095E+01	1.231E-26
2.147E+01	1.682E-27
2.198E+01	2.204E-28
2.249E+01	2.913E-29
2.301E+01	4.369E-30
2.352E+01	8.561E-31
2.403E+01	2.189E-31
2.455E+01	6.393E-32
2.506E+01	1.925E-32
2.557E+01	5.734E-33
2.609E+01	1.665E-33
2.660E+01	4.699E-34
2.711E+01	1.286E-34
2.763E+01	3.411E-35
2.814E+01	8.764E-36
2.865E+01	2.180E-36
2.917E+01	5.249E-37
2.968E+01	1.222E-37
3.019E+01	2.749E-38
3.070E+01	5.973E-39
3.122E+01	1.253E-39
3.173E+01	2.535E-40
3.224E+01	4.947E-41
3.276E+01	9.306E-42
3.327E+01	1.688E-42
3.378E+01	2.955E-43
3.430E+01	5.008E-44
3.481E+01	8.272E-45
3.532E+01	1.351E-45
3.584E+01	2.241E-46
3.635E+01	3.932E-47

45

0.000E+00	1.000E+00
5.345E-01	6.880E-01
1.069E+00	4.201E-01
1.603E+00	2.252E-01
2.138E+00	1.052E-01
2.672E+00	4.259E-02
3.207E+00	1.486E-02
3.741E+00	4.454E-03
4.276E+00	1.144E-03
4.810E+00	2.513E-04
5.345E+00	4.711E-05
5.879E+00	7.531E-06
6.414E+00	1.025E-06
6.948E+00	1.188E-07
7.483E+00	1.170E-08
8.017E+00	9.806E-10
8.552E+00	7.026E-11
9.086E+00	4.515E-12
9.621E+00	3.672E-13
1.016E+01	8.112E-14
1.069E+01	3.385E-14
1.120E+01	1.505E-14
1.172E+01	6.497E-15
1.223E+01	2.701E-15
1.274E+01	1.079E-15
1.326E+01	4.144E-16
1.377E+01	1.527E-16
1.428E+01	5.398E-17
1.480E+01	1.829E-17
1.531E+01	5.930E-18
1.582E+01	1.840E-18
1.634E+01	5.453E-19
1.685E+01	1.543E-19
1.736E+01	4.162E-20
1.787E+01	1.069E-20
1.839E+01	2.614E-21
1.890E+01	6.068E-22
1.941E+01	1.337E-22
1.993E+01	2.790E-23
2.044E+01	5.510E-24
2.095E+01	1.028E-24
2.147E+01	1.812E-25
2.198E+01	3.013E-26
2.249E+01	4.738E-27
2.301E+01	7.101E-28
2.352E+01	1.039E-28
2.403E+01	1.582E-29
2.455E+01	2.817E-30
2.506E+01	6.480E-31
2.557E+01	1.852E-31
2.609E+01	5.851E-32
2.660E+01	1.889E-32
2.711E+01	6.030E-33
2.763E+01	1.883E-33
2.814E+01	5.731E-34
2.865E+01	1.698E-34

	2.917E+01 2.968E+01 3.019E+01 3.070E+01 3.122E+01 3.173E+01 3.224E+01 3.276E+01 3.327E+01 3.378E+01 3.430E+01 3.481E+01 3.532E+01 3.584E+01 3.635E+01	4.894E-35 1.371E-35 3.734E-36 9.876E-37 2.536E-37 6.319E-38 1.527E-38 3.578E-39 8.121E-40 1.785E-40 3.800E-41 7.827E-42 1.561E-42 3.017E-43 5.666E-44
50	0.000E+00 5.345E-01 1.069E+00 1.603E+00 2.138E+00 2.672E+00 3.207E+00 3.741E+00 4.276E+00 4.810E+00 5.345E+00 5.879E+00 6.414E+00 6.948E+00 7.483E+00 8.017E+00 8.552E+00 9.086E+00 9.621E+00 1.016E+01 1.069E+01 1.120E+01 1.172E+01 1.223E+01 1.274E+01 1.326E+01 1.377E+01 1.428E+01 1.480E+01 1.531E+01 1.582E+01 1.634E+01 1.685E+01 1.736E+01 1.787E+01 1.839E+01 1.890E+01 1.941E+01 1.993E+01 2.044E+01 2.095E+01	1.000E+00 7.036E-01 4.448E-01 2.504E-01 1.247E-01 5.458E-02 2.093E-02 7.008E-03 2.043E-03 5.179E-04 1.139E-04 2.171E-05 3.585E-06 5.120E-07 6.322E-08 6.747E-09 6.226E-10 5.002E-11 3.692E-12 3.524E-13 8.702E-14 3.765E-14 1.748E-14 7.937E-15 3.485E-15 1.477E-15 6.039E-16 2.381E-16 9.042E-17 3.306E-17 1.163E-17 3.932E-18 1.277E-18 3.980E-19 1.189E-19 3.404E-20 9.321E-21 2.440E-21 6.099E-22 1.454E-22 3.302E-23

	2.147E+01 2.198E+01 2.249E+01 2.301E+01 2.352E+01 2.403E+01 2.455E+01 2.506E+01 2.557E+01 2.609E+01 2.660E+01 2.711E+01 2.763E+01 2.814E+01 2.865E+01 2.917E+01 2.968E+01 3.019E+01 3.070E+01 3.122E+01 3.173E+01 3.224E+01 3.276E+01 3.327E+01 3.378E+01 3.430E+01 3.481E+01 3.532E+01 3.584E+01 3.635E+01	7.135E-24 1.466E-24 2.859E-25 5.294E-26 9.313E-27 1.563E-27 2.539E-28 4.137E-29 7.317E-30 1.567E-30 4.243E-31 1.349E-31 4.572E-32 1.564E-32 5.280E-33 1.747E-33 5.645E-34 1.781E-34 5.479E-35 1.644E-35 4.806E-36 1.369E-36 3.798E-37 1.026E-37 2.694E-38 6.885E-39 1.710E-39 4.129E-40 9.683E-41 2.205E-41
55	0.000E+00 5.345E-01 1.069E+00 1.603E+00 2.138E+00 2.672E+00 3.207E+00 3.741E+00 4.276E+00 4.810E+00 5.345E+00 5.879E+00 6.414E+00 6.948E+00 7.483E+00 8.017E+00 8.552E+00 9.086E+00 9.621E+00 1.016E+01 1.069E+01 1.120E+01 1.172E+01 1.223E+01 1.274E+01 1.326E+01	1.000E+00 7.171E-01 4.667E-01 2.736E-01 1.435E-01 6.704E-02 2.779E-02 1.019E-02 3.295E-03 9.392E-04 2.354E-04 5.185E-05 1.002E-05 1.699E-06 2.524E-07 3.284E-08 3.743E-09 3.740E-10 3.306E-11 2.763E-12 3.225E-13 8.911E-14 3.985E-14 1.919E-14 9.077E-15 4.167E-15

1.377E+01	1.853E-15
1.428E+01	7.975E-16
1.480E+01	3.321E-16
1.531E+01	1.337E-16
1.582E+01	5.204E-17
1.634E+01	1.955E-17
1.685E+01	7.091E-18
1.736E+01	2.480E-18
1.787E+01	8.357E-19
1.839E+01	2.712E-19
1.890E+01	8.468E-20
1.941E+01	2.542E-20
1.993E+01	7.328E-21
2.044E+01	2.027E-21
2.095E+01	5.378E-22
2.147E+01	1.366E-22
2.198E+01	3.321E-23
2.249E+01	7.715E-24
2.301E+01	1.712E-24
2.352E+01	3.624E-25
2.403E+01	7.318E-26
2.455E+01	1.410E-26
2.506E+01	2.600E-27
2.557E+01	4.629E-28
2.609E+01	8.149E-29
2.660E+01	1.497E-29
2.711E+01	3.146E-30
2.763E+01	8.155E-31
2.814E+01	2.556E-31
2.865E+01	8.884E-32
2.917E+01	3.191E-32
2.968E+01	1.145E-32
3.019E+01	4.047E-33
3.070E+01	1.403E-33
3.122E+01	4.759E-34
3.173E+01	1.579E-34
3.224E+01	5.123E-35
3.276E+01	1.624E-35
3.327E+01	5.029E-36
3.378E+01	1.521E-36
3.430E+01	4.490E-37
3.481E+01	1.294E-37
3.532E+01	3.635E-38
3.584E+01	9.962E-39
3.635E+01	2.661E-39

NOTICE

Although this program has been tested and experience would indicate that it is accurate within the limits given by the assumptions of the theory used, we make no warranty as to workability of this software or any other licensed material. No warranties either expressed or implied (including warranties of fitness) shall apply. No responsibility is assumed for any errors, mistakes or misrepresentations that may occur from the use of this computer program. The user accepts full responsibility for assessing the validity and applicability of the results obtained with this program for any specific case.

POLLUTEv7

Version 7.13

Copyright (c) 2007.

GAEA Technologies Ltd., R.K. Rowe and J.R. Booker

DB SandThick

THE DARCY VELOCITY (Flux) THROUGH THE LAYERS $V_a = 0.000203$ m/year

Layer Properties

Layer	Thickness	Number of Sublayers	Coefficient of Hydrodynamic Dispersion	Matrix Porosity	Distribution Coefficient	Dry Density
Clay	11.12 m	20	0.019 m ² /a	0.37	0 m ³ /kg	1510 kg/m ³
Clay with Sand	26.82 m	50	0.019 m ² /a	0.34	0 m ³ /kg	1510 kg/m ³

Boundary Conditions

Constant Concentration

Source Concentration = 1 mg/L

Infinite Thickness Bottom Boundary

Laplace Transform Parameters

TAU = 7 N = 20 SIG = 0 RNU = 2

Calculated Concentrations at Selected Times and Depths

Time year	Depth m	Concentration mg/L
5	0.000E+00	1.000E+00
	5.560E-01	2.037E-01
	1.112E+00	1.091E-02
	1.668E+00	1.331E-04
	2.224E+00	3.467E-07

2.780E+00	1.878E-10
3.336E+00	1.005E-13
3.892E+00	5.956E-15
4.448E+00	2.947E-16
5.004E+00	9.449E-18
5.560E+00	1.904E-19
6.116E+00	2.329E-21
6.672E+00	1.657E-23
7.228E+00	6.570E-26
7.784E+00	1.471E-28
8.340E+00	5.331E-31
8.896E+00	1.130E-32
9.452E+00	2.457E-34
1.001E+01	4.021E-36
1.056E+01	4.849E-38
1.112E+01	4.414E-40
1.166E+01	3.308E-42
1.219E+01	1.821E-44
1.273E+01	8.759E-47
1.327E+01	7.615E-49
1.380E+01	1.335E-50
1.434E+01	0.000E+00
1.487E+01	0.000E+00
1.541E+01	0.000E+00
1.595E+01	0.000E+00
1.648E+01	0.000E+00
1.702E+01	0.000E+00
1.756E+01	0.000E+00
1.809E+01	0.000E+00
1.863E+01	0.000E+00
1.917E+01	0.000E+00
1.970E+01	0.000E+00
2.024E+01	0.000E+00
2.078E+01	0.000E+00
2.131E+01	0.000E+00
2.185E+01	0.000E+00
2.238E+01	0.000E+00
2.292E+01	0.000E+00
2.346E+01	0.000E+00
2.399E+01	0.000E+00
2.453E+01	0.000E+00
2.507E+01	0.000E+00
2.560E+01	0.000E+00
2.614E+01	0.000E+00
2.668E+01	0.000E+00
2.721E+01	0.000E+00
2.775E+01	0.000E+00
2.828E+01	0.000E+00
2.882E+01	0.000E+00
2.936E+01	0.000E+00
2.989E+01	0.000E+00
3.043E+01	0.000E+00
3.097E+01	0.000E+00
3.150E+01	0.000E+00
3.204E+01	0.000E+00
3.258E+01	0.000E+00
3.311E+01	0.000E+00

	3.365E+01	0.000E+00
	3.419E+01	0.000E+00
	3.472E+01	0.000E+00
	3.526E+01	0.000E+00
	3.579E+01	0.000E+00
	3.633E+01	0.000E+00
	3.687E+01	0.000E+00
	3.740E+01	0.000E+00
	3.794E+01	0.000E+00
10	0.000E+00	1.000E+00
	5.560E-01	3.700E-01
	1.112E+00	7.240E-02
	1.668E+00	6.979E-03
	2.224E+00	3.189E-04
	2.780E+00	6.756E-06
	3.336E+00	6.551E-08
	3.892E+00	2.891E-10
	4.448E+00	7.541E-13
	5.004E+00	3.374E-14
	5.560E+00	4.993E-15
	6.116E+00	6.111E-16
	6.672E+00	6.039E-17
	7.228E+00	4.770E-18
	7.784E+00	2.978E-19
	8.340E+00	1.451E-20
	8.896E+00	5.443E-22
	9.452E+00	1.547E-23
	1.001E+01	3.277E-25
	1.056E+01	5.130E-27
	1.112E+01	6.604E-29
	1.166E+01	1.327E-30
	1.219E+01	7.713E-32
	1.273E+01	6.164E-33
	1.327E+01	4.520E-34
	1.380E+01	2.907E-35
	1.434E+01	1.627E-36
	1.487E+01	7.882E-38
	1.541E+01	3.289E-39
	1.595E+01	1.176E-40
	1.648E+01	3.584E-42
	1.702E+01	9.341E-44
	1.756E+01	2.153E-45
	1.809E+01	5.109E-47
	1.863E+01	1.750E-48
	1.917E+01	9.274E-50
	1.970E+01	0.000E+00
	2.024E+01	0.000E+00
	2.078E+01	0.000E+00
	2.131E+01	0.000E+00
	2.185E+01	0.000E+00
	2.238E+01	0.000E+00
	2.292E+01	0.000E+00
	2.346E+01	0.000E+00
	2.399E+01	0.000E+00
	2.453E+01	0.000E+00
	2.507E+01	0.000E+00

	9.452E+00	5.974E-17
	1.001E+01	1.015E-17
	1.056E+01	1.538E-18
	1.112E+01	2.150E-19
	1.166E+01	2.754E-20
	1.219E+01	3.127E-21
	1.273E+01	3.131E-22
	1.327E+01	2.752E-23
	1.380E+01	2.112E-24
	1.434E+01	1.408E-25
	1.487E+01	8.154E-27
	1.541E+01	4.170E-28
	1.595E+01	2.085E-29
	1.648E+01	1.435E-30
	1.702E+01	1.787E-31
	1.756E+01	2.944E-32
	1.809E+01	4.920E-33
	1.863E+01	7.796E-34
	1.917E+01	1.157E-34
	1.970E+01	1.605E-35
	2.024E+01	2.075E-36
	2.078E+01	2.497E-37
	2.131E+01	2.791E-38
	2.185E+01	2.892E-39
	2.238E+01	2.773E-40
	2.292E+01	2.456E-41
	2.346E+01	2.008E-42
	2.399E+01	1.519E-43
	2.453E+01	1.075E-44
	2.507E+01	7.373E-46
	2.560E+01	5.346E-47
	2.614E+01	4.703E-48
	2.668E+01	5.326E-49
	2.721E+01	7.054E-50
	2.775E+01	0.000E+00
	2.828E+01	0.000E+00
	2.882E+01	0.000E+00
	2.936E+01	0.000E+00
	2.989E+01	0.000E+00
	3.043E+01	0.000E+00
	3.097E+01	0.000E+00
	3.150E+01	0.000E+00
	3.204E+01	0.000E+00
	3.258E+01	0.000E+00
	3.311E+01	0.000E+00
	3.365E+01	0.000E+00
	3.419E+01	0.000E+00
	3.472E+01	0.000E+00
	3.526E+01	0.000E+00
	3.579E+01	0.000E+00
	3.633E+01	0.000E+00
	3.687E+01	0.000E+00
	3.740E+01	0.000E+00
	3.794E+01	0.000E+00
25	0.000E+00	1.000E+00
	5.560E-01	5.729E-01

1.112E+00
1.668E+00
2.224E+00
2.780E+00
3.336E+00
3.892E+00
4.448E+00
5.004E+00
5.560E+00
6.116E+00
6.672E+00
7.228E+00
7.784E+00
8.340E+00
8.896E+00
9.452E+00
1.001E+01
1.056E+01
1.112E+01
1.166E+01
1.219E+01
1.273E+01
1.327E+01
1.380E+01
1.434E+01
1.487E+01
1.541E+01
1.595E+01
1.648E+01
1.702E+01
1.756E+01
1.809E+01
1.863E+01
1.917E+01
1.970E+01
2.024E+01
2.078E+01
2.131E+01
2.185E+01
2.238E+01
2.292E+01
2.346E+01
2.399E+01
2.453E+01
2.507E+01
2.560E+01
2.614E+01
2.668E+01
2.721E+01
2.775E+01
2.828E+01
2.882E+01
2.936E+01
2.989E+01
3.043E+01
3.097E+01
3.150E+01

2.580E-01
8.913E-02
2.324E-02
4.519E-03
6.506E-04
6.898E-05
5.363E-06
3.049E-07
1.265E-08
3.831E-10
8.758E-12
2.658E-13
4.643E-14
1.416E-14
4.118E-15
1.103E-15
2.717E-16
6.142E-17
1.319E-17
2.638E-18
4.828E-19
8.064E-20
1.225E-20
1.688E-21
2.100E-22
2.353E-23
2.364E-24
2.123E-25
1.702E-26
1.227E-27
8.302E-29
6.201E-30
6.969E-31
1.211E-31
2.448E-32
4.936E-33
9.528E-34
1.746E-34
3.032E-35
4.980E-36
7.727E-37
1.131E-37
1.560E-38
2.023E-39
2.466E-40
2.821E-41
3.027E-42
3.050E-43
2.904E-44
2.658E-45
2.444E-46
2.461E-47
2.983E-48
4.399E-49
7.260E-50
1.234E-50
0.000E+00

	3.204E+01	0.000E+00
	3.258E+01	0.000E+00
	3.311E+01	0.000E+00
	3.365E+01	0.000E+00
	3.419E+01	0.000E+00
	3.472E+01	0.000E+00
	3.526E+01	0.000E+00
	3.579E+01	0.000E+00
	3.633E+01	0.000E+00
	3.687E+01	0.000E+00
	3.740E+01	0.000E+00
	3.794E+01	0.000E+00
30	0.000E+00	1.000E+00
	5.560E-01	6.074E-01
	1.112E+00	3.024E-01
	1.668E+00	1.211E-01
	2.224E+00	3.847E-02
	2.780E+00	9.599E-03
	3.336E+00	1.869E-03
	3.892E+00	2.826E-04
	4.448E+00	3.306E-05
	5.004E+00	2.985E-06
	5.560E+00	2.075E-07
	6.116E+00	1.109E-08
	6.672E+00	4.560E-10
	7.228E+00	1.474E-11
	7.784E+00	5.124E-13
	8.340E+00	7.000E-14
	8.896E+00	2.285E-14
	9.452E+00	7.625E-15
	1.001E+01	2.386E-15
	1.056E+01	6.986E-16
	1.112E+01	1.974E-16
	1.166E+01	5.247E-17
	1.219E+01	1.301E-17
	1.273E+01	3.001E-18
	1.327E+01	6.432E-19
	1.380E+01	1.278E-19
	1.434E+01	2.347E-20
	1.487E+01	3.978E-21
	1.541E+01	6.201E-22
	1.595E+01	8.871E-23
	1.648E+01	1.161E-23
	1.702E+01	1.386E-24
	1.756E+01	1.507E-25
	1.809E+01	1.490E-26
	1.863E+01	1.350E-27
	1.917E+01	1.156E-28
	1.970E+01	1.047E-29
	2.024E+01	1.272E-30
	2.078E+01	2.322E-31
	2.131E+01	5.246E-32
	2.185E+01	1.230E-32
	2.238E+01	2.812E-33
	2.292E+01	6.178E-34
	2.346E+01	1.299E-34

	2.399E+01 2.453E+01 2.507E+01 2.560E+01 2.614E+01 2.668E+01 2.721E+01 2.775E+01 2.828E+01 2.882E+01 2.936E+01 2.989E+01 3.043E+01 3.097E+01 3.150E+01 3.204E+01 3.258E+01 3.311E+01 3.365E+01 3.419E+01 3.472E+01 3.526E+01 3.579E+01 3.633E+01 3.687E+01 3.740E+01 3.794E+01	2.609E-35 5.005E-36 9.154E-37 1.595E-37 2.645E-38 4.171E-39 6.245E-40 8.871E-41 1.195E-41 1.526E-42 1.851E-43 2.146E-44 2.416E-45 2.737E-46 3.334E-47 4.713E-48 7.906E-49 1.492E-49 2.948E-50 0.000E+00 0.000E+00 0.000E+00 0.000E+00 0.000E+00 0.000E+00 0.000E+00 0.000E+00 0.000E+00 0.000E+00
35	0.000E+00 5.560E-01 1.112E+00 1.668E+00 2.224E+00 2.780E+00 3.336E+00 3.892E+00 4.448E+00 5.004E+00 5.560E+00 6.116E+00 6.672E+00 7.228E+00 7.784E+00 8.340E+00 8.896E+00 9.452E+00 1.001E+01 1.056E+01 1.112E+01 1.166E+01 1.219E+01 1.273E+01 1.327E+01 1.380E+01 1.434E+01 1.487E+01 1.541E+01	1.000E+00 6.348E-01 3.403E-01 1.517E-01 5.555E-02 1.658E-02 4.008E-03 7.813E-04 1.224E-04 1.538E-05 1.547E-06 1.243E-07 7.968E-09 4.082E-10 1.702E-11 7.245E-13 9.112E-14 3.054E-14 1.121E-14 3.931E-15 1.344E-15 4.353E-16 1.331E-16 3.837E-17 1.041E-17 2.658E-18 6.366E-19 1.429E-19 2.998E-20

	1.595E+01 1.648E+01 1.702E+01 1.756E+01 1.809E+01 1.863E+01 1.917E+01 1.970E+01 2.024E+01 2.078E+01 2.131E+01 2.185E+01 2.238E+01 2.292E+01 2.346E+01 2.399E+01 2.453E+01 2.507E+01 2.560E+01 2.614E+01 2.668E+01 2.721E+01 2.775E+01 2.828E+01 2.882E+01 2.936E+01 2.989E+01 3.043E+01 3.097E+01 3.150E+01 3.204E+01 3.258E+01 3.311E+01 3.365E+01 3.419E+01 3.472E+01 3.526E+01 3.579E+01 3.633E+01 3.687E+01 3.740E+01 3.794E+01	5.874E-21 1.072E-21 1.818E-22 2.860E-23 4.164E-24 5.597E-25 6.937E-26 7.936E-27 8.451E-28 8.667E-29 9.510E-30 1.359E-30 2.767E-31 6.897E-32 1.802E-32 4.642E-33 1.158E-33 2.783E-34 6.438E-35 1.432E-35 3.059E-36 6.274E-37 1.234E-37 2.326E-38 4.199E-39 7.251E-40 1.197E-40 1.888E-41 2.844E-42 4.098E-43 5.664E-44 7.576E-45 1.000E-45 1.355E-46 2.001E-47 3.400E-48 6.664E-49 1.433E-49 3.198E-50 0.000E+00 0.000E+00 0.000E+00
40	0.000E+00 5.560E-01 1.112E+00 1.668E+00 2.224E+00 2.780E+00 3.336E+00 3.892E+00 4.448E+00 5.004E+00 5.560E+00 6.116E+00 6.672E+00 7.228E+00	1.000E+00 6.572E-01 3.730E-01 1.804E-01 7.356E-02 2.513E-02 7.148E-03 1.687E-03 3.292E-04 5.302E-05 7.032E-06 7.670E-07 6.873E-08 5.056E-09

7.784E+00
8.340E+00
8.896E+00
9.452E+00
1.001E+01
1.056E+01
1.112E+01
1.166E+01
1.219E+01
1.273E+01
1.327E+01
1.380E+01
1.434E+01
1.487E+01
1.541E+01
1.595E+01
1.648E+01
1.702E+01
1.756E+01
1.809E+01
1.863E+01
1.917E+01
1.970E+01
2.024E+01
2.078E+01
2.131E+01
2.185E+01
2.238E+01
2.292E+01
2.346E+01
2.399E+01
2.453E+01
2.507E+01
2.560E+01
2.614E+01
2.668E+01
2.721E+01
2.775E+01
2.828E+01
2.882E+01
2.936E+01
2.989E+01
3.043E+01
3.097E+01
3.150E+01
3.204E+01
3.258E+01
3.311E+01
3.365E+01
3.419E+01
3.472E+01
3.526E+01
3.579E+01
3.633E+01
3.687E+01
3.740E+01
3.794E+01

3.058E-10
1.549E-11
8.040E-13
1.054E-13
3.628E-14
1.434E-14
5.636E-15
2.110E-15
7.523E-16
2.552E-16
8.231E-17
2.520E-17
7.317E-18
2.012E-18
5.232E-19
1.285E-19
2.976E-20
6.487E-21
1.329E-21
2.556E-22
4.602E-23
7.746E-24
1.217E-24
1.781E-25
2.427E-26
3.092E-27
3.729E-28
4.454E-29
5.908E-30
1.028E-30
2.415E-31
6.640E-32
1.894E-32
5.335E-33
1.462E-33
3.880E-34
9.958E-35
2.470E-35
5.916E-36
1.368E-36
3.049E-37
6.552E-38
1.356E-38
2.701E-39
5.176E-40
9.533E-41
1.687E-41
2.868E-42
4.689E-43
7.391E-44
1.131E-44
1.702E-45
2.594E-46
4.188E-47
7.539E-48
1.548E-48
3.538E-49

45

0.000E+00	1.000E+00
5.560E-01	6.761E-01
1.112E+00	4.015E-01
1.668E+00	2.070E-01
2.224E+00	9.189E-02
2.780E+00	3.488E-02
3.336E+00	1.127E-02
3.892E+00	3.086E-03
4.448E+00	7.146E-04
5.004E+00	1.396E-04
5.560E+00	2.297E-05
6.116E+00	3.179E-06
6.672E+00	3.696E-07
7.228E+00	3.608E-08
7.784E+00	2.955E-09
8.340E+00	2.035E-10
8.896E+00	1.205E-11
9.452E+00	7.520E-13
1.001E+01	1.107E-13
1.056E+01	3.994E-14
1.112E+01	1.718E-14
1.166E+01	7.178E-15
1.219E+01	2.879E-15
1.273E+01	1.106E-15
1.327E+01	4.067E-16
1.380E+01	1.430E-16
1.434E+01	4.804E-17
1.487E+01	1.540E-17
1.541E+01	4.709E-18
1.595E+01	1.371E-18
1.648E+01	3.797E-19
1.702E+01	9.993E-20
1.756E+01	2.495E-20
1.809E+01	5.904E-21
1.863E+01	1.322E-21
1.917E+01	2.797E-22
1.970E+01	5.583E-23
2.024E+01	1.050E-23
2.078E+01	1.856E-24
2.131E+01	3.084E-25
2.185E+01	4.810E-26
2.238E+01	7.050E-27
2.292E+01	9.780E-28
2.346E+01	1.314E-28
2.399E+01	1.822E-29
2.453E+01	2.964E-30
2.507E+01	6.362E-31
2.560E+01	1.727E-31
2.614E+01	5.200E-32
2.668E+01	1.594E-32
2.721E+01	4.817E-33
2.775E+01	1.419E-33
2.828E+01	4.064E-34
2.882E+01	1.130E-34
2.936E+01	3.046E-35
2.989E+01	7.963E-36

	3.043E+01 3.097E+01 3.150E+01 3.204E+01 3.258E+01 3.311E+01 3.365E+01 3.419E+01 3.472E+01 3.526E+01 3.579E+01 3.633E+01 3.687E+01 3.740E+01 3.794E+01	2.017E-36 4.949E-37 1.175E-37 2.700E-38 5.997E-39 1.287E-39 2.668E-40 5.338E-41 1.031E-41 1.921E-42 3.458E-43 6.031E-44 1.025E-44 1.720E-45 2.919E-46
50	0.000E+00 5.560E-01 1.112E+00 1.668E+00 2.224E+00 2.780E+00 3.336E+00 3.892E+00 4.448E+00 5.004E+00 5.560E+00 6.116E+00 6.672E+00 7.228E+00 7.784E+00 8.340E+00 8.896E+00 9.452E+00 1.001E+01 1.056E+01 1.112E+01 1.166E+01 1.219E+01 1.273E+01 1.327E+01 1.380E+01 1.434E+01 1.487E+01 1.541E+01 1.595E+01 1.648E+01 1.702E+01 1.756E+01 1.809E+01 1.863E+01 1.917E+01 1.970E+01 2.024E+01 2.078E+01 2.131E+01 2.185E+01	1.000E+00 6.922E-01 4.266E-01 2.317E-01 1.101E-01 4.550E-02 1.628E-02 5.023E-03 1.334E-03 3.043E-04 5.950E-05 9.962E-06 1.427E-06 1.746E-07 1.826E-08 1.630E-09 1.247E-10 8.412E-12 6.270E-13 1.087E-13 4.267E-14 1.913E-14 8.404E-15 3.561E-15 1.452E-15 5.694E-16 2.145E-16 7.757E-17 2.691E-17 8.947E-18 2.849E-18 8.676E-19 2.525E-19 7.017E-20 1.859E-20 4.692E-21 1.127E-21 2.570E-22 5.562E-23 1.141E-23 2.214E-24

	2.238E+01 2.292E+01 2.346E+01 2.399E+01 2.453E+01 2.507E+01 2.560E+01 2.614E+01 2.668E+01 2.721E+01 2.775E+01 2.828E+01 2.882E+01 2.936E+01 2.989E+01 3.043E+01 3.097E+01 3.150E+01 3.204E+01 3.258E+01 3.311E+01 3.365E+01 3.419E+01 3.472E+01 3.526E+01 3.579E+01 3.633E+01 3.687E+01 3.740E+01 3.794E+01	4.063E-25 7.044E-26 1.154E-26 1.796E-27 2.690E-28 4.038E-29 6.641E-30 1.354E-30 3.549E-31 1.090E-31 3.536E-32 1.150E-32 3.674E-33 1.146E-33 3.485E-34 1.032E-34 2.971E-35 8.321E-36 2.266E-36 5.993E-37 1.540E-37 3.840E-38 9.290E-39 2.180E-39 4.957E-40 1.092E-40 2.331E-41 4.817E-42 9.645E-43 1.874E-43
55	0.000E+00 5.560E-01 1.112E+00 1.668E+00 2.224E+00 2.780E+00 3.336E+00 3.892E+00 4.448E+00 5.004E+00 5.560E+00 6.116E+00 6.672E+00 7.228E+00 7.784E+00 8.340E+00 8.896E+00 9.452E+00 1.001E+01 1.056E+01 1.112E+01 1.166E+01 1.219E+01 1.273E+01 1.327E+01 1.380E+01	1.000E+00 7.061E-01 4.489E-01 2.546E-01 1.280E-01 5.671E-02 2.206E-02 7.508E-03 2.231E-03 5.777E-04 1.301E-04 2.546E-05 4.325E-06 6.372E-07 8.136E-08 9.000E-09 8.628E-10 7.203E-11 5.449E-12 4.873E-13 1.044E-13 4.343E-14 2.021E-14 9.257E-15 4.103E-15 1.756E-15

1.434E+01	7.256E-16
1.487E+01	2.891E-16
1.541E+01	1.110E-16
1.595E+01	4.106E-17
1.648E+01	1.462E-17
1.702E+01	5.004E-18
1.756E+01	1.646E-18
1.809E+01	5.198E-19
1.863E+01	1.575E-19
1.917E+01	4.571E-20
1.970E+01	1.270E-20
2.024E+01	3.377E-21
2.078E+01	8.576E-22
2.131E+01	2.078E-22
2.185E+01	4.801E-23
2.238E+01	1.056E-23
2.292E+01	2.209E-24
2.346E+01	4.391E-25
2.399E+01	8.289E-26
2.453E+01	1.486E-26
2.507E+01	2.540E-27
2.560E+01	4.179E-28
2.614E+01	6.811E-29
2.668E+01	1.173E-29
2.721E+01	2.377E-30
2.775E+01	6.087E-31
2.828E+01	1.879E-31
2.882E+01	6.327E-32
2.936E+01	2.174E-32
2.989E+01	7.409E-33
3.043E+01	2.477E-33
3.097E+01	8.096E-34
3.150E+01	2.584E-34
3.204E+01	8.046E-35
3.258E+01	2.444E-35
3.311E+01	7.235E-36
3.365E+01	2.088E-36
3.419E+01	5.869E-37
3.472E+01	1.606E-37
3.526E+01	4.279E-38
3.579E+01	1.109E-38
3.633E+01	2.796E-39
3.687E+01	6.849E-40
3.740E+01	1.631E-40
3.794E+01	3.772E-41

NOTICE

Although this program has been tested and experience would indicate that it is accurate within the limits given by the assumptions of the theory used, we make no warranty as to workability of this software or any other licensed material. No warranties either expressed or implied (including warranties of fitness) shall apply. No responsibility is assumed for any errors, mistakes or misrepresentations that may occur from the use of this computer program. The user accepts full responsibility for assessing the validity and applicability of the results obtained with this program for any specific case.

POLLUTEv7

Version 7.13

Copyright (c) 2007.
GAEA Technologies Ltd., R.K. Rowe and J.R. Booker

DB SandThin

THE DARCY VELOCITY (Flux) THROUGH THE LAYERS $V_a = 0.000203$ m/year

Layer Properties

Layer	Thickness	Number of Sublayers	Coefficient of Hydrodynamic Dispersion	Matrix Porosity	Distribution Coefficient	Dry Density
Clay	11.12 m	20	0.019 m ² /a	0.37	0 m ³ /kg	1510 kg/m ³
Clay with Sand	24.65 m	50	0.019 m ² /a	0.34	0 m ³ /kg	1510 kg/m ³

Boundary Conditions

Constant Concentration

Source Concentration = 1 mg/L

Infinite Thickness Bottom Boundary

Laplace Transform Parameters

TAU = 7 N = 20 SIG = 0 RNU = 2

Calculated Concentrations at Selected Times and Depths

Time year	Depth m	Concentration mg/L
5	0.000E+00	1.000E+00
	5.560E-01	2.037E-01
	1.112E+00	1.091E-02
	1.668E+00	1.331E-04
	2.224E+00	3.467E-07

2.780E+00	1.878E-10
3.336E+00	1.005E-13
3.892E+00	5.956E-15
4.448E+00	2.947E-16
5.004E+00	9.449E-18
5.560E+00	1.904E-19
6.116E+00	2.329E-21
6.672E+00	1.657E-23
7.228E+00	6.570E-26
7.784E+00	1.471E-28
8.340E+00	5.331E-31
8.896E+00	1.130E-32
9.452E+00	2.457E-34
1.001E+01	4.021E-36
1.056E+01	4.849E-38
1.112E+01	4.414E-40
1.161E+01	4.974E-42
1.211E+01	4.304E-44
1.260E+01	3.147E-46
1.309E+01	3.164E-48
1.358E+01	6.662E-50
1.408E+01	0.000E+00
1.457E+01	0.000E+00
1.506E+01	0.000E+00
1.556E+01	0.000E+00
1.605E+01	0.000E+00
1.654E+01	0.000E+00
1.704E+01	0.000E+00
1.753E+01	0.000E+00
1.802E+01	0.000E+00
1.851E+01	0.000E+00
1.901E+01	0.000E+00
1.950E+01	0.000E+00
1.999E+01	0.000E+00
2.049E+01	0.000E+00
2.098E+01	0.000E+00
2.147E+01	0.000E+00
2.197E+01	0.000E+00
2.246E+01	0.000E+00
2.295E+01	0.000E+00
2.344E+01	0.000E+00
2.394E+01	0.000E+00
2.443E+01	0.000E+00
2.492E+01	0.000E+00
2.542E+01	0.000E+00
2.591E+01	0.000E+00
2.640E+01	0.000E+00
2.690E+01	0.000E+00
2.739E+01	0.000E+00
2.788E+01	0.000E+00
2.837E+01	0.000E+00
2.887E+01	0.000E+00
2.936E+01	0.000E+00
2.985E+01	0.000E+00
3.035E+01	0.000E+00
3.084E+01	0.000E+00
3.133E+01	0.000E+00

	3.183E+01	0.000E+00
	3.232E+01	0.000E+00
	3.281E+01	0.000E+00
	3.330E+01	0.000E+00
	3.380E+01	0.000E+00
	3.429E+01	0.000E+00
	3.478E+01	0.000E+00
	3.528E+01	0.000E+00
	3.577E+01	0.000E+00
10	0.000E+00	1.000E+00
	5.560E-01	3.700E-01
	1.112E+00	7.240E-02
	1.668E+00	6.979E-03
	2.224E+00	3.189E-04
	2.780E+00	6.756E-06
	3.336E+00	6.551E-08
	3.892E+00	2.891E-10
	4.448E+00	7.541E-13
	5.004E+00	3.374E-14
	5.560E+00	4.993E-15
	6.116E+00	6.111E-16
	6.672E+00	6.039E-17
	7.228E+00	4.770E-18
	7.784E+00	2.978E-19
	8.340E+00	1.451E-20
	8.896E+00	5.443E-22
	9.452E+00	1.547E-23
	1.001E+01	3.277E-25
	1.056E+01	5.130E-27
	1.112E+01	6.604E-29
	1.161E+01	1.748E-30
	1.211E+01	1.169E-31
	1.260E+01	1.142E-32
	1.309E+01	1.068E-33
	1.358E+01	8.967E-35
	1.408E+01	6.711E-36
	1.457E+01	4.457E-37
	1.506E+01	2.616E-38
	1.556E+01	1.351E-39
	1.605E+01	6.113E-41
	1.654E+01	2.418E-42
	1.704E+01	8.383E-44
	1.753E+01	2.621E-45
	1.802E+01	8.286E-47
	1.851E+01	3.443E-48
	1.901E+01	2.144E-49
	1.950E+01	1.604E-50
	1.999E+01	0.000E+00
	2.049E+01	0.000E+00
	2.098E+01	0.000E+00
	2.147E+01	0.000E+00
	2.197E+01	0.000E+00
	2.246E+01	0.000E+00
	2.295E+01	0.000E+00
	2.344E+01	0.000E+00
	2.394E+01	0.000E+00

	9.452E+00	5.974E-17
	1.001E+01	1.015E-17
	1.056E+01	1.538E-18
	1.112E+01	2.150E-19
	1.161E+01	3.267E-20
	1.211E+01	4.484E-21
	1.260E+01	5.539E-22
	1.309E+01	6.134E-23
	1.358E+01	6.066E-24
	1.408E+01	5.336E-25
	1.457E+01	4.164E-26
	1.506E+01	2.891E-27
	1.556E+01	1.835E-28
	1.605E+01	1.203E-29
	1.654E+01	1.111E-30
	1.704E+01	1.692E-31
	1.753E+01	3.228E-32
	1.802E+01	6.255E-33
	1.851E+01	1.162E-33
	1.901E+01	2.044E-34
	1.950E+01	3.397E-35
	1.999E+01	5.325E-36
	2.049E+01	7.861E-37
	2.098E+01	1.091E-37
	2.147E+01	1.423E-38
	2.197E+01	1.739E-39
	2.246E+01	1.989E-40
	2.295E+01	2.128E-41
	2.344E+01	2.128E-42
	2.394E+01	1.992E-43
	2.443E+01	1.760E-44
	2.492E+01	1.501E-45
	2.542E+01	1.307E-46
	2.591E+01	1.288E-47
	2.640E+01	1.567E-48
	2.690E+01	2.295E-49
	2.739E+01	3.666E-50
	2.788E+01	0.000E+00
	2.837E+01	0.000E+00
	2.887E+01	0.000E+00
	2.936E+01	0.000E+00
	2.985E+01	0.000E+00
	3.035E+01	0.000E+00
	3.084E+01	0.000E+00
	3.133E+01	0.000E+00
	3.183E+01	0.000E+00
	3.232E+01	0.000E+00
	3.281E+01	0.000E+00
	3.330E+01	0.000E+00
	3.380E+01	0.000E+00
	3.429E+01	0.000E+00
	3.478E+01	0.000E+00
	3.528E+01	0.000E+00
	3.577E+01	0.000E+00
25	0.000E+00	1.000E+00
	5.560E-01	5.729E-01

1.112E+00
1.668E+00
2.224E+00
2.780E+00
3.336E+00
3.892E+00
4.448E+00
5.004E+00
5.560E+00
6.116E+00
6.672E+00
7.228E+00
7.784E+00
8.340E+00
8.896E+00
9.452E+00
1.001E+01
1.056E+01
1.112E+01
1.161E+01
1.211E+01
1.260E+01
1.309E+01
1.358E+01
1.408E+01
1.457E+01
1.506E+01
1.556E+01
1.605E+01
1.654E+01
1.704E+01
1.753E+01
1.802E+01
1.851E+01
1.901E+01
1.950E+01
1.999E+01
2.049E+01
2.098E+01
2.147E+01
2.197E+01
2.246E+01
2.295E+01
2.344E+01
2.394E+01
2.443E+01
2.492E+01
2.542E+01
2.591E+01
2.640E+01
2.690E+01
2.739E+01
2.788E+01
2.837E+01
2.887E+01
2.936E+01
2.985E+01

2.580E-01
8.913E-02
2.324E-02
4.519E-03
6.506E-04
6.898E-05
5.363E-06
3.049E-07
1.265E-08
3.831E-10
8.758E-12
2.658E-13
4.643E-14
1.416E-14
4.118E-15
1.103E-15
2.717E-16
6.142E-17
1.319E-17
3.015E-18
6.394E-19
1.256E-19
2.278E-20
3.809E-21
5.851E-22
8.236E-23
1.059E-23
1.242E-24
1.323E-25
1.281E-26
1.135E-27
9.543E-29
8.603E-30
1.064E-30
1.971E-31
4.443E-32
1.030E-32
2.320E-33
5.017E-34
1.037E-34
2.048E-35
3.856E-36
6.921E-37
1.182E-37
1.921E-38
2.963E-39
4.339E-40
6.022E-41
7.919E-42
9.867E-43
1.168E-43
1.323E-44
1.462E-45
1.646E-46
2.030E-47
2.946E-48
5.049E-49

	3.035E+01	9.573E-50
	3.084E+01	1.877E-50
	3.133E+01	0.000E+00
	3.183E+01	0.000E+00
	3.232E+01	0.000E+00
	3.281E+01	0.000E+00
	3.330E+01	0.000E+00
	3.380E+01	0.000E+00
	3.429E+01	0.000E+00
	3.478E+01	0.000E+00
	3.528E+01	0.000E+00
	3.577E+01	0.000E+00
30	0.000E+00	1.000E+00
	5.560E-01	6.074E-01
	1.112E+00	3.024E-01
	1.668E+00	1.211E-01
	2.224E+00	3.847E-02
	2.780E+00	9.599E-03
	3.336E+00	1.869E-03
	3.892E+00	2.826E-04
	4.448E+00	3.306E-05
	5.004E+00	2.985E-06
	5.560E+00	2.075E-07
	6.116E+00	1.109E-08
	6.672E+00	4.560E-10
	7.228E+00	1.474E-11
	7.784E+00	5.124E-13
	8.340E+00	7.000E-14
	8.896E+00	2.285E-14
	9.452E+00	7.625E-15
	1.001E+01	2.386E-15
	1.056E+01	6.986E-16
	1.112E+01	1.974E-16
	1.161E+01	5.856E-17
	1.211E+01	1.638E-17
	1.260E+01	4.313E-18
	1.309E+01	1.068E-18
	1.358E+01	2.480E-19
	1.408E+01	5.397E-20
	1.457E+01	1.098E-20
	1.506E+01	2.085E-21
	1.556E+01	3.687E-22
	1.605E+01	6.059E-23
	1.654E+01	9.231E-24
	1.704E+01	1.301E-24
	1.753E+01	1.695E-25
	1.802E+01	2.037E-26
	1.851E+01	2.269E-27
	1.901E+01	2.388E-28
	1.950E+01	2.529E-29
	1.999E+01	3.160E-30
	2.049E+01	5.549E-31
	2.098E+01	1.300E-31
	2.147E+01	3.392E-32
	2.197E+01	8.916E-33
	2.246E+01	2.283E-33

	2.295E+01 2.344E+01 2.394E+01 2.443E+01 2.492E+01 2.542E+01 2.591E+01 2.640E+01 2.690E+01 2.739E+01 2.788E+01 2.837E+01 2.887E+01 2.936E+01 2.985E+01 3.035E+01 3.084E+01 3.133E+01 3.183E+01 3.232E+01 3.281E+01 3.330E+01 3.380E+01 3.429E+01 3.478E+01 3.528E+01 3.577E+01	5.649E-34 1.346E-34 3.088E-35 6.812E-36 1.444E-36 2.938E-37 5.735E-38 1.073E-38 1.923E-39 3.299E-40 5.411E-41 8.485E-42 1.272E-42 1.826E-43 2.524E-44 3.395E-45 4.563E-46 6.419E-47 1.006E-47 1.824E-48 3.758E-49 8.315E-50 1.881E-50 0.000E+00 0.000E+00 0.000E+00 0.000E+00
35	0.000E+00 5.560E-01 1.112E+00 1.668E+00 2.224E+00 2.780E+00 3.336E+00 3.892E+00 4.448E+00 5.004E+00 5.560E+00 6.116E+00 6.672E+00 7.228E+00 7.784E+00 8.340E+00 8.896E+00 9.452E+00 1.001E+01 1.056E+01 1.112E+01 1.161E+01 1.211E+01 1.260E+01 1.309E+01 1.358E+01 1.408E+01 1.457E+01 1.506E+01	1.000E+00 6.348E-01 3.403E-01 1.517E-01 5.555E-02 1.658E-02 4.008E-03 7.813E-04 1.224E-04 1.538E-05 1.547E-06 1.243E-07 7.968E-09 4.082E-10 1.702E-11 7.245E-13 9.112E-14 3.054E-14 1.121E-14 3.931E-15 1.344E-15 4.779E-16 1.618E-16 5.217E-17 1.599E-17 4.653E-18 1.284E-18 3.357E-19 8.301E-20

	1.556E+01 1.605E+01 1.654E+01 1.704E+01 1.753E+01 1.802E+01 1.851E+01 1.901E+01 1.950E+01 1.999E+01 2.049E+01 2.098E+01 2.147E+01 2.197E+01 2.246E+01 2.295E+01 2.344E+01 2.394E+01 2.443E+01 2.492E+01 2.542E+01 2.591E+01 2.640E+01 2.690E+01 2.739E+01 2.788E+01 2.837E+01 2.887E+01 2.936E+01 2.985E+01 3.035E+01 3.084E+01 3.133E+01 3.183E+01 3.232E+01 3.281E+01 3.330E+01 3.380E+01 3.429E+01 3.478E+01 3.528E+01 3.577E+01	1.938E-20 4.269E-21 8.851E-22 1.725E-22 3.154E-23 5.402E-24 8.652E-25 1.294E-25 1.808E-26 2.367E-27 2.948E-28 3.664E-29 5.103E-30 9.314E-31 2.264E-31 6.377E-32 1.858E-32 5.350E-33 1.500E-33 4.079E-34 1.074E-34 2.735E-35 6.737E-36 1.604E-36 3.686E-37 8.177E-38 1.750E-38 3.609E-39 7.169E-40 1.371E-40 2.523E-41 4.467E-42 7.613E-43 1.251E-43 1.993E-44 3.108E-45 4.851E-46 7.868E-47 1.394E-47 2.794E-48 6.303E-49 1.535E-49
40	0.000E+00 5.560E-01 1.112E+00 1.668E+00 2.224E+00 2.780E+00 3.336E+00 3.892E+00 4.448E+00 5.004E+00 5.560E+00 6.116E+00 6.672E+00 7.228E+00	1.000E+00 6.572E-01 3.730E-01 1.804E-01 7.356E-02 2.513E-02 7.148E-03 1.687E-03 3.292E-04 5.302E-05 7.032E-06 7.670E-07 6.873E-08 5.056E-09

7.784E+00	3.058E-10
8.340E+00	1.549E-11
8.896E+00	8.040E-13
9.452E+00	1.054E-13
1.001E+01	3.628E-14
1.056E+01	1.434E-14
1.112E+01	5.636E-15
1.161E+01	2.289E-15
1.211E+01	8.919E-16
1.260E+01	3.334E-16
1.309E+01	1.194E-16
1.358E+01	4.094E-17
1.408E+01	1.343E-17
1.457E+01	4.208E-18
1.506E+01	1.259E-18
1.556E+01	3.592E-19
1.605E+01	9.763E-20
1.654E+01	2.524E-20
1.704E+01	6.201E-21
1.753E+01	1.445E-21
1.802E+01	3.193E-22
1.851E+01	6.675E-23
1.901E+01	1.319E-23
1.950E+01	2.458E-24
1.999E+01	4.318E-25
2.049E+01	7.144E-26
2.098E+01	1.114E-26
2.147E+01	1.644E-27
2.197E+01	2.332E-28
2.246E+01	3.329E-29
2.295E+01	5.289E-30
2.344E+01	1.065E-30
2.394E+01	2.778E-31
2.443E+01	8.383E-32
2.492E+01	2.643E-32
2.542E+01	8.297E-33
2.591E+01	2.551E-33
2.640E+01	7.645E-34
2.690E+01	2.228E-34
2.739E+01	6.310E-35
2.788E+01	1.736E-35
2.837E+01	4.636E-36
2.887E+01	1.202E-36
2.936E+01	3.020E-37
2.985E+01	7.358E-38
3.035E+01	1.737E-38
3.084E+01	3.970E-39
3.133E+01	8.781E-40
3.183E+01	1.879E-40
3.232E+01	3.887E-41
3.281E+01	7.775E-42
3.330E+01	1.504E-42
3.380E+01	2.815E-43
3.429E+01	5.114E-44
3.478E+01	9.074E-45
3.528E+01	1.592E-45
3.577E+01	2.823E-46

45

0.000E+00	1.000E+00
5.560E-01	6.761E-01
1.112E+00	4.015E-01
1.668E+00	2.070E-01
2.224E+00	9.189E-02
2.780E+00	3.488E-02
3.336E+00	1.127E-02
3.892E+00	3.086E-03
4.448E+00	7.146E-04
5.004E+00	1.396E-04
5.560E+00	2.297E-05
6.116E+00	3.179E-06
6.672E+00	3.696E-07
7.228E+00	3.608E-08
7.784E+00	2.955E-09
8.340E+00	2.035E-10
8.896E+00	1.205E-11
9.452E+00	7.520E-13
1.001E+01	1.107E-13
1.056E+01	3.994E-14
1.112E+01	1.718E-14
1.161E+01	7.714E-15
1.211E+01	3.347E-15
1.260E+01	1.401E-15
1.309E+01	5.649E-16
1.358E+01	2.195E-16
1.408E+01	8.206E-17
1.457E+01	2.951E-17
1.506E+01	1.020E-17
1.556E+01	3.384E-18
1.605E+01	1.077E-18
1.654E+01	3.287E-19
1.704E+01	9.605E-20
1.753E+01	2.685E-20
1.802E+01	7.172E-21
1.851E+01	1.829E-21
1.901E+01	4.446E-22
1.950E+01	1.030E-22
1.999E+01	2.268E-23
2.049E+01	4.745E-24
2.098E+01	9.425E-25
2.147E+01	1.775E-25
2.197E+01	3.169E-26
2.246E+01	5.373E-27
2.295E+01	8.707E-28
2.344E+01	1.375E-28
2.394E+01	2.225E-29
2.443E+01	4.066E-30
2.492E+01	9.309E-31
2.542E+01	2.665E-31
2.591E+01	8.637E-32
2.640E+01	2.909E-32
2.690E+01	9.776E-33
2.739E+01	3.228E-33
2.788E+01	1.042E-33
2.837E+01	3.284E-34

	2.887E+01 2.936E+01 2.985E+01 3.035E+01 3.084E+01 3.133E+01 3.183E+01 3.232E+01 3.281E+01 3.330E+01 3.380E+01 3.429E+01 3.478E+01 3.528E+01 3.577E+01	1.009E-34 3.020E-35 8.810E-36 2.502E-36 6.919E-37 1.861E-37 4.869E-38 1.238E-38 3.060E-39 7.345E-40 1.711E-40 3.870E-41 8.492E-42 1.809E-42 3.741E-43
50	0.000E+00 5.560E-01 1.112E+00 1.668E+00 2.224E+00 2.780E+00 3.336E+00 3.892E+00 4.448E+00 5.004E+00 5.560E+00 6.116E+00 6.672E+00 7.228E+00 7.784E+00 8.340E+00 8.896E+00 9.452E+00 1.001E+01 1.056E+01 1.112E+01 1.161E+01 1.211E+01 1.260E+01 1.309E+01 1.358E+01 1.408E+01 1.457E+01 1.506E+01 1.556E+01 1.605E+01 1.654E+01 1.704E+01 1.753E+01 1.802E+01 1.851E+01 1.901E+01 1.950E+01 1.999E+01 2.049E+01 2.098E+01	1.000E+00 6.922E-01 4.266E-01 2.317E-01 1.101E-01 4.550E-02 1.628E-02 5.023E-03 1.334E-03 3.043E-04 5.950E-05 9.962E-06 1.427E-06 1.746E-07 1.826E-08 1.630E-09 1.247E-10 8.412E-12 6.270E-13 1.087E-13 4.267E-14 2.041E-14 9.623E-15 4.402E-15 1.950E-15 8.355E-16 3.463E-16 1.387E-16 5.365E-17 2.003E-17 7.215E-18 2.505E-18 8.375E-19 2.695E-19 8.339E-20 2.479E-20 7.075E-21 1.936E-21 5.077E-22 1.274E-22 3.057E-23

	2.147E+01 2.197E+01 2.246E+01 2.295E+01 2.344E+01 2.394E+01 2.443E+01 2.492E+01 2.542E+01 2.591E+01 2.640E+01 2.690E+01 2.739E+01 2.788E+01 2.837E+01 2.887E+01 2.936E+01 2.985E+01 3.035E+01 3.084E+01 3.133E+01 3.183E+01 3.232E+01 3.281E+01 3.330E+01 3.380E+01 3.429E+01 3.478E+01 3.528E+01 3.577E+01	7.007E-24 1.532E-24 3.195E-25 6.350E-26 1.204E-26 2.183E-27 3.825E-28 6.653E-29 1.219E-29 2.586E-30 6.817E-31 2.158E-31 7.499E-32 2.675E-32 9.504E-33 3.322E-33 1.138E-33 3.812E-34 1.249E-34 3.997E-35 1.250E-35 3.816E-36 1.137E-36 3.308E-37 9.384E-38 2.596E-38 6.997E-39 1.838E-39 4.701E-40 1.171E-40
55	0.000E+00 5.560E-01 1.112E+00 1.668E+00 2.224E+00 2.780E+00 3.336E+00 3.892E+00 4.448E+00 5.004E+00 5.560E+00 6.116E+00 6.672E+00 7.228E+00 7.784E+00 8.340E+00 8.896E+00 9.452E+00 1.001E+01 1.056E+01 1.112E+01 1.161E+01 1.211E+01 1.260E+01 1.309E+01 1.358E+01	1.000E+00 7.061E-01 4.489E-01 2.546E-01 1.280E-01 5.671E-02 2.206E-02 7.508E-03 2.231E-03 5.777E-04 1.301E-04 2.546E-05 4.325E-06 6.372E-07 8.136E-08 9.000E-09 8.628E-10 7.203E-11 5.449E-12 4.873E-13 1.044E-13 4.626E-14 2.288E-14 1.122E-14 5.359E-15 2.486E-15

	1.408E+01	1.119E-15
	1.457E+01	4.890E-16
	1.506E+01	2.072E-16
	1.556E+01	8.504E-17
	1.605E+01	3.381E-17
	1.654E+01	1.302E-17
	1.704E+01	4.847E-18
	1.753E+01	1.745E-18
	1.802E+01	6.072E-19
	1.851E+01	2.040E-19
	1.901E+01	6.610E-20
	1.950E+01	2.065E-20
	1.999E+01	6.217E-21
	2.049E+01	1.801E-21
	2.098E+01	5.020E-22
	2.147E+01	1.344E-22
	2.197E+01	3.455E-23
	2.246E+01	8.521E-24
	2.295E+01	2.014E-24
	2.344E+01	4.558E-25
	2.394E+01	9.876E-26
	2.443E+01	2.049E-26
	2.492E+01	4.078E-27
	2.542E+01	7.833E-28
	2.591E+01	1.476E-28
	2.640E+01	2.831E-29
	2.690E+01	5.934E-30
	2.739E+01	1.478E-30
	2.788E+01	4.481E-31
	2.837E+01	1.559E-31
	2.887E+01	5.763E-32
	2.936E+01	2.160E-32
	2.985E+01	8.033E-33
	3.035E+01	2.941E-33
	3.084E+01	1.057E-33
	3.133E+01	3.722E-34
	3.183E+01	1.284E-34
	3.232E+01	4.339E-35
	3.281E+01	1.435E-35
	3.330E+01	4.645E-36
	3.380E+01	1.471E-36
	3.429E+01	4.555E-37
	3.478E+01	1.379E-37
	3.528E+01	4.081E-38
	3.577E+01	1.180E-38

NOTICE

Although this program has been tested and experience would indicate that it is accurate within the limits given by the assumptions of the theory used, we make no warranty as to workability of this software or any other licensed material. No warranties either expressed or implied (including warranties of fitness) shall apply. No responsibility is assumed for any errors, mistakes or misrepresentations that may occur from the use of this computer program. The user accepts full responsibility for assessing the validity and applicability of the results obtained with this program for any specific case.