



Construction Documentation Report

St. Clair Power Plant Bottom Ash Basin, Coal Combustion Residual Closure

Prepared for
DTE Electric Company

June 27, 2023

22741069.00

Certification

I hereby certify that this Coal Combustion Residuals (CCR) Surface Impoundment Construction Documentation Report was prepared by me or under my direct supervision and that I am a duly licensed professional engineer under the laws of the State of Michigan. I further certify that this Construction Documentation Report meets the requirements of 40 C.F.R. §257.102 and Michigan's Natural Resources and Environmental Protection Act (NREPA) Part 115 Solid Waste Management 324.11519b for conducting closure of CCR Units.

Thomas J. Radue

June 27, 2023

Thomas J. Radue

Date

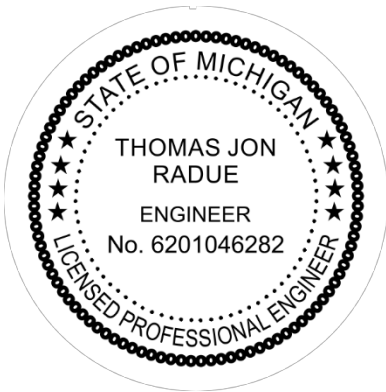

Construction Documentation Report

June 27, 2023

Contents

Executive Summary.....	1
1 Introduction	2
1.1 Purpose Of Construction Documentation Report	2
1.2 Closure Overview and Objectives.....	2
1.3 Project Description and Background	3
2 Roles and Responsibilities.....	5
2.1 Owner.....	5
2.2 Design and Construction Oversight Contractor.....	5
2.2.1 Project Manager and Project Engineer.....	5
2.2.2 Certifying Engineer	5
2.2.3 Construction Observer	6
2.3 Construction Contractors	6
3 Implementation.....	8
3.1 Summary of Closure Approach	8
3.2 Regulatory Permits and Approval.....	9
3.3 Site Preparation.....	9
3.3.1 Pipe Removal and Abandonment.....	9
3.3.2 Site Controls	10
3.3.3 Dewatering Activities	10
3.4 CCR Removal and Site Restoration.....	11
3.4.1 CCR Solidification Activities.....	11
3.4.2 CCR Removal and Disposal	11
3.4.3 Basin Backfill Activities	15
3.4.4 Stormwater Management & Controls.....	15
3.4.5 Finish Grade and Site Restoration	16
4 Sampling and Quality Assurance Testing.....	17
4.1 Basin Dewatering NPDES Permit Compliance Analytical Testing.....	17
4.2 Visual Documentation of CCR Removal	17
5 Summary	18
6 References	19

List of Tables

Table 3-1	East Bottom Ash Basin – Clay Over-Excavation Summary.....	13
Table 3-2	West Bottom Ash Basin – Clay Over-Excavation Summary.....	14

List of Figures

Figure 1	ST. Clair Bottom Ash Basin Aerial View
----------	--

List of Appendices

Appendix A	Federal and State Work Plans
Appendix B	Construction Documentation Drawings
Appendix C	Photographic Documentation Log
Appendix D	Excavated Extent Survey
Appendix E	Backfill Data
Appendix E - 1	Backfill Physical Properties
Appendix E - 2	Analytical Results
Appendix E - 3	Soil Compaction Data
Appendix E - 4	Earthworks – Backfill Volume
Appendix F	Project Submittals
Appendix F - 1	Contractor Project Execution Plan
Appendix F - 2	RCP Pipe & MH and PVC Pipe and Seal

Abbreviations

AMSL	above mean sea level
BAB	bottom ash basin(s)
BMJ	BMJ Engineers & Surveyors
CCR	coal combustion residuals
CDR	Construction Documentation Report
CO	construction observer
CQA	construction quality assurance
DTE	DTE Electric Company
EGLE	Michigan Department of Environment, Great Lakes, and Energy
EM&S	Environmental Management and Safety
EPA	Environmental Protection Agency
GPM	gallon per minute
GPS	global positioning system
NPDES	national pollution discharge elimination system
NREPA	Michigan Natural Resources and Environmental Protection Act
PM	project manager
QA/QC	quality assurance and quality control
RCP	reinforced concrete pipe
RRLF	Range Road Landfill
SESC	soil erosion and sedimentation control
SME	subject matter expert
STCPP	St. Clair Power Plant
TRC	TRC Engineers Michigan, Inc.

Executive Summary

This Construction Documentation Report (CDR) has been prepared for DTE Electric Company (DTE) to describe and document the construction activities completed as part of the St. Clair Power Plant (STCPP) Bottom Ash Basin (BAB) Closures in East China, Michigan. Location of the BABs is shown in Figure 1. The proposed closures of the STCPP east and west BABs were first summarized in the November 25, 2020 Closure Plan for Existing CCR Surface Impoundments, prepared per Coal Combustion Residuals (CCR) Rule 40 C.F.R. §257.102(b) (Federal work plan). The proposed closures were further described in the Bottom Ash Basins Closure Work Plan (State work plan) (Barr 2022) submitted to the Michigan Department of Environment, Great Lakes, and Energy (EGLE) on April 21, 2022, with revised copy submitted and received by EGLE on October 12, 2022. Copies of these documents are provided in Appendix A. The State and Federal work plans include the following BAB closure objectives:

1. Meet EGLE compliance criteria for CCR removal from the BABs;
2. Meet federal CCR rule compliance criteria for closure of CCR surface impoundments;
3. Isolate or remove CCR process water pipelines;
4. Maintain stability of the BAB steel sheet pile walls; and
5. Backfill the BABs with clean fill and restore the surface of the basins to facilitate vegetation establishment and surface water runoff.

The BAB closures met the objectives stated in the Federal and State work plans. Ongoing groundwater monitoring is being used to certify completion of closure in accordance with 40 C.F.R. §257.102(c). The initial post-removal round of groundwater quality sampling and analysis shows BAB area groundwater quality remains compliant with water quality standards.

The BAB closures were implemented in accordance with permits and approvals received for the work, as well as compliance with the basin Solid Waste Disposal Area Operating License (No. 9631), Range Road Landfill (RRLF) Solid Waste Disposal Area Operating License (No. 9603), Soil Erosion and Sedimentation Control (SESC) plan, and Flood Plain protection requirements.

The BAB closure was generally completed as described in the Federal and State work plans. Modifications, where necessary to complete the work, are described in this report.

1 Introduction

1.1 Purpose Of Construction Documentation Report

This CDR has been prepared for DTE as part of the STCPP BAB closures. The CDR documents the closure construction and restoration of the basins shown in Figure 1, which was completed in general accordance with the Federal and State work plans (generally referred to singularly hereafter as Work Plan). This report includes the following information:

- Description of the key roles and responsibilities of all parties and personnel supporting the completion of this construction project (Section 2);
- Bottom Ash Basin Closure Construction Implementation (Section 3); and
- Sampling and Quality Assurance Testing (Section 4).

Per the overall project objectives, this report documents that all CCR has been removed from both east and west BABs, the BABs have been backfilled, and erosion controls have been installed.

1.2 Closure Overview and Objectives

Initiation of closure of the BABs was driven by DTE's plan to comply with the Environmental Protection Agency (EPA) Coal Combustion Residuals (CCR) Rule. August 28, 2020 revisions to the CCR Rule required all unlined surface impoundments, including the STCPP BABs, to cease receipt of waste and initiate closure by April 11, 2021, unless an alternative deadline was requested and approved (40 C.F.R. §257.101(a)(1)). Specifically, owners and operators of CCR surface impoundment(s) can continue to receive CCR and non-CCR waste streams if the facility will cease operation of the coal-fired boiler(s) and complete closure of the impoundment(s) within certain specified timeframes (40 C.F.R. §257.103(f)(2)). For a CCR surface impoundment that is 40 acres or smaller the coal fired boiler(s) must cease operation and the CCR surface impoundment(s) must complete closure by no later than October 17, 2023. The STCPP BABs cover approximately 1.1 acres.

On November 25, 2020 DTE submitted a request to the US Environmental Protection Agency (EPA) for approval of a site-specific alternative deadline to initiate BAB closures pursuant to 40 C.F.R. §257.103(f)(2). DTE requested that the BABs be able to continue to receive CCR and non-CCR waste streams after April 11, 2021, and complete closure no later than October 17, 2023. The EPA, in their letter of January 11, 2022, deemed DTE's request complete. Further, the cease receipt of waste date at the STCPP BABs was tolled by the EPA until they could issue a final determination on DTE's request. Finally, on September 1, 2022, DTE informed the EPA that coal-fired boiler operations at STCPP ceased on May 31, 2022, and that physical isolation of the BABs from power plant infrastructure commenced on September 1, 2022 and thus the BABs had permanently ceased receipt of CCR and non-CCR waste streams. DTE requested to withdraw the

request as it was no longer necessary for EPA to issue a further extension of the April 11, 2021 deadline to cease receipt of waste at the BAB.

On behalf of DTE and consistent with DTE's cessation of CCR and non-CCR waste streams to the BABs, Barr Engineering Co. (Barr) prepared a work plan to demonstrate how BAB closure would be achieved in accordance with the CCR Rule and to request agreement from the Michigan Department of Environment, Great Lakes, and Energy (EGLE) on DTE's plan to execute closure of the STCPP BABs by CCR removal. EGLE received the work plan on April 21, 2022, with a revised work plan subsequently submitted on October 12, 2022.

In addition to the CCR Rule deadline to cease receipt of waste, the owner or operator of a coal ash impoundment(s) must begin to implement closure as described in Part 115 not more than 6 months after the final placement of coal ash within the impoundment(s) and must diligently pursue the closure. The closure must be completed in compliance with 40 C.F.R. §257.102(f)(1) and (2). DTE completed plans and specifications for BAB closure, initiated closure contractor bidding in late February 2022, selected a closure contractor in late March 2022, and initiated in-field BAB closure activities in August of 2022. DTE ceased operation of the coal-fired boilers at St. Clair Power Plant on May 31, 2022, completed washdowns of coal combustion residuals (CCR) containing equipment on August 12, 2022 and commenced physical isolation of the BABs from power plant infrastructure, and as previously stated, on September 1, 2022 permanently ceased receipt of CCR and non-CCR waste streams at the BABs and initiated closure as described in 40 C.F.R. §257.102(c).

DTE Electric commenced closure construction activities in August 2022 and completed the removal of CCR from the BABs, including the concrete-lined canal connecting the East and West BAB, in February 2023. The BABs were backfilled concurrent with and following CCR removal, and topsoiling, seeding and mulch blanket placement atop the former BABs was complete by May 19, 2023.

1.3 Project Description and Background

The DTE STCPP is located at 4901 Point Drive, East China Township, Michigan. The STCPP BABs were two adjacent sedimentation basins that were incised CCR surface impoundments underlain by a thick low permeability natural clay liner. The BABs were located south of the STCPP and approximately 30 feet west of the St. Clair River and formerly received sluiced bottom ash, non-CCR wastewater, direct precipitation, and surface water run-on from adjacent portions of the plant site. Primary flows to the BABs were first routed to the East BAB then to the West BAB through a connecting concrete-lined canal. The east basin had a capacity of 1.1 million gallons and the west basin had a capacity of 1.5 million gallons. Discharge water from the basins flowed with other site wastewater into the Overflow Canal for discharge to the St. Clair River in accordance with National Pollution Discharge Elimination System (NPDES) Permit No. MI001686, Outfall 001. Collected CCR was routinely cleaned out from the basins and disposed off-site at the Range Road Landfill (RRLF) located north of the plant site.

The basins were incised by virtue of their steel sheet pile wall perimeters, which remain in place. The walls typically extend 30 feet below grade, into a low permeability natural clay soil. The walls incorporate a tie back system wherein tie-back rods connect the upper portion of the sheet piles to additional set-back sheet pile segments. Some segments of the sheet pile walls are shorter than 30 feet and do not include tie backs. Pre-closure vibrocore testing to confirm CCR depth within the basins showed some historic over-excavation of the basins likely due to removal of some underlying clay in conjunction with routine CCR removal.

Following cessation of plant operations and contractor selection, DTE commenced closure construction activities in August 2022. DTE physically isolated the basins from STCPP infrastructure on September 1, 2022, and completed removal of the CCR from the BABs, including the concrete-lined canal connecting the East and West BAB, in February 2023. Following CCR removal, restoration included backfilling of the basins with soil and placing topsoil, seed, and mulch.

On behalf of DTE, Barr has prepared this CDR to provide documentation of site activities during the closure construction and restoration of the basins in accordance with the Work Plan final design.

2 Roles and Responsibilities

The parties named in this section are associated with the ownership, design, supply, transportation, installation, and quality assurance of all items associated with the BAB closure activities. The definitions, qualification, and responsibilities of these parties during the BAB closure are outlined in the following subsections.

2.1 Owner

The Owner is DTE Electric Company. DTE was responsible for the implementation of the BAB closure activities, including capping the CCR drainage piping formerly discharging to the BABs and removal of CCR material within the interior of the BABs. Further, DTE was responsible for selecting the Owner's company representative, design engineer and BAB closure project contractors, and served as the lead contact organization throughout the BAB closure project. The Owner's project engineer facilitated review of construction plans and specifications as well as the bidding process during the BAB closure project.

The Owner's environmental subject matter expert (SME) and Environmental Management and Safety (EM&S) representative served as the lead contact person for coordination and approval of CCR Rule compliance related matters during the BAB closure project.

2.2 Design and Construction Oversight Contractor

DTE selected Barr Engineering as the firm responsible for design and certification of the BAB closure, including engineering support, construction oversight, and construction quality assurance (CQA). Barr prepared the work plan and specifications for use by DTE for bidding and execution of the STCPP BAB closure activities. The engineering design, including drawings, specifications, CQA plan, and work plan were submitted to and approved by DTE.

Barr personnel filled the following roles during the design and construction of the BAB closure:

2.2.1 Project Manager and Project Engineer

Randy Christensen served as Barr's project manager (PM) and Project Engineer for the design and construction of the BAB closure. During construction, the PM was responsible for meeting the overall project objectives, ensuring all quality assurance requirements were satisfied, and acting as liaison between DTE Electric, Barr, and the construction contractor. The Project Engineer also provided quality assurance and quality control (QA/QC) for all design and specification changes during construction.

2.2.2 Certifying Engineer

Thomas Radue, PE, served as the Certifying Engineer. The Certifying Engineer was responsible for the review of the BAB closure design including performing overview of all design calculations and documents. The Certifying Engineer also reviewed all design and specification changes during construction.

2.2.3 Construction Observer

Barr appointed Jacquelyn Plowman as the construction observer (CO), who was the primary on site contact during CCR excavation. The CO was responsible for observing BAB closure construction activities.

During the construction, the CO completed the following:

1. Performed on-site inspections of the work to assess compliance with project standards and the QA/QC specifications;
2. Performed documentation of BAB closure activities;
3. Performed inspections/monitoring of onsite controls to evaluate effectiveness; and
4. Monitored, logged, photographed, and documented the following operations during the construction:
 - Material delivery;
 - Material removal;
 - Excavation activities (including limits of excavation and physical characteristics of the excavated materials); and
 - Backfilling and surface restoration activities.

2.3 Construction Contractors

The BAB closure project work was performed by Raymond Excavating Company (Raymond). A copy of Raymond's overall Project Execution Plan is in Appendix F - 1. Raymond was responsible for performing or subcontracting all work, and for complying with the permits, design plans, and specifications.

Raymond's specific responsibilities included:

1. Installation, maintenance, and inspection of site control measures;
2. Capping, filling, and isolating all pipes discharging to the BABs;
3. Temporary management of process and storm water sources and flows into, and around the BABs and overflow canal;
4. Excavation, transportation, and off-site disposal of CCR;
5. Delivery and placement of fill materials; and
6. Surveying.

Raymond subcontracted the following work: cement stabilization of CCR, dewatering and water treatment, bulkhead installation, soil backfill density testing, and subsurface utility locates. The list below details all subcontractors to Raymond and their responsibilities.

- Lang Tool Co (Lang) – CCR solidification via cement mixing;
- BMJ Engineers & Surveyors (BMJ) – surveying and soil density testing;
- Global Treatment Solutions – dewatering and water treatment activities;
- Rain for Rent – frac tank and pump supplier;
- Commercial Diving and Marine – underwater work; and
- Ozinga – concrete supplier.

DTE subcontracted the following work:

- Hydrochem – cleaning/decontamination of decommissioned CCR pipelines

3 Implementation

The following sections summarize the completed BAB closure by CCR removal and are separated into the major aspects for the project including summary of closure approach; regulatory permits and approvals; site preparation; and CCR removal and site restoration. Site conditions, constructability, proposed construction materials, and changes to the scope of work gave rise to occasional modifications to the Work Plan which are described in the following sections. Modifications to the Work Plan were completed in coordination with applicable permits. Record drawings created by Barr are included in Appendix B.

Barr performed oversight of Raymond's activities on behalf of DTE, field verified CCR removal and placement of clean fill, and documented pipe closure activities. Meetings were held with DTE, Lang, Raymond, and Barr throughout the project to inform the group of construction progress. Multiple site visits from project stakeholders were also coordinated throughout construction. Photos of construction activities and CCR removal are included in Appendix C.

3.1 Summary of Closure Approach

The STCPP BABs were closed by removal of CCR based on planned excavation grades and field observations. Designs were based on vibracore testing and geotechnical soil borings, completed prior to construction, to confirm approximate CCR depth and underlying material in each BAB.

Closure implementation included: dewatering the basins, in-basin mixing of cement with the CCR to physically stabilize the CCR, sequential removal of the cement-stabilized CCR from the basins and replacement by soil backfill to maintain sheet pile stability, disposal of the CCR at the RRLF, backfilling of the basins with soil up to grade, and placement of topsoil, seed, and mulch.

The lateral boundaries of the CCR stabilization and excavation were defined by the sheet pile walls along the entire perimeter of the East and West basins. The BABs covered approximately 1.1 acres combined. The pre-construction site conditions are shown on sheet 0516-C-3046 from Appendix A of the State work plan.

Excavation of CCR material reached approximate depths of 10 to 15 feet below the post-dewatered and pre-construction (i.e., top of CCR) topographic surface within the BABs. The surveyed elevation for the bottom of the excavations is shown in Appendix D.

Raymond removed CCR materials through dry excavation within the BAB, except for two areas. Wet excavation (hydro-excavation) methodologies were used to remove CCR materials in the canal connecting the West and East BAB and in the area north of the weir in the West BAB.

3.2 Regulatory Permits and Approval

The following regulatory approvals and permits were obtained as part of the construction scope:

- Flood Plain Permit Number WRP033915 v. 1 – issued by the Warren District Office Water Resources Division on June 16, 2022;
- Soil and Sedimentation Control (SESC) Permit Number 22-4657 – issued by the St. Clair County Health Department on June 16, 2022; and
- Closure work plan submittals (Barr 2022) originally submitted April 21, 2022, with revision submitted and received by EGLE on October 12, 2022.

Construction activities were also conducted in accordance with the existing permits and licenses, consisting of:

- National Pollutant Discharge Elimination System (NPDES) Permit Number MI0001686 – issued by EGLE Water Resources Division on August 27, 2015;
- Solid Waste Disposal Area Operating License (No. 9631) – issued by EGLE Materials Management Division on December 18, 2020; and
- Solid Waste Disposal Area Operating License (No. 9603) – issued by EGLE Materials Management Division on May 15, 2020.

3.3 Site Preparation

During the week of August 15, 2022, Raymond mobilized to the site. During the mobilization period, construction facilities, material, and equipment were delivered to the site and initial site preparations were completed. The sections below detail the preparations within the construction areas and include pipe abandonment, setting up site controls, and dewatering activities.

3.3.1 Pipe Removal and Abandonment

Abandonment of the CCR process-related inlet pipes at process units was completed by the DTE hired contractors, Raymond and Hydrochem. Prior to construction, all remaining below-grade piping leading to the BABs were flushed by Hydrochem to remove residual fluids, solids, and sludges and then the piping was abandoned-in-place by filling with cement grout (flowable fill) and capping at the former BAB discharge points. Raymond also removed and disposed of the two slag tanks and ash hopper drain water pumps located in the pump house. The associated piping was capped with blind flanges. Seven CCR process-related inlet pipes were abandoned by physical disconnection of above-grade piping to create a physical break; a section of piping was removed at Units 5, 6, and 7; and process-related inlet piping for Units 1, 2, 3, 4, and 6 were abandoned by physical disconnection of piping located in the sub-basement of

Unit 1 downstream of where the pipes merge. Documentation of the abandoned pipes is summarized in Table 2 of sheet 0516-C-3047 in Appendix B and photo documentation is provided in Appendix C.

The planned pipe removals and abandonments were modified for the following pipes:

- Two pipes on the west side of the East BAB were not identified during BAB closure planning. These pipes (4-inch and 3-inch) were plugged with flowable fill where they discharged into the East BAB. Both pipes had flowable fill injected to the pipes until visual confirmation that the pipes were completely filled.
- The former outfall in the West BAB was previously capped and did not require additional abandonment.

3.3.2 Site Controls

Prior to and during construction, various site controls were installed to minimize soil and sediment transport outside of the construction zone. Signage was also installed to notify workers if specific hazards or obstacles were present. Specific site controls utilized during construction included:

- During site preparation, Raymond installed soil erosion and sediment controls and Raymond subcontractor, Commercial Diving and Marine, deployed two temporary bulkheads in the overflow canal to isolate the West BAB from the St. Clair River via the overflow canal. One bulkhead was installed south of the pipeline manhole, and a second redundant bulkhead was deployed upstream in the 48-inch Reinforced Concrete Pipe (RCP) near the West BAB discharge inlet. The location of both the manhole and RCP are shown on sheet 0516-C-3047 from Appendix A in the State work Plan. Site preparation activities were completed in August 2022.
- Temporary fencing was set up to define and secure the work area. Signage was installed to notify personnel of fall hazards.
- BMJ set up survey control points prior to construction activities commencing that would be used to document final depths of CCR excavation, and other site-specific features as needed.

There were no site control modifications from the Work Plan.

3.3.3 Dewatering Activities

Raymond subcontractor, Global Treatment Solutions, set up the water filtration system to treat water removed during BAB dewatering (i.e., removal of ponded water from above CCR). Dewatering activities continued from mid-August 2022 through mid-October 2022, and began after the 48-inch RCP was plugged. Water was pumped from the point closest to the existing West BAB outlet using a stone sump/wet well. Water treatment equipment specifications are included in Appendix F - 1 and consisted of a 400-gallon per minute (GPM) water treatment system, two open top weir tanks, sand filtration, and

interchangeable bag filtration system. Treated water was discharged through the NPDES permitted discharge Outfall 001. NPDES water quality exceedances were not observed during the construction activities.

Incidental water collecting in the basins, following BAB dewatering and removal of the water filtration system, was pumped to the onsite sump for treatment and discharge. Four-inch electric powered trash pumps were installed as needed to remove water.

There were no dewatering activity modifications from the Work Plan.

3.4 CCR Removal and Site Restoration

CCR Removal from the BABs was completed by Raymond under the observation of Barr and in accordance with the Work Plan. The following sections describe CCR solidification activities, CCR removal and disposal, basin backfilling, stormwater management controls, and finished grades and vegetation establishment.

3.4.1 CCR Solidification Activities

CCR material was stabilized with cement following basin dewatering activities. Raymond's subcontractor, Lang Tool, Inc, utilized soil mixing equipment to blend cement and CCR to produce a higher strength mix than CCR alone. This equipment included a mix truck and specialized dual axis mixer drill stem with a reagent pumping system, which was used to mix cement with the CCR material in the BABs. The dual axis mixer was equipped with a global positioning system (GPS) unit to track depth and location of mixed material, and the mix truck tracked mixed material volumes with a computerized scale system. Cement shortages delayed mixing of the cement with the CCR in the BABs until Raymond's subcontractor, Ozinga, was able to secure a cement shipment in October. Between October 2022 and December 2022, Lang blended the CCR within the basins with approximately 2,445 tons of cement. The CCR material mixed with cement (cement stabilized) provided a surface upon which the excavators could then operate within the basins.

There were no modifications from the Work Plan beyond the schedule effects associated with cement shortages.

3.4.2 CCR Removal and Disposal

Raymond removed approximately 38,540 tons of CCR, cement-stabilized CCR, over-excavated material (small quantities of soil) through a combination of mechanical and hydro-excavation methodologies. As described in the Work Plan, excavation goals were achieved following removal of all CCR and at least 6-inches of underlying clay, which was confirmed by observing the type, color, and consistency of the lower excavated material, by photo documentation of the over excavation, and by surveying the base of the excavation. Visual documentation of CCR removal is discussed further in Section 4.2. CCR materials were

removed from all exposed surfaces such as the sheet pile walls, support structures, overflow canal, weir, and connecting channel between the East and West BAB by power washing, scraping the sheet pile wall by hand and with an excavator bucket. Surveyed elevations of the excavated surface are shown in Appendix D.

From November 2022 through January 2023, Raymond removed the bulk of the CCR materials from the BABs through mechanical excavation. Raymond operated an excavator with a digging and ditching bucket and sequentially removed the cement stabilized CCR from the basins and replaced it with soil backfill up to approximately elevation 572 ft to maintain sheet pile wall stability. Excavators accessed the CCR material from the interior of the basin, stockpiling CCR and over-excavated material within the basin. An excavator operating from the surface outside the basins placed the material into gated haul trucks, which transported excavated material to DTE's RRLF, located north of the plant. On average, full haul trucks were able to carry 24.5 tons of excavated material (CCR, CCR mixed with cement, and small quantities of soil). Based on this average and the number of trucks, the RRLF received approximately 21,977 tons of excavated material from the East BAB and 16,562 tons of excavated material from the West BAB.

Following excavation of CCR to elev. 572 ft in the West BAB, sheet pile movement and distress in the asphalt at the surface was observed along the western edge of the West BAB. Raymond stopped work to reinforce the sheet pile wall with backfill material, after which construction continued.

Areas that could not be accessed with an excavator were hydro-excavated. Hydro-excavation methodologies were used to remove CCR material from the canal between the East and West BAB and the area north of the West BAB weir wall. These concrete-lined areas were scraped, power washed clean, and the cleaned concrete was left in place. CCR dropped during truck loading at the surface of the BAB (particularly around the guard rails) was retrieved using a mini excavator and shovel and exported offsite to the RRLF.

Post-excavation survey elevations are shown in Appendix D. The average post-excavation surface was compared to the average top of clay pre-excavation surface calculated from vibrocore data during the geotechnical investigation (see Attachment B of the Work Plan). The average elevation of the post-excavation clay surface in the East and West BAB basin was 561.0 ft and 563.5 ft, respectively. The average pre-excavation elevation of the top of clay based on vibrocore data was 564.3 ft in the East BAB and 565.1 ft in the West BAB, demonstrating average clay over excavation by 3.3 ft in the East BAB and 1.6 ft in the West BAB, both well more than the 6-inch minimum required to achieve CCR removal. Tables 3-1 and 3-2 provide listings of the pre-excavation bottom of CCR elevations, the post-excavation clay surface elevations, and the elevation differential at each vibrocore location in the east and west BABs, respectively.

Post-excavation elevation surveys were not specifically performed at each vibracore location so post-excavation elevations and elevation differentials are approximate based on nearby survey points.

Table 3-1 East Bottom Ash Basin – Clay Over-Excavation Summary

Vibracore Location ID	Pre-Excavation Bottom of CCR Elevation (ft, amsl)	Approximate Post-Excavation Clay Surface Elevation (ft, amsl)	Approximate Elevation Differential (ft)
East-SED-01 ¹	--	--	--
East-SED-02 ¹	--	--	--
East-SED-03	561.2	559.66	1.5
East-SED-04	563.8	559.31	4.5
East-SED-05	563.8	561.43	2.4
East-SED-06	567.7	565.86	1.8
East-SED-07 ¹	--	--	--
East-SED-08	565.9	563.48 ²	2.4
East-SED-09	565.3	562.36	2.9
East-SED-10	565.3	560.96	4.3
East-SED-11	563.5	561.61	1.9
East-SED-12 ¹	--	--	--
East-SED-13	562.3	558.61 ²	3.7

¹ Vibracore pushed to refusal in CCR prior to reaching underlying natural clay surface.

² The post-excavation elevation is the average of two nearby survey points.

Table 3-2 West Bottom Ash Basin – Clay Over-Excavation Summary

Vibracore Location ID	Pre-Excavation Bottom of CCR Elevation (ft, amsl)	Approximate Post-Excavation Clay Surface Elevation (ft, amsl)	Approximate Elevation Differential (ft)
West-SED-01	565.2	563.57	1.6
West-SED-02 ¹	--	--	--
West-SED-03	568.2	564.85	3.4
West-SED-04	562.3	562.97 ²	0.7
West-SED-05	568.5	565.58	2.9
West-SED-06	564.4	562.78	1.6
West-SED-07 ¹	--	--	--
West-SED-08	565.4	564.39	1.0
West-SED-09	563.8	563.33 ²	0.5
West-SED-10	564.6	563.74	0.9
West-SED-11	567.1	563.97	3.1
West-SED-12	564.7	563.72	1.0
West-SED-13	566.2	561.17	5.0
West-SED-14	561.4	563.25	-1.9 ³

¹Vibracore pushed to refusal in CCR prior to reaching underlying natural clay surface.

²The post-excavation elevation is the average of two nearby survey points.

³The pre-excavation elevation at West-SED-14 is anomalous. Complete CCR removal was verified through visual inspection and as documented in Photo 158-1 in Appendix C.

Ft, amsl – Feet above mean sea level

The anticipated CCR removal extents were modified for the following areas:

- Less material required removal than anticipated along the west side of the West BAB and in the northern area of the East BAB due to differences between the extrapolated top of clay contours generated from the 2021 in-basin geotechnical investigation and field observations at the time of CCR removal.
- More material was removed than anticipated in select locations of the BABs due to the uneven interface between the top of clay and bottom of CCR and hence the contractor occasionally removing material beyond the over-excavation limits for reasons of practicality.

In all cases CCR removal was confirmed based on visual inspection as documented in the photo log in Appendix C.

3.4.3 Basin Backfill Activities

Clean fill (sandy clay) from a nearby borrow source, MAGNA, located in St. Clair, MI, was used to backfill the BABs to the specified ground surface elevation. Backfill data is included in Appendix E. Excavated areas were backfilled in approximately 12-inch lifts, with each lift compacted to 95 percent standard proctor maximum dry density. A vibrating plate compactor attached to an excavator was generally used to compact fill until an elevation of 572 ft was achieved. Fill above 572 ft was generally compacted with a sheepsfoot roller after a bulldozer spread out fill in even layers. Raymond's subcontractor, BMJ, completed weekly onsite compaction testing during backfill activities. Gradation and material source information is included in Appendix E - 1 and Appendix E - 2. Moisture and density reports are included in Appendix E - 3. The filled surface of each BAB received a 6-inch layer of topsoil and was contoured to facilitate surface water runoff – final contours specified for the closed basins are shown in the drawings on Sheet 0516-C-3048 in Appendix B, and backfill volumes are included in Appendix E - 4. Raymond completed topsoil and seeding in late April and into May, and at the time of this report, vegetation is still becoming established.

Basin backfill methods and contouring were modified for the following areas:

- The Work Plan did not account for grading adjacent the pumphouse at the West BAB. Fill material was placed up to the base of the pumphouse and graded to promote positive drainage to the stormwater structure. Barr, DTE, and Raymond discussed and approved the change.
- Flowable fill was used to backfill the area under the pumphouse due to difficult access. Approximately 62 cubic yards of flowable fill was used.

3.4.4 Stormwater Management & Controls

Stormwater structures were installed to promote drainage in the BABs. Stormwater-related submittals are in Appendix F - 2. Raymond installed a new stormwater line into the 48-inch RCP from the West Basin to the overflow canal and a new stormwater catch basin as shown in the drawings in Appendix B. Raymond also modified the chemical treatment trench, located adjacent to the East basin, for use as a stormwater drainageway following BAB closure. Modifications were consistent with the construction drawings shown on Sheets 0516-C-3052 in Appendix A of the Workplan. As described in Section 3.4.3, Raymond used borrow source fill from MAGNA to backfill the BABs to final grade and promote drainage to the overflow canal and modified chemical treatment trench.

Stormwater management and controls were modified, relative to the Work Plan, as follows:

- Extra mechanically compacted granular material was used as the foundation for the precast concrete base for the concrete storm manhole structure. Approximately 2 feet of mechanically compacted gravel was used.

-
- Raymond proposed alternate materials to seal the area around the 48-inch RCP. Material information is contained in Appendix F - 2. Raymond drilled into the overflow canal and injected waterproof material to seal the area.
 - Raymond installed the new stormwater line 10-inches higher than indicated on the drawings to promote positive drainage to the overflow canal.
 - Slight modifications were also made to the tie in from the existing concrete inlet box to the overflow canal to accommodate actual field verification measurements.

3.4.5 Finish Grade and Site Restoration

The finished surface of each closed basin was contoured to facilitate surface water runoff. Final contours, shown on drawings in Appendix B, were completed at the end of April 2023. At the time of this report, vegetation was still becoming established. SESC measures will be removed following vegetation establishment.

Timber mats used to traverse the BAB were decontaminated and removed from the site. Guard rail posts along portions of the BAB perimeters were not salvageable, so Raymond removed the posts with a saw and installed concrete bumpers.

4 Sampling and Quality Assurance Testing

4.1 Basin Dewatering NPDES Permit Compliance Analytical Testing

Raymond submitted a Dewatering Plan to DTE for approval prior to implementation, and to comply with the NPDES permit requirements. The plan is included in Appendix F - 1, and as summarized in Section 3.3.3, included an onsite treatment system for treating water from BAB dewatering activities. Water from the East BAB was pumped and gravity drained to the West BAB and the West BAB was subsequently dewatered from September 9, 2022 through early October 2022, with total suspended solids sampling (weekly), Oil & Grease sampling (twice per month), and dewatering flow monitoring (twice per week) per NPDES discharge criteria for Outfall 001. Discharge water samples were collected weekly and analyzed, and a flow meter continuously monitored the discharge volume. Approximately 1.3 million gallons of treated water was discharged to Outfall 001. Samples were submitted to Merit Laboratories in Holly, Michigan for analysis. NPDES exceedances were not observed during the construction activities.

There were no basin dewatering modifications from the Work Plan.

4.2 Visual Documentation of CCR Removal

Barr and DTE observed over-excavation of CCR material from November 2022 through February 2023. To satisfy the requirements of 40 C.F.R. §257.102(c).[20] achievement of the over excavation was visually confirmed by reviewing the plasticity of the lowest excavated material – the natural clay is plastic while the CCR has no to low plasticity, reviewing the color of the lowest excavated material – the natural clay ranges in color from dark brown to light grayish brown whereas the CCR was primarily dark gray, and documenting the excavation extent with photographs. Photo documentation is shown in Appendix C.

DTE has performed one round of post-closure groundwater quality sampling to demonstrate that groundwater monitoring concentrations do not exceed the groundwater protection standards established pursuant to §257.95(h) for constituents listed in Appendix IV to Part 257, and a second round of post-closure sampling will be performed. A final certification that groundwater meets groundwater protection standards will be completed as a stand-alone addendum to this CDR.

There were no modifications from the Work Plan relative to visual documentation of CCR removal.

5 Summary

Closure of the BABs was performed and completed in accordance with the Work Plan and permits and approvals obtained for the work. Minor modifications from the Work Plan, as described in this report, were implemented to adjust to in-field conditions and to facilitate achievement of all Work Plan objectives. The BAB's were fully removed from service, CCR was fully removed from the BABs, and the BABs were backfilled, contoured, and vegetated to facilitate future management of water runoff from the surface area of the former BABs. The semi-annual groundwater monitoring, in total consisting of two rounds of groundwater quality sampling and analysis of which the first round is complete, will assess the compliance with groundwater protection standards established pursuant to §257.95(h) for constituents listed in Appendix IV to Part 257.

6 References

Barr. 2022. Bottom Ash Basins Closure Work Plan, Prepared for DTE Electric Company Report, April 2022, with updates of October 2022.

Figures

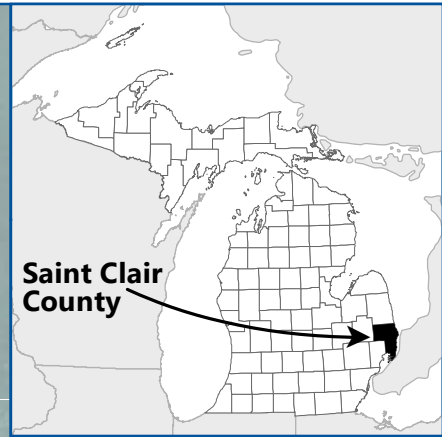

St. Clair River

WEST
BASIN

EAST
BASIN

CPT22-06

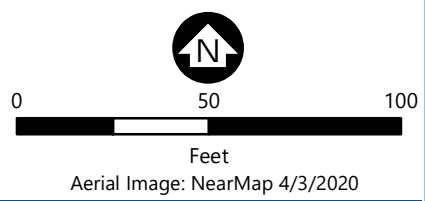

**BOTTOM ASH BASIN
LOCATIONS**
St. Clair Power Plant
DTE
4901 Pointe Drive
China Township, Michigan

FIGURE 1

Appendix A

Federal and State Work Plans

CLOSURE PLAN FOR EXISTING CCR SURFACE IMPOUNDMENT PER 40 CFR 257.102 (b)

SITE INFORMATION

Site Name / Address	DTE Energy St. Clair Power Plant Bottom Ash Basin #2 (east) / 4877 M-29, East China, MI 48054		
Owner Name / Address	DTE Electric Company / One Energy Plaza, Detroit, MI 48226		
CCR Unit	Ash Pond	Final Cover Type	N/A
Reason for Initiating Closure	Known final receipt of waste	Closure Method	Closure by Removal

CLOSURE PLAN DESCRIPTION

<p>(b)(1)(i) – Narrative description of how the CCR unit will be closed in accordance with this section.</p>	<p>The Ash Pond will be dewatered to facilitate CCR removal and decontamination of the unit. Closure operations will involve: (i) CCR removal by excavation of the ash pond, (ii) removal or decontamination of any areas affected by releases of CCR, (iii) demolition/abandonment of associated non-earthen features, and (iv) regrading to final desired grades using borrow soil for fill, as needed. In accordance with 257.102(b)(3), this written closure plan will be amended to provide additional details after the final engineering design for the closure by removal is completed. This closure plan reflects the best information available to date.</p>
<p>(b)(1)(ii) If closure of the CCR unit will be accomplished through removal of CCR from the CCR unit, a description of the procedures to remove the CCR and decontaminate the CCR unit in accordance with paragraph (c) of this section.</p>	<p>CCR will be removed primarily by excavation of the ash pond. The underlying and surrounding soils will be removed or decontaminated. If necessary and as confirmed by groundwater monitoring results, the upper-most usable aquifer will be flushed, pumped, and/or treated. Wastes generated will be disposed in compliance with applicable regulations.</p>

INVENTORY AND AREA ESTIMATES

(b)(1)(iv) – Estimate of the maximum inventory of CCR ever on-site over the active life of the CCR unit	2,080 cubic yards
(b)(1)(v) – Estimate of the largest area of the CCR unit ever requiring a final cover	No final cover will be placed as the CCR is being removed.

CLOSURE SCHEDULE

<p>(b)(1)(vi) – Schedule for completing all activities necessary to satisfy the closure criteria in this section, including an estimate of the year in which all closure activities for the CCR unit will be completed. The schedule should provide sufficient information to describe the sequential steps that will be taken to close the CCR unit, including major milestones ...and the estimated timeframes to complete each step or phase of CCR unit closure.</p>	
<p>The milestone and the associated timeframes are estimates. Some of the activities associated with the milestones will overlap. Amendments to the milestones and timeframes will be made as more information becomes available.</p>	
Written Closure Plan Placed in Operating Record	November 25, 2020
Notification of Intent to Close Placed in Operating Record	January 2022
Agency coordination and permit acquisition <ul style="list-style-type: none"> • Coordinating with state agencies for compliance • Acquiring state permits 	Fall 2021 through Spring 2022 (estimated)
Mobilization	Spring/Summer 2022 (estimated)
Dewater ash pond	Summer 2022 (estimated)
CCR removal and decontamination	Summer/Fall 2022 (estimated)
Estimate of Year in which all closure activities will be completed	2023

Certification by qualified professional engineer appended to this plan.

Certification Statement 40 CFR § 257.102(b)(4) – Written Closure Plan for a CCR Surface Impoundment

CCR Unit: DTE Energy St. Clair Power Plant Bottom Ash Basin #2 (east)

I, David McKenzie, P.E., being a Registered Professional Engineer in good standing in the State of Michigan, do hereby certify, to the best of my knowledge, information, and belief, that the information contained in this certification has been prepared in accordance with the accepted practice of engineering. I certify, for the above-referenced CCR Unit, that the information contained in this written closure plan dated November 25, 2020 meets the requirements of 40 CFR § 257.102.

David McKenzie, P.E.

Printed Name

November 25, 2020

Date

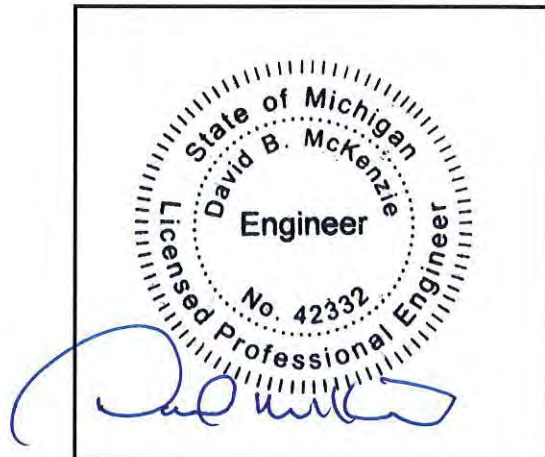

CLOSURE PLAN FOR EXISTING CCR SURFACE IMPOUNDMENT PER 40 CFR 257.102 (b)

SITE INFORMATION

Site Name / Address	DTE Energy St. Clair Power Plant Bottom Ash Basin #1 (west) / 4877 M-29, East China, MI 48054		
Owner Name / Address	DTE Electric Company / One Energy Plaza, Detroit, MI 48226		
CCR Unit	Ash Pond	Final Cover Type	N/A
Reason for Initiating Closure	Known final receipt of waste	Closure Method	Closure by Removal

CLOSURE PLAN DESCRIPTION

(b)(1)(i) – Narrative description of how the CCR unit will be closed in accordance with this section.	The Ash Pond will be dewatered to facilitate CCR removal and decontamination of the unit. Closure operations will involve: (i) CCR removal by excavation of the ash pond, (ii) removal or decontamination of any areas affected by releases of CCR, (iii) demolition/abandonment of associated non-earthen features, and (iv) regrading to final desired grades using borrow soil for fill, as needed. In accordance with 257.102(b)(3), this written closure plan will be amended to provide additional details after the final engineering design for the closure by removal is completed. This closure plan reflects the best information available to date.
(b)(1)(ii) If closure of the CCR unit will be accomplished through removal of CCR from the CCR unit, a description of the procedures to remove the CCR and decontaminate the CCR unit in accordance with paragraph (c) of this section.	CCR will be removed primarily by excavation of the ash pond. The underlying and surrounding soils will be removed or decontaminated. If necessary and as confirmed by groundwater monitoring results, the upper-most usable aquifer will be flushed, pumped, and/or treated. Wastes generated will be disposed in compliance with applicable regulations.

INVENTORY AND AREA ESTIMATES

(b)(1)(iv) – Estimate of the maximum inventory of CCR ever on-site over the active life of the CCR unit	4,450 cubic yards
(b)(1)(v) – Estimate of the largest area of the CCR unit ever requiring a final cover	No final cover will be placed as the CCR is being removed.

CLOSURE SCHEDULE

(b)(1)(vi) – Schedule for completing all activities necessary to satisfy the closure criteria in this section, including an estimate of the year in which all closure activities for the CCR unit will be completed. The schedule should provide sufficient information to describe the sequential steps that will be taken to close the CCR unit, including major milestones ...and the estimated timeframes to complete each step or phase of CCR unit closure.	
The milestone and the associated timeframes are estimates. Some of the activities associated with the milestones will overlap. Amendments to the milestones and timeframes will be made as more information becomes available.	
Written Closure Plan Placed in Operating Record	November 25, 2020
Notification of Intent to Close Placed in Operating Record	January 2022
Agency coordination and permit acquisition <ul style="list-style-type: none"> • Coordinating with state agencies for compliance • Acquiring state permits 	Fall 2021 through Spring 2022 (estimated) Spring/Summer 2022 (estimated)
Mobilization	Summer 2022 (estimated)
Dewater ash pond	Summer 2022 (estimated)
CCR removal and decontamination	Summer/Fall 2022 (estimated)
Estimate of Year in which all closure activities will be completed	2023

Certification by qualified professional engineer appended to this plan.

Certification Statement 40 CFR § 257.102(b)(4) - Written Closure Plan for a CCR Surface Impoundment

CCR Unit: DTE Energy St. Clair Power Plant Bottom Ash Basin #1 (west)

I, David McKenzie, being a Registered Professional Engineer in good standing in the State of Michigan, do hereby certify, to the best of my knowledge, information, and belief, that the information contained in this certification has been prepared in accordance with the accepted practice of engineering. I certify, for the above-referenced CCR Unit, that the information contained in the written closure plan dated November 25, 2020 meets the requirements of 40 CFR § 257.102.

David McKenzie, P.E
Printed Name

November 25, 2020
Date

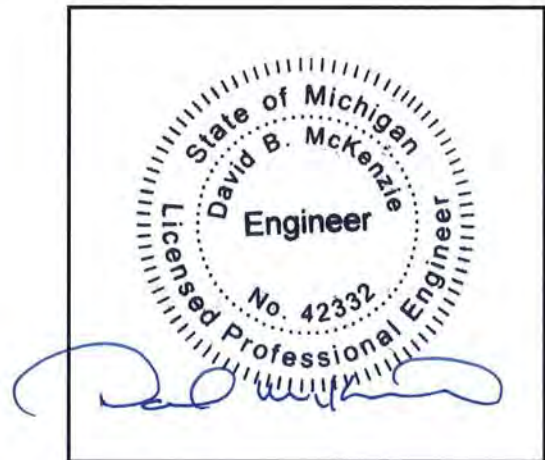



Bottom Ash Basins Closure Work Plan

St. Clair Power Plant

Prepared for
DTE Electric Company

April 2022 (w/updates of October 2022)

Bottom Ash Basins Closure Work Plan
April 2022 (w/updates of October 2022)

Contents

1	Closure Work Plan Overview and Objectives	1
2	Existing Conditions.....	2
3	Regulatory Framework.....	4
4	Closure by Removal of CCR.....	6
4.1	Water Management.....	6
4.2	CCR Excavation, Transport and Disposal.....	7
4.3	Pipe Removal.....	7
4.4	Documentation of CCR Removal.....	8
4.5	Site Restoration	9
4.6	Post-Excavation Monitoring	9
5	Project Schedule.....	11

List of Tables

Table 4-1	NPDES Discharge Criteria	6
Table 5-1	STCPP BAB Closure Schedule	11

List of Figures

Figure 1	St. Clair Bottom Ash Basin Aerial View
----------	--

List of Appendices, Attachments, or Exhibits

Attachment A	Bottom Ash Basin Closure Drawings
Attachment B	Geotechnical Memorandum and Memorandum Addendum 1

Certification

I hereby certify that this Coal Combustion Residuals (CCR) Surface Impoundment Closure Work Plan was prepared by me or under my direct supervision and that I am a duly licensed professional engineer under the laws of the State of Michigan. I further certify that this Closure Plan meets the requirements of 40 CFR §257.102 and NREPA Part 115 Solid Waste Management 324.11519b for conducting closure of CCR Units.

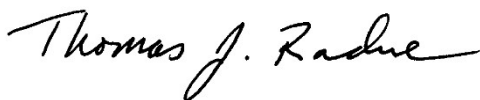

Thomas J. Radue

October 12, 2022

Date

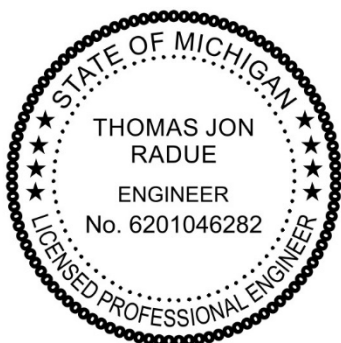

Abbreviations

BAB	Bottom Ash Basin(s)
CCR	Coal Combustion Residuals
CDR	Construction Documentation Report
DTE	DTE Electric Company
EGLE	Michigan Department of Environment, Great Lakes, and Energy
EPA	Environmental Protection Agency
MDOT	Michigan Department of Transportation
NREPA	Michigan Natural Resources and Environmental Protection Act
RRLF	Range Road Landfill
SSI	Statistically Significant Increase
STCPP	St. Clair Power Plant
TRC	TRC Engineers Michigan, Inc.
USCS	Unified Soil Classification System

1 Closure Work Plan Overview and Objectives

The DTE Electric Company (DTE) St. Clair Power Plant (STCPP) located at 4901 Point Drive, East China Township, Michigan will cease electric power generation operations in late spring/early summer of 2022. The Bottom Ash Basins (BABs), which are part of the plant's Coal Combustion Residuals (CCR) management system, are incised CCR surface impoundments (see attached Figure 1) laterally contained by perimeter steel sheet pile walls and underlain with a thick low permeability natural clay liner.

Following cessation of plant operations, CCR and other process wastewater will no longer be generated and therefore no longer be discharged into the BABs and the BABs will be closed. Some surface water run-on will continue to enter the closed basins and then be diverted offsite via permitted discharge, consistent with current practice.

On behalf of DTE, Barr Engineering Co. (Barr) has prepared this Closure Work Plan to demonstrate how BAB closure will be achieved in accordance with the cited rules and to request agreement from the Michigan Department of Environment, Great Lakes, and Energy (EGLE) on DTE's plan to execute a closure by removal of the STCPP BABs in accordance with state and federal requirements. This document provides a general description of the following for the BABs:

- Existing Conditions
- Regulatory Framework
- Closure by Removal of CCR
- Closure Schedule

To comply with the closure timeframe requirements of state and federal requirements and maintain project schedule, BAB closure would commence on or near July 5, 2022. DTE sought EGLE agreement with this Closure Work Plan (originally signed April 20, 2022) no later than June 1, 2022 so that construction could commence as planned. This October 11, 2022 copy includes minor updates to text in Section 4.4 – Documentation of CCR Removal confirmation Item 4, and minor updates to the final sentence of Section 4.6 – Post-Excavation Monitoring.

2 Existing Conditions

The STCPP BABs are two adjacent sedimentation basins that are incised CCR surface impoundments. The BABs are located south of the STCPP and approximately 30 feet west of the St. Clair River and receive sluiced bottom ash, non-CCR wastewater, direct precipitation, and surface water run-on from adjacent portions of the plant site. Primary flows to the BABs are first routed to the East BAB then to the West BAB through a connecting concrete-lined canal. The east basin has a capacity of 1.1 million gallons and the west basin has a capacity of 1.5 million gallons. Discharge water from the basins flows with other site wastewater into the Overflow Canal for discharge to the St. Clair River in accordance with National Pollution Discharge Elimination System (NPDES) Permit No. MI001686, Outfall 001. Collected CCR is routinely cleaned out from the basins and disposed off-site at the Range Road Landfill (RRLF) located north of the plant site.

The basins are incised by virtue of their steel sheet pile wall perimeters. The walls typically extend 30 feet below grade, into a low permeability natural clay soil. The walls incorporate a tie back system wherein tie-back rods connect the upper portion of the sheet piles to additional set-back sheet pile segments. Some segments of the sheet pile walls are shorter than 30 feet and do not include tie backs. The BAB Closure Drawings in Attachment A provide existing conditions information on the BAB sheet pile walls and the surrounding area.

To plan the BAB closures and inform contractors bidding for the BAB closure project, various subsurface evaluations were performed to determine the depth of CCR within the basins and to characterize the strength of native soil outside of the basins. The CCR is quite fine with P200s (percent passing No. 200 sieve) above 85%, and typically classifying as a silt (ML) or occasionally an elastic silt (MH) by the Unified Soil Classification System (USCS). The native clay surrounding the basins typically classifies as a lean clay (CL) with a permeability on the order of 10^{-7} to 10^{-8} cm/sec. The clay is a relatively massive deposit and is consistent with depth and quality across the site.

Vibracore testing to confirm CCR depth within the basins shows some historic over-excavation of the basins – removal of some underlying clay in conjunction with CCR removal. This over excavation will effectively reduce the embedment depth of the lower portions of the sheet pile walls during CCR removal and will be accounted for during contractor execution of the basin excavation plan. Findings from the geotechnical investigations are provided in Attachment B and include:

- Available historical information from 2016 drilling to install monitoring wells in the native clay, including permeability testing on clay samples and geologic sections of the site.
- Boring logs from 2021 geotechnical drilling in the native clay near the monitoring well locations.
- Summary data on vibracore within the basins to determine the elevation of the bottom of ash/top of clay, including a contour map and profiles and sections in the basins.
- A summary report from ConeTec with CPTu (Cone Penetration Testing and Pore Water Pressure) data from soundings performed outside the basins, including three vane shear tests in the native clay.

- Laboratory test results on bulk samples of the CCR (predominantly index/state testing) and on undisturbed samples of the native clay from the 2021 drilling (including index/state, strength, and permeability).

3 Regulatory Framework

The BABs receive sluiced bottom ash and non-CCR wastewater from routine plant operations, direct precipitation, and surface water run-on from adjacent plant areas and are operated in compliance with:

- Michigan Natural Resources and Environmental Protection Act (NREPA) Part 115 (Solid Waste Management)
- Part 115 rules: R 299.4101 to R 299.4922 of the Michigan Administrative Code
- EGLE Solid Waste Disposal Area Operating License Number 9631
- Environmental Protection Agency (EPA) Coal Combustion Residuals (CCR Rule), 40 CFR 257, Subpart D

The BABs are underlain by at least 120 feet of a low hydraulic conductivity natural clay liner. Groundwater detection monitoring that has been performed since 2017 in accordance with 40 CFR §257.93 and §257.94, has demonstrated that no statistically significant increases in groundwater quality parameters over background levels have been detected at the BABs.

August 28, 2020 revisions to the CCR Rule require all unlined surface impoundments, including the STCPP BABs (an eligible unlined CCR surface impoundment), to initiate closure by April 11, 2021, unless an alternative deadline is requested and approved (40 CFR 257.101(a)(1)). Specifically, owners and operators of a CCR surface impoundment may continue to receive CCR and non-CCR waste streams if the facility will cease operation of the coal-fired boiler(s) and complete closure of the impoundment within certain specified timeframes (40 CFR §257.103(f)(2)). For a CCR surface impoundment that is 40 acres or smaller the coal fired boiler(s) must cease operation and the CCR surface impoundment must complete closure by no later than October 17, 2023. The STCPP BABs cover approximately 1.1 acres.

In addition to the CCR Rule closure deadline, the owner or operator of a coal ash impoundment must begin to implement closure as described in Part 115 not more than 6 months after the final placement of coal ash within the impoundment and must diligently pursue the closure. The closure must be completed in compliance with 40 CFR 257.102(f)(1) and (2). DTE has completed plans and specifications for BAB closure, initiated closure contractor bidding in late February 2022, selected a closure contractor in late March 2022, and will initiate in-field BAB closure activities in July of 2022.

Closure by CCR removal, as proposed herein and described in the subsequent section of this Closure Plan, is complete when either:

- Compliance with the requirements of 40 CFR 257.102(c).[20] is achieved, or
- Testing confirms that constituent concentrations remaining in the coal ash impoundment or landfill unit and any concentrations of soil or groundwater affected by any releases do not exceed the lesser of the applicable standards, as adopted by EGLE under Part 115 or the groundwater protection standards established under 40 CFR 257.95(h)[21] and EGLE accepts the certification or, if the constituent concentrations do exceed those standards, EGLE has approved a remedy consistent with R 299.4444 and 299.4445.

Compliance with 40 CFR 257.102(c).[20] requires removing and decontaminating all areas affected by releases from the CCR unit. CCR removal and decontamination are complete when constituent concentrations throughout the CCR unit and any areas affected by releases from the CCR unit have been removed and groundwater monitoring concentrations do not exceed the groundwater protection standard established pursuant to §257.95(h) for constituents listed in Appendix IV to Part 257. DTE's plan for documentation of Closure is presented in Section 4.

4 Closure by Removal of CCR

The BABs will be closed by dewatering the basins, removing and disposing of the CCR at Range Road Landfill (RRLF), backfilling of the basins with soil, grading and topsoiling the finished surfaces, and establishing vegetation. The basin closures will be conducted in compliance with the basin Solid Waste Disposal Area Operating License (No. 9631), RRLF Solid Waste Disposal Area Operating License (No. 9603), and Soil Erosion and Sedimentation Control (SESC) and Flood Plain protection requirements. The following paragraphs describe the BAB closure activities.

4.1 Water Management

Upon cessation of plant operations the BABs will no longer receive sluiced bottom ash and other permitted plant discharges. Some direct precipitation, and surface water run-on from adjacent plant areas will continue to be received. The BAB closure contractor will, to the extent practicable, remove all water from the BABs by discharging it offsite via the NPDES permitted discharge Outfall 001. The primary NPDES discharge criteria for discharge through Outfall 001 and associated monitoring point 001D are presented in Table 4-1.

Table 4-1 NPDES Discharge Criteria

Parameter	Limit	Units	Monitoring Frequency at Outfall 001D	Sample Type
Total Suspended Solids	30	mg/l	Weekly	Grab from Discharge Pipe End
Oil and Grease	15	mg/l	Twice per Month	Grab from Discharge Pipe End
Dewatering Flow	19.5 ¹	MGD	Twice per Week	Meter or Other DTE-Approved Flow Monitoring

1) Total allowable discharge at Outfall 001D is 19.5 MGD

The Contractor will be required to submit a Dewatering Plan for DTE approval, and to comply with the plan throughout basin closure activities. The contractor's Dewatering Plan must include their provisions for maintaining discharge water quality in compliance with NPDES permit criteria.

The BABs are situated in a geologic formation consisting of low hydraulic conductivity natural clay. Hydraulic conductivities as low as 2.0×10^{-8} cm/s have been found in clay samples retrieved from the site and tested. As a result of the low hydraulic conductivity subsurface soils, significant quantities of groundwater seepage into the BABs are not expected through the course of their cleanout and closure.

Sequencing of basin dewatering, first the east basin and then the west basin, may be used to aid water clarification during closure. Water from the east basin will likely be pumped to the west basin for clarification prior to discharge via the NPDES permitted outfall, with additional filtration incorporated upstream of the final outfall, if required, to meet discharge standards. Water from the west basin will be discharged directly via the NPDES permitted outfall, but again with additional filtration utilized, if required, to meet discharge standards.

4.2 CCR Excavation, Transport and Disposal

CCR from the basins will be excavated, loaded directly into leak-tight haul trucks, and transported to and disposed at the RRLF. Once at the landfill the CCR will be mixed with and placed with other CCR being received at the landfill.

The method of CCR excavation from the BABs proposed by the selected contractor entails:

- Basin dewatering (removal of ponded water from above CCR).
- In-basin mixing of cement with the CCR.
- Sequential removal of the cement-stabilized CCR from the basins and replacement with soil backfill.

The selected contractor's method of CCR excavation, properly sequenced and executed, will maintain sheet pile wall stability. This is an important consideration. Over decades of basin operations some of the natural soil into which the sheet pile was embedded has been removed through the course of routine basin dredging operations. Instead of natural soil providing the resistance to movement of the lower portions of the sheet pile walls, in toward the center of the basins, CCR now takes the place of natural soil and provides the necessary resistance to inward sheet pile wall movement. The CCR will be removed as part of clean closure of the basins, including from sheet pile walls, and must be replaced by clean fill that will subsequently provide the lateral sheet pile bracing required as the basin cleanout progresses. The basins will be filled with clean soil as part of basin closure, to the point where lateral wall movement will no longer be a consideration. The steel sheet piles will remain in place, though DTE may choose to remove them at a later date.

4.3 Pipe Removal

The BABs are integrated with the overall plant CCR and process water management systems by a variety of pipelines. These pipelines will be isolated or removed from service concurrent with the closure of the BABs. This will include removal of any remaining CCR from pipeline segments affected by BAB closure. The pipelines identified in the closure specifications for management during BAB closure and the method of pipeline management are:

- 1) Two 8" Fiberglass Bottom Ash Transport Pipes: Remove piping back to elbow (each pipe) at pipe support. Cap pipe using blind flange. Locate source to ash transport line and disconnect pipe (each pipe at source).
- 2) One 48" reinforced concrete pipe (RCP) Bottom Ash Pond Outlet to Overflow Canal: Plug pond end of pipe with concrete a minimum of 3-feet into pipe. Plug pipe at catch basin labeled as

Manhole A a minimum of 3-feet into pipe. Note that Manhole A is to remain active after plant shutdown. In addition to plugging the 48-inch RCP the overflow canal will be plugged upstream of where Manhole A discharges. The overflow canal is an approx. 16 ft x 16 ft concrete canal.

- 3) Trenway Trench A
 - a. 6-inch ashcolite pipe from slag drainage Unit 5. This pipe is no longer active. Pipe will be cut and capped.
 - b. 8" Unit 5 drain sump pipe. This pipe will be rerouted to the plant's main sump. Pipe will be cut where it passes just east of the main sump and then rerouted to the main sump. Rerouting of pipe will require saw cutting of existing concrete drive. Rerouted pipe will be installed such that it's allowed to gravity drain into main sump.
- 4) 12" ashcolite pipe for ash drainage of Unit 5: Pipe will be cut and capped.
- 5) Trenway Trench B: 18" ash drain line for Unit 7. Pipe will be cut and capped.
- 6) One 6" Drain Line from flue dust storage silo. Pipe will be cut and capped.

Any other conduits or pipelines not identified during BAB closure planning will be managed during closure activities by cutting, capping, filling, or other means deemed appropriate by DTE at the time of basin closure.

4.4 Documentation of CCR Removal

Section 3.0 of this Closure Plan presented the regulatory framework for CCR Surface Impoundment Closure by CCR Removal, consisting of removing and decontaminating all areas affected by releases from the CCR unit and demonstrating that:

- constituent concentrations throughout the CCR unit and any areas affected by releases from the CCR unit have been removed, and
- groundwater monitoring concentrations do not exceed the groundwater protection standard established pursuant to §257.95(h) for constituents listed in Appendix IV to Part 257.

The past over-excavation of the BABs and requirement to maintain sheet pile wall stability during CCR removal may constrain physical access to the bottom of the basin for detailed documentation of CCR removal. The safety of DTE, contractor, and consultant personnel will take precedence over detailed documentation of CCR removal. However, the closure specifications emphasize the need to document CCR removal, and the selected contractor's CCR removal approach using cement-stabilization of the CCR should afford such opportunity, within the noted safety constraints. Planned actions for confirming CCR removal from the BABs consist of:

1. Specification of a 6-inch over excavation of the bottom of each basin such that 6 inches of natural soil is removed after the bottom of CCR is encountered. Achievement of the over excavation will be confirmed by:
 - a. Review of the consistency (plasticity) of the lowest excavated material – the natural clay will have some plasticity whereas the CCR will not.
 - b. Review of the color of the lowest excavated material – the natural clay will be dark brown to grayish brown whereas the CCR will be primarily gray.

2. Visual evaluation of excavation bottom with photographic documentation that CCR has been removed.
3. Documentation of base of excavation grades as confirmation that excavation depth exceeded the depth of CCR identified during basin geotechnical exploration for closure design.
4. Review of two subsequent rounds of CCR unit groundwater water monitoring data to confirm groundwater quality parameter concentrations do not exceed groundwater protection standards.

CCR removal will be documented in a Construction Documentation Report (CDR) at the conclusion of construction efforts. The CDR is anticipated to include the following information:

- Summary statement of purpose and scope of work and associated closure criteria;
- Parties and personnel involved with the project;
- Narrative of the project (chronologically), including a discussion of challenges encountered and how they were addressed;
- CCR removal documentation methods;
- Documentation that CCR removal criteria were met in accordance with the plans and specifications;
- Photographic documentation of major activities;
- Record drawings showing the excavation area and final grades, structures and permanent soil erosion and sedimentation control features;
- Copies of associated written correspondence (if any) with regulatory agencies; and
- Certification by a Michigan Professional Engineer that construction was in accordance with the closure plans and specifications, and basis for any necessary deviations from the closure plans and specifications.

The CCR-removal and basin closure CDR is anticipated to be submitted to EGLE in late 2022, with a final certification that groundwater meets groundwater protection standards to be submitted as a stand-alone addendum to the CDR in summer or fall of 2023.

4.5 Site Restoration

The BABs will be filled with clean soil fill from a Michigan Department of Transportation (MDOT) – approved and DTE-approved clean soil borrow source. The fill will be placed from the bottom of the cleaned basins to the specified ground surface. The filled surface of each BAB will receive a 6-inch layer of topsoil and vegetation will be established to stabilize the soil and prevent surficial erosion. The finished surface of each basin will be contoured to facilitate surface water runoff – final contours specified for the closed basins are shown on the drawings in Attachment A.

4.6 Post-Excavation Monitoring

After removal of CCR from the BABs, DTE will continue to perform semi-annual (two rounds per year) of post-closure groundwater monitoring as specified in CCR Rule §257.102(c) and/or in NREPA Part 115 Solid Waste Management 324.11519b(9)(a). Groundwater monitoring will be performed in accordance with the existing Quality Assurance Project Plan – DTE Electric Company STCPP Bottom Ash Basin (the QAPP) (TRC, July 2016; revised August 2017) and statistically evaluated per the Groundwater Statistical Evaluation Plan

– DTE Electric Company STCPP CCR Bottom Ash Basins (TRC, October 2017). Because the BABs will be closed by CCR removal, DTE proposes to discontinue groundwater monitoring and to decommission the monitoring well network after two consecutive post-closure rounds of sampling demonstrate that groundwater monitoring concentrations do not exceed the groundwater protection standards established pursuant to 257.95(h) for the constituents listed in Appendix IV to Part 257.

5 Project Schedule

DTE has established a schedule to accomplish all BAB closure activities in 2022. This includes project bidding, execution, and documentation. DTE selected a group of qualified bidders, solicited bids, awarded the bid in mid-April 2022, and will execute the remainder of the project as shown in the project schedule summarized in Table 5-1.

Table 5-1 STCPP BAB Closure Schedule

Activity	Date
Bid Award (complete)	mid-April, 2022
Contractor Submittals Begin	early June, 2022
Start of In-Field BAB Closure	July 05, 2022
BAB Closure Complete	late October/early November, 2022
BAB Closure Documentation	late December, 2022
Final Groundwater Certification – As Stand-Alone Addendum to BAB Closure Documentation Report	Summer or Fall 2023

The schedule above is approximate – DTE will update EGLE as schedule changes and as work progresses, in the event EGLE wishes to visit the site during BAB Closure.

Figure 1

St. Clair BAB Aerial View



Aerial Image: Google Earth, 10/11/2020 10:27:58.31 EST. File Path: \\BARR\Projects\2021\2021-2022 Geotechnical Investigation\St. Clair Power Plant\2021-2022 Geotechnical Investigation\Users\BARR



2021-2022 GEOTECHNICAL INVESTIGATION LOCATIONS
St. Clair Power Plant
DTE Energy
4901 Pointe Drive
China Township, Michigan

FIGURE 1

Attachment A

Bottom Ash Basin Closure Drawings

DTE ENERGY

ST. CLAIR COUNTY, EAST CHINA, MICHIGAN

ST. CLAIR POWER PLANT

BOTTOM ASH BASIN CLOSURE PROJECT

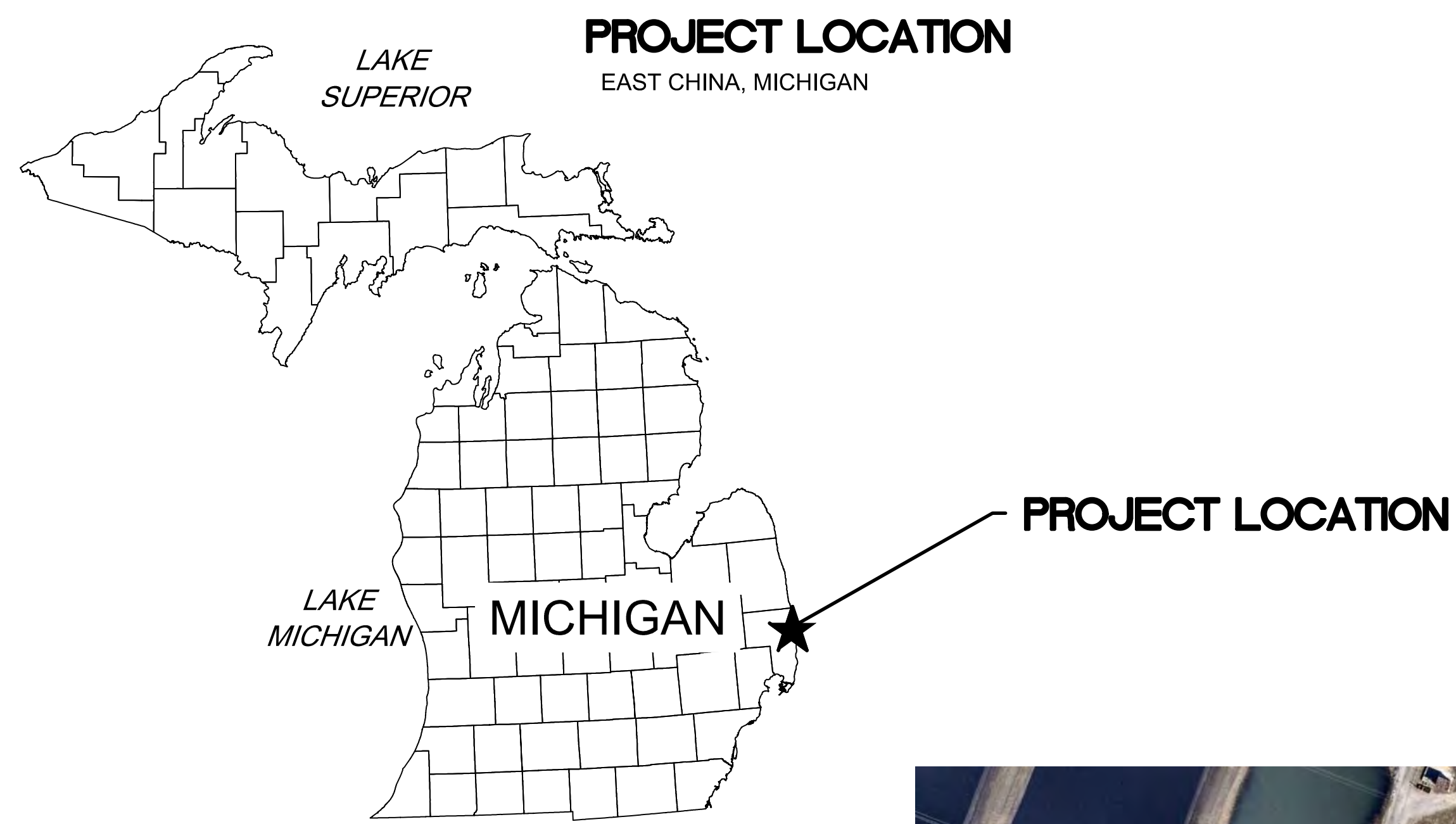

INDEX OF DRAWINGS

DOCUMENT #	REV.	NAME
0516-C-3045		COVER SHEET
0516-C-3046		EXISTING CONDITIONS PLAN
0516-C-3047		SITE DEMOLITION PLAN
0516-C-3048		FINAL GRADING AND RESTORATION PLAN
0516-C-3049		BASIN CROSS-SECTIONS
0516-C-3050		EXISTING CONDITIONS STRUCTURAL DETAILS
0516-C-3051		GENERAL DETAILS
0516-C-3052		STORMWATER SECTIONS AND DETAILS
0516-C-3053		SPECIFICATIONS
0516-M-7435		PUMP BUILDING AND SILO DRAIN SUMP PLAN, PROFILES, AND DETAILS
0516-M-7436		UNIT 5 DRAIN SUMP PIPE REROUTE PLAN AND DETAILS

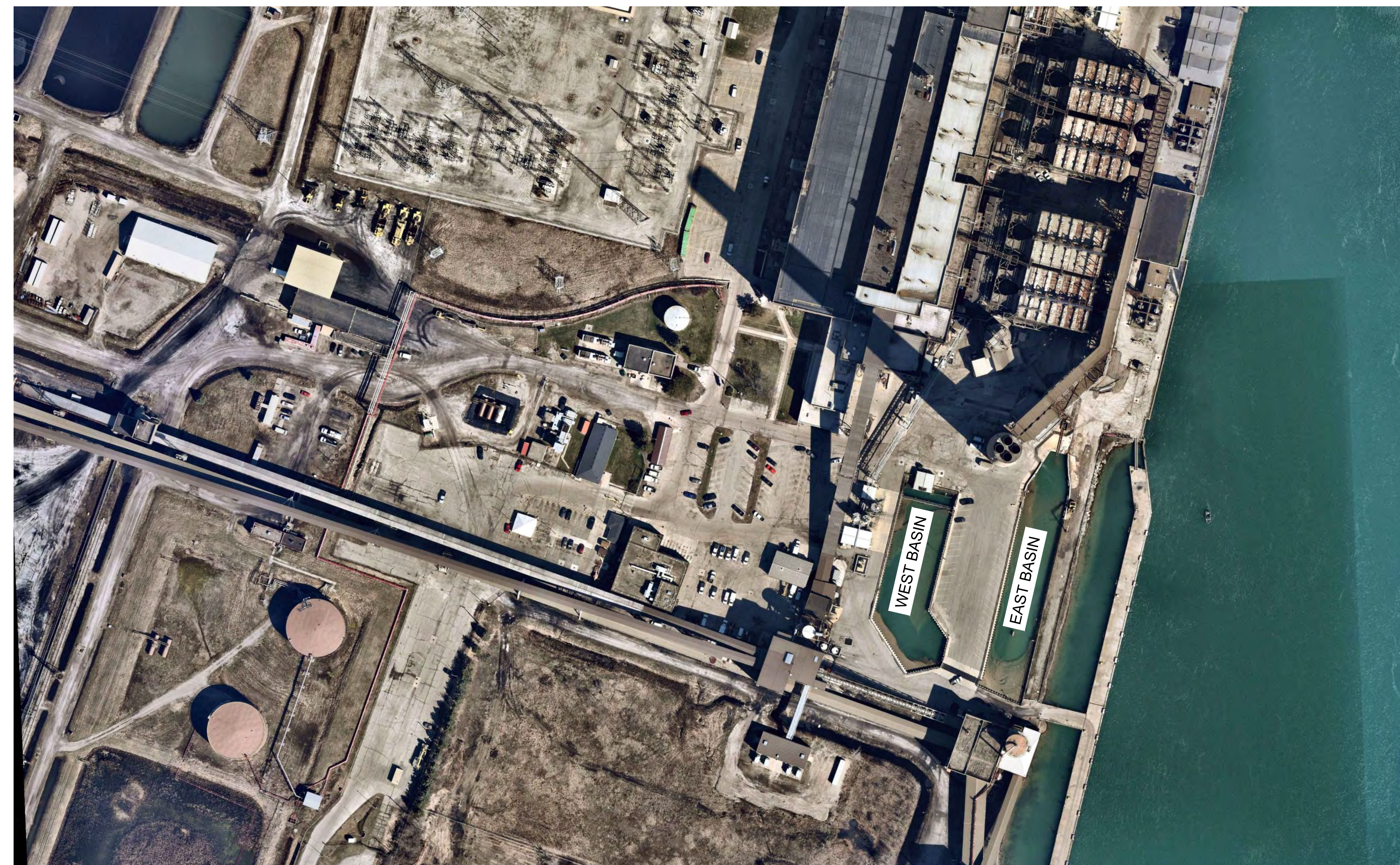

TYPICAL CALL OUTS

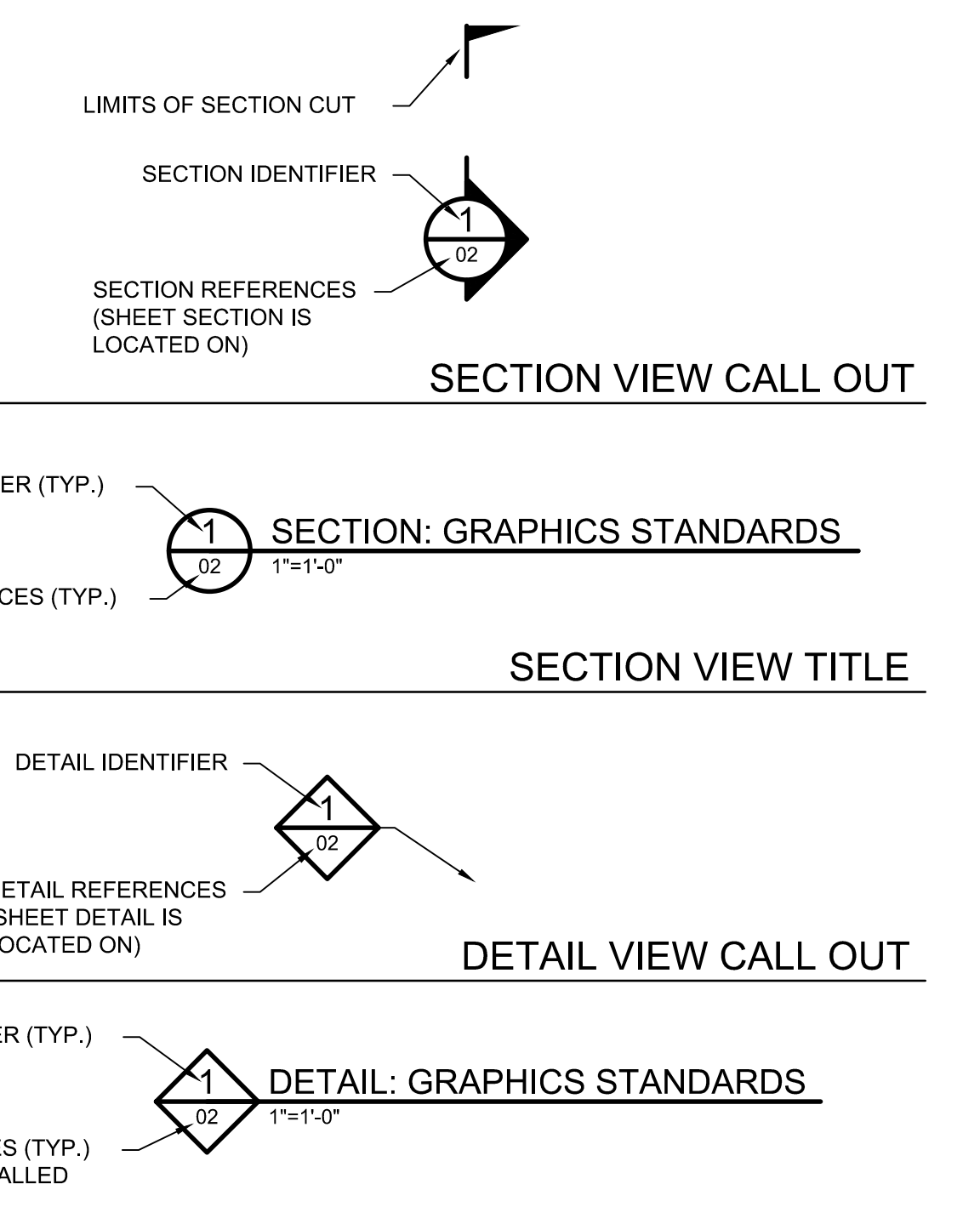

0516-C-3045
LATEST REVISION

NO.	DATE	ISSUED FOR	PROJ. ENG.	RESP. ENG.
6				
5				
4	01FEB22	CONSTRUCTION	S. MASTERS	R. CHRISTENSEN
3	14JAN22	90% DESIGN REVIEW	S. MASTERS	R. CHRISTENSEN
2	20DEC21	60% DESIGN REVIEW	S. MASTERS	R. CHRISTENSEN
1	29OCT21	50% DESIGN REVIEW	S. MASTERS	R. CHRISTENSEN

PROJECT ENGINEER: S. MASTERS APPROVALS

PRECONSTRUCTION REVISION BLOCK - REV. 0

Vendor:

BARR
BARR ENGINEERING CO.
3005 BENTONVILLE STREET
SUITE 100
ANN ARBOR, MI 48106
PH: 734.769.0101

DTE

ST. CLAIR COUNTY POWER PLANT

BOTTOM ASH BASIN CLOSURE COVER SHEET

DESIGNED BY: S. HUECKMAN DATE: 21OCT21
 DRAWN BY: J. METTLACH DATE: 26OCT21
 CHECKED BY: R. CHRISTENSEN DATE: 29OCT21
 APPROVED BY: R. CHRISTENSEN DATE: 01FEB22
 PROJECT ENGINEER: S. MASTERS DATE: 01FEB22
 PROJECT MANAGER: DATE:

LOCATION NAME: ST. CLAIR COUNTY POWER PLANT UNIT NUMBER:
 ORIGINATING SOURCE: BARR ENGINEERING CO. SCALE: AS SHOWN USE DIMENSIONS DO NOT SCALE.
 DTE ELECTRIC COMPANY DRAWING NUMBER: 0516-C-3045

GENERAL NOTES

- EXISTING TOPOGRAPHIC INFORMATION BASED ON JULY 2016 SSCP ASH BASIN TOPO SURVEY BY MCNEELY & LINCOLN ASSOCIATES, INC. AND UPDATED WITH MAY 2021 BATHYMETRIC DATA BY BMJ ENGINEERS & SURVEYORS, INC.
- ELEVATIONS ARE PRESENTED IN THE DTE PLANT VERTICAL DATUM (ORIGIN UNKNOWN).
- ALL COORDINATES ARE PRESENTED IN THE DTE PLANT HORIZONTAL DATUM (ORIGIN UNKNOWN).

VICINITY MAP

C				B				A			
PROJ.	DESIGN	TEST	DRG	PROJ.	DESIGN	TEST	DRG	PROJ.	DESIGN	TEST	DRG
MADE BY	DATE	INC	ELECT.	MADE BY	DATE	INC	ELECT.	MADE BY	DATE	INC	ELECT.
CHK BY	DATE	MECH.	APPROVED BY	CHK BY	DATE	MECH.	APPROVED BY	CHK BY	DATE	MECH.	APPROVED BY

THIS IS AN CAD PRODUCED DRAWING.
ANY CHANGES OR REVISIONS TO
THIS DRAWING MUST BE COMPLETED
USING THE CAD SYSTEM.

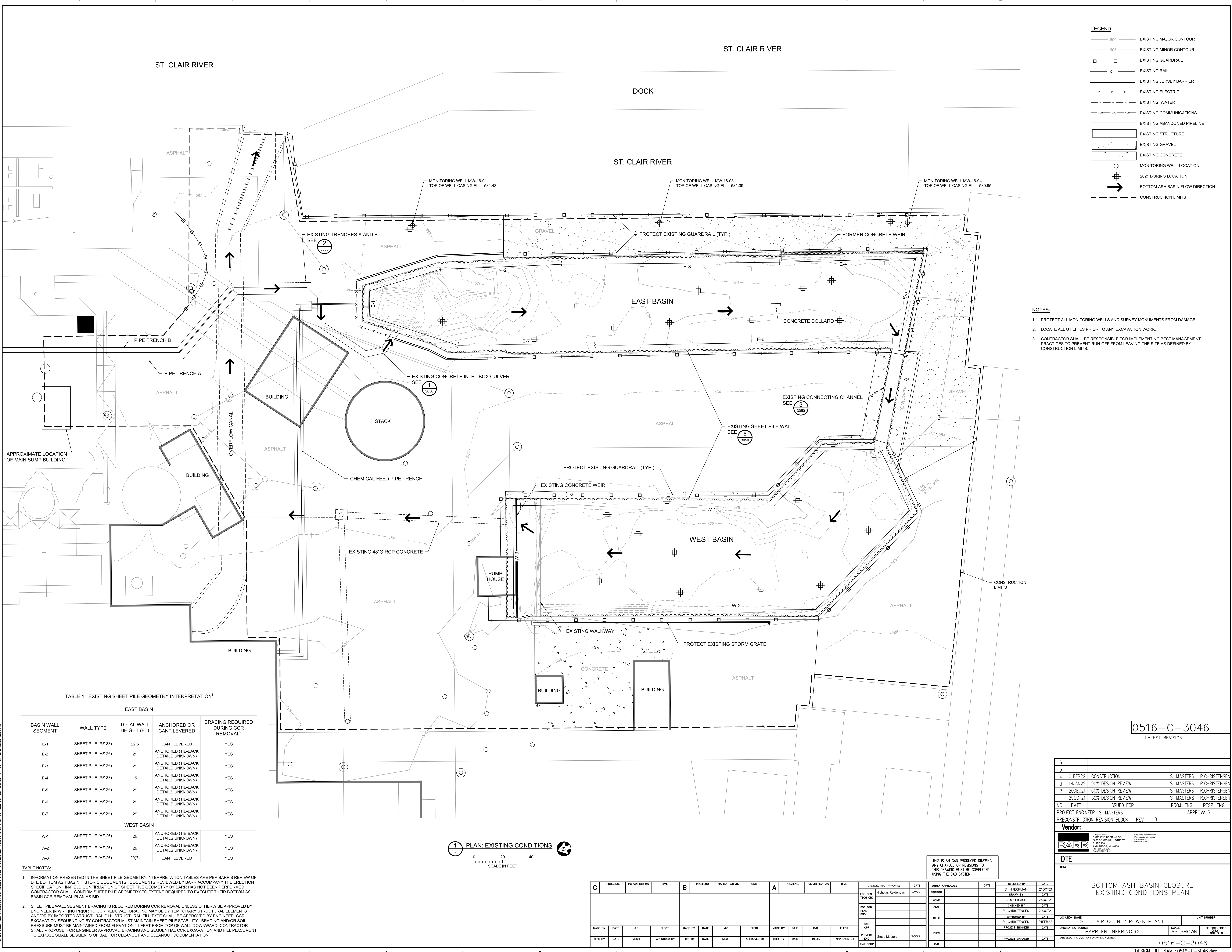

LEGEND

- 600 — EXISTING MAJOR CONTOUR
- 605 — EXISTING MINOR CONTOUR
- □ — EXISTING GUARDRAIL
- x — EXISTING RAIL
- — — EXISTING JERSEY BARRIER
- e — e — e — EXISTING ELECTRIC
- w — w — w — EXISTING WATER
- — — EXISTING COMMUNICATIONS
- — — EXISTING ABANDONED PIPELINE
- — — EXISTING STRUCTURE
- — — EXISTING GRAVEL
- — — EXISTING CONCRETE
- ⊕ MONITORING WELL LOCATION
- ⊕ 2021 BORING LOCATION
- BOTTOM ASH BASIN FLOW DIRECTION
- - - CONSTRUCTION LIMITS

- NOTES:**
- PROTECT ALL MONITORING WELLS AND SURVEY MONUMENTS FROM DAMAGE.
 - LOCATE ALL UTILITIES PRIOR TO ANY EXCAVATION WORK.
 - CONTRACTOR SHALL BE RESPONSIBLE FOR IMPLEMENTING BEST MANAGEMENT PRACTICES TO PREVENT RUN-OFF FROM LEAVING THE SITE AS DEFINED BY CONSTRUCTION LIMITS.

TABLE 1 - EXISTING SHEET PILE GEOMETRY INTERPRETATION¹

EAST BASIN				
BASIN WALL SEGMENT	WALL TYPE	TOTAL WALL HEIGHT (FT)	ANCHORED OR CANTILEVERED	BRACING REQUIRED DURING CCR REMOVAL ²
E-1	SHEET PILE (PZ-38)	22.5	CANTILEVERED	YES
E-2	SHEET PILE (AZ-26)	29	ANCHORED (TIE-BACK DETAILS UNKNOWN)	YES
E-3	SHEET PILE (AZ-26)	29	ANCHORED (TIE-BACK DETAILS UNKNOWN)	YES
E-4	SHEET PILE (PZ-38)	15	ANCHORED (TIE-BACK DETAILS UNKNOWN)	YES
E-5	SHEET PILE (AZ-26)	29	ANCHORED (TIE-BACK DETAILS UNKNOWN)	YES
E-6	SHEET PILE (AZ-26)	29	ANCHORED (TIE-BACK DETAILS UNKNOWN)	YES
E-7	SHEET PILE (AZ-26)	29	ANCHORED (TIE-BACK DETAILS UNKNOWN)	YES
WEST BASIN				
W-1	SHEET PILE (AZ-26)	29	ANCHORED (TIE-BACK DETAILS UNKNOWN)	YES
W-2	SHEET PILE (AZ-26)	29	ANCHORED (TIE-BACK DETAILS UNKNOWN)	YES
W-3	SHEET PILE (AZ-26)	29(?)	CANTILEVERED	YES

- TABLE NOTES:**
- INFORMATION PRESENTED IN THE SHEET PILE GEOMETRY INTERPRETATION TABLES ARE PER BARR'S REVIEW OF DTE BOTTOM ASH BASIN HISTORIC DOCUMENTS. DOCUMENTS REVIEWED BY BARR ACCOMPANY THE EXECUTION SPECIFICATION. IN-FIELD CONFIRMATION OF SHEET PILE GEOMETRY BY BARR HAS NOT BEEN PERFORMED. CONTRACTOR SHALL CONFIRM SHEET PILE GEOMETRY TO EXTENT REQUIRED TO EXECUTE THEIR BOTTOM ASH BASIN CCR REMOVAL PLAN AS BID.
 - SHEET PILE WALL SEGMENT BRACING IS REQUIRED DURING CCR REMOVAL UNLESS OTHERWISE APPROVED BY ENGINEER IN WRITING PRIOR TO CCR REMOVAL. BRACING MAY BE BY TEMPORARY STRUCTURAL ELEMENTS AND/OR BY IMPORTED STRUCTURAL FILL. STRUCTURAL FILL TYPE SHALL BE APPROVED BY ENGINEER. CCR EXCAVATION SEQUENCING BY CONTRACTOR MUST MAINTAIN SHEET PILE STABILITY. BRACING AND/OR SOIL PRESSURE MUST BE MAINTAINED FROM ELEVATION 14 FEET FROM TOP OF WALL DOWNWARD. CONTRACTOR SHALL PROPOSE, FOR ENGINEER APPROVAL, BRACING AND SEQUENTIAL CCR EXCAVATION AND FILL PLACEMENT TO EXPOSE SMALL SEGMENTS OF BAB FOR CLEANOUT AND CLEANOUT DOCUMENTATION.

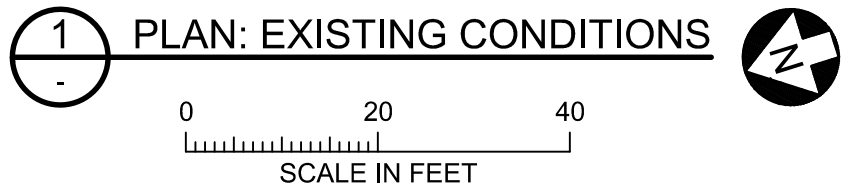

0516-C-3046
LATEST REVISION

6				
5				
4	01FEB22	CONSTRUCTION	S. MASTERS	R. CHRISTENSEN
3	14JAN22	90% DESIGN REVIEW	S. MASTERS	R. CHRISTENSEN
2	20DEC21	60% DESIGN REVIEW	S. MASTERS	R. CHRISTENSEN
1	29OCT21	50% DESIGN REVIEW	S. MASTERS	R. CHRISTENSEN
NO.	DATE	ISSUED FOR	PROJ. ENG.	RESP. ENG.
PROJECT ENGINEER: S. MASTERS			APPROVALS	
PRECONSTRUCTION REVISION BLOCK - REV. 0				

Vendor:

BARR
BARR ENGINEERING CO.
3005 BROADWAY STREET
ANN ARBOR, MI 48106
PH: (734) 221-0111

DTE
TITLE: BOTTOM ASH BASIN CLOSURE EXISTING CONDITIONS PLAN

DESIGNED BY: S. HUECKMAN 21OCT21
 DRAWN BY: J. METTLACH 26OCT21
 CHECKED BY: R. CHRISTENSEN 29OCT21
 APPROVED BY: R. CHRISTENSEN 01FEB22
 PROJECT ENGINEER: DATE
 PROJECT MANAGER: DATE

LOCATION NAME: ST. CLAIR COUNTY POWER PLANT UNIT NUMBER
 ORIGINATING SOURCE: BARR ENGINEERING CO. SCALE: AS SHOWN USE DIMENSIONS DO NOT SCALE
 DTE ELECTRIC COMPANY DRAWING NUMBER: 0516-C-3046

C				B				A			
PROJ. ENG.	DESIGN	CHECK	DATE	PROJ. ENG.	DESIGN	CHECK	DATE	PROJ. ENG.	DESIGN	CHECK	DATE
DTE ELECTRIC APPROVALS				OTHER APPROVALS				DATE			
FOR GEN. TECH. DRG. Nicholas Reidenbach 2/2/22				FOR GEN. PLANT ENG. R. CHRISTENSEN 29OCT21				FOR GEN. DIST. DRG. Steve Masters 2/3/22			
PROJECT ENG. DATE				PROJECT ENG. DATE				PROJECT ENG. DATE			
ENG. COMP. DATE				ENG. COMP. DATE				ENG. COMP. DATE			

THIS IS AN CAD PRODUCED DRAWING. ANY CHANGES OR REVISIONS TO THIS DRAWING MUST BE COMPLETED USING THE CAD SYSTEM.

ST. CLAIR RIVER

ST. CLAIR RIVER

DOCK

ST. CLAIR RIVER

LEGEND

— 580 —	EXISTING MAJOR CONTOUR
— 583 —	EXISTING MINOR CONTOUR
— □ —	EXISTING GUARDRAIL
— x —	EXISTING RAIL
— — —	EXISTING JERSEY BARRIER
— w — w — w —	EXISTING ELECTRIC
— — —	EXISTING WATER
— — —	EXISTING COMMUNICATIONS
▨	EXISTING STRUCTURE
▨	DEMOLITION
⊕	MONITORING WELL LOCATION
⊕	2021 BORING LOCATION
— 565 —	PROPOSED CCR EXCAVATION MAJOR CONTOUR (SEE NOTE 1)
— 567 —	PROPOSED CCR EXCAVATION MINOR CONTOUR (SEE NOTE 1)
- - - - -	CONSTRUCTION LIMITS

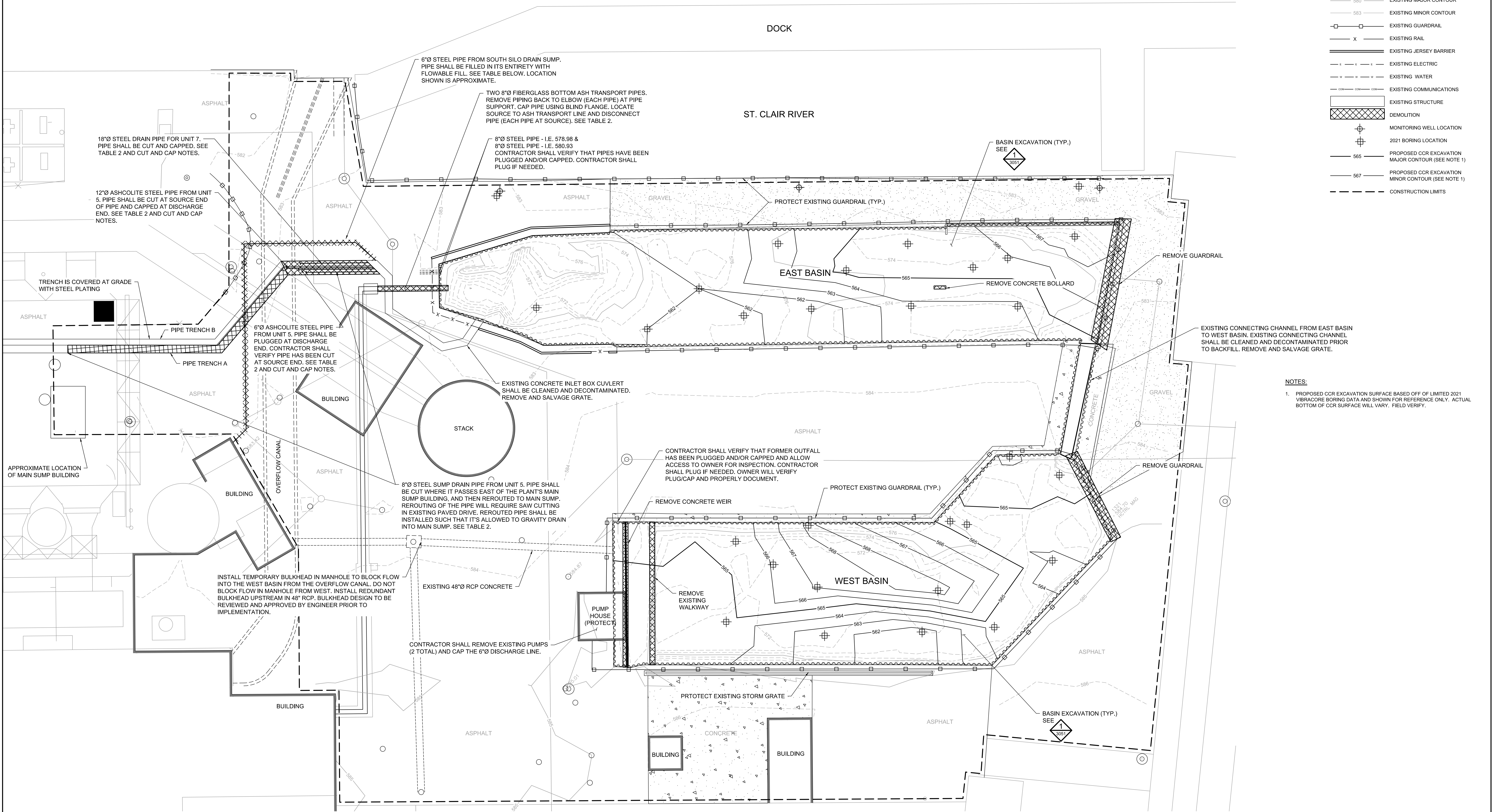

NOTES:

1. PROPOSED CCR EXCAVATION SURFACE BASED OFF OF LIMITED 2021 VIBROCORE BORING DATA AND SHOWN FOR REFERENCE ONLY. ACTUAL BOTTOM OF CCR SURFACE WILL VARY. FIELD VERIFY.

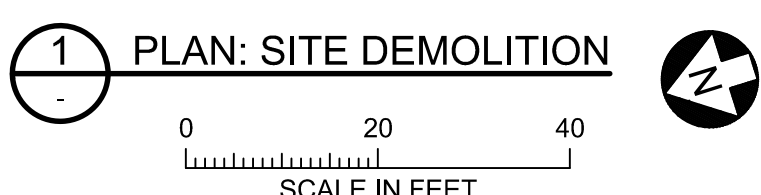
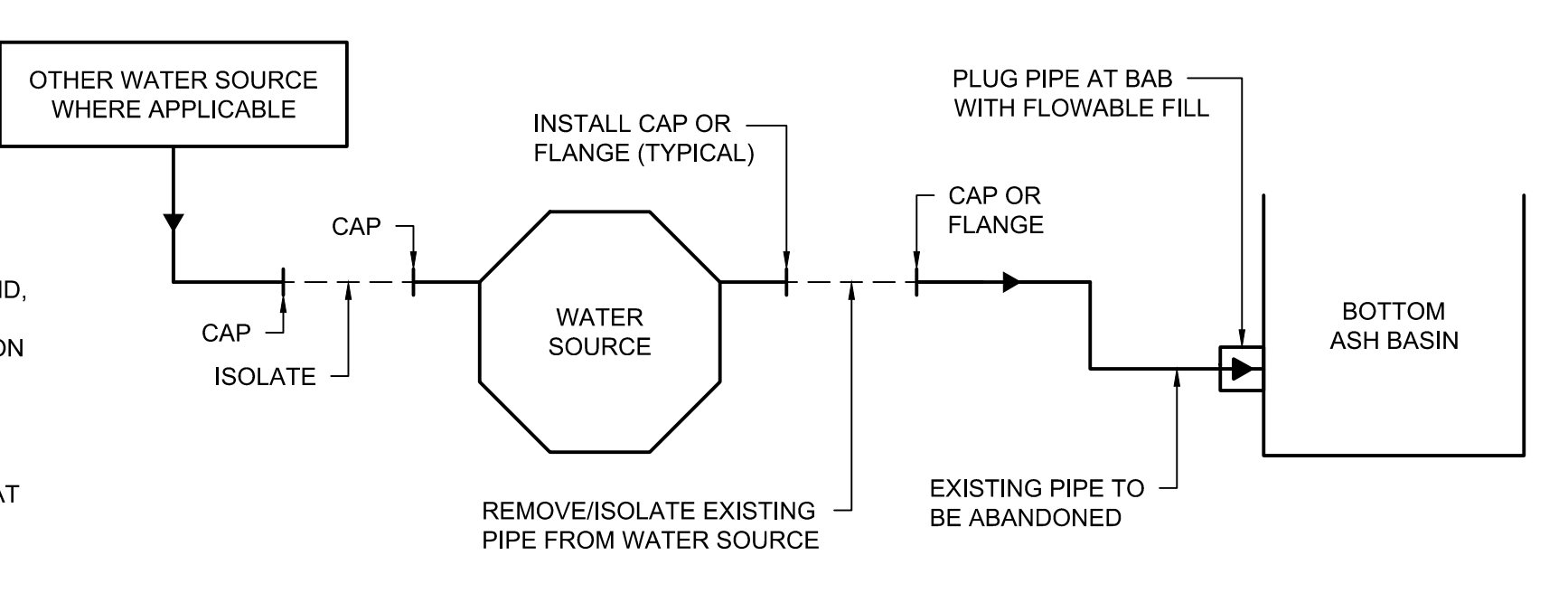

TABLE 2 - PIPE ABANDONMENT AND RE-ROUTE SUMMARY

PIPE LOCATION	PIPE SIZE / ID	MATERIAL	CURRENT USE	SCOPE
TRENCH A	6" ASHCOLITE PIPE	STEEL	INACTIVE PIPE. THIS PIPE IS NO LONGER ACTIVE AND HAS BEEN DECOMMISSIONED UPSTREAM OF BAB.	PLUG PIPE WHERE IT DISCHARGES INTO THE CHEMICAL TREATMENT TRENCH WITH FLOWABLE FILL A MINIMUM OF 10' INTO PIPE.
TRENCH A	8" UNIT 5 DRAIN SUMP PIPE	STEEL	ACTIVE PIPE USED TO DRAIN UNIT 5 SUMP.	PIPE TO BE REROUTED TO PLANT'S MAIN SUMP. SEE DETAILS SHEET M7439.
TRENCH A	12" ASHCOLITE PIPE	STEEL	ACTIVE PIPE USED FOR DRAINING UNIT 5.	1. PLUG PIPE WHERE IT DISCHARGES INTO THE CHEMICAL TREATMENT TRENCH WITH FLOWABLE FILL A MINIMUM OF 10' INTO PIPE. 2. TRACE PIPE BACK TO THE UNIT 5 SOURCE OF WATER. DISCONNECT PIPE FROM ITS WATER SOURCE AND INSTALL CAP ON EACH EXPOSED END OF PIPE. IF APPLICABLE, REMOVE PRIMARY SOURCE OF WATER TO UNIT 5.
TRENCH B	18" DRAIN PIPE FOR UNIT 7	STEEL	ACTIVE PIPE USED FOR DRAINING UNIT 7.	1. PLUG PIPE WHERE IT DISCHARGES INTO THE CHEMICAL TREATMENT TRENCH WITH FLOWABLE FILL A MINIMUM OF 10' INTO PIPE. 2. TRACE PIPE BACK TO THE UNIT 7 SOURCE OF WATER. DISCONNECT PIPE FROM ITS WATER SOURCE AND INSTALL CAP ON EACH EXPOSED END OF PIPE. IF APPLICABLE, REMOVE PRIMARY SOURCE OF WATER TO UNIT 7.
CHEMICAL TREATMENT TRENCH	6" DRAIN LINE	STEEL	ACTIVE PIPE USED TO DRAIN SOUTH SILO SUMP.	1. FILL ENTIRE LENGTH OF PIPE WITH FLOWABLE FILL. 2. TRACE PIPE BACK TO THE NORTH SILO SOURCE OF WATER. DISCONNECT PIPE FROM ITS WATER SOURCE AND INSTALL CAP ON EACH EXPOSED END OF PIPE. IF APPLICABLE, REMOVE PRIMARY SOURCE OF WATER TO NORTH SILO.
BAB ABOVE GRADE INFLUENT PIPING	2-8" ASH TRANSPORT PIPES	FIBERGLASS	ACTIVE PIPES USED TO TRANSPORT BOTTOM ASH TO THE BOTTOM ASH POND.	1. REMOVE AND DISCARD THE ABOVE GRADE PIPE BACK TO THE CONCRETE CHAMBER. 2. PLUG THE END OF EACH PIPE WITH FLOWABLE FILL, AT LEAST 10' INTO THE PIPE. 3. TRACE PIPE BACK TO THE ORIGINAL SOURCE OF WATER. DISCONNECT PIPE FROM ITS WATER SOURCE AND INSTALL CAP ON EACH EXPOSED END OF PIPE. SOURCE FOR BOTH PIPES IS IN THE BASEMENT OF THE PLANT UNDER UNITS 1-4.

CUT AND CAP NOTES:

1. CUT AND CAP PIPE AT BOTH ENDS OF THE PIPE. AT THE DISCHARGE END, PLUG PIPE WITH CONCRETE. AT THE SOURCE END, CUT THE PIPE AT A PRESELECTED FLANGE OR ELBOW AND PHYSICALLY REMOVE A SECTION OF PIPE. THIS APPROACH ISOLATES THE PIPE FROM THE BOTTOM ASH POND, WHICH ELIMINATES THE POTENTIAL FOR AN ACCIDENTAL RELEASE TO THE POND.
2. IF THE SOURCE END OF THE PIPE ORIGINATES AT A UNIT/PROCESS THAT HAS A WATER SUPPLY, THEN THE CONTRACTOR SHALL REMOVE THE SUPPLY OF WATER INTO THE UNIT BY CLOSING ALL WATER SUPPLY VALVES TO THE UNIT AND THEN REMOVING A SECTION OF THE PIPE BETWEEN THE UNIT AND THE VALVE. THE SAME PROCESS SHALL BE COMPLETED ON THE WATER SUPPLY DISCHARGE END. THIS APPROACH ELIMINATES THE WATER SUPPLY FROM ACCIDENTALLY BEING TURNED ON, CAUSING A RELEASE FROM THE UNIT.



THIS IS AN CAD PRODUCED DRAWING. ANY CHANGES OR REVISIONS TO THIS DRAWING MUST BE COMPLETED USING THE CAD SYSTEM.

C		B		A		DATE		DATE		DATE	
PROJ. ENG.	DESIGNER	PROJ. ENG.	DESIGNER	PROJ. ENG.	DESIGNER	DATE	DATE	DATE	DATE	DATE	DATE
Steve Masters	Steve Masters	Steve Masters	Steve Masters	Steve Masters	Steve Masters	2/3/22	2/3/22	2/3/22	2/3/22	2/3/22	2/3/22

0516-C-3047
LATEST REVISION

NO.	DATE	ISSUED FOR	PROJ. ENG.	RESP. ENG.
6				
5				
4	01FEB22	CONSTRUCTION	S. MASTERS	R. CHRISTENSEN
3	14JAN22	90% DESIGN REVIEW	S. MASTERS	R. CHRISTENSEN
2	20DEC21	60% DESIGN REVIEW	S. MASTERS	R. CHRISTENSEN
1	29OCT21	50% DESIGN REVIEW	S. MASTERS	R. CHRISTENSEN

Vendor:

BARR ENGINEERING CO.
3005 SANDHURST DR. SUITE 100
ANDERSON, SC 29625
PH: 803.792.0171

DTE

ST. CLAIR COUNTY POWER PLANT

BOTTOM ASH BASIN CLOSURE SITE DEMOLITION PLAN

0516-C-3047
DATE: 02FEB22 OPERATOR: JAM6

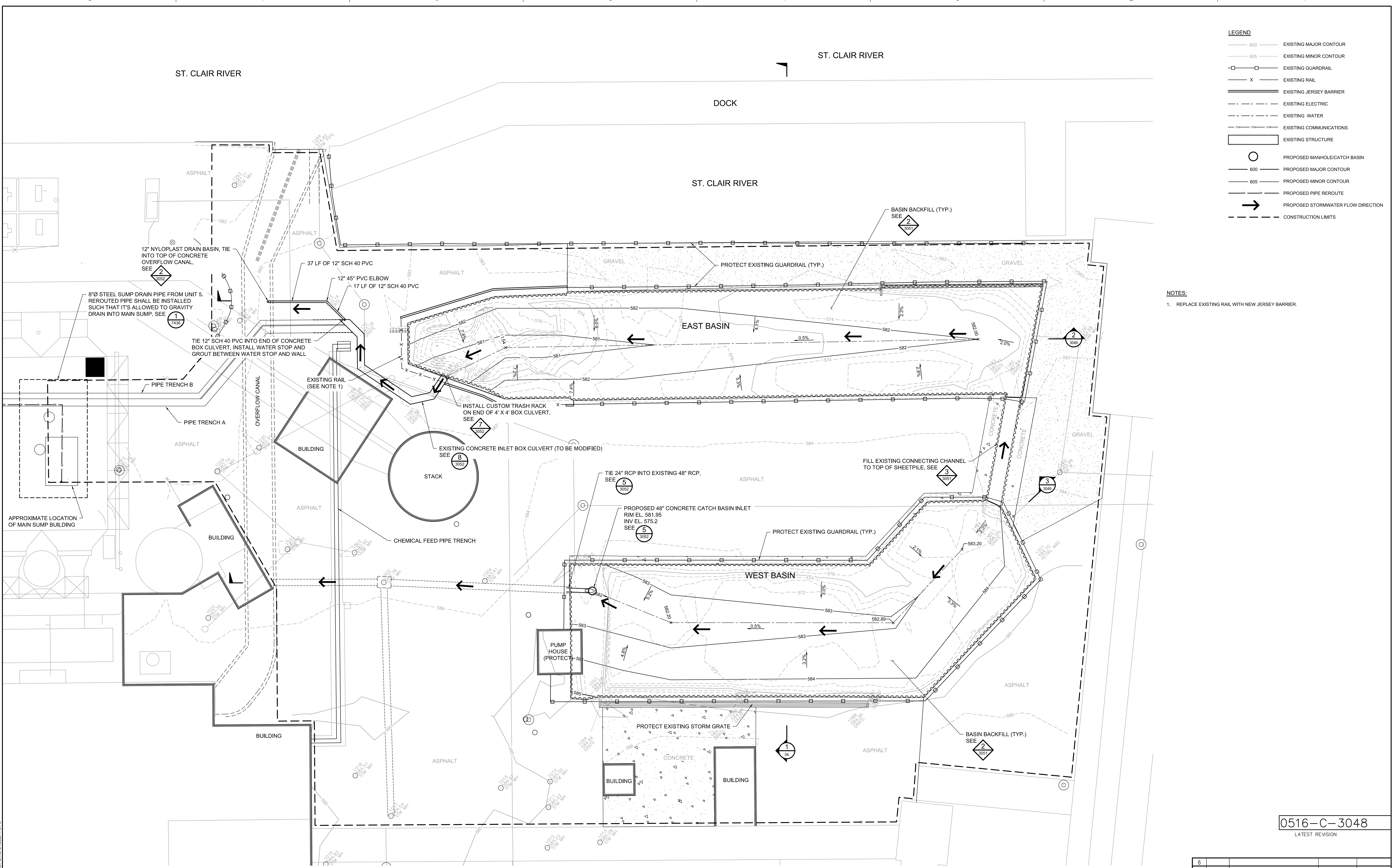

LEGEND

---	EXISTING MAJOR CONTOUR
---	EXISTING MINOR CONTOUR
---	EXISTING GUARDRAIL
X---	EXISTING RAIL
====	EXISTING JERSEY BARRIER
---	EXISTING ELECTRIC
---	EXISTING WATER
---	EXISTING COMMUNICATIONS
---	EXISTING STRUCTURE
○	PROPOSED MANHOLE/CATCH BASIN
---	PROPOSED MAJOR CONTOUR
---	PROPOSED MINOR CONTOUR
---	PROPOSED PIPE REROUTE
→	PROPOSED STORMWATER FLOW DIRECTION
- - -	CONSTRUCTION LIMITS

NOTES:
 1. REPLACE EXISTING RAIL WITH NEW JERSEY BARRIER.

0516-C-3048
 LATEST REVISION

1 PLAN: FINAL GRADING AND RESTORATION
 0 20 40
 SCALE IN FEET

6				
5				
4	01FEB22	CONSTRUCTION	S. MASTERS	R. CHRISTENSEN
3	14JAN22	90% DESIGN REVIEW	S. MASTERS	R. CHRISTENSEN
2	20DEC21	60% DESIGN REVIEW	S. MASTERS	R. CHRISTENSEN
1	29OCT21	50% DESIGN REVIEW	S. MASTERS	R. CHRISTENSEN
NO.	DATE	ISSUED FOR	PROJ. ENG.	RESP. ENG.
PROJECT ENGINEER: S. MASTERS			APPROVALS	
PRECONSTRUCTION REVISION BLOCK - REV. 0				

Vendor:
BARR
 BARR ENGINEERING CO.
 3005 BENTONVILLE STREET
 SUITE 100
 ANDOVER, MA 01810
 PH: 978-232-0171

DTE
 TITLE

ST. CLAIR COUNTY POWER PLANT		UNIT NUMBER
BOTTOM ASH BASIN CLOSURE FINAL GRADING AND RESTORATION PLAN		
ORIGINATING SOURCE	BARR ENGINEERING CO.	SCALE AS SHOWN
DTE ELECTRIC COMPANY DRAWING NUMBER	0516-C-3048	USE DIMENSIONS DO NOT SCALE

THIS IS AN CAD PRODUCED DRAWING.
 ANY CHANGES OR REVISIONS TO
 THIS DRAWING MUST BE COMPLETED
 USING THE CAD SYSTEM

PROLOGS.	FIS GEN TECH DRG	CIVIL	PROLOGS.	FIS GEN TECH DRG	CIVIL	PROLOGS.	FIS GEN TECH DRG	CIVIL	DTE ELECTRIC APPROVALS	DATE	OTHER APPROVALS	DATE	DESIGNED BY	DATE
									Nicholas Reinhardt	2/2/22			S. HUECKEMAN	21OCT21
													J. METTLACH	26OCT21
													R. CHRISTENSEN	29OCT21
													R. CHRISTENSEN	01FEB22
													PROJECT ENGINEER	DATE
													PROJECT MANAGER	DATE

CAD USER: Jam J. 2/2/22 1:13 PM
 FILE: ALPHAS02214108100221410800_C3048_GRAVING.DWG PLOT SCALE: 1:1 PLOT DATE: 2/1/2022 1:13 PM

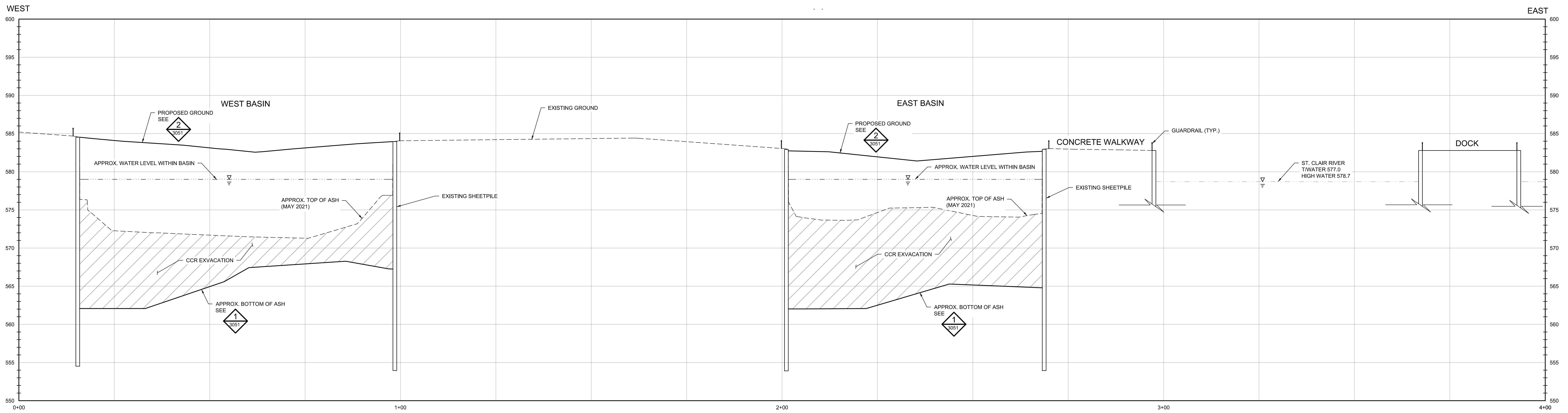

1 SECTION: OVERALL SITE
 HORIZONTAL SCALE IN FEET: 0 10 20
 VERTICAL SCALE IN FEET: 0 5 10

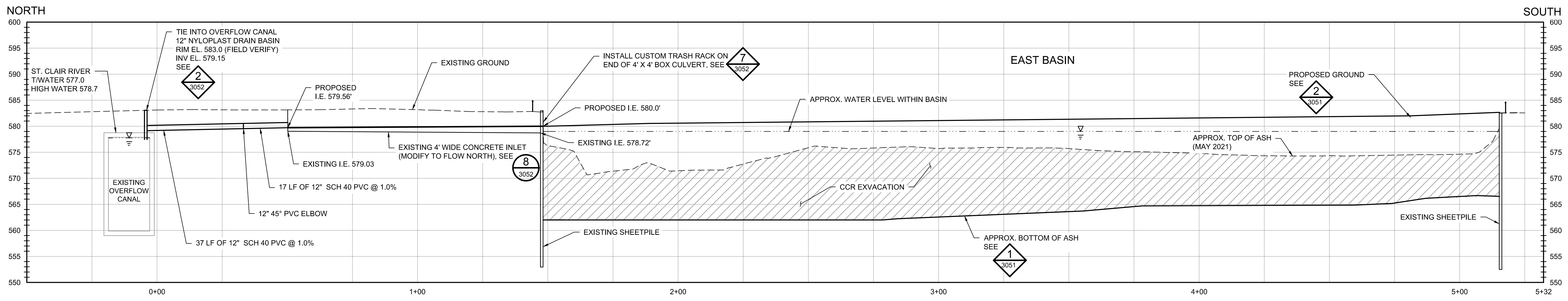

2 SECTION: EAST BASIN
 HORIZONTAL SCALE IN FEET: 0 20 40
 VERTICAL SCALE IN FEET: 0 10 20

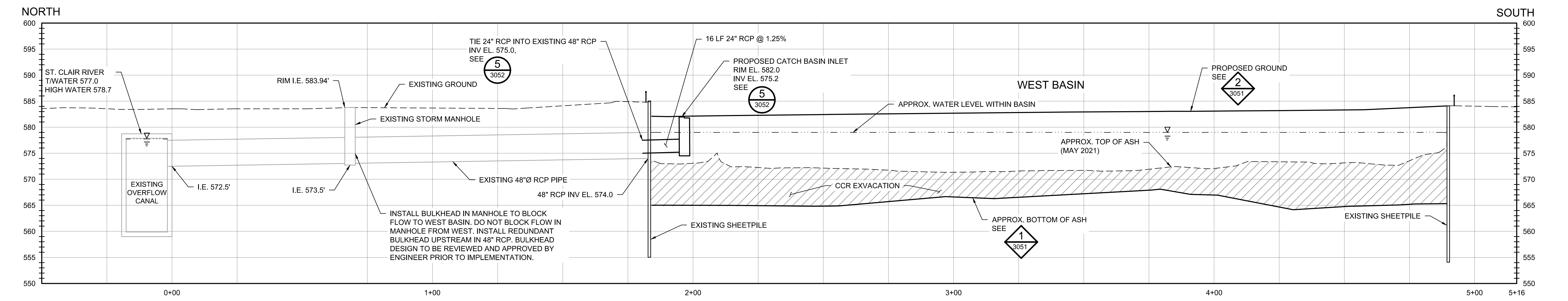

3 SECTION: WEST BASIN
 HORIZONTAL SCALE IN FEET: 0 20 40
 VERTICAL SCALE IN FEET: 0 10 20

- NOTES:**
1. WATER LEVEL AND TOP OF ASH WILL VARY OVER TIME.
 2. APPROX. TOP OF ASH IS BASED ON MAY 2021 BATHYMETRIC SURVEY. ASH SURFACE LOCATION IS VARIABLE OVER TIME AND WILL REQUIRE VERIFICATION BY CONTRACTOR AT TIME OF BAB CLOSURE BIDDING AND CLOSURE EXECUTION.
 3. APPROX. BOTTOM OF ASH WAS BASED ON THE DEPTH TO CLAY MEASUREMENTS FROM VIBRACORE INVESTIGATION IN SEPTEMBER 2021.
 4. GROUNDWATER LEVEL OUTSIDE THE BASIN APPEARS TO BE APPROX. ELEVATION 580', BASED ON 2020 DATA FROM MONITORING WELLS.

0516-C-3049
 LATEST REVISION

6				
5				
4	01FEB22	CONSTRUCTION	S. MASTERS	R. CHRISTENSEN
3	14JAN22	90% DESIGN REVIEW	S. MASTERS	R. CHRISTENSEN
2	20DEC21	60% DESIGN REVIEW	S. MASTERS	R. CHRISTENSEN
1	29OCT21	50% DESIGN REVIEW	S. MASTERS	R. CHRISTENSEN
NO. DATE	ISSUED FOR		PROJ. ENG.	RESP. ENG.
PROJECT ENGINEER: S. MASTERS			APPROVALS	
PRECONSTRUCTION REVISION BLOCK - REV. 0				

Vendor:

BARR ENGINEERING CO.
 3055 BENTLEYVILLE STREET
 SUITE 100
 ANDALUSIA, AL 36826
 PH: 205-336-1100
 FAX: 205-336-1101

DTE

TITLE: **BOTTOM ASH BASIN CLOSURE BASIN CROSS-SECTIONS**

DESIGNED BY: S. HUECKMAN DATE: 21OCT21
 CHECKED BY: J. METTLACH DATE: 26OCT21
 DESIGNED BY: R. CHRISTENSEN DATE: 29OCT21
 CHECKED BY: R. CHRISTENSEN DATE: 01FEB22
 PROJECT ENGINEER: S. MASTERS DATE: 01FEB22
 PROJECT MANAGER: DATE:

LOCATION NAME: ST. CLAIR COUNTY POWER PLANT UNIT NUMBER:
 ORIGINATING SOURCE: BARR ENGINEERING CO. SCALE: AS SHOWN USE DIMENSIONS DO NOT SCALE.
 DTE ELECTRIC COMPANY DRAWING NUMBER: 0516-C-3049

THIS IS AN CAD PRODUCED DRAWING. ANY CHANGES OR REVISIONS TO THIS DRAWING MUST BE COMPLETED USING THE CAD SYSTEM.

C PROLOGS				B PROLOGS				A PROLOGS				DTE ELECTRIC APPROVALS		OTHER APPROVALS		DESIGNED BY	DATE
PROLOGS	DESIGN	REV	DATE	PROLOGS	DESIGN	REV	DATE	PROLOGS	DESIGN	REV	DATE	FOR GEN TECH DRG	DATE	FOR GEN PLANT ENG	DATE	S. HUECKMAN	21OCT21
												Nicholas Reindorbs	2/2/22			J. METTLACH	26OCT21
																R. CHRISTENSEN	29OCT21
																R. CHRISTENSEN	01FEB22
																Steve Masters	2/3/22

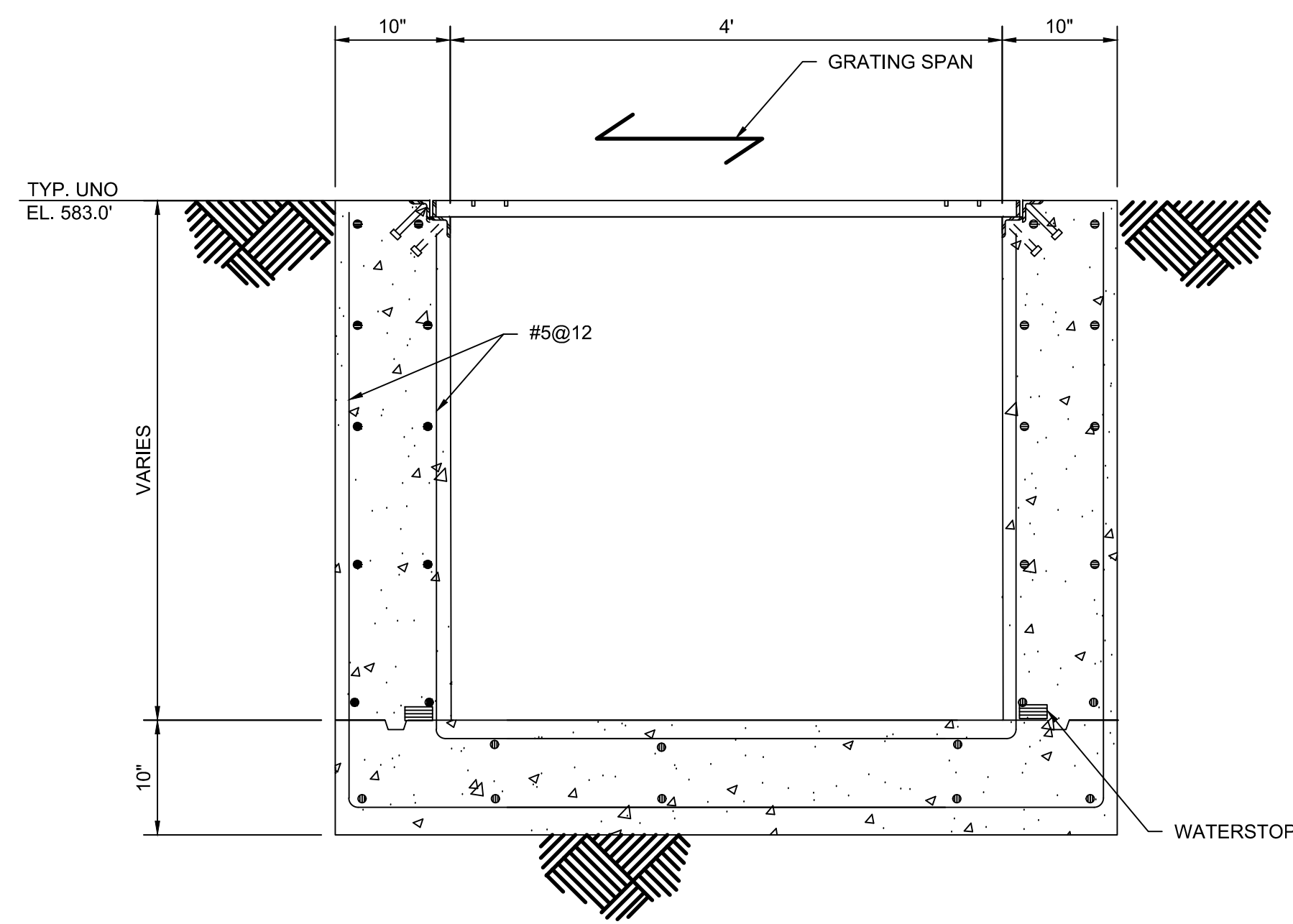

NOTE:
REINFORCING TO BE #4@12" TYP. UNO

1 SECTION: EXISTING CONCRETE CANAL
3046 NOT TO SCALE

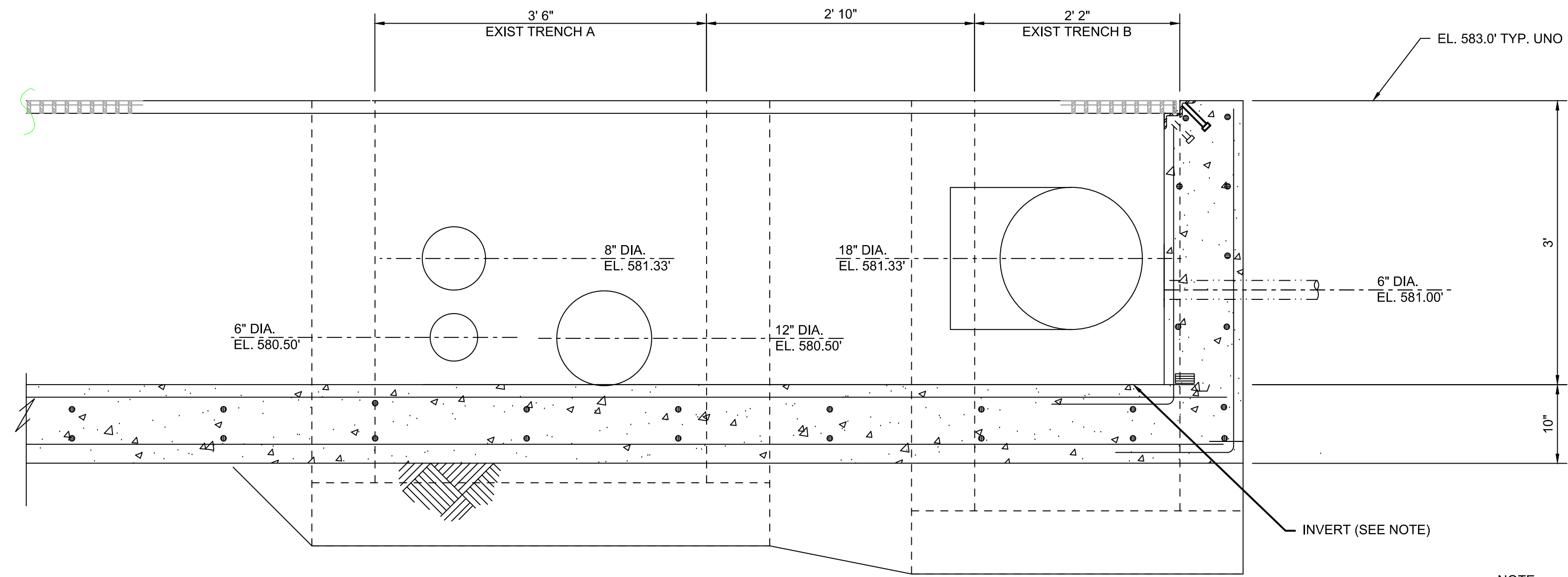

NOTE:
CONCRETE CANAL INVERTS SHOWN ON 0516-C-3049 BASED OFF JULY 2016 TOPG SURVEY BY MCNEELY & LINCOLN ASSOCIATES, INC. (FIELD VERIFY)

2 SECTION: EXISTING TRENCHES A AND B
3046 NOT TO SCALE

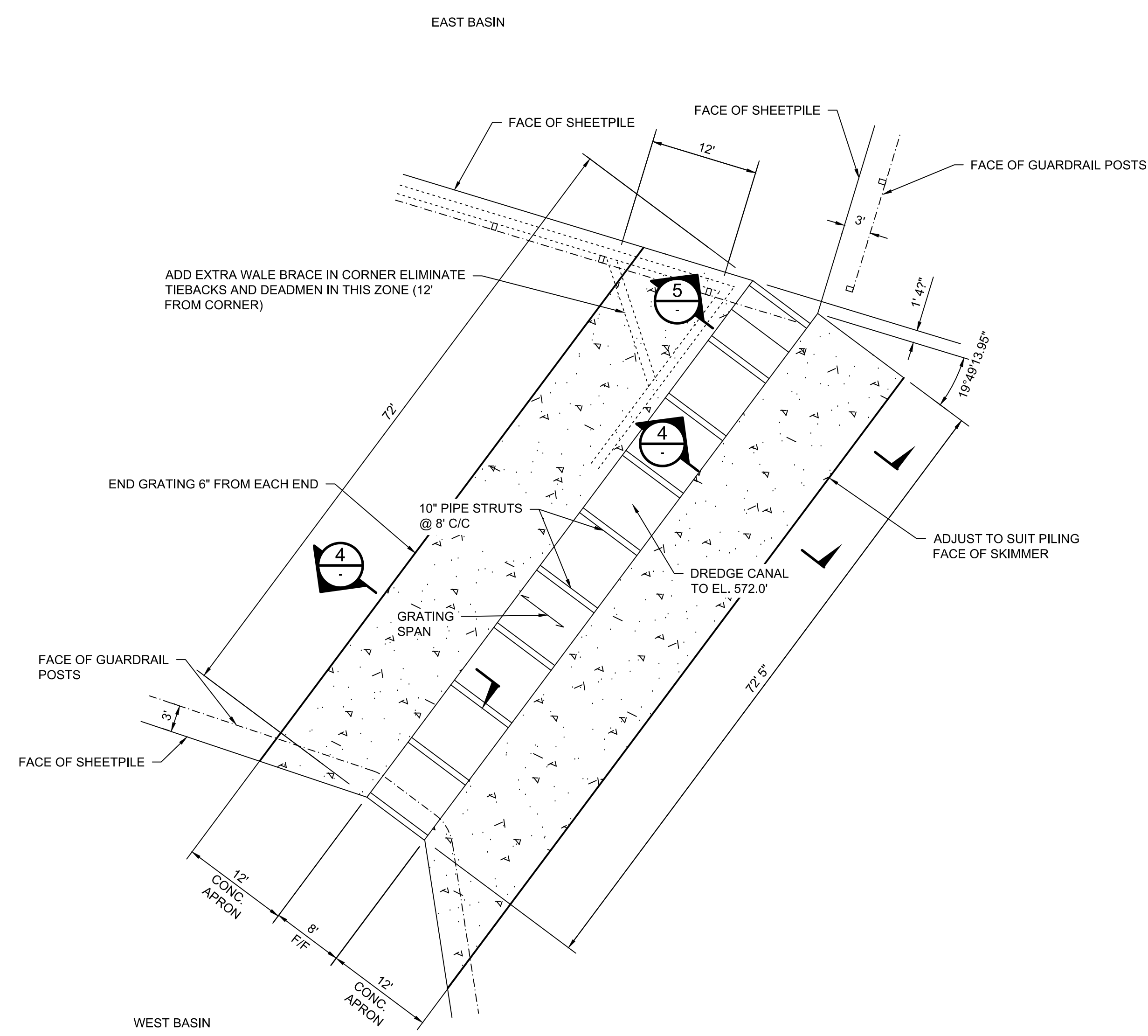

3 PLAN: EXISTING CONNECTING CHANNEL
3046 NOT TO SCALE

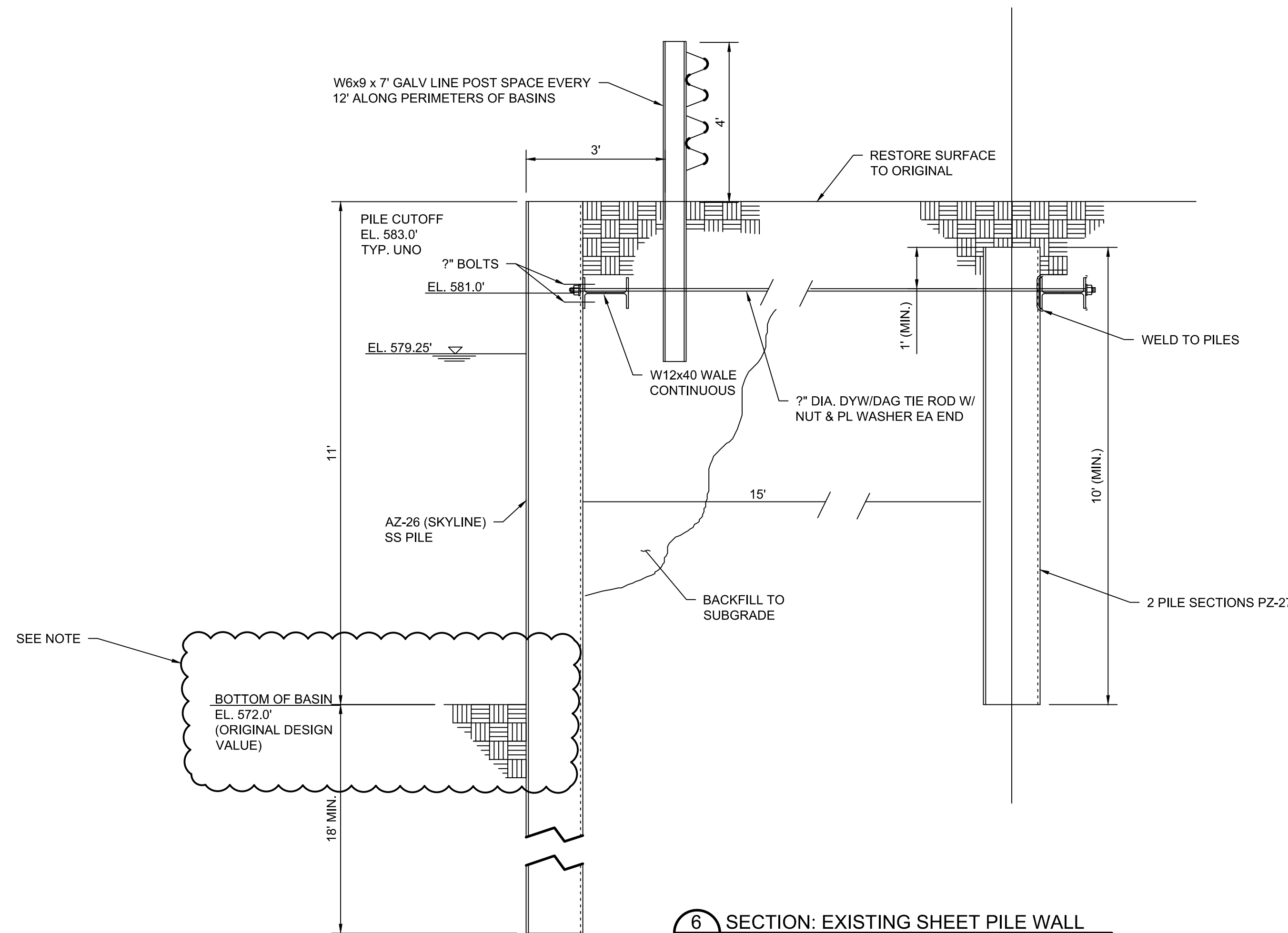

NOTE:
2021 VIBRACORE BORINGS SHOW BOTTOM OF BASINS TO BE APPROX. AVERAGE EL. 564.

4 SECTION: EXISTING SHEET PILE WALL
3046 NOT TO SCALE

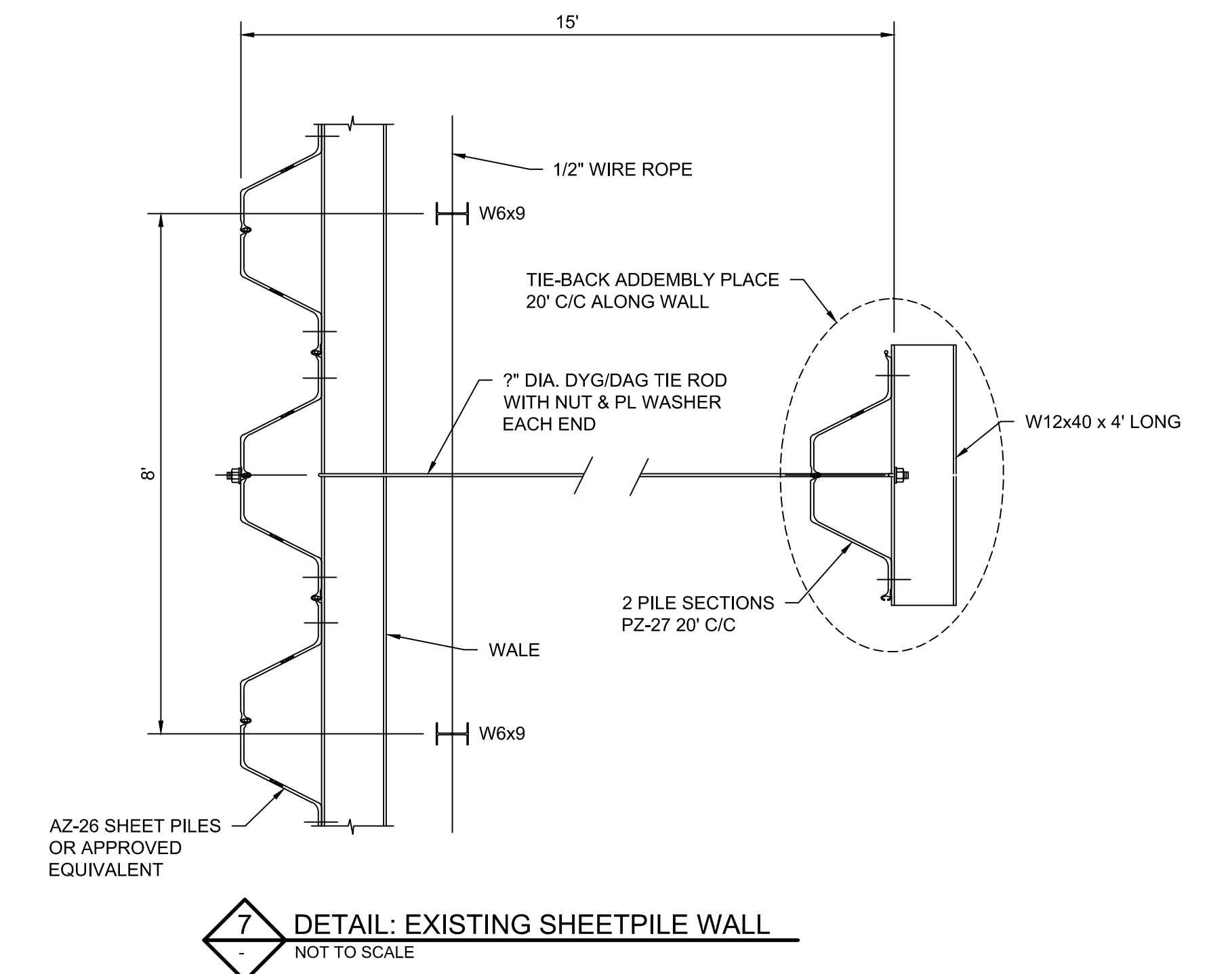

5 DETAIL: EXISTING SHEETPILE WALL
NOT TO SCALE

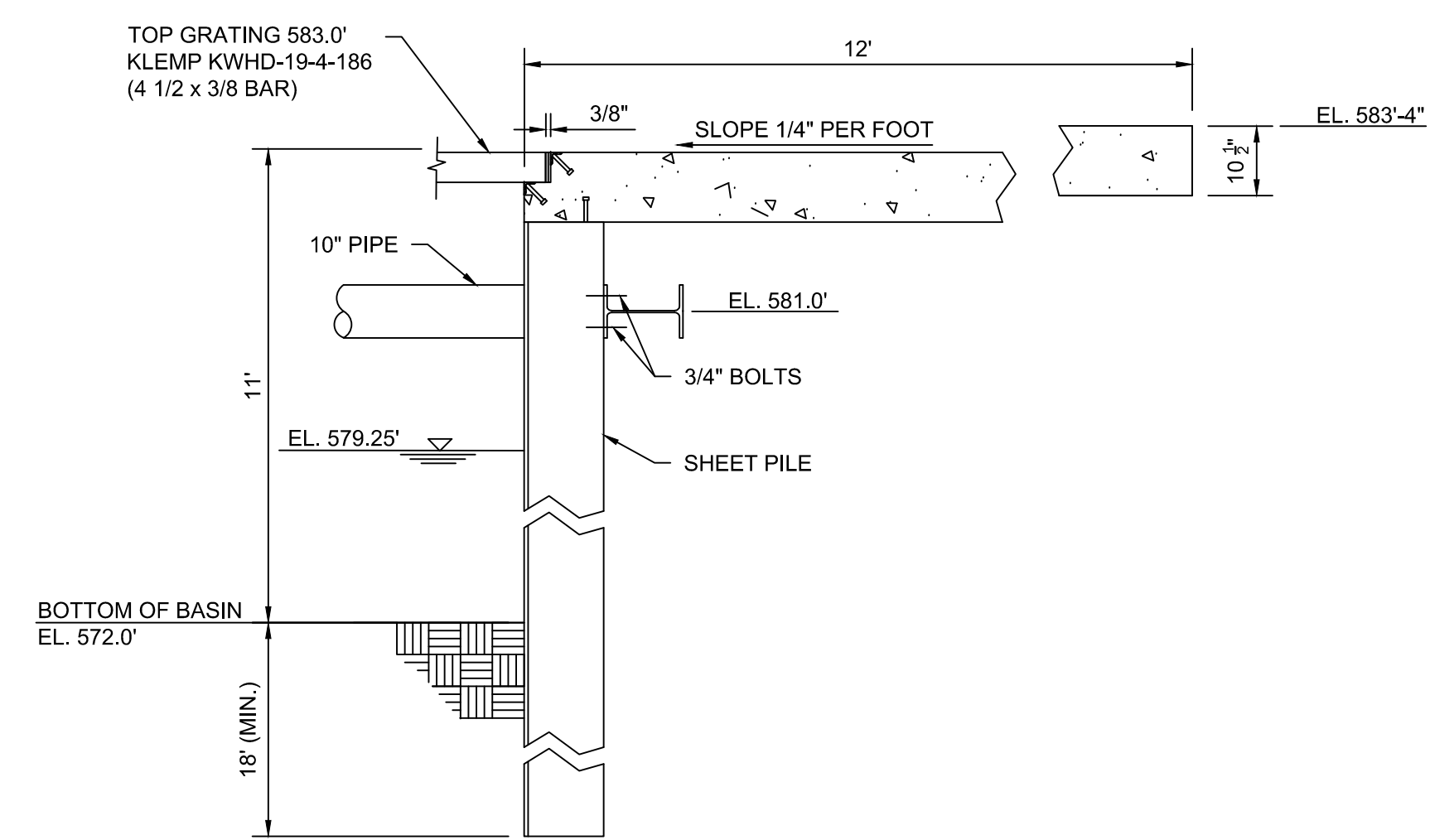

6 SECTION: A-A
NOT TO SCALE

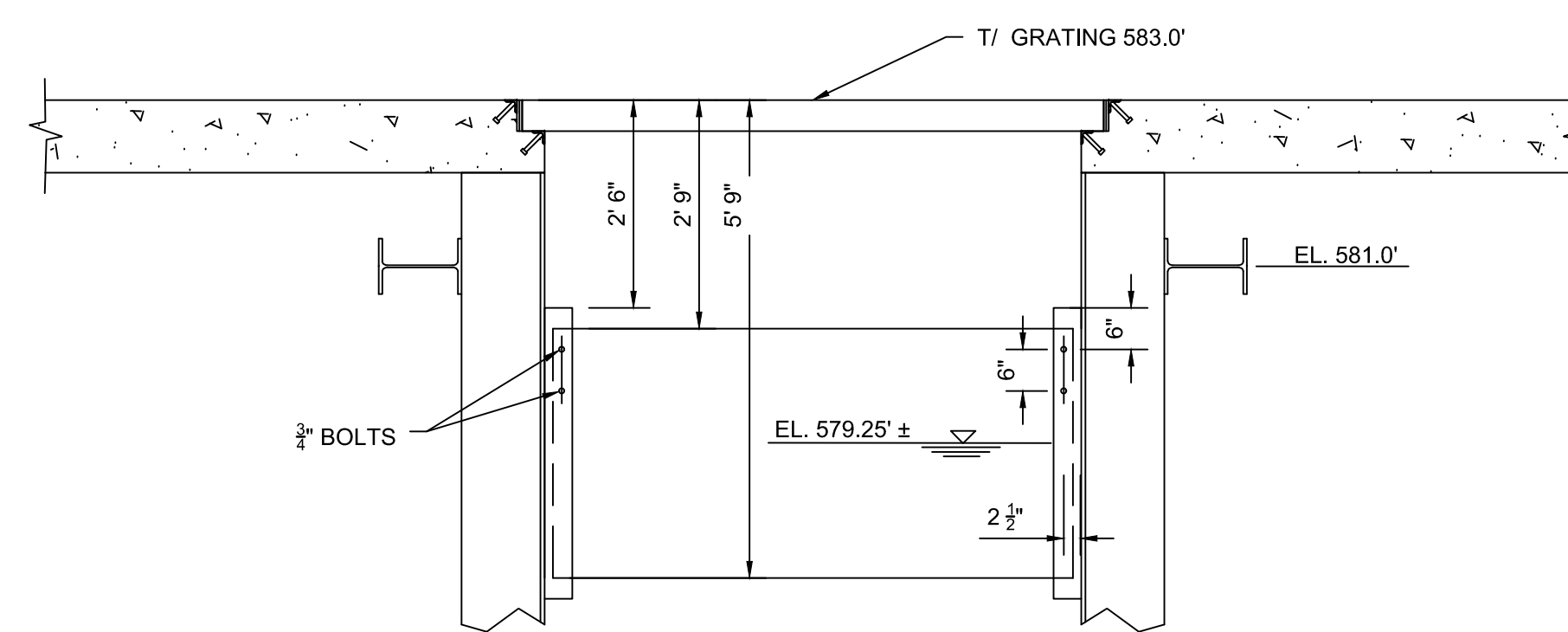

7 SECTION: B-B
NOT TO SCALE

NOTES:

1. THE INFORMATION PROVIDED ON THIS SHEET IS FOR INFORMATIONAL PURPOSES ONLY. THIS INFORMATION, TO THE BEST OF OUR KNOWLEDGE, REPRESENTS AS-BUILT CONDITIONS.
2. THESE SECTIONS ARE REDRAWN FROM PREVIOUS RECORD DRAWINGS. DRAWINGS REFERENCED ARE 6C516W-134 AND 6C516W-135.

0516-C-3050
LATEST REVISION

6				
5				
4	01FEB22	CONSTRUCTION	S. MASTERS	R. CHRISTENSEN
3	14JAN22	90% DESIGN REVIEW	S. MASTERS	R. CHRISTENSEN
2	20DEC21	60% DESIGN REVIEW	S. MASTERS	R. CHRISTENSEN
1	29OCT21	50% DESIGN REVIEW	S. MASTERS	R. CHRISTENSEN
NO.	DATE	ISSUED FOR	PROJ. ENG.	RESP. ENG.
PROJECT ENGINEER: S. MASTERS			APPROVALS	
PRECONSTRUCTION REVISION BLOCK - REV. B				

Vendor:
BARR ENGINEERING CO.
3005 EDWARDSVILLE STREET
SAVING HARBOR, IL 61880
PH: 815.291.0001

DTE
TITLE

BOTTOM ASH BASIN CLOSURE
EXISTING CONDITIONS STRUCTURAL DETAILS

LOCATION NAME: ST. CLAIR COUNTY POWER PLANT
UNIT NUMBER

ORIGINATING SOURCE: BARR ENGINEERING CO.
SCALE: AS SHOWN
USE DIMENSIONS DO NOT SCALE

DESIGN FILE NAME: 0516-C-3050.dwg
DATE: 01FEB22 OPERATOR: JAM6

C PROBLEMS				B PROBLEMS				A PROBLEMS				DATE		DATE		DATE																																	
PROG.	ISS	REV	CHK	PROG.	ISS	REV	CHK	PROG.	ISS	REV	CHK	DATE	DATE	DATE	DATE	DATE																																	
<table border="0"> <tr> <td>DESIGNED BY</td> <td>S. HUECKMAN</td> <td>DATE</td> <td>21OCT21</td> </tr> <tr> <td>FOR GEN TECH DRG</td> <td>Nickolas Reinhardt</td> <td>DATE</td> <td>2/2/22</td> </tr> <tr> <td>FOR GEN PLANT ENG</td> <td>J. METTLACH</td> <td>DATE</td> <td>26OCT21</td> </tr> <tr> <td>FOR GEN ENG</td> <td>R. CHRISTENSEN</td> <td>DATE</td> <td>29OCT21</td> </tr> <tr> <td>APPROVED BY</td> <td>R. CHRISTENSEN</td> <td>DATE</td> <td>01FEB22</td> </tr> <tr> <td>PROJECT ENGINEER</td> <td>S. MASTERS</td> <td>DATE</td> <td></td> </tr> <tr> <td>PROJECT MANAGER</td> <td></td> <td>DATE</td> <td></td> </tr> </table>												DESIGNED BY	S. HUECKMAN	DATE	21OCT21	FOR GEN TECH DRG	Nickolas Reinhardt	DATE	2/2/22	FOR GEN PLANT ENG	J. METTLACH	DATE	26OCT21	FOR GEN ENG	R. CHRISTENSEN	DATE	29OCT21	APPROVED BY	R. CHRISTENSEN	DATE	01FEB22	PROJECT ENGINEER	S. MASTERS	DATE		PROJECT MANAGER		DATE		<table border="0"> <tr> <td>OTHER APPROVALS</td> <td></td> </tr> <tr> <td>MECH</td> <td></td> </tr> <tr> <td>ELECT</td> <td></td> </tr> <tr> <td>PLANT</td> <td></td> </tr> </table>		OTHER APPROVALS		MECH		ELECT		PLANT	
DESIGNED BY	S. HUECKMAN	DATE	21OCT21																																														
FOR GEN TECH DRG	Nickolas Reinhardt	DATE	2/2/22																																														
FOR GEN PLANT ENG	J. METTLACH	DATE	26OCT21																																														
FOR GEN ENG	R. CHRISTENSEN	DATE	29OCT21																																														
APPROVED BY	R. CHRISTENSEN	DATE	01FEB22																																														
PROJECT ENGINEER	S. MASTERS	DATE																																															
PROJECT MANAGER		DATE																																															
OTHER APPROVALS																																																	
MECH																																																	
ELECT																																																	
PLANT																																																	
<table border="0"> <tr> <td>MADE BY</td> <td>DATE</td> <td>INC</td> <td>ELECT.</td> </tr> <tr> <td>CHK BY</td> <td>DATE</td> <td>MECH.</td> <td>APPROVED BY</td> </tr> </table>				MADE BY	DATE	INC	ELECT.	CHK BY	DATE	MECH.	APPROVED BY	<table border="0"> <tr> <td>MADE BY</td> <td>DATE</td> <td>INC</td> <td>ELECT.</td> </tr> <tr> <td>CHK BY</td> <td>DATE</td> <td>MECH.</td> <td>APPROVED BY</td> </tr> </table>				MADE BY	DATE	INC	ELECT.	CHK BY	DATE	MECH.	APPROVED BY	<table border="0"> <tr> <td>MADE BY</td> <td>DATE</td> <td>INC</td> <td>ELECT.</td> </tr> <tr> <td>CHK BY</td> <td>DATE</td> <td>MECH.</td> <td>APPROVED BY</td> </tr> </table>				MADE BY	DATE	INC	ELECT.	CHK BY	DATE	MECH.	APPROVED BY	<table border="0"> <tr> <td>DATE</td> <td>DATE</td> </tr> <tr> <td>2/2/22</td> <td></td> </tr> </table>		DATE	DATE	2/2/22									
MADE BY	DATE	INC	ELECT.																																														
CHK BY	DATE	MECH.	APPROVED BY																																														
MADE BY	DATE	INC	ELECT.																																														
CHK BY	DATE	MECH.	APPROVED BY																																														
MADE BY	DATE	INC	ELECT.																																														
CHK BY	DATE	MECH.	APPROVED BY																																														
DATE	DATE																																																
2/2/22																																																	

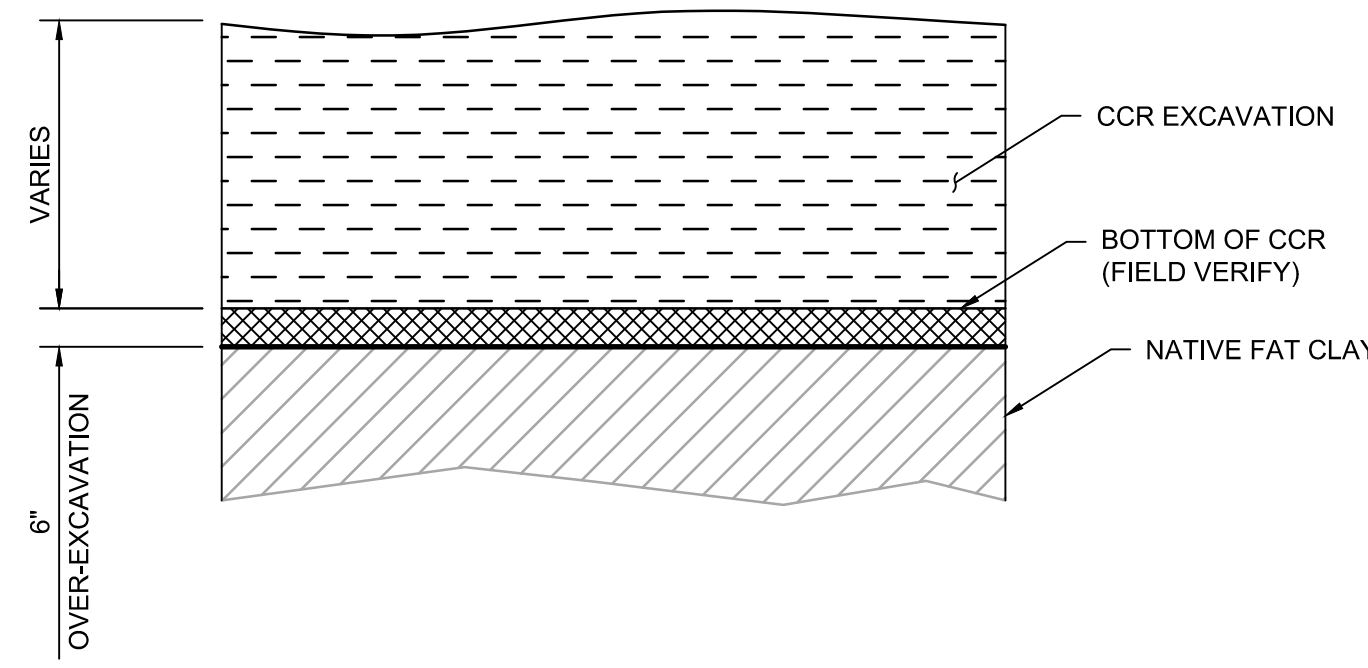

1 DETAIL: BASIN EXCAVATION (TYP.)
3047,3049 NOT TO SCALE

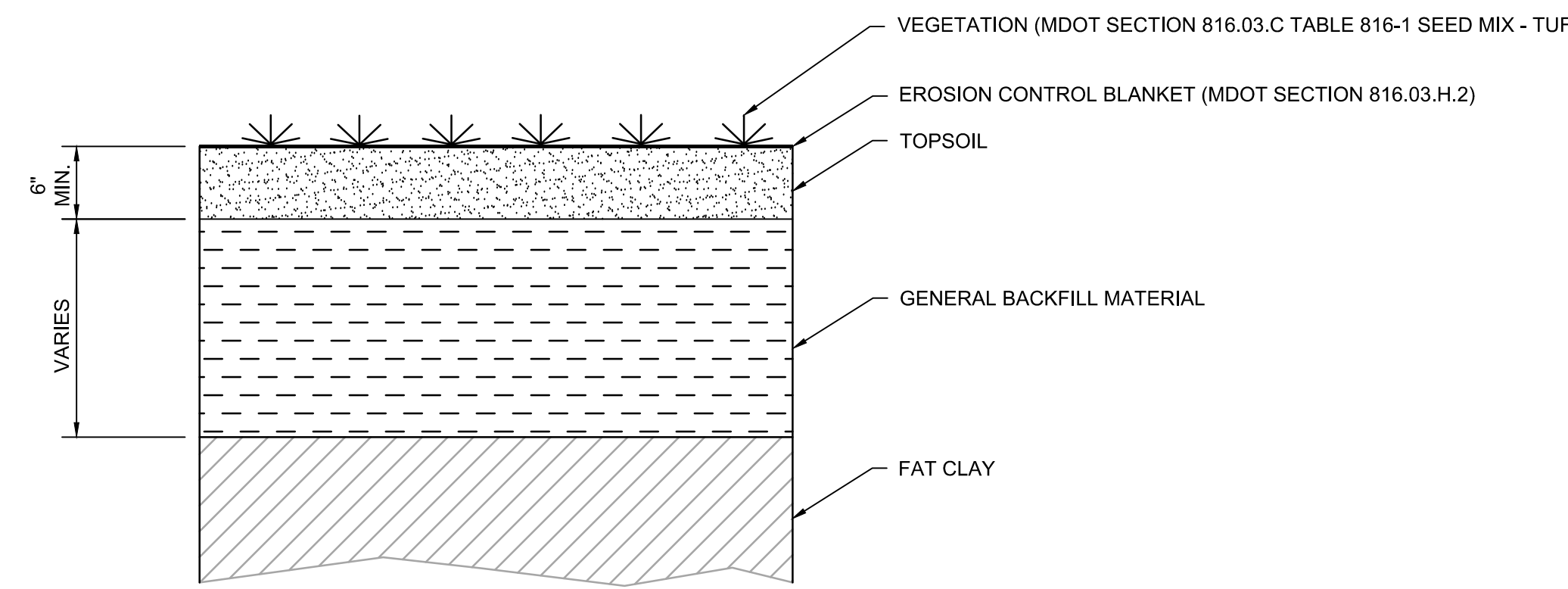

2 DETAIL: BASIN BACKFILL (TYP.)
3048,3049 NOT TO SCALE

NOTES:
1. ESTABLISH TURF IN ACCORDANCE WITH MDOT SECTION 816 TURF ESTABLISHMENT.

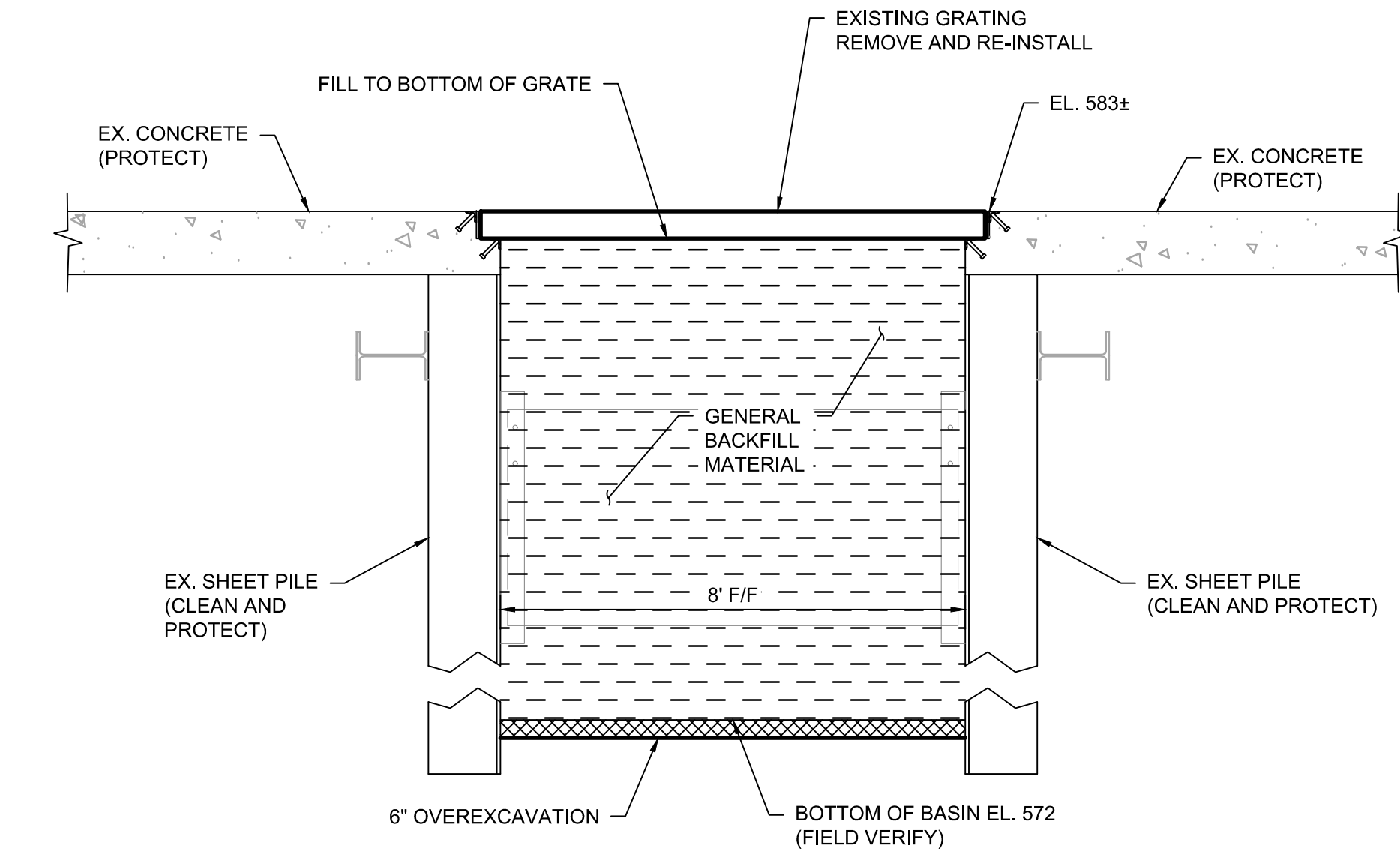

3 DETAIL: EXISTING CONNECTING CHANNEL BACKFILL (TYP.)
3048 NOT TO SCALE

NOTES:
1. REMOVE AND REPLACE STRUTS AS NECESSARY TO PERFORM THE EXCAVATION AND BACKFILL WORK.

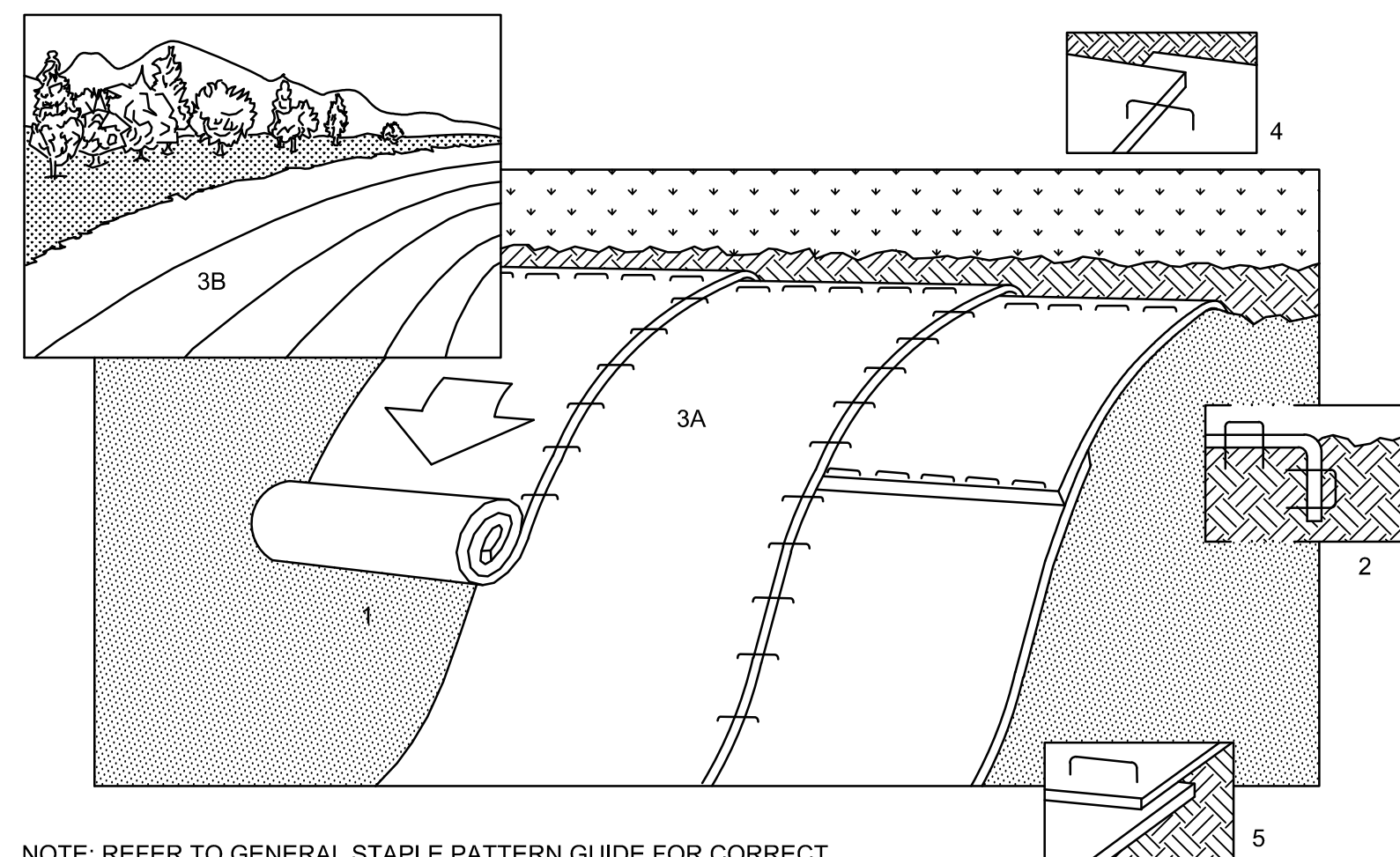

NOTE: REFER TO GENERAL STAPLE PATTERN GUIDE FOR CORRECT STAPLE PATTERN RECOMMENDATIONS FOR SLOPE INSTALLATIONS.

4 DETAIL: EROSION CONTROL MULCH BLANKET
NOT TO SCALE

EROSION CONTROL MULCH BLANKET NOTES:

1. INSTALL EROSION CONTROL BLANKET ON ALL TOPSOILED AREAS.
2. PREPARE SOIL BEFORE INSTALLING BLANKETS, INCLUDING APPLICATION OF SEED.
3. BEGIN AT THE TOP OF THE SLOPE BY ANCHORING THE BLANKET IN 8" DEEP X 6" WIDE TRENCH. BACKFILL AND COMPACT THE TRENCH AFTER STAPLING.
4. ROLL THE BLANKETS (A.) DOWN OR (B.) HORIZONTALLY ACROSS THE SLOPE.
5. THE EDGES OF PARALLEL BLANKETS MUST BE STAPLED WITH APPROXIMATELY 2' OVERLAP.
6. WHEN BLANKETS MUST BE SPLICED DOWN THE SLOPE, PLACE BLANKETS END OVER END (SHINGLE STYLE) WITH APPROXIMATELY 4" OVERLAP. STAPLE THROUGH OVERLAPPED AREA APPROXIMATELY 12" APART.

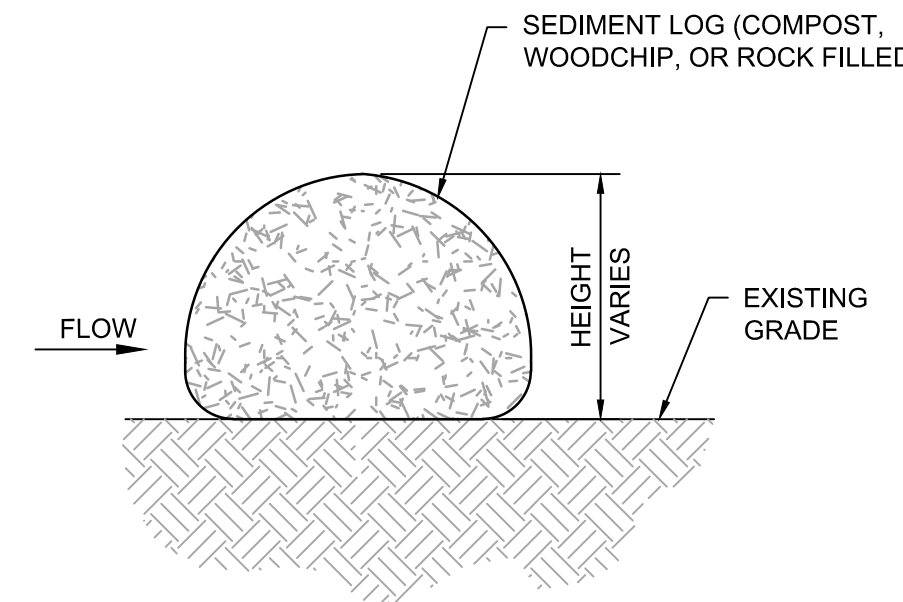

NOTES:

1. STAKE FREE SEDIMENT LOG TO BE USED IN AREAS THAT ARE RELATIVELY FLAT AND SHOULD BE INSTALLED ALONG CONTOURS (CONSTANT ELEVATION).
2. NO GAPS SHALL BE PRESENT UNDER SEDIMENT LOG. PREPARE AREA AS NEEDED TO SMOOTH SURFACE OR REMOVE DEBRIS.
3. ACCUMULATED SEDIMENT SHALL BE REMOVED WHEN REACHING 1/2 OF LOG HEIGHT.
4. SEDIMENT LOG SHALL BE MAINTAINED THROUGHOUT THE CONSTRUCTION PERIOD AND REPAIRED OR REPLACED AS REQUIRED.

5 DETAIL: SEDIMENT LOG - STAKE FREE
NOT TO SCALE

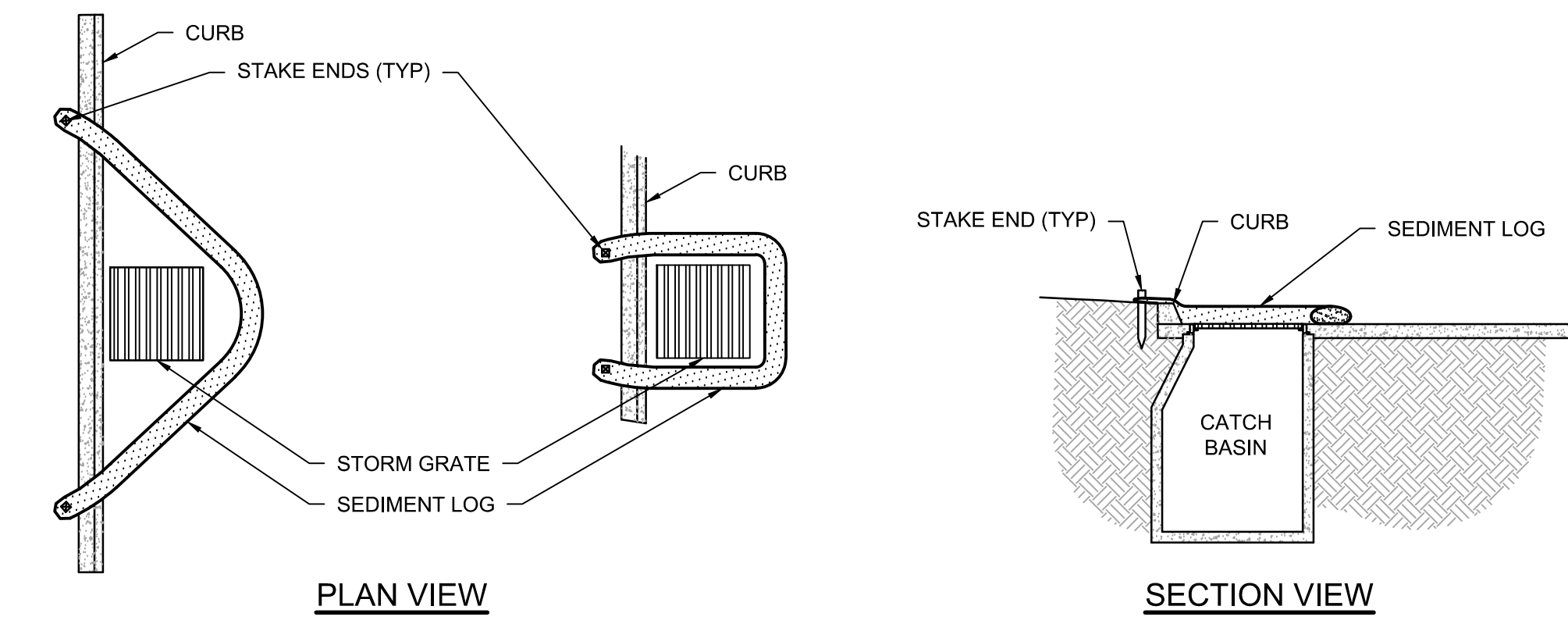

PLAN VIEW

SECTION VIEW

NOTES:

1. INLET PROTECTION SHALL BE INSTALLED PRIOR TO ANY GRADING WORK IN THE AREA TO BE PROTECTED OR IMMEDIATELY FOLLOWING CATCHBASIN INSTALLATION, AND SHALL BE MAINTAINED THROUGHOUT THE CONSTRUCTION PERIOD.
2. MATERIALS SHALL BE SUFFICIENT TO ALLOW FLOW WHILE BLOCKING SEDIMENT. NO HOLES OR GAPS SHALL BE PRESENT IN UNDER SEDIMENT LOG.
3. INLET PROTECTION SHALL BE CLEANED AS REQUIRED.
4. MATERIALS AND ANY ACCUMULATED SEDIMENT SHALL BE REMOVED IN CONJUNCTION WITH THE FINAL GRADING AND SITE STABILIZATION.

6 DETAIL: INLET PROTECTION - SEDIMENT LOG
NOT TO SCALE

0516-C-3051
LATEST REVISION

6				
5				
4	01FEB22	CONSTRUCTION	S. MASTERS	R. CHRISTENSEN
3	14JAN22	90% DESIGN REVIEW	S. MASTERS	R. CHRISTENSEN
2	20DEC21	60% DESIGN REVIEW	S. MASTERS	R. CHRISTENSEN
1	29OCT21	50% DESIGN REVIEW	S. MASTERS	R. CHRISTENSEN
NO.	DATE	ISSUED FOR	PROJ. ENG.	RESP. ENG.
PROJECT ENGINEER: S. MASTERS			APPROVALS	
PRECONSTRUCTION REVISION BLOCK - REV. 0				

Vendor:
BARR ENGINEERING CO.
3005 REDWOOD BLVD SUITE 100
ANN ARBOR MI 48106
PH: 734-769-0511
WWW.BARR-ENG.COM

DTE
TITLE

BOTTOM ASH BASIN CLOSURE
GENERAL DETAILS

LOCATION NAME: ST. CLAIR COUNTY POWER PLANT UNIT NUMBER:
ORIGINATING SOURCE: BARR ENGINEERING CO. SCALE: AS SHOWN USE DIMENSIONS DO NOT SCALE.
DTE ELECTRIC COMPANY DRAWING NUMBER: 0516-C-3051
DATE: 01FEB22 OPERATOR: JAM6

C PROLOGS. FOS GEN TECH ENG CIVL				B PROLOGS. FOS GEN TECH ENG CIVL				A PROLOGS. FOS GEN TECH ENG CIVL				DTE ELECTRIC APPROVALS		OTHER APPROVALS		DESIGNED BY DATE	
MADE BY	DATE	INC	ELECT.	MADE BY	DATE	INC	ELECT.	MADE BY	DATE	INC	ELECT.	FOR GEN TECH ENG	DATE	VERIFIER	DATE	DESIGNED BY	DATE
CHK BY	DATE	MECH.	APPROVED BY	CHK BY	DATE	MECH.	APPROVED BY	CHK BY	DATE	MECH.	APPROVED BY	Steve Masters	2/22	Nicholas Reidenbach	2/22	S. HUECKEMAN	21OCT21
																J. METTLACH	26OCT21
																R. CHRISTENSEN	29OCT21
																R. CHRISTENSEN	01FEB22
																PROJECT ENGINEER	DATE
																PROJECT MANAGER	DATE

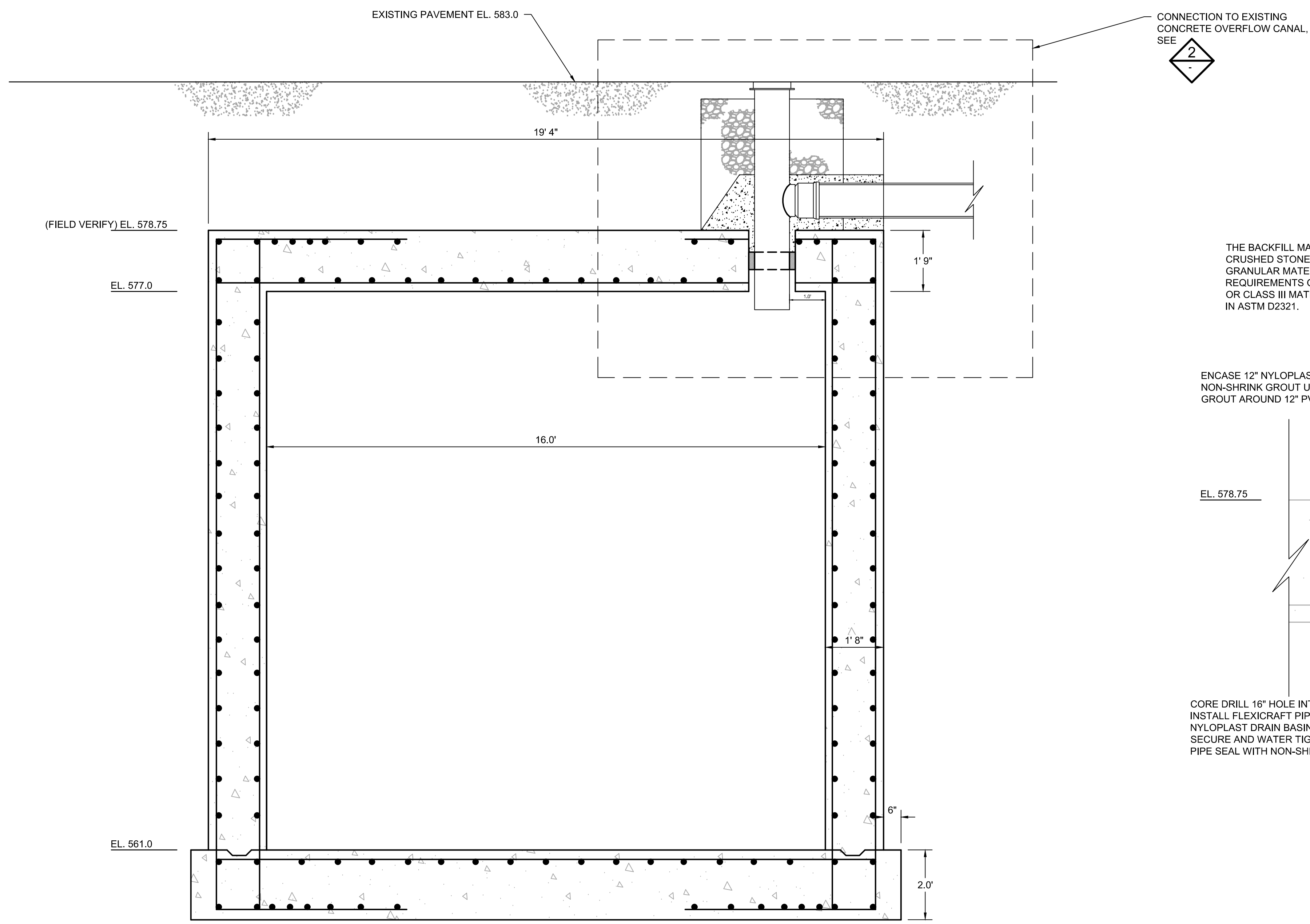

1 SECTION: EXISTING CONCRETE OVERFLOW CANAL
SCALE IN FEET

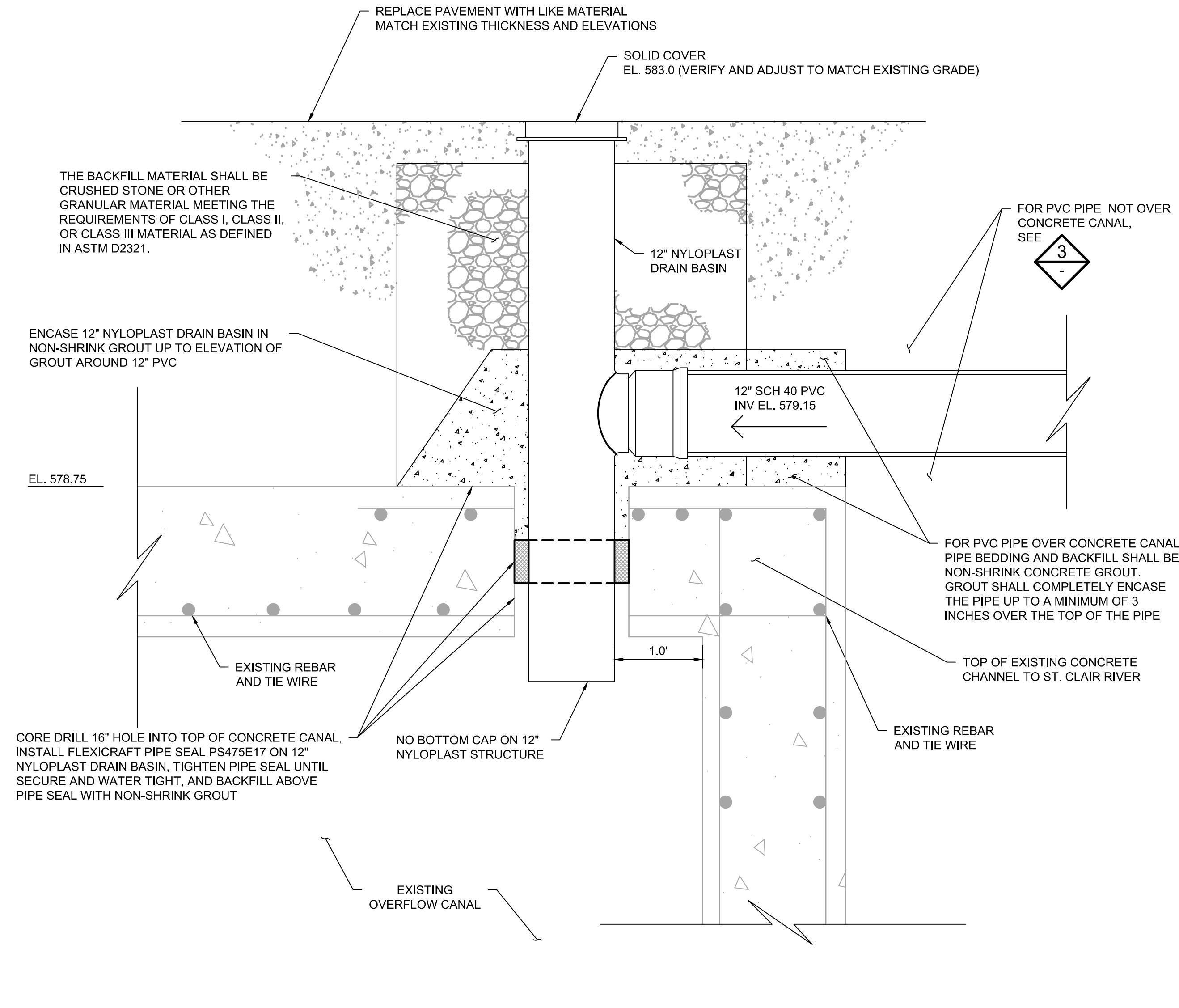

2 DETAIL: NYLOPLAST CONNECTION TO EXISTING CONCRETE OVERFLOW CANAL
SCALE IN FEET

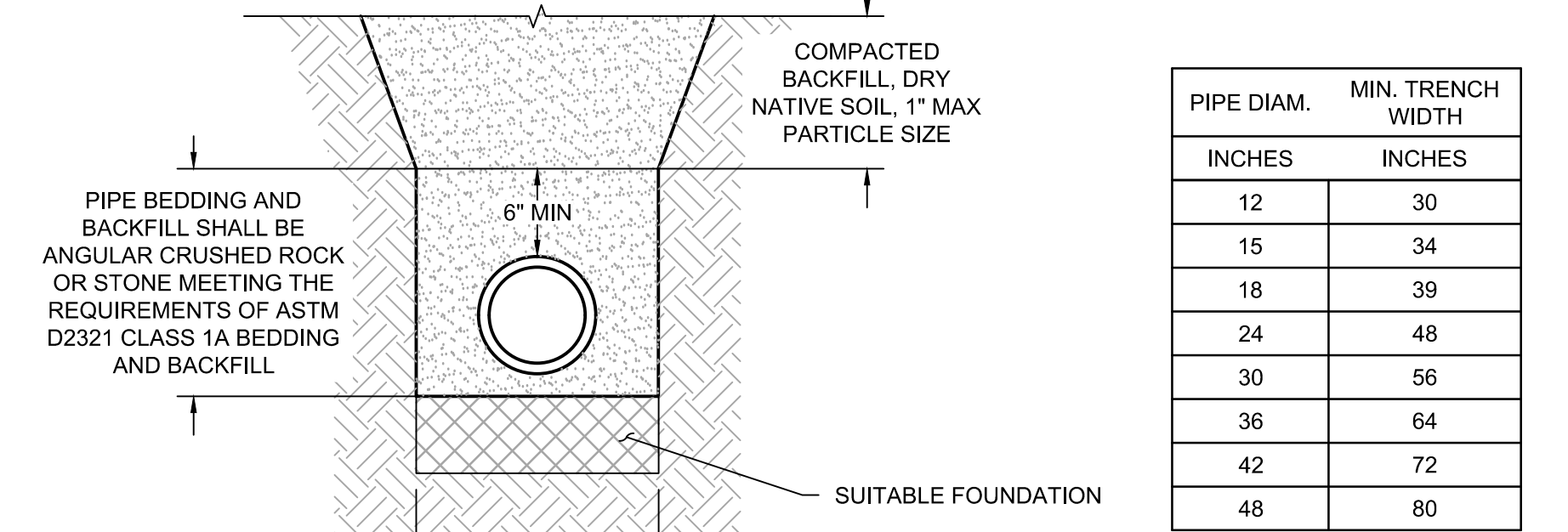

- NOTES:
- ALL PIPE SYSTEMS SHALL BE INSTALLED IN ACCORDANCE WITH ASTM D2321, "STANDARD PRACTICE FOR UNDERGROUND INSTALLATION OF THERMOPLASTIC PIPE FOR SEWERS AND OTHER GRAVITY FLOW APPLICATIONS", LATEST ADDITION.
 - MEASURES SHOULD BE TAKEN TO PREVENT MIGRATION OF NATIVE FINES INTO BACKFILL MATERIAL, WHEN REQUIRED.
 - FOUNDATION: WHERE THE TRENCH BOTTOM IS UNSTABLE, THE CONTRACTOR SHALL EXCAVATE TO A DEPTH REQUIRED BY THE ENGINEER AND REPLACE WITH SUITABLE MATERIAL AS SPECIFIED BY THE ENGINEER, AS AN ALTERNATIVE AND AT THE DISCRETION OF THE DESIGN ENGINEER, THE TRENCH BOTTOM MAY BE STABILIZED USING A GEOTEXTILE MATERIAL.
 - MAINTAIN A DRY TRENCH WHEN BACKFILLING THE PIPE. MECHANICALLY COMPACT IN ACCORDANCE WITH DTE SPECIFICATION 317.

3 DETAIL: PVC PIPE TRENCH
NOT TO SCALE

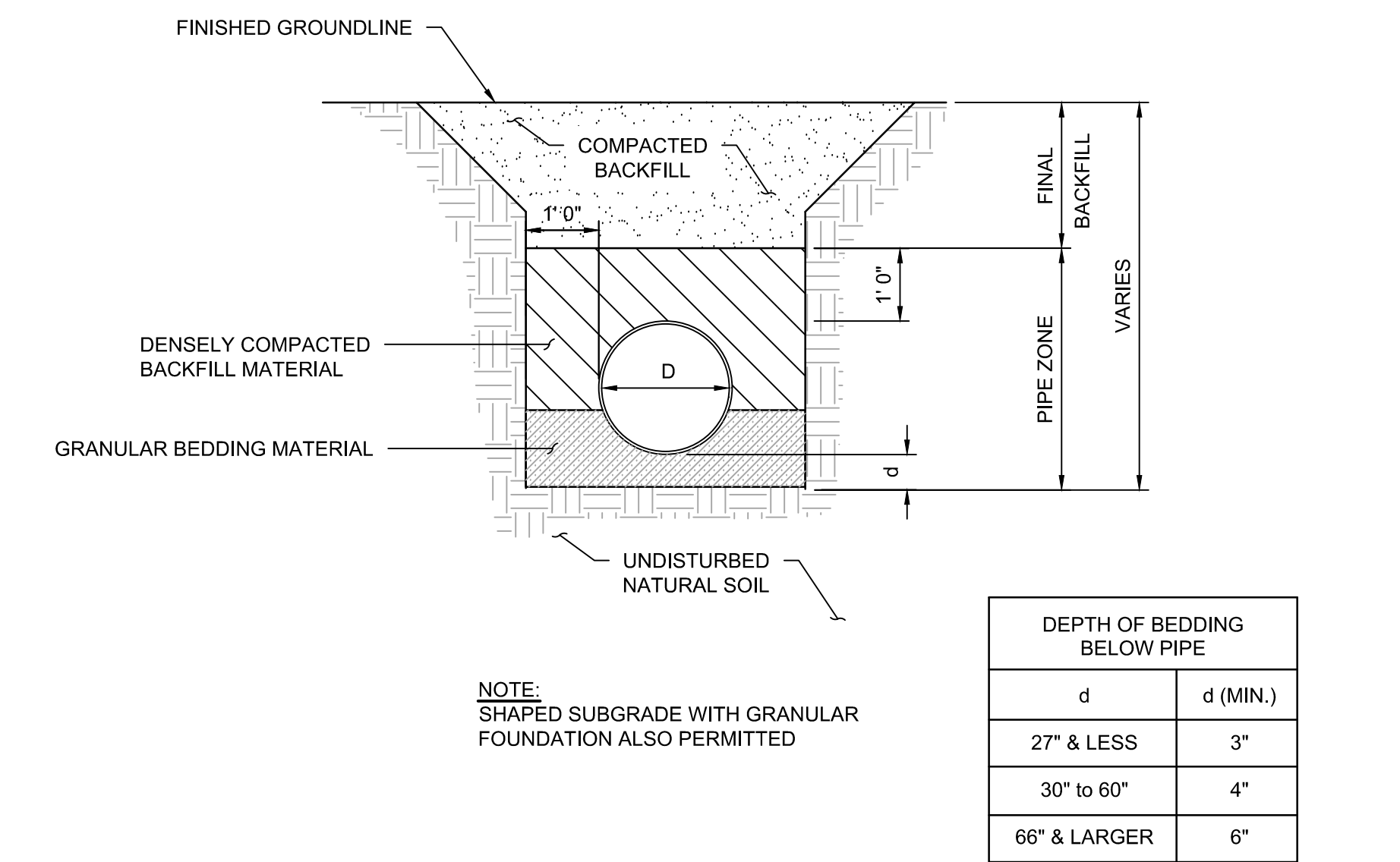

4 DETAIL: RCP STORM SEWER TRENCH
NOT TO SCALE

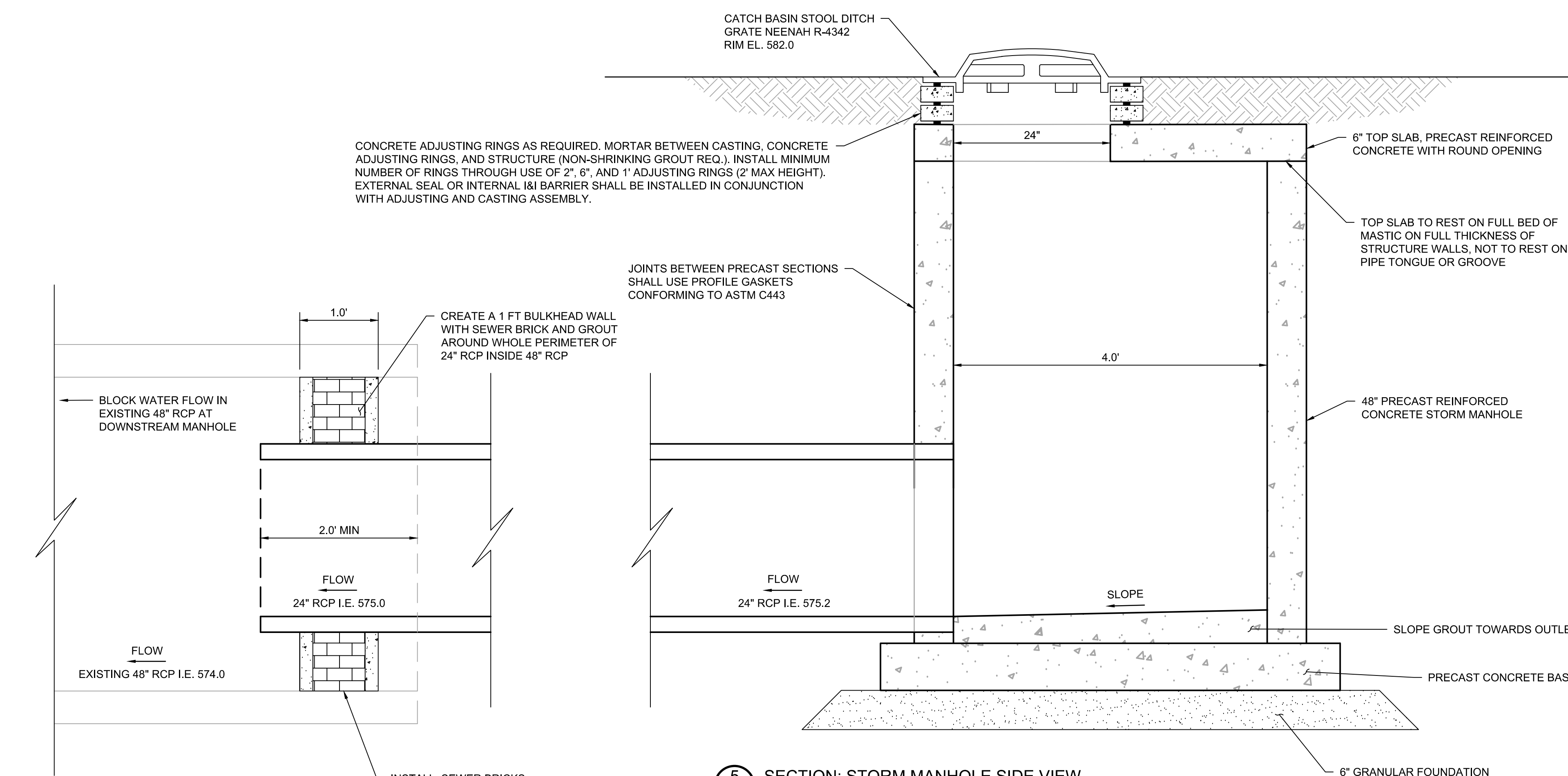

5 SECTION: STORM MANHOLE SIDE VIEW
SCALE IN FEET

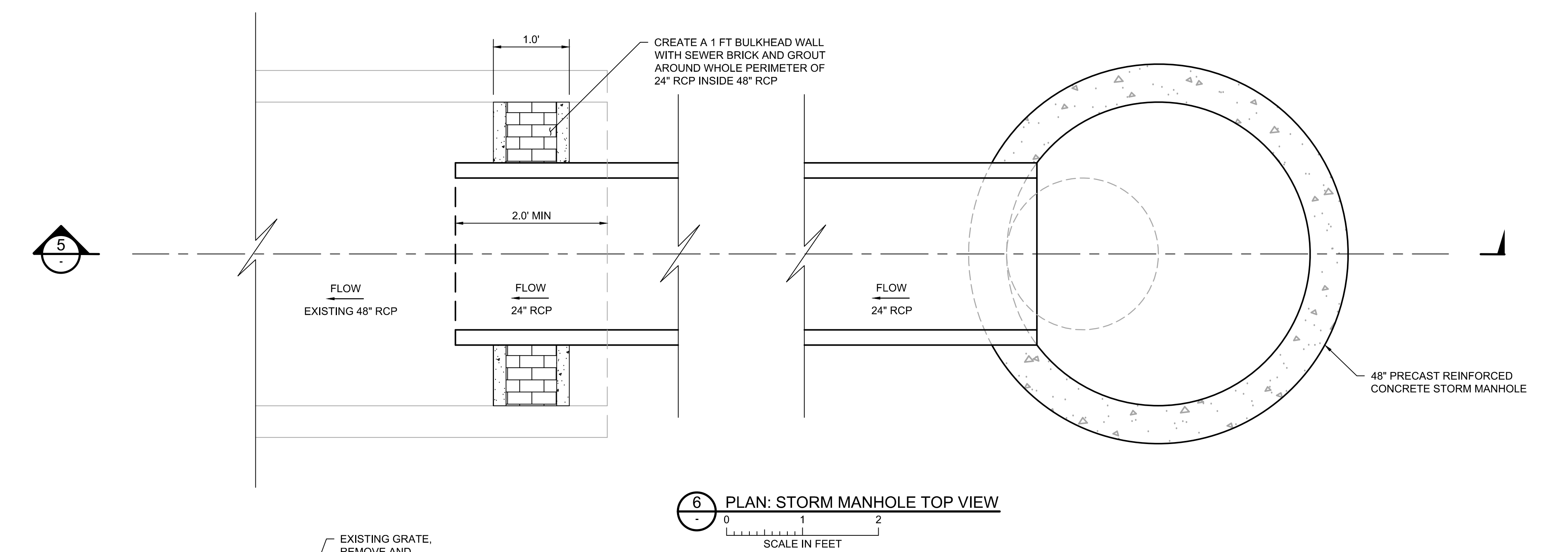

6 PLAN: STORM MANHOLE TOP VIEW
SCALE IN FEET

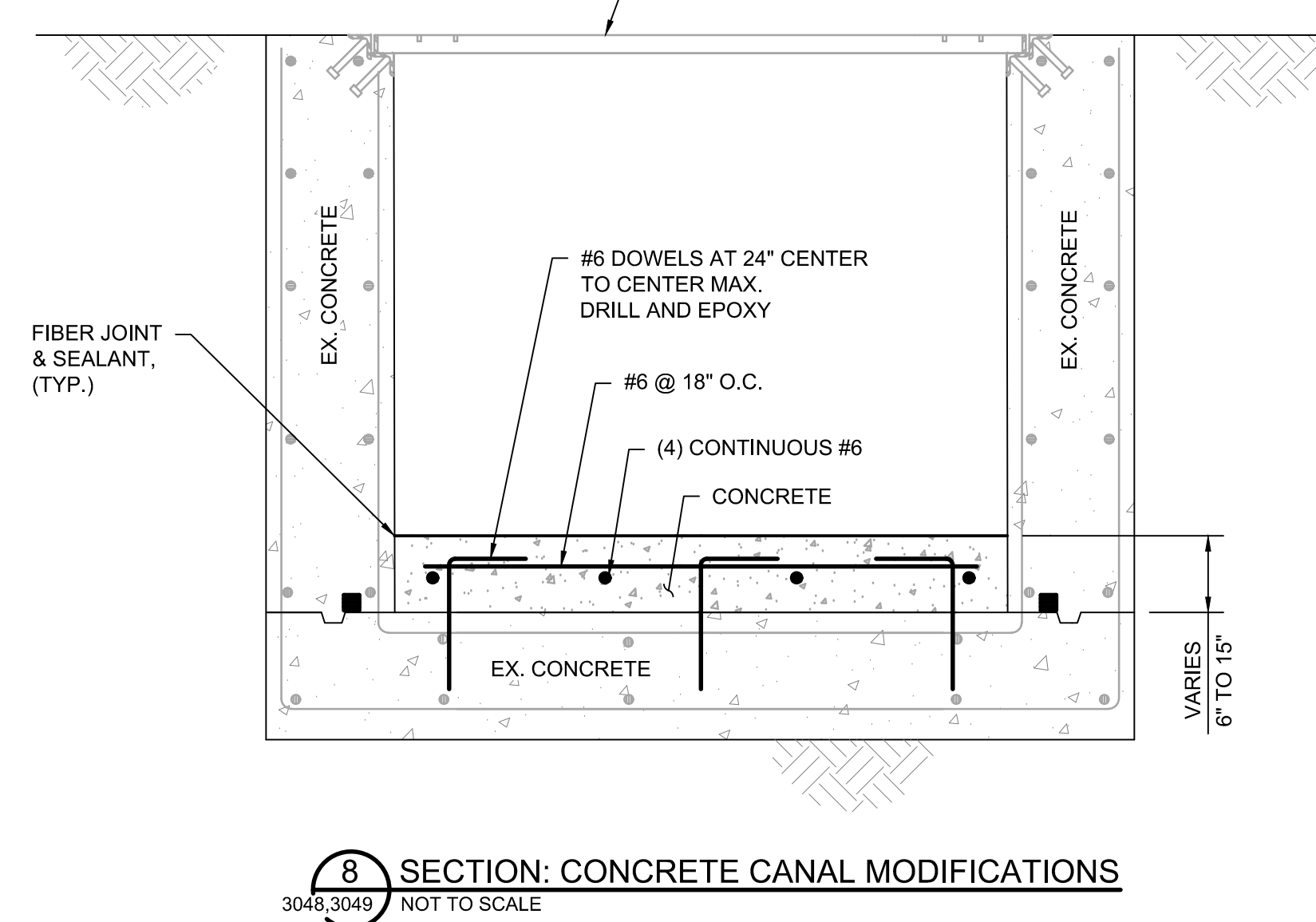

8 SECTION: CONCRETE CANAL MODIFICATIONS
NOT TO SCALE

- NOTES:
- FIELD VERIFY VERTICAL DIMENSION MATCHES OPENING IN MODIFIED CONCRETE CANAL.
 - TRASH RACK SHALL BE SECURED TO FACE OF CONCRETE CANAL WALLS.
 - SUBMIT SHOP DRAWING TO ENGINEER FOR APPROVAL.

7 DETAIL: CUSTOM TRASH RACK
NOT TO SCALE

- CAST IN PLACE CONCRETE
- ALL CONCRETE WORK AND REINFORCEMENT DETAILING SHALL BE IN ACCORDANCE WITH ACI 318-14.
 - MINIMUM COMPRESSIVE STRENGTH OF CONCRETE: 4,000 PSI AT 28 DAYS.
 - MAXIMUM WATER/CEMENT RATIO: 0.45.
 - ALL CONCRETE SHALL CONTAIN 6% AIR CONTENT ± 1.5%.
 - CEMENT SHALL BE TYPE II MEETING THE REQUIREMENTS OF ASTM C150.
 - MAXIMUM COARSE AGGREGATE SIZE SHALL BE 3/4".
 - FLY ASH SHALL BE CLASS F MEETING THE REQUIREMENTS OF ASTM C618. MAXIMUM 25% BY WEIGHT OF TOTAL CEMENTITIOUS CONTENT.
 - REINFORCING STEEL SHALL BE ASTM A615 GRADE 60 DEFORMED BARS.
- FASTENING AND ANCHORAGE
- PRODUCTS
 - POST-INSTALLED ANCHORS: HILTI HIT-HY 200 EPOXY ADHESIVE ANCHORING SYSTEM.
 - ELASTOMERIC SEALANT: "SIKAFLEX 1A" PRODUCT AS MANUFACTURED BY SIKA CORPORATION OR APPROVED EQUAL.
 - BACKER ROD: 3/4" CLOSED CELL PVC, COMPATIBLE WITH SEALANT.
 - JOINT FILLER: 3/4" THICK CELLULAR FIBER.

0516-C-3052
LATEST REVISION

NO.	DATE	ISSUED FOR	PROJ. ENG.	RESP. ENG.
6				
5				
4	01FEB22	CONSTRUCTION	S. MASTERS	R. CHRISTENSEN
3	14JAN22	90% DESIGN REVIEW	S. MASTERS	R. CHRISTENSEN
2	20DEC21	60% DESIGN REVIEW	S. MASTERS	R. CHRISTENSEN
1	20DEC21	60% DESIGN REVIEW	S. MASTERS	R. CHRISTENSEN

PROJECT ENGINEER: S. MASTERS
PRECONSTRUCTION REVISION BLOCK - REV. B

Vendor:

BARR	BARR ENGINEERING CO. 3005 SANDHURST DRIVE SUITE 100 ANDERSON, SC 29615 PH: 252-737-9111
------	---

DTE

DESIGNED BY	DATE	OTHER APPROVALS	DATE
S. HUECKMAN	20DEC21		
A. BATEMAN	20DEC21		
R. CHRISTENSEN	01FEB22		
R. CHRISTENSEN	01FEB22		
R. CHRISTENSEN	01FEB22		
STEVE MASTERS	2/23		

PROJECT ENGINEER: S. MASTERS
PROJECT MANAGER: DTE

0516-C-3052

DESIGN FILE NAME: 0516-C-3052.dwg
DATE: 01FEB22 OPERATOR: JAM6

PROBLEMS				PROBLEMS				PROBLEMS				DTE ELECTRIC APPROVALS				OTHER APPROVALS			
PROLOGS	ISS	REV	DATE	PROLOGS	ISS	REV	DATE	PROLOGS	ISS	REV	DATE	DATE	DATE	DATE	DATE	DATE	DATE	DATE	
												NICHOLAS FROEDERBACH	2/2/22						
MADE BY	DATE	CHK BY	DATE	MADE BY	DATE	CHK BY	DATE	MADE BY	DATE	CHK BY	DATE	PROJECT ENG.	DATE	PROJECT MANAGER	DATE				

TECHNICAL SPECIFICATIONS:

- 1. SUMMARY OF WORK
A. SEE ERECTION SPECIFICATION DIVISION 01 - GENERAL REQUIREMENTS SECTION 011100 - SUMMARY OF WORK.
2. SUBMITTALS
A. SEE ERECTION SPECIFICATION DIVISION 01 - GENERAL REQUIREMENTS SECTION 013300 - SUBMITTALS.
3. SAFETY
A. CONTRACTOR IS RESPONSIBLE FOR JOBSITE CONDITIONS AND SAFETY PROCEDURES AND PROGRAMS, INCLUDING SAFETY AND HEALTH OF ALL PERSONS AND PROPERTY, ON THOSE PORTIONS OF THE SITE AFFECTED BY OR USED BY CONTRACTOR, CONTRACTOR'S EMPLOYEES, SUBCONTRACTORS, AGENTS, AND OTHERS DURING PERFORMANCE OF THE WORK.
4. QUALITY REQUIREMENTS
A. QUALITY-CONTROL SERVICES INCLUDE INSPECTIONS, TESTS, AND RELATED ACTIONS, INCLUDING REPORTS PERFORMED BY CONTRACTOR, BY OWNER, BY INDEPENDENT AGENCIES, AND BY GOVERNING AUTHORITIES.
5. OWNER OPERATIONS
A. COORDINATE ALL WORK WITH OWNER OPERATIONS.
6. CONTROL OF WATER
A. FURNISH ALL LABOR, EQUIPMENT, MATERIALS, AND PERFORM ALL OPERATIONS NECESSARY TO CONTROL WATER IN THE WORK AREAS, INCLUDING THE PROVISION, OPERATION AND MAINTENANCE OF PUMPS AND/OR DEWATERING SYSTEMS ALONG WITH ANY TEMPORARY PIPING OR CHANNELS NECESSARY TO ALLOW THE PROPER EXECUTION OF THE WORK.
7. SITE PREPARATION
A. LOCATE ALL UTILITIES PRIOR TO ANY EXCAVATION WORK. CONTRACTOR MUST REVIEW YARD MAPS AND CONFIRM LOCATION WITH GPR PRIOR TO WORK. THIS MAY INCLUDE SUBCONTRACTING A PRIVATE UTILITY LOCATE COMPANY.
8. GENERAL
A. GENERAL SOIL CONDITIONS IN THE WORK AREA INCLUDE NATIVE CLAY MATERIALS AND CCR WASTE MATERIAL.
9. PRODUCTS
A. COMMON FILL (BAB BACKFILLING): SEE ERECTION SPECIFICATION DIVISION 31 - EARTHWORK SECTION 312000 - EARTHWORK TRANSPORTATION, AND DEPOSITION FOR COMMON FILL SPECIFICATION B. TOPSOIL SHALL MEET MDOT STANDARD SPECIFICATIONS SECTION 917.07.
10. EXECUTION
A. COORDINATE REMOVALS, RELOCATIONS, OR REPLACEMENTS OF EXISTING UTILITIES THAT CONFLICT WITH THE WORK.
11. TESTING AND CLEAN CLOSURE VERIFICATION
A. TESTING SHALL BE PERFORMED BY AN APPROVED INDEPENDENT TESTING AGENCY.
12. EROSION AND SEDIMENT CONTROL
A. INSTALL ADEQUATE MEANS TO CONTROL SOIL EROSION IN PROJECT SITE.
13. SITE RESTORATION
A. PRIOR TO DEMOBILIZATION FROM SITE, RESTORE ANY AREAS IMPACTED BY CONSTRUCTION ACTIVITIES TO A CONDITION EQUAL TO OR BETTER THAN THE CONDITION PRIOR TO CONSTRUCTION.

0516-C-3053
LATEST REVISION

Table with 5 columns: No., Date, Issued For, Proj. Eng., Resp. Eng.
4 01FEB22 CONSTRUCTION S. MASTERS R. CHRISTENSEN
3 14JAN22 80% DESIGN REVIEW S. MASTERS R. CHRISTENSEN
2 20DEC21 60% DESIGN REVIEW S. MASTERS R. CHRISTENSEN
1 29OCT21 50% DESIGN REVIEW S. MASTERS R. CHRISTENSEN

Vendor: BARR ENGINEERING CO.
BARR ENGINEERING CO.
3005 BARR DRIVE
SUITE 100
ANDOVER, MA 01810
PH: 978-335-0111
WWW.BARR-ENG.COM

Approval table with columns: PROBLEMS, FOS GEN TEST ORS, CIVIL, PROBLEMS, FOS GEN TEST ORS, CIVIL, PROBLEMS, FOS GEN TEST ORS, CIVIL, DTE ELECTRIC APPROVALS, DATE, OTHER APPROVALS, DATE, DESIGNED BY, DATE, CHECKED BY, DATE, APPROVED BY, DATE, PROJECT ENGINEER, DATE, PROJECT MANAGER, DATE.

TITLE: BOTTOM ASH BASIN CLOSURE SPECIFICATIONS
LOCATION NAME: ST. CLAIR COUNTY POWER PLANT
UNIT NUMBER:
ORIGINATING SOURCE: BARR ENGINEERING CO.
SCALE: AS SHOWN
USE DIMENSIONS DO NOT SCALE.
DTE ELECTRIC COMPANY DRAWING NUMBER: 0516-C-3053
DESIGN FILE NAME: 0516-C-3053.dwg
DATE: 01FEB22 OPERATOR: JAM6

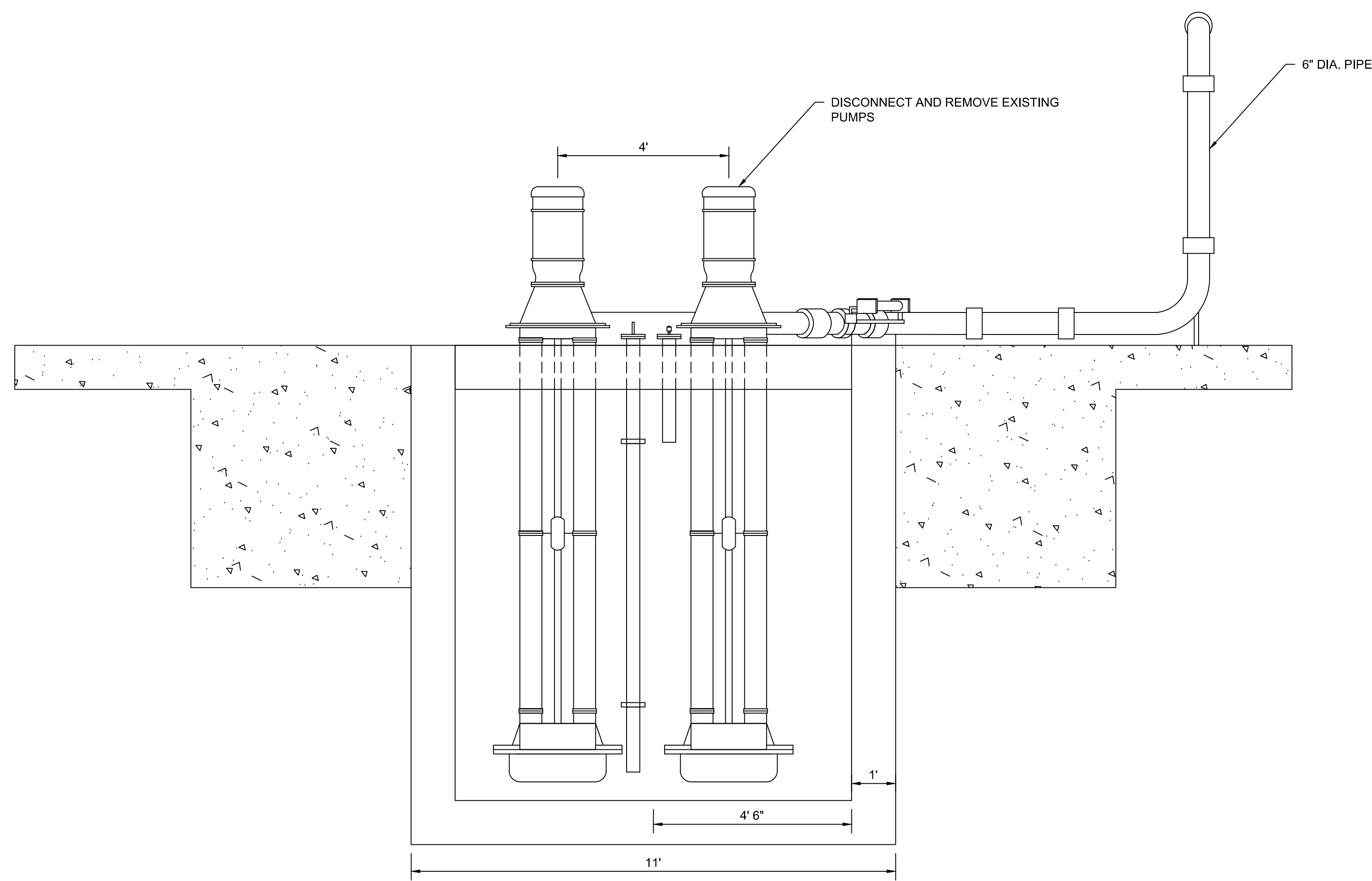

1 PROFILE: PUMP BUILDING PUMPS
SCALE IN FEET

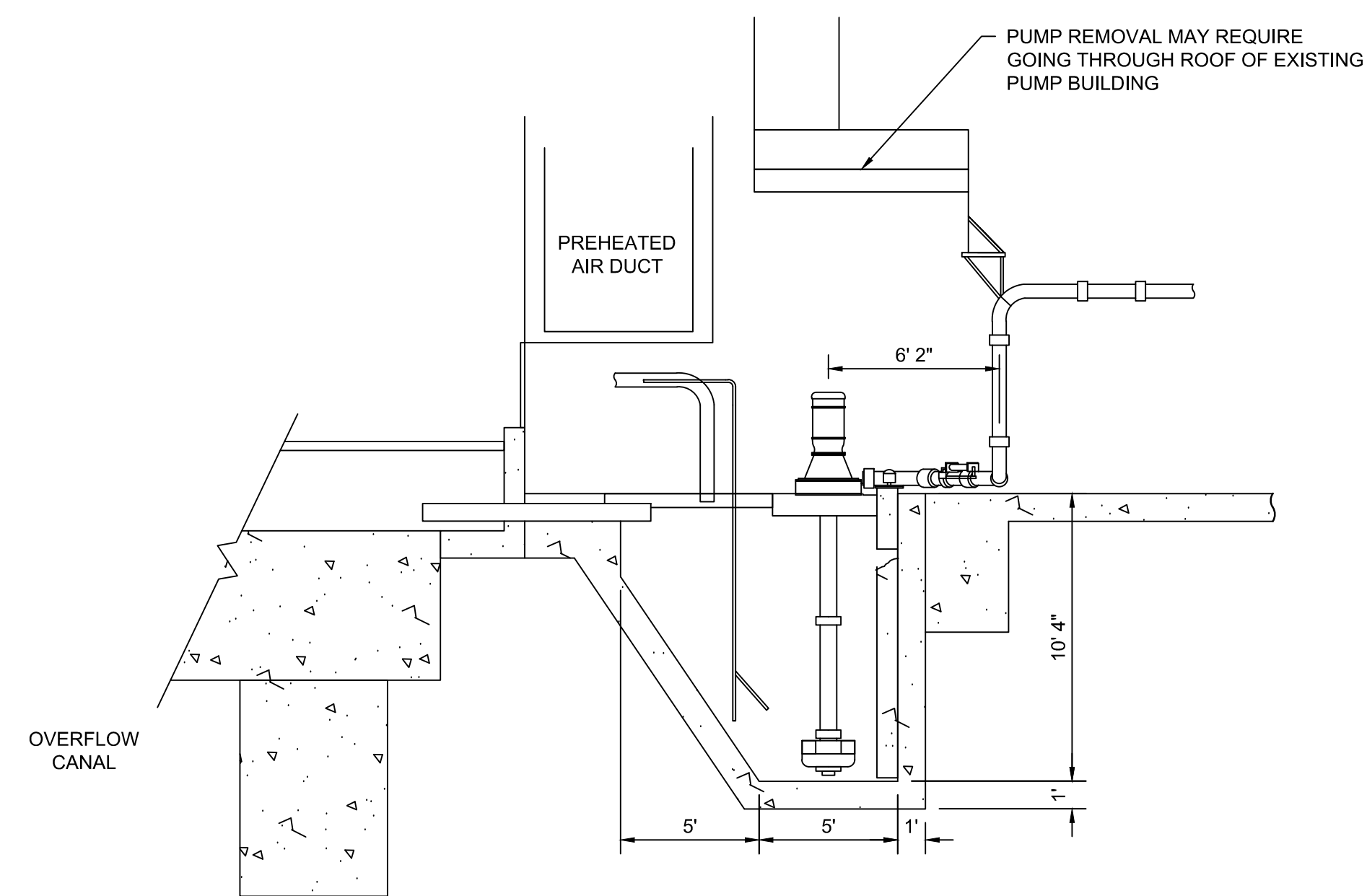

2 PROFILE: PUMP BUILDING PUMPS
SCALE IN FEET

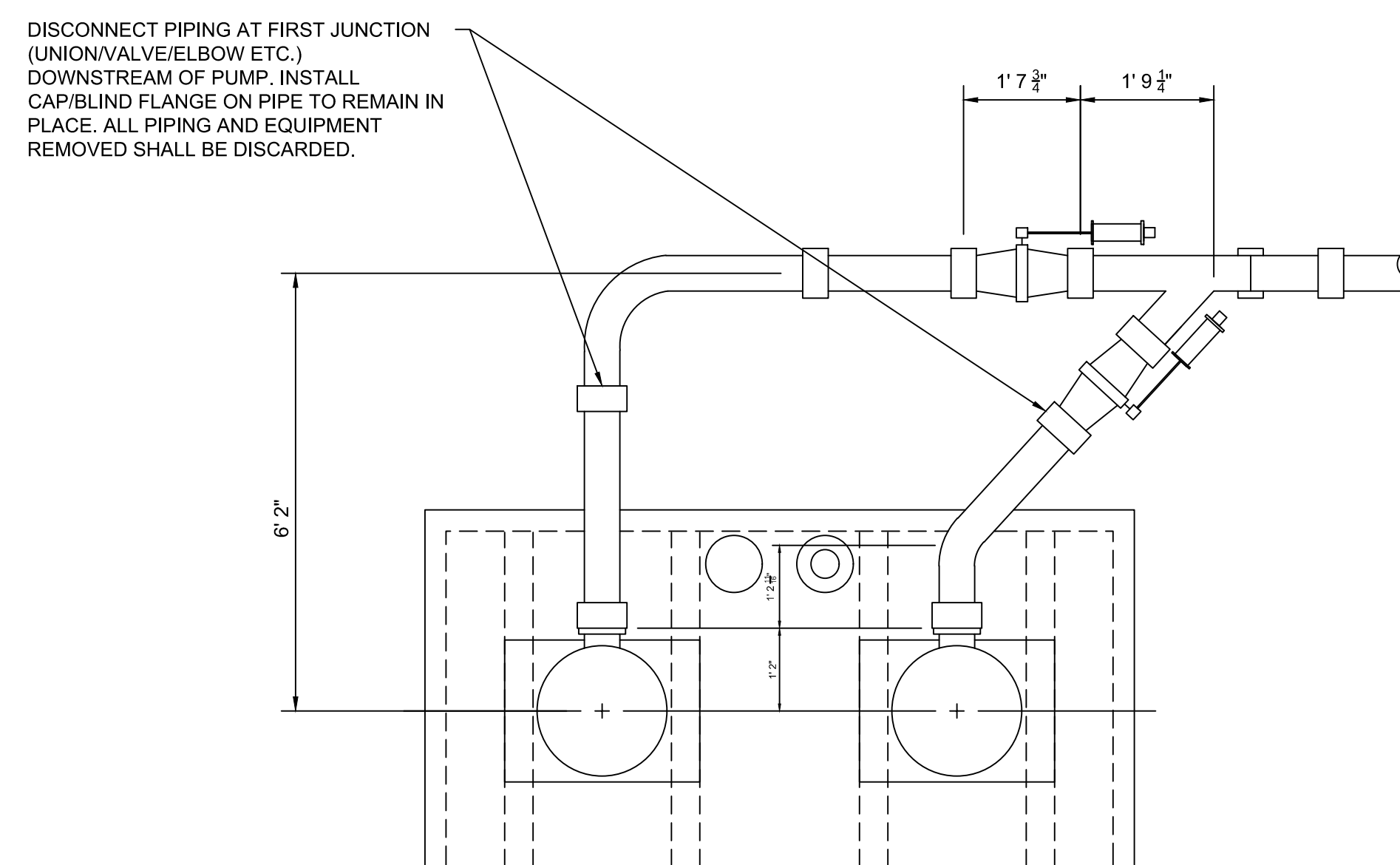

3 DETAIL: PUMP BUILDING PUMPS
SCALE IN FEET

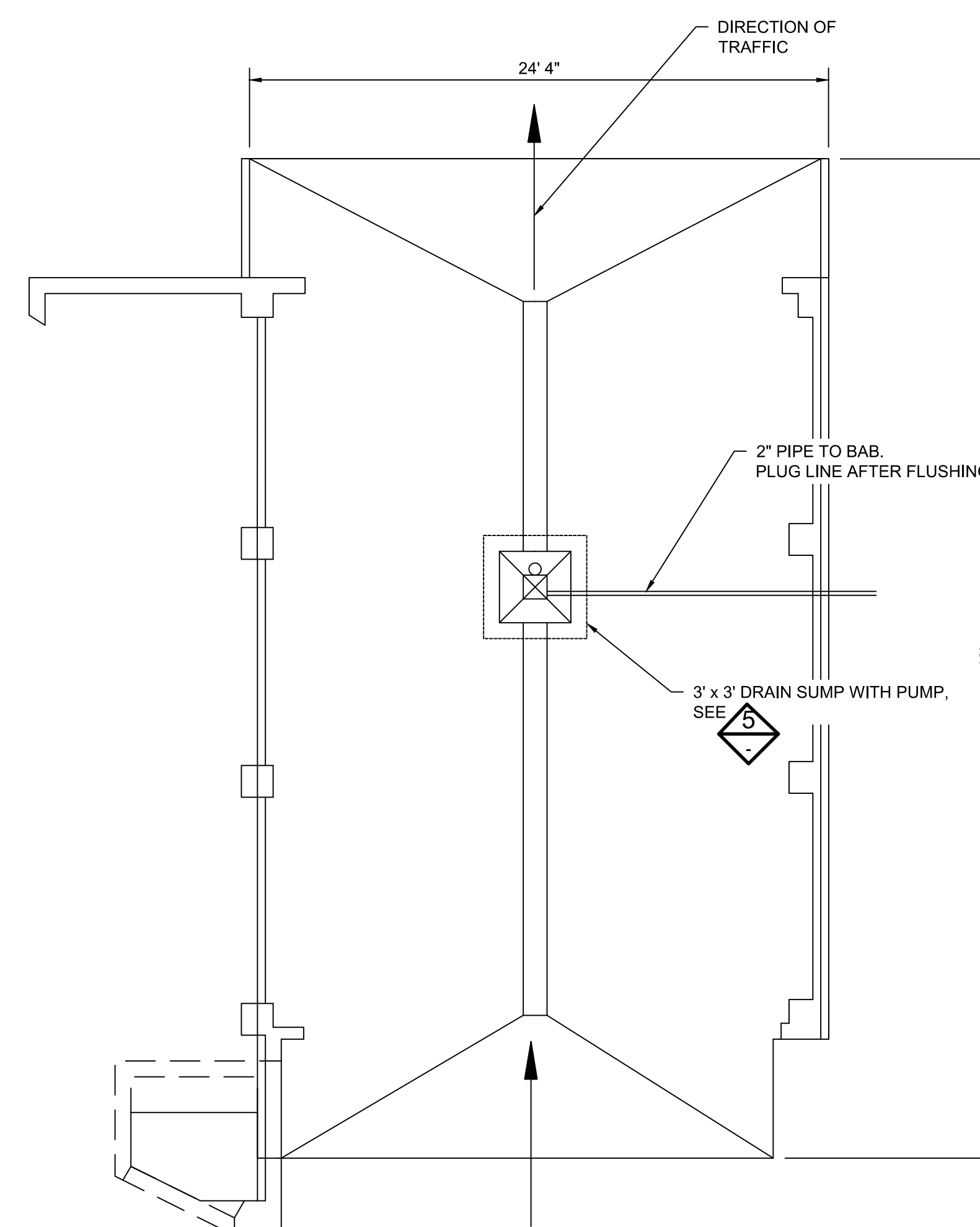

4 PLAN: NORTH AND SOUTH DRAIN SILO TRUCK WASH BAR DRAINAGE SUMP CLEANING
SCALE IN FEET

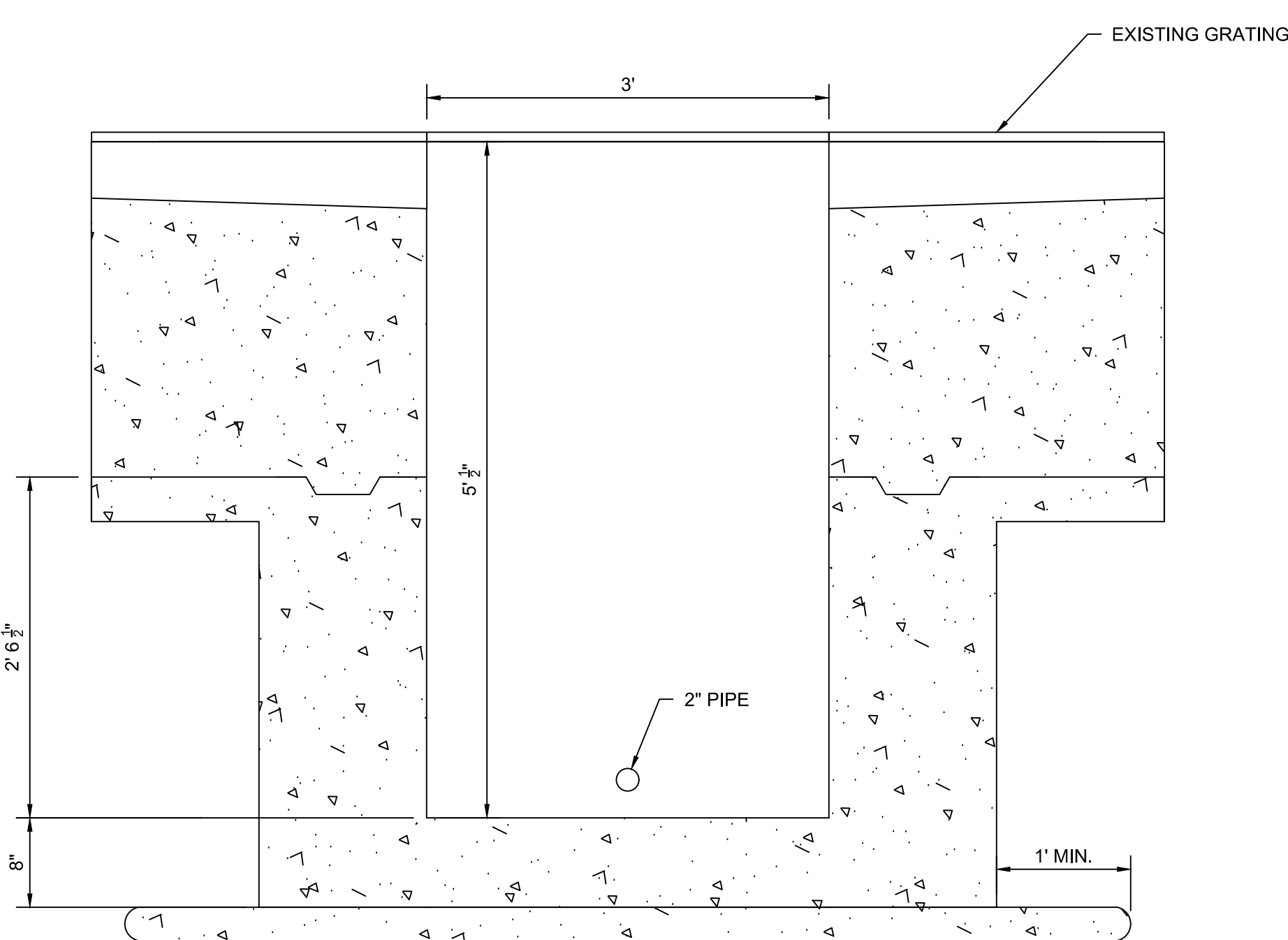

5 DETAIL: DRAIN SUMP
SCALE IN FEET

LEGEND

NOTES:

- REMOVE AND DISCARD EXISTING PUMPS AND ANY ASSOCIATED EQUIPMENT/MATERIAL THAT MAY ALSO NEED TO BE REMOVED IN ORDER TO DISCONNECT PUMPS.
- CAP DISCHARGE PIPING AFTER PUMP REMOVAL.
- DUE TO SIZE OF PUMPS ITS LIKELY PUMPS WILL NEED TO BE REMOVED THROUGH THE EXISTING ROOF HATCH LOCATED ABOVE THE PUMPS.
- IT IS THE RESPONSIBILITY OF THE CONTRACTOR TO CONFIRM POWER TO THE PUMP HAS BEEN SHUT DOWN.
- DRAINAGE SUMPS AT BOTH THE NORTH SILO AND SOUTH SILO DRAIN PITS SHALL BE POWER WASHED AND VACUUMED OUT.
- CONTRACTOR SHALL REMOVE ALL EQUIPMENT/TOOLS LOCATED DOWN INSIDE SUMP.
- AFTER SUMPS HAVE BEEN CLEANED THE CONTRACTOR SHALL FLUSH THE DISCHARGE PIPE AS REQUIRED SUCH THAT CLEAN WATER CAN BE VISUALLY OBSERVED COMING OUT OF THE DISCHARGE END.
- AFTER THE DISCHARGE LINE HAS BEEN VERIFIED "FLUSHED CLEAN" CONTRACTOR SHALL CAP/PLUG DISCHARGE LINE TO PREVENT ACCIDENTAL RELEASE TO THE BOTTOM ASH PONDS.

REFERENCE DRAWINGS:

- 0516-M-1073
- 0516-C-0484
- 0516-C-0485

0516-M-7435
LATEST REVISION

6			
5			
4			
3			
2	01FEB22	CONSTRUCTION	S. MASTERS R. CHRISTENSEN
1	14JAN22	90% DESIGN REVIEW	S. MASTERS R. CHRISTENSEN
NO. DATE	ISSUED FOR	PROJ. ENG.	RESP. ENG.
PROJECT ENGINEER: S. MASTERS			APPROVALS
PRECONSTRUCTION REVISION BLOCK - REV. 0			

Vendor:

DTE	
TITLE	
BOTTOM ASH BASIN CLOSURE PUMP BUILDING AND SILO DRAIN SUMP PLAN, PROFILES, AND DETAILS	
LOCATION NAME	UNIT NUMBER
ST. CLAIR COUNTY POWER PLANT	
ORIGINATING SOURCE	SCALE
BARR ENGINEERING CO.	A5 SHOWN
DTE ELECTRIC COMPANY DRAWING NUMBER	USE DIMENSIONS DO NOT SCALE
0516-M-7435	
DESIGN FILE NAME: 0516-M-7435.dwg	
DATE: 01FEB22 OPERATOR: JAM6	

THIS IS AN CAD PRODUCED DRAWING.
ANY CHANGES OR REVISIONS TO
THIS DRAWING MUST BE COMPLETED
USING THE CAD SYSTEM

C PROBLEMS				B PROBLEMS				A PROBLEMS				DTE ELECTRIC APPROVALS		OTHER APPROVALS		DESIGNED BY	DATE
FOG GEN TECH DRG				FOG GEN TECH DRG				FOG GEN TECH DRG				Nicholas Reinhardt	2/2/22	VERMIR		S. HUECKEMAN	21OCT21
FOG GEN PLANT ENG				FOG GEN PLANT ENG				FOG GEN PLANT ENG						ARCH		J. METTLACH	26OCT21
DIST OPR				DIST OPR				DIST OPR						CIVIL		R. CHRISTENSEN	29OCT21
PROJECT ENG				PROJECT ENG				PROJECT ENG						MECH		R. CHRISTENSEN	01FEB22
ENG COMP				ENG COMP				ENG COMP						ELECT		Steve Masters	2/3/22
MADE BY	DATE	INC	ELECT.	MADE BY	DATE	INC	ELECT.	MADE BY	DATE	INC	ELECT.	PROJECT ENG	DATE	APPROVED BY	DATE	PROJECT ENGINEER	DATE
CHK BY	DATE	MECH.	APPROVED BY	CHK BY	DATE	MECH.	APPROVED BY	CHK BY	DATE	MECH.	APPROVED BY	PROJECT MGR	DATE			PROJECT MANAGER	DATE

CAD USER: kva L J0604 FILE: AL1058022141081002210580.dwg PLOT DATE: 01/20/22 4:57 PM

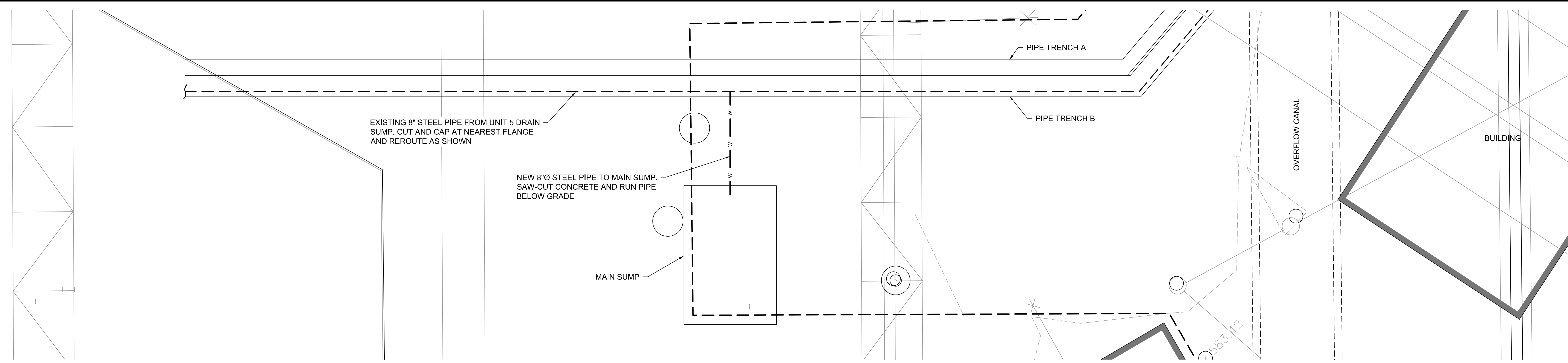

LEGEND

- 600 — EXISTING MAJOR CONTOUR
- 605 — EXISTING MINOR CONTOUR
- ○ — ○ — EXISTING GUARDRAIL
- — — EXISTING PIPELINE
- + + + — EXISTING ELECTRIC
- w w w — EXISTING WATER
- com com com — EXISTING COMMUNICATIONS
- ▭ EXISTING STRUCTURE

- NOTES:**
- SECTIONS AND DETAILS ARE REDRAWN FROM PREVIOUS RECORD DRAWINGS. DRAWINGS REFERENCED ARE 0516-M-1064, 0516-C-0727, AND 0516-C-W-0134.
 - CUT AND CAP PIPE AT BOTH ENDS OF THE PIPE. AT THE DISCHARGE END, PLUG WITH CONCRETE. AT THE SOURCE END, CUT THE PIPE AT A PRESELECTED FLANGE OR ELBOW AND PHYSICALLY REMOVE A SECTION OF PIPE. THIS APPROACH ISOLATES THE PIPE FROM THE BOTTOM ASH POND, WHICH ELIMINATES THE POTENTIAL FOR AN ACCIDENTAL RELEASE TO THE POND.
 - IF THE SOURCE END OF THE PIPE ORIGINATES AT A UNIT PROCESS THAT HAS A WATER SUPPLY, THEN THE CONTRACTOR SHALL REMOVE THE SUPPLY OF WATER INTO THE UNIT BY CLOSING ALL WATER SUPPLY VALVES TO THE UNIT AND THEN REMOVING A SECTION OF THE PIPE BETWEEN THE UNIT AND THE VALVE. THE SAME PROCESS SHALL BE COMPLETED ON THE WATER SUPPLY DISCHARGE END. THIS APPROACH ELIMINATES THE WATER SUPPLY FROM ACCIDENTALLY BEING TURNED ON, CAUSING A RELEASE FROM THE UNIT.

REFERENCE DRAWINGS:

0516-M-1064
0516-C-0727
0516-C-W-0134

1 PLAN: STEEL PIPE TO MAIN SUMP
SCALE IN FEET

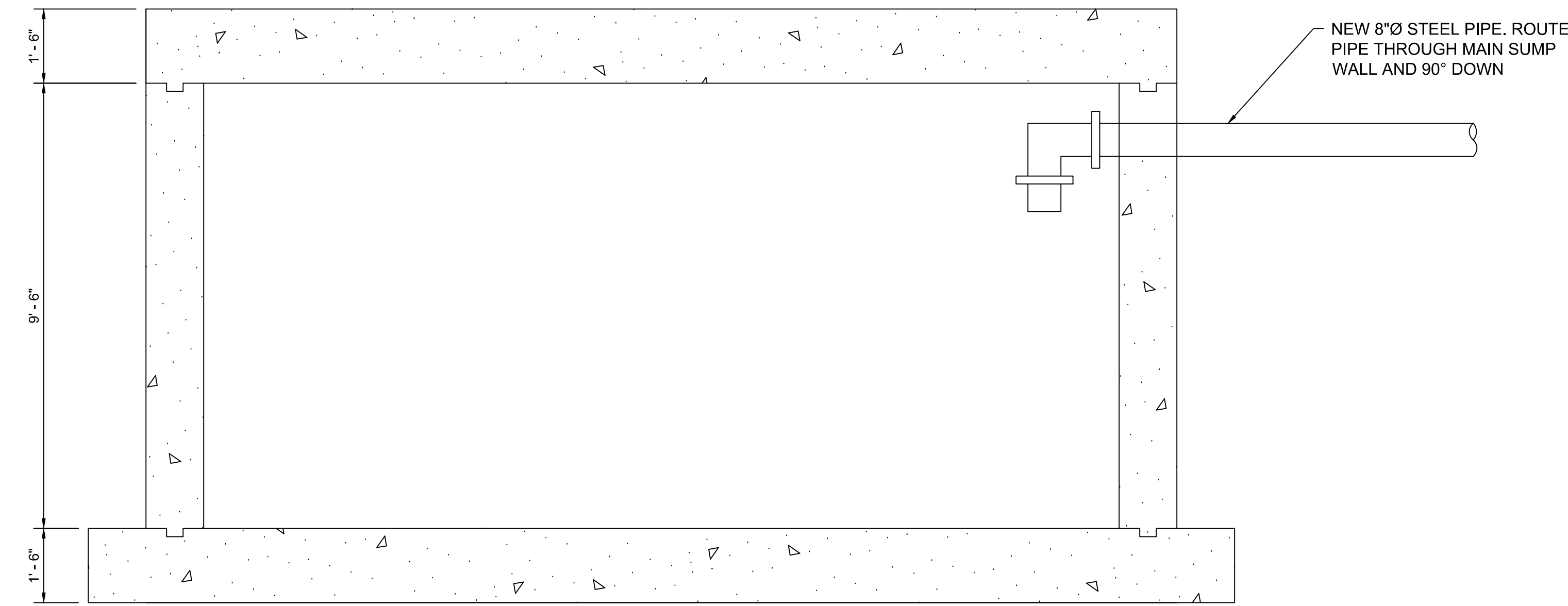
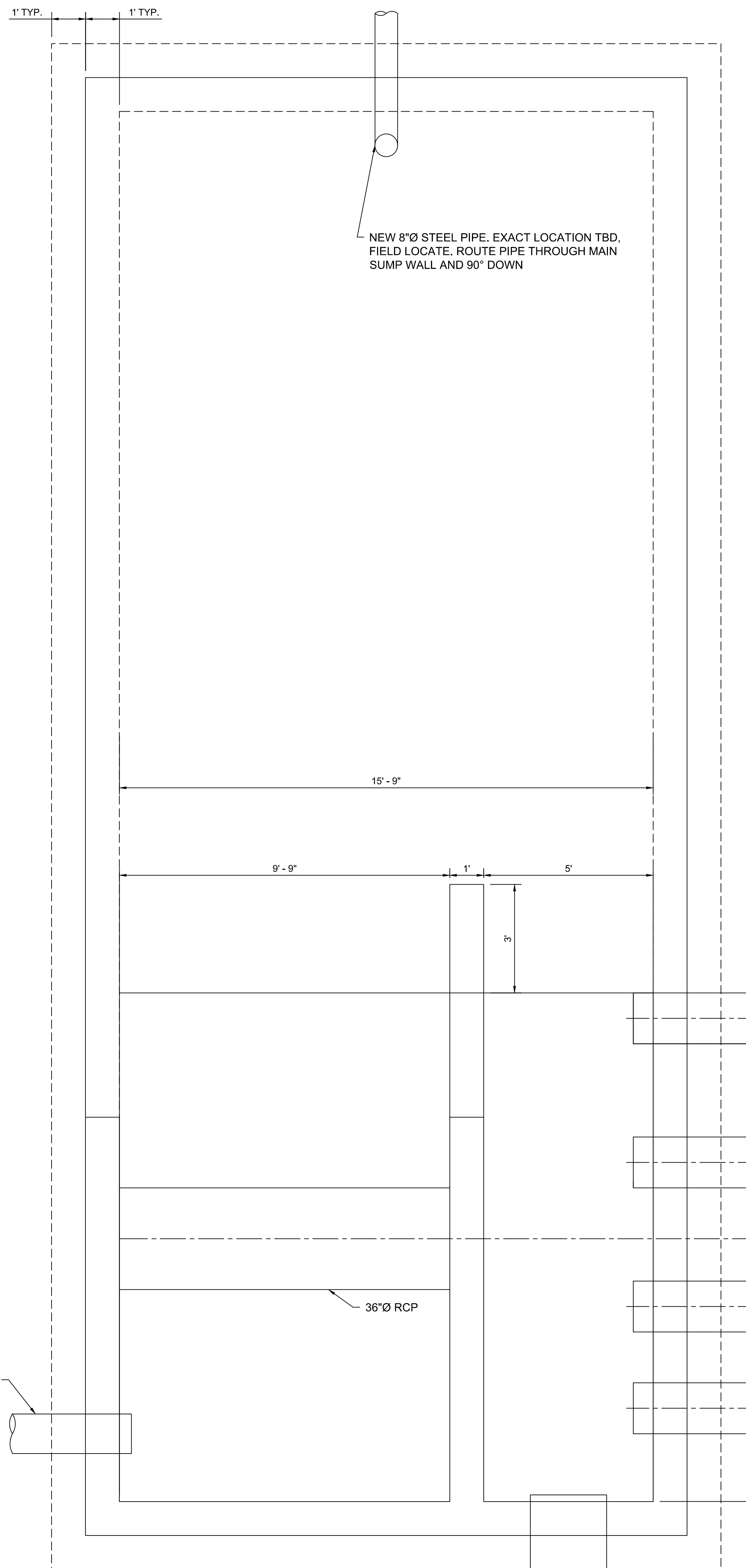

3 SECTION: MAIN SUMP
SCALE IN FEET

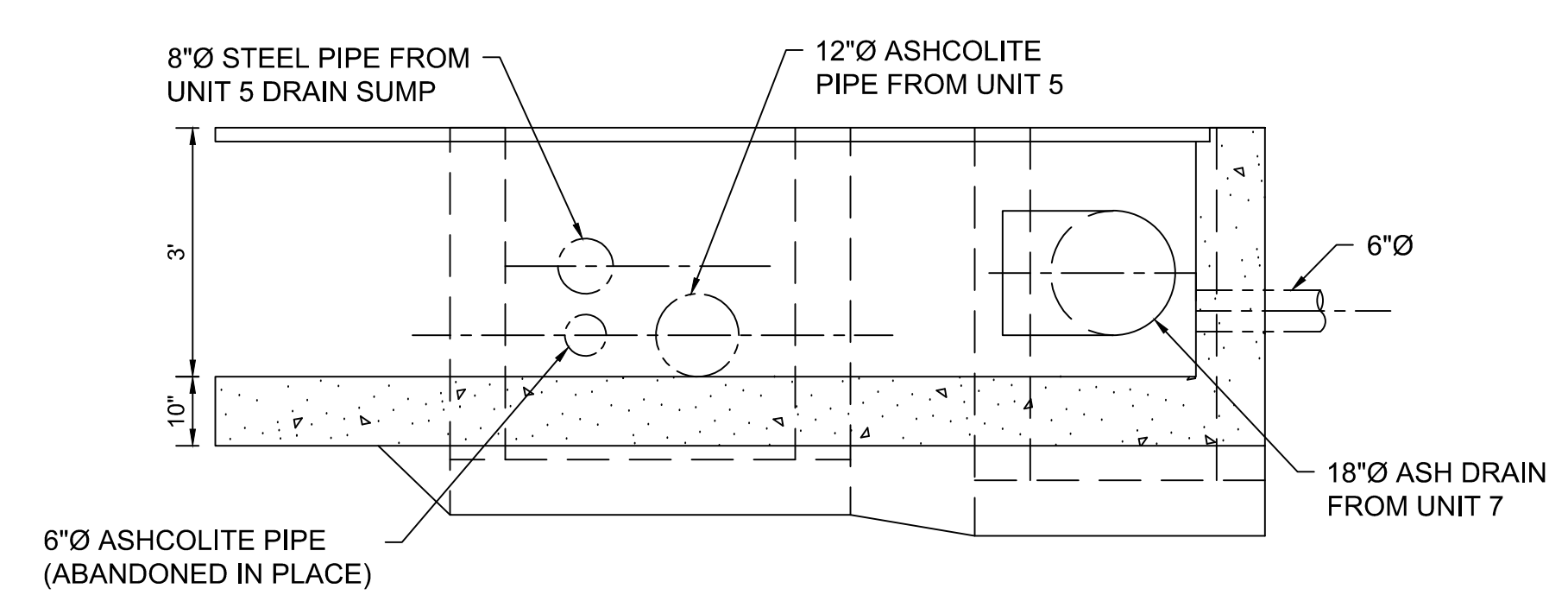

4 DETAIL: EXISTING PIPE TRENCH A AND B
SCALE IN FEET

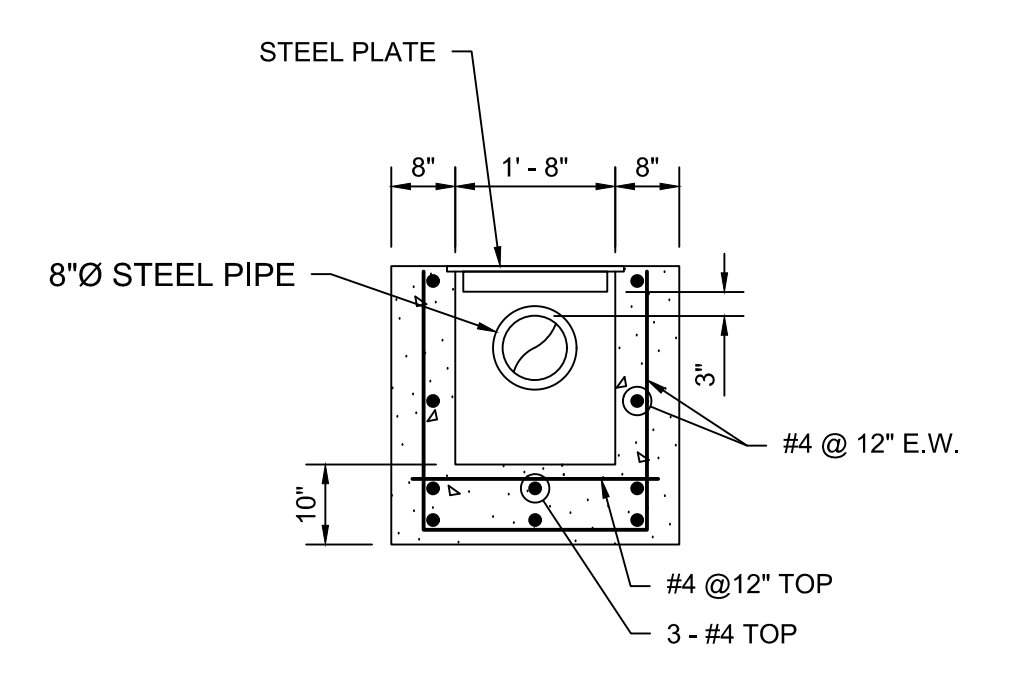

5 DETAIL: PIPE TRENCH
SCALE IN FEET

- CAST IN PLACE CONCRETE**
- ALL CONCRETE WORK AND REINFORCEMENT DETAILING SHALL BE IN ACCORDANCE WITH ACI 318-14.
 - MINIMUM COMPRESSIVE STRENGTH OF CONCRETE: 4,000 PSI AT 28 DAYS.
 - MAXIMUM WATER/CEMENT RATIO: 0.45.
 - ALL CONCRETE SHALL CONTAIN 6% AIR CONTENT ±1.5%.
 - CEMENT SHALL BE TYPE II MEETING THE REQUIREMENTS OF ASTM C150.
 - MAXIMUM COARSE AGGREGATE SIZE SHALL BE 3/4".
 - FLY ASH SHALL BE CLASS F MEETING THE REQUIREMENTS OF ASTM C618. MAXIMUM 25% BY WEIGHT OF TOTAL CEMENTITIOUS CONTENT.
 - REINFORCING STEEL SHALL BE ASTM A615 GRADE 60 DEFORMED BARS.

0516-M-7436
LATEST REVISION

6				
5				
4	01FEB22	CONSTRUCTION	S. MASTERS	R. CHRISTENSEN
3	14JAN22	90% DESIGN REVIEW	S. MASTERS	R. CHRISTENSEN
2	20DEC21	60% DESIGN REVIEW	S. MASTERS	R. CHRISTENSEN
1	29OCT21	50% DESIGN REVIEW	S. MASTERS	R. CHRISTENSEN

PROJECT ENGINEER: S. MASTERS
PRECONSTRUCTION REVISION BLOCK - REV. 0

Vendor:
BARR ENGINEERING CO.
3005 EDWARDSVILLE DRIVE
SUITE 100
ANDERSON, IN 46016
PH: 317-921-0111

DTE

DESIGNED BY	DATE	DESIGNED BY	DATE
S. HUECKMAN	21OCT21	DESIGNED BY	DATE
J. METTLACH	26OCT21	DESIGNED BY	DATE
R. CHRISTENSEN	29OCT21	DESIGNED BY	DATE
R. CHRISTENSEN	01FEB22	DESIGNED BY	DATE
S. MASTERS	DATE	DESIGNED BY	DATE
S. MASTERS	DATE	DESIGNED BY	DATE
S. MASTERS	DATE	DESIGNED BY	DATE
S. MASTERS	DATE	DESIGNED BY	DATE

LOCATION NAME: ST. CLAIR COUNTY POWER PLANT
UNIT NUMBER: _____
ORIGINATING SOURCE: BARR ENGINEERING CO.
SCALE: AS SHOWN
USE DIMENSIONS DO NOT SCALE.

C				B				A				DTE ELECTRIC APPROVALS		OTHER APPROVALS		DESIGNED BY	
PROJ. ENG.	DESIGN	CHK BY	DATE	PROJ. ENG.	DESIGN	CHK BY	DATE	PROJ. ENG.	DESIGN	CHK BY	DATE	DATE	DATE	DATE	DATE	DATE	DATE
												Nicholas Reidenbach	2/2/22			S. HUECKMAN	21OCT21
															J. METTLACH	26OCT21	
															R. CHRISTENSEN	29OCT21	
															R. CHRISTENSEN	01FEB22	
															S. MASTERS	DATE	
															S. MASTERS	DATE	
															S. MASTERS	DATE	
															S. MASTERS	DATE	

THIS IS AN CAD PRODUCED DRAWING. ANY CHANGES OR REVISIONS TO THIS DRAWING MUST BE COMPLETED USING THE CAD SYSTEM.

Attachment B

Geotechnical Information

Technical Memorandum

To: DTE
From: Barr Engineering Co.
Subject: 2021-2022 STCCP Geotechnical Investigations
Date: January 31, 2022
Project: STCCP BAB Closure Plan

This memorandum summarizes geotechnical investigations performed in the fall of 2021 and winter of 2022 at DTE's St. Clair Power Plant (STCCP) in East China, Michigan. Available historic geotechnical data is also discussed and appended.

1 Scope of Services

To support development of a closure plan for the bottom ash basins (BAB) at STCCP, geotechnical investigations were performed to collect and test samples of the ash and the native materials outside the sheet pile walls and below the basins.

Barr completed the following tasks for the geotechnical investigation:

- 1) Geotechnical Field Investigations:
 - a) Two Standard Penetration Test (SPT) borings on the east side of the East basin to evaluate in-situ strength condition and stratigraphy of the native clay.
 - b) Vibracore pushes within the West and East basins to investigate the depth to ash and native clay.
 - c) Cone Penetrometer Test (CPT) soundings throughout the site to gain additional knowledge about the native clay behavior.
 - d) Vane Shear Testing (VST) at one location to provide in-situ native clay strengths at various depths.
- 2) Geotechnical Laboratory Testing:
 - a) Select soil boring samples tested to determine material index, state, hydraulic, and strength properties.
 - b) Select ash bulk samples tested to determine material index, state, and hydraulic properties.

These investigations are described in more detail in the following sections. Historic information is provided in Attachment 1.

2 Field Investigations

The 2021 and 2022 geotechnical investigation locations are shown on Figure 1 and summarized in Table 1.

Table 1 Geotechnical Investigation Locations

Boring ID	Type	Northing [ft]	Easting [ft]	Elevation [ft]	Depth(s) [ft]
SB-01-21	Exploratory SPT boring	465,175.14	13,632,072.86	581.3	44
SB-02-21	Exploratory SPT boring	465,508.90	13,632,154.81	584.6	60
CPT22-01	CPTu sounding	465,504.15	13,632,152.26	582.5	60
CPT22-02	CPTu sounding	465,179.30	13,632,076.58	581.8	50
CPT22-03	CPTu sounding	465,458.91	13,632,006.30	583.3	50
CPT22-04	CPTu sounding	465,266.91	13,631,968.00	583.6	50
CPT22-05	CPTu sounding	465,235.57	13,631,841.18	584.0	50
CPT22-06	CPTu sounding	465,485.80	13,631,857.45	583.8	50
VST22-01	Vane shear testing	465,494.05	13,632,146.10	582.4	6/21/31

Note: Boring coordinates are in Michigan State Plane South Zone, NAD83 (international feet) and the elevations reference NAVD88.

2.1 SPT Drilling Investigation

Two geotechnical borings were completed by Job Site Services, Inc. (JSS) out of Bay City, Michigan, in October 2021. JSS performed the borings using a CME 1050 drill rig with hollow-stem auger methods. Borings were performed at key locations (near previous drilling by TRC during a 2016 investigation to install monitoring wells) to gather data on the subsurface stratigraphy and SPT blow counts in the native clay material. The borings were performed with a Barr geologist present to visually classify soil samples, record SPT blow counts, obtain pocket penetrometer strength measurements, and prepare field boring logs. Soil samples were collected from standard penetration test split-spoons and thin-wall tubes for laboratory testing. Soil sampling and classification was performed based on 2-foot-long continuous split-spoon samples to the completion depth of the borings. The borings were backfilled with bentonite and cuttings.

The boring logs can be found in Attachment 2.

2.2 Vibracore Drilling Investigation

In September and October 2021, twenty-seven vibracore locations within the West and East basins were drilled, with depths ranging from 15.9 to 25.6 feet. The vibracore drilling was also performed by JSS with a Barr geologist present to record the encountered stratigraphy. Vibracore drilling methods were used to gain a better understanding of the depth to fly ash (from top of water in basins), and depth to native clay. Due to the soft, saturated, fine-grained characteristics of the fly ash, top of sediment depths were hard to determine, but were estimated to be 7.5 and 8 feet below grade at 2 locations. The average depth to native clay of the East and West cells was 18.8 feet. The average depth to water of the East and West cells was 4.5 feet below the top of grade/sheet piles. With a depth to water between approximately 3 to 5 feet

below ground surface and a depth to ash around 8 feet, the resulting thickness of the ash in the BABs is estimated to be around 10 feet.

A summary of the vibracore work can be found in Attachment 3.

2.3 CPT Testing

In January 2022, six CPT soundings were performed in the native clay throughout the site by ConeTec Investigations, Ltd., (ConeTec) out of Elk Grove Village, Illinois. The CPT work was performed with a Barr engineer present to observe procedures and stratigraphy encountered, and to select locations to perform vane shear testing (see next section). CPT22-01 was performed adjacent to boring location SB-02-21, and CPT22-02 was performed adjacent to SB-01-21 for comparison of SPT and laboratory strength results in the native clay. The remaining four borings were performed throughout the site to improve spatial coverage of data. Depth of the CPT soundings ranged from 50 to 60 feet. An obstruction was encountered at CPT-03-21 which prevented ConeTec from advancing past 5 feet at that location.

Resulting clay strength measurements from the investigation were fairly consistent across the site. A stronger, more granular layer was encountered around 45 feet below ground surface at CPT22-01 through CPT22-04. The granular layer was not encountered at CPT22-05 and CPT22-06.

CPT plots and data can be found in ConeTec's report in Attachment 4.

2.3.1 Vane Shear Testing

Electronic Vane Shear Testing was performed by ConeTec with a Barr engineer present in January 2022. VST was completed offset from one sounding (CPT-22-01) at three different depth locations of 7, 20, and 30 feet based on the resulting Soil Behavior Type (SBT) profiles from the CPT investigation.

VST plots and data can be found in ConeTec's report in Attachment 4.

3 Laboratory Testing

In addition to ash and soil samples collected during the investigations, bulk ash samples were also collected by Barr Engineering staff during an August 2021 site visit. Samples were tested for Standard Proctor moisture-density relationship to evaluate future compaction of the ash when placed at DTE's Range Road Landfill.

Testing Engineering Consulting (TEC) of Troy, Michigan, and Soil Engineering Testing, Inc., (SET) of Bloomington, Minnesota, performed in-laboratory material tests in September and December of 2021 and January in 2022. The tests performed on ash and soil samples collected during the geotechnical investigation are summarized in Table 2. The test results are included in Attachment 5.

Table 2 Summary of Laboratory and Field Test Program

Laboratory Test	Quantity on Ash	Quantity on Clay
Moisture Content	-	10
Dry Density	-	-
Grain Size Analysis (Mechanical and Hydrometer)	7	6
Atterberg Limits	7	6
Permeability	-	1
Specific Gravity	7	2
Organic Content	-	2
pH	7	-
Standard Proctor	-	2
Unconsolidated-Undrained Triaxial Compression Strength	-	4
Unconfined Compressive Strength	-	4
Field Vane Tests	-	3
Lab Vane Tests	-	8

4 Water Level Conditions

During the vibracore work, water level in the basins was typically encountered from about 3.9 to 5.2 feet below the surrounding ground surface, as noted in Attachment 3.





Groundwater was not encountered in the SPT boring locations. Groundwater measurements were not available upon completion of the borings. See specific depth to water values in the previous monitoring well drilling and well data in Attachment 1.

5 BAB Cross-sections and Profiles

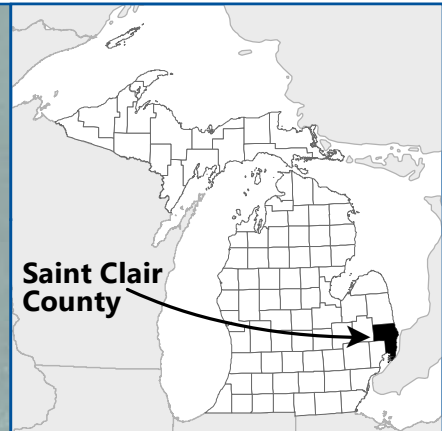
A depth to clay contour map, along with cross sections of the West and East Basins were created using information available regarding the construction of the basins as well as stratigraphy and water level information gained from the geotechnical investigation. The depth to clay map is provided as Figure 2 and the basin cross-sections and profiles can be found in Attachment 6 . Contours/depths are interpolated from a limited data set and actual depths between test locations can be expected to be somewhat variable, particularly as ash deposition will continue until closure of the plant in 2022.

Barr Footer: ArcGIS 10.8.1, 2022-01-27 16:38 File: I:\Projects\22\41069\Maps\Reports\GeotechInvestigationLocations\Figure1_STCPP_2021_2022_InvestigationLocations.mxd User: MAC2



-  Vibracore Boring
-  Geotechnical Boring
-  Cone Penetration Test Location
-  Vane Shear Test Location

Notes:

- Boring locations depicted on this figure based on GPS data collected by Barr Engineering Co. (9/29/2021 to 10/5/2021.)
- Cone penetration test and vane shear test locations on this figure based on coordinates from ConeTec report, "Presentation of Site Investigation Results", dated 1/12/2022.

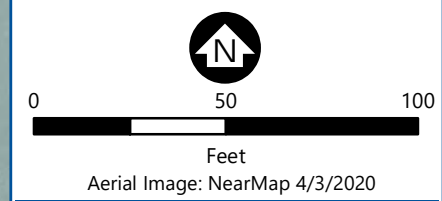

2021-2022 GEOTECHNICAL INVESTIGATION LOCATIONS
 St. Clair Power Plant
 DTE Energy
 4901 Pointe Drive
 China Township, Michigan

FIGURE 1



Barr Footer: ArcGIS 10.8.1, 2021-11-05 15:43 File: I:\Projects\22\22\41069\Maps\Reports\Figure 1 - STCPP Boring Locations - Depth to Clay.mxd User: MACZ

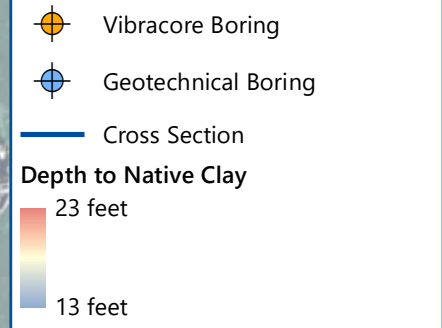
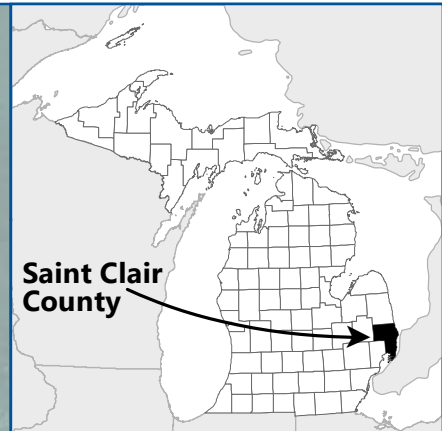
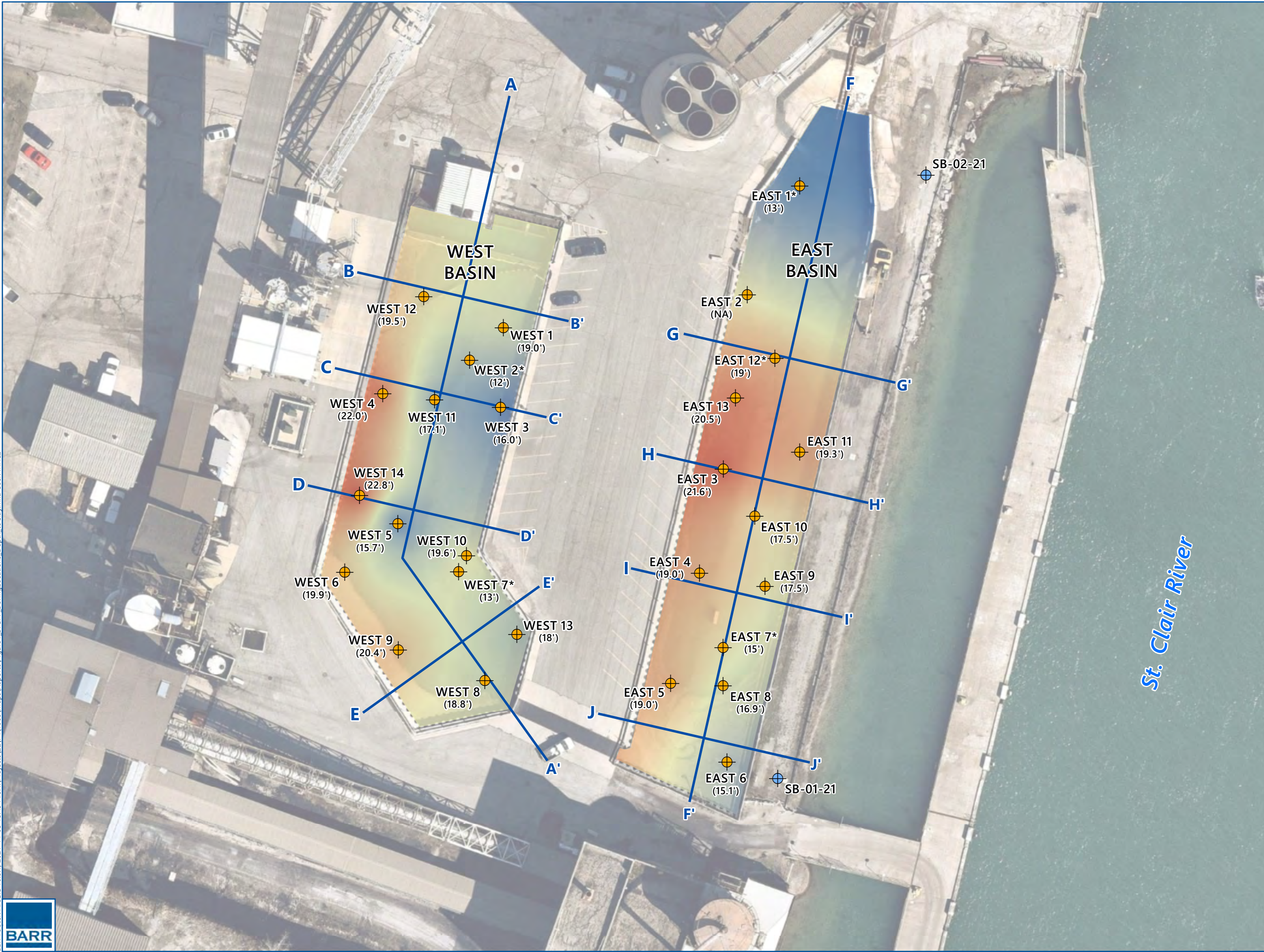

Notes:

- Boring locations depicted on this figure based on GPS data collected by Barr Engineering Co. (9/29/2021 to 10/5/2021.)
- Boring locations labels include measured depth to clay feet below surface.
- *Denotes Vibracore was pushed to refusal and no clay was recovered, and therefore excluded from cell bottom analysis; Exception being EAST 1 where coarse material prevented collection of any depth to clay measurements.

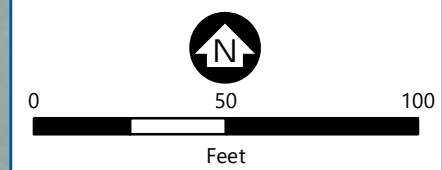

Aerial Image: NearMap 4/3/2020

2021 INVESTIGATION LOCATIONS

DEPTH TO NATIVE CLAY

St. Clair Power Plant
DTE Energy
4901 Pointe Drive
China Township, Michigan

FIGURE 2





Attachment 1

Available Historical Geotechnical Data

TRC 2016 Boring Logs





LEGEND

-  DOWN-GRADIENT WELL
-  UP-GRADIENT WELL
-  RIVER LEVEL MONITORING POINT

NOTES

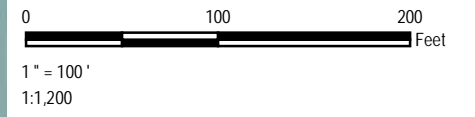
1. BASE MAP IMAGERY FROM GOOGLE EARTH PRO & PARTNERS, APRIL 2015.
2. WELL LOCATIONS SURVEYED BY BMJ ENGINEERS AND SURVEYORS INC. IN APRIL 2016.



PROJECT:		DTE ELECTRIC CO. ST. CLAIR POWER PLANT 4901 POINTE DRIVE CHINA TOWNSHIP, MICHIGAN	
TITLE:		SITE PLAN	
DRAWN BY:	PAPEZ J	PROJ NO.:	231828.0001
CHECKED BY:	SCIESZKA C	FIGURE 1	
APPROVED BY:	BUENING V		
DATE:	MAY 2016		
		1540 Eisenhower Place Ann Arbor, MI 48108-3284 Phone: 734.971.7080 www.trcsolutions.com	
FILE NO.:		231828-0004-001.mxd	



WELL CONSTRUCTION LOG

WELL NO. MW-16-01

Page 1 of 3

Facility/Project Name: DTE: Saint Clair Power Plant		Date Drilling Started: 3/31/16	Date Drilling Completed: 3/31/16	Project Number: 231828.0004.0000	
Drilling Firm: Stock Drilling	Drilling Method: Sonic	Surface Elev. (ft) 585.12	TOC Elevation (ft) 584.74	Total Depth (ft bgs) 138.0	Borehole Dia. (in) 6
Boring Location: S side of median, in parking lot W of ash basin.		Personnel Logged By - J. Reed Driller - A. Goldsmith		Drilling Equipment: Terrasonic	
N: 465440.66 E: 13631612.80					
Civil Town/City/or Village: Saint Clair	County: Saint Clair	State: MI	Water Level Observations: While Drilling: _____ Date/Time _____ After Drilling: _____ Date/Time 4/8/16 08:45 Depth (ft bgs) 14.08		

SAMPLE NUMBER AND TYPE	RECOVERY (%)	BLOW COUNTS	DEPTH IN FEET	LITHOLOGIC DESCRIPTION	USCS	GRAPHIC LOG	WELL DIAGRAM	COMMENTS
1 CS	90		5	GRAVEL WITH SAND mostly gravel, little sand, brown (10YR 5/3), no odor, moist. CLAY mostly clay, few silt, grayish brown (10YR 5/2), no odor, moist, dense.				
			10	Change to medium dense at 10.0 feet.				
			12.5	Change to soft to medium dense at 12.5 feet.				
			20		CL			
2 CS	95		30					
			35					

SOIL BORING WELL CONSTRUCTION LOG 231828.0004.0000.GPJ TRC CORP.GDT 5/25/16

Signature: *[Handwritten Signature]* for J Reed

Firm: TRC Environmental Corporation 734.971.7080
1540 Eisenhower Place Ann Arbor, Michigan Fax 734.971.9022

Checked By: C. Scieszka



WELL CONSTRUCTION LOG

WELL NO. MW-16-01

Page 2 of 3

SOIL BORING WELL CONSTRUCTION LOG 231828.0004.0000.GPJ TRC CORP.GDT 5/25/16

SAMPLE		BLOW COUNTS	DEPTH IN FEET	LITHOLOGIC DESCRIPTION	USCS	GRAPHIC LOG	WELL DIAGRAM	COMMENTS
NUMBER AND TYPE	RECOVERY (%)							
3 ST								
4 CS	100		45	Change to few fine to coarse sand at 43.0 feet.				
			50	Change to gray (10YR 5/1) at 50.0 feet.				
			55					
			60		CL			
			65					
5 CS	100		70					
			75					
			80	Sand seam, 8 inches thick, mostly coarse sand, black (10YR 2/1) at 80.25 feet.	SP			
				CLAY WITH SAND mostly clay, little fine to coarse sand, few silt, gray (10YR 5/1), no odor, medium dense.	CL			
			85	Sand seam, 8 inches thick, mostly coarse sand, black (10YR 2/1) at 85.0 feet.	SP			
				CLAY WITH SAND mostly clay, little fine to coarse sand, few silt, gray (10YR 5/1), no odor, medium dense.	CL			
6 CS	100		90	Change to few to little fine to coarse sand at 90.0 feet.	CL			



WELL CONSTRUCTION LOG

WELL NO. MW-16-01

Page 3 of 3

SOIL BORING WELL CONSTRUCTION LOG 231828.0004.0000.GPJ TRC CORP.GDT 5/25/16

SAMPLE		BLOW COUNTS	DEPTH IN FEET	LITHOLOGIC DESCRIPTION	USCS	GRAPHIC LOG	WELL DIAGRAM	COMMENTS
NUMBER AND TYPE	RECOVERY (%)							
7 CS	100		95					
			100					
			105					
			110		CL			
			115					
			120	Change to soft at 120.0 feet.				
8 CS	100		125					
			130	SILTY CLAY mostly clay, some silt, very dark gray, (10YR 3/1), no odor, dry to moist, hard.	CL-ML			
9 CS	100		135	SHALE very dark gray (10YR 3/1) to light gray (10YR 7/1), no odor, moist.				
			140	End of boring at 138.0 feet below ground surface.				
			145					



WELL CONSTRUCTION LOG

WELL NO. MW-16-02

Page 1 of 3

Facility/Project Name: DTE: Saint Clair Power Plant		Date Drilling Started: 3/28/16	Date Drilling Completed: 3/28/16	Project Number: 231828.0004.0000
Drilling Firm: Stock Drilling	Drilling Method: Sonic	Surface Elev. (ft) 582.18	TOC Elevation (ft) 581.43	Total Depth (ft bgs) 138.0
Boring Location: NE side of ash basin.		Personnel Logged By - A. Knutson Driller - A. Goldsmith		Drilling Equipment: Terrasonic
N: 465503.41 E: 13632151.32		Water Level Observations: While Drilling: Date/Time After Drilling: Date/Time 4/8/16 08:38		Depth (ft bgs) Depth (ft bgs) 1.76
Civil Town/City/or Village: Saint Clair	County: Saint Clair	State: MI		

SAMPLE NUMBER AND TYPE	RECOVERY (%)	BLOW COUNTS	DEPTH IN FEET	LITHOLOGIC DESCRIPTION	USCS	GRAPHIC LOG	WELL DIAGRAM	COMMENTS
1 CS	95		5	<p>GRAVEL mostly coarse gravel, few coarse sand, black (10YR 2/1), no odor, moist, loose.</p> <p>SAND WITH GRAVEL mostly fine to coarse sand, some fine to coarse gravel, brown (10YR 5/3), no odor, moist, loose.</p> <p>CLAY mostly clay, few silt, grayish brown (10YR 5/1), no odor, moist, stiff.</p>				
			8.0	Change to soft at 8.0 feet.				
2 CS	100		10					
3 CS	100		20		CL			
4 CS	100		35					

SOIL BORING WELL CONSTRUCTION LOG 231828.0004.0000.GPJ TRC_CORP.GDT 5/25/16

Signature: *V. Knutson for A. Knutson* Firm: TRC Environmental Corporation 734.971.7080
 1540 Eisenhower Place Ann Arbor, Michigan Fax 734.971.9022

Checked By: C. Scieszka



WELL CONSTRUCTION LOG

WELL NO. MW-16-02

Page 2 of 3

SOIL BORING WELL CONSTRUCTION LOG 231828.0004.0000.GPJ TRC CORP.GDT 5/25/16

SAMPLE		BLOW COUNTS	DEPTH IN FEET	LITHOLOGIC DESCRIPTION	USCS	GRAPHIC LOG	WELL DIAGRAM	COMMENTS
NUMBER AND TYPE	RECOVERY (%)							
5 CS	100		45	Change to few silt at 45.0 feet. Change to no silt at 46.0 feet.	CL			
6 CS	100		55	SILTY CLAY mostly silt, little clay, dark grayish brown (10YR 5/3), no odor, moist, stiff.				
7 CS	100		65		CL-ML			
8 CS	100		75	Change to few fine to coarse sand at 73.5 feet. Change to no sand at 76.5 feet.				
9 CS	100		85					
			90					



WELL CONSTRUCTION LOG

WELL NO. MW-16-02

Page 3 of 3

SOIL BORING WELL CONSTRUCTION LOG 231828.0004.0000.GPJ TRC CORP.GDT 5/25/16

SAMPLE		BLOW COUNTS	DEPTH IN FEET	LITHOLOGIC DESCRIPTION	USCS	GRAPHIC LOG	WELL DIAGRAM	COMMENTS
NUMBER AND TYPE	RECOVERY (%)							
10 CS	100		95					
11 CS	100		100					
12 CS	100		110		CL-ML			
13 CS	80		125	SILTY CLAY mostly clay, some silt, very dark gray (10YR 3/1), no odor, dry, hard.	CL-ML			
14 CS	100		130	SHALE very dark gray (10YR 3/1) to light gray (10YR 7/1), no odor, moist.				
			140	End of boring at 138.0 feet below ground surface.				
			145					



WELL CONSTRUCTION LOG

WELL NO. MW-16-03

Page 1 of 3

Facility/Project Name: DTE: Saint Clair Power Plant		Date Drilling Started: 3/24/16	Date Drilling Completed: 3/24/16	Project Number: 231828.0004.0000
Drilling Firm: Stock Drilling	Drilling Method: Sonic	Surface Elev. (ft) 582.08	TOC Elevation (ft) 581.39	Total Depth (ft bgs) 138.0
Boring Location: E side of ash basin.		Personnel Logged By - J. Reed Driller - A. Goldsmith		Drilling Equipment: Terrasonic
N: 465353.06 E: 13632114.23	Civil Town/City/or Village: Saint Clair	County: Saint Clair	State: MI	Water Level Observations: While Drilling: Date/Time After Drilling: Date/Time 4/8/16 08:35 Depth (ft bgs) 2.16

SAMPLE NUMBER AND TYPE	RECOVERY (%)	BLOW COUNTS	DEPTH IN FEET	LITHOLOGIC DESCRIPTION	USCS	GRAPHIC LOG	WELL DIAGRAM	COMMENTS
1 CS	95		5	GRAVEL WITH SAND mostly gravel, some sand, black (10YR 2/1), no odor, moist, loose. SAND AND GRAVEL brown (10YR 5/3), no odor, moist, loose. CLAY mostly clay, few to little silt, grayish brown (10YR 5/2), no odor, moist, stiff.	CL			
			10	Change to medium stiff at 10.0 feet.				
			25					
			35	Change to trace to few sand at 30.0 feet. Change to no sand at 32.5 feet.				
2	100		15					
3	100		25					
4	100		35					

SOIL BORING WELL CONSTRUCTION LOG 231828.0004.0000.GPJ TRC CORP.GDT 5/25/16

Signature: *Vint E. Bruny for J. Reed* Firm: TRC Environmental Corporation 734.971.7080
 1540 Eisenhower Place Ann Arbor, Michigan Fax 734.971.9022

Checked By: C. Scieszka



WELL CONSTRUCTION LOG

WELL NO. MW-16-03

Page 2 of 3

SOIL BORING WELL CONSTRUCTION LOG 231828.0004.0000.GPJ TRC CORP.GDT 5/25/16

SAMPLE		RECOVERY (%)	BLOW COUNTS	DEPTH IN FEET	LITHOLOGIC DESCRIPTION	USCS	GRAPHIC LOG	WELL DIAGRAM	COMMENTS
NUMBER AND TYPE									
5	ST								
6	CS	100		45					
7	CS	100		55					
8	CS	100		65	SILTY CLAY mostly clay, little silt, dark grayish brown (10YR 5/2), no odor, moist, dense.	CL			
9	CS	100		75		CL-ML			
10	CS	100		85					
				90					



WELL CONSTRUCTION LOG

WELL NO. MW-16-03

Page 3 of 3

SOIL BORING WELL CONSTRUCTION LOG 231828.0004.0000.GPJ TRC CORP.GDT 5/25/16

SAMPLE		BLOW COUNTS	DEPTH IN FEET	LITHOLOGIC DESCRIPTION	USCS	GRAPHIC LOG	WELL DIAGRAM	COMMENTS
NUMBER AND TYPE	RECOVERY (%)							
11 CS	100		95					
12 CS	100		100					
13 CS	100		105					
14 CS	100		110		CL-ML			
15 CS	100		115					
			120					
			125					
			130	SILTY CLAY HARDPAN AND SHALE very dark gray (10YR 3/1), no odor, dry to slightly moist, hard.	CL-ML			
			135	SHALE very dark gray (10YR 3/1) to light gray (10YR 7/1), no odor, moist.				
			140	End of boring at 138.0 feet below ground surface.				
			145					



WELL CONSTRUCTION LOG

WELL NO. MW-16-04

Page 1 of 3

Facility/Project Name: DTE: Saint Clair Power Plant		Date Drilling Started: 3/22/16	Date Drilling Completed: 3/23/16	Project Number: 231828.0004.0000	
Drilling Firm: Stock Drilling	Drilling Method: Sonic	Surface Elev. (ft) 581.99	TOC Elevation (ft) 580.95	Total Depth (ft bgs) 138.0	Borehole Dia. (in) 6
Boring Location: SE side of ash basin. N: 465173.94 E: 13632077.11		Personnel Logged By - J. Reed Driller - A. Goldsmith		Drilling Equipment: Terrasonic	
Civil Town/City/or Village: Saint Clair	County: Saint Clair	State: MI	Water Level Observations: While Drilling: Date/Time After Drilling: Date/Time 4/8/16 08:28 Depth (ft bgs) 2.19		

SAMPLE	RECOVERY (%)	BLOW COUNTS	DEPTH IN FEET	LITHOLOGIC DESCRIPTION	USCS	GRAPHIC LOG	WELL DIAGRAM	COMMENTS
1 CS	80		5	<p>GRAVEL mostly gravel, few to little fine to coarse sand, very dark gray (10YR 3/1), no odor, moist.</p> <p>CLAY WITH SAND mostly clay, little to some fine to coarse sand, dark grayish brown (10YR 4/2), no odor, moist, medium dense.</p>	CL	CL	CL	
			10	<p>SAND WITH CLAY mostly sand, little to some clay, dark grayish brown (10YR 4/2), no odor, moist.</p> <p>CLAY WITH SAND mostly clay, little to some fine to coarse sand, medium plasticity, dark grayish brown (10YR 4/2), no odor, moist, medium dense.</p> <p>CLAY mostly clay, trace fine to medium sand, medium plasticity, grayish brown (10YR 5/2), no odor, moist, stiff.</p>	SW-SC CL	SW-SC CL	SW-SC CL	
2 CS	95		15					
3 CS	100		25	Change to medium stiff at 25.0 feet.	CL	CL	CL	
4 CS	100		35					

SOIL BORING WELL CONSTRUCTION LOG 231828.0004.0000.GPJ TRC CORP.GDT 5/25/16

Signature: <i>[Handwritten Signature]</i>	Firm: TRC Environmental Corporation 1540 Eisenhower Place Ann Arbor, Michigan	734.971.7080 Fax 734.971.9022
---	---	----------------------------------

Checked By: C. Scieszka



WELL CONSTRUCTION LOG

WELL NO. MW-16-04

SOIL BORING WELL CONSTRUCTION LOG 231828.0004.0000.GPJ TRC CORP.GDT 5/25/16

SAMPLE		BLOW COUNTS	DEPTH IN FEET	LITHOLOGIC DESCRIPTION	USCS	GRAPHIC LOG	WELL DIAGRAM	COMMENTS
NUMBER AND TYPE	RECOVERY (%)							
5 ST					CL			
6 CS	100		45	SILTY CLAY mostly clay, little to some silt, few fine to coarse sand, dark grayish brown (10YR 5/2), no odor, moist, medium stiff.	CL-ML	[Hatched pattern]	[Hatched pattern]	
7 CS	100		55					
8 CS	100		65	CLAY mostly clay, few to little silt, few fine to coarse sand, grayish brown (10YR 5/2), no odor, moist, medium stiff.	CL	[Hatched pattern]	[Hatched pattern]	
9 CS	100		75					
10 CS	100		85	Change to wet at 79.5 feet. Change to moist at 83.0 feet.				
			90					



WELL CONSTRUCTION LOG

WELL NO. MW-16-04

Page 3 of 3

SOIL BORING WELL CONSTRUCTION LOG 231828.0004.0000.GPJ TRC CORP.GDT 5/25/16

SAMPLE		BLOW COUNTS	DEPTH IN FEET	LITHOLOGIC DESCRIPTION	USCS	GRAPHIC LOG	WELL DIAGRAM	COMMENTS
NUMBER AND TYPE	RECOVERY (%)							
11 CS	100		95					
12 CS	100		100					
13 CS	100		105					
14 CS	100		110		CL			
15 CS	100		115					
			120					
			125					
			130	SILTY CLAY HARDPAN/SHALE mostly clay and silt, very dark gray (10YR 3/1), no odor, dry to moist, hard.	CL-ML			
			135	SHALE light gray (10YR 7/1) to very dark gray (10YR 3/1), no odor, dry.				
			140	End of boring at 138.0 feet below ground surface.				
			145					

TRC Laboratory Data

TRC Environmental Corporation													QC:	JPH			
Falling Head, Rising Tailwater Permeability Test (ASTM D5084, Method C)													QA:	JPH			
Project Name: DTE - SCPP BAB						Cell #:						10					
Project #: 231828.0004.0000						USCS Description:						N/A					
Sample Name: MW-16-01, 40-42'						USCS Classification:						N/A					
Visual Descript: Gray sandy lean clay, with gravel						Average Kv =						2.3E-08 cm/s					
Sample Type: Undisturbed		Initial Values		Final Values													
Sample Dia. (in)		2.86		2.83		Permeant:						Water					
Sample Ht. (in)		3.62		3.47		Permeant Specific Gravity:						1.00					
Tare & Wet (g)		470.27		763.70		Sample Specific Gravity:						2.60 Est.					
Tare & Dry (g)		373.66		604.00		Confining Pressure (psi):						100.0					
Tare (g)		88.45		89.44		Burette Diameter (in):						0.250					
Sample Wt. (g)		703.30		674.26		Burette Zero (cm):						100.0					
Moisture (%)		33.9		31.0		Max. Effect. Stress (psi):						6.2					
Wet Density (pcf)		115.2		117.7		Min. Effect. Stress (psi):						4.1					
Dry Density (pcf)		86.1		89.8		Ave. Effect. Stress (psi):						4.6					
Saturation (%)		99.4		100.0													
Yr.	Mo.	Day	Hr.	Min.	Run Time (s)	Temp C***	Pressure (psi) Bot	Pressure (psi) Top	Cham (cm)	Cham. Dif.(cm)	Bot (cm)	Bot. Dif.(cm)	Top (cm)	Top Dif.(cm)	Flow Dif.(%)	Kv *** cm/s	Ave.* 0.1
1	2016	4	22	9	23.00	0.0	95	95	13.65		2.80		101.50				
2	2016	4	22	18	33.00	33000	25.0	95	95	31.40	17.75	1.00	-1.80	91.35	10.15	-143.1	8.2E-08
3	2016	4	25	11	31.00	233880	23.0	95	95	54.55	23.15	2.00	1.00	79.25	12.10	-84.7	2.1E-08
4	2016	4	25	17	43.00	22320	24.0	95	95	55.40	0.85	2.75	0.75	78.55	0.70	3.4	2.7E-08
5	2016	4	25	20	40.00	10620	24.0	95	95	55.85	0.45	2.95	0.20	78.15	0.40	-33.3	2.3E-08
6	2016	4	25	23	16.00	9360	24.0	95	95	56.35	0.50	3.20	0.25	77.80	0.35	-16.7	2.7E-08
7	2016	4	26	5	0.00	20640	25.0	95	95	56.65	0.30	3.85	0.65	77.25	0.55	8.3	2.4E-08
8	2016	4	26	8	19.00	11940	24.0	95	95	57.55	0.90	4.00	0.15	76.70	0.55	-57.1	2.5E-08
9	2016	4	26	13	18.00	17940	24.0	95	95	58.40	0.85	4.45	0.45	76.10	0.60	-14.3	2.5E-08
10	2016	4	27	4	58.00	56400	23.0	95	95	61.65	3.25	5.45	1.00	74.05	2.05	-34.4	2.5E-08
11	2016	4	27	12	48.00	28200	23.0	95	95	62.00	0.35	6.10	0.65	73.35	0.70	-3.7	2.3E-08
12	2016	4	27	15	9.00	8460	23.0	95	95	62.00	0.00	6.30	0.20	73.05	0.30	-20.0	2.8E-08
13	2016	4	28	5	2.00	49980	22.0	95	95	65.10	3.10	6.95	0.65	71.35	1.70	-44.7	2.4E-08
14	2016	4	28	8	6.00	11040	24.0	95	95	64.75	-0.35	7.40	0.45	71.25	0.10	63.6	2.4E-08
15	2016	4	28	14	57.00	24660	23.0	95	95	65.30	0.55	7.85	0.45	70.60	0.65	-18.2	2.3E-08
16	2016	4	28	20	48.00	21060	23.0	95	95	66.25	0.95	8.30	0.45	70.00	0.60	-14.3	2.6E-08
17	2016	4	29	5	31.00	31380	26.0	95	95	68.05	1.80	8.70	0.40	69.05	0.95	-40.7	2.1E-08
18	2016	4	29	10	27.00	17760	23.0	95	95	67.10	-0.95	9.25	0.55	68.80	0.25	37.5	2.4E-08
19	2016	4	29	14	42.00	15300	23.0	95	95	67.70	0.60	9.55	0.30	68.50	0.30	0.0	2.1E-08
20	2016	4	29	18	0.00	11880	23.0	95	95	67.50	-0.20	9.90	0.35	68.35	0.15	40.0	2.3E-08
21	2016	5	1	16	24.00	167040	22.0	95	95	72.80	5.30	12.75	2.85	64.50	3.85	-14.9	2.4E-08
22	2016	5	2	4	59.00	45300	23.0	95	95	74.50	1.70	13.35	0.60	63.50	1.00	-25.0	2.2E-08
23	2016	5	2	8	5.00	11160	23.0	95	95	74.15	-0.35	13.65	0.30	63.35	0.15	33.3	2.6E-08
24	2016	5	2	13	16.00	18660	23.0	95	95	74.45	0.30	14.00	0.35	63.10	0.25	16.7	2.1E-08
25	2016	5	2	20	46.00	27000	26.0	95	95	73.50	-0.95	14.75	0.75	62.90	0.20	57.9	2.2E-08
26	2016	5	3	4	50.00	29040	23.0	95	95	74.70	1.20	15.05	0.30	62.10	0.80	-45.5	2.5E-08
**A zero in this column starts a series of measurements.													*Average Kv for those rows with a 1 in the Ave. column.				
(Termination determined by stable Kv and low flow differential.)													***Kv adjusted for temperature.				

TRC Environmental Corporation													QC:	JPH				
Falling Head, Rising Tailwater Permeability Test (ASTM D5084, Method C)													QA:	JPH				
Project Name: DTE - SCPP BAB						Cell #:						10						
Project #: 231828.0004.0000						USCS Description:						N/A						
Sample Name: MW-16-01, 40-42'						USCS Classification:						N/A						
Visual Descript: Gray sandy lean clay, with gravel																		
Sample Type: Undisturbed		Initial Values		Final Values														
Sample Dia. (in)		2.86		2.83		Permeant:						Water						
Sample Ht. (in)		3.62		3.47		Permeant Specific Gravity:						1.00						
Tare & Wet (g)		470.27		763.70		Sample Specific Gravity:						2.60 Est.						
Tare & Dry (g)		373.66		604.00		Confining Pressure (psi):						100.0						
Tare (g)		88.45		89.44		Burette Diameter (in):						0.250						
Sample Wt. (g)		703.30		674.26		Burette Zero (cm):						100.0						
Moisture (%)		33.9		31.0		Maximum Gradient:						4.7						
Wet Density (pcf)		115.2		117.7		Average Gradient:						4.5						
Dry Density (pcf)		86.1		89.8		Max. Effect. Stress (psi):						4.8						
Saturation (%)		99.4		100.0		Min. Effect. Stress (psi):						4.1						
						Ave. Effect. Stress (psi):						4.4						
1	Date	Time		Run	Temp	Pressure (psi)		Cham	Cham.	Bot	Bot.	Top	Top	Flow	Kv ***	Ave.*		
	Yr. Mo. Day	Hr. Min.	Time (s)	C°**	Bot Top	(cm)	Dif.(cm)	(cm)	Dif.(cm)	(cm)	Dif.(cm)	(cm)	Dif.(cm)	Dif.(%)	cm/s	0.1		
1	2016	5	3	4	50.00		0.0	95	95	74.70		15.05		62.10				
2	2016	5	3	8	1.00	11460	25.0	95	95	75.05	0.35	15.25	0.20	61.90	0.20	0.0	2.3E-08	
3	2016	5	3	11	11.00	11400	23.0	95	95	75.60	0.55	15.30	0.05	61.65	0.25	-66.7	1.8E-08	
4	2016	5	3	14	13.00	10920	23.0	95	95	76.00	0.40	15.50	0.20	61.45	0.20	0.0	2.5E-08	
5	2016	5	3	19	37.00	19440	24.0	95	95	76.30	0.30	15.95	0.45	61.25	0.20	38.5	2.3E-08	
6	2016	5	4	5	24.00	35220	23.0	95	95	76.70	0.40	16.45	0.50	60.65	0.60	-9.1	2.2E-08	
7	2016	5	4	9	49.00	15900	23.0	95	95	76.85	0.15	16.75	0.30	60.35	0.30	0.0	2.8E-08	
8	2016	5	4	14	51.00	18120	23.0	95	95	77.40	0.55	16.90	0.15	60.00	0.35	-40.0	2.0E-08	
9	2016	5	4	20	1.00	18600	25.0	95	95	76.85	-0.55	17.40	0.50	59.90	0.10	66.7	2.3E-08	
10	2016	5	5	5	25.00	33840	24.0	95	95	78.30	1.45	17.75	0.35	59.15	0.75	-36.4	2.4E-08	
11	2016	5	5	10	26.00	18060	24.0	95	95	78.30	0.00	18.10	0.35	58.90	0.25	16.7	2.5E-08	1
12	2016	5	5	14	42.00	15360	24.0	95	95	78.60	0.30	18.30	0.20	58.70	0.20	0.0	2.0E-08	1
13	2016	5	6	4	53.00	51060	23.0	95	95	79.30	0.70	19.10	0.80	58.00	0.70	6.7	2.4E-08	1
14	2016	5	6	9	33.00	16800	23.0	95	95	79.90	0.60	19.25	0.15	57.70	0.30	-33.3	2.2E-08	1
15																		
16																		
17																		
18																		
19																		
20																		
21																		
22																		
23																		
24																		
25																		
26																		
**A zero in this column starts a series of measurements.													*Average Kv for those rows with a 1 in the Ave. column.		2.3E-08	cm/s		
(Termination determined by stable Kv and low flow differential.)													***Kv adjusted for temperature.					

TRC Environmental Corporation													QC:	JPH			
Falling Head, Rising Tailwater Permeability Test (ASTM D5084, Method C)													QA:	JPH			
Project Name: DTE - SCPP BAB						Cell #:						11					
Project #: 231828.0004.0000						USCS Description:						N/A					
Sample Name: MW-16-02, 40-42'						USCS Classification:						N/A					
Visual Descript: Gray sandy lean clay, with gravel						Average Kv =						2.7E-08 cm/s					
Sample Type: Undisturbed		Initial Values		Final Values													
Sample Dia. (in)		2.85		2.84		Permeant: Water											
Sample Ht. (in)		2.69		2.68		Permeant Specific Gravity: 1.00											
Tare & Wet (g)		482.10		587.40		Sample Specific Gravity: 2.68 Est.											
Tare & Dry (g)		371.38		440.90		Confining Pressure (psi): 100.0											
Tare (g)		87.03		88.43		Burette Diameter (in): 0.250											
Sample Wt. (g)		507.56		498.97		Burette Zero (cm): 100.0											
Moisture (%)		38.9		41.6		Maximum Gradient: 9.0											
Wet Density (pcf)		112.8		112.0		Average Gradient: 8.3											
Dry Density (pcf)		81.2		79.1		Max. Effect. Stress (psi): 5.5											
Saturation (%)		98.4		100.0		Min. Effect. Stress (psi): 4.0											
						Ave. Effect. Stress (psi): 4.6											
Yr.	Mo.	Day	Hr.	Min.	Run Time (s)	Temp C***	Pressure (psi) Bot	Pressure (psi) Top	Cham (cm)	Cham. Dif.(cm)	Bot (cm)	Bot. Dif.(cm)	Top (cm)	Top Dif.(cm)	Flow Dif.(%)	Kv *** cm/s	Ave.* 0.1
1	2016	4	29	5	36.00	0.0	95	95	65.15		2.65		103.70				
2	2016	4	29	10	28.00	17520	23.0	95	95	67.50	2.35	3.50	0.85	102.35	1.35	-22.7	3.1E-08
3	2016	4	29	14	45.00	15420	23.0	95	95	69.50	2.00	4.40	0.90	102.40	-0.05	111.8	1.4E-08
4	2016	4	29	17	58.00	11580	23.0	95	95	70.70	1.20	5.05	0.65	102.00	0.40	23.8	2.3E-08
5	2016	5	1	16	20.00	166920	22.0	95	95	80.70	10.00	13.65	8.60	96.80	5.20	24.6	2.3E-08
6	2016	5	2	5	0.00	45600	23.0	95	95	82.70	2.00	15.70	2.05	94.70	2.10	-1.2	2.8E-08
7	2016	5	2	8	7.00	11220	23.0	95	95	83.25	0.55	16.20	0.50	94.25	0.45	5.3	2.6E-08
8	2016	5	2	13	7.00	18000	23.0	95	95	84.00	0.75	17.05	0.85	93.55	0.70	9.7	2.7E-08
9	2016	5	2	20	40.00	27180	26.0	95	95	85.60	1.60	18.20	1.15	92.50	1.05	4.5	2.5E-08
10	2016	5	3	4	51.00	29460	23.0	95	95	85.85	0.25	19.35	1.15	91.10	1.40	-9.8	2.9E-08
11	2016	5	3	8	3.00	11520	25.0	95	95	86.60	0.75	19.85	0.50	90.65	0.45	5.3	2.7E-08
12	2016	5	3	11	8.00	11100	23.0	95	95	86.60	0.00	20.30	0.45	90.15	0.50	-5.3	3.0E-08
13	2016	5	3	14	13.00	11100	23.0	95	95	87.30	0.70	20.75	0.45	89.70	0.45	0.0	2.9E-08
14	2016	5	3	19	34.00	19260	24.0	95	95	88.25	0.95	21.55	0.80	89.15	0.55	18.5	2.5E-08
15	2016	5	4	5	25.00	35460	23.0	95	95	89.35	1.10	22.85	1.30	87.75	1.40	-3.7	2.8E-08
16	2016	5	4	9	50.00	15900	23.0	95	95	89.70	0.35	23.45	0.60	87.20	0.55	4.3	2.8E-08
17	2016	5	4	14	52.00	18120	23.0	95	95	90.20	0.50	24.10	0.65	86.55	0.65	0.0	2.8E-08
18	2016	5	4	19	58.00	18360	25.0	95	95	91.10	0.90	24.80	0.70	86.00	0.55	12.0	2.6E-08
19	2016	5	5	5	26.00	34080	24.0	95	95	91.75	0.65	25.95	1.15	84.75	1.25	-4.2	2.8E-08
20	2016	5	5	10	27.00	18060	24.0	95	95	92.40	0.65	26.50	0.55	84.20	0.55	0.0	2.5E-08
21	2016	5	5	14	43.00	15360	24.0	95	95	92.80	0.40	27.05	0.55	83.70	0.50	4.8	2.9E-08
22	2016	5	6	4	53.00	51000	23.0	95	95	84.30	-8.50	28.70	1.65	82.15	1.55	3.1	2.8E-08
23	2016	5	6	9	34.00	16860	23.0	95	95	94.70	10.40	29.20	0.50	81.65	0.50	0.0	2.8E-08
24																	
25																	
26																	
**A zero in this column starts a series of measurements.													*Average Kv for those rows with a 1 in the Ave. column.		2.7E-08 cm/s		
(Termination determined by stable Kv and low flow differential.)													***Kv adjusted for temperature.				

TRC Environmental Corporation													QC:	JPH			
Falling Head, Rising Tailwater Permeability Test (ASTM D5084, Method C)													QA:	JPH			
Project Name: DTE - SCPP BAB						Cell #:						2					
Project #: 231828.0004.0000						USCS Description:						N/A					
Sample Name: MW-16-03, 40-42'						USCS Classification:						N/A					
Visual Descript: Gray sandy lean clay, with gravel						Average Kv =						2.9E-08 cm/s					
Sample Type: Undisturbed		Initial Values		Final Values													
Sample Dia. (in)		2.86		2.83		Permeant: Water											
Sample Ht. (in)		2.90		2.85		Permeant Specific Gravity: 1.00											
Tare & Wet (g)		474.40		611.40		Sample Specific Gravity: 2.70 Est.											
Tare & Dry (g)		351.87		453.40		Confining Pressure (psi): 100.0											
Tare (g)		86.27		88.02		Burette Diameter (in): 0.250											
Sample Wt. (g)		535.23		523.38		Burette Zero (cm): 100.0											
Moisture (%)		46.1		43.2		Maximum Gradient: 7.7											
Wet Density (pcf)		109.4		111.2		Average Gradient: 7.3											
Dry Density (pcf)		74.9		77.6		Max. Effect. Stress (psi): 5.5											
Saturation (%)		99.8		100.0		Min. Effect. Stress (psi): 3.8											
						Ave. Effect. Stress (psi): 4.3											
Yr.	Mo.	Day	Hr.	Min.	Run Time (s)	Temp C***	Pressure (psi) Bot	Pressure (psi) Top	Cham (cm)	Cham. Dif.(cm)	Bot (cm)	Bot. Dif.(cm)	Top (cm)	Top Dif.(cm)	Flow Dif.(%)	Kv *** cm/s	Ave.* 0.1
1	2016	4	29	5	39.00	0.0	95	95	71.90		3.05		103.70				
2	2016	4	29	10	29.00	17400	23.0	95	95	74.80	2.90	3.25	0.20	100.00	3.70	-89.7	6.0E-08
3	2016	4	29	14	46.00	15420	23.0	95	95	77.30	2.50	3.70	0.45	98.60	1.40	-51.4	3.3E-08
4	2016	4	29	17	59.00	11580	23.0	95	95	78.70	1.40	4.15	0.45	97.75	0.85	-30.8	3.1E-08
5	2016	5	1	16	21.00	166920	22.0	95	95	90.30	11.60	11.25	7.10	89.20	8.55	-9.3	3.0E-08
6	2016	5	2	5	1.00	45600	23.0	95	95	92.75	2.45	13.05	1.80	87.30	1.90	-2.7	2.8E-08
7	2016	5	2	8	7.00	11160	23.0	95	95	93.70	0.95	13.40	0.35	86.80	0.50	-17.6	2.7E-08
8	2016	5	2	13	8.00	18060	23.0	95	95	94.25	0.55	14.20	0.80	86.20	0.60	14.3	2.8E-08
9	2016	5	2	20	42.00	27240	26.0	95	95	96.15	1.90	15.25	1.05	85.20	1.00	2.6	2.6E-08
10	2016	5	3	4	52.00	29400	23.0	95	95	95.60	-0.55	16.20	0.95	83.85	1.35	-17.5	3.0E-08
11	2016	5	3	8	3.00	11460	25.0	95	95	96.60	1.00	16.60	0.40	83.45	0.40	0.0	2.6E-08
12	2016	5	3	11	9.00	11160	23.0	95	95	96.20	-0.40	17.10	0.50	82.95	0.50	0.0	3.6E-08
13	2016	5	3	14	14.00	11100	23.0	95	95	97.05	0.85	17.35	0.25	82.55	0.40	-23.1	2.4E-08
14	2016	5	3	19	34.00	19200	24.0	95	95	98.70	1.65	18.10	0.75	82.00	0.55	15.4	2.7E-08
15	2016	5	4	5	26.00	35520	23.0	95	95	99.75	1.05	19.25	1.15	80.70	1.30	-6.0	2.9E-08
16	2016	5	4	9	50.00	15840	23.0	95	95	100.30	0.55	19.80	0.55	80.20	0.50	4.5	2.9E-08
17	2016	5	4	14	52.00	18120	23.0	95	95	100.60	0.30	20.30	0.50	79.55	0.65	-13.0	2.8E-08
18	2016	5	4	19	59.00	18420	25.0	95	95	101.75	1.15	21.00	0.70	79.10	0.45	21.7	2.7E-08
19	2016	5	5	5	26.00	34020	24.0	95	95	102.60	0.85	21.90	0.90	77.85	1.25	-16.3	2.8E-08
20	2016	5	5	10	27.00	18060	24.0	95	95	103.20	0.60	22.50	0.60	77.35	0.50	9.1	2.8E-08
21	2016	5	5	14	43.00	15360	24.0	95	95	103.50	0.30	22.95	0.45	76.85	0.50	-5.3	2.9E-08
22	2016	5	6	4	54.00	51060	23.0	95	95	104.00	0.50	24.35	1.40	75.40	1.45	-1.8	2.8E-08
23	2016	5	6	9	35.00	16860	23.0	95	95	105.00	1.00	24.80	0.45	74.90	0.50	-5.3	2.9E-08
24																	
25																	
26	**A zero in this column starts a series of measurements. (Termination determined by stable Kv and low flow differential.)													*Average Kv for those rows with a 1 in the Ave. column. 2.9E-08 cm/s			
													***Kv adjusted for temperature.				

TRC Environmental Corporation													QC:	JPH				
Falling Head, Rising Tailwater Permeability Test (ASTM D5084, Method C)													QA:	JPH				
Project Name: DTE - SCPP BAB						Cell #:						3						
Project #: 231828.0004.0000						USCS Description:						N/A						
Sample Name: MW-16-04, 40-42'						USCS Classification:						N/A						
Visual Descript: Gray sandy lean clay, with gravel						Average Kv =						3.1E-08 cm/s						
Sample Type: Undisturbed		Initial Values		Final Values														
Sample Dia. (in)		2.85		2.82		Permeant: Water												
Sample Ht. (in)		2.88		2.84		Permeant Specific Gravity: 1.00												
Tare & Wet (g)		561.80		656.70		Sample Specific Gravity: 2.63 Est.												
Tare & Dry (g)		460.60		537.10		Confining Pressure (psi): 100.0												
Tare (g)		95.90		87.80		Burette Diameter (in): 0.250												
Sample Wt. (g)		580.00		568.90		Burette Zero (cm): 100.0												
Moisture (%)		27.7		26.6		Maximum Gradient: 7.7												
Wet Density (pcf)		120.5		122.2		Average Gradient: 7.3												
Dry Density (pcf)		94.3		96.5		Max. Effect. Stress (psi): 5.5												
Saturation (%)		98.7		100.0		Min. Effect. Stress (psi): 4.0												
						Ave. Effect. Stress (psi): 4.6												
Yr.	Mo.	Day	Hr.	Min.	Run Time (s)	Temp C°**	Pressure (psi) Bot	Pressure (psi) Top	Cham (cm)	Cham. Dif.(cm)	Bot (cm)	Bot. Dif.(cm)	Top (cm)	Top Dif.(cm)	Flow Dif.(%)	Kv *** cm/s	Ave.* 0.1	
1	2016	4	29	5	41.00	0.0	95	95	66.60		1.60		104.80					
2	2016	4	29	10	30.00	17340	23.0	95	95	68.30	1.70	2.15	0.55	101.80	3.00	-69.0	5.3E-08	
3	2016	4	29	14	47.00	15420	23.0	95	95	69.60	1.30	2.90	0.75	100.80	1.00	-14.3	3.0E-08	
4	2016	4	29	17	59.00	11520	23.0	95	95	70.60	1.00	3.50	0.60	100.15	0.65	-4.0	2.9E-08	
5	2016	5	1	16	21.00	166920	22.0	95	95	77.85	7.25	11.95	8.45	91.30	8.85	-2.3	3.2E-08	
6	2016	5	2	5	2.00	45660	23.0	95	95	79.40	1.55	13.95	2.00	89.10	2.20	-4.8	3.1E-08	
7	2016	5	2	8	8.00	11160	23.0	95	95	80.15	0.75	14.40	0.45	88.65	0.45	0.0	2.8E-08	
8	2016	5	2	13	9.00	18060	23.0	95	95	80.40	0.25	15.25	0.85	88.00	0.65	13.3	3.0E-08	
9	2016	5	2	20	43.00	27240	26.0	95	95	81.60	1.20	16.40	1.15	86.95	1.05	4.5	2.8E-08	
10	2016	5	3	4	52.00	29340	23.0	95	95	80.60	-1.00	17.50	1.10	85.50	1.45	-13.7	3.3E-08	
11	2016	5	3	8	2.00	11400	25.0	95	95	81.25	0.65	18.00	0.50	85.10	0.40	11.1	2.9E-08	
12	2016	5	3	11	9.00	11220	23.0	95	95	80.75	-0.50	18.40	0.40	84.60	0.50	-11.1	3.2E-08	
13	2016	5	3	14	15.00	11160	23.0	95	95	81.55	0.80	18.85	0.45	84.15	0.45	0.0	3.2E-08	
14	2016	5	3	19	35.00	19200	24.0	95	95	82.95	1.40	19.60	0.75	83.60	0.55	15.4	2.7E-08	
15	2016	5	4	5	26.00	35460	23.0	95	95	83.40	0.45	20.90	1.30	82.20	1.40	-3.7	3.2E-08	
16	2016	5	4	9	50.00	15840	23.0	95	95	83.70	0.30	21.40	0.50	81.60	0.60	-9.1	3.0E-08	
17	2016	5	4	14	53.00	18180	23.0	95	95	83.80	0.10	22.05	0.65	80.95	0.65	0.0	3.2E-08	
18	2016	5	4	19	59.00	18360	25.0	95	95	84.80	1.00	22.80	0.75	80.50	0.45	25.0	2.8E-08	
19	2016	5	5	5	27.00	34080	24.0	95	95	85.10	0.30	23.85	1.05	79.20	1.30	-10.6	3.1E-08	
20	2016	5	5	10	28.00	18060	24.0	95	95	85.60	0.50	24.45	0.60	78.65	0.55	4.3	3.0E-08	1
21	2016	5	5	14	44.00	15360	24.0	95	95	85.80	0.20	25.00	0.55	78.25	0.40	15.8	3.0E-08	1
22	2016	5	6	4	55.00	51060	23.0	95	95	86.70	0.90	26.50	1.50	76.75	1.50	0.0	3.0E-08	1
23	2016	5	6	9	35.00	16800	23.0	95	95	87.20	0.50	27.00	0.50	76.15	0.60	-9.1	3.5E-08	1
24																		
25																		
26	**A zero in this column starts a series of measurements.													*Average Kv for those rows with a 1 in the Ave. column.		3.1E-08 cm/s		
(Termination determined by stable Kv and low flow differential.)													***Kv adjusted for temperature.					

TRC 2016 Monitoring Well Logs & Data



WELL CONSTRUCTION DIAGRAM

PROJ. NAME: DTE EC: SCPP CCR MW Installation	WELL ID: MW-16-01
PROJ. NO: 2381828.0004	DATE INSTALLED: 3/31/2016 INSTALLED BY: J. REED CHECKED BY: C. SCIESZKA

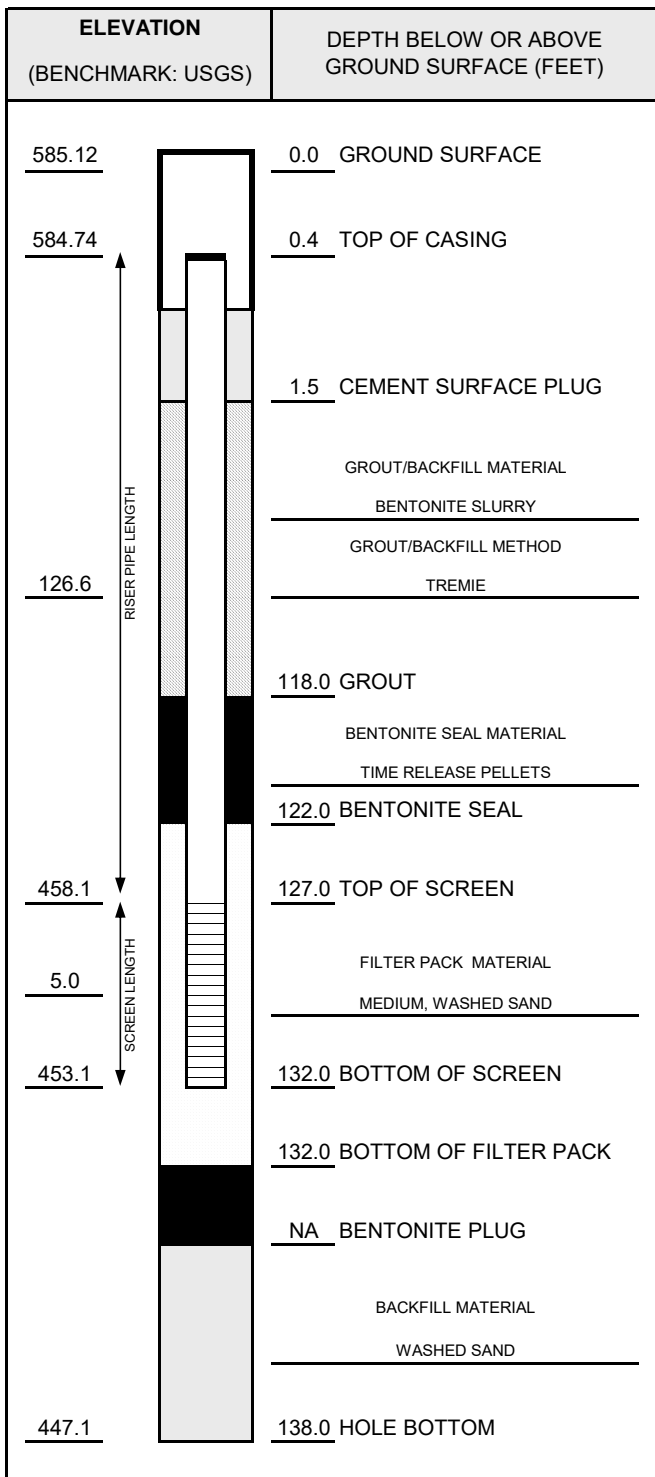

NOTES:

CASING AND SCREEN DETAILS	
TYPE OF RISER:	<u>2-INCH PVC</u>
PIPE SCHEDULE:	<u>40</u>
PIPE JOINTS:	<u>THREADED O-RINGS</u>
SCREEN TYPE:	<u>2-INCH PVC</u>
SCR. SLOT SIZE:	<u>0.01-INCH</u>
BOREHOLE DIAMETER:	<u>6</u> IN. FROM <u>0</u> TO <u>138</u> FT. <u> </u> IN. FROM <u> </u> TO <u> </u> FT.
SURF. CASING DIAMETER:	<u> </u> IN. FROM <u> </u> TO <u> </u> FT. <u> </u> IN. FROM <u> </u> TO <u> </u> FT.

WELL DEVELOPMENT	
DEVELOPMENT METHOD:	<u>SURGE AND PUMP</u>
TIME DEVELOPING:	<u>2.5</u> HOURS
WATER REMOVED:	<u>50</u> GALLONS
WATER ADDED:	<u>NA</u> GALLONS
WATER CLARITY BEFORE / AFTER DEVELOPMENT	
CLARITY BEFORE:	<u>CLOUDY</u>
COLOR BEFORE:	<u>GRAY</u>
CLARITY AFTER:	<u>SLIGHTLY CLOUDY</u>
COLOR AFTER:	<u>CLEAR TO VERY LIGHT GRAY</u>
ODOR (IF PRESENT):	<u>NONE</u>

WATER LEVEL SUMMARY				
	MEASUREMENT (FEET)		DATE	TIME
DTB BEFORE DEVELOPING:	132.00	T/PVC	4/5/16	940
DTB AFTER DEVELOPING:	132.00	T/PVC	4/5/16	1420
SWL BEFORE DEVELOPING:	--	T/PVC	--	--
SWL AFTER DEVELOPING:	13.70	T/PVC	4/8/16	828
OTHER SWL:		T/PVC		
OTHER SWL:		T/PVC		

PROTECTIVE CASING DETAILS	
PERMANENT, LEGIBLE WELL LABEL ADDED?	<input checked="" type="checkbox"/> YES <input type="checkbox"/> NO
PROTECTIVE COVER AND LOCK INSTALLED?	<input checked="" type="checkbox"/> YES <input type="checkbox"/> NO
LOCK KEY NUMBER:	<u>3120</u>



WELL CONSTRUCTION DIAGRAM

PROJ. NAME: DTE EC: SCPP CCR MW Installation	WELL ID: MW-16-02
PROJ. NO: 2381828.0004	DATE INSTALLED: 3/29/2016 INSTALLED BY: A. Knutson
CHECKED BY: C. SCIESZKA	

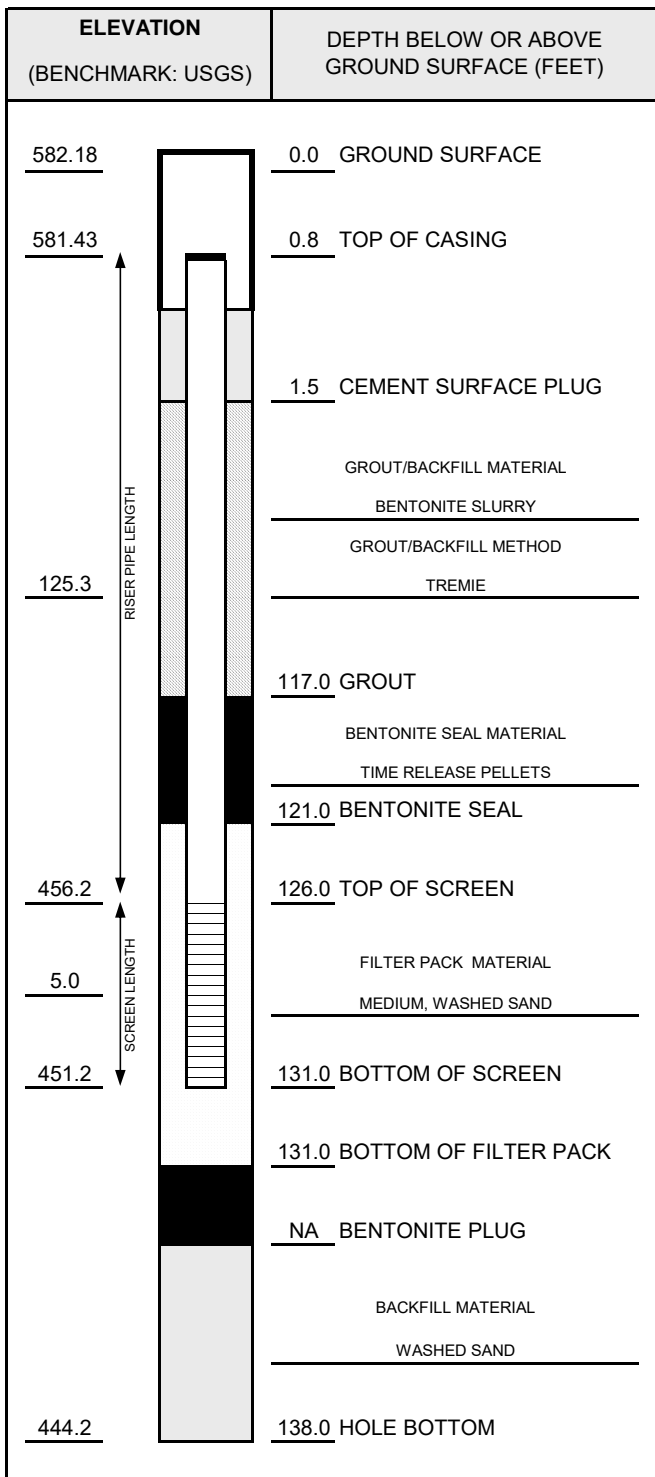

NOTES:

CASING AND SCREEN DETAILS	
TYPE OF RISER:	<u>2-INCH PVC</u>
PIPE SCHEDULE:	<u>40</u>
PIPE JOINTS:	<u>THREADED O-RINGS</u>
SCREEN TYPE:	<u>2-INCH PVC</u>
SCR. SLOT SIZE:	<u>0.01-INCH</u>
BOREHOLE DIAMETER:	<u>6</u> IN. FROM <u>0</u> TO <u>138</u> FT.
	<u> </u> IN. FROM <u> </u> TO <u> </u> FT.
SURF. CASING DIAMETER:	<u> </u> IN. FROM <u> </u> TO <u> </u> FT.
	<u> </u> IN. FROM <u> </u> TO <u> </u> FT.

WELL DEVELOPMENT	
DEVELOPMENT METHOD:	<u>SURGE AND PUMP</u>
TIME DEVELOPING:	<u>2.5</u> HOURS
WATER REMOVED:	<u>55</u> GALLONS
WATER ADDED:	<u>NA</u> GALLONS
WATER CLARITY BEFORE / AFTER DEVELOPMENT	
CLARITY BEFORE:	<u>CLOUDY</u>
COLOR BEFORE:	<u>GRAY</u>
CLARITY AFTER:	<u>SLIGHTLY CLOUDY</u>
COLOR AFTER:	<u>CLEAR TO VERY LIGHT GRAY</u>
ODOR (IF PRESENT):	<u>NONE</u>

WATER LEVEL SUMMARY				
	MEASUREMENT (FEET)		DATE	TIME
DTB BEFORE DEVELOPING:	131.90	T/PVC	4/4/16	--
DTB AFTER DEVELOPING:	132.00	T/PVC	4/4/16	--
SWL BEFORE DEVELOPING:	1.40	T/PVC	4/4/16	--
SWL AFTER DEVELOPING:	1.10	T/PVC	4/8/16	838
OTHER SWL:		T/PVC		
OTHER SWL:		T/PVC		

PROTECTIVE CASING DETAILS	
PERMANENT, LEGIBLE WELL LABEL ADDED?	<input checked="" type="checkbox"/> YES <input type="checkbox"/> NO
PROTECTIVE COVER AND LOCK INSTALLED?	<input checked="" type="checkbox"/> YES <input type="checkbox"/> NO
LOCK KEY NUMBER:	<u>3120</u>



WELL CONSTRUCTION DIAGRAM

PROJ. NAME: DTE EC: SCPP CCR MW Installation	WELL ID: MW-16-03
PROJ. NO: 2381828.0004	DATE INSTALLED: 3/25/2016 INSTALLED BY: J. Reed CHECKED BY: C. SCIESZKA

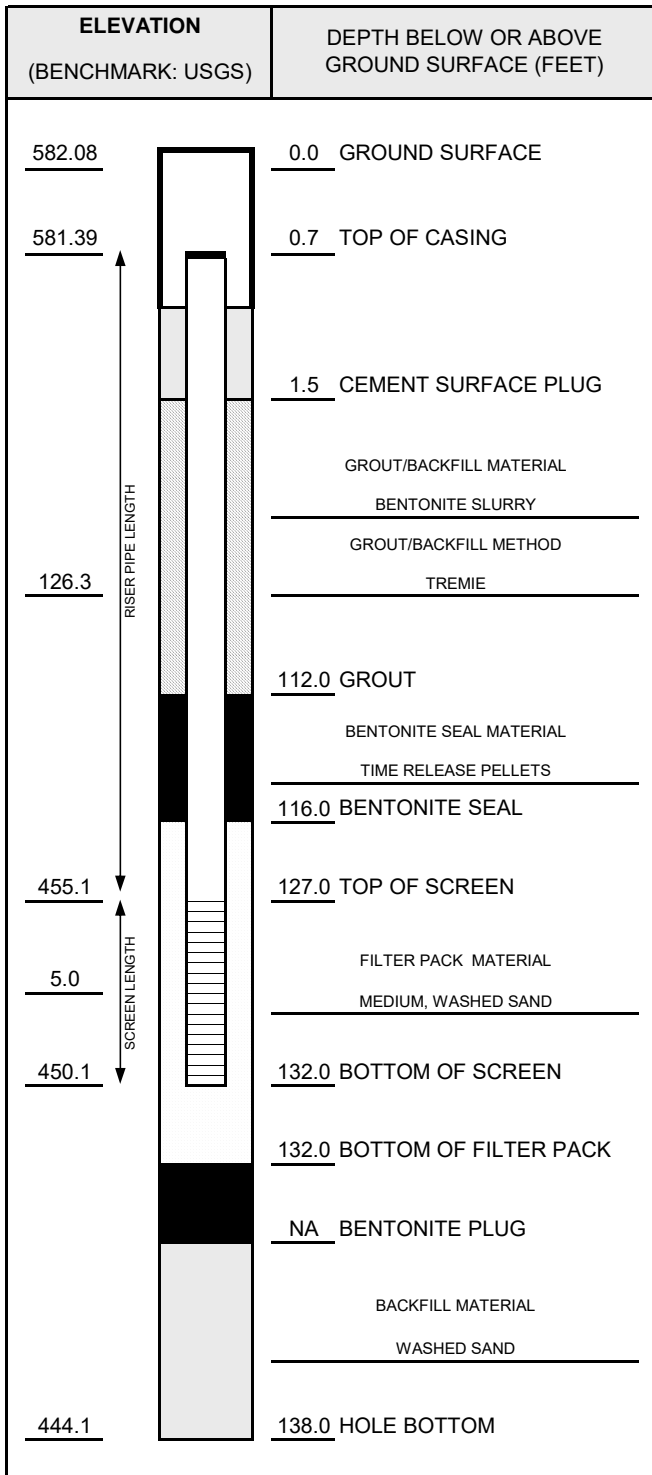

CASING AND SCREEN DETAILS	
TYPE OF RISER:	<u>2-INCH PVC</u>
PIPE SCHEDULE:	<u>40</u>
PIPE JOINTS:	<u>THREADED O-RINGS</u>
SCREEN TYPE:	<u>2-INCH PVC</u>
SCR. SLOT SIZE:	<u>0.01-INCH</u>
BOREHOLE DIAMETER:	<u>6</u> IN. FROM <u>0</u> TO <u>138</u> FT. <u> </u> IN. FROM <u> </u> TO <u> </u> FT.
SURF. CASING DIAMETER:	<u> </u> IN. FROM <u> </u> TO <u> </u> FT. <u> </u> IN. FROM <u> </u> TO <u> </u> FT.

WELL DEVELOPMENT	
DEVELOPMENT METHOD:	<u>SURGE AND PUMP</u>
TIME DEVELOPING:	<u>4</u> HOURS
WATER REMOVED:	<u>74</u> GALLONS
WATER ADDED:	<u>NA</u> GALLONS
WATER CLARITY BEFORE / AFTER DEVELOPMENT	
CLARITY BEFORE:	<u>CLOUDY/SUSPENDED SAND</u>
COLOR BEFORE:	<u>GRAY</u>
CLARITY AFTER:	<u>SLIGHTLY CLOUDY</u>
COLOR AFTER:	<u>VERY LIGHT GRAY TO CLEAR</u>
ODOR (IF PRESENT):	<u>NONE</u>

WATER LEVEL SUMMARY				
	MEASUREMENT (FEET)		DATE	TIME
DTB BEFORE DEVELOPING:	123.40	T/PVC	4/4/16	950
DTB AFTER DEVELOPING:	132.00	T/PVC	4/4/16	1420
SWL BEFORE DEVELOPING:	1.00	T/PVC	4/4/16	950
SWL AFTER DEVELOPING:	1.47	T/PVC	4/8/16	835
OTHER SWL:		T/PVC		
OTHER SWL:		T/PVC		

NOTES:
APPROXIMATELY 8.6 FEET OF MEDIUM, WASHED SAND WAS UNINTENTIONALLY PLACED IN WELL DURING INSTALLATION. THE SAND WAS REMOVED DURING WELL DEVELOPMENT.

PROTECTIVE CASING DETAILS	
PERMANENT, LEGIBLE WELL LABEL ADDED?	<input checked="" type="checkbox"/> YES <input type="checkbox"/> NO
PROTECTIVE COVER AND LOCK INSTALLED?	<input checked="" type="checkbox"/> YES <input type="checkbox"/> NO
LOCK KEY NUMBER:	<u>3120</u>



WELL CONSTRUCTION DIAGRAM

PROJ. NAME: DTE EC: SCPP CCR MW Installation	WELL ID: MW-16-04
PROJ. NO: 2381828.0004	DATE INSTALLED: 3/23/2016 INSTALLED BY: J. Reed
CHECKED BY: C. SCIESZKA	

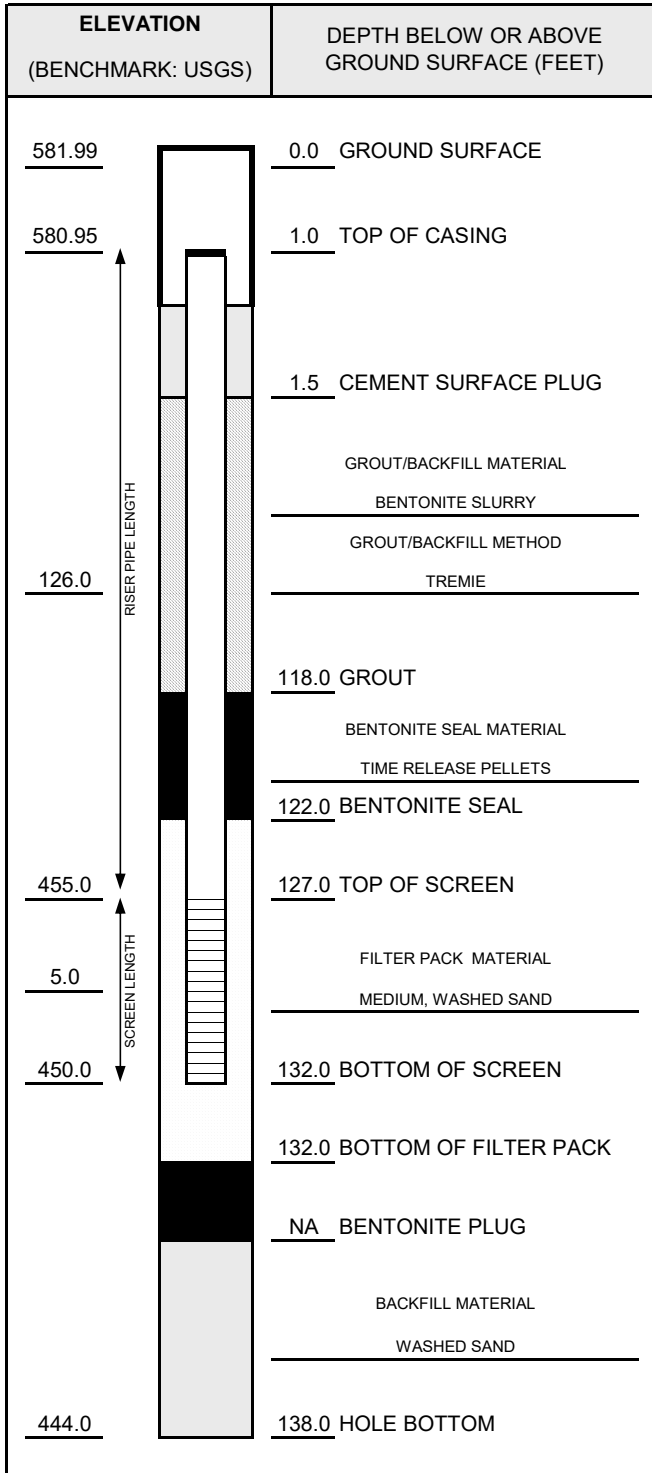

CASING AND SCREEN DETAILS	
TYPE OF RISER:	<u>2-INCH PVC</u>
PIPE SCHEDULE:	<u>40</u>
PIPE JOINTS:	<u>THREADED O-RINGS</u>
SCREEN TYPE:	<u>2-INCH PVC</u>
SCR. SLOT SIZE:	<u>0.01-INCH</u>
BOREHOLE DIAMETER:	<u>6</u> IN. FROM <u>0</u> TO <u>138</u> FT. <u> </u> IN. FROM <u> </u> TO <u> </u> FT.
SURF. CASING DIAMETER:	<u> </u> IN. FROM <u> </u> TO <u> </u> FT. <u> </u> IN. FROM <u> </u> TO <u> </u> FT.

WELL DEVELOPMENT	
DEVELOPMENT METHOD:	<u>SURGE AND PUMP</u>
TIME DEVELOPING:	<u>2</u> HOURS
WATER REMOVED:	<u>40</u> GALLONS
WATER ADDED:	<u>NA</u> GALLONS
WATER CLARITY BEFORE / AFTER DEVELOPMENT	
CLARITY BEFORE:	<u>CLOUDY/GRAY</u>
COLOR BEFORE:	<u>GRAY</u>
CLARITY AFTER:	<u>SLIGHTLY CLOUDY</u>
COLOR AFTER:	<u>LIGHT GRAY</u>
ODOR (IF PRESENT):	<u>NONE</u>

WATER LEVEL SUMMARY				
	MEASUREMENT (FEET)		DATE	TIME
DTB BEFORE DEVELOPING:	133.10	T/PVC	4/4/16	945
DTB AFTER DEVELOPING:	132.00	T/PVC	4/4/16	1700
SWL BEFORE DEVELOPING:	1.01	T/PVC	4/4/16	945
SWL AFTER DEVELOPING:	1.15	T/PVC	4/8/16	828
OTHER SWL:		T/PVC		
OTHER SWL:		T/PVC		

PROTECTIVE CASING DETAILS	
PERMANENT, LEGIBLE WELL LABEL ADDED?	<input checked="" type="checkbox"/> YES <input type="checkbox"/> NO
PROTECTIVE COVER AND LOCK INSTALLED?	<input checked="" type="checkbox"/> YES <input type="checkbox"/> NO
LOCK KEY NUMBER:	<u>3120</u>

NOTES:

Table 1
 Summary of Groundwater Elevation Data –May and September 2020
 St. Clair Power Plant Bottom Ash Basins – RCRA CCR Monitoring Program
 East China Township, Michigan

	MP-01		MW-16-01		MW-16-02		MW-16-03		MW-16-04	
Date Installed	3/23/2016		3/31/2016		3/29/2016		3/25/2016		3/23/2016	
TOC Elevation	580.84 ⁽¹⁾		584.74		581.43		581.39		580.95	
Geologic Unit of Screened Interval	NA		Silty Clay Shale Interface		Silty Clay Shale Interface		Silty Clay/Hardpan Shale Interface		Silty Clay/Hardpan Shale Interface	
Screened Interval Elevation	NA		458.1 to 453.1		456.2 to 451.2		455.1 to 450.1		455.0 to 450.0	
Unit	ft BTOC	ft	ft BTOC	ft	ft BTOC	ft	ft BTOC	ft	ft BTOC	ft
Measurement Date	Depth to Water	Surface Water Elevation	Depth to Water	GW Elevation	Depth to Water	GW Elevation	Depth to Water	GW Elevation	Depth to Water	GW Elevation
05/05/2020	2.35	578.49	3.21	581.53	1.54	579.89	1.61	579.78	1.09	579.86
9/14/2020	NM	579.21 ⁽²⁾	3.25	581.49	1.30	580.13	1.10	580.29	0.85	580.10

Notes:

Elevations are reported in feet relative to the North American Vertical Datum of 1988.

ft BTOC - feet below top of casing

NA - not applicable





1) Elevation represents the point of reference used to collect surface water level measurements.

2) Surface water elevation taken from NOAA/National Oceanic St.Clair River gauging station, St.Clair, MI (ID: 901480).

TRC Cross Sections





LEGEND

-  DOWN-GRADIENT WELL
-  UP-GRADIENT WELL
-  RIVER LEVEL MONITORING POINT
-  CROSS SECTIONS

NOTES

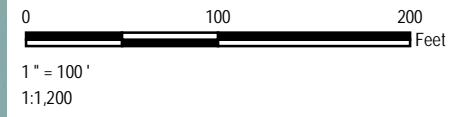
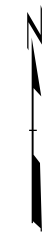
1. BASE MAP IMAGERY FROM GOOGLE EARTH PRO & PARTNERS, APRIL 2015.
2. WELL LOCATIONS SURVEYED BY BMJ ENGINEERS AND SURVEYORS INC. IN APRIL 2016.



PROJECT:		DTE ELECTRIC COMPANY ST. CLAIR POWER PLANT 4901 POINTE DRIVE CHINA TOWNSHIP, MICHIGAN	
TITLE:		CROSS-SECTION LOCATOR MAP	
DRAWN BY:	B DEEGAN	PROJ NO.:	254222.0004
CHECKED BY:	S.HOLMSTROM	FIGURE B-1	
APPROVED BY:	V.BUENING		
DATE:	FEBRUARY 2017		
		1540 Eisenhower Place Ann Arbor, MI 48108-3284 Phone: 734.971.7080 www.trcsolutions.com	
FILE NO.:		254222-0004-002.mxd	

GENERALIZED GEOLOGIC CROSS-SECTION A-A'

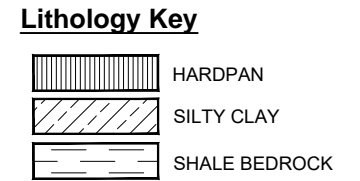
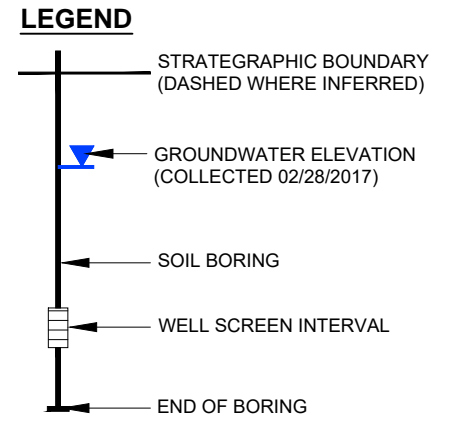
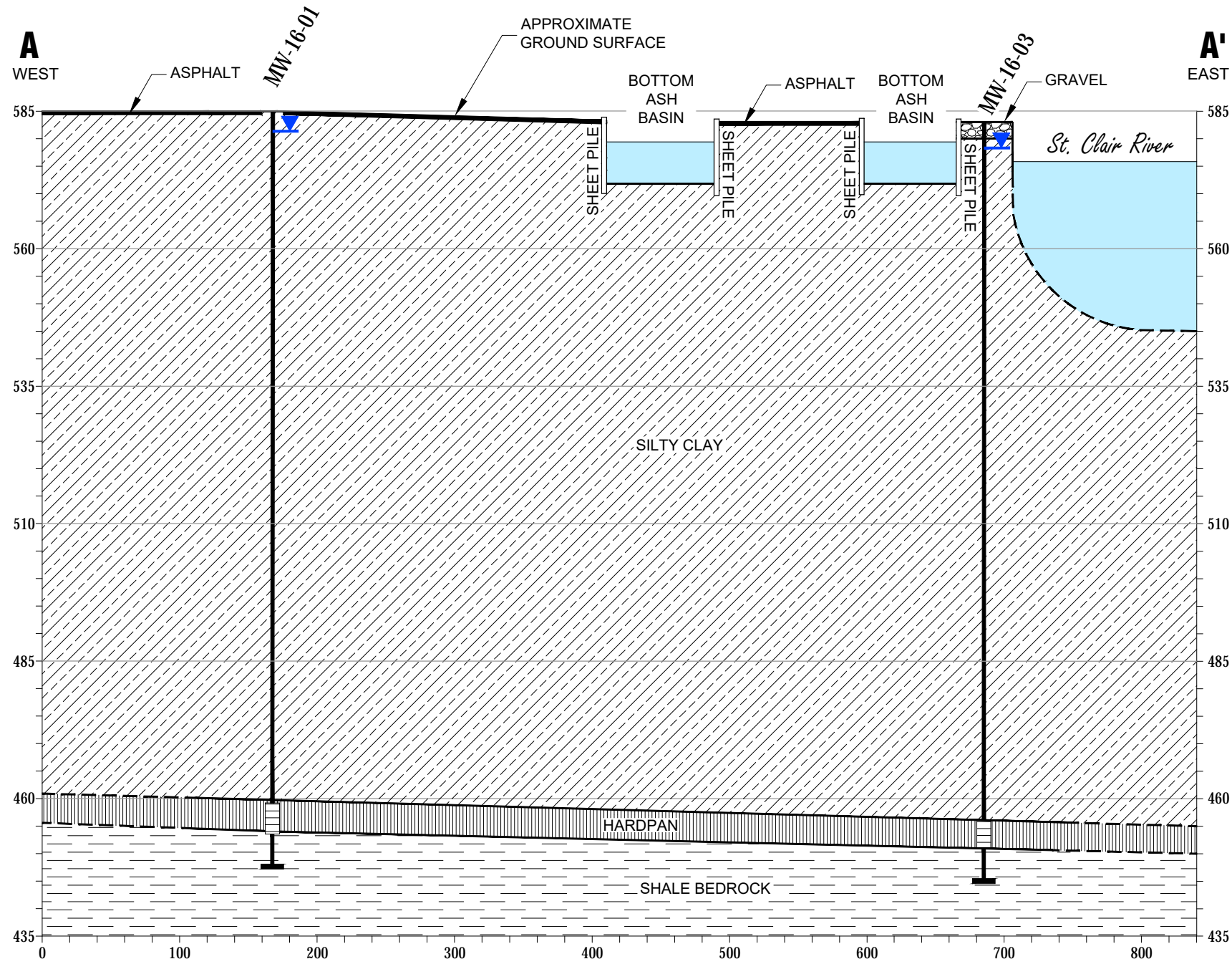

Basin Sheet Pile Lengths and Basin Depths Shown on This Figure are Not Current. See Project Drawings and Attachment 6 for Current Information.

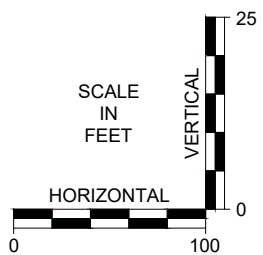

PROJECT:		DTE ELECTRIC COMPANY ST. CLAIR POWER PLANT EAST CHINA TOWNSHIP, MICHIGAN	
TITLE:		GENERALIZED GEOLOGIC CROSS-SECTION A-A'	
DRAWN BY:	D. STEHLE	PROJ NO.:	265996.0004.01.01
CHECKED BY:	S. HOLMSTROM	FIGURE B-2	
APPROVED BY:	V. BUENING		
DATE:	SEPTEMBER 2017		
		1540 Eisenhower Place Ann Arbor, MI 48108 Phone: 734.971.7080 www.trcsolutions.com	
FILE NO.:		265996.0004.01.01.04-05.dwg	

11x17 --- ATTACHED XREFS: --- ATTACHED IMAGES: --- PLOT DATE: October 12, 2017 - 12:02PM --- LAYOUT: FIG04 XS AA
 DRAWING NAME: F:\TRC\DESIGN\St Clair\PP\265996\0004\01\265996.0004.01.01.04-05.dwg

GENERALIZED GEOLOGIC CROSS-SECTION B-B'

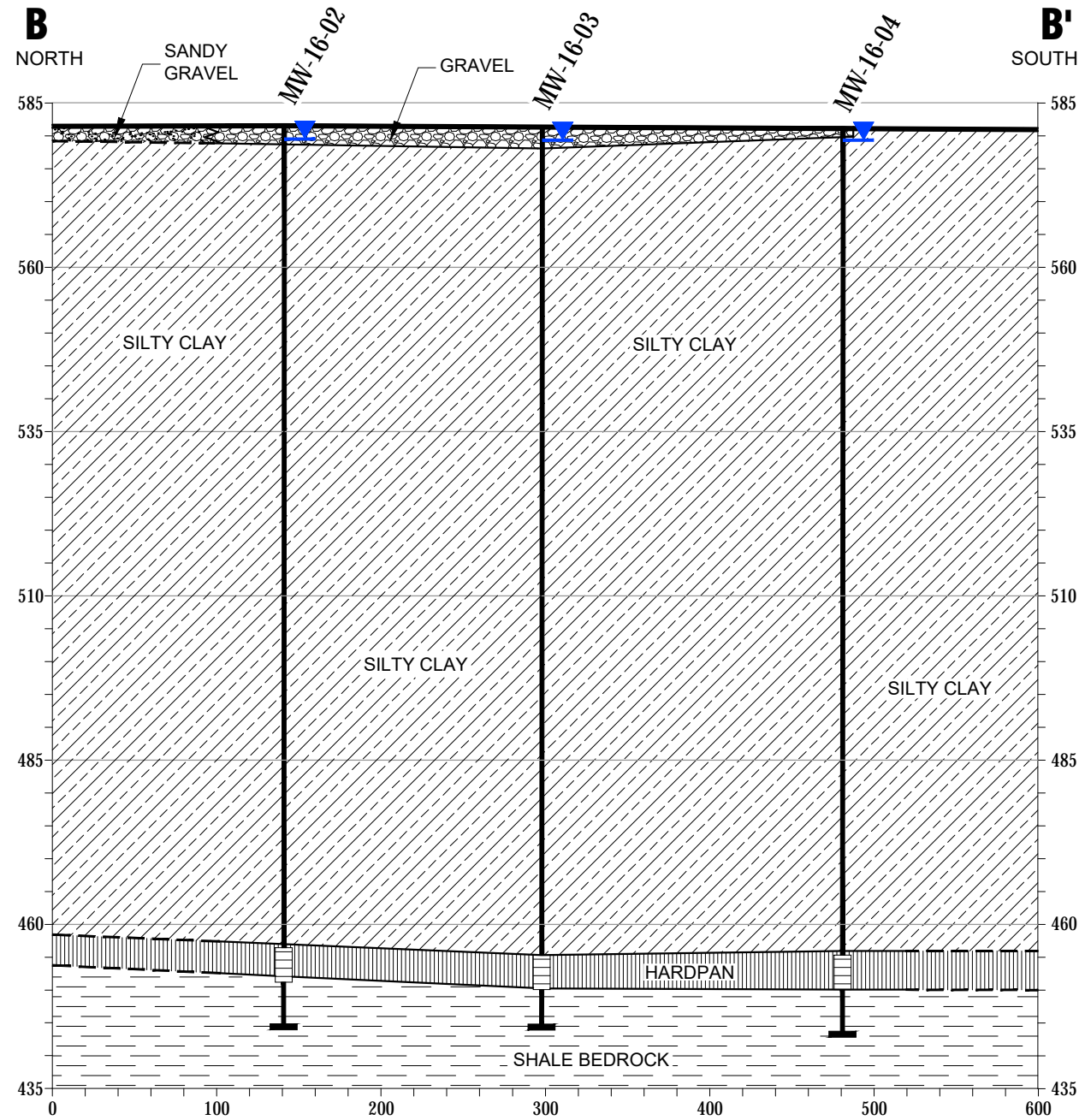

LEGEND

- STRATIGRAPHIC BOUNDARY (DASHED WHERE INFERRED)
- ▲ GROUNDWATER ELEVATION (COLLECTED 02/28/2017)
- SOIL BORING
- ▨ WELL SCREEN INTERVAL
- └ END OF BORING

Lithology Key

- ▨ HARDPAN
- ▨ SILTY CLAY
- ▨ SHALE BEDROCK
- ▨ GRAVEL
- ▨ SANDY GRAVEL

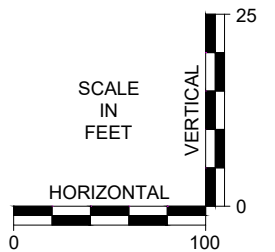

11x17 --- ATTACHED XREFS: --- ATTACHED IMAGES: --- PLOT DATE: October 12, 2017 - 12:03PM --- LAYOUT: FIG05 XS.BB
 DRAWING NAME: F:\TRC\DESIGN\St.Clair\PP\265996\0004\01\265996.0004.01.01.04-05.dwg

PROJECT:		DTE ELECTRIC COMPANY ST. CLAIR POWER PLANT EAST CHINA TOWNSHIP, MICHIGAN	
TITLE:		GENERALIZED GEOLOGIC CROSS-SECTION B-B'	
DRAWN BY:	D. STEHLE	PROJ NO.:	265996.0004.01.01
CHECKED BY:	S. HOLMSTROM	FIGURE B-3	
APPROVED BY:	V. BUENING		
DATE:	SEPTEMBER 2017		
		1540 Eisenhower Place Ann Arbor, MI 48108 Phone: 734.971.7080 www.trcsolutions.com	
FILE NO.:		265996.0004.01.01.04-05.dwg	

Attachment 2

2021 Boring Logs

Project: STCPP BAB Pond Closure Job No.: 22741069 Location: St. Claire, Michigan Coordinates: N 465,175.1 ft E 13,632,072.9 ft Datum: MI State Plane S Zone, NAD83(ft) Elev.NAVD88	Surface Elevation: 581.3 ft Drilling Method: HSA Sampling Method: SS, 3T Completion Depth: 44.0 ft
--	---

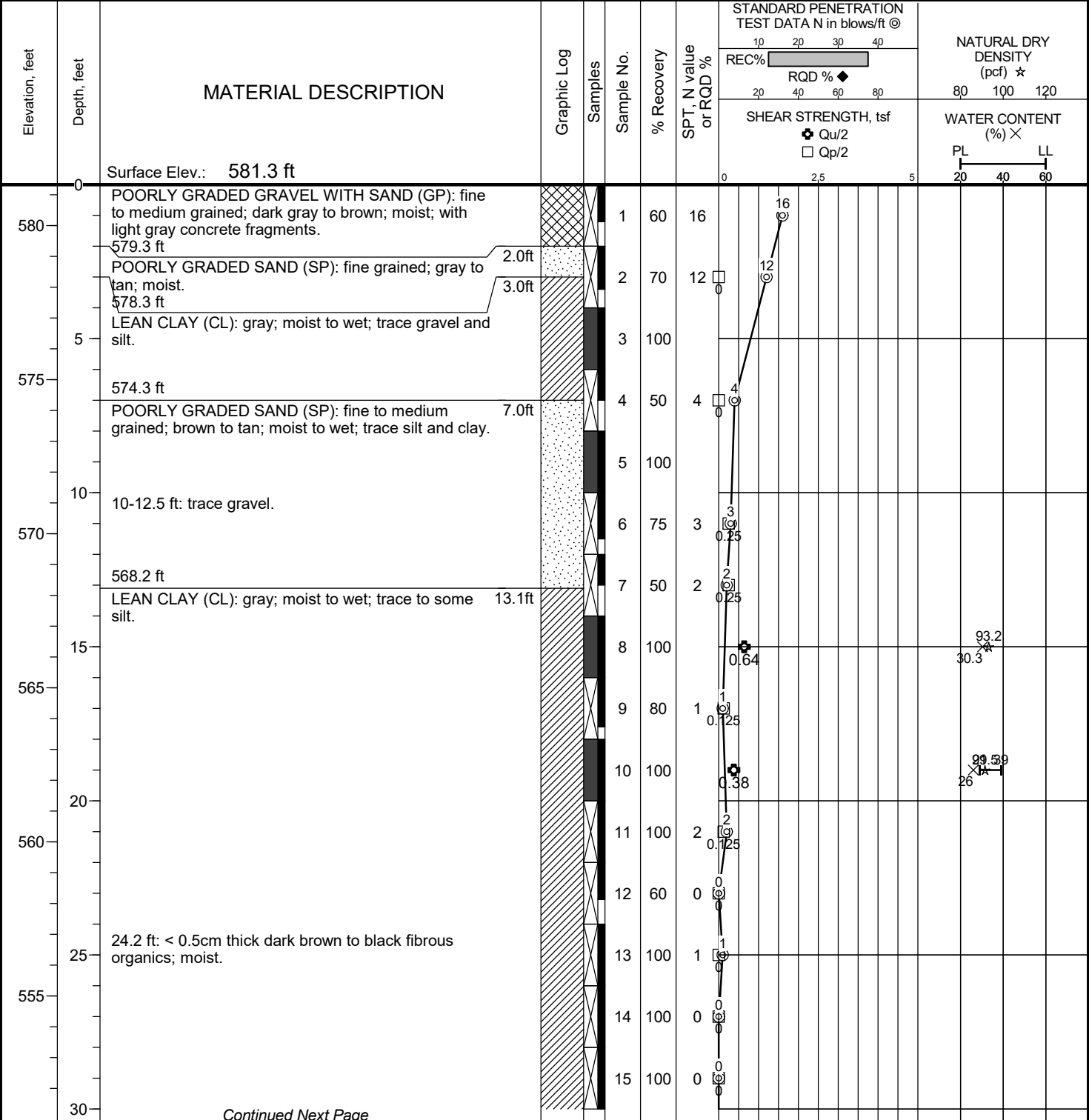

Continued Next Page

Date Boring Started: 10/4/21 Date Boring Completed: 10/4/21 Logged By: JKP3 Drilling Contractor: JSS Drill Rig: CME 1050. Hammer Efficiency is 70.6%.	Water Levels (ft) ▽ At Time of Drilling Dry	Remarks: Augered through bridge in cuttings and backfilled rest of boring with cuttings, bentonite and grout. Qp values are averaged from multiple tests across a 2-foot interval. Elevation estimated from Trimble. Weather: 65F, overcast
---	---	--

M:\GINT\PROJECTS\22741069\22741069_STCPP BAB CLOSURE.GPJ_BARR\LIBRARY.GLB_BOREHOLE LOG REPORT_BARR TEMPLATE.GDT



Barr Engineering Company
 3005 Boardwalk St, Suite 100
 Ann Arbor, MI 48108
 Telephone: 734-922-4400

LOG OF BORING SB-01-21

Project: STCPP BAB Pond Closure	Surface Elevation: 581.3 ft
Job No.: 22741069	Drilling Method: HSA
Location: St. Claire, Michigan	Sampling Method: SS, 3T
Coordinates: N 465,175.1 ft E 13,632,072.9 ft	Completion Depth: 44.0 ft
Datum: MI State Plane S Zone, NAD83(ft) Elev.NAVD88	

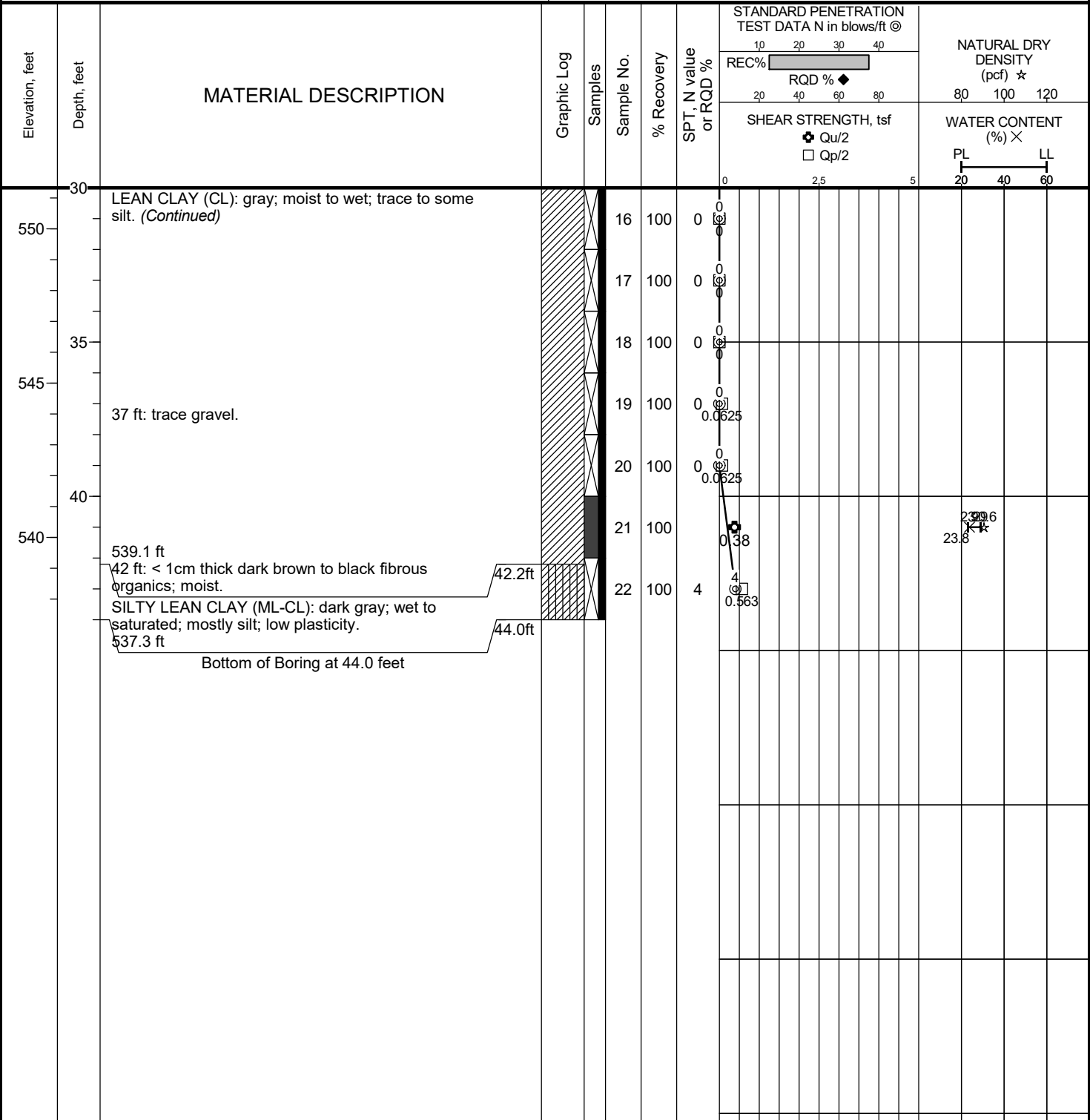

M:\GINT\PROJECTS\22741069\22741069_STCPP BAB CLOSURE.GPJ_BARR\LIBRARY.GLB_BOREHOLE LOG REPORT_BARR TEMPLATE.GDT

Date Boring Started: 10/4/21	Water Levels (ft)	Remarks: Augered through bridge in cuttings and backfilled rest of boring with cuttings, bentonite and grout. Qp values are averaged from multiple tests across a 2-foot interval. Elevation estimated from Trimble.
Date Boring Completed: 10/4/21	At Time of Drilling	
Logged By: JKP3	Dry	
Drilling Contractor: JSS		
Drill Rig: CME 1050. Hammer Efficiency is 70.6%.		
		Weather: 65F, overcast



Barr Engineering Company
 3005 Boardwalk St, Suite 100
 Ann Arbor, MI 48108
 Telephone: 734-922-4400

LOG OF BORING SB-02-21

Sheet 1 of 2

Project:	STCPP BAB Pond Closure	Surface Elevation:	584.6 ft
Job No.:	22741069	Drilling Method:	HSA
Location:	St. Claire, Michigan	Sampling Method:	SS, 3T
Coordinates:	N 465,508.9 ft E 13,632,154.8 ft	Completion Depth:	60.0 ft
Datum:	MI State Plane S Zone, NAD83(ft) Elev.NAVD88		

Elevation, feet	Depth, feet	MATERIAL DESCRIPTION	Graphic Log	Samples	Sample No.	% Recovery	SPT, N value or RQD %	STANDARD PENETRATION TEST DATA N in blows/ft @		NATURAL DRY DENSITY (pcf) ★	WATER CONTENT (%) ×
								REC%	RQD % ◆		
		Surface Elev.: 584.6 ft						10 20 30 40		80 100 120	
584.3	0.3	CONCRETE: concrete and slag.			1	0					
581.9	2.7	CONCRETE AND POORLY GRADED GRAVEL WITH SAND (GP): black to brown to tan; moist.			2	70	7	7	0.75		
580.4	4.2	LEAN CLAY (CL): bluish gray; moist; trace silt.			3	80	4	4	0.375		
580.0	4.6	POORLY GRADED GRAVEL WITH SAND (GP): black; moist.			4	85	1	1	0.875		
		LEAN CLAY (CL): bluish gray; moist; trace silt increasing to some silt with depth; trace gravel. 6.4-6.5 ft: black gravel with sand.			5	80	3	3	0.875		
		11 ft: color change to gray.			6	50	1	1	0.563		
					7	70	2	2	0.563		
					8	100			0.865	230.97	26.6
					9	75	3	3	0.875		
					10	80	2	2	0.35		
					11	100	7	7	0.188		
					12	90	1	1	0.188		
					13	100	1	1	0.0625		
					14	70	0	0			
					15	100	0	0			
					16	90	0	0			
					17	100	0	0			
550	35	549.6 ft									

Continued Next Page

Date Boring Started: 10/5/21
 Date Boring Completed: 10/5/21
 Logged By: JKP3
 Drilling Contractor: JSS
 Drill Rig: CME 1050. Hammer Efficiency is 70.6%.

Water Levels (ft)
 ▼ At Time of Drilling
 Dry

Remarks: Grouted from 60 ft bgs to approximately 2 ft bgs, with cuttings added at approximately 30 ft bgs. One bag of sand added at 2 ft bgs and topped off with cement patch. Qp values are averaged from multiple tests across a 2-foot interval. Elevation estimated from Trimble. Weather: 65F, overcast

M:\GINT\PROJECTS\22741069\22741069_STCPP BAB CLOSURE.GPJ_BARR\LIBRARY.GLB_BOREHOLE LOG REPORT_BARR TEMPLATE.GDT



Barr Engineering Company
 3005 Boardwalk St, Suite 100
 Ann Arbor, MI 48108
 Telephone: 734-922-4400

LOG OF BORING SB-02-21

Project: STCPP BAB Pond Closure	Surface Elevation: 584.6 ft
Job No.: 22741069	Drilling Method: HSA
Location: St. Claire, Michigan	Sampling Method: SS, 3T
Coordinates: N 465,508.9 ft E 13,632,154.8 ft	Completion Depth: 60.0 ft
Datum: MI State Plane S Zone, NAD83(ft) Elev.NAVD88	

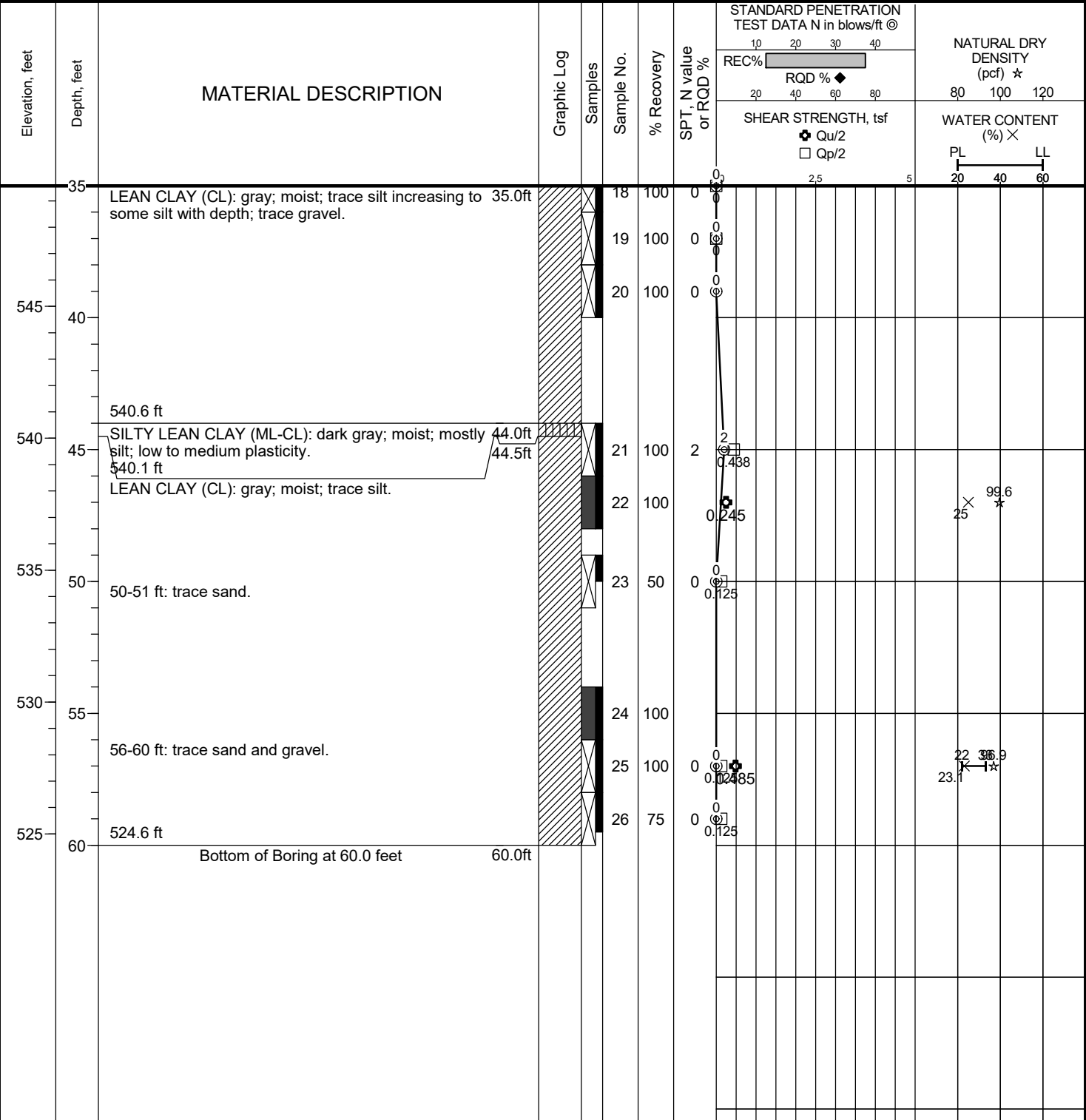

Date Boring Started: 10/5/21	Water Levels (ft)	Remarks: Grouted from 60 ft bgs to approximately 2 ft bgs, with cuttings added at approximately 30 ft bgs. One bag of sand added at 2 ft bgs and topped off with cement patch. Qp values are averaged from multiple tests across a 2-foot interval. Elevation estimated from Trimble. Weather: 65F, overcast
Date Boring Completed: 10/5/21	At Time of Drilling	
Logged By: JKP3	Dry	
Drilling Contractor: JSS		
Drill Rig: CME 1050. Hammer Efficiency is 70.6%.		

M:\GINT\PROJECTS\22741069\22741069_STCPP BAB CLOSURE.GPJ_BARR\LIBRARY.GLB_BOREHOLE LOG REPORT_BARR TEMPLATE.GDT

Attachment 3

2021 Vibracore Summary

**DTE STCPP - BAB Closure Plan
2021 Vibracore Investigation Summary**

Boring Name	Basin	Date Collected	Length of Push (ft)	Recovery (ft)	Recovery (%)	Top of Clay from Core (ft)	Estimated Recovered Ash* (ft)	Top of Sheetpile Elevation	Depth to Clay (ft bgs [^])	Bottom of CCR Elevation %	Depth to Water (ft bgs [^])	Total Push Depth (ft bgs [^])	Samples Collected	Comments
East-SED-01	East	9/29/2021	13	5	38%	--		582.8	--	--	3.8	16.8	--	Pushed to refusal [#] - coarse material encountered near inflow.
East-SED-02	East	9/29/2021	--	10	--	--		582.8	--	--	3.8	--	solid ash	Pushed to refusal [#] - coarse material encountered near inflow. Field error: length of push not recorded.
East-SED-03	East	9/29/2021	20.5	9	44%	6.3	2.7	582.8	21.6	561.2	3.8	24.3	soild ash, solid clay, ash	
East-SED-04	East	9/29/2021	20	10	50%	5.2	4.8	582.8	19.0	563.8	3.8	23.8	solid ash	
East-SED-05	East	9/29/2021	17	6.5	38%	4.7	1.8	582.8	19.0	563.8	3.8	20.8	solid ash	
East-SED-06	East	9/30/2021	12	7.5	63%	6.7	0.8	582.8	15.1	567.7	3.9	15.9	ash	
East-SED-07	East	9/30/2021	15	8	53%	--	8	582.8	--	--	3.9	18.9	solid ash	Pushed to refusal [#] - hit something harder here, footing? Low density, low plasticity silty ash with clay.
East-SED-08	East	9/30/2021	18	10	56%	5	5	582.8	16.9	565.9	3.9	21.9	ash with solid clay	
East-SED-09	East	9/30/2021	18	10	56%	5.6	4.4	582.8	17.5	565.3	3.9	21.9	solid ash	
East-SED-10	East	9/30/2021	18	10	56%	5.6	4.4	582.8	17.5	565.3	3.9	21.9	ash with solid clay	
East-SED-11	East	9/30/2021	19	10	53%	6.4	3.6	582.8	19.3	563.5	3.9	22.9	solid ash	
East-SED-12	East	9/30/2021	19	10	53%	--	10	582.8	--	--	3.9	22.9	ash	Pushed to refusal [#] - sandy ash with silt and clay. Trace tan solid ash inclusions. Low density, non plastic.
East-SED-13	East	9/30/2021	21	10	48%	5.6	4.4	582.8	20.5	562.3	3.9	24.9	ash	
West-SED-01	West	9/30/2021	20	7.5	38%	1.6	5.9	584.2	19.0	565.2	4.9	24.9	ash	
West-SED-02	West	9/30/2021	12	5	42%	--	5	584.2	--	--	5.2	17.2	solid ash	Pushed to refusal [#] - dark gray silty ash with clay, trace carbon grains, slightly plastic, low density.
West-SED-03	West	9/30/2021	15	7.1	47%	3.2	3.9	584.2	16.0	568.2	4.9	19.9	ash	
West-SED-04	West	9/30/2021	20	9	45%	5.4	3.6	584.2	22.0	562.3	5.6	25.6	solid ash	
West-SED-05	West	9/30/2021	18	10	56%	2.5	7.5	584.2	15.7	568.5	5.2	23.2	ash	
West-SED-06	West	9/30/2021	18	10	56%	6.3	3.7	584.2	19.9	564.4	5.6	23.6	solid ash	
West-SED-07	West	9/30/2021	13	9.7	75%	--	9.7	584.2	--	--	4.9	17.9	solid ash	Pushed to refusal [#] - dark gray silty ash with clay, trace sand, carbon grains, and gravel, slightly plastic, low density.
West-SED-08	West	9/30/2021	17	9.3	55%	6.2	3.1	584.2	18.8	565.4	4.9	21.9	ash	
West-SED-09	West	10/1/2021	20	10	50%	4.9	5.1	584.2	20.4	563.8	5.5	25.5	ash	
West-SED-10	West	10/1/2021	16	10	63%	8.7	1.3	584.2	19.6	564.6	4.9	20.9	solid ash, solid clay	
West-SED-11	West	10/1/2021	17	10	59%	4.9	5.1	584.2	17.1	567.1	5.2	22.2	ash, solid clay	
West-SED-12	West	10/1/2021	19	10	53%	5	5	584.2	19.5	564.7	5.5	24.5	ash, solid ash	
West-SED-13	West	10/1/2021	16	10	63%	7.1	2.9	584.2	18.0	566.2	4.9	20.9	ash	
West-SED-14	West	10/1/2021	20	10	50%	7.3	2.7	584.2	22.8	561.4	5.5	25.5	ash, solid clay	

<i>Average</i>	18.8	561.2	4.5	21.9
<i>East Ave</i>	18.5	568.5	3.9	21.4
<i>West Ave</i>	19.1	564.8	5.2	22.4

Notes:

(--) not applicable/reported

[#]All vibracores were pushed to refusal; additional notes provided when core did not reach native clay.

[^] ft bgs - Feet below surrounding ground surface, where ground surface is the top of the sheet pile surrounding the basins.

* Ash recovery was limited because the core catcher used was optimal for pushing into the clay, but therefore the finer ash in the upper portion of the core was not recovered as readily.

% Shading highlights variability of the depth/elevation of bottom of CCR; green indicates shallower values and red indicates deeper values.

Material Descriptions under Samples Collected:

Solid ash - sample collected was a consolidated ash sample with minimal disturbance

Ash - sample collected was unconsolidated, disturbed ash

Solid clay - sample of the clay

Statistics by Basin	TOP OF CLAY EL.	
	EAST BASIN	WEST BASIN
Min.	561.2	561.4
Max	567.7	568.5
Average	564.3	565.1

*Beyond East-SED-01 and East-SED-02, the refusals were difficult to understand - material did not seem significantly different from other ash, but crew was not able to push further. No coarse material or larger chunks observed at the base of the core.

Barr Footer: ArcGIS 10.8.1, 2021-11-05 15:43 File: I:\Projects\22\22\41069\Maps\Reports\Figure 1_STCPP_BoringLocations_Depth to Clay.mxd User: MACZ

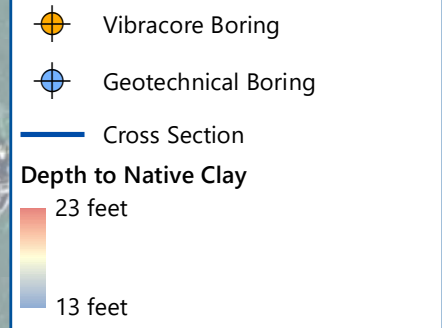
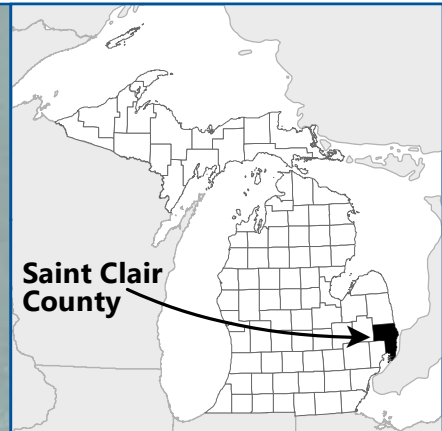
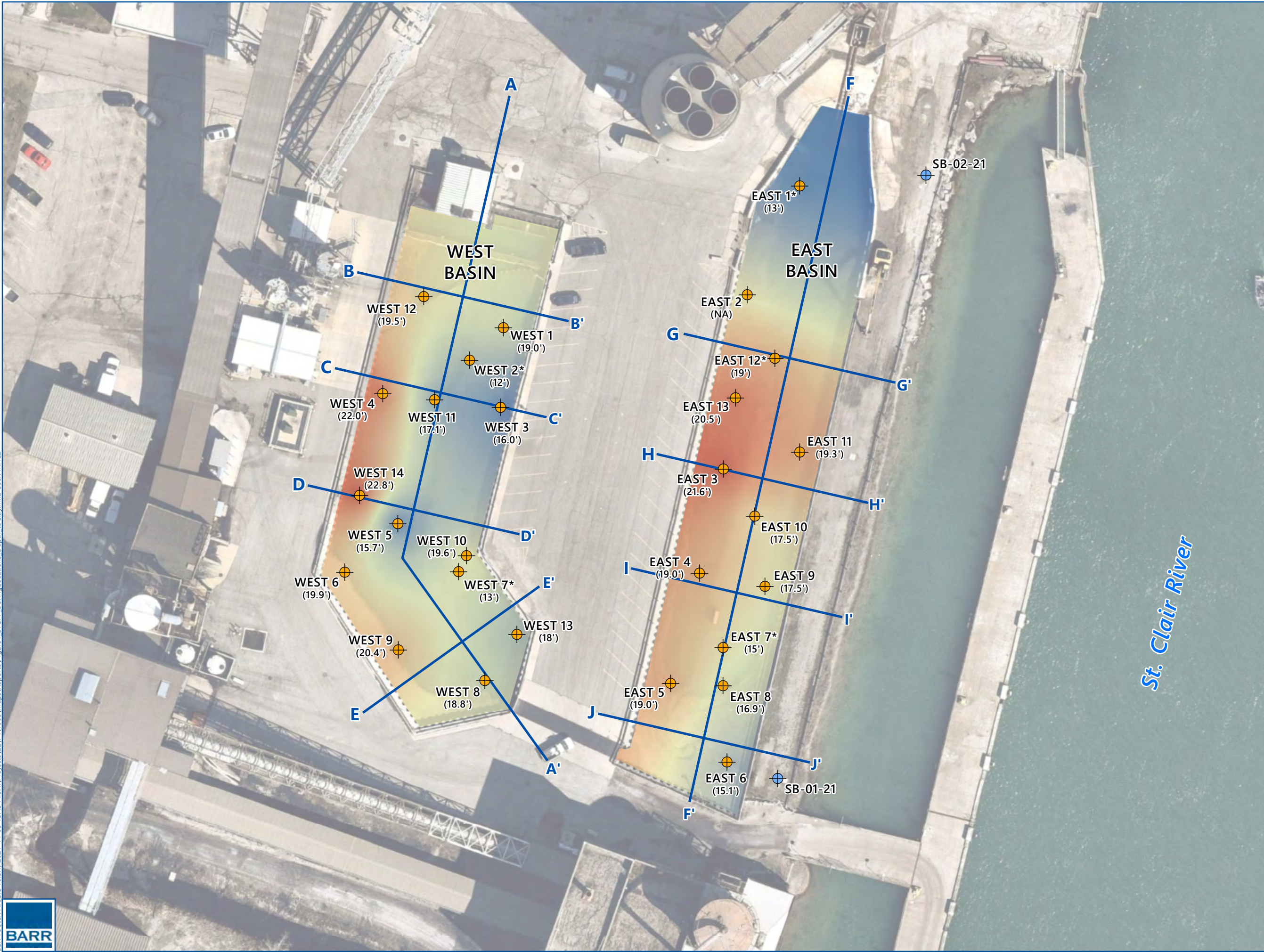

Notes:

- Boring locations depicted on this figure based on GPS data collected by Barr Engineering Co. (9/29/2021 to 10/5/2021.)
- Boring locations labels include measured depth to clay feet below surface.
- *Denotes Vibracore was pushed to refusal and no clay was recovered, and therefore excluded from cell bottom analysis; Exception being EAST 1 where coarse material prevented collection of any depth to clay measurements.

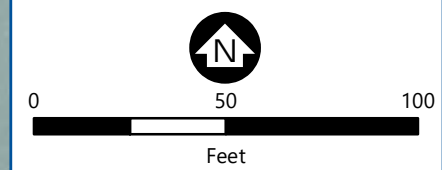

Aerial Image: NearMap 4/3/2020

2021 INVESTIGATION LOCATIONS
DEPTH TO NATIVE CLAY
 St. Clair Power Plant
 DTE Energy
 4901 Pointe Drive
 China Township, Michigan

FIGURE 3-1



Attachment 4

2022 ConeTec Report

Zip files of raw data
available on request

PRESENTATION OF SITE INVESTIGATION RESULTS

DTE Energy St. Clair Power Plant, East China Twp., MI

Prepared for:

Barr Engineering Co.

ConeTec Job No: 22-61-23505

Project Start Date: 07-Jan-2022

Project End Date: 08-Jan-2022

Report Date: 12-Jan-2022

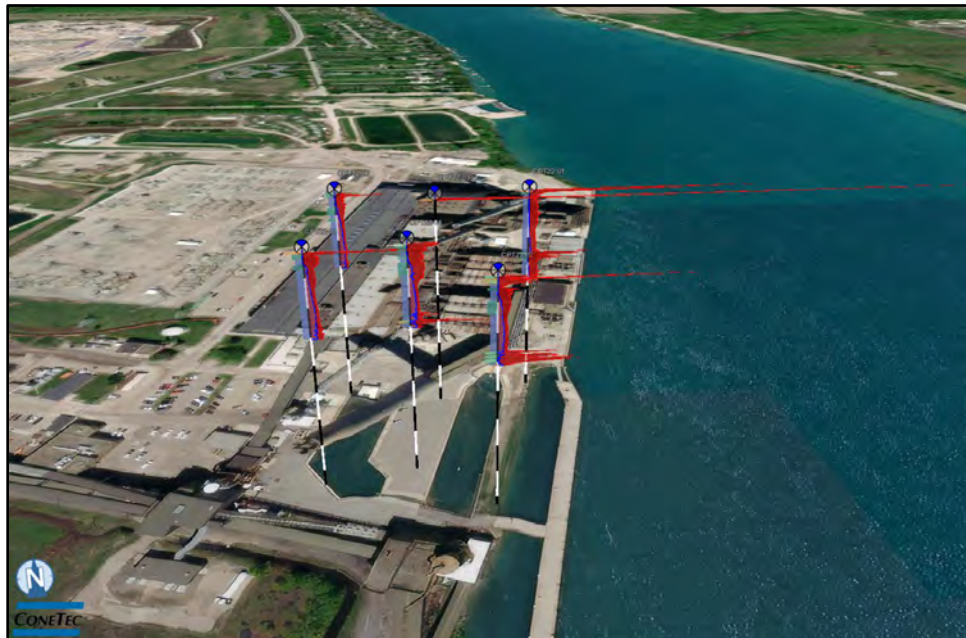

Prepared by:

ConeTec Inc.
1335 Louis Avenue
Elk Grove Village, Illinois 60007

Tel: +1 (224) 228-6286

ConeTecLL@conetec.com
www.conetec.com
www.conetecdataservices.com



Introduction

The enclosed report presents the results of the site investigation program conducted by ConeTec Inc. for Barr Engineering Co. at the DTE Energy St. Clair Power Plant in St. Clair County, Michigan. The program consisted of 6 cone penetration tests (CPTu) and 1 electric vane shear test (eVST) location. Please note that this report, which also includes all accompanying data, are subject to the 3rd Party Disclaimer and Client Disclaimer that follow in the 'Limitations' section of this report.

Project Information

Project	
Client	Barr Engineering Co.
Project	DTE Energy St. Clair Power Plant, East China Twp., MI
ConeTec project number	22-61-23505

An aerial overview from Google Earth including the test locations is presented below.

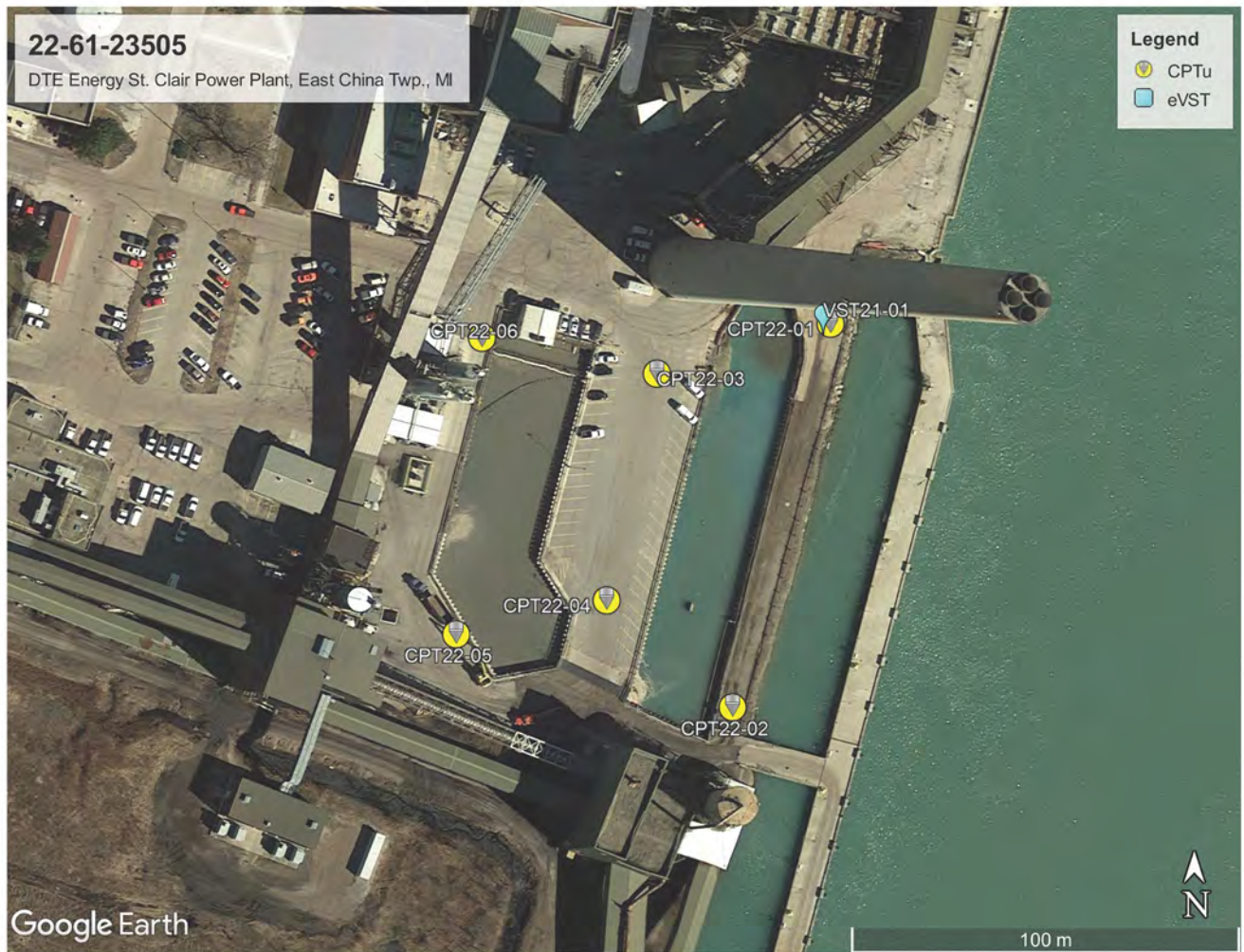

Rig Description	Deployment System	Test Type
CPT truck rig (C18)	30 ton rig cylinder	CPTu, eVST

Coordinates		
Test Type	Collection Method	EPSG Number
CPTu, eVST	Consumer grade GPS	32617

Cone Penetrometers Used for this Project						
Cone Description	Cone Number	Cross Sectional Area (cm ²)	Sleeve Area (cm ²)	Tip Capacity (bar)	Sleeve Capacity (bar)	Pore Pressure Capacity (bar)
706:T1500F15U35	706	15	225	1500	15	35
Cone 706 was used for all CPTu soundings.						

Cone Penetration Test (CPTu)	
Depth reference	Depths are referenced to the existing ground surface at the time of each test.
Tip and sleeve data offset	0.1 meter This has been accounted for in the CPT data files.
Additional plots	<ul style="list-style-type: none"> Advanced plots with I_c, S_u, OCR, and $N1(60)$ Soil Behaviour Type (SBT) scatter plots

Calculated Geotechnical Parameter Tables	
Additional information	<p>The Normalized Soil Behaviour Type Chart based on Q_{tn} (SBT Q_{tn}) (Robertson, 2009) was used to classify the soil for this project. A detailed set of calculated CPTu parameters have been generated and are provided in Excel format files in the release folder. The CPTu parameter calculations are based on values of corrected tip resistance (q_t) sleeve friction (f_s) and pore pressure (u_2).</p> <p>Effective stresses are calculated based on unit weights that have been assigned to the individual soil behaviour type zones and the assumed equilibrium pore pressure profile.</p> <p>Soils were classified as either drained or undrained based on the Q_{tn} Normalized Soil Behaviour Type Chart (Robertson, 2009). Calculations for both drained and undrained parameters were included for materials that classified as silt mixtures (zone 4).</p>

Electric Field Vane Shear Test (VST)	
Depth reference	Depths are referenced to the existing ground surface at the time of each test.
Load cell capacity	100 N·m
Load cell location	Surface
Additional comments	Peak undrained shear strength values (S_u) are over-plotted on the CPTu S_u profile for comparison.

Limitations

3rd Party Disclaimer

This report titled "DTE Energy St. Clair Power Plant, East China Twp., MI", referred to as the ("Report"), was prepared by ConeTec for Barr Engineering Co.. The Report is confidential and may not be distributed to or relied upon by any third parties without the express written consent of ConeTec. Any third parties gaining access to the Report do not acquire any rights as a result of such access. Any use which a third party makes of the Report, or any reliance on or decisions made based on it, are the responsibility of such third parties. ConeTec accepts no responsibility for loss, damage and/or expense, if any, suffered by any third parties as a result of decisions made, or actions taken or not taken, which are in any way based on, or related to, the Report or any portion(s) thereof.

Client Disclaimer

ConeTec was retained by Barr Engineering Co. to collect and provide the raw data ("Data") which is included in this report titled "DTE Energy St. Clair Power Plant, East China Twp., MI", which is referred to as the ("Report"). ConeTec has collected and reported the Data in accordance with current industry standards. No other warranty, express or implied, with respect to the Data is made by ConeTec. In order to properly understand the Data included in the Report, reference must be made to the documents accompanying and other sources referenced in the Report in their entirety. Any analysis, interpretation, judgment, calculations and/or geotechnical parameters (collectively "Interpretations") included in the Report, including those based on the Data, are outside the scope of ConeTec's retainer and are included in the Report as a courtesy only. Other than the Data, the contents of the Report (including any Interpretations) should not be relied upon in any fashion without independent verification and ConeTec is in no way responsible for any loss, damage or expense resulting from the use of, and/or reliance on, such material by any party.



Cone penetration tests (CPTu) are conducted using an integrated electronic piezocone penetrometer and data acquisition system manufactured by Adara Systems Ltd., a subsidiary of ConeTec.

ConeTec's piezocone penetrometers are compression type designs in which the tip and friction sleeve load cells are independent and have separate load capacities. The piezocones use strain gauged load cells for tip and sleeve friction and a strain gauged diaphragm type transducer for recording pore pressure. The piezocones also have a platinum resistive temperature device (RTD) for monitoring the temperature of the sensors, an accelerometer type dual axis inclinometer and two geophone sensors for recording seismic signals. All signals are amplified and measured with minimum sixteen-bit resolution down hole within the cone body, and the signals are sent to the surface using a high bandwidth, error corrected digital interface through a shielded cable.

ConeTec penetrometers are manufactured with various tip, friction and pore pressure capacities in both 10 cm² and 15 cm² tip base area configurations in order to maximize signal resolution for various soil conditions. The specific piezocone used for each test is described in the CPT summary table presented in the first appendix. The 15 cm² penetrometers do not require friction reducers as they have a diameter larger than the deployment rods. The 10 cm² piezocones use a friction reducer consisting of a rod adapter extension behind the main cone body with an enlarged cross sectional area (typically 44 millimeters diameter over a length of 32 millimeters with tapered leading and trailing edges) located at a distance of 585 millimeters above the cone tip.

The penetrometers are designed with equal end area friction sleeves, a net end area ratio of 0.8 and cone tips with a 60 degree apex angle.

All ConeTec piezocones can record pore pressure at various locations. Unless otherwise noted, the pore pressure filter is located directly behind the cone tip in the "u₂" position ([ASTM Type 2](#)). The filter is six millimeters thick, made of porous plastic (polyethylene) having an average pore size of 125 microns (90-160 microns). The function of the filter is to allow rapid movements of extremely small volumes of water needed to activate the pressure transducer while preventing soil ingress or blockage.

The piezocone penetrometers are manufactured with dimensions, tolerances and sensor characteristics that are in general accordance with the current [ASTM D5778](#) standard. ConeTec's calibration criteria also meets or exceeds those of the current [ASTM D5778](#) standard. An illustration of the piezocone penetrometer is presented in [Figure CPTu](#).

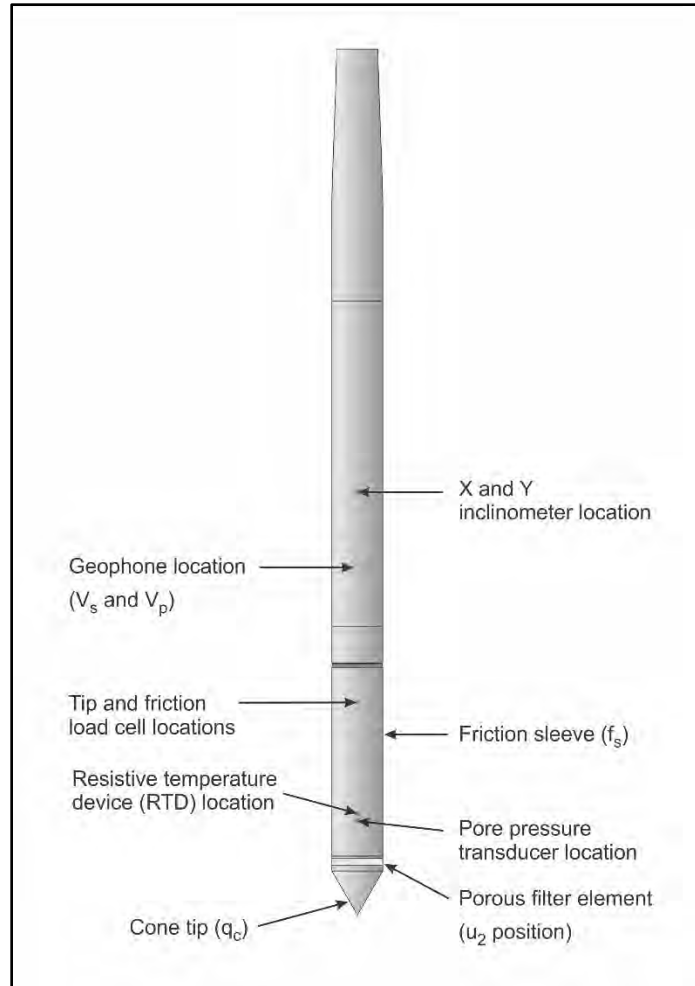

Figure CPTu. Piezocone Penetrometer (15 cm²)

The ConeTec data acquisition systems consist of a Windows based computer and a signal interface box and power supply. The signal interface combines depth increment signals, seismic trigger signals and the downhole digital data. This combined data is then sent to the Windows based computer for collection and presentation. The data is recorded at fixed depth increments using a depth wheel attached to the push cylinders or by using a spring loaded rubber depth wheel that is held against the cone rods. The typical recording interval is 2.5 centimeters; custom recording intervals are possible.

The system displays the CPTu data in real time and records the following parameters to a storage media during penetration:

- Depth
- Uncorrected tip resistance (q_c)
- Sleeve friction (f_s)
- Dynamic pore pressure (u)
- Additional sensors such as resistivity, passive gamma, ultra violet induced fluorescence, if applicable

All testing is performed in accordance to ConeTec's CPTu operating procedures which are in general accordance with the current [ASTM D5778](#) standard.

Prior to the start of a CPTu sounding a suitable cone is selected, the cone and data acquisition system are powered on, the pore pressure system is saturated with silicone oil and the baseline readings are recorded with the cone hanging freely in a vertical position.

The CPTu is conducted at a steady rate of two centimeters per second, within acceptable tolerances. Typically one meter length rods with an outer diameter of 1.5 inches (38.1 millimeters) are added to advance the cone to the sounding termination depth. After cone retraction final baselines are recorded.

Additional information pertaining to ConeTec's cone penetration testing procedures:

- Each filter is saturated in silicone oil under vacuum pressure prior to use
- Baseline readings are compared to previous readings
- Soundings are terminated at the client's target depth or at a depth where an obstruction is encountered, excessive rod flex occurs, excessive inclination occurs, equipment damage is likely to take place, or a dangerous working environment arises
- Differences between initial and final baselines are calculated to ensure zero load offsets have not occurred and to ensure compliance with [ASTM](#) standards

The interpretation of piezocone data for this report is based on the corrected tip resistance (q_t), sleeve friction (f_s) and pore water pressure (u). The interpretation of soil type is based on the correlations developed by [Robertson et al. \(1986\)](#) and [Robertson \(1990, 2009\)](#). It should be noted that it is not always possible to accurately identify a soil behavior type based on these parameters. In these situations, experience, judgment and an assessment of other parameters may be used to infer soil behavior type.

The recorded tip resistance (q_c) is the total force acting on the piezocone tip divided by its base area. The tip resistance is corrected for pore pressure effects and termed corrected tip resistance (q_t) according to the following expression presented in [Robertson et al. \(1986\)](#):

$$q_t = q_c + (1-a) \cdot u_2$$

where: q_t is the corrected tip resistance

q_c is the recorded tip resistance

u_2 is the recorded dynamic pore pressure behind the tip (u_2 position)

a is the Net Area Ratio for the piezocone (0.8 for ConeTec probes)

The sleeve friction (f_s) is the frictional force on the sleeve divided by its surface area. As all ConeTec piezocones have equal end area friction sleeves, pore pressure corrections to the sleeve data are not required.

The dynamic pore pressure (u) is a measure of the pore pressures generated during cone penetration. To record equilibrium pore pressure, the penetration must be stopped to allow the dynamic pore pressures to stabilize. The rate at which this occurs is predominantly a function of the permeability of the soil and the diameter of the cone.

The friction ratio (R_f) is a calculated parameter. It is defined as the ratio of sleeve friction to the tip resistance expressed as a percentage. Generally, saturated cohesive soils have low tip resistance, high friction ratios and generate large excess pore water pressures. Cohesionless soils have higher tip resistances, lower friction ratios and do not generate significant excess pore water pressure.

A summary of the CPTu soundings along with test details and individual plots are provided in the appendices. A set of files with calculated geotechnical parameters were generated for each sounding based on published correlations and are provided in Excel format in the data release folder. Information regarding the methods used is also included in the data release folder.

For additional information on CPTu interpretations and calculated geotechnical parameters, refer to [Robertson et al. \(1986\)](#), [Lunne et al. \(1997\)](#), [Robertson \(2009\)](#), [Mayne \(2013, 2014\)](#) and [Mayne and Peuchen \(2012\)](#).

References

ASTM D5778-20, 2020, "Standard Test Method for Performing Electronic Friction Cone and Piezocone Penetration Testing of Soils", ASTM International, West Conshohocken, PA. DOI: [10.1520/D5778-20](#).

Lunne, T., Robertson, P.K. and Powell, J. J. M., 1997, "Cone Penetration Testing in Geotechnical Practice", Blackie Academic and Professional.

Mayne, P.W., 2013, "Evaluating yield stress of soils from laboratory consolidation and in-situ cone penetration tests", Sound Geotechnical Research to Practice (Holtz Volume) GSP 230, ASCE, Reston/VA: 406-420. DOI: [10.1061/9780784412770.027](#).

Mayne, P.W. and Peuchen, J., 2012, "Unit weight trends with cone resistance in soft to firm clays", Geotechnical and Geophysical Site Characterization 4, Vol. 1 (Proc. ISC-4, Pernambuco), CRC Press, London: 903-910.

Mayne, P.W., 2014, "Interpretation of geotechnical parameters from seismic piezocone tests", CPT'14 Keynote Address, Las Vegas, NV, May 2014.

Robertson, P.K., Campanella, R.G., Gillespie, D. and Greig, J., 1986, "Use of Piezometer Cone Data", Proceedings of InSitu 86, ASCE Specialty Conference, Blacksburg, Virginia.

Robertson, P.K., 1990, "Soil Classification Using the Cone Penetration Test", Canadian Geotechnical Journal, Volume 27: 151-158. DOI: [10.1139/T90-014](#).

Robertson, P.K., 2009, "Interpretation of cone penetration tests – a unified approach", Canadian Geotechnical Journal, Volume 46: 1337-1355. DOI: [10.1139/T09-065](#).

The fast vane field system is manufactured by Adara Systems Ltd., a subsidiary of ConeTec. An illustration of the uphole fast vane system configuration is presented in [Figure FVST](#).

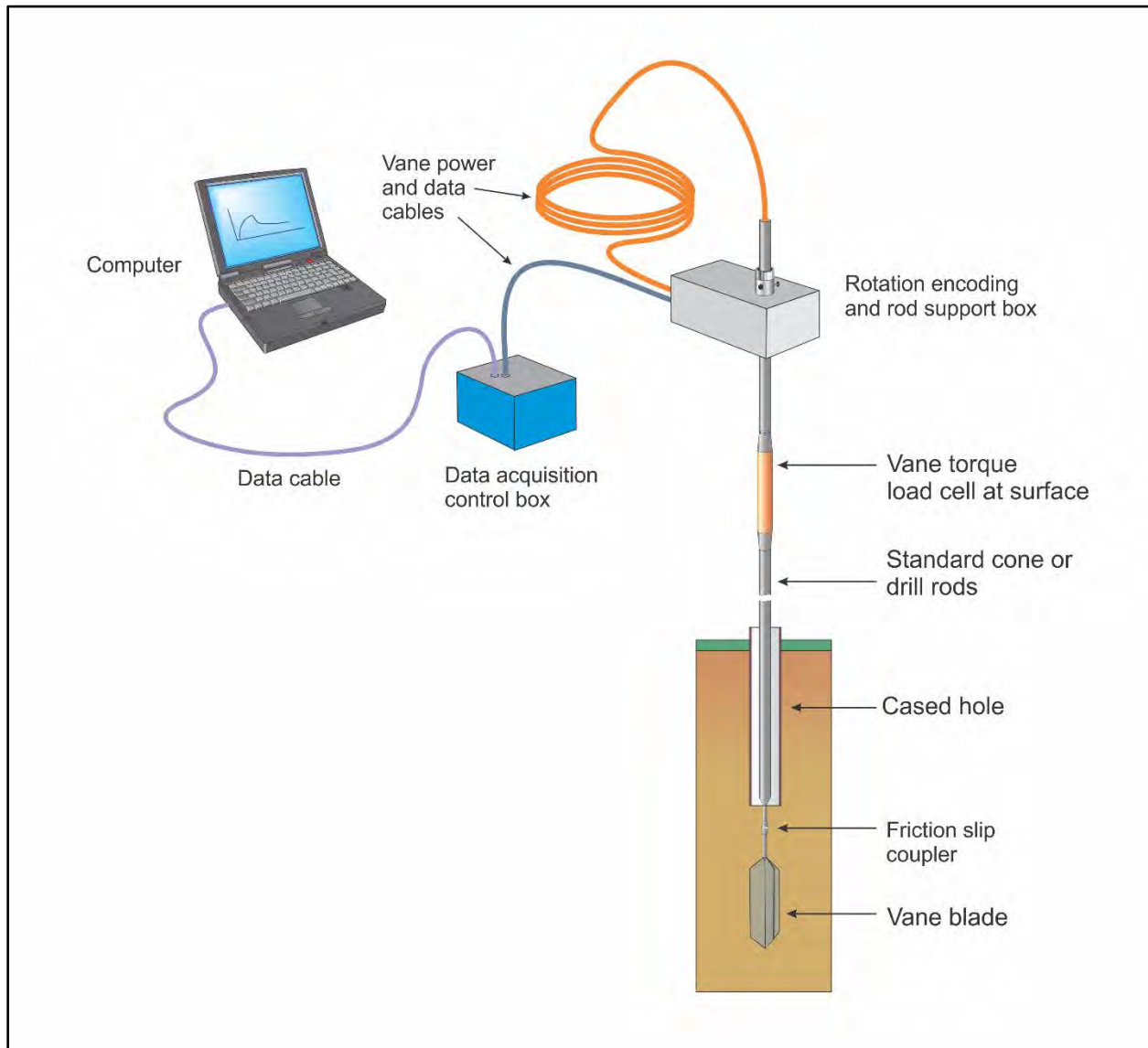

Figure FVST. Illustration of the uphole fast vane system configuration

The vane system is designed with an array of strain gauges in a load cell that measure the applied torque. A fast vane motor setup is used to hold the rods during the test and capture the angle of rotation using a proximity sensor mounted in the motor box. The analog torque signal is transmitted with a cable through the data acquisition system. The system uses a friction slip coupler to permit the free slip or play of approximately fifteen degrees between the rods and the vane blade in order to isolate and record rod friction from the soil before rotation of the vane blade starts. The system is designed to use vane blades of various sizes and configurations that connect to the friction slip coupler. The vane blades manufactured by Adara have dimensions and tolerances that are in general accordance with the current [ASTM D2573](#) standards. In very soft soil conditions and at the request of the client, ConeTec may use a large diameter vane blade that exceeds the [ASTM D2573](#) maximum size specifications in order to maximize torque resolution. In very stiff soil conditions and at the request of the client, ConeTec may use a smaller

diameter vane blade than the minimum size specified in [ASTM D2573](#) in order to obtain a peak torque below the capacity of the load cell.

ConeTec's calibration criteria of the load cells are in general accordance with the current [ASTM D2573](#) standard.

The data acquisition system consists of a computer that records the torque and encoder data every 0.02 seconds. The system records the following parameters and saves them to a file as the test is conducted:

- Torque in Newton-meters
- Encoder stream – changes between 10V and 0V every 1.5 degrees of rotation

All testing is performed in general accordance to ConeTec's field vane testing operating procedures. For additional information on vane shear testing refer to [Greig et al. \(1987\)](#).

Prior to the start of a vane shear test profile, a suitable sized vane blade is selected, the vane system is powered on and the vane load cell baseline reading is recorded with the load cell hanging freely in a vertical position.

The vane blade, slip coupler and rods are advanced to the desired test depth through a cased hole, typically using AWJ drill rods or one meter length rods with an outer diameter of 1.5 inches (38.1 millimeters). Test depths are referenced to the middle of the rectangular portion of the vane blade. The rods are rotated at the desired speed requested by the client capturing up to and beyond the yield stress (peak). Following the peak test, the vane blade is then rapidly rotated clockwise ten times to completely remold the soil. The test procedure is repeated in order to record the remolded strength of the soil. The vane blade is then advanced to the next depth and the procedure is repeated or the vane blade is retracted to allow for drilling and vane blade size changes. Once the vane profile is complete, the final baseline of the load cell is recorded and compared to previous reading as a QA/QC check.

Undrained shear strength from the field vane, $(S_u)_{fv}$, is calculated from torque measurements using the following general equation ([ASTM D2573](#)) taking into consideration the case of rectangular or tapered ends at the top and/or bottom of the vane blade.

$$(S_u)_{fv} = \frac{12 \cdot T_{\max}}{\pi D^2 \left(\frac{D}{\cos(i_T)} + \frac{D}{\cos(i_B)} + 6H \right)}$$

where:

- $(S_u)_{fv}$ = undrained shear strength from the field vane
 T_{max} = maximum value of torque
 D = vane diameter
 H = height of the rectangular portion of the vane
 i_T = angle of taper at vane top (with respect to horizontal)
 i_B = angle of taper at vane bottom (with respect to horizontal)

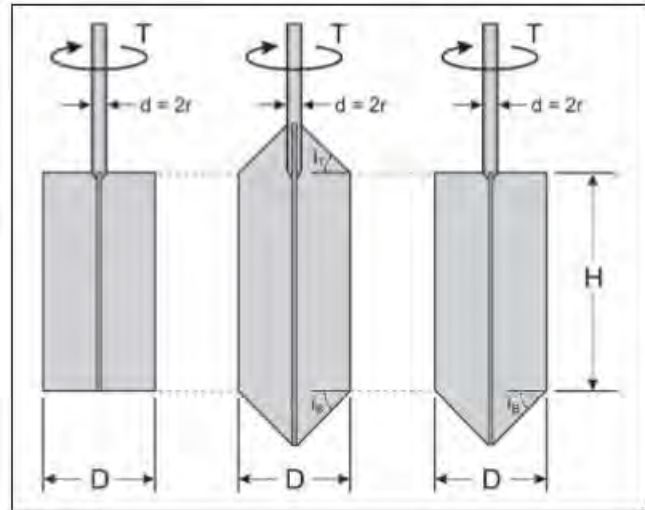

For rectangular vane blades where $H/D = 2$, the above equation simplifies to:

$$(S_u)_{fv} = \frac{6 \cdot T_{max}}{7\pi D^3}$$

The recorded rod friction is subtracted from the peak and remolded torque. No correction factors are applied to the vane results to derive the mobilized shear strength ($\tau_{mobilized}$).

A summary of the vane shear tests, a table of results and individual VST plots are provided in the relevant appendices. Tabular data in Excel format is provided in the data release folder.

References

ASTM D2573 / D2573M-18, 2018, "Standard Test Method for Field Vane Shear Test in Saturated Fine-Grained Soils", ASTM International, West Conshohocken, PA. DOI: [10.1520/D2573_D2573M-18](https://doi.org/10.1520/D2573_D2573M-18).

Greig, J.W., R.G. Campanella and P.K. Robertson, 1987, "Comparison of Field Vane Results With Other In-Situ Test Results", International Symposium on Laboratory and Field Vane Shear Strength Testing, ASTM, Tampa, FL, Proceedings.

The appendices listed below are included in the report:

- Cone Penetration Test Summary and Standard Cone Penetration Test Plots
- Advanced Cone Penetration Test Plots with I_c , $S_u(N_{kt})$, OCR and $N1(60)I_c$
- Soil Behavior Type (SBT) Scatter Plots
- Description of Methods for Calculated CPT Geotechnical Parameters
- Electric Field Vane Shear Test Profile Summary and Results
- Electric Field Vane Shear Test Plots

Cone Penetration Test Summary and Standard Cone Penetration Test Plots



Job No: 22-61-23505
Client: Barr Engineering Co.
Project: DTE Energy St. Clair Power Plant, East China Twp., MI
Start Date: 07-Jan-2022
End Date: 08-Jan-2022

CONE PENETRATION TEST SUMMARY

Sounding ID	File Name	Date	Cone	Cone Area (cm ²)	Assumed Phreatic Surface (ft)	Final Depth (ft)	Northing ² (m)	Easting ² (m)	Refer to Notation Number
CPT22-01	22-61-23505_CP01	07-Jan-2022	706:T1500F15U35	15	10.0	60.20	4735398	379574	
CPT22-02	22-61-23505_CP02	07-Jan-2022	706:T1500F15U35	15	13.0	51.02	4735300	379547	
CPT22-03	22-61-23505_CP03	07-Jan-2022	706:T1500F15U35	15		4.51	4735386	379529	3
CPT22-04	22-61-23505_CP04	07-Jan-2022	706:T1500F15U35	15	13.0	50.20	4735328	379515	
CPT22-05	22-61-23505_CP05	07-Jan-2022	706:T1500F15U35	15	10.0	50.20	4735320	379476	
CPT22-06	22-61-23505_CP06	08-Jan-2022	706:T1500F15U35	15	10.0	50.20	4735396	379484	
Totals	6 soundings					266.32			

1. The assumed phreatic surface was based on the dynamic pore pressure response. Hydrostatic conditions were assumed for the calculated parameters.
2. Coordinates were collected with consumer grade GPS equipment. Datum: WGS 1984 / UTM Zone 17 North.
3. No phreatic surface was detected.



Barr Engineering

Job No: 22-61-23505

Date: 2022-01-07 09:12

Site: DTE Energy St. Clair Power Plant

Sounding: CPT22-01

Cone: 706:T1500F15U35

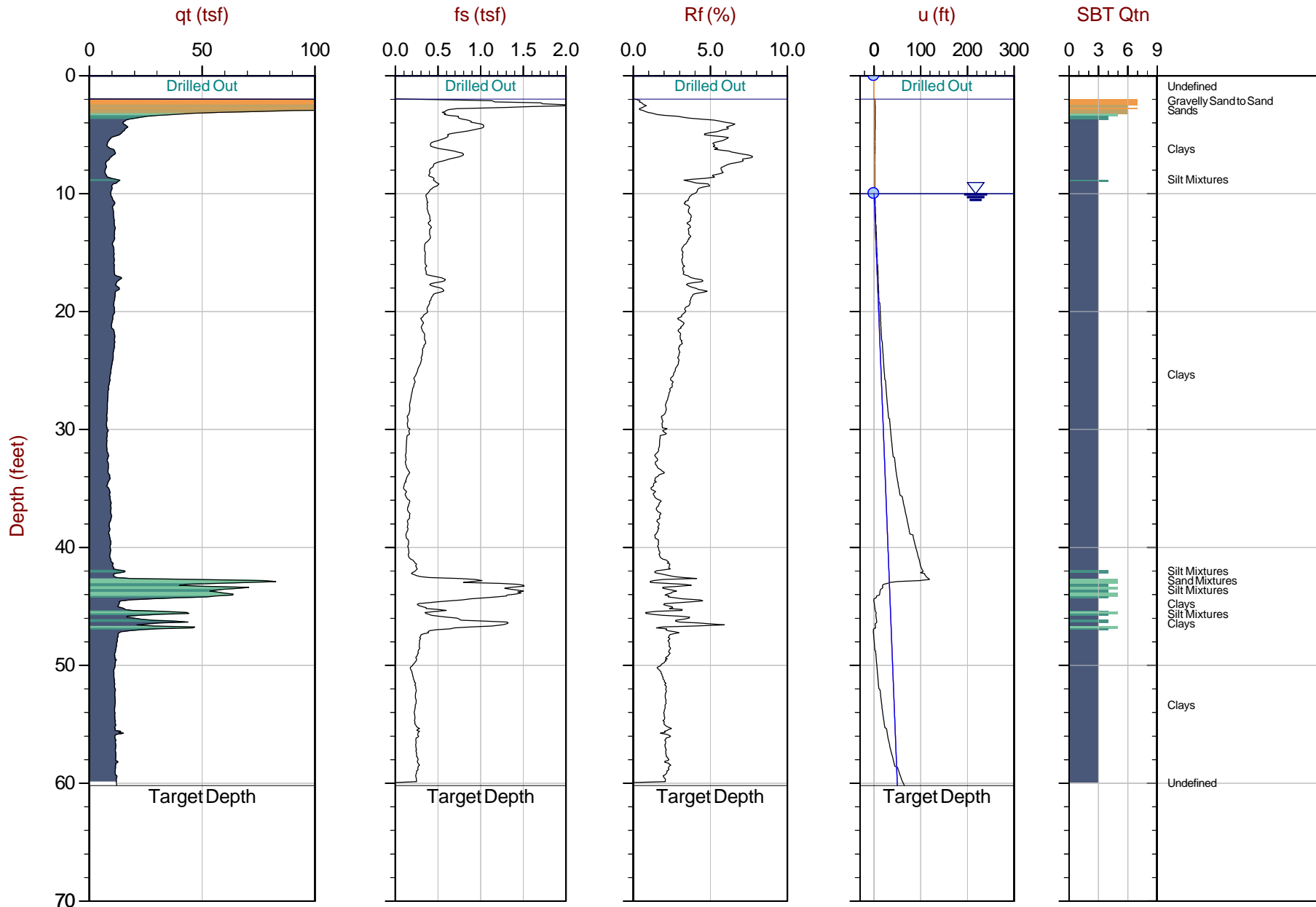

Max Depth: 18.350 m / 60.20 ft
 Depth Inc: 0.025 m / 0.082 ft
 Avg Int: Every Point

File: 22-61-23505_CP01.COR
 Unit Wt: SBTQtn(PKR2009)

SBT: Robertson, 2009 and 2010
 Coords: UTM 17N N: 4735398m E: 379574m

Overplot Item: ● Ueq ● Assumed Ueq ◁ Dissipation, Ueq achieved ◁ Dissipation, Ueq not achieved ◁ Dissipation, Ueq assumed — UeqLine — Hydrostatic Line

The reported coordinates were acquired from consumer grade GPS equipment and are only approximate locations. The coordinates should not be used for design purposes.



Barr Engineering

Job No: 22-61-23505

Date: 2022-01-07 10:41

Site: DTE Energy St. Clair Power Plant

Sounding: CPT22-02

Cone: 706:T1500F15U35

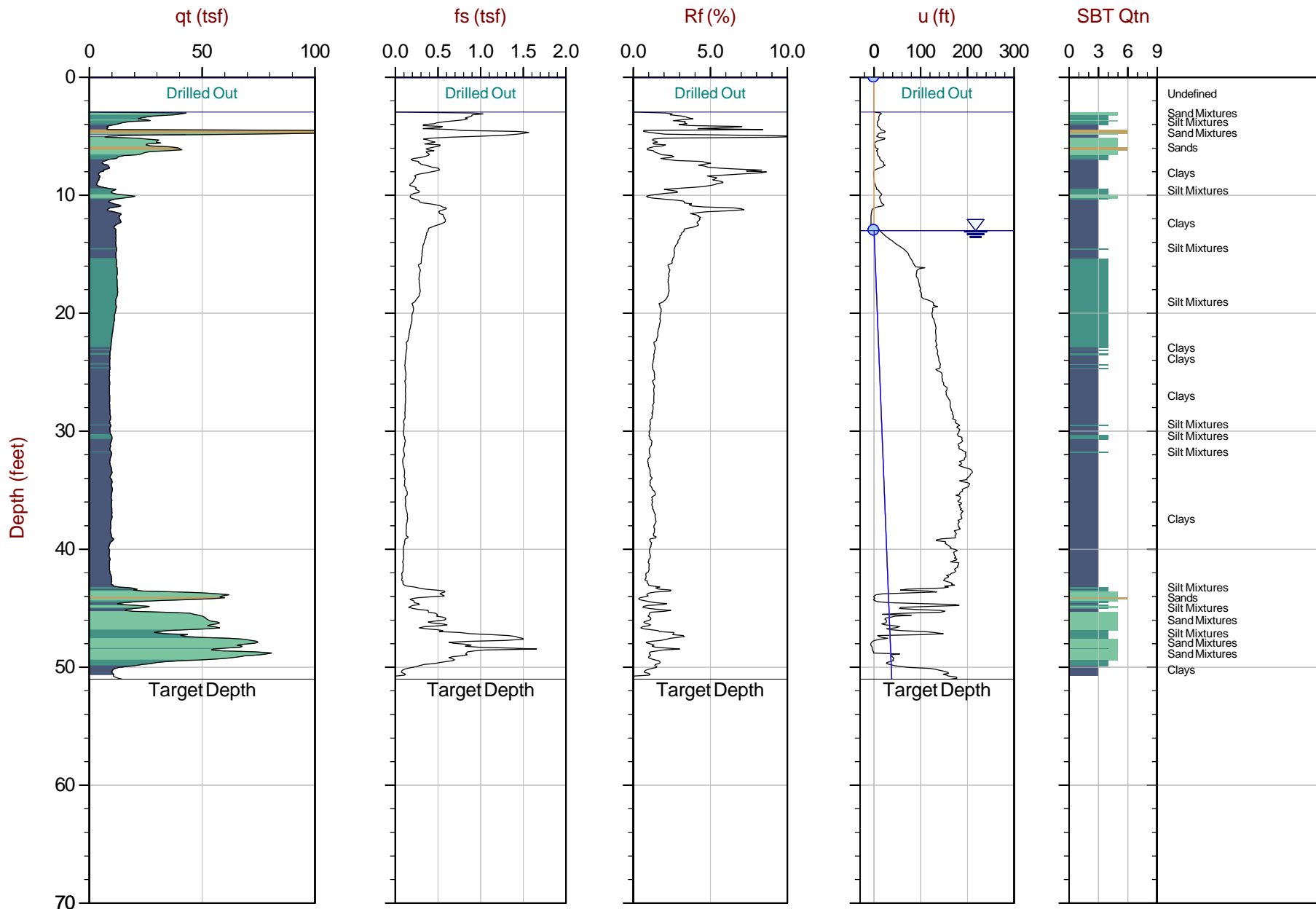

Max Depth: 15.550 m / 51.02 ft
 Depth Inc: 0.025 m / 0.082 ft
 Avg Int: Every Point

File: 22-61-23505_CP02.COR
 Unit Wt: SBTQtn(PKR2009)

SBT: Robertson, 2009 and 2010
 Coords: UTM 17N N: 4735300m E: 379547m

Overplot Item: ● Ueq ● Assumed Ueq ◁ Dissipation, Ueq achieved ◁ Dissipation, Ueq not achieved ◁ Dissipation, Ueq assumed — Ueq Line — Hydrostatic Line

The reported coordinates were acquired from consumer grade GPS equipment and are only approximate locations. The coordinates should not be used for design purposes.



Barr Engineering

Job No: 22-61-23505

Date: 2022-01-07 13:30

Site: DTE Energy St. Clair Power Plant

Sounding: CPT22-03

Cone: 706:T1500F15U35

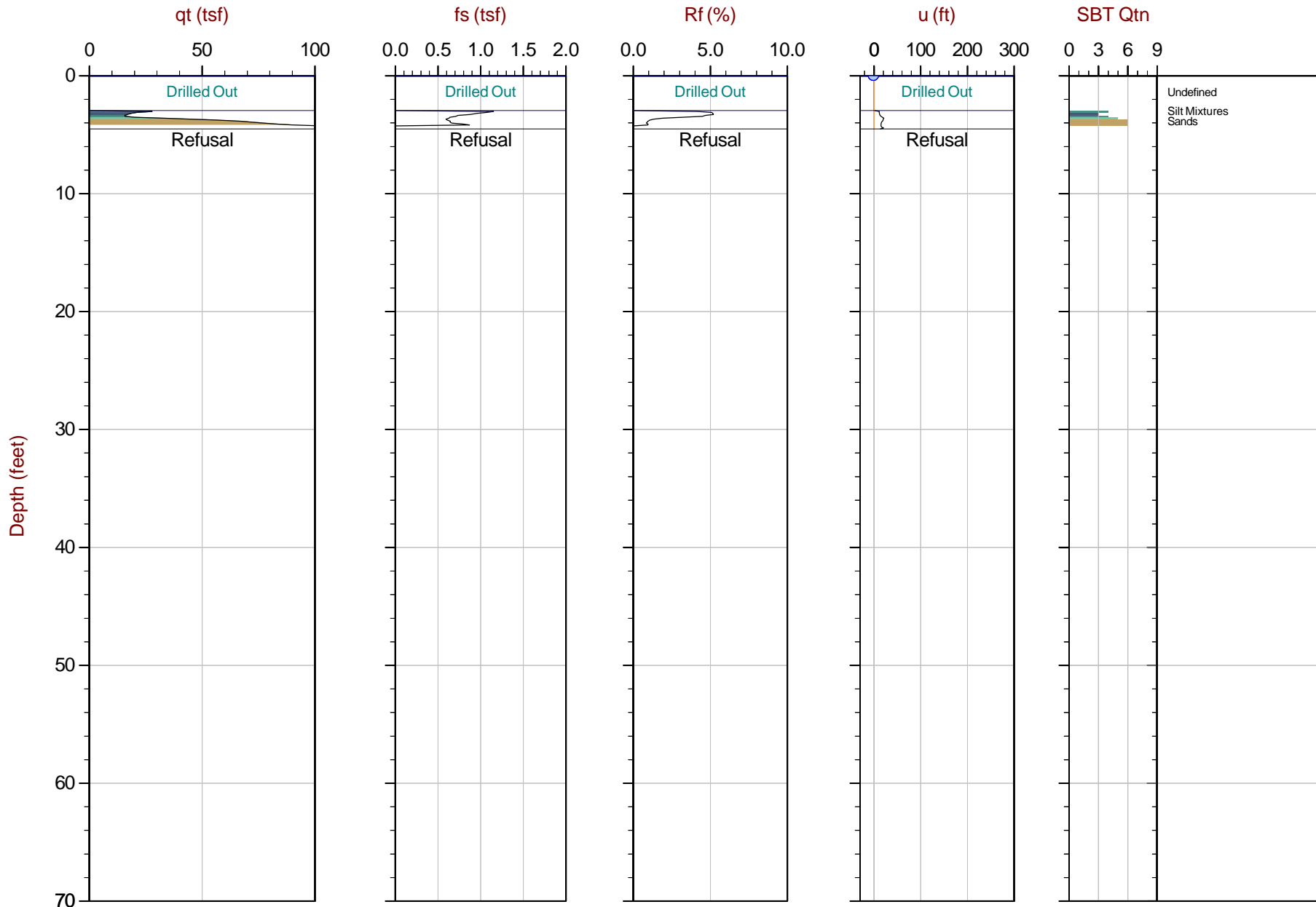

Max Depth: 1.375 m / 4.51 ft
 Depth Inc: 0.025 m / 0.082 ft
 Avg Int: Every Point

File: 22-61-23505_CP03.COR
 Unit Wt: SBTQtn(PKR2009)

SBT: Robertson, 2009 and 2010
 Coords: UTM 17N N: 4735386m E: 379529m

Overplot Item: ● Ueq ● Assumed Ueq ◀ Dissipation, Ueq achieved ◀ Dissipation, Ueq not achieved ◀ Dissipation, Ueq assumed — UeqLine — HydrostaticLine

The reported coordinates were acquired from consumer grade GPS equipment and are only approximate locations. The coordinates should not be used for design purposes.



Barr Engineering

Job No: 22-61-23505

Date: 2022-01-07 13:44

Site: DTE Energy St. Clair Power Plant

Sounding: CPT22-04

Cone: 706:T1500F15U35

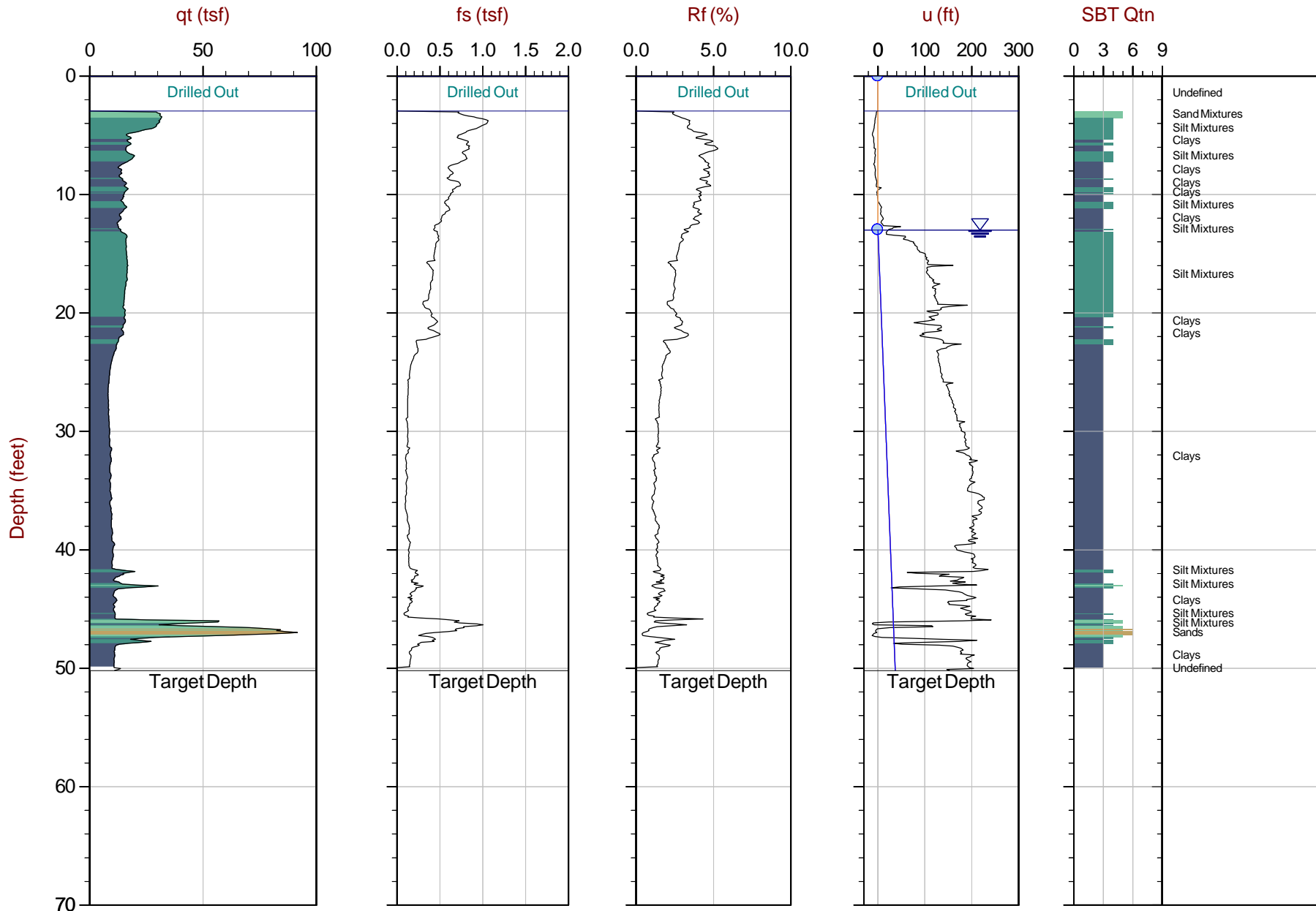

Max Depth: 15.300 m / 50.20 ft
 Depth Inc: 0.025 m / 0.082 ft
 Avg Int: Every Point

File: 22-61-23505_CP04.COR
 Unit Wt: SBTQtn(PKR2009)

SBT: Robertson, 2009 and 2010
 Coords: UTM 17N N: 4735328m E: 379515m

Overplot Item: ● Ueq ● Assumed Ueq ◁ Dissipation, Ueq achieved ◁ Dissipation, Ueq not achieved ◁ Dissipation, Ueq assumed — UeqLine — Hydrostatic Line

The reported coordinates were acquired from consumer grade GPS equipment and are only approximate locations. The coordinates should not be used for design purposes.



Barr Engineering

Job No: 22-61-23505

Date: 2022-01-07 14:51

Site: DTE Energy St. Clair Power Plant

Sounding: CPT22-05

Cone: 706:T1500F15U35

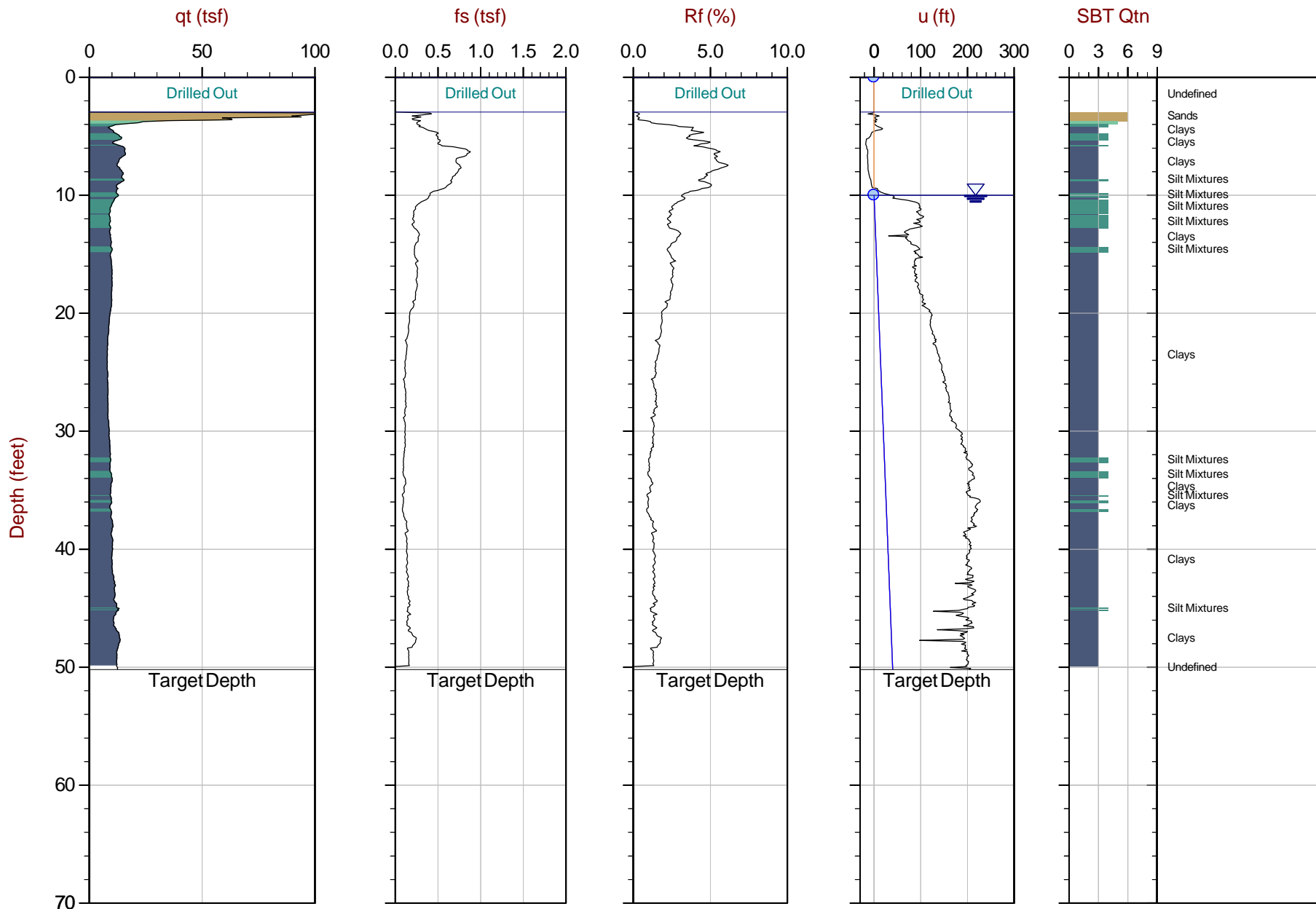

Max Depth: 15.300 m / 50.20 ft
 Depth Inc: 0.025 m / 0.082 ft
 Avg Int: Every Point

File: 22-61-23505_CP05.COR
 Unit Wt: SBTQtn(PKR2009)

SBT: Robertson, 2009 and 2010
 Coords: UTM 17N N: 4735320m E: 379476m

Overplot Item: ● Ueq ● Assumed Ueq ◁ Dissipation, Ueq achieved ◁ Dissipation, Ueq not achieved ◁ Dissipation, Ueq assumed — Ueq Line — Hydrostatic Line

The reported coordinates were acquired from consumer grade GPS equipment and are only approximate locations. The coordinates should not be used for design purposes.



Barr Engineering

Job No: 22-61-23505

Date: 2022-01-08 08:37

Site: DTE Energy St. Clair Power Plant

Sounding: CPT22-06

Cone: 706:T1500F15U35

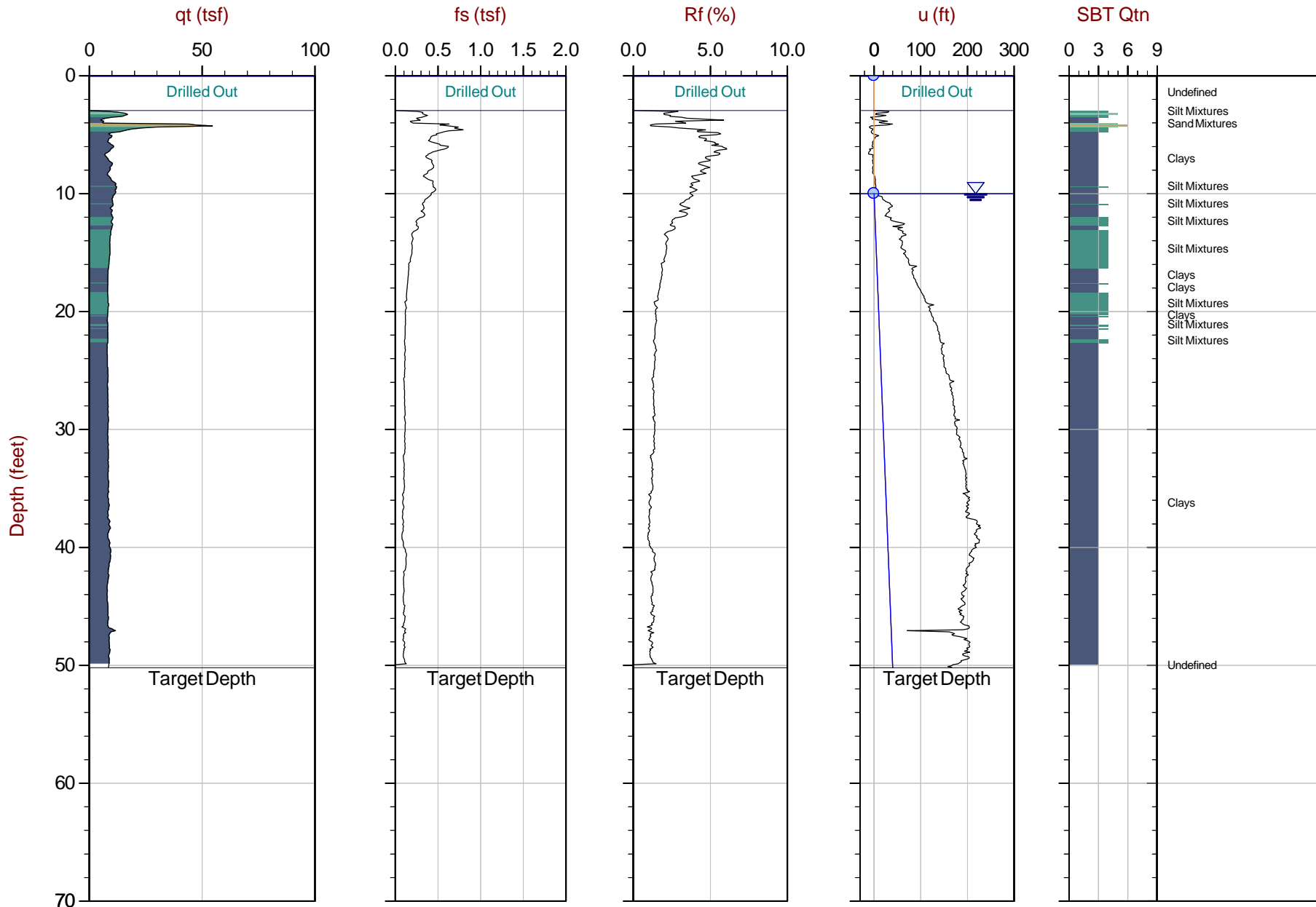

Max Depth: 15.300 m / 50.20 ft
 Depth Inc: 0.025 m / 0.082 ft
 Avg Int: Every Point

File: 22-61-23505_CP06.COR
 Unit Wt: SBTQtn(PKR2009)

SBT: Robertson, 2009 and 2010
 Coords: UTM 17N N: 4735396m E: 379484m

Overplot Item: ● Ueq ● Assumed Ueq ◁ Dissipation, Ueq achieved ◁ Dissipation, Ueq not achieved ◁ Dissipation, Ueq assumed — Ueq Line — Hydrostatic Line

The reported coordinates were acquired from consumer grade GPS equipment and are only approximate locations. The coordinates should not be used for design purposes.

Advanced Cone Penetration Plots with I_c , $S_u(N_{kt})$, OCR and $N1(60)I_c$



Barr Engineering

Job No: 22-61-23505
Date: 2022-01-07 09:12
Site: DTE Energy St. Clair Power Plant

Sounding: CPT22-01
Cone: 706:T1500F15U35

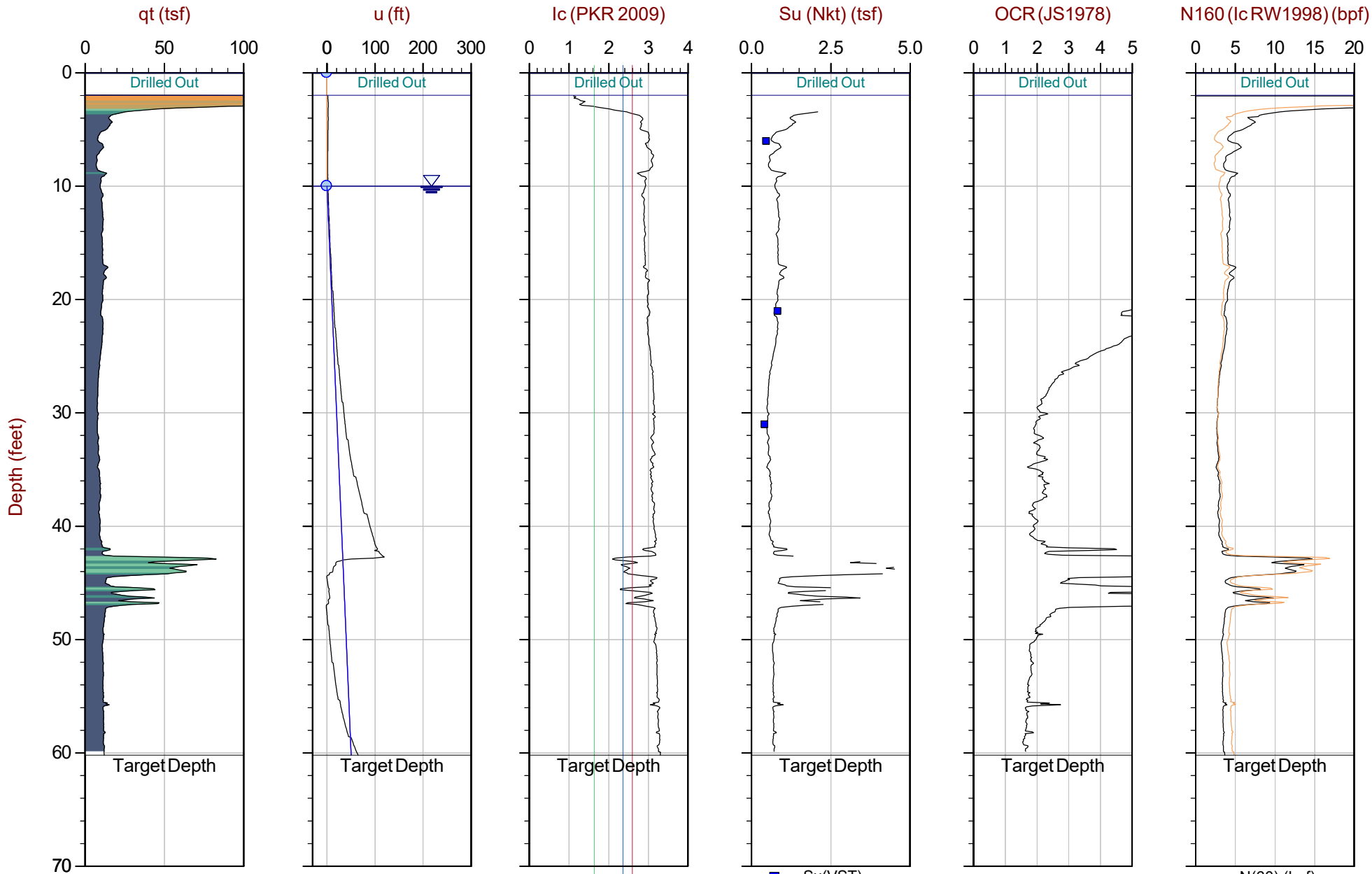

Max Depth: 18.350 m / 60.20 ft
Depth Inc: 0.025 m / 0.082 ft
Avg Int: Every Point

File: 22-61-23505_CP01.COR
Unit Wt: SBTQtn(PKR2009)
Su Nkt: 12.0

SBT: Robertson, 2009 and 2010
Coords: UTM 17N N: 4735398m E: 379574m

Overplot Item: ● Ueq ● Assumed Ueq ◁ Dissipation, Ueq achieved ◁ Dissipation, Ueq not achieved ◁ Dissipation, Ueq assumed — UeqLine — HydrostaticLine

The reported coordinates were acquired from consumer grade GPS equipment and are only approximate locations. The coordinates should not be used for design purposes.



Barr Engineering

Job No: 22-61-23505

Date: 2022-01-07 10:41

Site: DTE Energy St. Clair Power Plant

Sounding: CPT22-02

Cone: 06:T1500F15U35

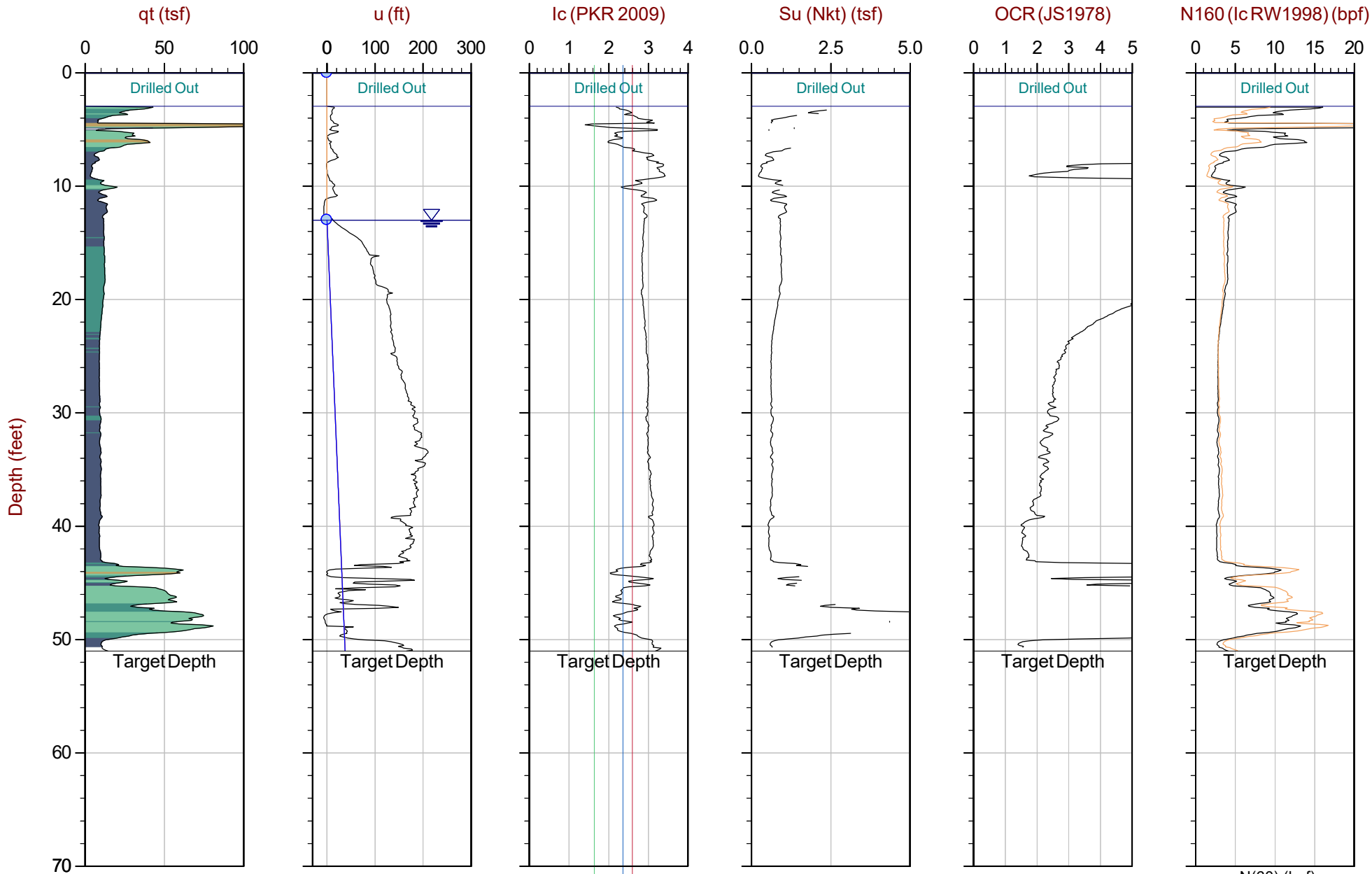

Max Depth: 15.550 m / 51.02 ft
 Depth Inc: 0.025 m / 0.082 ft
 Avg Int: Every Point

File: 22-61-23505_CP02.COR
 Unit Wt: SBTQtn(PKR2009)
 Su Nkt: 12.0

SBT: Robertson, 2009 and 2010
 Coords: UTM 17N N: 4735300m E: 379547m

Overplot Item: ● Ueq ● Assumed Ueq ◀ Dissipation, Ueq achieved ◀ Dissipation, Ueq not achieved ◀ Dissipation, Ueq assumed — UeqLine — HydrostaticLine

The reported coordinates were acquired from consumer grade GPS equipment and are only approximate locations. The coordinates should not be used for design purposes.



Barr Engineering

Job No: 22-61-23505
Date: 2022-01-07 13:30
Site: DTE Energy St. Clair Power Plant

Sounding: CPT22-03
Cone: 706:T1500F15U35

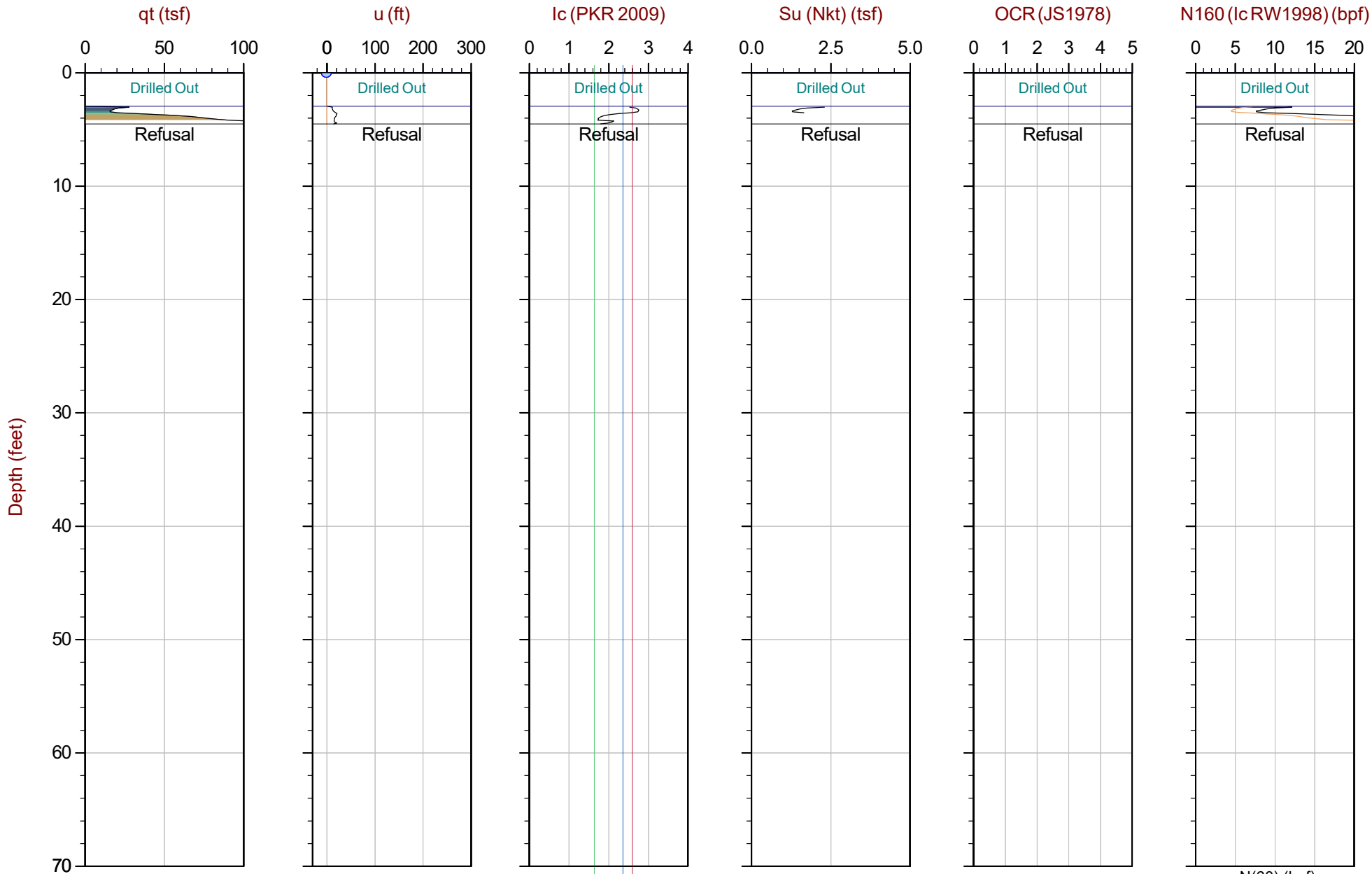

Max Depth: 1.375 m / 4.51 ft
Depth Inc: 0.025 m / 0.082 ft
Avg Int: Every Point

File: 22-61-23505_CP03.COR
Unit Wt: SBTQtn(PKR2009)
Su Nkt: 12.0

SBT: Robertson, 2009 and 2010
Coords: UTM 17N N: 4735386m E: 379529m

Overplot Item: ● Ueq ● Assumed Ueq ◁ Dissipation, Ueq achieved ◁ Dissipation, Ueq not achieved ◁ Dissipation, Ueq assumed — UeqLine — HydrostaticLine

The reported coordinates were acquired from consumer grade GPS equipment and are only approximate locations. The coordinates should not be used for design purposes.



Barr Engineering

Job No: 22-61-23505

Date: 2022-01-07 13:44

Site: DTE Energy St. Clair Power Plant

Sounding: CPT22-04

Cone: 706:T1500F15U35

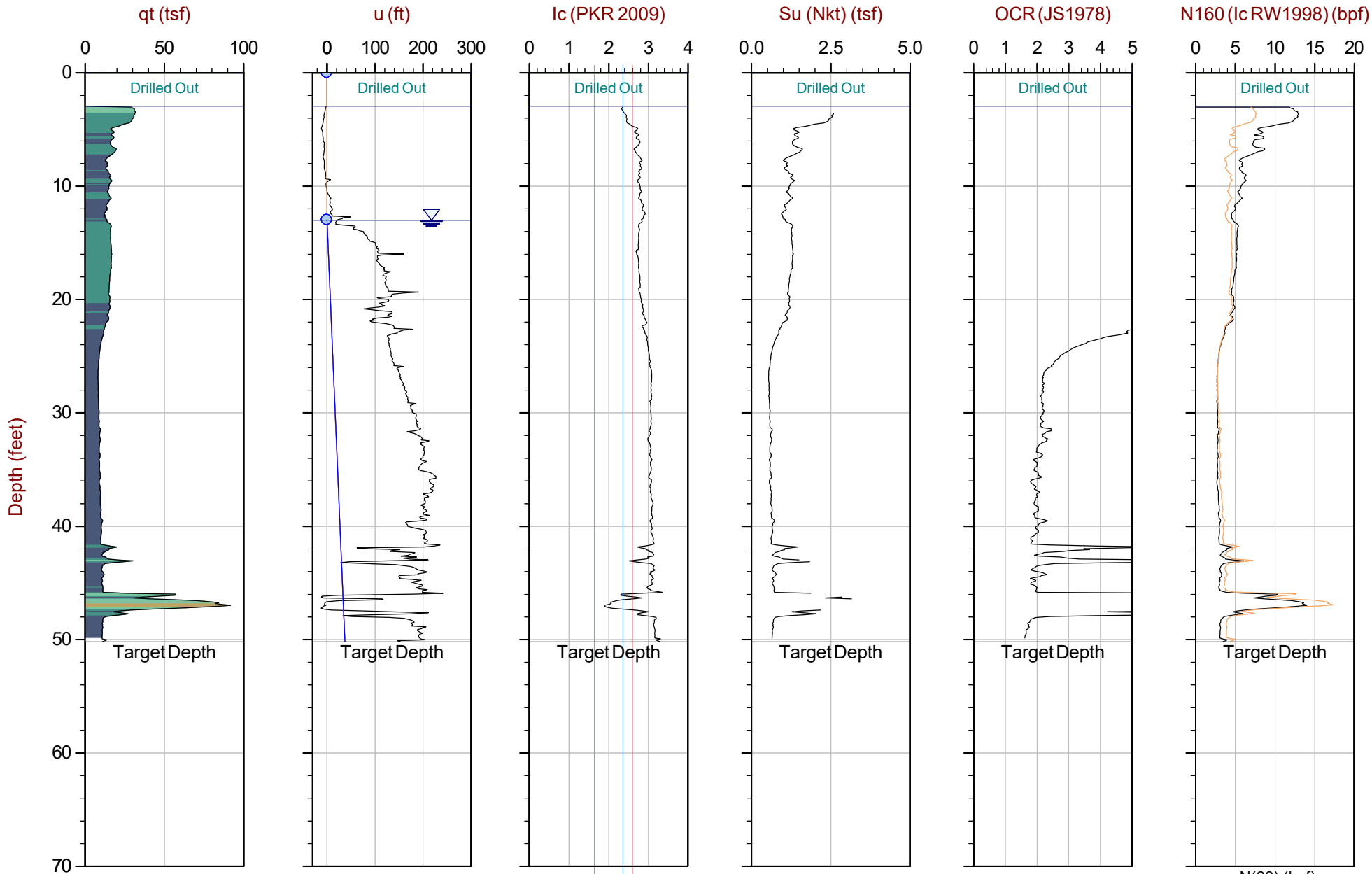

Max Depth: 15.300 m / 50.20 ft
 Depth Inc: 0.025 m / 0.082 ft
 Avg Int: Every Point

File: 22-61-23505_CP04.COR
 Unit Wt: SBTQtn(PKR2009)
 Su Nkt: 12.0

SBT: Robertson, 2009 and 2010
 Coords: UTM 17N N: 4735328m E: 379515m

Overplot Item: ● Ueq ● Assumed Ueq ◁ Dissipation, Ueq achieved ◁ Dissipation, Ueq not achieved ◁ Dissipation, Ueq assumed — UeqLine — HydrostaticLine

The reported coordinates were acquired from consumer grade GPS equipment and are only approximate locations. The coordinates should not be used for design purposes.



Barr Engineering

Job No: 22-61-23505

Date: 2022-01-07 14:51

Site: DTE Energy St. Clair Power Plant

Sounding: CPT22-05

Cone: 706:T1500F15U35

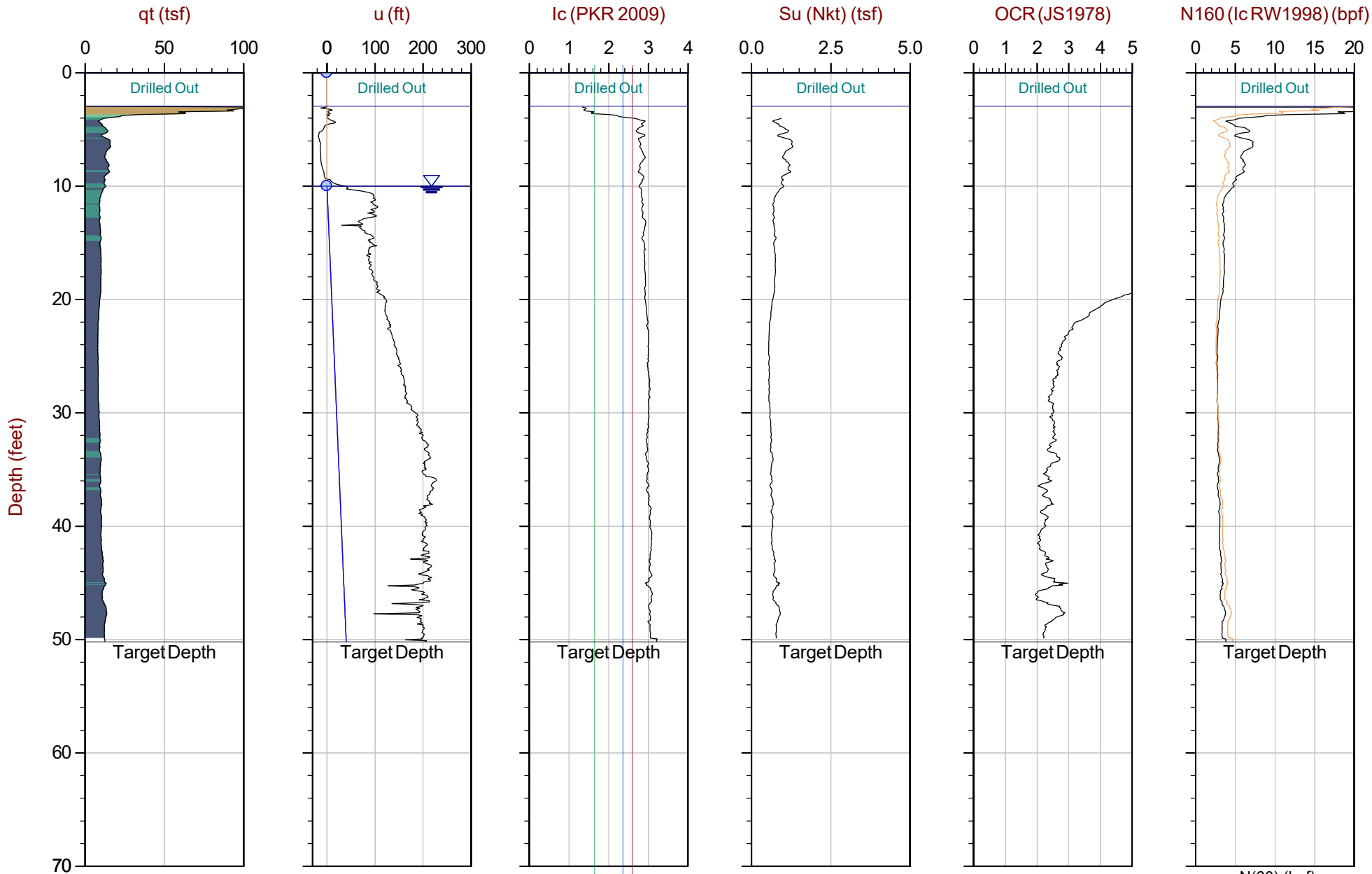

Max Depth: 15.300 m / 50.20 ft
 Depth Inc: 0.025 m / 0.082 ft
 Avg Int: Every Point

File: 22-61-23505_CP05.COR
 Unit Wt: SBTQtn(PKR2009)
 Su Nkt: 12.0

SBT: Robertson, 2009 and 2010
 Coords: UTM 17N N: 4735320m E: 379476m

Overplot Item: ● Ueq ● Assumed Ueq ◁ Dissipation, Ueq achieved ◁ Dissipation, Ueq not achieved ◁ Dissipation, Ueq assumed — UeqLine — HydrostaticLine

The reported coordinates were acquired from consumer grade GPS equipment and are only approximate locations. The coordinates should not be used for design purposes.



Barr Engineering

Job No: 22-61-23505
 Date: 2022-01-08 08:37
 Site: DTE Energy St. Clair Power Plant

Sounding: CPT22-06
 Cone: 706:T1500F15U35

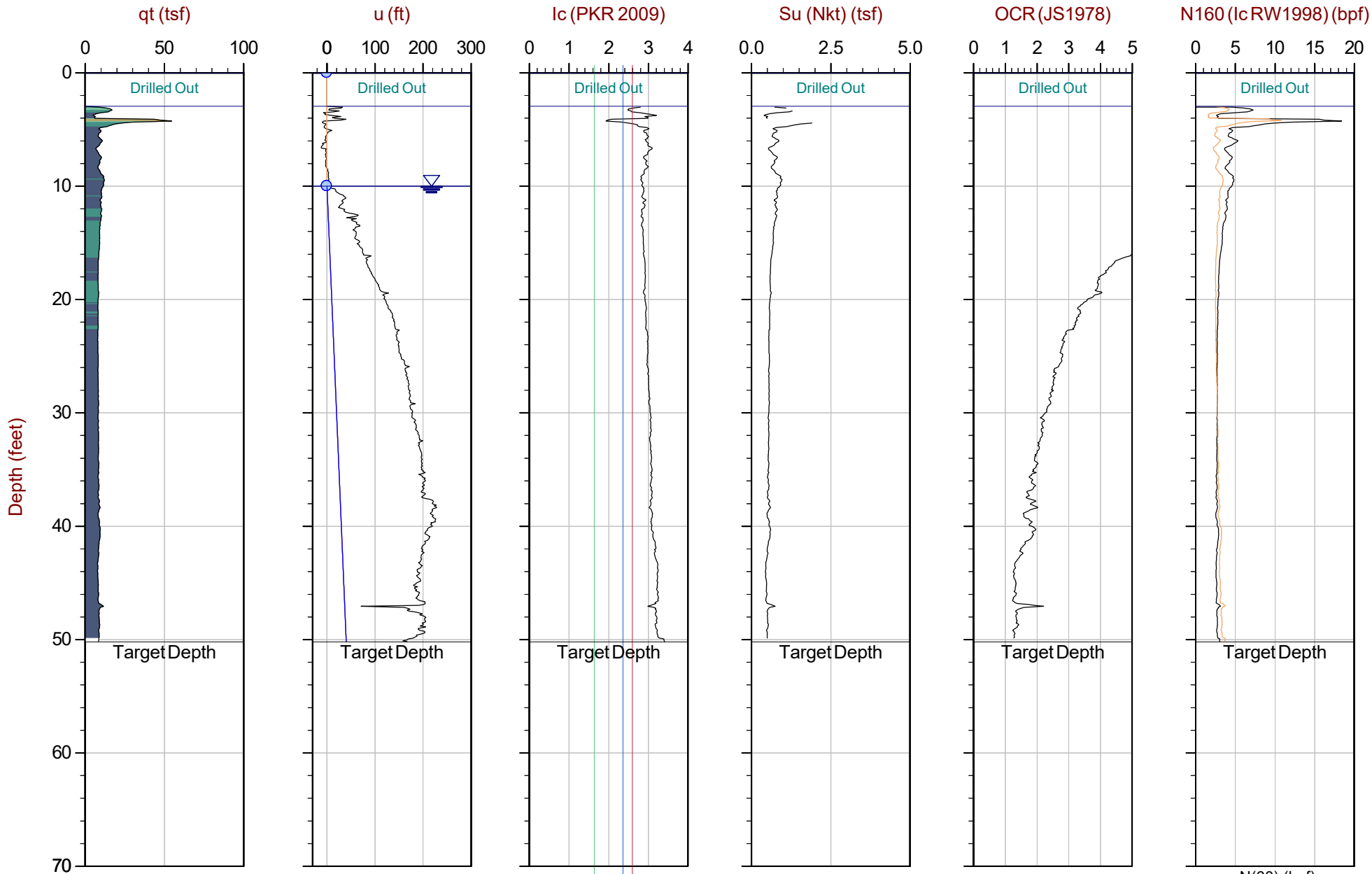

Max Depth: 15.300 m / 50.20 ft
 Depth Inc: 0.025 m / 0.082 ft
 Avg Int: Every Point

File: 22-61-23505_CP06.COR
 Unit Wt: SBTQtn(PKR2009)
 Su Nkt: 12.0

SBT: Robertson, 2009 and 2010
 Coords: UTM 17N N: 4735396m E: 379484m

Overplot Item: ● Ueq ● Assumed Ueq ◁ Dissipation, Ueq achieved ◁ Dissipation, Ueq not achieved ◁ Dissipation, Ueq assumed — UeqLine — HydrostaticLine

The reported coordinates were acquired from consumer grade GPS equipment and are only approximate locations. The coordinates should not be used for design purposes.

Soil Behavior Type (SBT) Scatter Plots

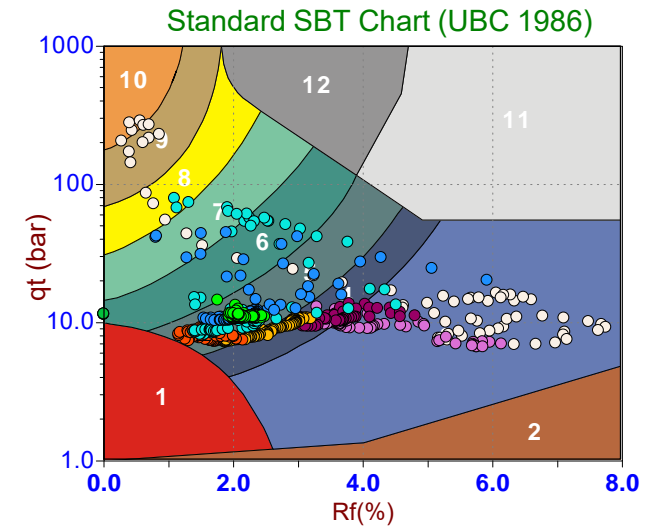
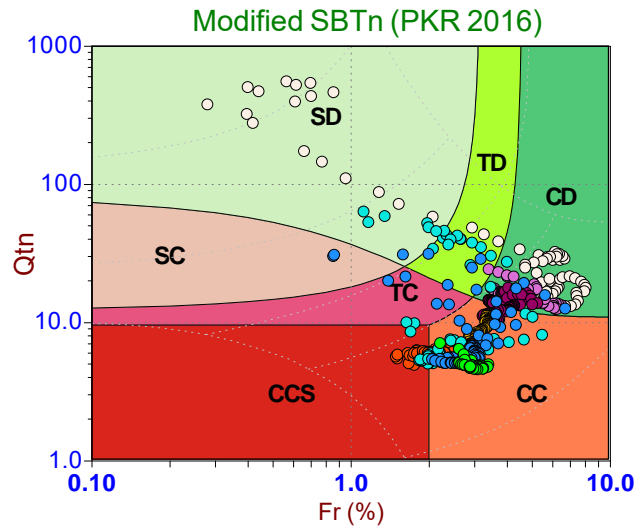
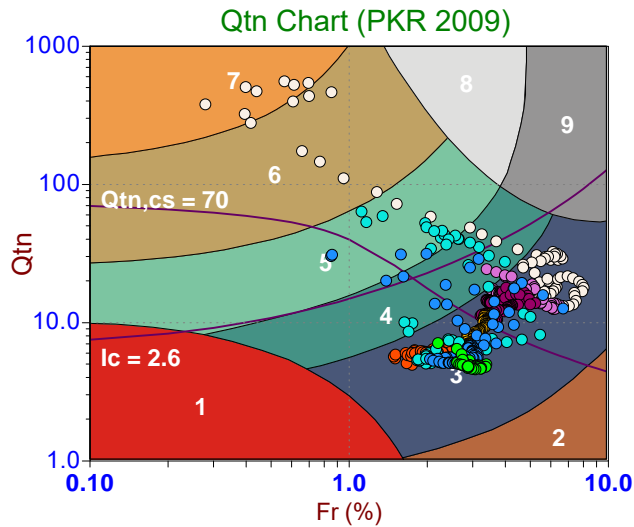

Depth Ranges

- >0.0 to 7.5 ft
- >7.5 to 15.0 ft
- >15.0 to 22.5 ft
- >22.5 to 30.0 ft
- >30.0 to 37.5 ft
- >37.5 to 45.0 ft
- >45.0 to 52.5 ft
- >52.5 to 60.0 ft
- >60.0 to 67.5 ft
- >67.5 to 75.0 ft
- >75.0 ft

Legend

- Sensitive, Fine Grained
- Organic Soils
- Clays
- Silt Mixtures
- Sand Mixtures
- Sands
- Gravelly Sand to Sand
- Stiff Sand to Clayey Sand
- Very Stiff Fine Grained

Legend

- CCS (Cont. sensitive clay like)
- CC (Cont. clay like)
- TC (Cont. transitional)
- SC (Cont. sand like)
- CD (Dil. clay like)
- TD (Dil. transitional)
- SD (Dil. sand like)

Legend

- Sensitive Fines
- Organic Soil
- Clay
- Silty Clay
- Clayey Silt
- Silt
- Sandy Silt
- Silty Sand/Sand
- Sand
- Gravelly Sand
- Stiff Fine Grained
- Cemented Sand

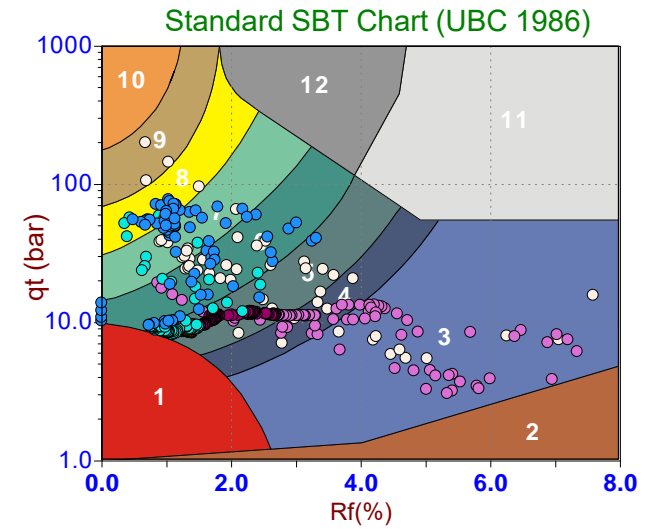
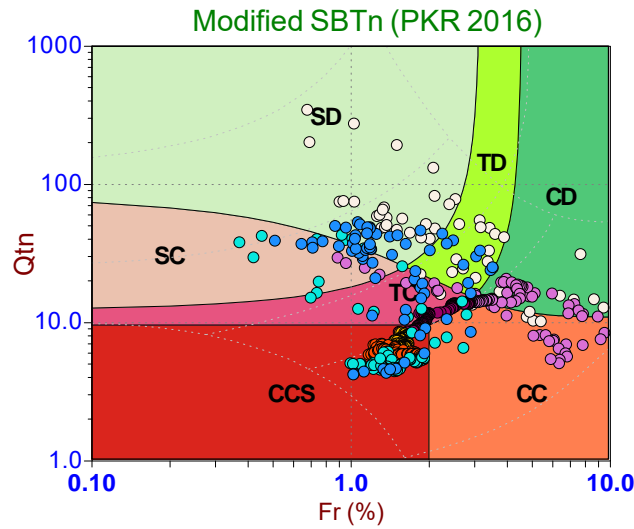
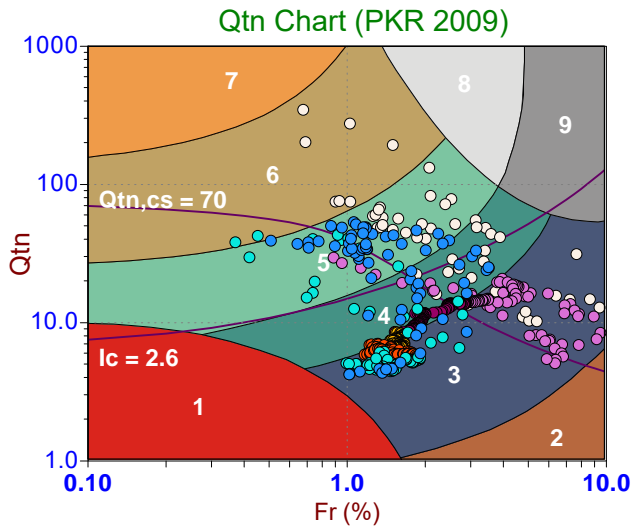

Depth Ranges

- >0.0 to 7.5 ft
- >7.5 to 15.0 ft
- >15.0 to 22.5 ft
- >22.5 to 30.0 ft
- >30.0 to 37.5 ft
- >37.5 to 45.0 ft
- >45.0 to 52.5 ft
- >52.5 to 60.0 ft
- >60.0 to 67.5 ft
- >67.5 to 75.0 ft
- >75.0 ft

Legend

- Sensitive, Fine Grained
- Organic Soils
- Clays
- Silt Mixtures
- Sand Mixtures
- Sands
- Gravelly Sand to Sand
- Stiff Sand to Clayey Sand
- Very Stiff Fine Grained

Legend

- CCS (Cont. sensitive clay like)
- CC (Cont. clay like)
- TC (Cont. transitional)
- SC (Cont. sand like)
- CD (Dil. clay like)
- TD (Dil. transitional)
- SD (Dil. sand like)

Legend

- Sensitive Fines
- Organic Soil
- Clay
- Silty Clay
- Clayey Silt
- Silt
- Sandy Silt
- Silty Sand/Sand
- Sand
- Gravelly Sand
- Stiff Fine Grained
- Cemented Sand

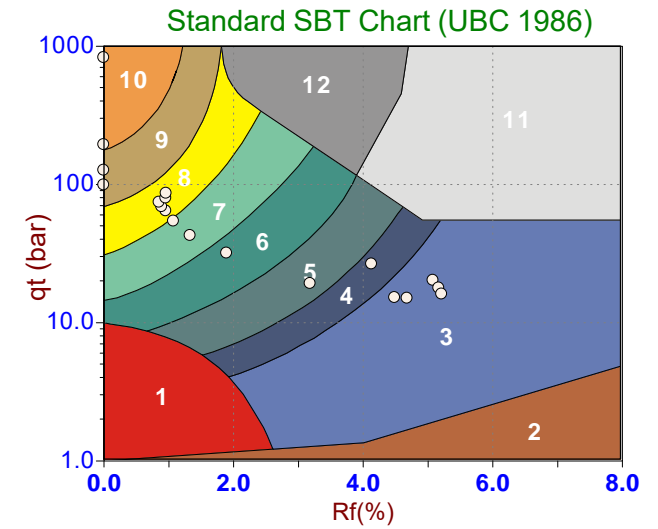
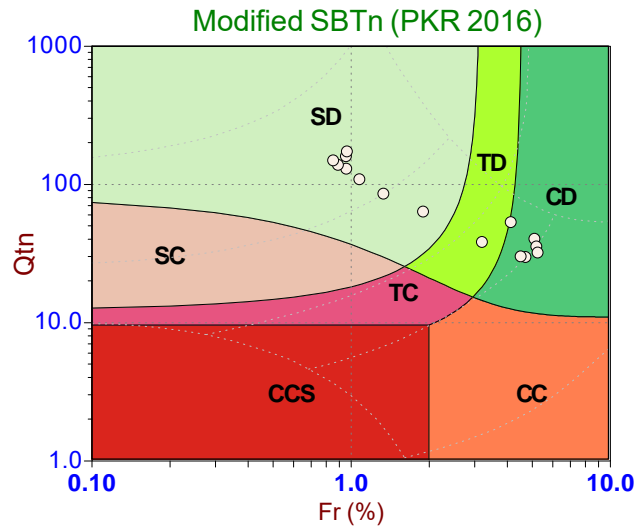
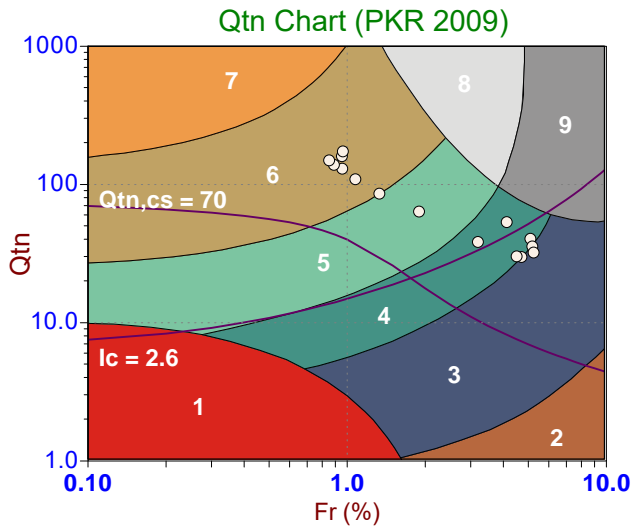

Depth Ranges

- >0.0 to 7.5 ft
- >7.5 to 15.0 ft
- >15.0 to 22.5 ft
- >22.5 to 30.0 ft
- >30.0 to 37.5 ft
- >37.5 to 45.0 ft
- >45.0 to 52.5 ft
- >52.5 to 60.0 ft
- >60.0 to 67.5 ft
- >67.5 to 75.0 ft
- >75.0 ft

Legend

- Sensitive, Fine Grained
- Organic Soils
- Clays
- Silt Mixtures
- Sand Mixtures
- Sands
- Gravelly Sand to Sand
- Stiff Sand to Clayey Sand
- Very Stiff Fine Grained

Legend

- CCS (Cont. sensitive clay like)
- CC (Cont. clay like)
- TC (Cont. transitional)
- SC (Cont. sand like)
- CD (Dil. clay like)
- TD (Dil. transitional)
- SD (Dil. sand like)

Legend

- Sensitive Fines
- Organic Soil
- Clay
- Silty Clay
- Clayey Silt
- Silt
- Sandy Silt
- Silty Sand/Sand
- Sand
- Gravelly Sand
- Stiff Fine Grained
- Cemented Sand

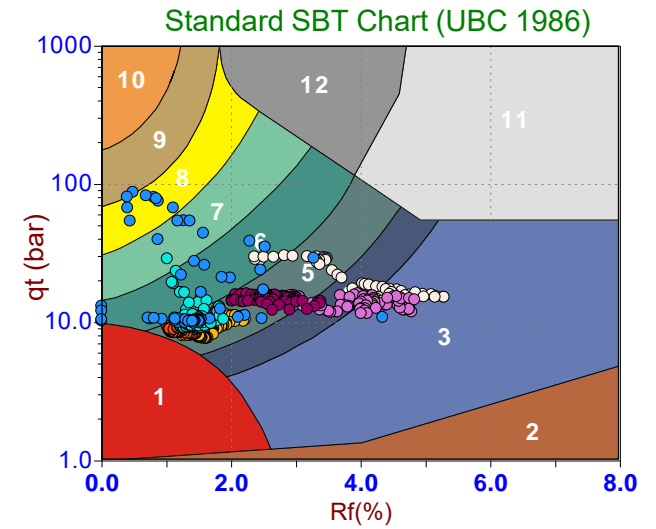
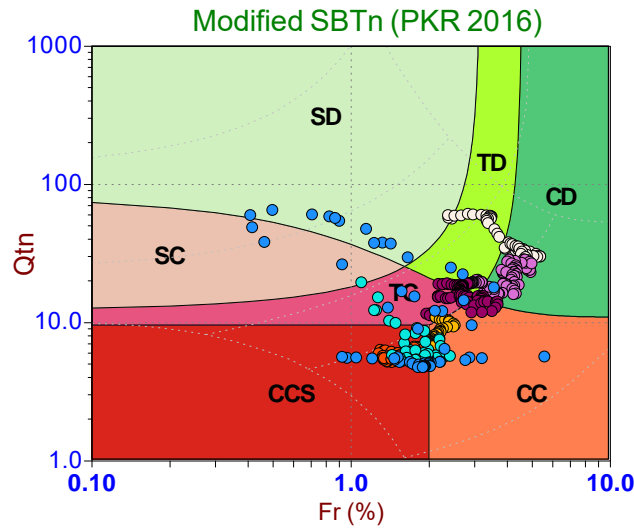
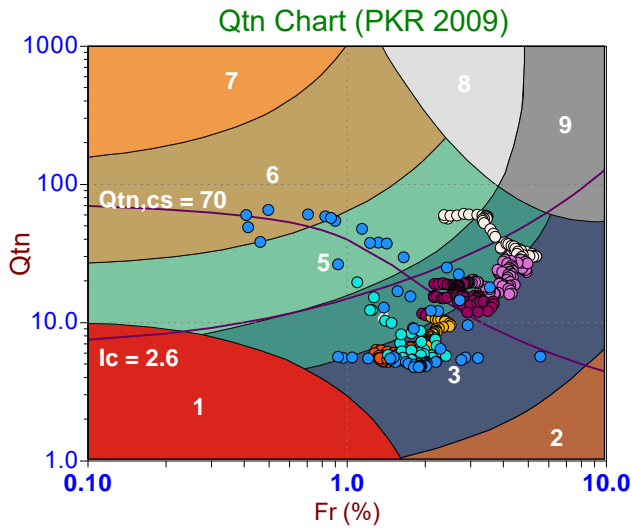

Depth Ranges

- >0.0 to 7.5 ft
- >7.5 to 15.0 ft
- >15.0 to 22.5 ft
- >22.5 to 30.0 ft
- >30.0 to 37.5 ft
- >37.5 to 45.0 ft
- >45.0 to 52.5 ft
- >52.5 to 60.0 ft
- >60.0 to 67.5 ft
- >67.5 to 75.0 ft
- >75.0 ft

Legend

- Sensitive, Fine Grained
- Organic Soils
- Clays
- Silt Mixtures
- Sand Mixtures
- Sands
- Gravelly Sand to Sand
- Stiff Sand to Clayey Sand
- Very Stiff Fine Grained

Legend

- CCS (Cont. sensitive clay like)
- CC (Cont. clay like)
- TC (Cont. transitional)
- SC (Cont. sand like)
- CD (Dil. clay like)
- TD (Dil. transitional)
- SD (Dil. sand like)

Legend

- Sensitive Fines
- Organic Soil
- Clay
- Silty Clay
- Clayey Silt
- Silt
- Sandy Silt
- Silty Sand/Sand
- Sand
- Gravelly Sand
- Stiff Fine Grained
- Cemented Sand

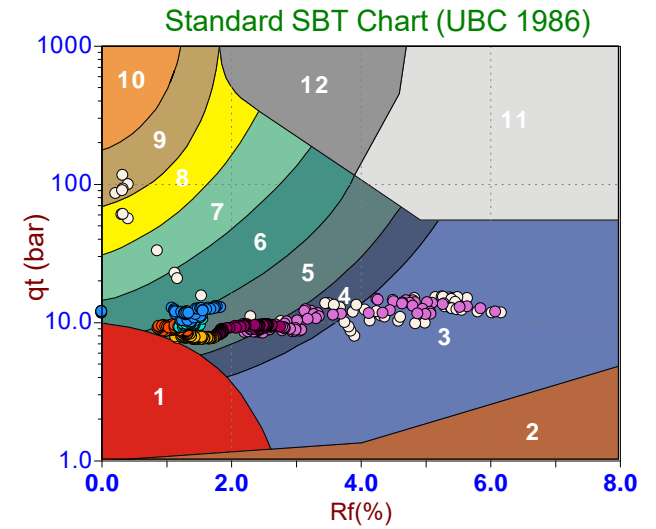
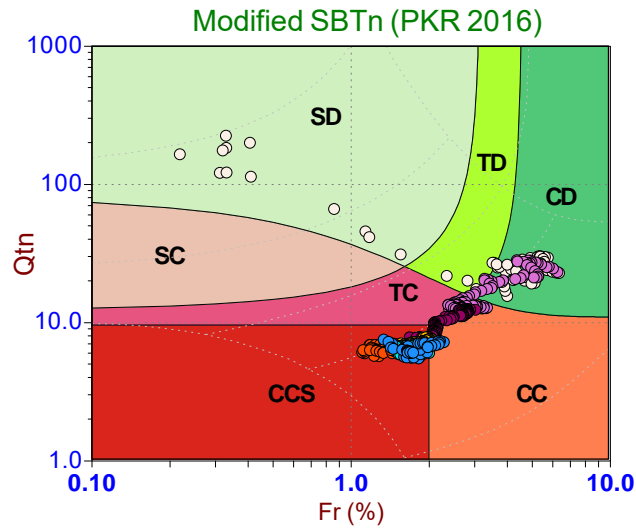
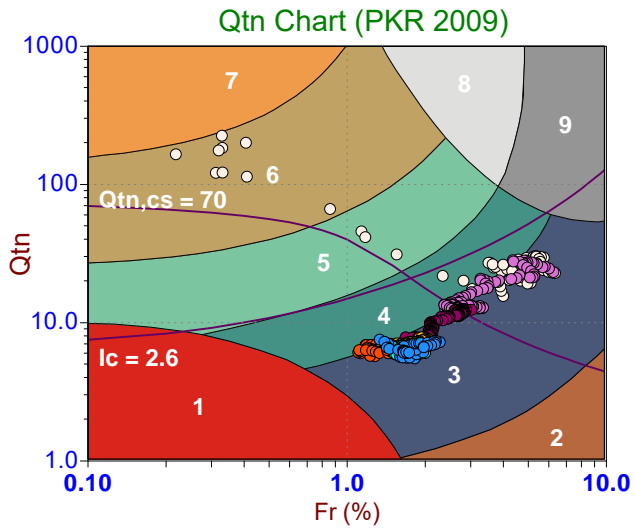

Depth Ranges

- >0.0 to 7.5 ft
- >7.5 to 15.0 ft
- >15.0 to 22.5 ft
- >22.5 to 30.0 ft
- >30.0 to 37.5 ft
- >37.5 to 45.0 ft
- >45.0 to 52.5 ft
- >52.5 to 60.0 ft
- >60.0 to 67.5 ft
- >67.5 to 75.0 ft
- >75.0 ft

Legend

- Sensitive, Fine Grained
- Organic Soils
- Clays
- Silt Mixtures
- Sand Mixtures
- Sands
- Gravelly Sand to Sand
- Stiff Sand to Clayey Sand
- Very Stiff Fine Grained

Legend

- CCS (Cont. sensitive clay like)
- CC (Cont. clay like)
- TC (Cont. transitional)
- SC (Cont. sand like)
- CD (Dil. clay like)
- TD (Dil. transitional)
- SD (Dil. sand like)

Legend

- Sensitive Fines
- Organic Soil
- Clay
- Silty Clay
- Clayey Silt
- Silt
- Sandy Silt
- Silty Sand/Sand
- Sand
- Gravelly Sand
- Stiff Fine Grained
- Cemented Sand

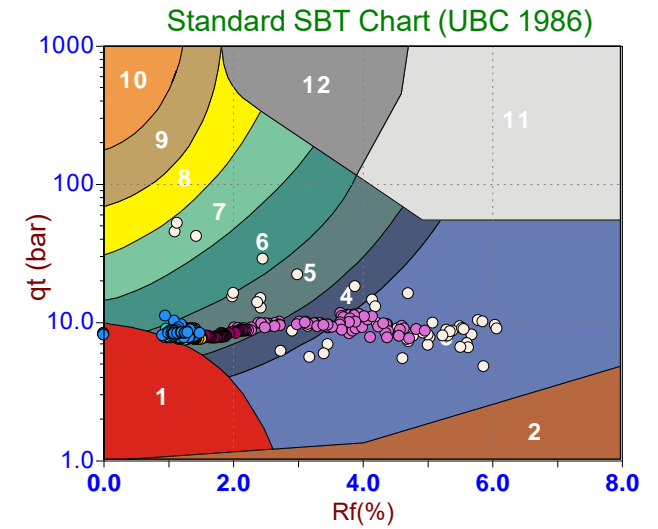
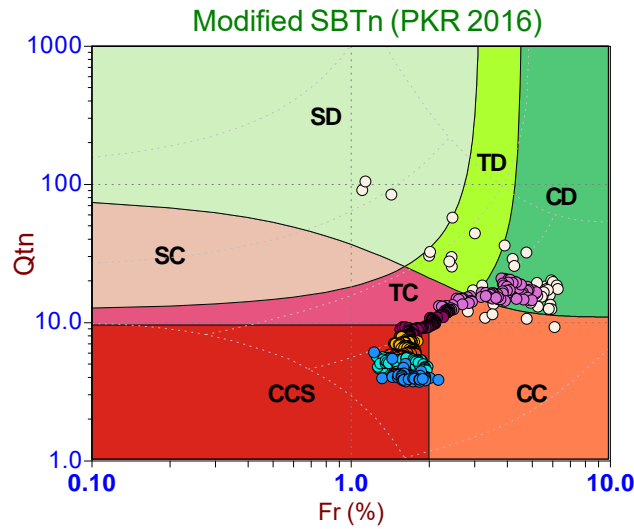
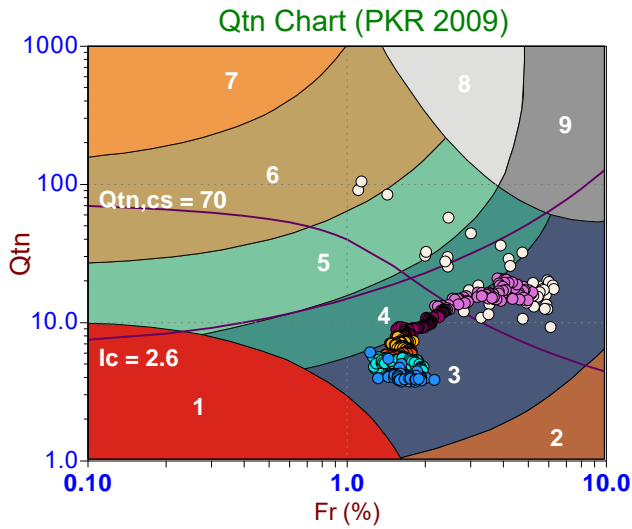

Depth Ranges

- >0.0 to 7.5 ft
- >7.5 to 15.0 ft
- >15.0 to 22.5 ft
- >22.5 to 30.0 ft
- >30.0 to 37.5 ft
- >37.5 to 45.0 ft
- >45.0 to 52.5 ft
- >52.5 to 60.0 ft
- >60.0 to 67.5 ft
- >67.5 to 75.0 ft
- >75.0 ft

Legend

- Sensitive, Fine Grained
- Organic Soils
- Clays
- Silt Mixtures
- Sand Mixtures
- Sands
- Gravelly Sand to Sand
- Stiff Sand to Clayey Sand
- Very Stiff Fine Grained

Legend

- CCS (Cont. sensitive clay like)
- CC (Cont. clay like)
- TC (Cont. transitional)
- SC (Cont. sand like)
- CD (Dil. clay like)
- TD (Dil. transitional)
- SD (Dil. sand like)

Legend

- Sensitive Fines
- Organic Soil
- Clay
- Silty Clay
- Clayey Silt
- Silt
- Sandy Silt
- Silty Sand/Sand
- Sand
- Gravelly Sand
- Stiff Fine Grained
- Cemented Sand

Description of Methods for Calculated CPT Geotechnical Parameters

CALCULATED CPT GEOTECHNICAL PARAMETERS

A Detailed Description of the Methods Used in ConeTec's CPT Geotechnical Parameter Calculation and Plotting Software

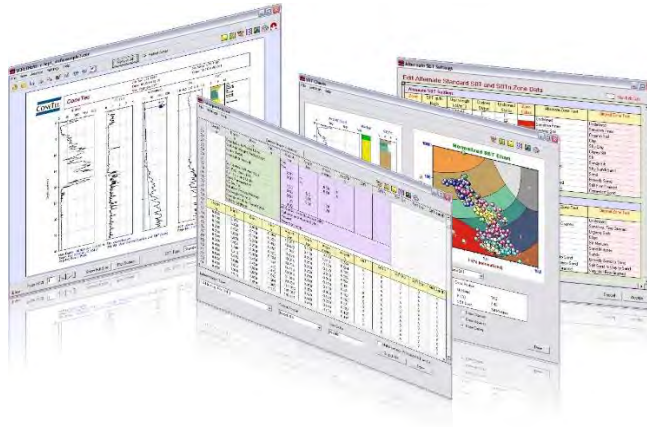

Revision SZW-Rev 14

Revised November 26, 2019

Prepared by Jim Greig, M.A.Sc, P.Eng (BC)



Limitations

The geotechnical parameter output was prepared specifically for the site and project named in the accompanying report subject to objectives, site conditions and criteria provided to ConeTec by the client. The output may not be relied upon by any other party or for any other site without the express written permission of ConeTec Group (ConeTec) or any of its affiliates. For this project, ConeTec has provided site investigation services, prepared factual data reporting and produced geotechnical parameter calculations consistent with current best practices. No other warranty, expressed or implied, is made.

To understand the calculations that have been performed and to be able to reproduce the calculated parameters the user is directed to the basic descriptions for the methods in this document and the detailed descriptions and their associated limitations and appropriateness in the technical references cited for each parameter.

ConeTec's Calculated CPT Geotechnical Parameters as of November 26, 2019

ConeTec's CPT parameter calculation and plotting routine provides a tabular output of geotechnical parameters based on current published CPT correlations and is subject to change to reflect the current state of practice. Due to drainage conditions and the basic assumptions and limitations of the correlations, not all geotechnical parameters provided are considered applicable for all soil types. The results are presented only as a guide for geotechnical use and should be carefully examined for consideration in any geotechnical design. Reference to current literature is strongly recommended. ConeTec does not warranty the correctness or the applicability of any of the geotechnical parameters calculated by the program and does not assume liability for any use of the results in any design or review. For verification purposes we recommend that representative hand calculations be done for any parameter that is critical for design purposes. The end user of the parameter output should also be fully aware of the techniques and the limitations of any method used by the program. The purpose of this document is to inform the user as to which methods were used and to direct the end user to the appropriate technical papers and/or publications for further reference.

The geotechnical parameter output was prepared specifically for the site and project named in the accompanying report subject to objectives, site conditions and criteria provided to ConeTec by the client. The output may not be relied upon by any other party or for any other site without the express written permission of ConeTec Group (ConeTec) or any of its affiliates.

The CPT calculations are based on values of tip resistance, sleeve friction and pore pressures considered at each data point or averaged over a user specified layer thickness (e.g. 0.20 m). Note that q_t is the tip resistance corrected for pore pressure effects and q_c is the recorded tip resistance. The corrected tip resistance (corrected using u_2 pore pressure values) is used for all of the calculations. Since all ConeTec cones have equal end area friction sleeves pore pressure corrections to sleeve friction, f_s , are not required.

The tip correction is: $q_t = q_c + (1-a) \cdot u_2$ (consistent units are implied)

where: q_t is the corrected tip resistance

q_c is the recorded tip resistance

u_2 is the recorded dynamic pore pressure behind the tip (u_2 position)

a is the Net Area Ratio for the cone (typically 0.80 for ConeTec cones)

The total stress calculations are based on soil unit weight values that have been assigned to the Soil Behavior Type (SBT) zones, from a user defined unit weight profile, by using a single uniform value throughout the profile, through unit weight estimation techniques described in various technical papers or from a combination of these methods. The parameter output files indicate the method(s) used.

Effective vertical overburden stresses are calculated based on a hydrostatic distribution of equilibrium pore pressures below the water table or from a user defined equilibrium pore pressure profile (typically obtained from CPT dissipation tests) or a combination of the two. For over water projects the stress effects of the column of water above the mudline have been taken into account as has the appropriate unit weight of water. How this is done depends on where the instruments were zeroed (i.e. on deck or at the mudline). The parameter output files indicate the method(s) used.

A majority of parameter calculations are derived or driven by results based on material types as determined by the various soil behavior type charts depicted in Figures 1 through 5. The parameter output files indicate the method(s) used.

The Soil Behavior Type classification chart shown in Figure 1 is the classic non-normalized SBT Chart developed at the University of British Columbia and reported in Robertson, Campanella, Gillespie and Greig (1986). Figure 2 shows the original normalized (linear method) SBT chart developed by Robertson (1990). The Bq classification charts shown in Figures 3a and 3b incorporate pore pressures into the SBT classification and are based on the methods described in Robertson (1990). Many of these charts have been summarized in Lunne, Robertson and Powell (1997). The



Jefferies and Davies SBT chart shown in Figure 3c is based on the techniques discussed in Jefferies and Davies (1993) which introduced the concept of the Soil Behavior Type Index parameter, I_c . Please note that the I_c parameter developed by Robertson and Fear (1995) and Robertson and Wride (1998) is similar in concept but uses a slightly different calculation method than that used by Jefferies and Davies (1993) as the latter incorporates pore pressure in their technique through the use of the B_q parameter. The normalized Q_{tn} SBT chart shown in Figure 4 is based on the work by Robertson (2009) utilizing a variable stress ratio exponent, n , for normalization based on a slightly modified redefinition and iterative approach for I_c . The boundary curves drawn on the chart are based on the work described in Robertson (2010).

Figure 5 shows a revised behavior based chart by Robertson (2016) depicting contractive-dilatative zones. As the zones represent material behavior rather than soil gradation ConeTec has chosen a set of zone colors that are less likely to be confused with material type colors from previous SBT charts. These colors differ from those used by Dr. Robertson.

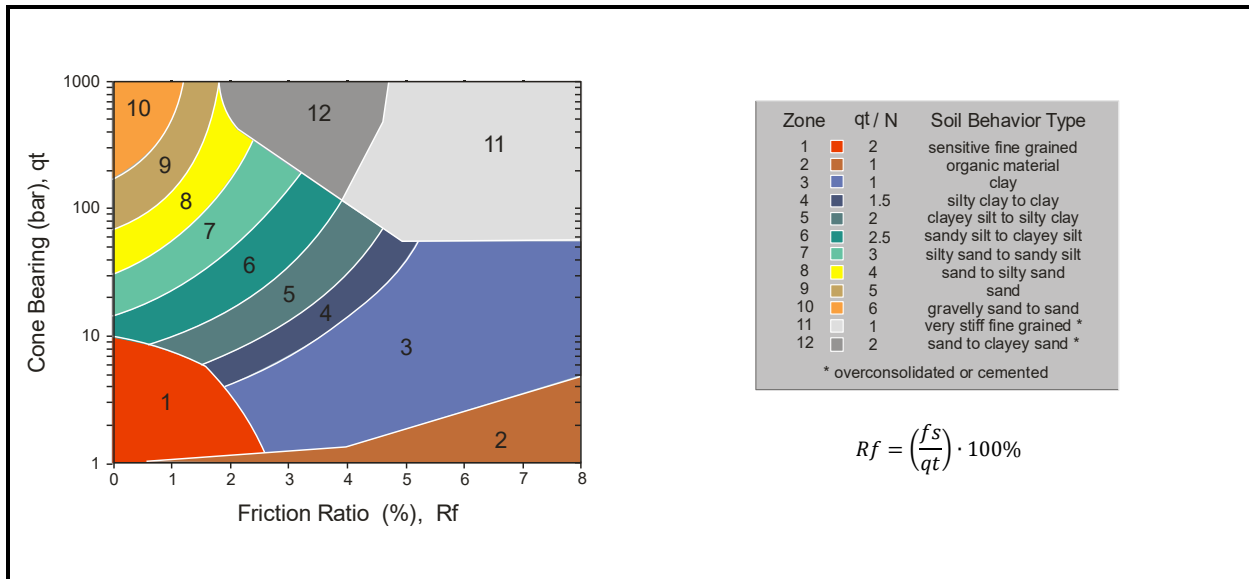

Figure 1. Non-Normalized Soil Behavior Type Classification Chart (SBT)

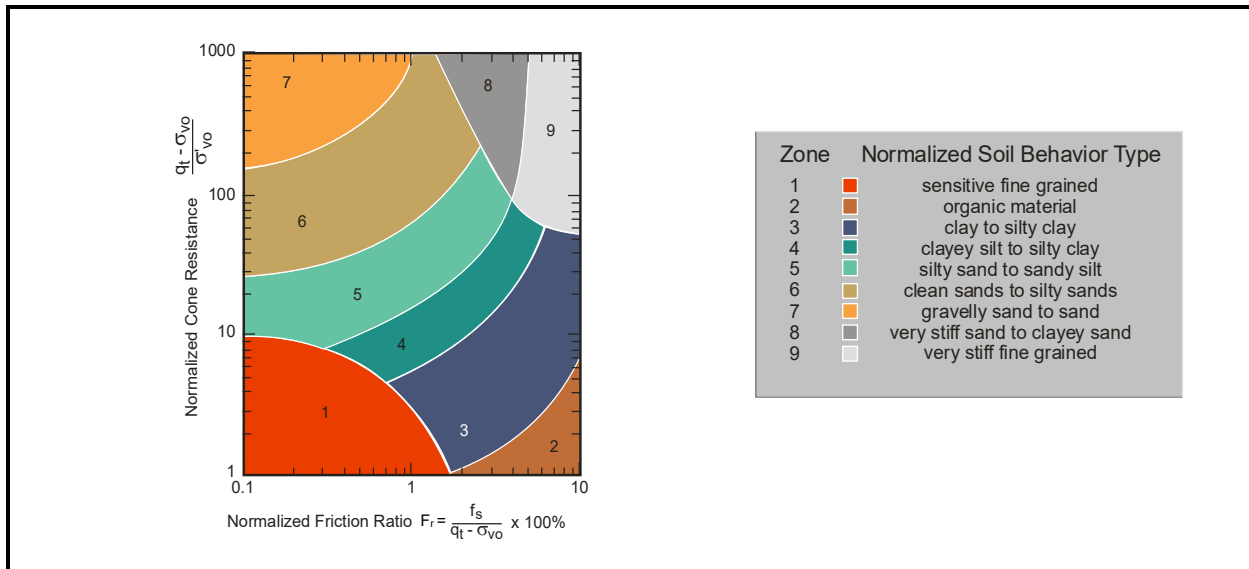

Figure 2. Normalized Soil Behavior Type Classification Chart (SBTn)

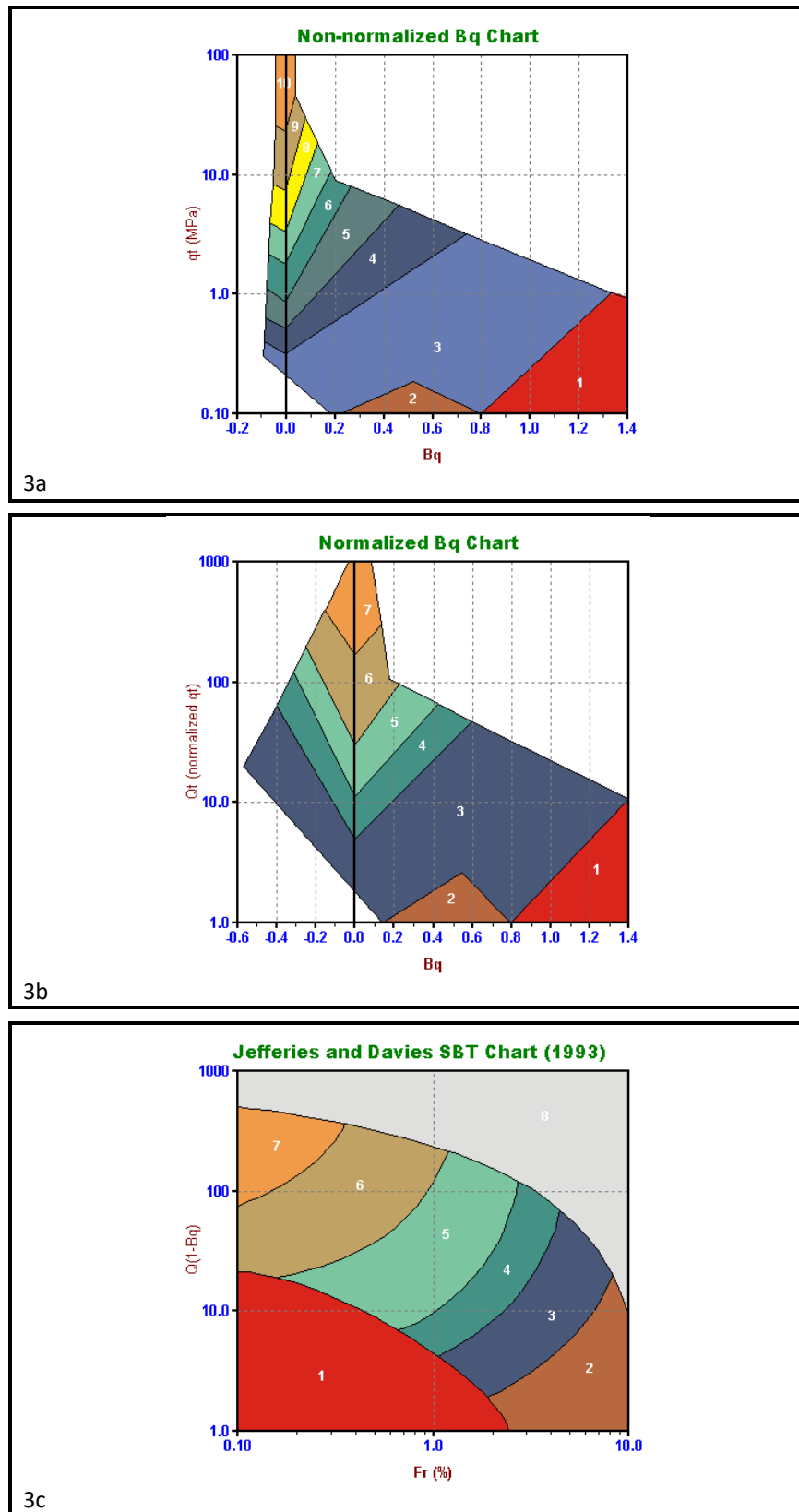

Figure 3. Alternate Soil Behavior Type Charts

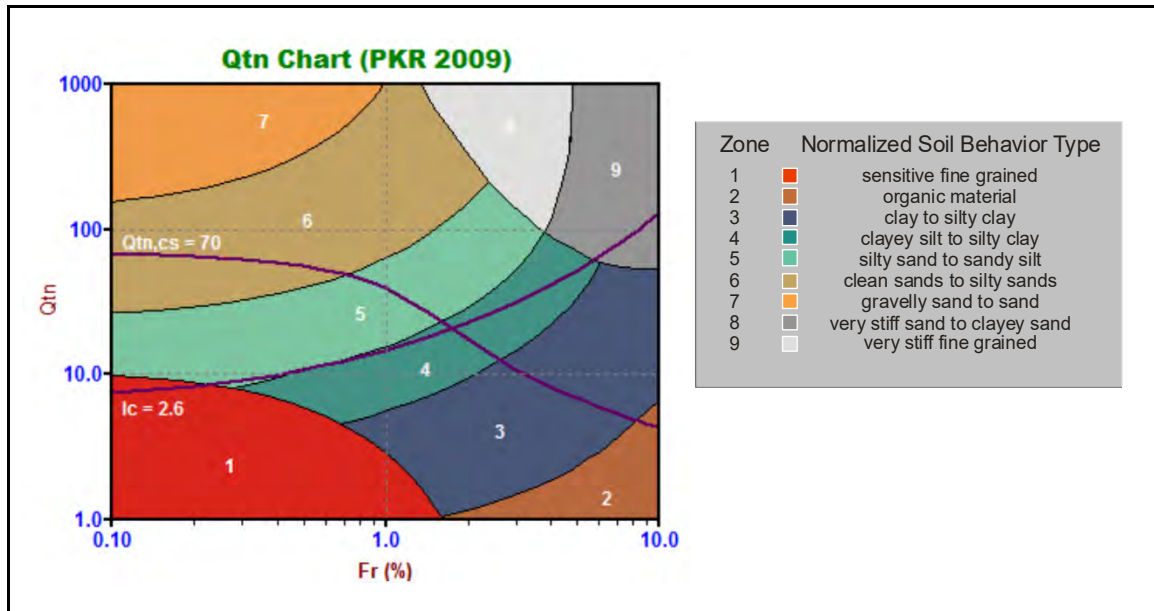

Figure 4. Normalized Soil Behavior Type Chart using Q_{tn} (SBT Q_{tn})

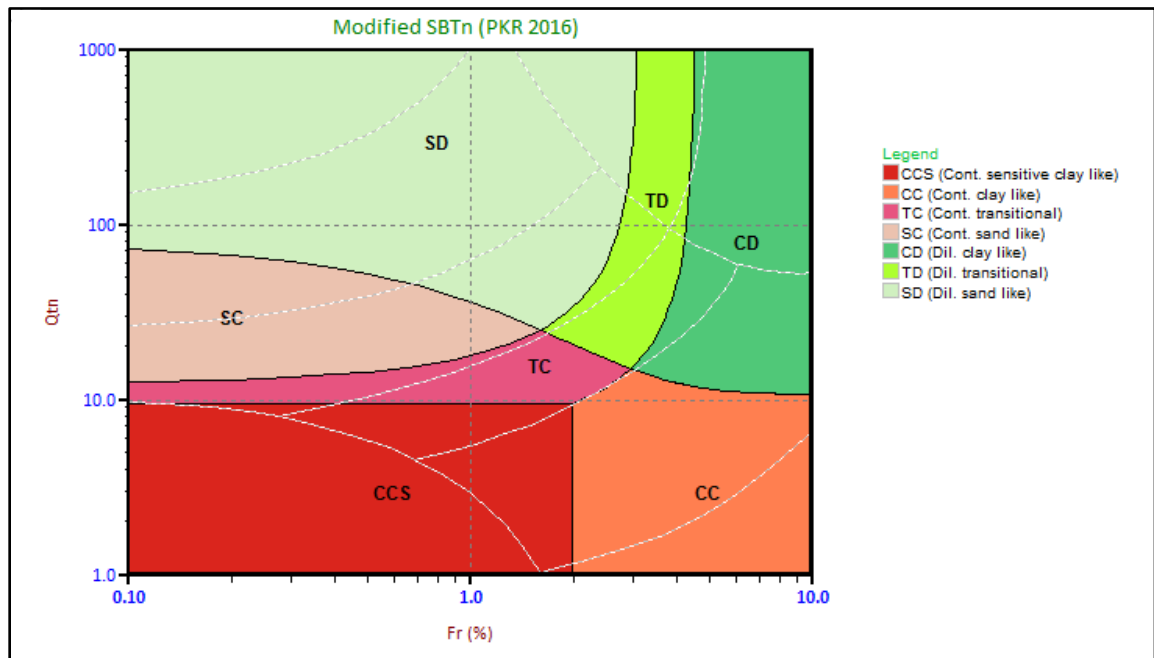

Figure 5. Modified SBTn Behavior Based Chart

Details regarding the geotechnical parameter calculations are provided in Tables 1a and 1b. The appropriate references cited are listed in Table 2. Non-liquefaction specific parameters are detailed in Table 1a and liquefaction specific parameters are detailed in Table 1b.

Where methods are based on charts or techniques that are too complex to describe in this summary the user should refer to the cited material. Specific limitations for each method are described in the cited material.

Where the results of a calculation/correlation are deemed 'invalid' the value will be represented by the text strings "-9999", "-9999.0", the value 0.0 (Zero) or an empty cell. Invalid results will occur because of (and not limited to) one or a combination of:

1. Invalid or undefined CPT data (e.g. drilled out section or data gap).
2. Where the calculation method is inappropriate, for example, drained parameters in a material behaving as an undrained material (and vice versa).
3. Where input values are beyond the range of the referenced charts or specified limitations of the correlation method.
4. Where pre-requisite or intermediate parameter calculations are invalid.

The parameters selected for output from the program are often specific to a particular project. As such, not all of the calculated parameters listed in Table 1 may be included in the output files delivered with this report.

The output files are typically provided in Microsoft Excel XLS or XLSX format. The ConeTec software has several options for output depending on the number or types of calculated parameters desired or requested by the client. Each output file is named using the original COR file base name followed by a three or four letter indicator of the output set selected (e.g. BSC, TBL, NLI, NL2, IFI, IFI2) and possibly followed by an operator selected suffix identifying the characteristics of the particular calculation run.

Table 1a. CPT Parameter Calculation Methods – Non liquefaction Parameters

Calculated Parameter	Description	Equation	Ref
Depth	Mid Layer Depth <i>(where calculations are done at each point then Mid Layer Depth = Recorded Depth)</i>	$[Depth (Layer Top) + Depth (Layer Bottom)] / 2.0$	CK*
Elevation	Elevation of Mid Layer based on sounding collar elevation supplied by client or through site survey	Elevation = Collar Elevation - Depth	CK*
Avg qc	Averaged recorded tip value (q_c)	$Avgqc = \frac{1}{n} \sum_{i=1}^n q_c$ <i>n=1 when calculations are done at each point</i>	CK*
Avg qt	Averaged corrected tip (q_t) where: $q_t = q_c + (1-a) \bullet u_2$	$Avgqt = \frac{1}{n} \sum_{i=1}^n q_t$ <i>n=1 when calculations are done at each point</i>	1
Avg fs	Averaged sleeve friction (f_s)	$Avgfs = \frac{1}{n} \sum_{i=1}^n f_s$ <i>n=1 when calculations are done at each point</i>	CK*
Avg Rf	Averaged friction ratio (R_f) where friction ratio is defined as: $R_f = 100\% \bullet \frac{f_s}{q_t}$	$AvgRf = 100\% \bullet \frac{Avgfs}{Avgqt}$ <i>n=1 when calculations are done at each point</i>	CK*
Avg u	Averaged dynamic pore pressure (u)	$Avgu = \frac{1}{n} \sum_{i=1}^n u_i$ <i>n=1 when calculations are done at each point</i>	CK*

Calculated Parameter	Description	Equation	Ref
Avg Res	Averaged Resistivity (this data is not always available since it is a specialized test requiring an additional module)	$AvgRes = \frac{1}{n} \sum_{i=1}^n Resistivity_i$ <i>n=1 when calculations are done at each point</i>	CK*
Avg UVIF	Averaged UVIF ultra-violet induced fluorescence (this data is not always available since it is a specialized test requiring an additional module)	$AvgUVIF = \frac{1}{n} \sum_{i=1}^n UVIF_i$ <i>n=1 when calculations are done at each point</i>	CK*
Avg Temp	Averaged Temperature (this data is not always available since it requires specialized calibrations)	$AvgTemp = \frac{1}{n} \sum_{i=1}^n Temperature_i$ <i>n=1 when calculations are done at each point</i>	CK*
Avg Gamma	Averaged Gamma Counts (this data is not always available since it is a specialized test requiring an additional module)	$AvgGamma = \frac{1}{n} \sum_{i=1}^n Gamma_i$ <i>n=1 when calculations are done at each point</i>	CK*
SBT	Soil Behavior Type as defined by Robertson et al 1986 (often referred to as Robertson and Campanella, 1986)	See Figure 1	1, 5
SBTn	Normalized Soil Behavior Type as defined by Robertson 1990 (linear normalization)	See Figure 2	2, 5
SBT-Bq	Non-normalized Soil Behavior type based on the Bq parameter	See Figure 3	1, 2, 5
SBT-Bqn	Normalized Soil Behavior based on the Bq parameter	See Figure 3	2, 5
SBT-JandD	Soil Behavior Type as defined by Jeffries and Davies	See Figure 3	7
SBT Qtn	Soil Behavior Type as defined by Robertson (2009) using a variable stress ratio exponent for normalization based on I_c	See Figure 4	15
Modified SBTn (contractive /dilative)	Modified SBTn chart as defined by Robertson (2016) indicating zones of contractive/dilative behavior.	See Figure 5	30
Unit Wt.	<p>Unit Weight of soil determined from one of the following user selectable options:</p> <ol style="list-style-type: none"> 1) uniform value 2) value assigned to each SBT zone 3) value assigned to each SBTn zone 4) value assigned to SBTn zone as determined from Robertson and Wride (1998) based on q_{c1n} 5) values assigned to SBT Qtn zones 6) Mayne f_s (sleeve friction) method 7) Robertson 2010 method 8) user supplied unit weight profile <p>The last option may co-exist with any of the other options</p>	See references	3, 5, 15, 21, 24, 29

Calculated Parameter	Description	Equation	Ref
TStress σ_v	<p>Total vertical overburden stress at Mid Layer Depth</p> <p><i>A layer is defined as the averaging interval specified by the user where depths are reported at their respective mid-layer depth.</i></p> <p><i>For data calculated at each point layers are defined using the recorded depth as the mid-point of the layer. Thus, a layer starts half-way between the previous depth and the current depth unless this is the first point in which case the layer start is at zero depth. The layer bottom is half-way from the current depth to the next depth unless it is the last data point.</i></p> <p><i>Defining layers affects how stresses are calculated since the unit weight attributed to a data point is used throughout the entire layer. This means that to calculate the stresses the total stress at the top and bottom of a layer are required. The stress at mid layer is determined by adding the incremental stress from the layer top to the mid-layer depth. The stress at the layer bottom becomes the stress at the top of the subsequent layer. Stresses are NOT calculated from mid-point to mid-point.</i></p> <p><i>For over-water work the total stress due to the column of water above the mud line is taken into account where appropriate.</i></p>	$TStress = \sum_{i=1}^n \gamma_i h_i$ <p>where γ_i is layer unit weight h_i is layer thickness</p>	CK*
EStress σ_v'	Effective vertical overburden stress at mid-layer depth	$\sigma_v' = \sigma_v - u_{eq}$	CK*
Equil u u _{eq} OR u ₀	<p>Equilibrium pore pressure determined from one of the following user selectable options:</p> <ol style="list-style-type: none"> 1) hydrostatic below water table 2) user supplied profile 3) combination of those above <p>When a user supplied profile is used/provided a linear interpolation is performed between equilibrium pore pressures defined at specific depths. If the profile values start below the water table then a linear transition from zero pressure at the water table to the first defined pointed is used.</p> <p>Equilibrium pore pressures may come from dissipation tests, adjacent piezometers or other sources. Occasionally, an extra equilibrium point (“assumed value”) will be provided in the profile that does not come from a recorded value to smooth out any abrupt changes or to deal with material interfaces. These “assumed” values will be indicated on our plots and in tabular summaries.</p>	<p>For hydrostatic option:</p> $u_{eq} = \gamma_w \cdot (D - D_{wt})$ <p>where u_{eq} is equilibrium pore pressure γ_w is unit weight of water D is the current depth D_{wt} is the depth to the water table</p>	CK*
K ₀	Coefficient of earth pressure at rest, K ₀	$K_0 = (1 - \sin\Phi') OCR^{\sin\Phi'}$	17
C _n	Overburden stress correction factor used for (N ₁) ₆₀ and older CPT parameters	$C_n = (P_a/\sigma_v')^{0.5}$ <p>where $0.0 < C_n < 2.0$ (user adjustable, typically 1.7) P_a is atmospheric pressure (100 kPa)</p>	12
C _q	Overburden stress normalizing factor	$C_q = 1.8 / (0.8 + (\sigma_v'/P_a))$ <p>where $0.0 < C_q < 2.0$ (user adjustable) P_a is atmospheric pressure (100 kPa)</p>	3, 12

Calculated Parameter	Description	Equation	Ref
N ₆₀	SPT N value at 60% energy calculated from q _t /N ratios assigned to each SBT zone. This method has abrupt N value changes at zone boundaries.	See Figure 1	5
(N ₁) ₆₀	SPT N ₆₀ value corrected for overburden pressure	$(N_1)_{60} = C_n \cdot N_{60}$	4
N _{60lc}	SPT N ₆₀ values based on the I _c parameter [as defined by Roberston and Wride 1998 (5), or by Robertson 2009 (15)].	$(q_t/P_a)/N_{60} = 8.5 (1 - I_c/4.6)$ $(q_t/P_a)/N_{60} = 10^{(1.1268 - 0.2817I_c)}$ Pa being atmospheric pressure	5 15, 31
(N ₁) _{60lc}	SPT N ₆₀ value corrected for overburden pressure (using N ₆₀ I _c). User has 3 options.	1) $(N_1)_{60lc} = C_n \cdot (N_{60} I_c)$ 2) $q_{c1n}/(N_1)_{60lc} = 8.5 (1 - I_c/4.6)$ 3) $(Q_{tn})/(N_1)_{60lc} = 10^{(1.1268 - 0.2817I_c)}$	4 5 15, 31
S _u or S _u (Nkt)	Undrained shear strength based on q _t S _u factor N _{kt} is user selectable	$S_u = \frac{q_t - \sigma_v}{N_{kt}}$	1, 5
S _u or S _u (Ndu)	Undrained shear strength based on pore pressure S _u factor N _{du} is user selectable	$S_u = \frac{u_2 - u_{eq}}{N_{du}}$	1, 5
Dr	Relative Density determined from one of the following user selectable options: a) Ticino Sand b) Hokksund Sand c) Schmertmann (1978) d) Jamiolkowski (1985) - All Sands e) Jamiolkowski et al (2003) (various compressibilities, K _c)	See reference (methods a through d) Jamiolkowski et al (2003) reference	5 14
PHI φ	Friction Angle determined from one of the following user selectable options (methods a through d are for sands and method e is for silts and clays): a) Campanella and Robertson b) Durgunoglu and Mitchel c) Janbu d) Kulhawy and Mayne e) NTH method (clays and silts)	See appropriate reference	5 5 5 11 23
Delta U/qt	Differential pore pressure ratio (older parameter used before B _q was established)	$= \frac{\Delta u}{q_t}$ where: $\Delta u = u - u_{eq}$ and $u = \text{dynamic pore pressure}$ $u_{eq} = \text{equilibrium pore pressure}$	CK*
B _q	Pore pressure parameter	$B_q = \frac{\Delta u}{q_t - \sigma_v}$ where: $\Delta u = u - u_{eq}$ and $u = \text{dynamic pore pressure}$ $u_{eq} = \text{equilibrium pore pressure}$	1, 2, 5
Net qt or qtNet	Net tip resistance (used in many subsequent correlations)	$q_t - \sigma_v$	CK*
qe	Effective tip resistance (using the dynamic pore pressure u ₂ and not equilibrium pore pressure)	$q_t - u_2$	CK*

Calculated Parameter	Description	Equation	Ref
qeNorm	Normalized effective tip resistance	$\frac{qt - u_2}{\sigma_v}$	CK*
Q_t or Norm: Qt	Normalized q_t for Soil Behavior Type classification as defined by Robertson (1990) using a linear stress normalization. Note this is different from Q_{tn} .	$Q_t = \frac{qt - \sigma_v}{\sigma_v}$	2, 5
F_r or Norm: Fr	Normalized Friction Ratio for Soil Behavior Type classification as defined by Robertson (1990)	$Fr = 100\% \cdot \frac{fs}{qt - \sigma_v}$	2, 5
Q(1-Bq)	Q(1-Bq) grouping as suggested by Jefferies and Davies for their classification chart and the establishment of their I_c parameter	$Q \cdot (1 - Bq)$ <i>where Bq is defined as above and Q is the same as the normalized tip resistance, Q_t, defined above</i>	6, 7
qc1	Normalized tip resistance, q_{c1} , using a fixed stress ratio exponent, n (this method has stress units)	$q_{c1} = q_t \cdot (P_a / \sigma_v')^{0.5}$ where: P_a = atmospheric pressure	21
qc1 (0.5)	Normalized tip resistance, q_{c1} , using a fixed stress ratio exponent, n (this method is unit-less)	$q_{c1} (0.5) = (q_t / P_a) \cdot (P_a / \sigma_v')^{0.5}$ where: P_a = atmospheric pressure	5
qc1 (Cn)	Normalized tip resistance, q_{c1} , based on C_n (this method has stress units)	$q_{c1}(Cn) = C_n * q_t$	5, 12
qc1 (Cq)	Normalized tip resistance, q_{c1} , based on C_q (this method has stress units)	$q_{c1}(Cq) = C_q * q_t$ (some papers use q_c)	5, 12
qc1n	normalized tip resistance, q_{c1n} , using a variable stress ratio exponent, n (where n=0.0, 0.70, 1.0) (this method is unit-less)	$q_{c1n} = (q_t / P_a)(P_a / \sigma_v')^n$ where: P_a = atm. Pressure and n varies as described below	3, 5
I_c or I_c (RW1998)	Soil Behavior Type Index as defined by Robertson and Fear (1995) and Robertson and Wride (1998) for estimating grain size characteristics and providing smooth gradational changes across the SBTn chart	$I_c = [(3.47 - \log_{10} Q)^2 + (\log_{10} Fr + 1.22)^2]^{0.5}$ <i>Where:</i> $Q = \left(\frac{qt - \sigma_v}{P_a} \right) \left(\frac{P_a}{\sigma_v'} \right)^n$ <i>Or</i> $Q = q_{c1n} = \left(\frac{qt}{P_a} \right) \left(\frac{P_a}{\sigma_v'} \right)^n$ <i>depending on the iteration in determining I_c</i> <i>And</i> Fr is in percent P_a = atmospheric pressure <i>n varies between 0.5, 0.70 and 1.0 and is selected in an iterative manner based on the resulting I_c</i>	3, 5, 21
I_c (PKR 2009)	Soil Behavior Type Index, I_c (PKR 2009) based on a variable stress ratio exponent n, which itself is based on I_c (PKR 2009). An iterative calculation is required to determine I_c (PKR 2009) and its corresponding n (PKR 2009).	I_c (PKR 2009) = $[(3.47 - \log_{10} Q_{tn})^2 + (1.22 + \log_{10} Fr)^2]^{0.5}$	15

Calculated Parameter	Description	Equation	Ref
n (PKR 2009)	Stress ratio exponent n, based on I _c (PKR 2009). An iterative calculation is required to determine n (PKR 2009) and its corresponding I _c (PKR 2009).	$n (PKR 2009) = 0.381 (I_c) + 0.05 (\sigma'_v/P_a) - 0.15$	15
Qtn (PKR 2009)	Normalized tip resistance using a variable stress ratio exponent based on I _c (PKR 2009) and n (PKR 2009). An iterative calculation is required to determine Qtn (PKR 2009).	$Q_{tn} = [(qt - \sigma_v)/P_a](P_a/\sigma'_v)^n$ where P _a = atmospheric pressure (100 kPa) n = stress ratio exponent described above	15
FC	Apparent fines content (%)	$FC = 1.75(I_c^{3.25}) - 3.7$ $FC = 100$ for I _c > 3.5 $FC = 0$ for I _c < 1.26 $FC = 5\%$ if 1.64 < I _c < 2.6 AND F _r < 0.5	3
I _c Zone	This parameter is the Soil Behavior Type zone based on the I _c parameter (valid for zones 2 through 7 on SBTn or SBT Qtn charts)	I _c < 1.31 Zone = 7 1.31 < I _c < 2.05 Zone = 6 2.05 < I _c < 2.60 Zone = 5 2.60 < I _c < 2.95 Zone = 4 2.95 < I _c < 3.60 Zone = 3 I _c > 3.60 Zone = 2	3
State Param or State Parameter or ψ	The state parameter index, ψ, is defined as the difference between the current void ratio, e, and the critical void ratio, e _c . Positive ψ - contractive soil Negative ψ - dilative soil This is based on the work by Been and Jefferies (1985) and Plewes, Davies and Jefferies (1992) - vertical effective stress is used rather than a mean normal stress	See reference	6, 8
Yield Stress σ _p '	Yield stress is calculated using the following methods a) General method b) 1 st order approximation using q _t Net (clays) c) 1 st order approximation using Δu ₂ (clays) d) 1 st order approximation using q _e (clays)	All stresses in kPa a) $\sigma_p' = 0.33 \cdot (q_t - \sigma_v)^{m'} \cdot (\sigma_{atm}/100)^{1-m'}$ where $m' = 1 - \frac{0.28}{1 + (I_c / 2.65)^{2.5}}$ b) $\sigma_p' = 0.33 \cdot (q_t - \sigma_v)$ c) $\sigma_p' = 0.54 \cdot (\Delta u_2)$ Δu ₂ = u ₂ - u ₀ d) $\sigma_p' = 0.60 \cdot (q_t - u_2)$	19 20 20 20
OCR OCR(JS1978) OCR(Mayne2014) OCR (qtNet) OCR (deltaU) OCR (qe) OCR (Vs) OCR (PKR2015)	Over Consolidation Ratio based on a) Schmertmann (1978) method involving a plot of S _u /σ _v ' / (S _u /σ _v ') _{NC} and OCR b) based on Yield stresses described above c) approximate version based on qtNet d) approximate version based on Δu e) approximate version based on effective tip, q _e f) approximate version based on shear wave velocity, V _s g) based on Q _t	a) requires a user defined value for NC S _u /P _c ' ratio b through f) based on yield stresses g) $OCR = 0.25 \cdot (Q_t)^{1.25}$	9 19 20 20 20 18 32

Calculated Parameter	Description	Equation	Ref
Es/qt	Intermediate parameter for calculating Young’s Modulus, E, in sands. It is the Y axis of the reference chart.	Based on Figure 5.59 in the reference	5
Es Young’s Modulus E	<p>Young’s Modulus based on the work done in Italy. There are three types of sands considered in this technique. The user selects the appropriate type for the site from:</p> <p>a) OC Sands b) Aged NC Sands c) Recent NC Sands</p> <p>Each sand type has a family of curves that depend on mean normal stress. The program calculates mean normal stress and linearly interpolates between the two extremes provided in the Es/qt chart. Es is evaluated for an axial strain of 0.1%.</p>	<p>Mean normal stress is evaluated from:</p> $\sigma'_m = \frac{1}{3}(\sigma'_v + \sigma'_h + \sigma'_h)$ <p>where σ'_v = vertical effective stress σ'_h = horizontal effective stress</p> <p>and $\sigma_h = K_o \cdot \sigma'_v$ with K_o assumed to be 0.5</p>	5
Delta U/TStress	Differential pore pressure ratio with respect to total stress	$= \frac{\Delta u}{\sigma_v}$ where: $\Delta u = u - u_{eq}$	CK*
Delta U/Estress, P Value, Excess Pore Pressure Ratio	Differential pore pressure ratio with respect to effective stress. Key parameter (P, Normalized Pore Pressure Parameter, Excess Pore Pressure Ratio) in the Winckler et. al. static liquefaction method.	$= \frac{\Delta u}{\sigma'_v}$ where: $\Delta u = u - u_{eq}$	25, 25a, CK*
Su/EStress	Undrained shear strength ratio with respect to vertical effective overburden stress using the Su (Nkt) method	$= Su (N_{kt}) / \sigma'_v$	CK*
Gmax	G _{max} determined from SCPT shear wave velocities (not estimated values)	$G_{max} = \rho V_s^2$ where ρ is the mass density of the soil determined from the estimated unit weights at each test depth	27
qtNet/Gmax	Net tip resistance ratio with respect to the small strain modulus G _{max} determined from SCPT shear wave velocities (not estimated values)	$= (qt - \sigma_v) / G_{max}$ where $G_{max} = \rho V_s^2$ and ρ is the mass density of the soil determined from the estimated unit weights at each test depth	15, 28, 30

*CK – common knowledge

Table 1b. CPT Parameter Calculation Methods – Liquefaction Parameters

Calculated Parameter	Description	Equation	Ref
K_{SPT}	Equivalent clean sand factor for $(N_1)_{60}$	$K_{SPT} = 1 + ((0.75/30) \cdot (FC - 5))$	10
K_{CPT} or K_C (RW1998)	Equivalent clean sand correction for q_{c1N}	$K_{cpt} = 1.0$ for $l_c \leq 1.64$ $K_{cpt} = f(l_c)$ for $l_c > 1.64$ (see reference) $K_c = -0.403 l_c^4 + 5.581 l_c^3 - 21.63 l_c^2 + 33.75 l_c - 17.88$	3, 10
K_C (PKR 2010)	Clean sand equivalent factor to be applied to Q_{tn}	$K_c = 1.0$ for $l_c \leq 1.64$ $K_c = -0.403 l_c^4 + 5.581 l_c^3 - 21.63 l_c^2 + 33.75 l_c - 17.88$ for $l_c > 1.64$	16
$(N_1)_{60cs} I_C$	Clean sand equivalent SPT $(N_1)_{60} I_C$. User has 3 options.	1) $(N_1)_{60cs} I_C = \alpha + \beta((N_1)_{60} I_C)$ 2) $(N_1)_{60cs} I_C = K_{SPT} * ((N_1)_{60} I_C)$ 3) $(q_{c1ncs}) / (N_1)_{60cs} I_C = 8.5 (1 - I_C/4.6)$ FC \leq 5%: $\alpha = 0, \beta = 1.0$ FC \geq 35% $\alpha = 5.0, \beta = 1.2$ 5% < FC < 35% $\alpha = \exp[1.76 - (190/FC^2)]$ $\beta = [0.99 + (FC^{1.5}/1000)]$	10 10 5
q_{c1ncs}	Clean sand equivalent q_{c1n}	$q_{c1ncs} = q_{c1n} \cdot K_{cpt}$	3
$Q_{tn,cs}$ (PKR 2010)	Clean sand equivalent for Q_{tn} described above - Q_{tn} being the normalized tip resistance based on a variable stress exponent as defined by Robertson (2009)	$Q_{tn,cs} = Q_{tn} \cdot K_C$ (PKR 2016)	16
$S_u(Liq)/ES_v$	Liquefied shear strength ratio as defined by Olson and Stark	$\frac{S_u(Liq)}{\sigma'_v} = 0.03 + 0.0143(q_{c1})$ Note: σ'_v and s'_v are synonymous	13
$S_u(Liq)/ES_v$ (PKR 2010)	Liquefied shear strength ratio as defined by Robertson (2010)	$\frac{S_u(Liq)}{\sigma'_v}$ Based on a function involving $Q_{tn,cs}$	16
$S_u(Liq)$ (PKR 2010)	Liquefied shear strength derived from the liquefied shear strength ratio and effective overburden stress		16
Cont/Dilat Tip	Contractive / Dilative qc1 Boundary based on $(N_1)_{60}$	$(\sigma'_v)_{boundary} = 9.58 \times 10^{-4} [(N_1)_{60}]^{4.79}$ $qc1$ is calculated from specified qt(MPa)/N ratio	13
CRR	Cyclic Resistance Ratio (for Magnitude 7.5)	$q_{c1ncs} < 50$: $CRR_{7.5} = 0.833 [q_{c1ncs}/1000] + 0.05$ $50 \leq q_{c1ncs} < 160$: $CRR_{7.5} = 93 [q_{c1ncs}/1000]^3 + 0.08$	10
K_g	Small strain Stiffness Ratio Factor, K_g	$[G_{max}/qt]/[qc1n^{-m}]$ $m =$ empirical exponent, typically 0.75	26

Calculated Parameter	Description	Equation	Ref
SP Distance	State Parameter Distance, Winckler static liquefaction method	Perpendicular distance on Qtn chart from plotted point to state parameter $\Psi = -0.05$ curve	25
URS NP Fr	Normalized friction ratio point on $\Psi = -0.05$ curve used in SP Distance calculation		25
URS NP Qtn	Normalized tip resistance (Qtn) point on $\Psi = -0.05$ curve used in SP Distance calculation		25

Table 2. References

No.	Reference
1	Robertson, P.K., Campanella, R.G., Gillespie, D. and Greig, J., 1986, "Use of Piezometer Cone Data", Proceedings of InSitu 86, ASCE Specialty Conference, Blacksburg, Virginia.
2	Robertson, P.K., 1990, "Soil Classification Using the Cone Penetration Test", Canadian Geotechnical Journal, Volume 27. This includes the discussions and replies.
3	Robertson, P.K. and Wride (Fear), C.E., 1998, "Evaluating cyclic liquefaction potential using the cone penetration test", Canadian Geotechnical Journal, 35: 442-459.
4	Robertson, P.K. and Wride, C.E., 1997, "Cyclic Liquefaction and its Evaluation Based on SPT and CPT", NCEER Workshop Paper, January 22, 1997.
5	Lunne, T., Robertson, P.K. and Powell, J. J. M., 1997, "Cone Penetration Testing in Geotechnical Practice," Blackie Academic and Professional.
6	Plewes, H.D., Davies, M.P. and Jefferies, M.G., 1992, "CPT Based Screening Procedure for Evaluating Liquefaction Susceptibility", 45 th Canadian Geotechnical Conference, Toronto, Ontario, October 1992.
7	Jefferies, M.G. and Davies, M.P., 1993, "Use of CPTu to Estimate equivalent N_{60} ", Geotechnical Testing Journal, 16(4): 458-467.
8	Been, K. and Jefferies, M.P., 1985, "A state parameter for sands", Geotechnique, 35(2), 99-112.
9	Schmertmann, 1978, "Guidelines for Cone Penetration Test Performance and Design", Federal Highway Administration Report FHWA-TS-78-209, U.S. Department of Transportation.
10	Proceedings of the NCEER Workshop on Evaluation of Liquefaction Resistance of Soils, Salt Lake City, 1996, chaired by Leslie Youd.
11	Kulhawy, F.H. and Mayne, P.W., 1990, "Manual on Estimating Soil Properties for Foundation Design, Report No. EL-6800", Electric Power Research Institute, Palo Alto, CA, August 1990, 306 p.
12	Olson, S.M. and Stark, T.D., 2002, "Liquefied strength ratio from liquefied flow failure case histories", Canadian Geotechnical Journal, 39: 951-966.
13	Olson, Scott M. and Stark, Timothy D., 2003, "Yield Strength Ratio and Liquefaction Analysis of Slopes and Embankments", Journal of Geotechnical and Geoenvironmental Engineering, ASCE, August 2003.
14	Jamiolkowski, M.B., Lo Presti, D.C.F. and Manassero, M., 2003, "Evaluation of Relative Density and Shear Strength of Sands from CPT and DMT", Soil Behaviour and Soft Ground Construction, ASCE, GSP NO. 119, 201-238.
15	Robertson, P.K., 2009, "Interpretation of cone penetration tests – a unified approach", Canadian Geotechnical Journal, 46: 1337-1355.
16	Robertson, P.K., 2010, "Evaluation of Flow Liquefaction and Liquefied Strength Using the Cone Penetration Test", Journal of Geotechnical and Geoenvironmental Engineering, ASCE, June 2010.
17	Mayne, P.W. and Kulhawy, F.H., 1982, "Ko-OCR Relationships in Soil", Journal of the Geotechnical Engineering Division, ASCE, Vol. 108, GT6, pp. 851-872.
18	Mayne, P.W., Robertson P.K. and Lunne T., 1998, "Clay stress history evaluated from seismic piezocone tests", Proceedings of the First International Conference on Site Characterization – ISC '98, Atlanta Georgia, Volume 2, 1113-1118.

No.	Reference
19	Mayne, P.W., 2014, "Generalized CPT Method for Evaluating Yield Stress in Soils", Geocharacterization for Modeling and Sustainability (GSP 235: Proc. GeoCongress 2014, Atlanta, GA), ASCE, Reston, Virginia: 1336-1346.
20	Mayne, P.W., 2015, "Geocharacterization by In-Situ Testing", Continuing Education Course, Vancouver, BC, January 6-8, 2015.
21	Robertson, P.K. and Fear, C.E., 1995, "Liquefaction of sands and its evaluation", Proceedings of the First International Conference on Earthquake Engineering, Keynote Lecture IS Tokyo '95, Tokyo Japan, 1995.
22	Mayne, P.W., Peuchen, J. and Boumeester, D., 2010, "Soil unit weight estimation from CPTs", Proceeding of the 2 nd International Symposium on Cone Penetration Testing (CPT '10), Vol 2, Huntington Beach, California; Omnipress: 169-176.
23	Mayne, P.W., 2007, "NCHRP Synthesis 368 on Cone Penetration Test", Transportation Research Board, National Academies Press, Washington, D.C., 118 pages.
24	Mayne, P.W., 2014, "Interpretation of geotechnical parameters from seismic piezocone tests.", Key note address #2, proceedings, 3 rd International Symposium on Cone Penetration Testing (CPT'14, Las Vegas), ISSMGE Technical Committee TC102.
25	Winckler, Christina, Davidson, Richard, Yenne, Lisa, Pilz, Jorgen, 2014, "CPTu-Based State Characterization of Tailings Liquefaction Susceptibility", Tailings and Mine Waste, 2014.
25a	Winckler, Christina, Davidson, Richard, Yenne, Lisa, Pilz, Jorgen, 2014, "CPTu-Based State Characterization of Tailings Liquefaction Susceptibility", Powerpoint presentation, Tailings and Mine Waste, 2014.
26	Schneider, J.A. and Moss, R.E.S., 2011, "Linking cyclic stress and cyclic strain based methods for assessment of cyclic liquefaction triggering in sands", Geotechnique Letters 1, 31-36.
27	Rice, A., 1984, "The Seismic Cone Penetrometer", M.A.Sc. thesis submitted to the University of British Columbia, Dept. of Civil Engineering, Vancouver, BC, Canada.
28	Gillespie, D.G., 1990, "Evaluating Shear Wave Velocity and Pore Pressure Data from the Seismic Cone Penetration Test", Ph.D. thesis submitted to the University of British Columbia, Dept. of Civil Engineering, Vancouver, BC, Canada.
29	Robertson, P.K and Cabal, K.L., 2010, "Estimating soil unit weight from CPT", Proceedings of the 2 nd International Symposium on Cone Penetration Testing (CPT '10), Huntington Beach, California.
30	Robertson, P.K., 2016, "Cone penetration test (CPT)-based soil behaviour type (SBT) classification system – an update", Canadian Geotechnical Journal, July 2016.
31	Robertson, P.K., 2012, "Interpretation of in-situ tests – some insights", Mitchell Lecture, ISC'4, Recife, Brazil.
32	Robertson, P.K., Cabal, K.L. 2015, "Guide to Cone Penetration Testing for Geotechnical Engineering", 6 th Edition.

Electric Field Vane Shear Test Profile Summary and Results





Job No: 22-61-23505
Client: Barr Engineering Co.
Project: DTE Energy St. Clair Power Plant, East China Twp., MI
Start Date: 08-Jan-2022
End Date: 08-Jan-2022

ELECTRIC FIELD VANE SHEAR TEST PROFILE SUMMARY

Sounding ID	File Name	Adjacent Test Sounding ID	Date	Northing ¹ (m)	Easting ¹ (m)	Refer to Notation Number
VST22-01	22-61-23505_VST01	CPT22-01	08-Jan-2022	4735395	379572	

1. Coordinates were collected with consumer grade GPS equipment. Datum: WGS 1984 / UTM Zone 17 North.



Job No: 22-61-23505
Client: Barr Engineering Co.
Project: DTE Energy St. Clair Power Plant, East China Twp., MI
Start Date: 08-Jan-2022
End Date: 08-Jan-2022

FIELD VANE SHEAR TEST RESULTS

Sounding ID	File Name	Date	Load Cell Serial Number	Pre-Punch Depth (ft)	Test Depth ¹ (ft)	Vane Diameter D (mm)	Vane Height H (mm)	Top Taper Angle i_T (deg)	Bottom Taper Angle i_B (deg)	Vane Factor (Nm to tsf)	Peak Torque (Nm)	Peak Stress (tsf)	Peak Frictional Stress (tsf)	Su Peak (tsf)	Refer to Notation Number
VST22-01	22-61-23505_VST01	08-Jan-2022	AVLC053	5.5	6.0	50	100	45	45	0.0215	22.58	0.49	0.03	0.46	
VST22-01	22-61-23505_VST01	08-Jan-2022	AVLC053	19.0	21.0	50	100	45	45	0.0215	41.04	0.88	0.06	0.82	
VST22-01	22-61-23505_VST01	08-Jan-2022	AVLC053	29.0	31.0	50	100	45	45	0.0215	21.04	0.45	0.04	0.41	

1. Test depths are referenced to the middle of the vane.



Job No: 22-61-23505
Client: Barr Engineering Co.
Project: DTE Energy St. Clair Power Plant, East China Twp., MI
Start Date: 08-Jan-2022
End Date: 08-Jan-2022

FIELD VANE SHEAR TEST TIMING

Sounding ID	Date	Test Depth (ft)	Peak Test Start Time (HH:mm)	Start to Failure Interval (sec)	Peak Test Avg Rate (deg/sec)
VST22-01	08-Jan-2022	6.0	11:32	406	0.10
VST22-01	08-Jan-2022	21.0	13:16	391	0.10
VST22-01	08-Jan-2022	31.0	14:50	286	0.10

1. Test depths are referenced to the middle of the vane.

Electric Field Vane Shear Test Plots



Job Number: 22-61-23505
Client: Barr Engineering
Project: DTE Energy St. Clair Power Plant
Sounding ID: VST22-01
Sounding Date: 08-Jan-2022

Test Depth (ft): 6.00
Vane Type: Double tapered 50 mm x 100 mm

Coordinate System: WGS84/UTM 17N
Northing (m): 4735395
Easting (m): 379572

Vane Shear Test

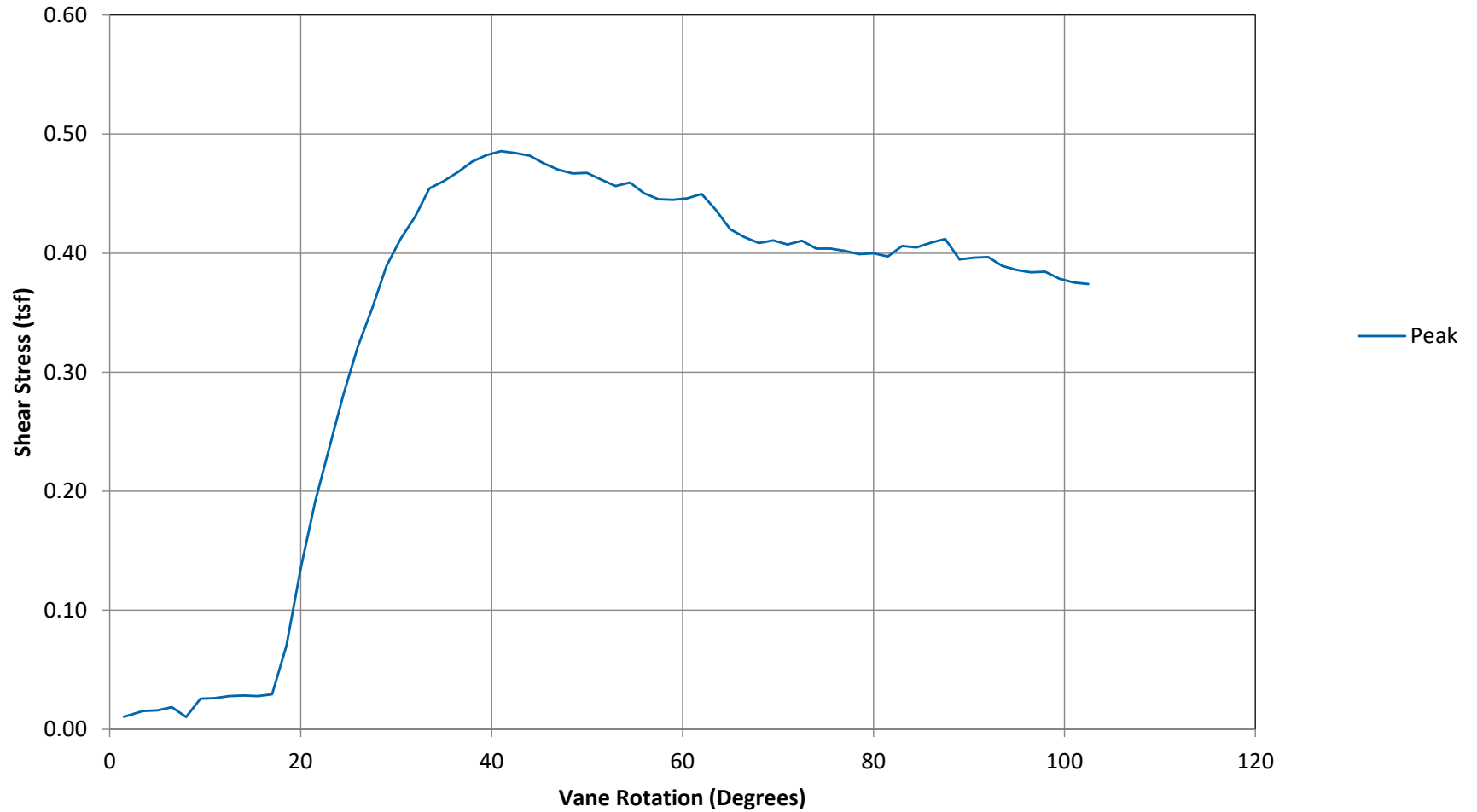



Job Number: 22-61-23505
Client: Barr Engineering
Project: DTE Energy St. Clair Power Plant
Sounding ID: VST22-01
Sounding Date: 08-Jan-2022

Test Depth (ft): 21.00
Vane Type: Double tapered 50 mm x 100 mm

Coordinate System: WGS84/UTM 17N
Northing (m): 4735395
Easting (m): 379572

Vane Shear Test

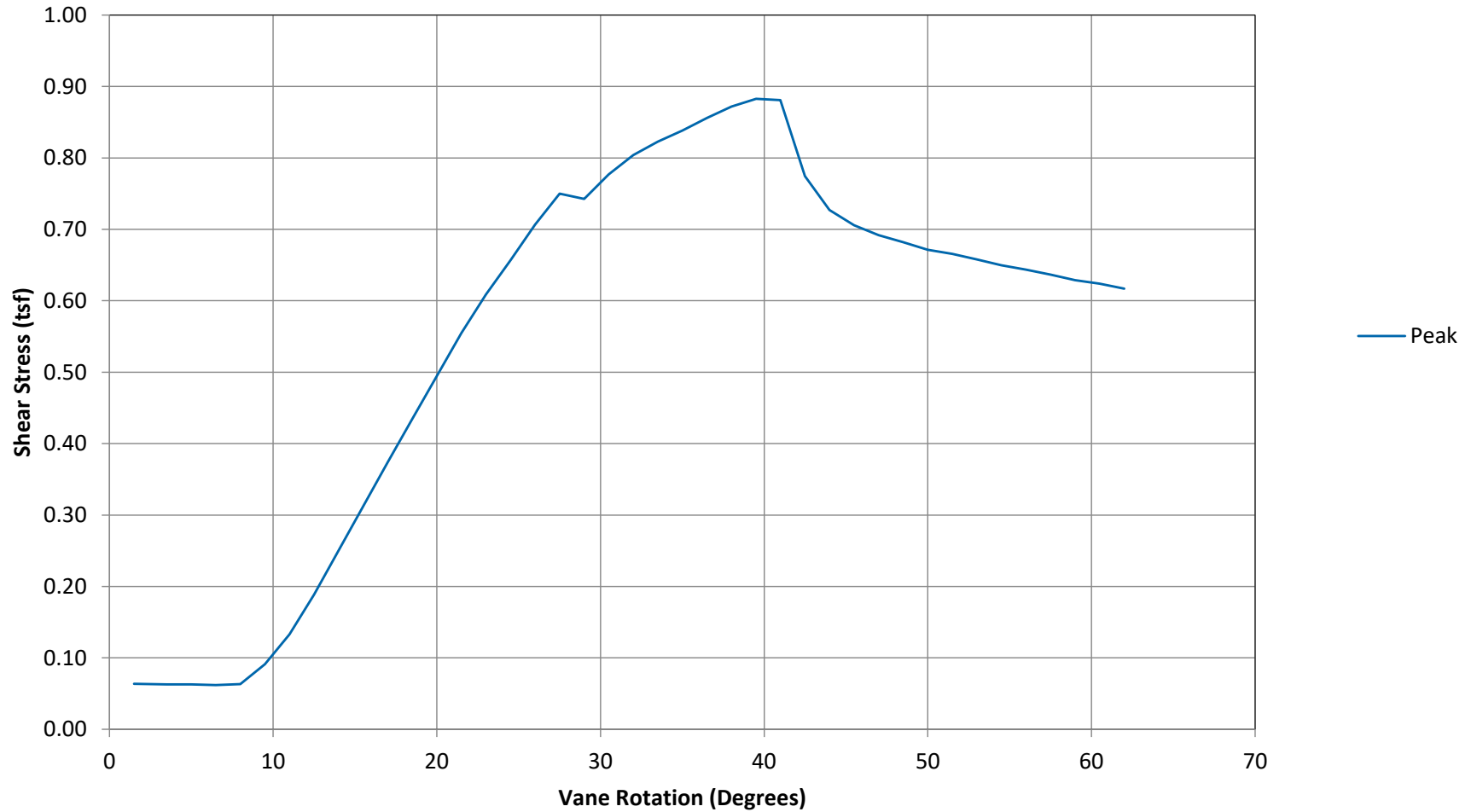



Job Number: 22-61-23505
Client: Barr Engineering
Project: DTE Energy St. Clair Power Plant
Sounding ID: VST22-01
Sounding Date: 08-Jan-2022

Test Depth (ft): 31.00
Vane Type: Double tapered 50 mm x 100 mm

Coordinate System: WGS84/UTM 17N
Northing (m): 4735395
Easting (m): 379572

Vane Shear Test

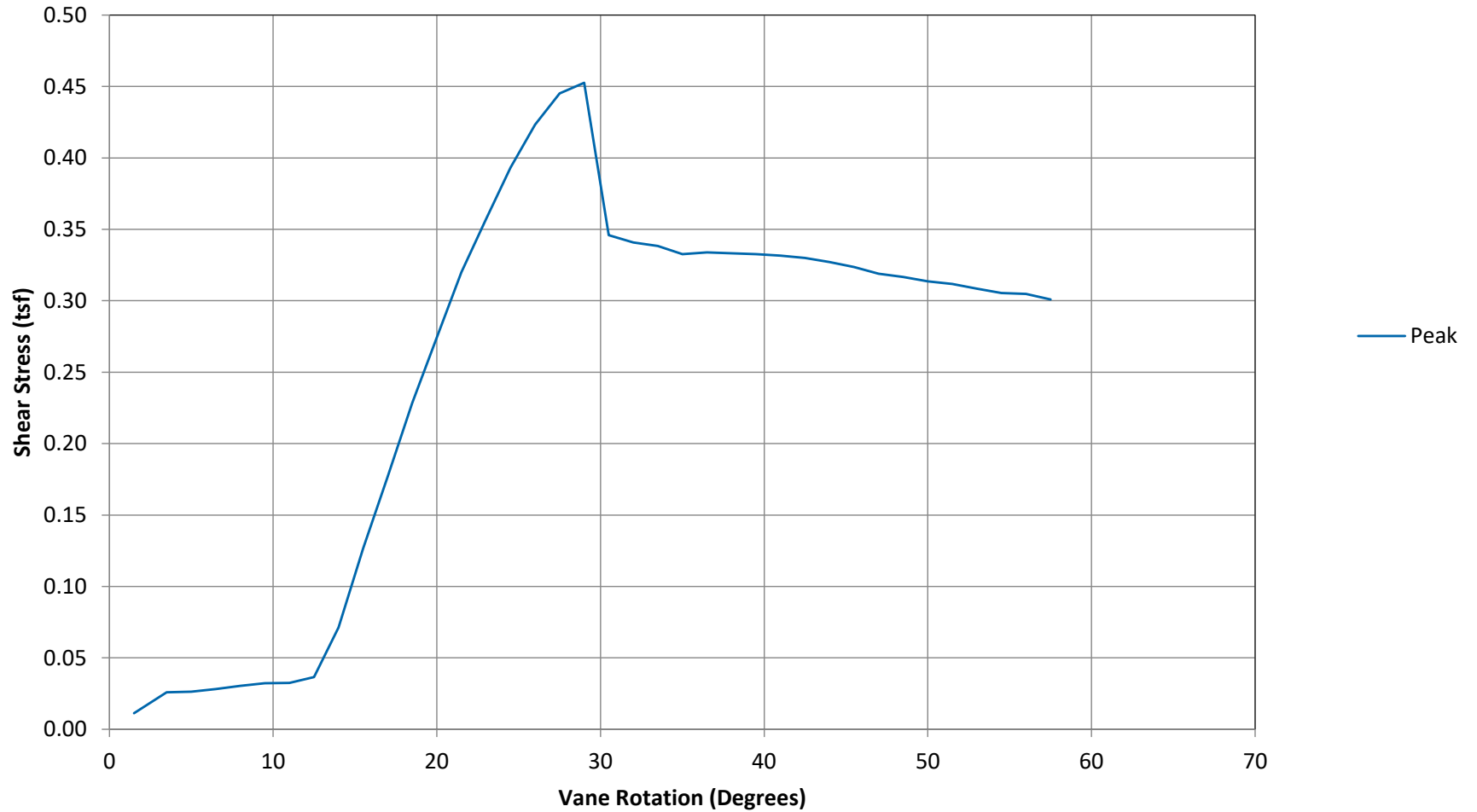

Attachment 5

Laboratory Testing Results

Grain Size Distribution ASTM D422-16

Job No. : **13334**

Project:	DTE STCPP	Test Date:	8/27/21
Reported To:	Barr Engineering Company	Report Date:	8/31/21

	Location / Boring No.	Sample No.	Date	Sample Type	Soil Classification
*	Ash Pond W.	#1	8/20/21	Bag	Elastic Silt (MH)
●	Ash Pond W.	#2	8/20/21	Bag	Elastic Silt (MH)
◇	Ash Pond W.	#3	8/20/21	Bag	Elastic Silt (MH)

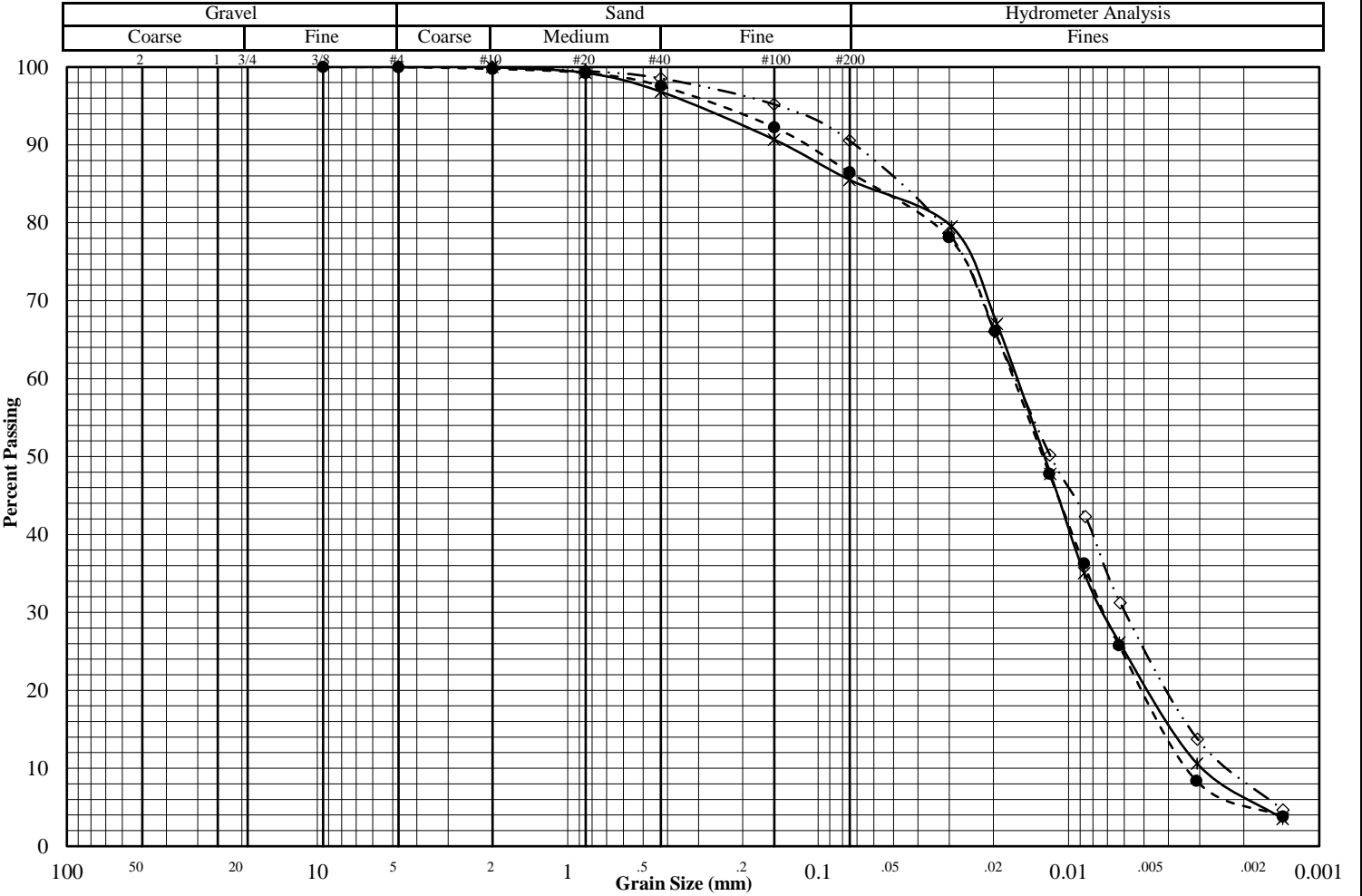

Additional Results	*	●	◇
Liquid Limit	63	62	59
Plastic Limit	56	55	53
Plasticity Index <small>ASTM: D4316</small>	7	7	6
Water Content <small>ASTM: D2216</small>			
Dry Density (pcf) <small>ASTM: D7263</small>			
Specific Gravity <small>ASTM: D854</small>	2.55*	2.55*	2.55*
Porosity			
Organic Content <small>ASTM: D2974</small>			
pH <small>ASTM: D4972 Method B</small>	11.8	11.8	11.8

	Percent Passing		
	*	●	◇
Mass (g)	209.3	205.2	283.4
2"			
1.5"			
1"			
3/4"			
3/8"		100.0	
#4		100.0	100.0
#10	100.0	99.8	100.0
#20	99.2	99.2	99.5
#40	96.8	97.6	98.5
#100	90.7	92.3	95.2
#200	85.5	86.5	90.6

	*	●	◇
D ₆₀			
D ₃₀			
D ₁₀			
C _u			
C _c			

Remarks:

(* = assumed)

Grain Size Distribution ASTM D422-16

Job No. : **13334**

Project:	DTE STCPP	Test Date:	8/27/21
Reported To:	Barr Engineering Company	Report Date:	8/31/21
Location / Boring No.	Sample No.	Date	Sample Type
Soil Classification			
Spec 1	Ash Pond W.	#1	8/20/21
		Bag	Elastic Silt (MH)
Spec 2	Ash Pond W.	#2	8/20/21
		Bag	Elastic Silt (MH)
Spec 3	Ash Pond W.	#3	8/20/21
		Bag	Elastic Silt (MH)

Sieve Data

Specimen 1		Specimen 2		Specimen 3	
Sieve	% Passing	Sieve	% Passing	Sieve	% Passing
2"		2"		2"	
1.5"		1.5"		1.5"	
1"		1"		1"	
3/4"		3/4"		3/4"	
3/8"		3/8"	100.0	3/8"	
#4		#4	100.0	#4	100.0
#10	100.0	#10	99.8	#10	100.0
#20	99.2	#20	99.2	#20	99.5
#40	96.8	#40	97.6	#40	98.5
#100	90.7	#100	92.3	#100	95.2
#200	85.5	#200	86.5	#200	90.6

Hydrometer Data

Specimen 1		Specimen 2		Specimen 3	
Diameter (mm)	% Passing	Diameter	% Passing	Diameter	% Passing
0.029	79.5	0.030	78.2	0.030	78.6
0.019	67.0	0.020	66.1	0.020	66.0
0.012	47.8	0.012	47.8	0.012	50.2
0.009	35.0	0.009	36.3	0.009	42.3
0.006	26.1	0.006	25.8	0.006	31.2
0.003	10.6	0.003	8.4	0.003	13.7
0.001	3.5	0.001	3.8	0.001	4.6

Remarks

Specimen 1	Specimen 2	Specimen 3

Grain Size Distribution ASTM D422-16

Job No. : **13334**

Project:	DTE STCPP	Test Date:	8/27/21
Reported To:	Barr Engineering Company	Report Date:	8/31/21

	Location / Boring No.	Sample No.	Date	Sample Type	Soil Classification
*	Ash Pond W.	#4	8/20/21	Bag	Elastic Silt (MH)
●	Ash Pond E.	#7	8/20/21	Bag	Silt (ML)
◇	Ash Pond E.	#8	8/20/21	Bag	Silt (ML)

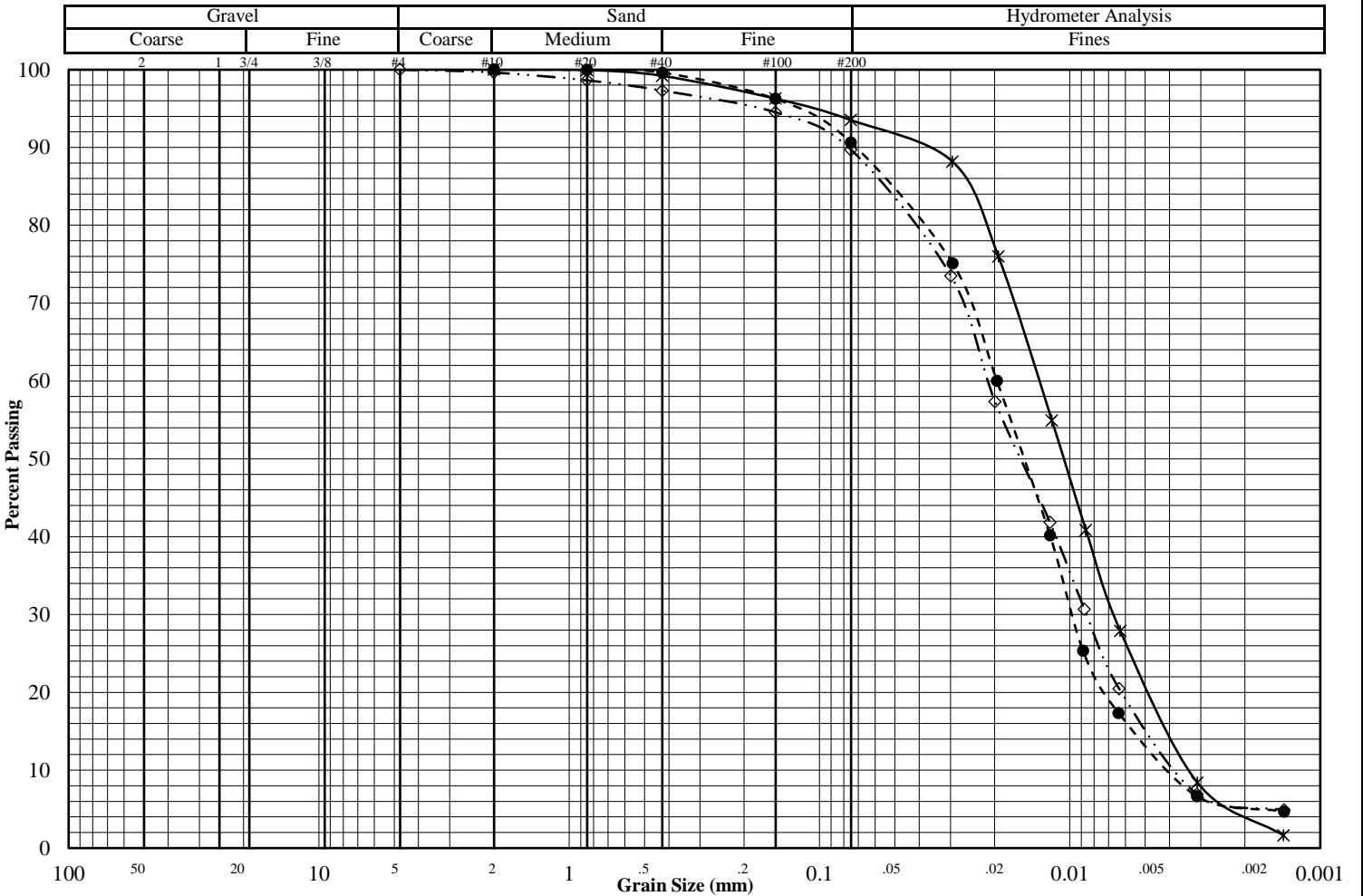

Additional Results

	*	●	◇
Liquid Limit	70	44	44
Plastic Limit	62	40	39
Plasticity Index <small>ASTM: D4316</small>	8	4	5
Water Content <small>ASTM: D2216</small>			
Dry Density (pcf) <small>ASTM: D7263</small>			
Specific Gravity <small>ASTM: D854</small>	2.55*	2.61*	2.61*
Porosity			
Organic Content <small>ASTM: D2974</small>			
pH <small>ASTM: D4972 Method B</small>	11.8	11.8	12.1

	Percent Passing		
	*	●	◇
Mass (g)	210.4	195.0	320.5
2"			
1.5"			
1"			
3/4"			
3/8"			
#4			100.0
#10	100.0	100.0	99.6
#20	99.9	100.0	98.6
#40	99.2	99.6	97.3
#100	96.3	96.2	94.5
#200	93.5	90.6	89.7

	*	●	◇
D ₆₀			
D ₃₀			
D ₁₀			
C _u			
C _c			

Remarks:

(* = assumed)

Grain Size Distribution ASTM D422-16

Job No. : **13334**

Project:	DTE STCPP	Test Date:	8/27/21
Reported To:	Barr Engineering Company	Report Date:	8/31/21
Location / Boring No.	Sample No.	Date	Sample Type
Soil Classification			
Spec 1	Ash Pond W.	#4	8/20/21
			Bag
			Elastic Silt (MH)
Spec 2	Ash Pond E.	#7	8/20/21
			Bag
			Silt (ML)
Spec 3	Ash Pond E.	#8	8/20/21
			Bag
			Silt (ML)

Sieve Data

Specimen 1		Specimen 2		Specimen 3	
Sieve	% Passing	Sieve	% Passing	Sieve	% Passing
2"		2"		2"	
1.5"		1.5"		1.5"	
1"		1"		1"	
3/4"		3/4"		3/4"	
3/8"		3/8"		3/8"	
#4		#4		#4	100.0
#10	100.0	#10	100.0	#10	99.6
#20	99.9	#20	100.0	#20	98.6
#40	99.2	#40	99.6	#40	97.3
#100	96.3	#100	96.2	#100	94.5
#200	93.5	#200	90.6	#200	89.7

Hydrometer Data

Specimen 1		Specimen 2		Specimen 3	
Diameter (mm)	% Passing	Diameter	% Passing	Diameter	% Passing
0.029	88.2	0.029	75.1	0.030	73.5
0.019	76.0	0.020	60.0	0.020	57.3
0.012	54.9	0.012	40.2	0.012	41.9
0.009	40.8	0.009	25.3	0.009	30.7
0.006	27.9	0.006	17.4	0.006	20.5
0.003	8.4	0.003	6.6	0.003	6.9
0.001	1.6	0.001	4.7	0.001	4.9

Remarks

Specimen 1	Specimen 2	Specimen 3

Grain Size Distribution ASTM D422-16

Job No. : **13334**

Project:	DTE STCPP	Test Date:	8/27/21
Reported To:	Barr Engineering Company	Report Date:	8/31/21

Location / Boring No.	Sample No.	Date	Sample Type	Soil Classification
* Ash Pond E.	#9	8/20/21	Bag	Silt (ML)
●				
◇				

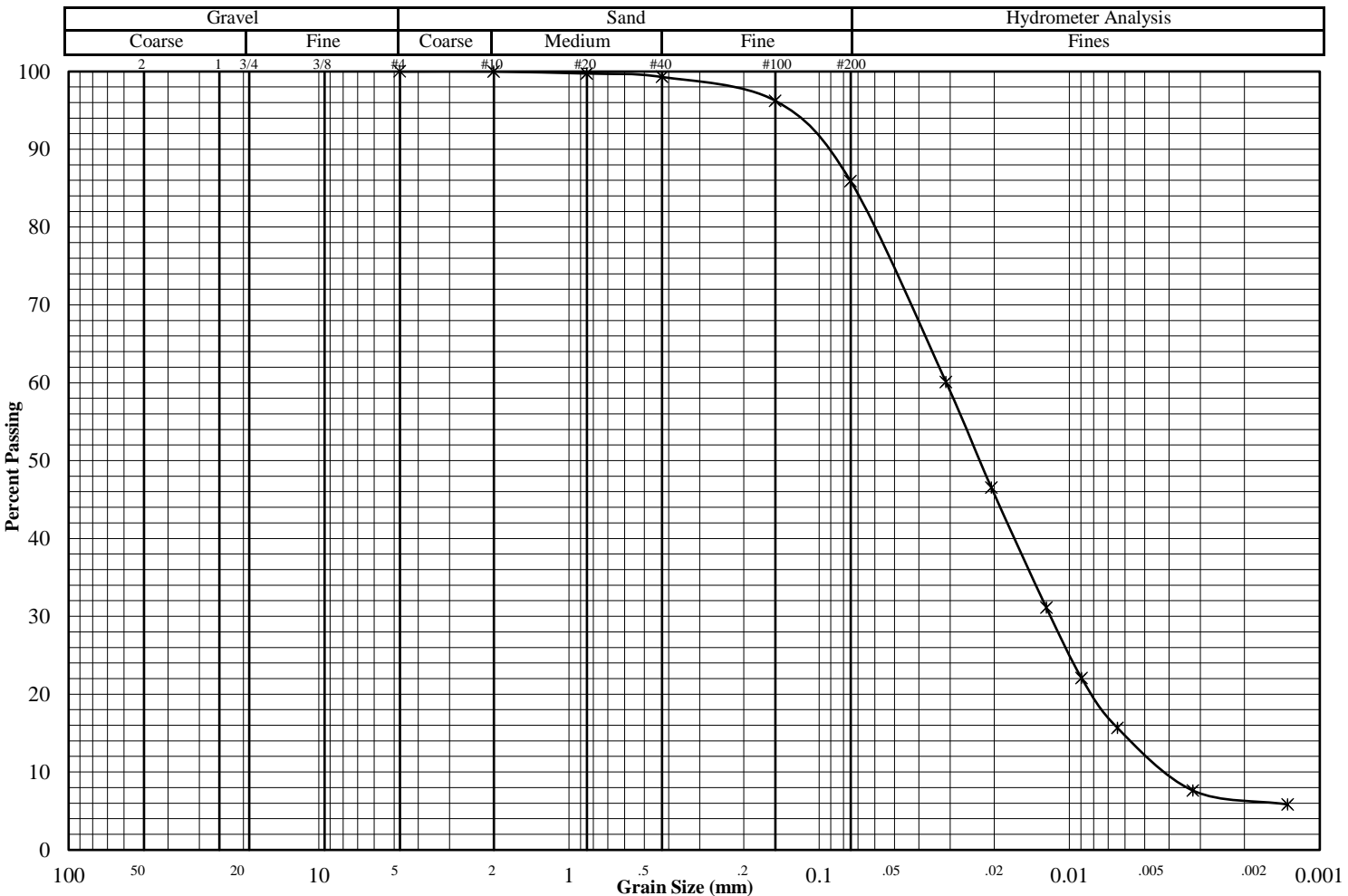

Additional Results

	*	●	◇
Liquid Limit	38		
Plastic Limit	N/A		
Plasticity Index	NP		
ASTM: D4316			
Water Content			
ASTM: D2216			
Dry Density (pcf)			
ASTM: D7263			
Specific Gravity	2.62*		
ASTM: D854			
Porosity			
Organic Content			
ASTM: D2974			
pH	11.9		
ASTM: D4972 Method B			

	Percent Passing		
	*	●	◇
Mass (g)	417.1		
2"			
1.5"			
1"			
3/4"			
3/8"			
#4	100.0		
#10	100.0		
#20	99.7		
#40	99.3		
#100	96.2		
#200	85.9		

	*	●	◇
D ₆₀			
D ₃₀			
D ₁₀			
C _u			
C _c			

Remarks:

(* = assumed)

Grain Size Distribution ASTM D422-16

Job No. : **13334**

Project:	DTE STCPP	Test Date:	8/27/21
Reported To:	Barr Engineering Company	Report Date:	8/31/21
Location / Boring No.	Sample No.	Date	Sample Type
Spec 1	Ash Pond E.	#9	8/20/21
Spec 2			
Spec 3			

Sieve Data

Specimen 1		Specimen 2		Specimen 3	
Sieve	% Passing	Sieve	% Passing	Sieve	% Passing
2"		2"		2"	
1.5"		1.5"		1.5"	
1"		1"		1"	
3/4"		3/4"		3/4"	
3/8"		3/8"		3/8"	
#4	100.0	#4		#4	
#10	100.0	#10		#10	
#20	99.7	#20		#20	
#40	99.3	#40		#40	
#100	96.2	#100		#100	
#200	85.9	#200		#200	

Hydrometer Data

Specimen 1		Specimen 2		Specimen 3	
Diameter (mm)	% Passing	Diameter	% Passing	Diameter	% Passing
0.031	60.1				
0.021	46.5				
0.012	31.1				
0.009	22.1				
0.006	15.7				
0.003	7.6				
0.001	5.8				

Remarks

Specimen 1	Specimen 2	Specimen 3

Laboratory Test Summary

Project: DTE STCPP

Job: 13334

Client: Barr Engineering Company

Date: 9/2/2021

Sample Information & Classification

Boring #	Ash Pond W.	Ash Pond W.	Ash Pond W.	Ash Pond W.	Ash Pond E.	Ash Pond E.	Ash Pond E.	
Sample #	#1	#2	#3	#4	#7	#8	#9	
Date	8/20/2021	8/20/2021	8/20/2021	8/20/2021	8/20/2021	8/20/2021	8/20/2021	
Sample Type	Bag	Bag	Bag	Bag	Bag	Bag	Bag	
Material Classification	Elastic Silt (MH)	Elastic Silt (MH)	Elastic Silt (MH)	Elastic Silt (MH)	Silt (ML)	Silt (ML)	Silt (ML)	

Atterberg Limits (ASTM:D4318)

Liquid Limit	63	62	59	70	44	44	38	
Plastic Limit	56	55	53	62	40	39	N/A	
Plasticity Index	7	7	6	8	4	5	NP	

Plasticity Chart (ASTM:D2487)

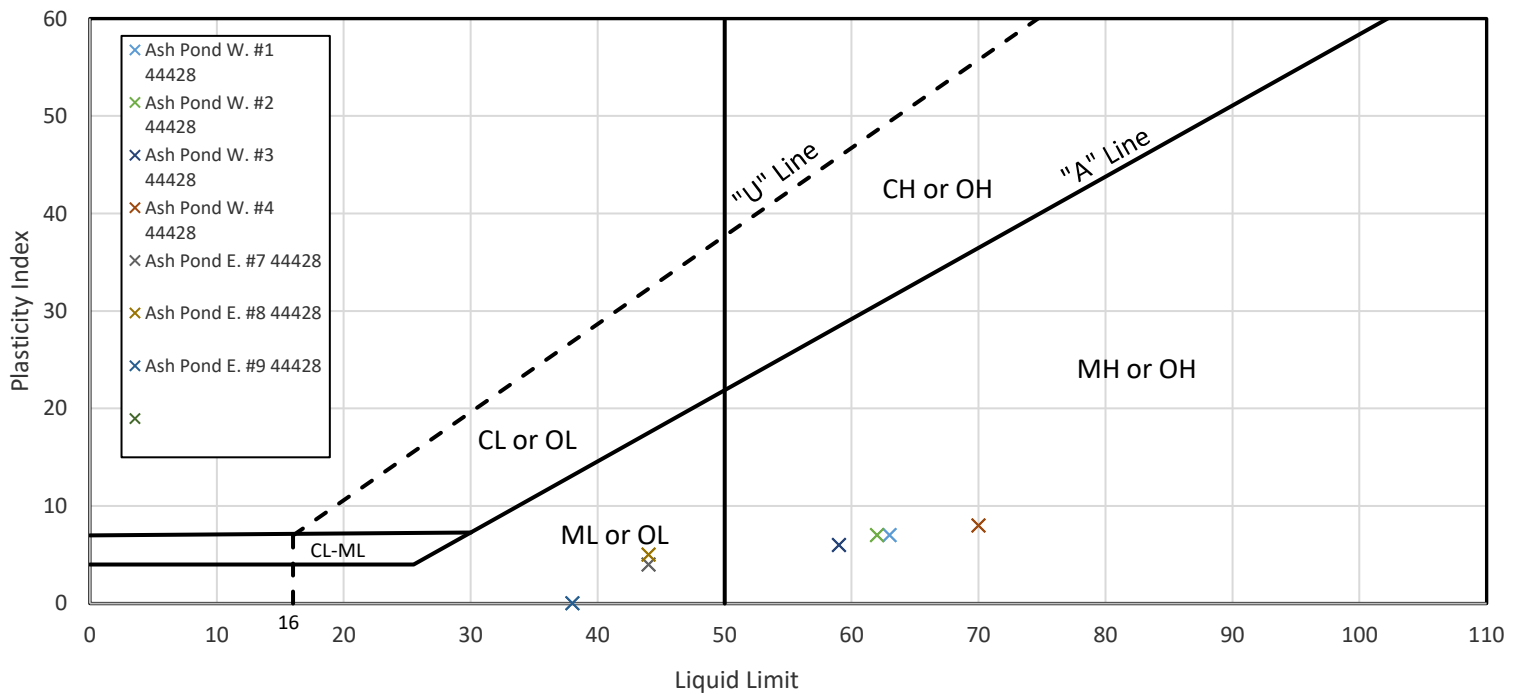

pH Testing Summary Sheet (ASTM:D4972)

Project: DTE STCPP
 Client: Barr Engineering Company

Job: 13334
 Date: 9/2/2021

Boring / Location	Sample	Sample Type	Date	pH	Visual Classification
Ash Pond W.	#1	Bag	8/20/2021	11.8	Elastic Silt (MH)
Ash Pond W.	#2	Bag	8/20/2021	11.8	Elastic Silt (MH)
Ash Pond W.	#3	Bag	8/20/2021	11.8	Elastic Silt (MH)
Ash Pond W.	#4	Bag	8/20/2021	11.8	Elastic Silt (MH)
Ash Pond E.	#7	Bag	8/20/2021	11.8	Silt (ML)
Ash Pond E.	#8	Bag	8/20/2021	12.1	Silt (ML)
Ash Pond E.	#9	Bag	8/20/2021	11.9	Silt (ML)

Grain Size Distribution ASTM D422-16

Job No. : **13334**

Project:	DTE STCPP	Test Date:	8/27/21
Reported To:	Barr Engineering Company	Report Date:	8/31/21

	Location / Boring No.	Sample No.	Date	Sample Type	Soil Classification
*	Ash Pond W.	#1	8/20/21	Bag	Elastic Silt (MH)
●	Ash Pond W.	#2	8/20/21	Bag	Elastic Silt (MH)
◇	Ash Pond W.	#3	8/20/21	Bag	Elastic Silt (MH)

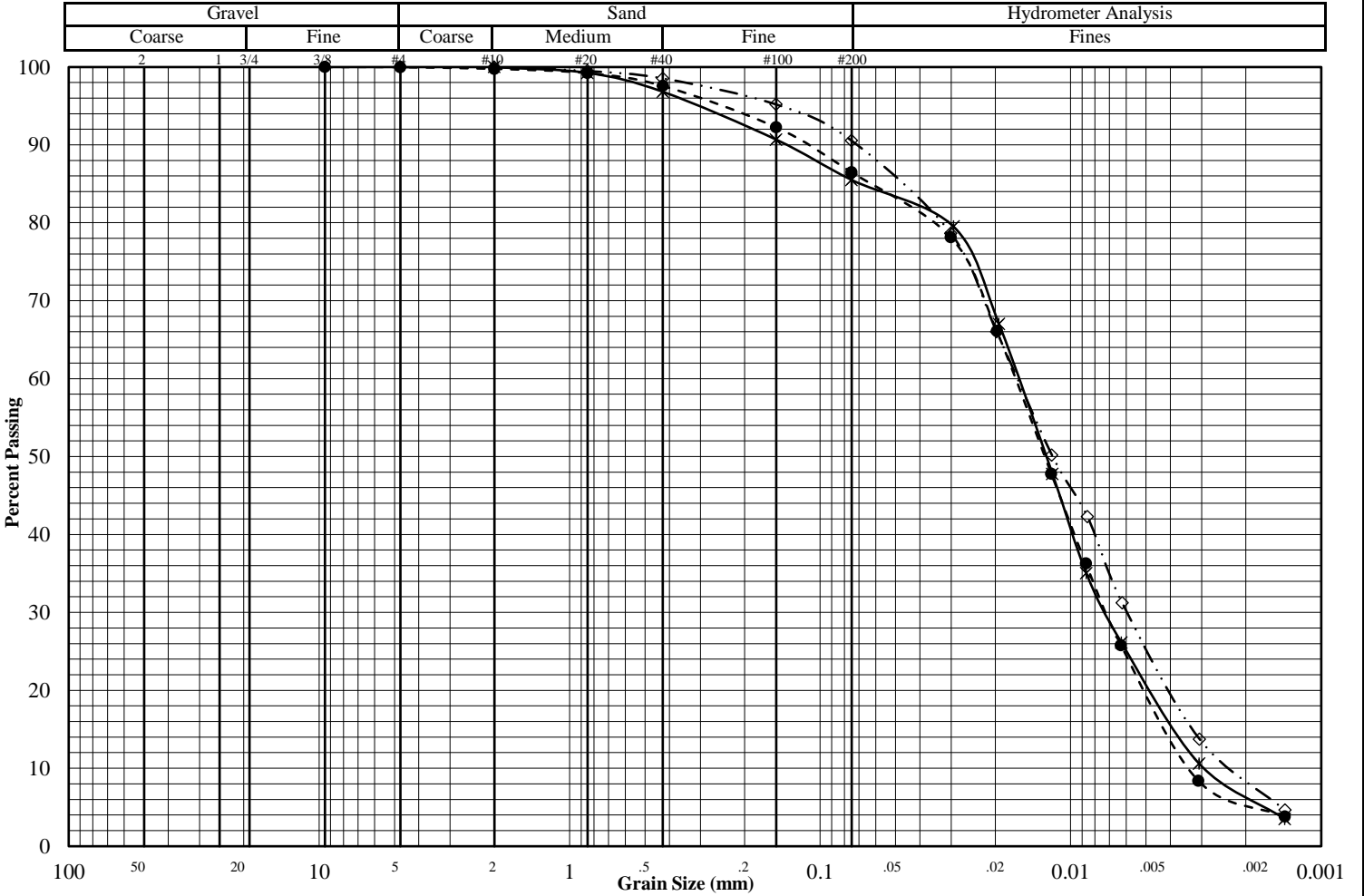

Additional Results

	*	●	◇
Liquid Limit	63	62	59
Plastic Limit	56	55	53
Plasticity Index <small>ASTM: D4316</small>	7	7	6
Water Content <small>ASTM: D2216</small>			
Dry Density (pcf) <small>ASTM: D7263</small>			
Specific Gravity <small>ASTM: D854</small>	2.55*	2.55*	2.55*
Porosity			
Organic Content <small>ASTM: D2974</small>			
pH <small>ASTM: D4972 Method B</small>	11.8	11.8	11.8

	Percent Passing		
	*	●	◇
Mass (g)	209.3	205.2	283.4
2"			
1.5"			
1"			
3/4"			
3/8"		100.0	
#4		100.0	100.0
#10	100.0	99.8	100.0
#20	99.2	99.2	99.5
#40	96.8	97.6	98.5
#100	90.7	92.3	95.2
#200	85.5	86.5	90.6

	*	●	◇
D ₆₀			
D ₃₀			
D ₁₀			
C _u			
C _c			

Remarks:

(* = assumed)

Grain Size Distribution ASTM D422-16

Job No. : **13334**

Project:	DTE STCPP	Test Date:	8/27/21
Reported To:	Barr Engineering Company	Report Date:	8/31/21

	Location / Boring No.	Sample No.	Date	Sample Type	Soil Classification
Spec 1	Ash Pond W.	#1	8/20/21	Bag	Elastic Silt (MH)
Spec 2	Ash Pond W.	#2	8/20/21	Bag	Elastic Silt (MH)
Spec 3	Ash Pond W.	#3	8/20/21	Bag	Elastic Silt (MH)

Sieve Data

Specimen 1		Specimen 2		Specimen 3	
Sieve	% Passing	Sieve	% Passing	Sieve	% Passing
2"		2"		2"	
1.5"		1.5"		1.5"	
1"		1"		1"	
3/4"		3/4"		3/4"	
3/8"		3/8"	100.0	3/8"	
#4		#4	100.0	#4	100.0
#10	100.0	#10	99.8	#10	100.0
#20	99.2	#20	99.2	#20	99.5
#40	96.8	#40	97.6	#40	98.5
#100	90.7	#100	92.3	#100	95.2
#200	85.5	#200	86.5	#200	90.6

Hydrometer Data

Specimen 1		Specimen 2		Specimen 3	
Diameter (mm)	% Passing	Diameter	% Passing	Diameter	% Passing
0.029	79.5	0.030	78.2	0.030	78.6
0.019	67.0	0.020	66.1	0.020	66.0
0.012	47.8	0.012	47.8	0.012	50.2
0.009	35.0	0.009	36.3	0.009	42.3
0.006	26.1	0.006	25.8	0.006	31.2
0.003	10.6	0.003	8.4	0.003	13.7
0.001	3.5	0.001	3.8	0.001	4.6

Remarks

Specimen 1	Specimen 2	Specimen 3

Grain Size Distribution ASTM D422-16

Job No. : **13334**

Project:	DTE STCPP	Test Date:	8/27/21
Reported To:	Barr Engineering Company	Report Date:	8/31/21

	Location / Boring No.	Sample No.	Date	Sample Type	Soil Classification
*	Ash Pond W.	#4	8/20/21	Bag	Elastic Silt (MH)
●	Ash Pond E.	#7	8/20/21	Bag	Silt (ML)
◇	Ash Pond E.	#8	8/20/21	Bag	Silt (ML)

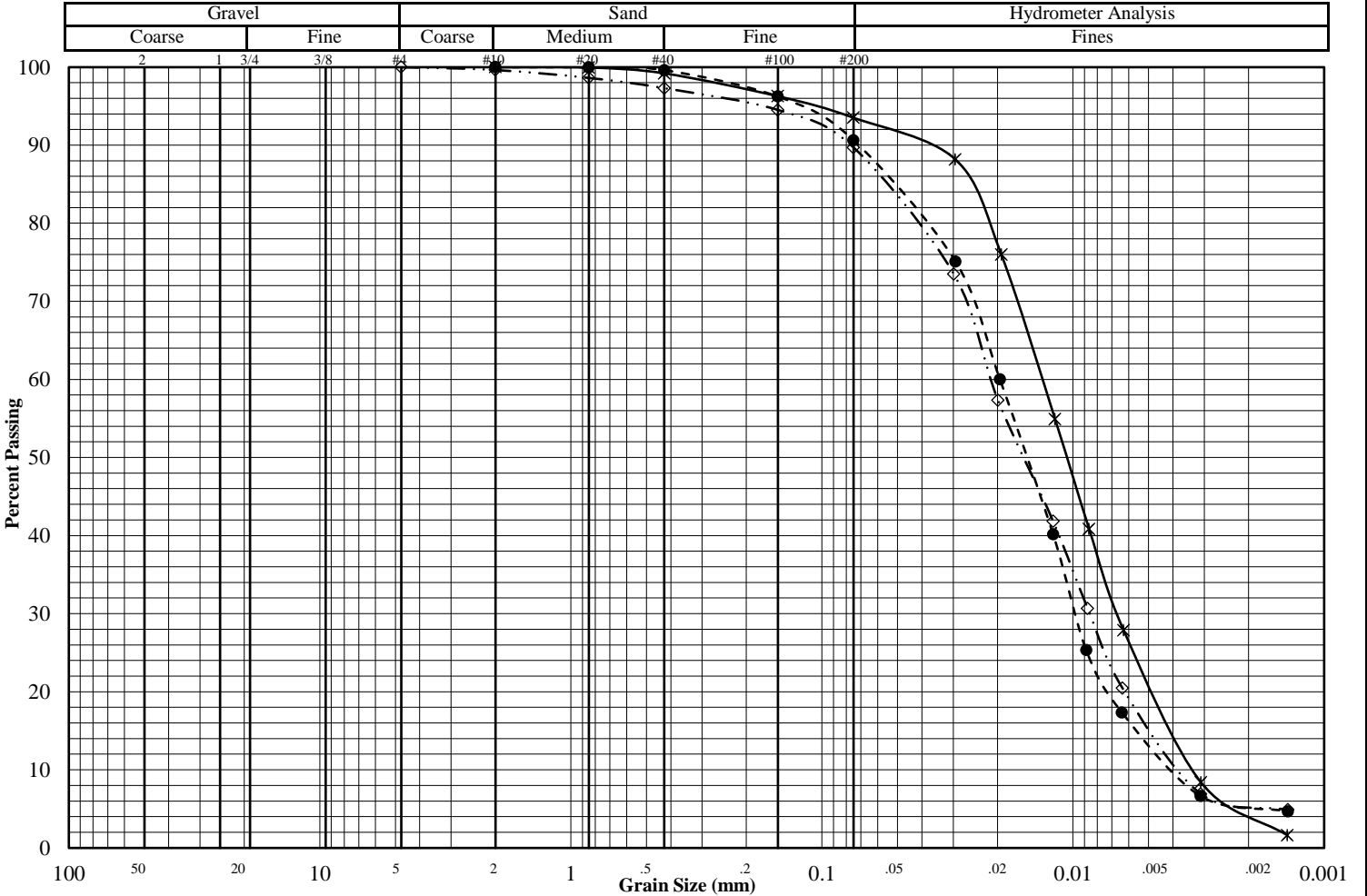

Additional Results	*	●	◇
Liquid Limit	70	44	44
Plastic Limit	62	40	39
Plasticity Index <small>ASTM: D4316</small>	8	4	5
Water Content <small>ASTM: D2216</small>			
Dry Density (pcf) <small>ASTM: D7263</small>			
Specific Gravity <small>ASTM: D854</small>	2.55*	2.61*	2.61*
Porosity			
Organic Content <small>ASTM: D2974</small>			
pH <small>ASTM: D4972 Method B</small>	11.8	11.8	12.1

	Percent Passing		
	*	●	◇
Mass (g)	210.4	195.0	320.5
2"			
1.5"			
1"			
3/4"			
3/8"			
#4			100.0
#10	100.0	100.0	99.6
#20	99.9	100.0	98.6
#40	99.2	99.6	97.3
#100	96.3	96.2	94.5
#200	93.5	90.6	89.7

	*	●	◇
D ₆₀			
D ₃₀			
D ₁₀			
C _u			
C _c			

Remarks:

(* = assumed)

Grain Size Distribution ASTM D422-16

Job No. : **13334**

Project:	DTE STCPP	Test Date:	8/27/21
Reported To:	Barr Engineering Company	Report Date:	8/31/21

	Location / Boring No.	Sample No.	Date	Sample Type	Soil Classification
Spec 1	Ash Pond W.	#4	8/20/21	Bag	Elastic Silt (MH)
Spec 2	Ash Pond E.	#7	8/20/21	Bag	Silt (ML)
Spec 3	Ash Pond E.	#8	8/20/21	Bag	Silt (ML)

Sieve Data

Specimen 1		Specimen 2		Specimen 3	
Sieve	% Passing	Sieve	% Passing	Sieve	% Passing
2"		2"		2"	
1.5"		1.5"		1.5"	
1"		1"		1"	
3/4"		3/4"		3/4"	
3/8"		3/8"		3/8"	
#4		#4		#4	100.0
#10	100.0	#10	100.0	#10	99.6
#20	99.9	#20	100.0	#20	98.6
#40	99.2	#40	99.6	#40	97.3
#100	96.3	#100	96.2	#100	94.5
#200	93.5	#200	90.6	#200	89.7

Hydrometer Data

Specimen 1		Specimen 2		Specimen 3	
Diameter (mm)	% Passing	Diameter	% Passing	Diameter	% Passing
0.029	88.2	0.029	75.1	0.030	73.5
0.019	76.0	0.020	60.0	0.020	57.3
0.012	54.9	0.012	40.2	0.012	41.9
0.009	40.8	0.009	25.3	0.009	30.7
0.006	27.9	0.006	17.4	0.006	20.5
0.003	8.4	0.003	6.6	0.003	6.9
0.001	1.6	0.001	4.7	0.001	4.9

Remarks

Specimen 1	Specimen 2	Specimen 3

Grain Size Distribution ASTM D422-16

Job No. : **13334**

Project:	DTE STCPP
Reported To:	Barr Engineering Company

Test Date:	8/27/21
Report Date:	8/31/21

	Location / Boring No.	Sample No.	Date	Sample Type	Soil Classification
*	Ash Pond E.	#9	8/20/21	Bag	Silt (ML)
●					
◇					

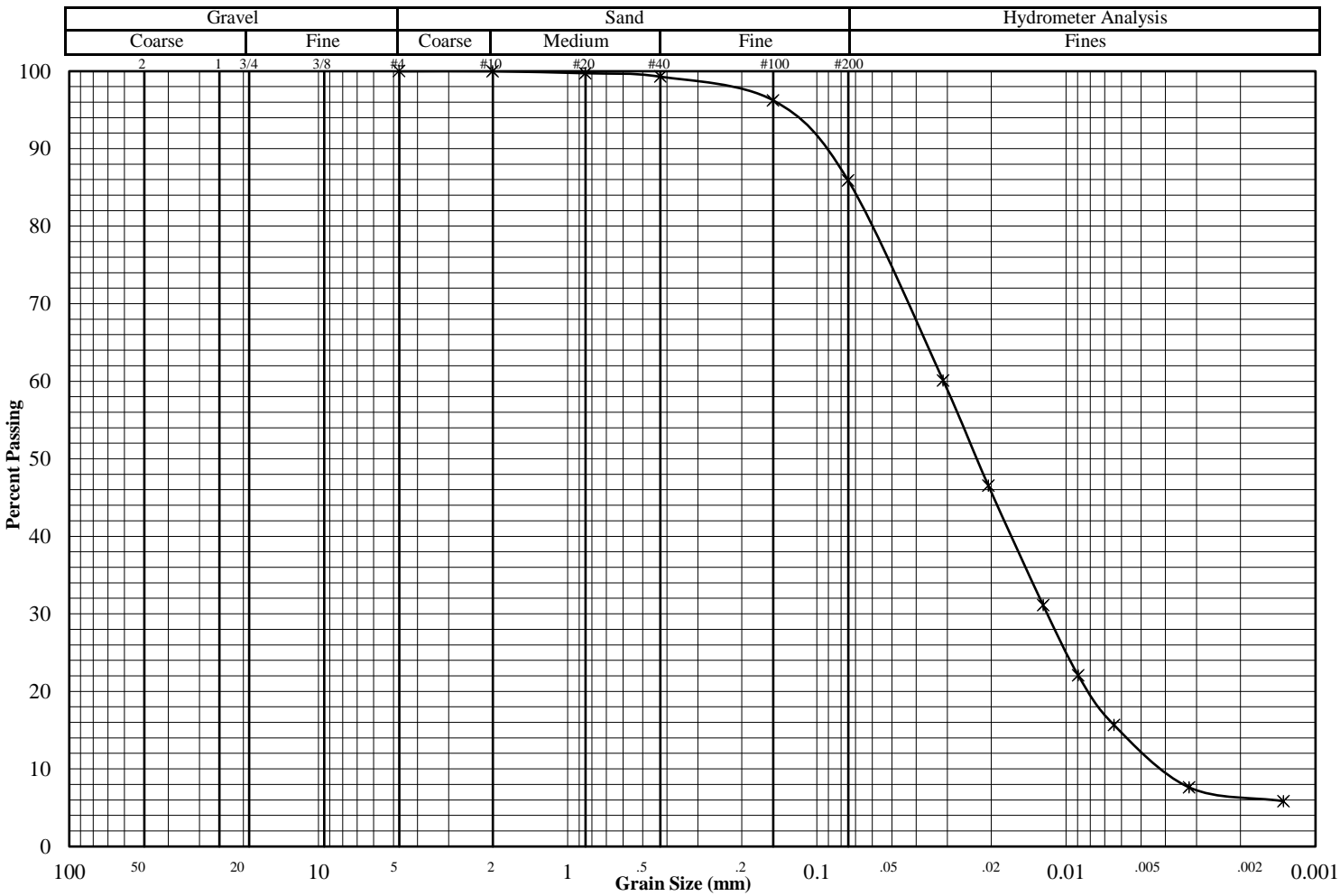

Additional Results	*	●	◇
Liquid Limit	38		
Plastic Limit	N/A		
Plasticity Index	NP		
Water Content			
Dry Density (pcf)			
Specific Gravity	2.62*		
Porosity			
Organic Content			
pH	11.9		

	Percent Passing		
	*	●	◇
Mass (g)	417.1		
2"			
1.5"			
1"			
3/4"			
3/8"			
#4	100.0		
#10	100.0		
#20	99.7		
#40	99.3		
#100	96.2		
#200	85.9		

	*	●	◇
D ₆₀			
D ₃₀			
D ₁₀			
C _u			
C _c			

Remarks:

(* = assumed)

Grain Size Distribution ASTM D422-16

Job No. : **13334**

Project:	DTE STCPP	Test Date:	8/27/21
Reported To:	Barr Engineering Company	Report Date:	8/31/21
Location / Boring No.	Sample No.	Date	Sample Type
Spec 1	Ash Pond E.	#9	8/20/21
Spec 2			
Spec 3			

Sieve Data

Specimen 1		Specimen 2		Specimen 3	
Sieve	% Passing	Sieve	% Passing	Sieve	% Passing
2"		2"		2"	
1.5"		1.5"		1.5"	
1"		1"		1"	
3/4"		3/4"		3/4"	
3/8"		3/8"		3/8"	
#4	100.0	#4		#4	
#10	100.0	#10		#10	
#20	99.7	#20		#20	
#40	99.3	#40		#40	
#100	96.2	#100		#100	
#200	85.9	#200		#200	

Hydrometer Data

Specimen 1		Specimen 2		Specimen 3	
Diameter (mm)	% Passing	Diameter	% Passing	Diameter	% Passing
0.031	60.1				
0.021	46.5				
0.012	31.1				
0.009	22.1				
0.006	15.7				
0.003	7.6				
0.001	5.8				

Remarks

Specimen 1	Specimen 2	Specimen 3

Laboratory Test Summary

Project: DTE STCPP Job: 13334
 Client: Barr Engineering Company Date: 9/2/2021

Sample Information & Classification

Boring #	Ash Pond W.	Ash Pond W.	Ash Pond W.	Ash Pond W.	Ash Pond E.	Ash Pond E.	Ash Pond E.	
Sample #	#1	#2	#3	#4	#7	#8	#9	
Date	8/20/2021	8/20/2021	8/20/2021	8/20/2021	8/20/2021	8/20/2021	8/20/2021	
Sample Type	Bag	Bag	Bag	Bag	Bag	Bag	Bag	
Material Classification	Elastic Silt (MH)	Elastic Silt (MH)	Elastic Silt (MH)	Elastic Silt (MH)	Silt (ML)	Silt (ML)	Silt (ML)	

Atterberg Limits (ASTM:D4318)

Liquid Limit	63	62	59	70	44	44	38	
Plastic Limit	56	55	53	62	40	39	N/A	
Plasticity Index	7	7	6	8	4	5	NP	

Plasticity Chart (ASTM:D2487)

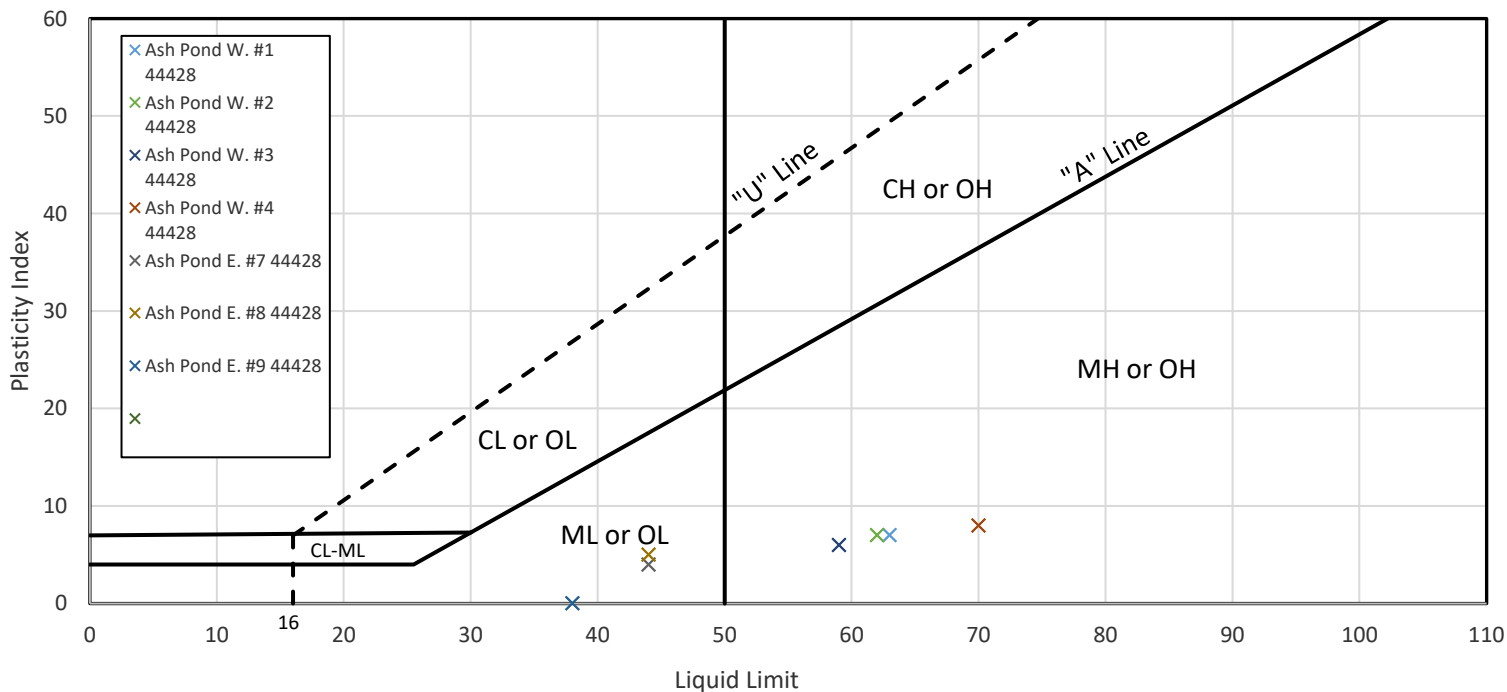

pH Testing Summary Sheet (ASTM:D4972)

Project: DTE STCPP
 Client: Barr Engineering Company

Job: 13334
 Date: 9/2/2021

Boring / Location	Sample	Sample Type	Date	pH	Visual Classification
Ash Pond W.	#1	Bag	8/20/2021	11.8	Elastic Silt (MH)
Ash Pond W.	#2	Bag	8/20/2021	11.8	Elastic Silt (MH)
Ash Pond W.	#3	Bag	8/20/2021	11.8	Elastic Silt (MH)
Ash Pond W.	#4	Bag	8/20/2021	11.8	Elastic Silt (MH)
Ash Pond E.	#7	Bag	8/20/2021	11.8	Silt (ML)
Ash Pond E.	#8	Bag	8/20/2021	12.1	Silt (ML)
Ash Pond E.	#9	Bag	8/20/2021	11.9	Silt (ML)

62199 East Basin 1 & 1A_rev1

JOB NAME:	BARR - DTE Ash Pond		
PROJECT NO.	62199		
SAMPLE SOURCE:	Ash Composite from Vibracore		
SAMPLE ID:	East Basin 1 & 1A Comb.	INTENDED USE:	Assessment for Fill
DATE SAMPLED:	10/2/2021		

ASTM D-422/D-4318

		TOTAL SAMPLE WT.= 217.7 (gms.)			TOTAL	DIAMETER
+10 SIEVE PORTION	SIEVE SIZE	CUM WT. RET	PART % RET	PART % PASS	PASSING	(mm)
	1	0.0	0.0%	100.0%	100.0%	25.000
	3/4 IN	0.0	0.0%	100.0%	100.0%	19.000
	1/2 IN	0.0	0.0%	100.0%	100.0%	12.500
	3/8 IN	0.0	0.0%	100.0%	100.0%	9.500
	#4	0.0	0.0%	100.0%	100.0%	4.750
	#10	0.0	0.0%	100.0%	100.0%	2.000
WT. OF SAMPLE AT START OF HYDRO=		50.0 (gms.)				
-#10 SIEVE PORTION						
	#20	0.0	0.0%	100.0%	100.0%	0.850
	#40	0.2	0.4%	99.6%	99.6%	0.420
	#100	1.8	3.6%	96.4%	96.4%	0.150
	#200	6.3	12.6%	87.4%	87.4%	0.075
HYDROMETER PORTION	TEMPERATURE(°C)=	19.0				
	TEMP BATH BULB READ=	5.0				
	SPECIFIC GRAVITY G _s =	2.70 (assumed)				
	ELAPSED TIME (MIN)	UNCORR	CORRECTED	% PASS		
	1	49.0	44.0	87.1%	87.1%	0.0392
	2	47.0	42.0	83.2%	83.2%	0.0282
	5	36.0	31.0	61.4%	61.4%	0.0196
	15	30.0	25.0	49.5%	49.5%	0.0119
	30	24.0	19.0	37.6%	37.6%	0.0088
	60	20.0	15.0	29.7%	29.7%	0.0063
	120	16.0	11.0	21.8%	21.8%	0.0046
	240	14.0	9.0	17.8%	17.8%	0.0033
	1450	13.0	8.0	15.8%	15.8%	0.0013

soil classification:

GRAVEL=	0.0%
SAND=	12.6%
SILT=	71.4%
CLAY=	16.0%

62199 West Basin 1 & 1A

JOB NAME:	BARR - DTE Ash Pond		
PROJECT NO.	62199		
SAMPLE SOURCE:	Ash Composite from Vibracore		
SAMPLE ID:	West Basin 1 & 1A Comb.	INTENDED USE:	Assessment for Fill
DATE SAMPLED:	10/1/2021		

ASTM D-422/D-4318

		TOTAL SAMPLE WT.= 289.5 (gms.)			TOTAL	DIAMETER
+10 SIEVE PORTION	SIEVE SIZE	CUM WT. RET	PART % RET	PART % PASS	PASSING	(mm)
	1	0.0	0.0%	100.0%	100.0%	25.000
	3/4 IN	0.0	0.0%	100.0%	100.0%	19.000
	1/2 IN	0.0	0.0%	100.0%	100.0%	12.500
	3/8 IN	0.0	0.0%	100.0%	100.0%	9.500
	#4	0.0	0.0%	100.0%	100.0%	4.750
	#10	0.0	0.0%	100.0%	100.0%	2.000
WT. OF SAMPLE AT START OF HYDRO=		50.0 (gms.)				
-#10 SIEVE PORTION						
	#20	0.0	0.0%	100.0%	100.0%	0.850
	#40	0.2	0.4%	99.6%	99.6%	0.420
	#100	1.8	3.6%	96.4%	96.4%	0.150
	#200	6.3	12.6%	87.4%	87.4%	0.075
HYDROMETER PORTION	TEMPERATURE(°C)=	19.0				
	TEMP BATH BULB READ=	5.0				
	SPECIFIC GRAVITY G _s =	2.70 (assumed)				
	ELAPSED TIME (MIN)	UNCORR	CORRECTED	% PASS		
	1	49.0	44.0	87.1%	87.1%	0.0392
	2	42.0	37.0	73.3%	73.3%	0.0295
	5	37.0	32.0	63.4%	63.4%	0.0194
	15	30.0	25.0	49.5%	49.5%	0.0119
	30	25.0	20.0	39.6%	39.6%	0.0087
	60	24.0	19.0	37.6%	37.6%	0.0062
	120	20.0	15.0	29.7%	29.7%	0.0045
	240	17.0	12.0	23.8%	23.8%	0.0032
	1450	16.0	11.0	21.8%	21.8%	0.0013

soil classification:

GRAVEL=	0.0%
SAND=	12.6%
SILT=	65.4%
CLAY=	22.0%

JOB NAME:	BARR - DTE Ash Pond		
PROJECT NO.	62199		
SAMPLE SOURCE:	SB-01-21		
SAMPLE ID:	18' to 20'	INTENDED USE:	Assessment for Fill
DATE SAMPLED:	10/2/2021		

ASTM D-422/D-4318

		TOTAL SAMPLE WT.= 217.7 (gms.)			TOTAL	DIAMETER
+10 SIEVE PORTION	SIEVE SIZE	CUM WT. RET	PART % RET	PART % PASS	PASSING	(mm)
	1	0.0	0.0%	100.0%	100.0%	25.000
	3/4 IN	0.0	0.0%	100.0%	100.0%	19.000
	1/2 IN	0.0	0.0%	100.0%	100.0%	12.500
	3/8 IN	0.0	0.0%	100.0%	100.0%	9.500
	#4	0.0	0.0%	100.0%	100.0%	4.750
	#10	0.0	0.0%	100.0%	100.0%	2.000
WT. OF SAMPLE AT START OF HYDRO=		50.0 (gms.)				
-#10 SIEVE PORTION	SIEVE SIZE	CUM WT. RET	PART % RET	PART % PASS	PASSING	DIAMETER
	#20	0.0	0.0%	100.0%	100.0%	0.850
	#40	0.0	0.0%	100.0%	100.0%	0.420
	#100	0.0	0.0%	100.0%	100.0%	0.150
	#200	0.0	0.0%	100.0%	100.0%	0.075
HYDROMETER PORTION	TEMPERATURE(°C)=	18.8				
	TEMP BATH BULB READ=	7.0				
	SPECIFIC GRAVITY G _s =	2.72 (assumed)				
	ELAPSED TIME (MIN)	UNCORR	CORRECTED	% PASS		
	1	57.0	50.0	99.0%	99.0%	0.0355
	2	57.0	50.0	99.0%	99.0%	0.0251
	4	56.0	49.0	97.0%	97.0%	0.0179
	8	56.0	49.0	97.0%	97.0%	0.0126
	15	55.0	48.0	95.0%	95.0%	0.0094
	30	53.0	46.0	91.1%	91.1%	0.0068
	60	50.0	43.0	85.1%	85.1%	0.0049
	120	46.0	39.0	77.2%	77.2%	0.0036
	240	41.0	34.0	67.3%	67.3%	0.0027
	1440	32.0	25.0	49.5%	49.5%	0.0012

soil classification:

GRAVEL=	0.0%
SAND=	0.0%
SILT=	33.5%
CLAY=	66.5%

JOB NAME:	BARR - DTE Ash Pond		
PROJECT NO.	62199		
SAMPLE SOURCE:	SB-01-21		
SAMPLE ID:	40' to 42'	INTENDED USE:	Assessment for Fill
DATE SAMPLED:	10/2/2021		

ASTM D-422/D-4318

		TOTAL SAMPLE WT.= 217.7 (gms.)			TOTAL	DIAMETER
+10 SIEVE PORTION	SIEVE SIZE	CUM WT. RET	PART % RET	PART % PASS	PASSING	(mm)
	1	0.0	0.0%	100.0%	100.0%	25.000
	3/4 IN	0.0	0.0%	100.0%	100.0%	19.000
	1/2 IN	0.0	0.0%	100.0%	100.0%	12.500
	3/8 IN	0.0	0.0%	100.0%	100.0%	9.500
	#4	0.0	0.0%	100.0%	100.0%	4.750
	#10	0.0	0.0%	100.0%	100.0%	2.000
WT. OF SAMPLE AT START OF HYDRO=		50.0 (gms.)				
-#10 SIEVE PORTION						
	#20	0.0	0.0%	100.0%	100.0%	0.850
	#40	0.0	0.0%	100.0%	100.0%	0.420
	#100	0.0	0.0%	100.0%	100.0%	0.150
	#200	0.0	0.0%	100.0%	100.0%	0.075
HYDROMETER PORTION	TEMPERATURE(°C)=	18.8				
	TEMP BATH BULB READ=	7.0				
	SPECIFIC GRAVITY G _s =	2.72 (assumed)				
	ELAPSED TIME (MIN)	UNCORR	CORRECTED	% PASS		
	1	52.0	44.0	87.1%	87.1%	0.0375
	2	50.0	43.0	85.1%	85.1%	0.0270
	4	47.0	40.0	79.2%	79.2%	0.0197
	8	44.0	37.0	73.3%	73.3%	0.0143
	15	41.0	34.0	67.3%	67.3%	0.0107
	30	37.0	30.0	59.4%	59.4%	0.0078
	60	32.0	25.0	49.5%	49.5%	0.0058
	120	27.0	20.0	39.6%	39.6%	0.0042
	240	25.0	18.0	35.6%	35.6%	0.0030
	1440	17.0	10.0	19.8%	19.8%	0.0013

soil classification:

GRAVEL=	0.0%
SAND=	0.0%
SILT=	71.8%
CLAY=	28.2%

JOB NAME:	BARR - DTE Ash Pond		
PROJECT NO.	62199		
SAMPLE SOURCE:	SB-02-21		
SAMPLE ID:	14' to 16'	INTENDED USE:	Assessment for Fill
DATE SAMPLED:	10/2/2021		

ASTM D-422/D-4318

		TOTAL SAMPLE WT.= 217.7 (gms.)			TOTAL	DIAMETER
+10 SIEVE PORTION	SIEVE SIZE	CUM WT. RET	PART % RET	PART % PASS	PASSING	(mm)
	1	0.0	0.0%	100.0%	100.0%	25.000
	3/4 IN	0.0	0.0%	100.0%	100.0%	19.000
	1/2 IN	0.0	0.0%	100.0%	100.0%	12.500
	3/8 IN	0.0	0.0%	100.0%	100.0%	9.500
	#4	0.0	0.0%	100.0%	100.0%	4.750
	#10	0.0	0.0%	100.0%	100.0%	2.000
WT. OF SAMPLE AT START OF HYDRO=		50.0 (gms.)				
-#10 SIEVE PORTION						
	#20	0.0	0.0%	100.0%	100.0%	0.850
	#40	0.0	0.0%	100.0%	100.0%	0.420
	#100	0.0	0.0%	100.0%	100.0%	0.150
	#200	0.0	0.0%	100.0%	100.0%	0.075
HYDROMETER PORTION	TEMPERATURE(°C)=	18.8				
	TEMP BATH BULB READ=	7.0				
	SPECIFIC GRAVITY G _s =	2.72 (assumed)				
	ELAPSED TIME (MIN)	UNCORR	CORRECTED	% PASS		
	1	53.0	46.0	91.1%	91.1%	0.0370
	2	52.0	45.0	89.1%	89.1%	0.0265
	4	51.0	44.0	87.1%	87.1%	0.0189
	8	51.0	44.0	87.1%	87.1%	0.0133
	15	49.0	42.0	83.2%	83.2%	0.0100
	30	47.0	40.0	79.2%	79.2%	0.0072
	60	44.0	37.0	73.3%	73.3%	0.0052
	120	40.0	33.0	65.3%	65.3%	0.0038
	240	37.0	30.0	59.4%	59.4%	0.0028
	1440	30.0	23.0	45.5%	45.5%	0.0012

soil classification:

GRAVEL=	0.0%
SAND=	0.0%
SILT=	41.7%
CLAY=	58.3%

JOB NAME:	BARR - DTE Ash Pond		
PROJECT NO.	62199		
SAMPLE SOURCE:	SB-02-21		
SAMPLE ID:	56' to 58'	INTENDED USE:	Assessment for Fill
DATE SAMPLED:	10/2/2021		

ASTM D-422/D-4318

		TOTAL SAMPLE WT.= 217.7 (gms.)			TOTAL	DIAMETER
+10 SIEVE PORTION	SIEVE SIZE	CUM WT. RET	PART % RET	PART % PASS	PASSING	(mm)
	1	0.0	0.0%	100.0%	100.0%	25.000
	3/4 IN	0.0	0.0%	100.0%	100.0%	19.000
	1/2 IN	0.0	0.0%	100.0%	100.0%	12.500
	3/8 IN	0.0	0.0%	100.0%	100.0%	9.500
	#4	0.0	0.0%	100.0%	100.0%	4.750
	#10	0.0	0.0%	100.0%	100.0%	2.000
WT. OF SAMPLE AT START OF HYDRO=		50.0 (gms.)				
-#10 SIEVE PORTION						
	#20	0.0	0.0%	100.0%	100.0%	0.850
	#40	0.0	0.0%	100.0%	100.0%	0.420
	#100	0.0	0.0%	100.0%	100.0%	0.150
	#200	0.0	0.0%	100.0%	100.0%	0.075
HYDROMETER PORTION	TEMPERATURE(°C)=	18.8				
	TEMP BATH BULB READ=	7.0				
	SPECIFIC GRAVITY G _s =	2.72 (assumed)				
	ELAPSED TIME (MIN)	UNCORR	CORRECTED	% PASS		
	1	50.0	43.0	85.1%	85.1%	0.0382
	2	49.0	42.0	83.2%	83.2%	0.0273
	4	48.0	41.0	81.2%	81.2%	0.0194
	8	46.0	39.0	77.2%	77.2%	0.0141
	15	45.0	38.0	75.2%	75.2%	0.0103
	30	42.0	35.0	69.3%	69.3%	0.0075
	60	40.0	33.0	65.3%	65.3%	0.0054
	120	36.0	29.0	57.4%	57.4%	0.0040
	240	31.0	24.0	47.5%	47.5%	0.0029
	1440	24.0	17.0	33.7%	33.7%	0.0012

soil classification:

GRAVEL=	0.0%
SAND=	0.0%
SILT=	56.9%
CLAY=	43.1%

Triaxial Permeability

Specimen mass and geometry

Mass (g)	Diameter (cm)	Length (cm)	Area (cm ²)	Volume (cm ³)
967.7	7.25	12.0	41.28	495.4

Initial water content data

Container	Mass of wet soil & container (g)	Mass of dry soil & container (g)	Mass of container (g)
26	111.3	90.4	26.6

Initial water content and density values

Water content (%)	Bulk density (g/cm ³)	Dry density (g/cm ³)
32.76	1.953	1.471

Final water content data and value

Container	Mass of wet soil & container (g)	Mass of dry soil & container (g)	Mass of container (g)	Water content (%)
26	111.3	90.4	26.6	32.76

Triaxial Permeability

Equipment constants

Burette	Elevation at top (cm)	Volume (cm ³)	Length (cm)	Area (cm ²)
Bottom	71.8	50	49.5	1.01
Top	72.0	50	49.5	1.01

Pressures for test

Item	Pressure (psi)	Pressure (Pa)	Water head (m)
Cell	25.94	178.84	18.230
Bottom	24.05	165.81	16.902
Top	21.45	147.88	15.075

Triaxial Permeability

Test values for Test 1

Time	Volume in bottom burette (cm ³)	Volume in top burette (cm ³)	Elevation at bottom burette (cm)	Elevation at top burette (cm)	Head in bottom burette (cm)	Head in top burette (cm)	Head difference (cm)
Start	10.0	34.8	61.9	37.5	1727.728	1542.257	185.470
End	13.6	31.5	58.3	40.8	1730.995	1538.957	192.037
	-3.6	3.3					

Permeability values for Test 1

Burette area (cm ²)	Specimen length (cm)	Specimen area (cm ²)	Duration of test (sec)	Initial head (cm)	Final head (cm)	Coefficient of permeability (cm/sec)
1.01	12.0	41.28	25200	185.470	192.037	4.05E-07

Triaxial Permeability

Test values for Test 2

Time	Volume in bottom burette (cm ³)	Volume in top burette (cm ³)	Elevation at bottom burette (cm)	Elevation at top burette (cm)	Head in bottom burette (cm)	Head in top burette (cm)	Head difference (cm)
Start	13.6	31.5	58.3	40.8	1730.995	1538.957	192.037
End	21.0 -7.4	24.3 7.2	51.0	47.9	1738.123	1531.757	206.365

Permeability values for Test 2

Burette area (cm ²)	Specimen length (cm)	Specimen area (cm ²)	Duration of test (sec)	Initial head (cm)	Final head (cm)	Coefficient of permeability (cm/sec)
1.01	12.0	41.28	61200	192.037	206.365	3.45E-07

Triaxial Permeability

Test values for Test 3

Time	Volume in bottom burette (cm ³)	Volume in top burette (cm ³)	Elevation at bottom burette (cm)	Elevation at top burette (cm)	Head in bottom burette (cm)	Head in top burette (cm)	Head difference (cm)
Start	21.0	24.3	51.0	47.9	1738.123	1531.757	206.365
End	23.7	21.5	48.3	50.7	1740.895	1528.957	211.937
	-2.7	2.8					

Permeability values for Test 3

Burette area (cm ²)	Specimen length (cm)	Specimen area (cm ²)	Duration of test (sec)	Initial head (cm)	Final head (cm)	Coefficient of permeability (cm/sec)
1.01	12.0	41.28	25200	206.365	211.937	3.10E-07



Testing Engineers and Consultants, Inc.

1343 Rochester Road PO Box 249 Troy, Michigan 48099-0249
248-588-6200 or 313 T-E-S-T-I-N-G
Fax 248-588-6232

SOIL COMPACTION TEST GRAPH

PROJECT: DTE Ash Pond

TEC REPORT NUMBER: 62199

LOCATION:

REPORT DATE: 12/17/21

CLIENT: DTE

TEST METHOD: ASTM D1557

SOURCE TEST: #1

Material Description: EAST Basin 1A+1

Sample Date: 07/01/21

Sample Source:

Sampled By: TEC

Sample Location:

Maximum Density: 77.9 pcf

Intended Use:

Optimum Moisture: 34.9 %

EAST 1+1A

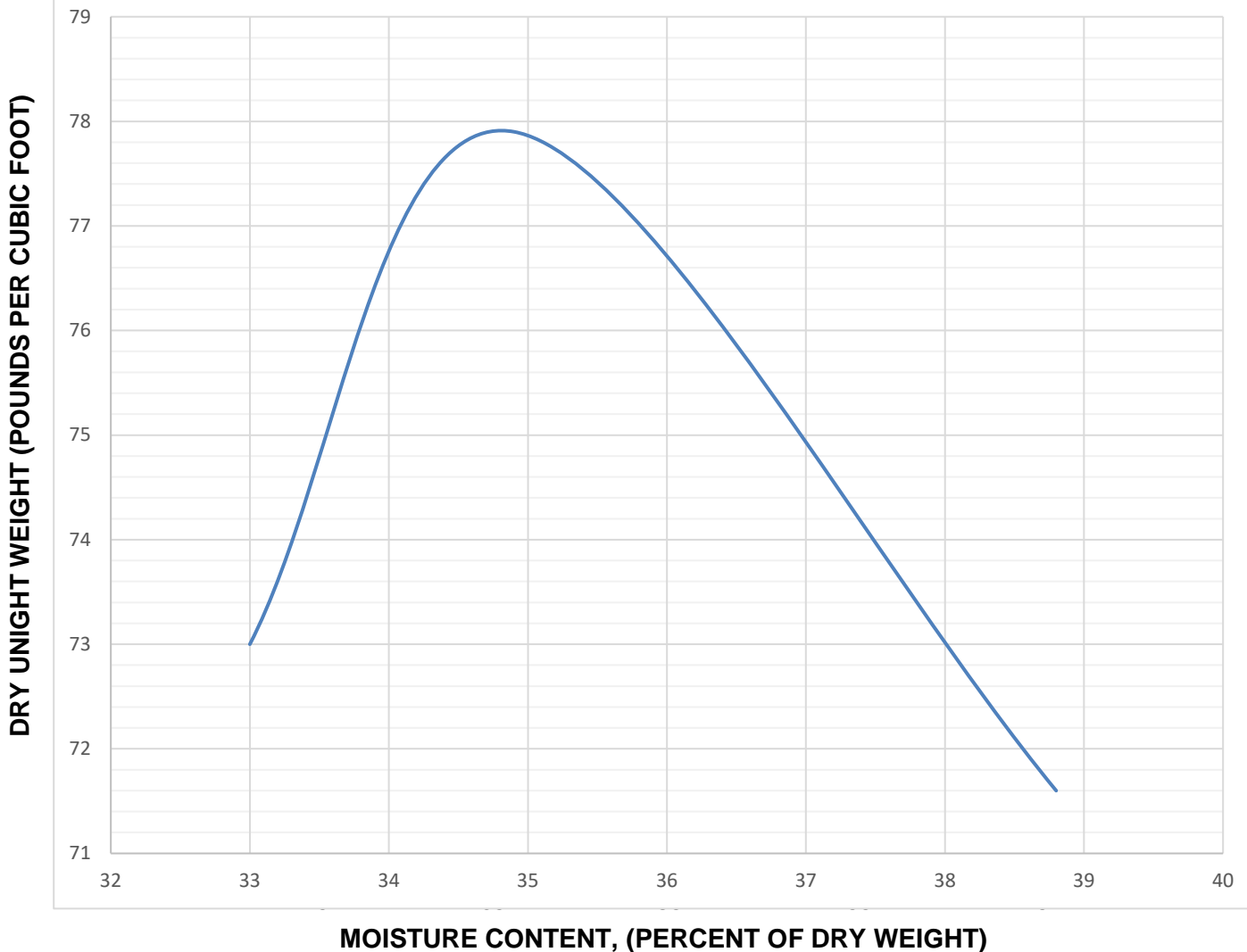

TESTED BY: JC

PLOTTED BY: CS

REVIEWED BY: CS



Testing Engineers and Consultants, Inc.

1343 Rochester Road PO Box 249 Troy, Michigan 48099-0249

248-588-6200 or 313 T-E-S-T-I-N-G

Fax 248-588-6232

SOIL COMPACTION TEST GRAPH

PROJECT: DTE Ash Pond

TEC REPORT NUMBER: 62199

LOCATION:

REPORT DATE: 12/17/21

CLIENT: DTE

TEST METHOD: ASTM D1557

SOURCE TEST: #1

Material Description: WEST 1A+1

Sample Date:

Sample Source:

Sampled By: TEC

Sample Location:

Maximum Density: 53.7 pcf

Intended Use:

Optimum Moisture: 66.5 %

WEST1+1A

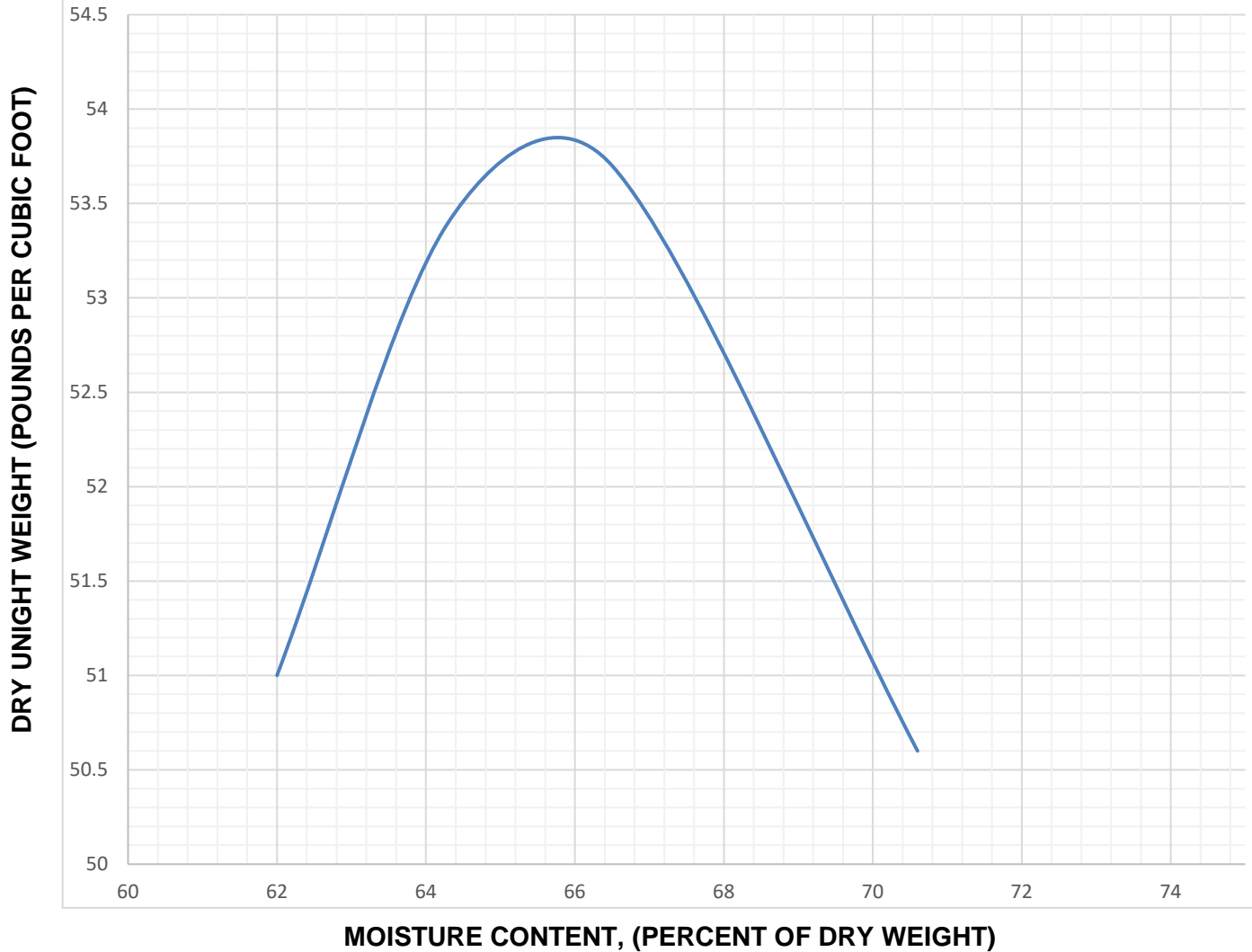

TESTED BY: JC

PLOTTED BY: CS

REVIEWED BY: CS

Ash Laboratory Results Summary

Boring	Specific gravity	Moisture content/organic properties			Atterberg limits		
		Moisture content Air dried (%)	Moisture content Oven dried after saturation (%)	Organic content (%)	Liquid limit	Plastic limit	Plasticity index
East basin 1	2.61 combined	35.9	83.7	8.7	49 combined	45	4
East basin 1A		28.5	89.9	6.1			
West basin 1	2.41 combined	41.9	123.0	16.1	35 combined	30	5
West basin 1A		60.2	124.2	17.0			

Clay Lab Summary

Boring	Depth (ft)	Weight – volume properties			Unconfined compressive strength (psf)	Atterberg limits		
		Moisture content (%)	Bulk unit weight (pcf)	Dry unit weight (pcf)		Liquid limit	Plastic limit	Plasticity index
SB-01-21	18 to 20	26.0	115.2	91.5	1520	39	29	10
SB-01-21	40 to 42	23.8	112.8	90.6	1510	29	23	6
SB-02-21	56 to 68	23.1	119.2	96.9	1930	33	22	11
SB-02-21	14 to 16	26.6	115.1	90.9	3450	37	23	14

UNCONFINED COMPRESSION TEST

Project Name: STCPP

Depth: 14-16 ft

Sample Number: 22741069 SB-02-21

Visual Classification: Brown Silty 10/5/2021

Sample data

Bag # 8

Weight of specimen (g)	Initial length (in)	Initial diameter (in)	Initial area (in ²)
1259.78	6.043	2.964	6.899

Water content data

Moist soil (g)	Dry soil (g)	Water (g)
991.56	783.04	208.52

Moisture content and unit weight results

Moisture content (%)	Bulk unit weight (pcf)	Dry unit weight (pcf)
26.63	115.1	90.9

Deformation - load and stress - strain results

Deformation (in)	Vertical Strain ϵ	Corrected Area (in ²)	Load (lb)	Stress (lb/ft ²)
0	0	6.899	0	0
0.05	0.008	6.955	26.1	540
0.1	0.017	7.018	55.7	1140
0.15	0.025	7.076	86.8	1770
0.2	0.033	7.134	108.6	2190
0.25	0.041	7.194	130.2	2610
0.3	0.05	7.262	147	2910
0.35	0.058	7.324	159.9	3140
0.4	0.066	7.387	170.3	3320
0.45	0.074	7.45	177.2	3430
0.5	0.083	7.523	174.8	3350
0.55	0.091	7.59	161.3	3060

UNCONFINED COMPRESSION TEST

Project Name: STCPP

Depth: 18-20 ft

Sample Number: 227410 CA SB-01-21

Visual Classification: Brown Silty 10/4/2021

Sample data

Weight of specimen (g)	Initial length (in)	Initial diameter (in)	Initial area (in ²)
1140.44	6.035	2.864	6.441

Water content data

Moist soil (g)	Dry soil (g)	Water (g)
953.93	756.88	197.05

Moisture content and unit weight results

Moisture content (%)	Bulk unit weight ^f (pcf)	Dry unit weight (pcf)
26.03	111.8	88.7

Deformation - load and stress - strain results

Deformation (in)	Vertical Strain ϵ	Corrected Area (in ²)	Load (lb)	Stress (lb/ft ²)
0	0	6.441	0	0
0.05	0.008	6.493	12.5	280
0.1	0.017	6.552	21.1	460
0.15	0.025	6.606	27.4	600
0.2	0.033	6.661	34	740
0.25	0.041	6.716	39.2	840
0.3	0.05	6.78	44.9	950
0.35	0.058	6.838	49.8	1050
0.4	0.066	6.896	54.7	1140
0.45	0.075	6.963	58.4	1210
0.5	0.083	7.024	61.9	1270
0.55	0.091	7.086	65.5	1330
0.6	0.099	7.149	68.3	1380
0.65	0.108	7.221	71.2	1420
0.7	0.116	7.286	73.1	1440
0.75	0.124	7.353	75.1	1470
0.8	0.133	7.429	77	1490
0.85	0.141	7.498	78.3	1500
0.9	0.149	7.569	80.1	1520

SB-01-2021 18 to 20 feet

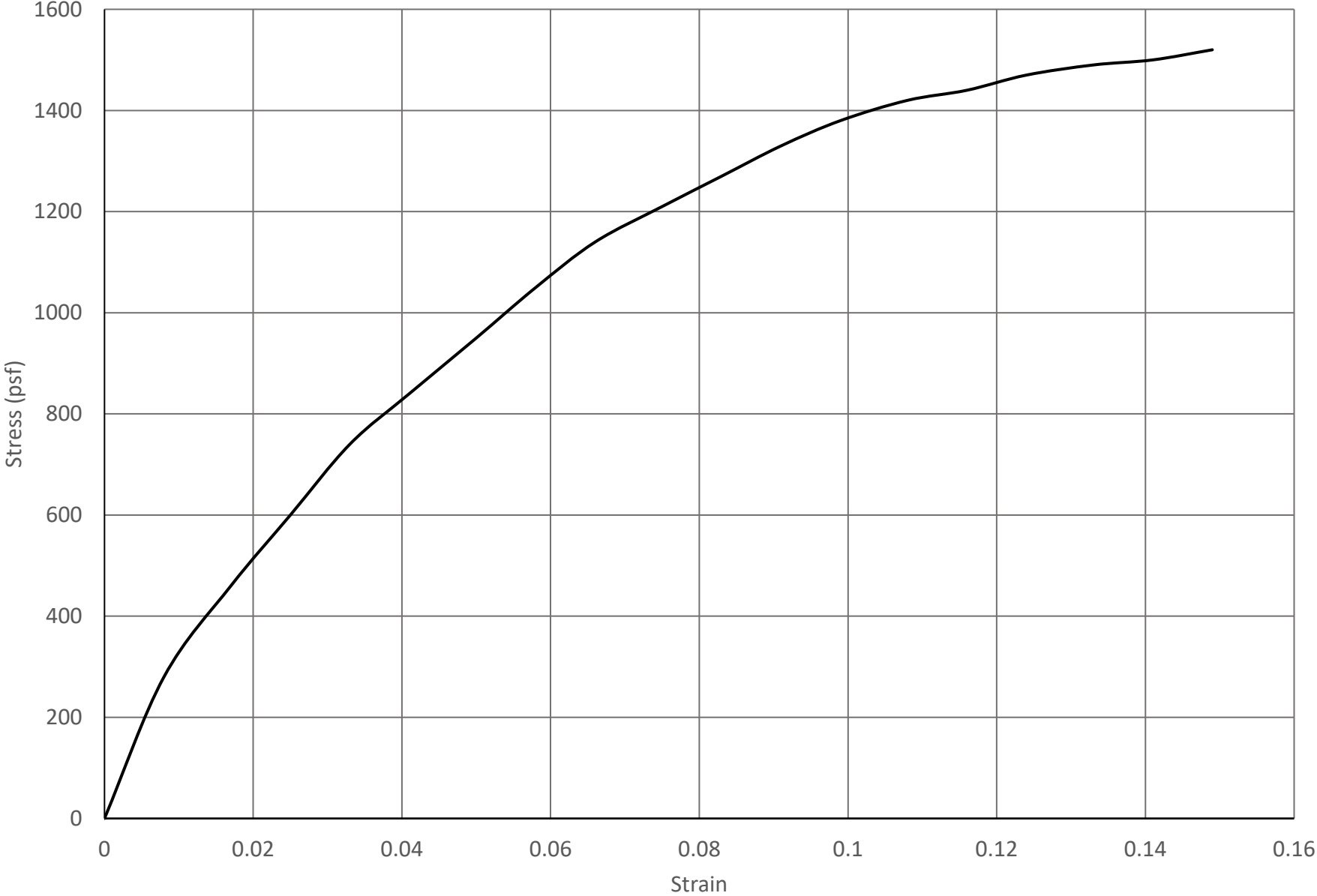

UNCONFINED COMPRESSION TEST

Project Name: STCPP

Depth: 40-42 ft

Sample Number: 27741069 SB-01-21

Visual Classification: Brown Silty 10/4/2021

Sample data

Weight of specimen (g)	Initial length (in)	Initial diameter (in)	Initial area (in ²)
1223.81	6.034	2.964	6.899

Water content data

Moist soil (g)	Dry soil (g)	Water (g)
903	729.17	173.83

Moisture content and unit weight results

Moisture content (%)	Bulk unit weight (pcf)	Dry unit weight (pcf)
23.84	112.0	90.4

Deformation - load and stress - strain results

Deformation (in)	Vertical Strain ϵ	Corrected Area (in ²)	Load (Ib)	Stress (Ib/ft ²)
0	0	6.899	0	0
0.05	0.008	6.955	13.2	270
0.1	0.017	7.018	24.4	500
0.15	0.025	7.076	32.6	660
0.2	0.033	7.134	39.5	800
0.25	0.041	7.194	46.6	930
0.3	0.05	7.262	52	1030
0.35	0.058	7.324	57.3	1130
0.4	0.066	7.387	61.8	1200
0.45	0.075	7.458	66	1270
0.5	0.083	7.523	69.9	1340
0.55	0.091	7.59	72.8	1380
0.6	0.099	7.657	75.9	1430
0.65	0.108	7.734	78	1450
0.7	0.116	7.804	80	1480
0.75	0.124	7.876	81	1480
0.8	0.133	7.957	83.3	1510
0.85	0.141	8.031	83.7	1500
0.9	0.149	8.107	82.9	1470

SB-01-2021 40 to 42 feet

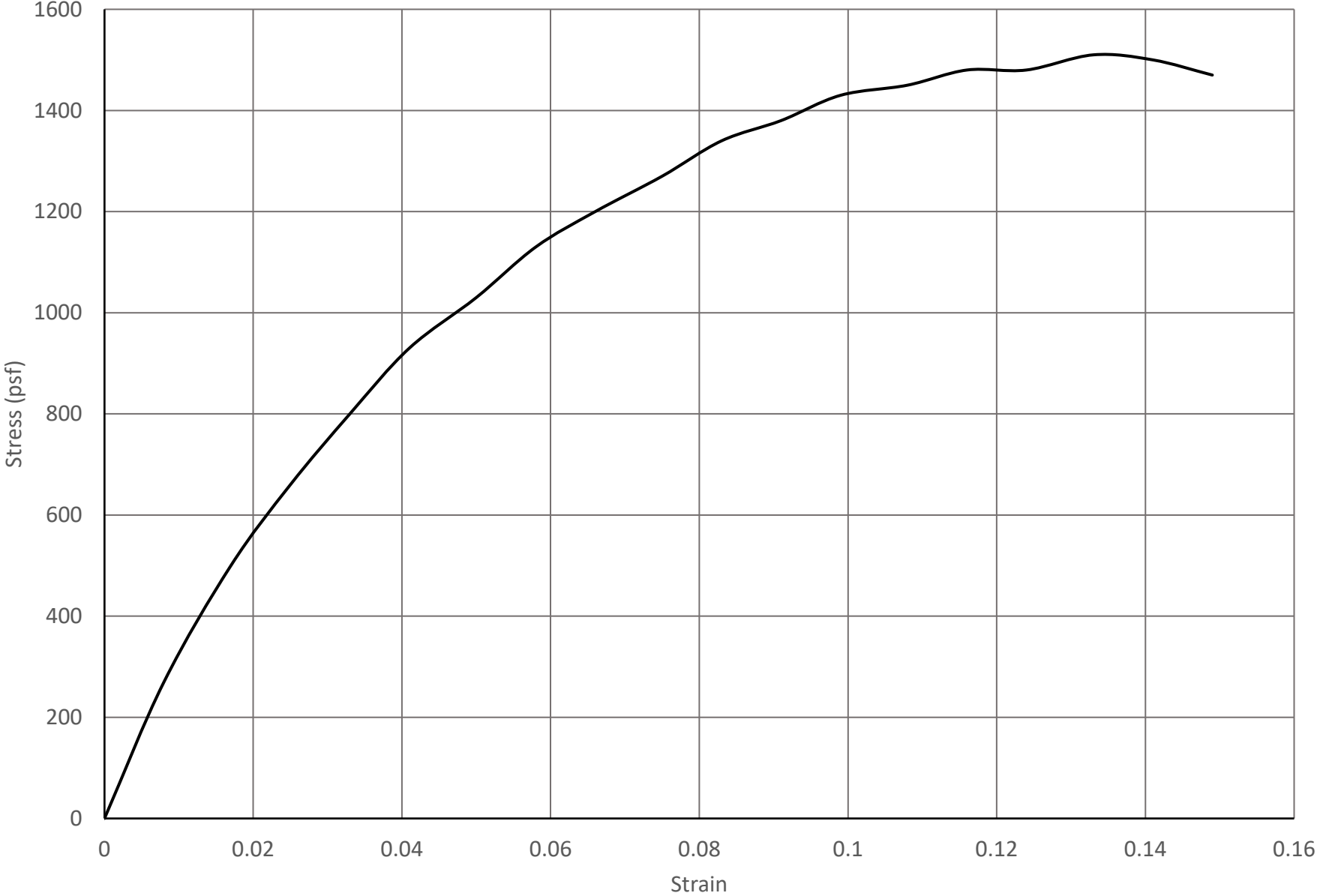

SB-01-2021 56 to 58 feet

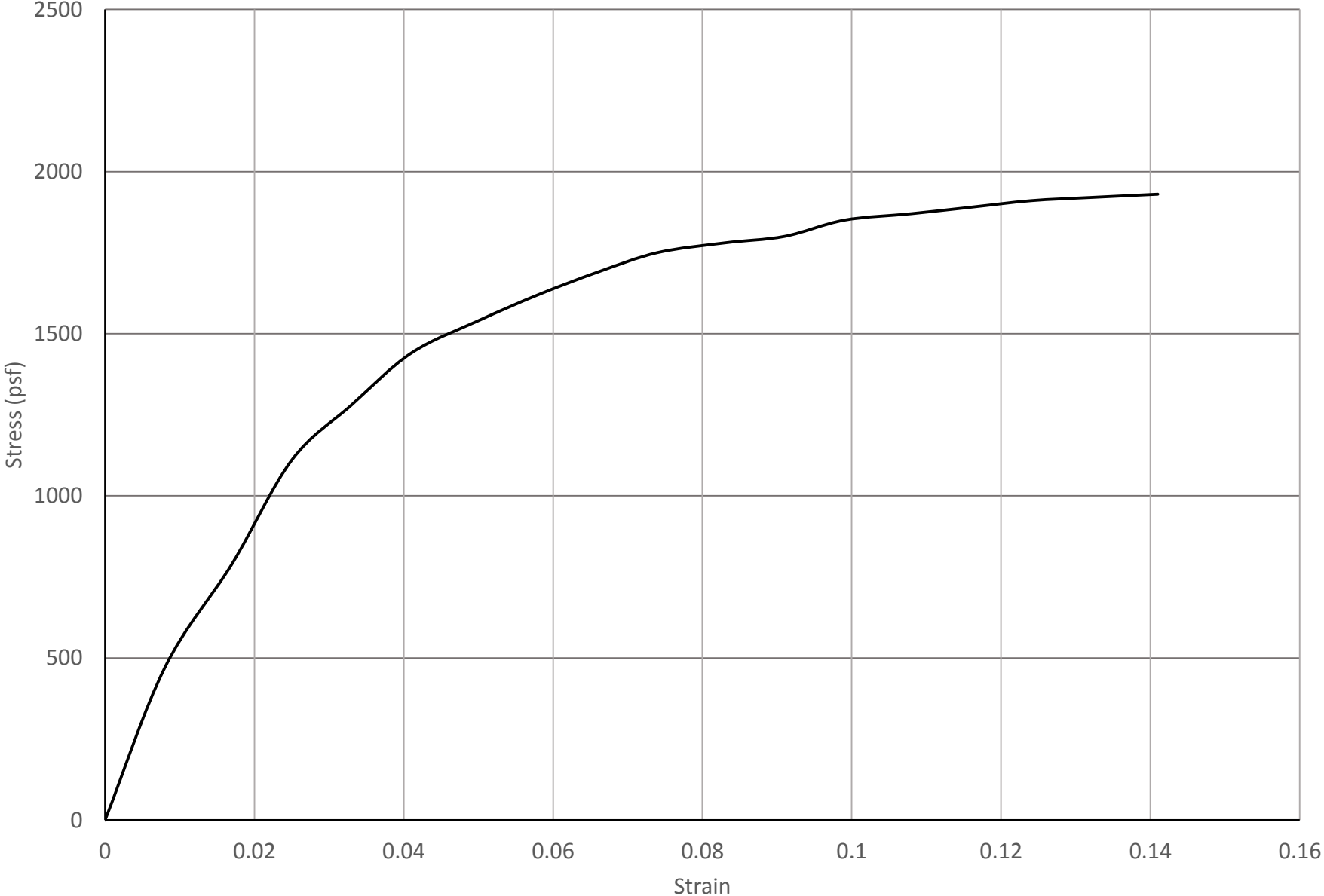

SB-02-2021 14 to 16 feet

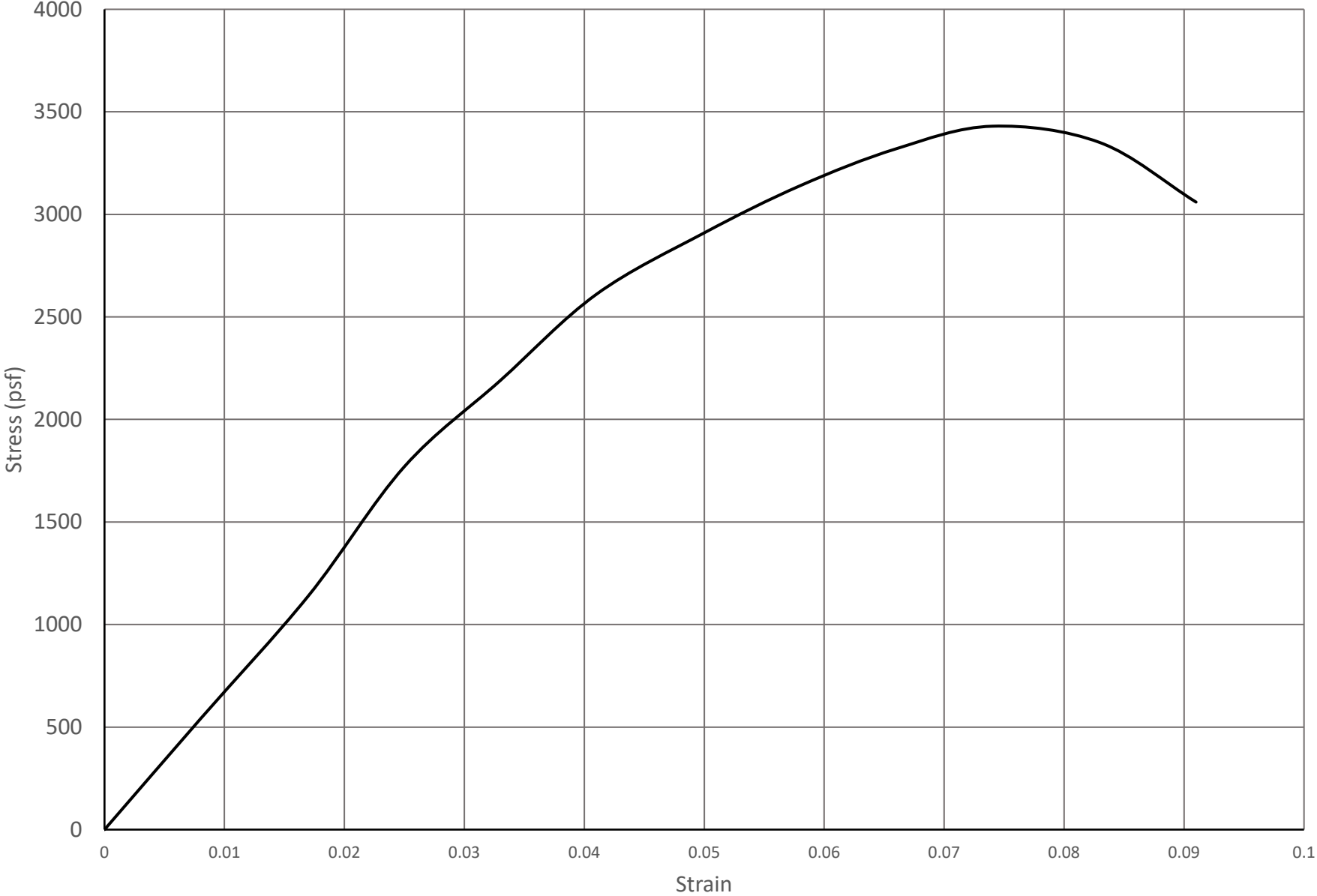

SET Job#: 13562Extrusion LogDate: 12/27/21Project/Client: STCRP

Boring #	Sample#	Depth(ft)	Recovery (in)		Soil Description	
SB-01-21		18-20	BE: 8.5	2" P/D		HAND VANE = 31 KPa
			AE: 8.5	Cl, grayish brown (cl)		
SB-02-21	(Top)	14-16		* 2" Material not saved		HAND VANE = 30 KPa
SB-02-21		56-58	B: 9	1" P/D		HAND VANE = 31.5 KPa
			A: 9	Cl w/ sand & a fr of gravel, grayish brown		
SB-02-21	(Bot)	14-16	B: 9	0.5" P/D		HAND VANE = 46 KPa
			A: 9	Cl, grayish brown (cl)		
SB-01-21		40-42	B: 15.5	0.5" P/D		HAND VANE = 24 KPa
			A: 15.5	Cl w/ sand, brown, soft (cl)		
SB-02-21		46-48	B: 26	0.5" P/D		HV = 22 KPa
			A: 26	Cl w/ sand, brown, soft (cl)		
SB-01-21		14-16	B: 20	2" P/D		HV = 26 KPa
			A: 20	Cl, grayish brown (cl)		
SB-01-21		8-10	B: 24	10" P/D - clay at bottom		HV = 29 KPa - ran on clay
			A: 12	Top: SP-SM w/ a fr of gravel, brown (SP-SM)		
SB-01-21		4-6	B: 16	* All Tossed		
			A: 16	SC w/ a fr of gravel & portions of SM, gray & brown (sc)		

Triaxial U-U Stress/Strain Curves (ASTM:D2850)

Project: STCPP Job: 13562
 Client: Barr Engineering Company Date: 12/31/21
 Remarks: Specimens trimmed to given sizes; Allowed to adjust under applied confining pressures for about 10 minutes.

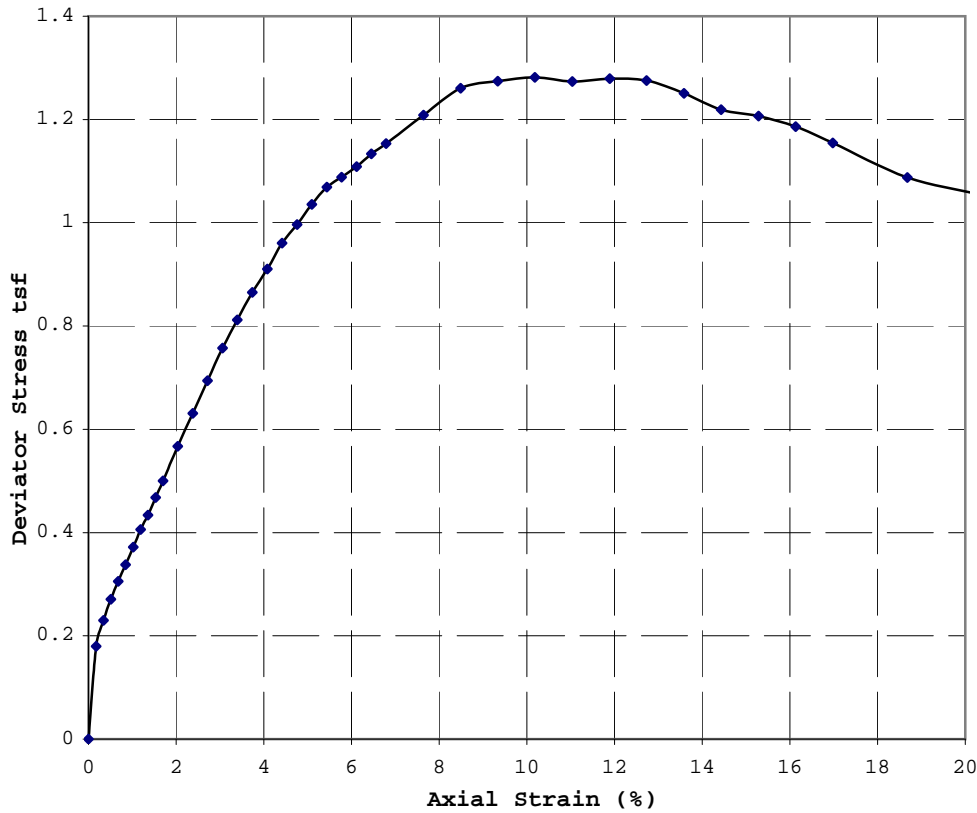

Boring: SB-01-21 Depth: 14-16
 Sample #: _____
 Soil Type: Lean Clay (CL)
 Strain Rate (in/min): 0.060
 Sample Type: 3T
 Dia. (in) 2.87 Ht. (in) 5.89
 Height to Diameter Ratio: 2.05
Max Deviator Stress: 1.28 tsf
Strain at Failure (%): 10.2
 Confining Pressure: 0.6 tsf

W.C. (%): 30.3
 Yd (pcf): 93.2

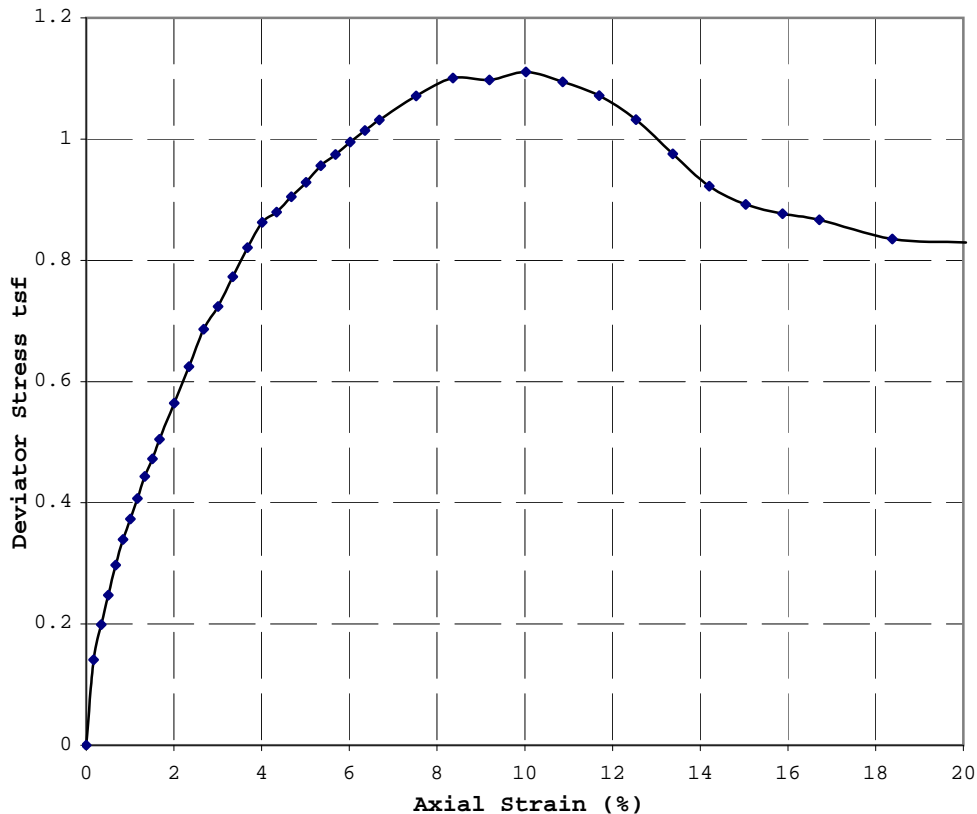
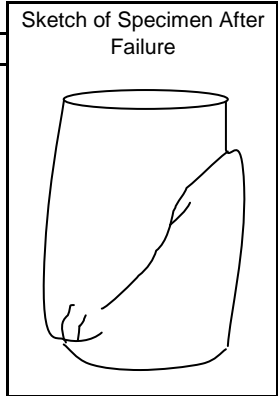

Boring: SB-01-21 Depth: 18-20
 Sample #: _____
 Soil Type: Lean Clay (CL)
 Strain Rate (in/min): 0.060
 Sample Type: 3T
 Dia. (in) 2.84 Ht. (in) 5.99
 Height to Diameter Ratio: 2.11
Max Deviator Stress: 1.11 tsf
Strain at Failure (%): 10.0
 Confining Pressure: 0.7 tsf

W.C. (%): 29.3
 Yd (pcf): 94.4

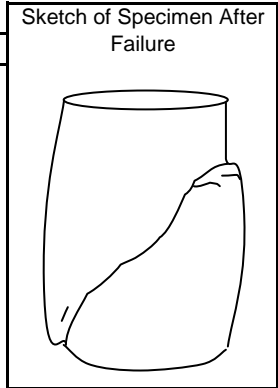

Triaxial U-U Stress/Strain Curves (ASTM:D2850)

Project: STCPP Job: 13562
 Client: Barr Engineering Company Date: 12/31/21
 Remarks: Specimens trimmed to given sizes; Allowed to adjust under applied confining pressures for about 10 minutes.

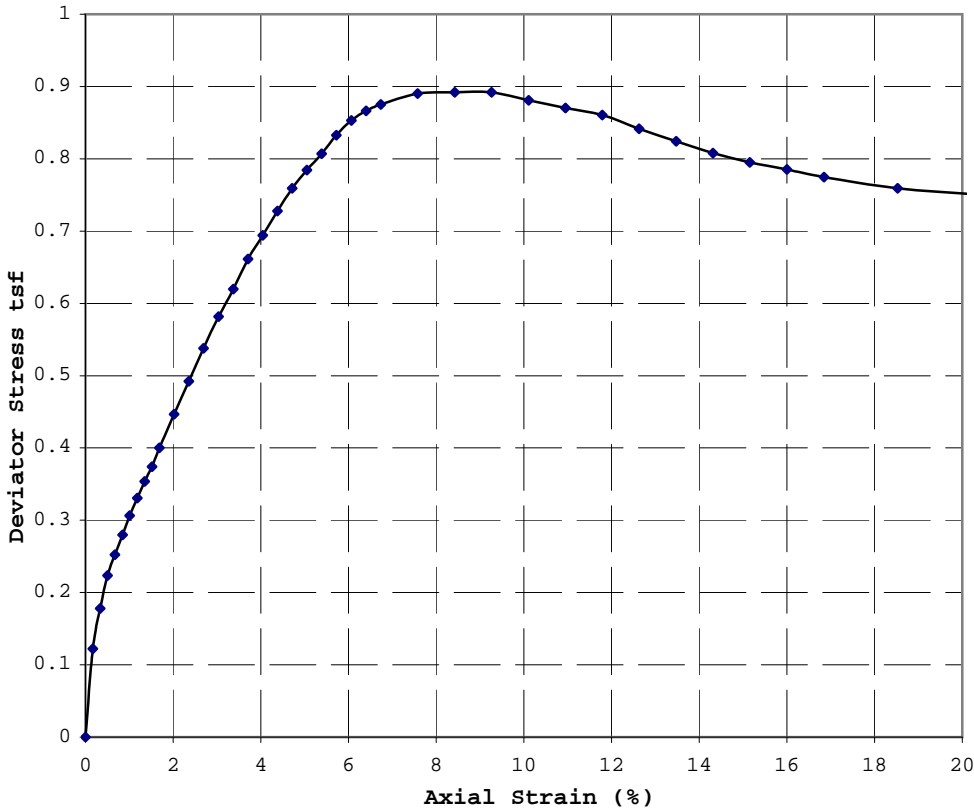

Boring: SB-02-21 Depth: 14-16
 Sample #: _____ Bottom
 Soil Type: Lean Clay (CL)
 Strain Rate (in/min): 0.060
 Sample Type: 3T
 Dia. (in): 2.85 Ht. (in): 5.94
 Height to Diameter Ratio: 2.08
Max Deviator Stress: 0.89 tsf
Strain at Failure (%): 9.3
 Confining Pressure: 0.6 tsf

W.C. (%): 28.6
 Yd (pcf): 95.3

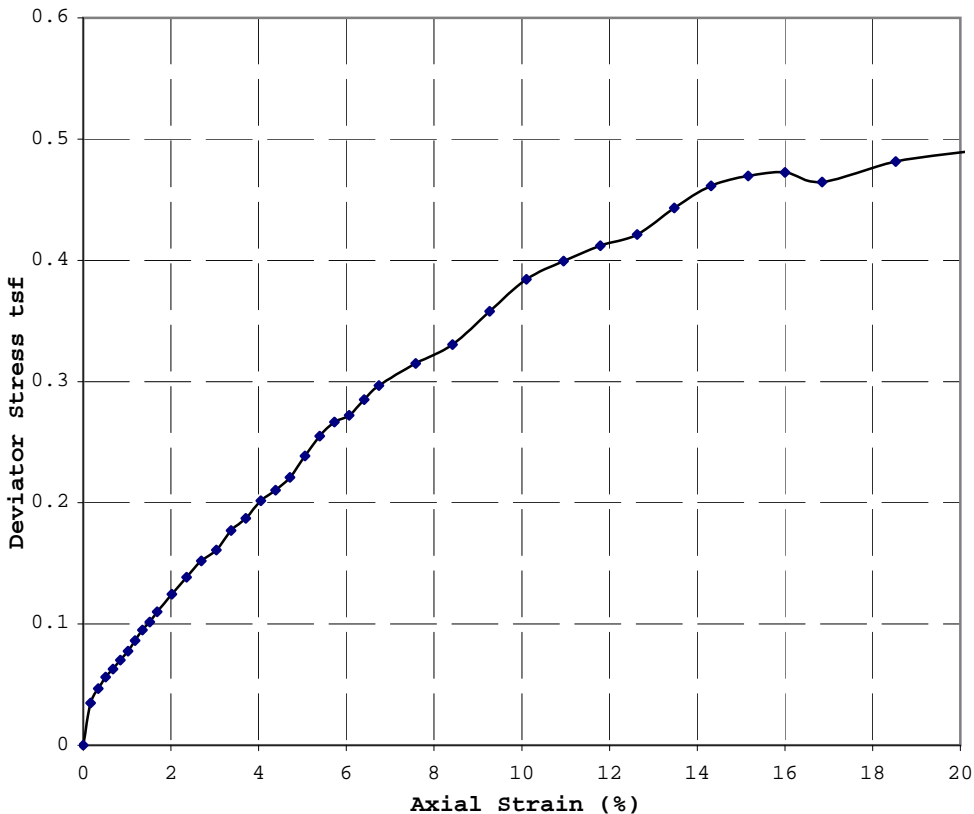
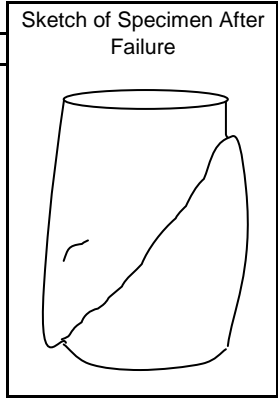

Boring: SB-02-21 Depth: 46-48
 Sample #: _____
 Soil Type: Lean Clay w/sand (CL)
 Strain Rate (in/min): 0.060
 Sample Type: 3T
 Dia. (in): 2.87 Ht. (in): 5.94
 Height to Diameter Ratio: 2.07
Max Deviator Stress: 0.49 tsf
Strain at Failure (%): 20.0
 Confining Pressure: 1.4 tsf

W.C. (%): 25.0
 Yd (pcf): 99.6

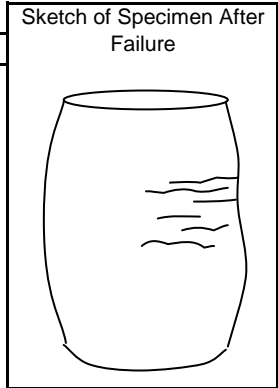

Summary of Native Clay Laboratory Shear Strength Data

DTE STCPP - BAB Closure Plan

Boring	Thin Wall Sample Depth	USCS	Unconfined S _u (TEC)	Lab Vane S _u (SET)	Lab Vane S _u (SET)	UU S _u (SET)	UU Test Pressure	Comment
	feet		psf	kPa	psf	psf	psi	
SB-01-21	8 to 10	CL	--	29	606	--	--	tube had just a couple inches of clay in the bottom, rest of tube was SP-SM to SM
SB-01-21	14 to 16	CL		26	543	1,280	0.6	
SB-01-21	18 to 20	CL	760	31	647	1,110	0.7	
SB-01-21	40 to 42	CL	755	24	501	--	--	tube was dropped from about 2 feet, but the sample looked fine
SB-02-21	14 to 16 (top of tube)	CL	1,725	30	627	--	--	
SB-02-21	14 to 16 (bottom of tube)	CL		46	961	890	0.6	
SB-02-21	46 to 48	CL		22	459	490	1.4	
SB-02-21	56 to 58	CL	965	32	658	--	--	

Native Clay Laboratory Strength Comparison

DTE STCPP BAB Closure Plan

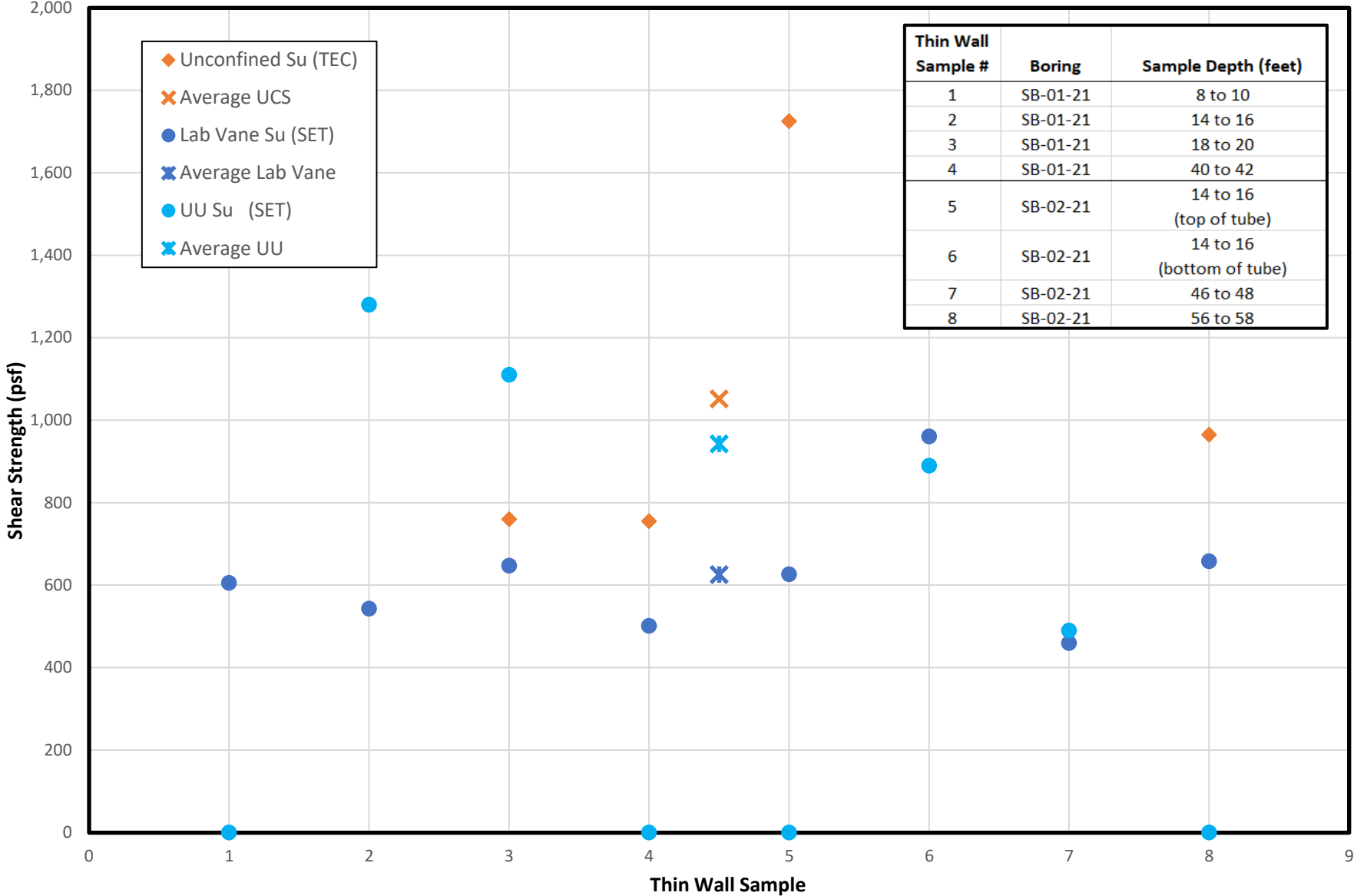

Native Clay Atterberg Limits DTE STCPP BAB Closure

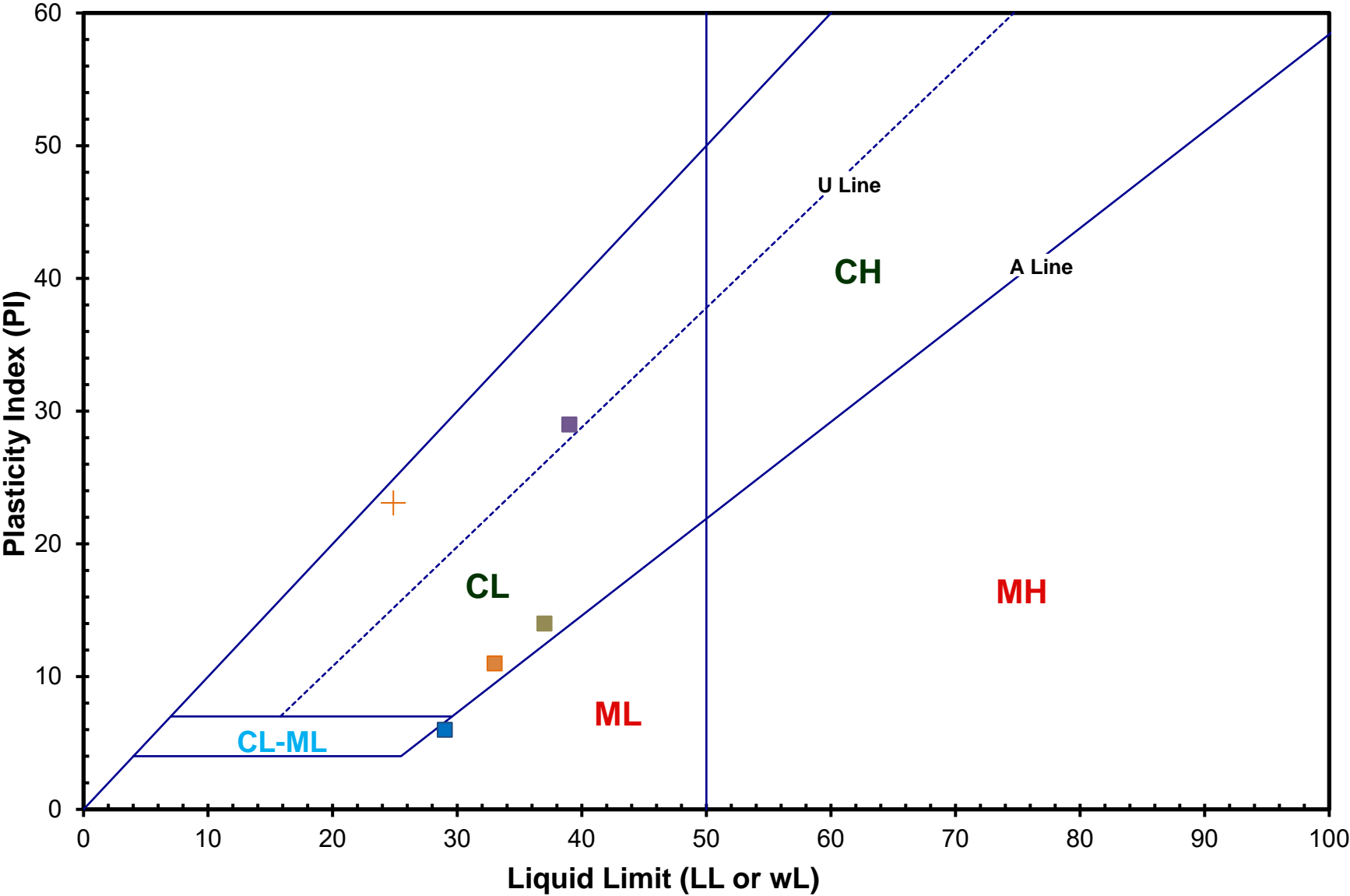

Attachment 6

BAB Profiles and Cross-Sections

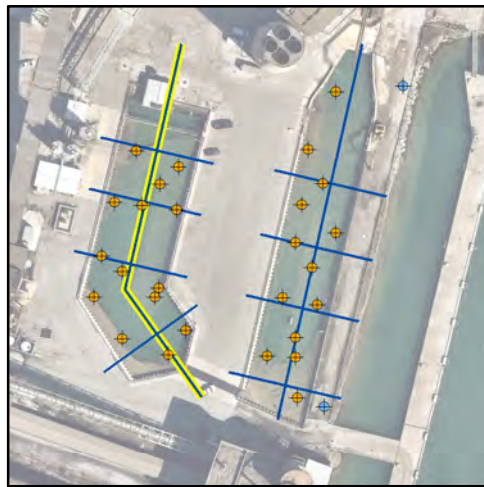
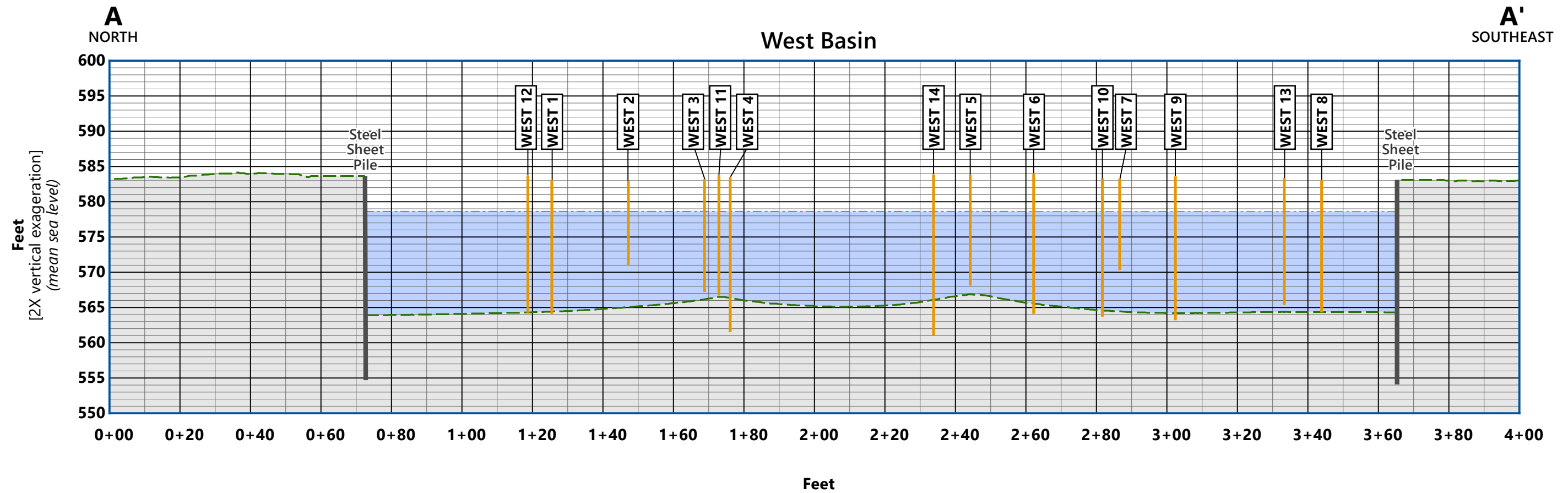

NOTES:

Topographic information depicted based on NOAA DigitalCoast LiDAR data and depth to water & native clay measurements collected during 2021 vibracore boring.

Ash is present subaqueously in the basin, but depth of ash varied and varies over time and is not show.

For Bottom Ash Basin Sheet Pile Information See Bottom Ash Basin Closure Existing Conditions Plan – Drawing 0516-C-3046 and Associated Bottom Ash Basin Closure Drawings

CROSS SECTION A-A'
WEST BASIN
St. Clair Power Plant
DTE Energy
4901 Pointe Drive
China Township, Michigan

FIGURE 6-1

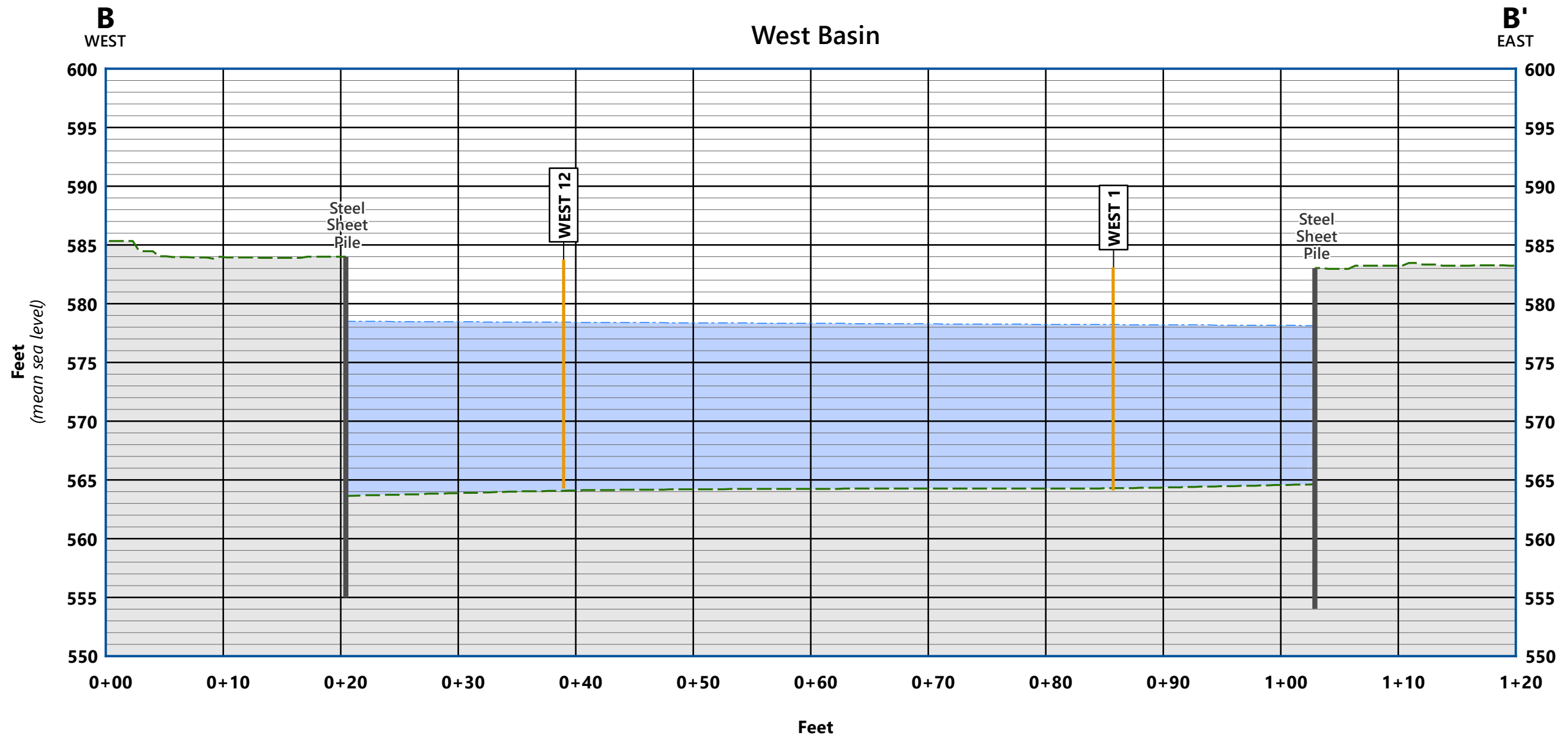

Barr Footer: ArcGIS 10.8.1, 2021-11-05 16:06 File: I:\Projects\22\4\1069\Maps\Reports\Figure2_2_STCPP_CrossSection_B.mxd User: MAC2

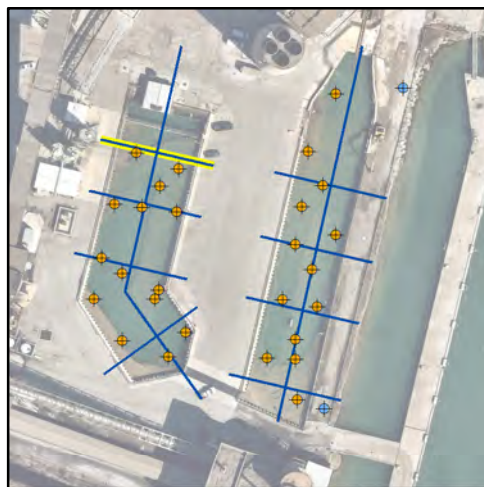

NOTES:

Topographic information depicted based on NOAA DigitalCoast LiDAR data and depth to water & native clay measurements collected during 2021 vibracore boring.

Ash is present subaqueously in the basin, but depth of ash varied and varies over time and is not show.

For Bottom Ash Basin Sheet Pile Information See Bottom Ash Basin Closure Existing Conditions Plan – Drawing 0516-C-3046 and Associated Bottom Ash Basin Closure Drawings

CROSS SECTION B-B'
 WEST BASIN
 St. Clair Power Plant
 DTE Energy
 4901 Pointe Drive
 China Township, Michigan

FIGURE 6-2

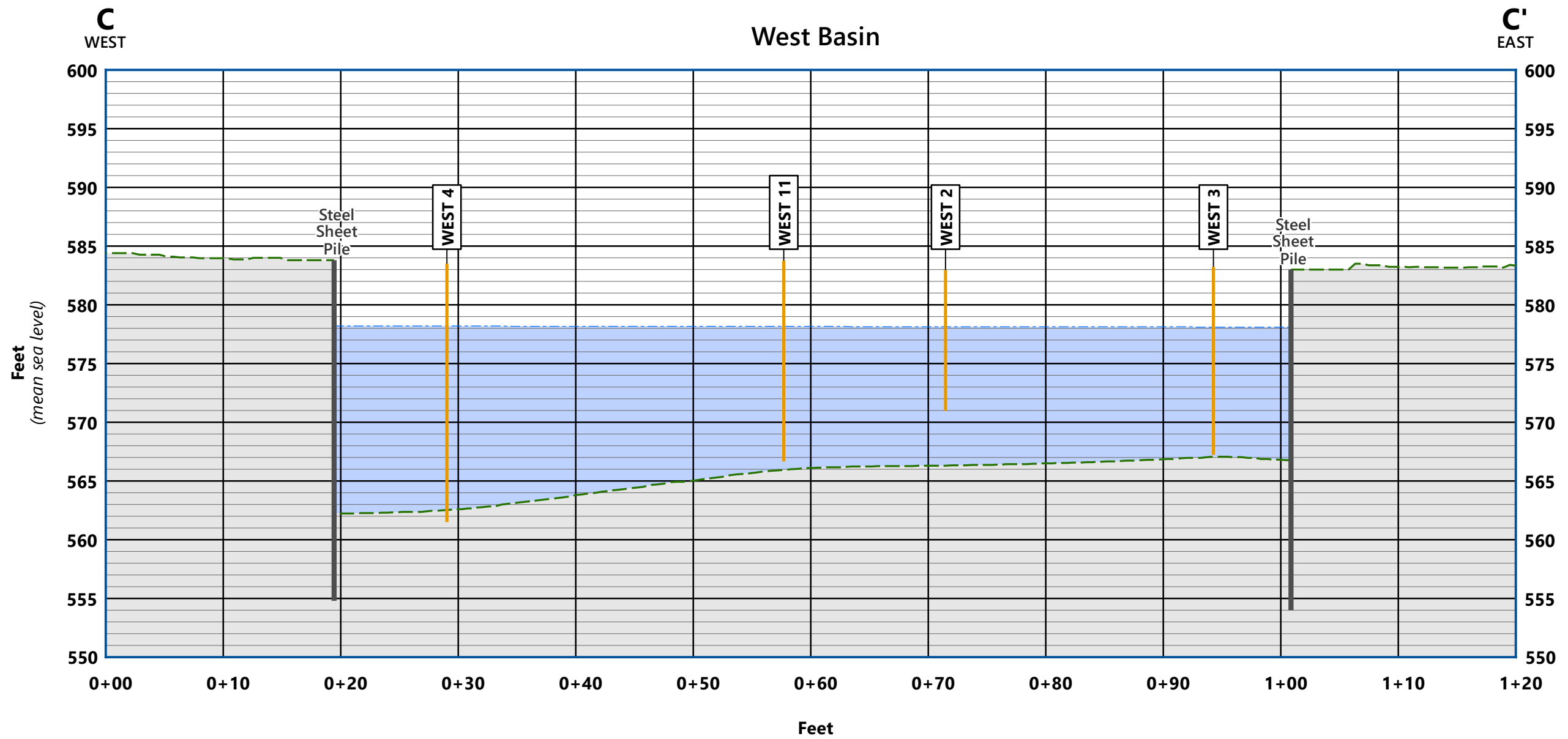

Barr Footer: ArcGIS 10.8.1, 2021-11-07 11:16 File: \\Projects\22\4\1069\Maps\Reports\Figure2_3_STCPP_CrossSection_C.mxd User: MAC2



NOTES:

Topographic information depicted based on NOAA DigitalCoast LiDAR data and depth to water & native clay measurements collected during 2021 vibracore boring.

Ash is present subaqueously in the basin, but depth of ash varied and varies over time and is not show.

For Bottom Ash Basin Sheet Pile Information See Bottom Ash Basin Closure Existing Conditions Plan – Drawing 0516-C-3046 and Associated Bottom Ash Basin Closure Drawings

CROSS SECTION C-C'
WEST BASIN
 St. Clair Power Plant
 DTE Energy
 4901 Pointe Drive
 China Township, Michigan

FIGURE 6-3

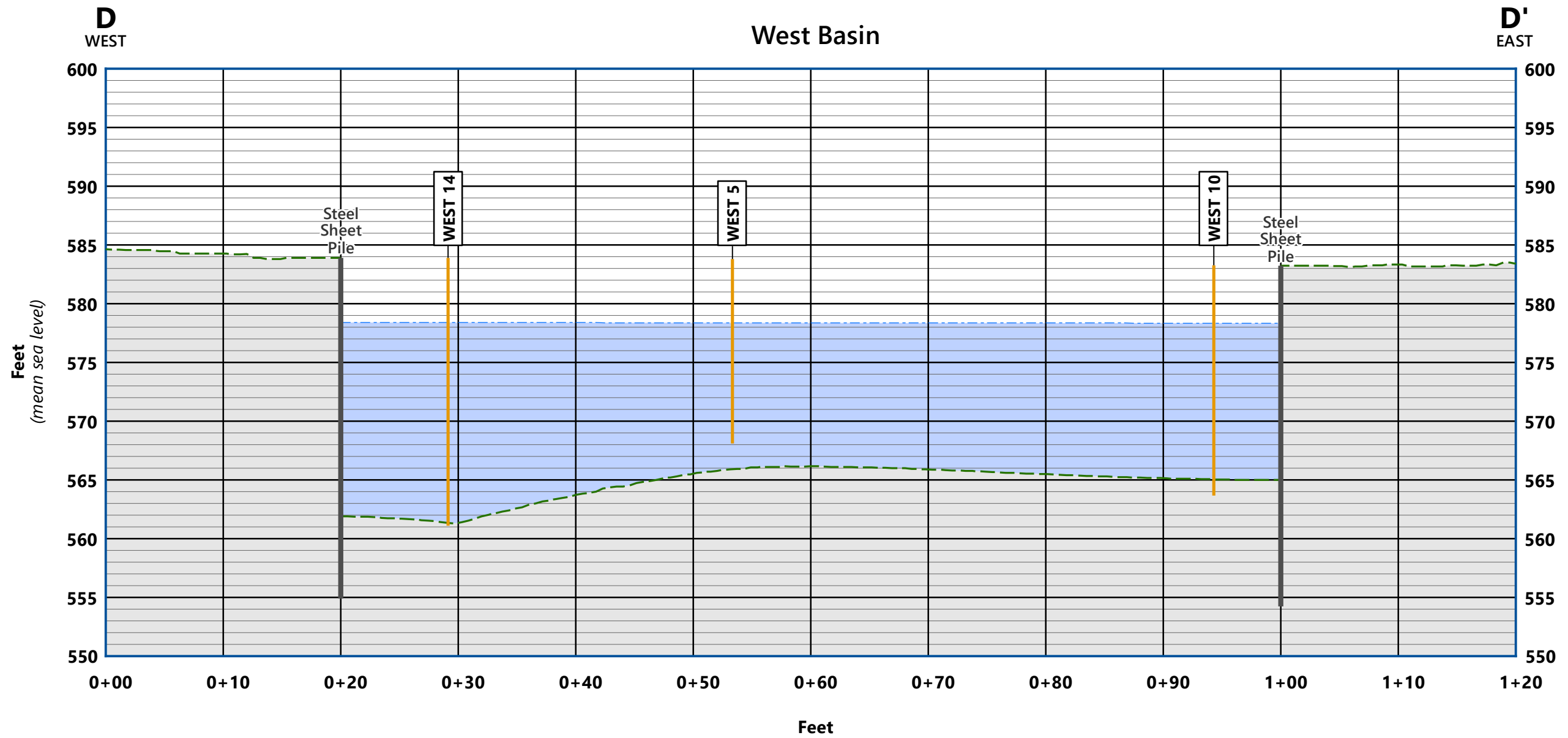

Barr Footer: ArcGIS 10.8.1, 2021-11-07 12:11 File: I:\Projects\22\4\1069\Maps\Reports\Figure2_4_STCPP_CrossSection_D.mxd User: MAC2



NOTES:

Topographic information depicted based on NOAA DigitalCoast LiDAR data and depth to water & native clay measurements collected during 2021 vibracore boring.

Ash is present subaqueously in the basin, but depth of ash varied and varies over time and is not show.

For Bottom Ash Basin Sheet Pile Information See Bottom Ash Basin Closure Existing Conditions Plan – Drawing 0516-C-3046 and Associated Bottom Ash Basin Closure Drawings

CROSS SECTION D-D'
WEST BASIN
St. Clair Power Plant
DTE Energy
4901 Pointe Drive
China Township, Michigan

FIGURE 6-4

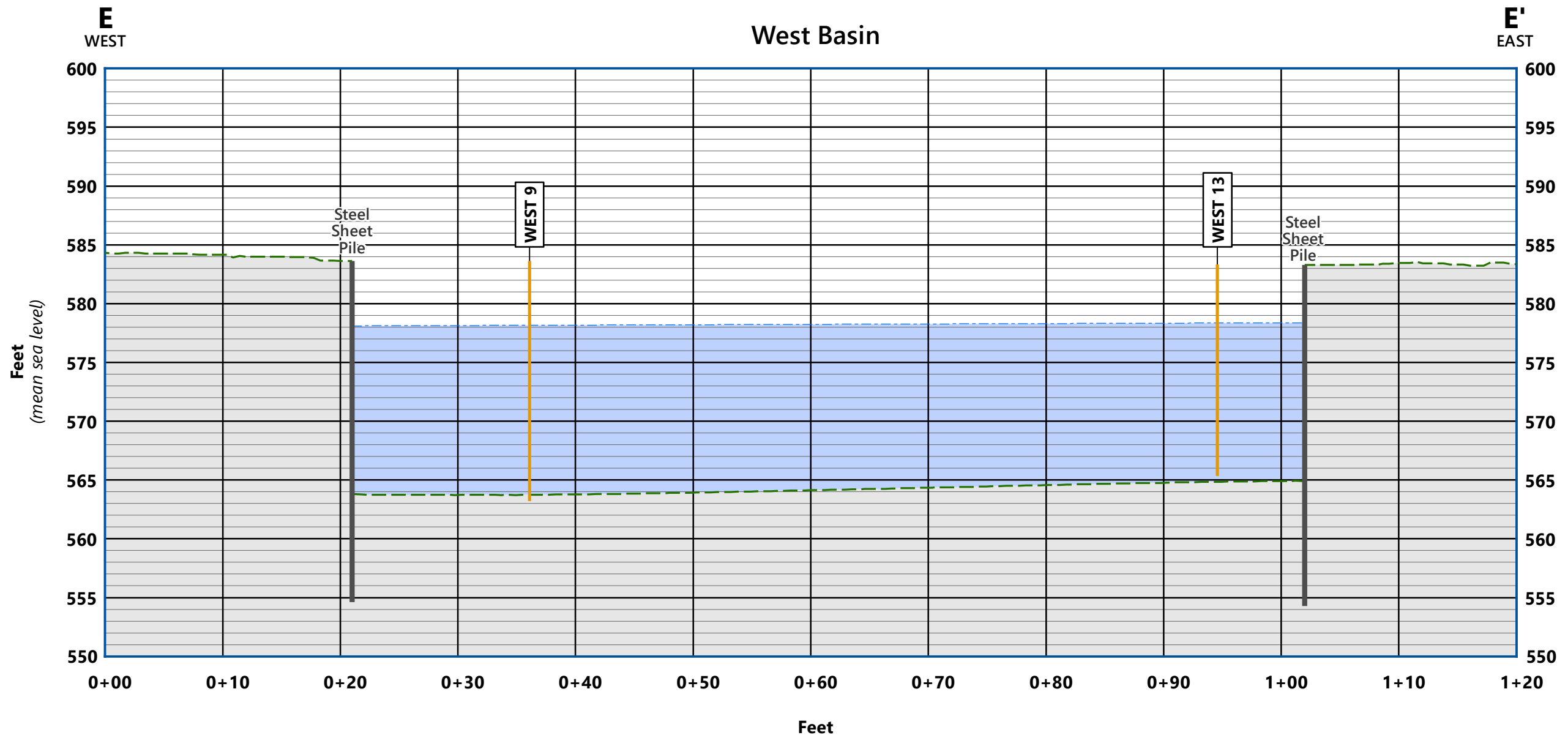

Barr Footer: ArcGIS 10.8.1, 2021-11-07 12:15 File: \\Projects\22\4\1069\Maps\Reports\Figure2_5_STCPP_CrossSection_E.mxd User: MAC2

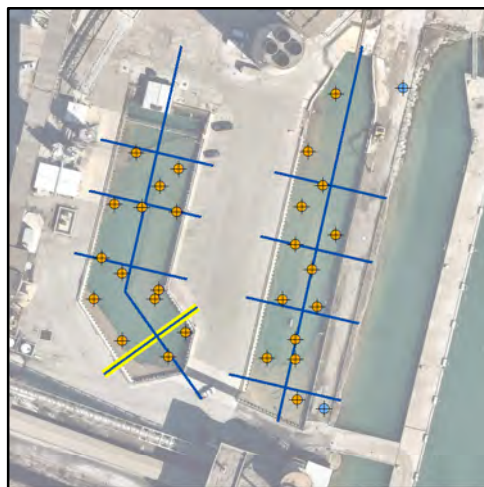

NOTES:

Topographic information depicted based on NOAA DigitalCoast LiDAR data and depth to water & native clay measurements collected during 2021 vibracore boring.

Ash is present subaqueously in the basin, but depth of ash varied and varies over time and is not show.

For Bottom Ash Basin Sheet Pile Information See Bottom Ash Basin Closure Existing Conditions Plan – Drawing 0516-C-3046 and Associated Bottom Ash Basin Closure Drawings

CROSS SECTION E-E'
 WEST BASIN
 St. Clair Power Plant
 DTE Energy
 4901 Pointe Drive
 China Township, Michigan
FIGURE 6-5

Barr Footer: ArcGIS 10.8.1, 2021-12-17 18:17 File: I:\Projects\22\4\1069\Maps\Reports\Figure2_1_STCPP_CrossSection_A.mxd User: MAC2

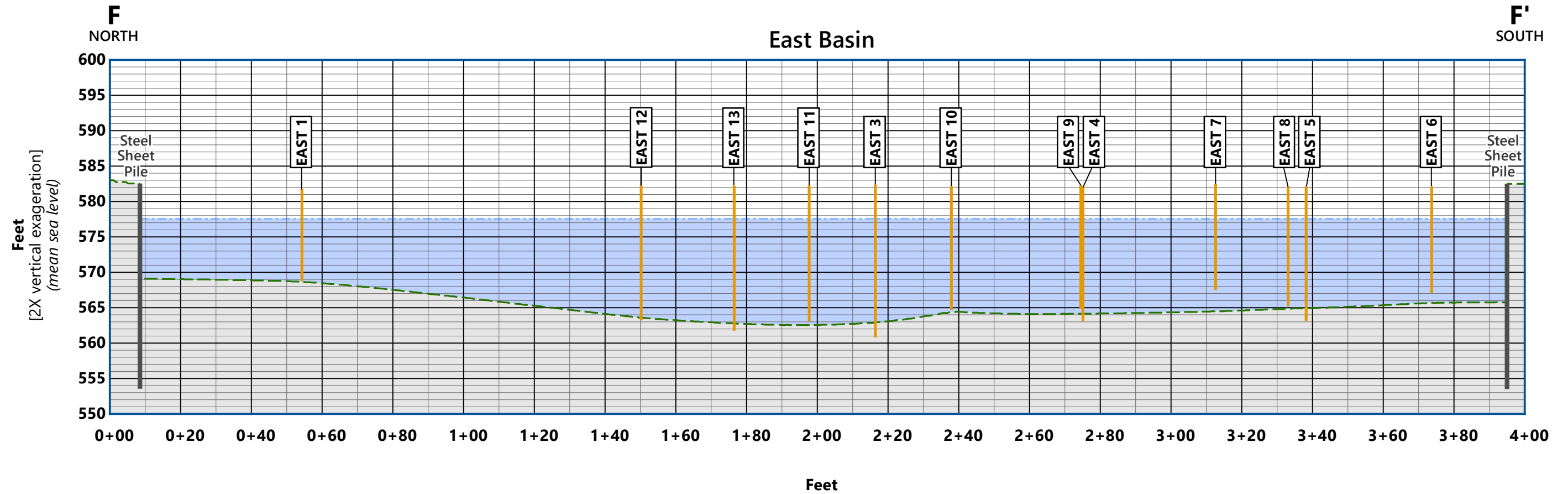

NOTES:

Topographic information depicted based on NOAA DigitalCoast LiDAR data and depth to water & native clay measurements collected during 2021 vibracore boring.

Ash is present subaqueously in the basin, but depth of ash varied and varies over time and is not show.

For Bottom Ash Basin Sheet Pile Information See Bottom Ash Basin Closure Existing Conditions Plan – Drawing 0516-C-3046 and Associated Bottom Ash Basin Closure Drawings

CROSS SECTION A-A'
 WEST BASIN
 St. Clair Power Plant
 DTE Energy
 4901 Pointe Drive
 China Township, Michigan

FIGURE 6-6

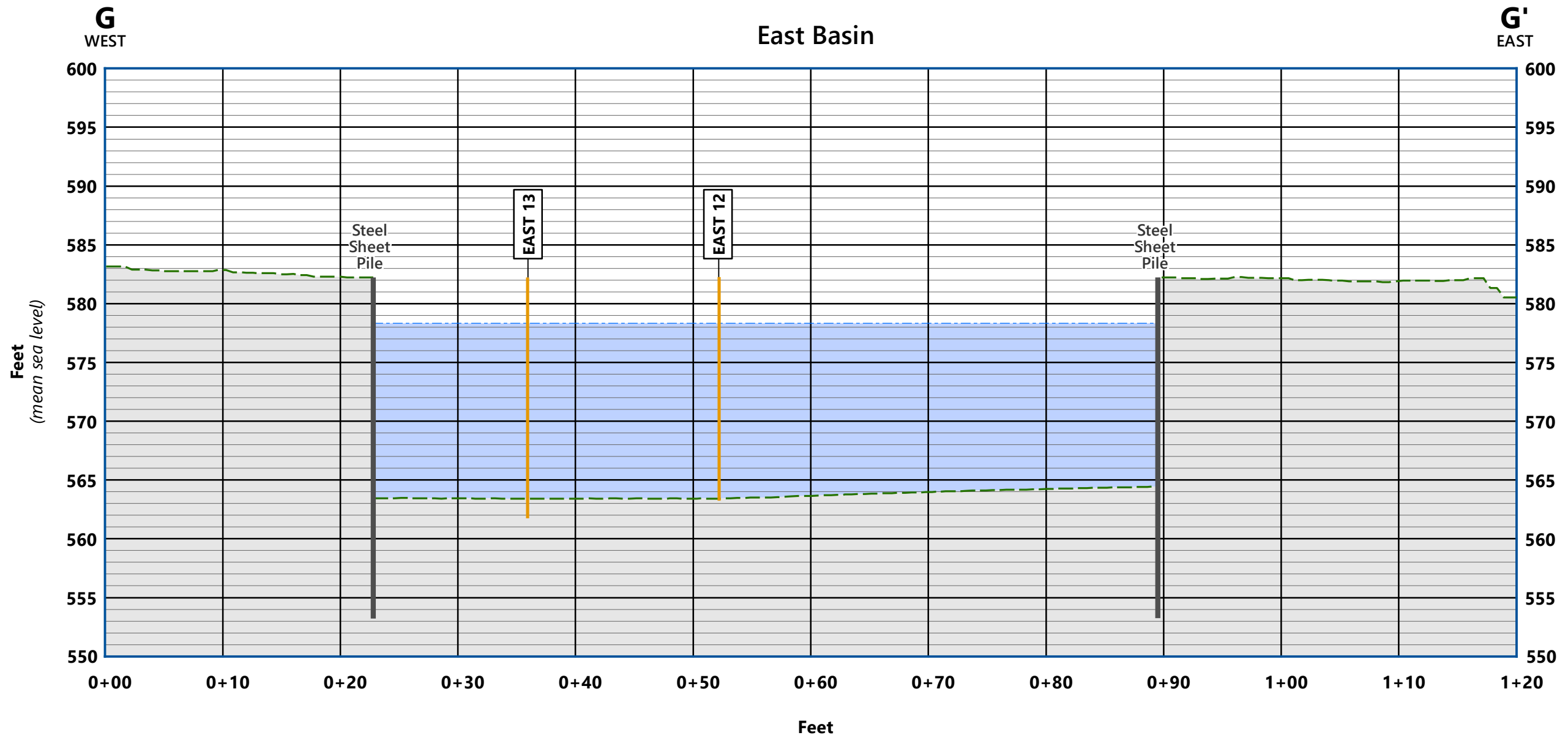

Barr Footer: ArcGIS 10.8.1, 2021-11-09 15:43 File: I:\Projects\22\41069\Maps\Reports\Figure2_7_STCPP_CrossSection_G.mxd User: MAC2



NOTES:

Topographic information depicted based on NOAA DigitalCoast LiDAR data and depth to water & native clay measurements collected during 2021 vibracore boring.

Ash is present subaqueously in the basin, but depth of ash varied and varies over time and is not show.

For Bottom Ash Basin Sheet Pile Information See Bottom Ash Basin Closure Existing Conditions Plan – Drawing 0516-C-3046 and Associated Bottom Ash Basin Closure Drawings

CROSS SECTION G-G'
EAST BASIN
 St. Clair Power Plant
 DTE Energy
 4901 Pointe Drive
 China Township, Michigan

FIGURE 6-7

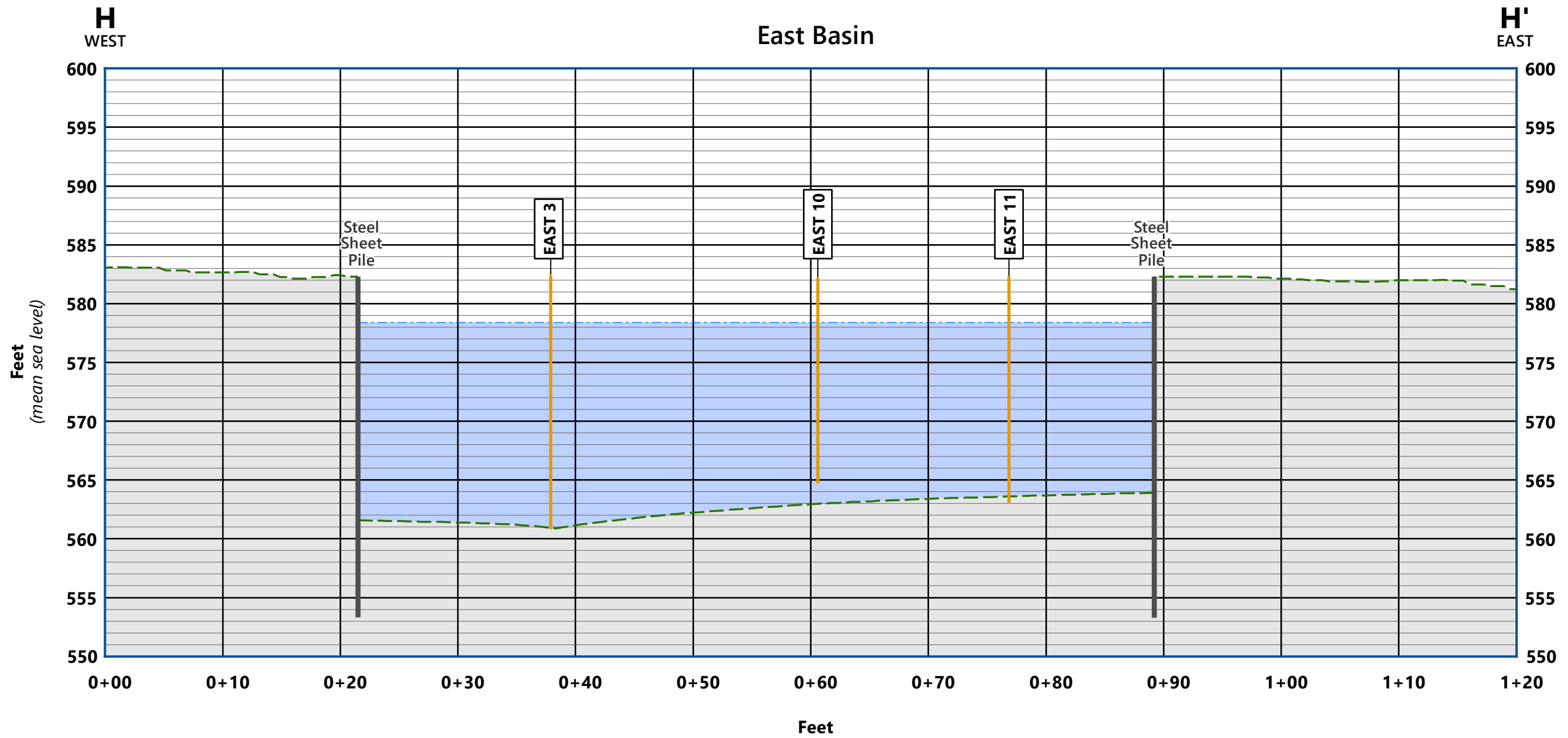

Barr Footer: ArcGIS 10.8.1, 2021-11-09 16:52 File: \\Projects\22\4\1069\Maps\Reports\Figure2_8_STCPP_CrossSection_H.mxd User: MAC2



NOTES:

Topographic information depicted based on NOAA DigitalCoast LiDAR data and depth to water & native clay measurements collected during 2021 vibracore boring.

Ash is present subaqueously in the basin, but depth of ash varied and varies over time and is not show.

For Bottom Ash Basin Sheet Pile Information See Bottom Ash Basin Closure Existing Conditions Plan – Drawing 0516-C-3046 and Associated Bottom Ash Basin Closure Drawings

CROSS SECTION H-H'
EAST BASIN
 St. Clair Power Plant
 DTE Energy
 4901 Pointe Drive
 China Township, Michigan
FIGURE 6-8

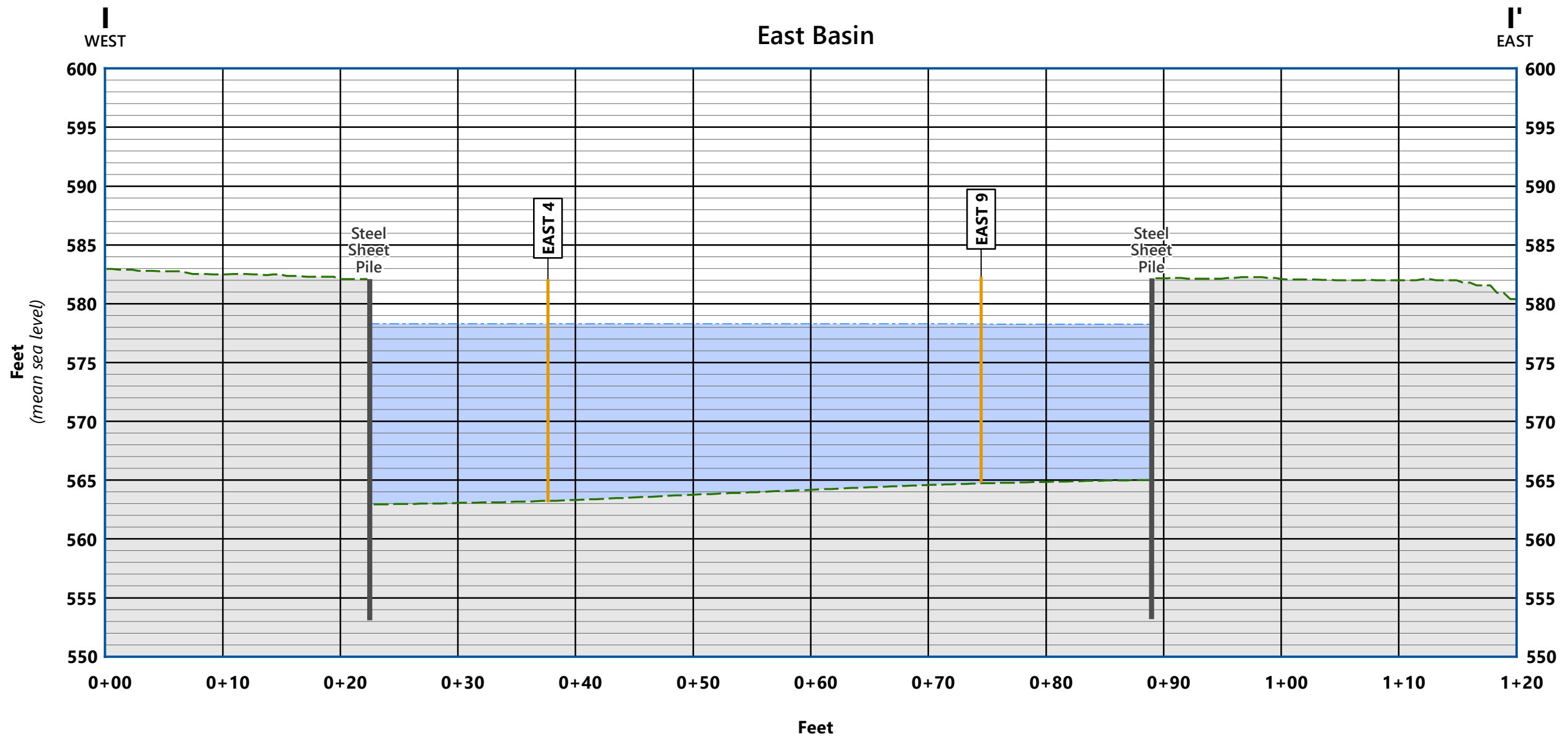

Barr Footer: ArcGIS 10.8.1, 2021-11-10 13:45 File: \\Projects\22\4\1069\Maps\Reports\Figure2_9_STCPP_CrossSection_I.mxd User: MACZ

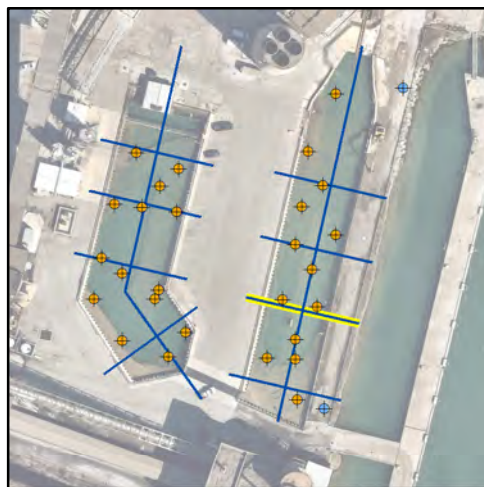

NOTES:

Topographic information depicted based on NOAA DigitalCoast LiDAR data and depth to water & native clay measurements collected during 2021 vibracore boring.

Ash is present subaqueously in the basin, but depth of ash varied and varies over time and is not show.

For Bottom Ash Basin Sheet Pile Information See Bottom Ash Basin Closure Existing Conditions Plan – Drawing 0516-C-3046 and Associated Bottom Ash Basin Closure Drawings

CROSS SECTION I-I'
EAST BASIN
St. Clair Power Plant
DTE Energy
4901 Pointe Drive
China Township, Michigan

FIGURE 6-9

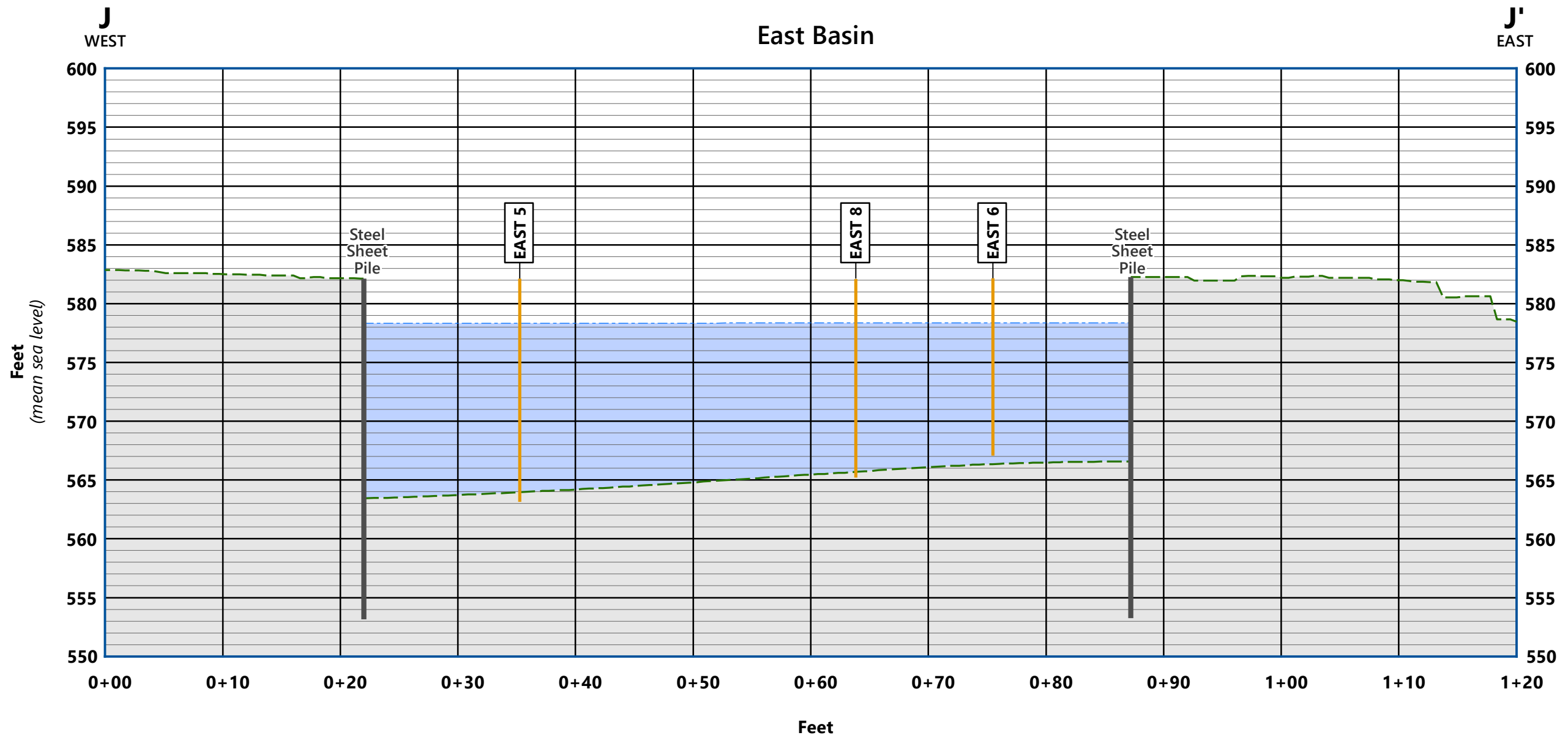

Barr Footer: ArcGIS 10.8.1, 2021-11-10 13:54 File: \\Projects\22\4\1069\Maps\Reports\Figure2_10_STCPP_CrossSection_J.mxd User: MAC2



NOTES:

Topographic information depicted based on NOAA DigitalCoast LiDAR data and depth to water & native clay measurements collected during 2021 vibracore boring.

Ash is present subaqueously in the basin, but depth of ash varied and varies over time and is not show.

For Bottom Ash Basin Sheet Pile Information See Bottom Ash Basin Closure Existing Conditions Plan – Drawing 0516-C-3046 and Associated Bottom Ash Basin Closure Drawings

CROSS SECTION J-J'
EAST BASIN
 St. Clair Power Plant
 DTE Energy
 4901 Pointe Drive
 China Township, Michigan

FIGURE 6-10

Technical Memorandum

To: DTE STCPP BAB Closure Team
From: Barr Engineering
Subject: Addendum No. 1 – Additional geotechnical laboratory testing
Date: February 18, 2022
Project: DTE STCPP BAB Closure

This Addendum provides additional geotechnical laboratory testing, collected in January 2022, to supplement the data provided in Attachment B of the Erection Specifications for the DTE STCPP BAB Closure project. The data includes:

- Permeability testing on clay
- Proctors on ash
- Summary tables from the laboratory on ash and clay testing
- UCS testing on clay

Triaxial Permeability

Specimen mass and geometry

Mass (g)	Diameter (cm)	Length (cm)	Area (cm ²)	Volume (cm ³)
967.7	7.25	12.0	41.28	495.4

Initial water content data

Container	Mass of wet soil & container (g)	Mass of dry soil & container (g)	Mass of container (g)
26	111.3	90.4	26.6

Initial water content and density values

Water content (%)	Bulk density (g/cm ³)	Dry density (g/cm ³)
32.76	1.953	1.471

Final water content data and value

Container	Mass of wet soil & container (g)	Mass of dry soil & container (g)	Mass of container (g)	Water content (%)
26	111.3	90.4	26.6	32.76

Triaxial Permeability

Equipment constants

Burette	Elevation at top (cm)	Volume (cm ³)	Length (cm)	Area (cm ²)
Bottom	71.8	50	49.5	1.01
Top	72.0	50	49.5	1.01

Pressures for test

Item	Pressure (psi)	Pressure (Pa)	Water head (m)
Cell	25.94	178.84	18.230
Bottom	24.05	165.81	16.902
Top	21.45	147.88	15.075

Triaxial Permeability

Test values for Test 1

Time	Volume in bottom burette (cm ³)	Volume in top burette (cm ³)	Elevation at bottom burette (cm)	Elevation at top burette (cm)	Head in bottom burette (cm)	Head in top burette (cm)	Head difference (cm)
Start	10.0	34.8	61.9	37.5	1727.728	1542.257	185.470
End	13.6	31.5	58.3	40.8	1730.995	1538.957	192.037
	-3.6	3.3					

Permeability values for Test 1

Burette area (cm ²)	Specimen length (cm)	Specimen area (cm ²)	Duration of test (sec)	Initial head (cm)	Final head (cm)	Coefficient of permeability (cm/sec)
1.01	12.0	41.28	25200	185.470	192.037	4.05E-07

Triaxial Permeability

Test values for Test 2

Time	Volume in bottom burette (cm ³)	Volume in top burette (cm ³)	Elevation at bottom burette (cm)	Elevation at top burette (cm)	Head in bottom burette (cm)	Head in top burette (cm)	Head difference (cm)
Start	13.6	31.5	58.3	40.8	1730.995	1538.957	192.037
End	21.0 -7.4	24.3 7.2	51.0	47.9	1738.123	1531.757	206.365

Permeability values for Test 2

Burette area (cm ²)	Specimen length (cm)	Specimen area (cm ²)	Duration of test (sec)	Initial head (cm)	Final head (cm)	Coefficient of permeability (cm/sec)
1.01	12.0	41.28	61200	192.037	206.365	3.45E-07

Triaxial Permeability

Test values for Test 3

Time	Volume in bottom burette (cm ³)	Volume in top burette (cm ³)	Elevation at bottom burette (cm)	Elevation at top burette (cm)	Head in bottom burette (cm)	Head in top burette (cm)	Head difference (cm)
Start	21.0	24.3	51.0	47.9	1738.123	1531.757	206.365
End	23.7 -2.7	21.5 2.8	48.3	50.7	1740.895	1528.957	211.937

Permeability values for Test 3

Burette area (cm ²)	Specimen length (cm)	Specimen area (cm ²)	Duration of test (sec)	Initial head (cm)	Final head (cm)	Coefficient of permeability (cm/sec)
1.01	12.0	41.28	25200	206.365	211.937	3.10E-07



Testing Engineers and Consultants, Inc.

1343 Rochester Road PO Box 249 Troy, Michigan 48099-0249
248-588-6200 or 313 T-E-S-T-I-N-G
Fax 248-588-6232

SOIL COMPACTION TEST GRAPH

PROJECT: DTE Ash Pond

TEC REPORT NUMBER: 62199

LOCATION:

REPORT DATE: 12/17/21

CLIENT: DTE

TEST METHOD: ASTM D1557

SOURCE TEST: #1

Material Description: EAST Basin 1A+1

Sample Date: 07/01/21

Sample Source:

Sampled By: TEC

Sample Location:

Maximum Density: 77.9 pcf

Intended Use:

Optimum Moisture: 34.9 %

EAST 1+1A

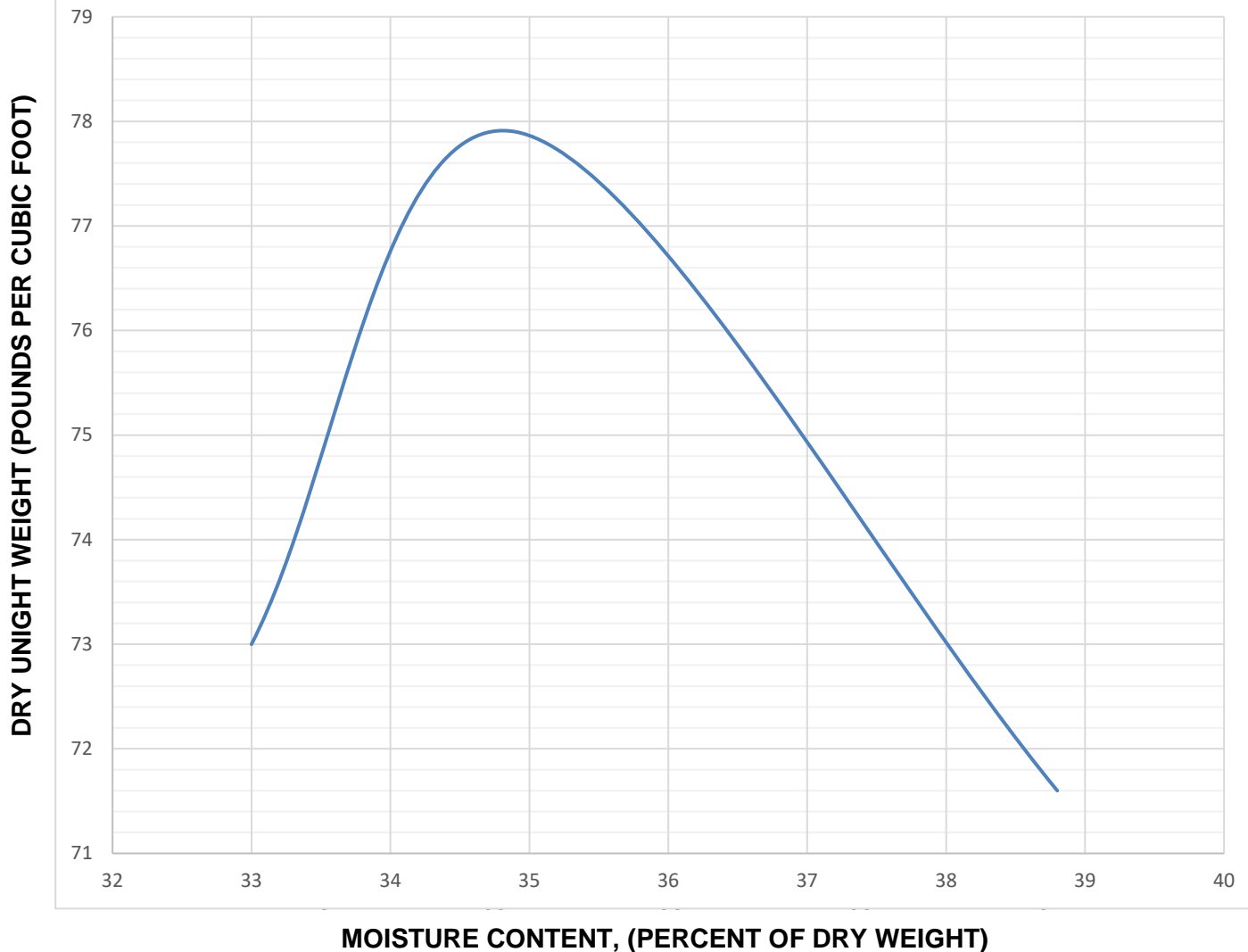

TESTED BY: JC

PLOTTED BY: CS

REVIEWED BY: CS



Testing Engineers and Consultants, Inc.

1343 Rochester Road PO Box 249 Troy, Michigan 48099-0249

248-588-6200 or 313 T-E-S-T-I-N-G

Fax 248-588-6232

SOIL COMPACTION TEST GRAPH

PROJECT: DTE Ash Pond

TEC REPORT NUMBER: 62199

LOCATION:

REPORT DATE: 12/17/21

CLIENT: DTE

TEST METHOD: ASTM D1557

SOURCE TEST: #1

Material Description: WEST 1A+1

Sample Date:

Sample Source:

Sampled By: TEC

Sample Location:

Maximum Density: 53.7 pcf

Intended Use:

Optimum Moisture: 66.5 %

WEST1+1A

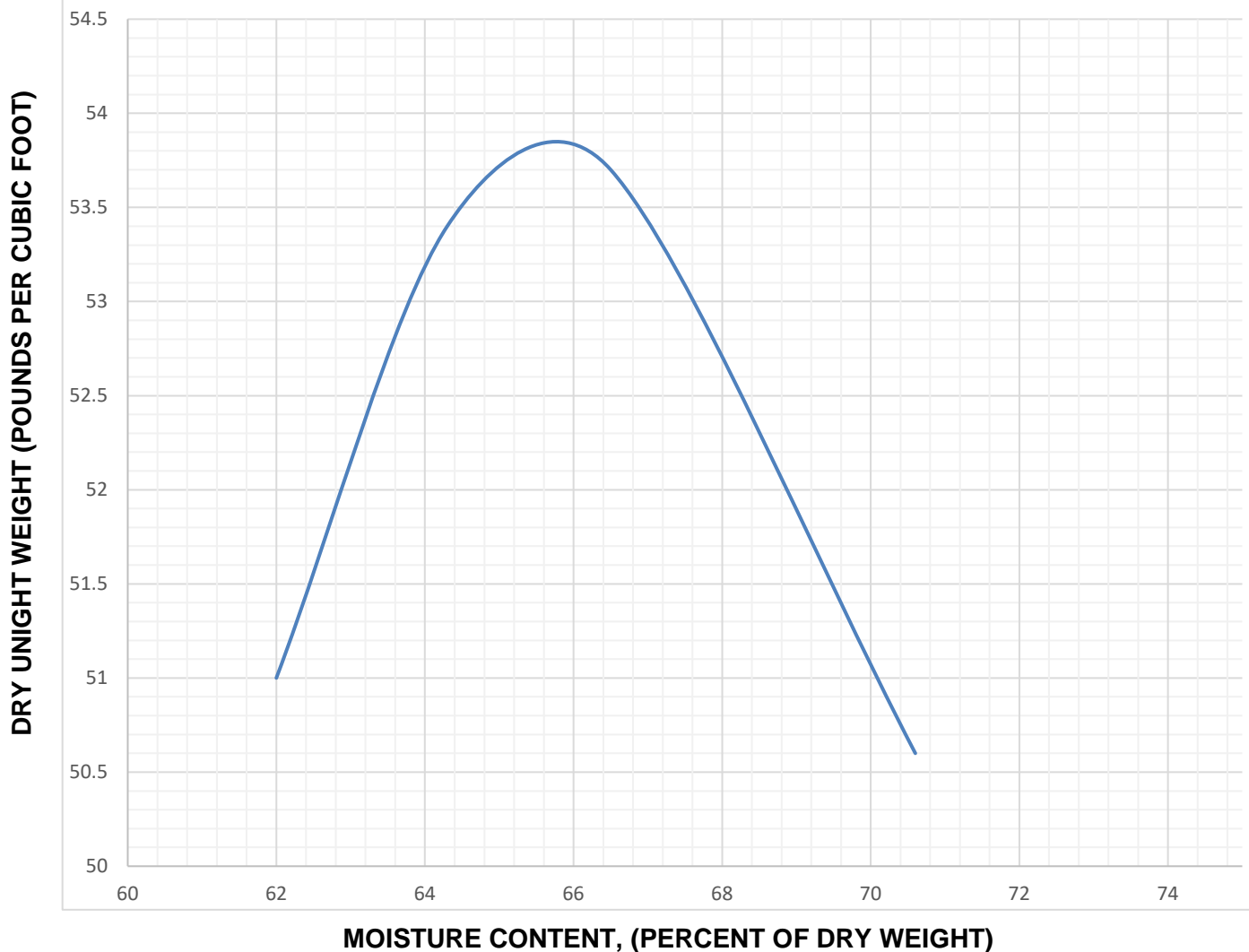

TESTED BY: JC

PLOTTED BY: CS

REVIEWED BY: CS

Ash Laboratory Results Summary

Boring	Specific gravity	Moisture content/organic properties			Atterberg limits		
		Moisture content Air dried (%)	Moisture content Oven dried after saturation (%)	Organic content (%)	Liquid limit	Plastic limit	Plasticity index
East basin 1	2.61 combined	35.9	83.7	8.7	49 combined	45	4
East basin 1A		28.5	89.9	6.1			
West basin 1	2.41 combined	41.9	123.0	16.1	35 combined	30	5
West basin 1A		60.2	124.2	17.0			

Clay Lab Summary

Boring	Depth (ft)	Weight – volume properties			Unconfined compressive strength (psf)	Atterberg limits		
		Moisture content (%)	Bulk unit weight (pcf)	Dry unit weight (pcf)		Liquid limit	Plastic limit	Plasticity index
SB-01-21	18 to 20	26.0	115.2	91.5	1520	39	29	10
SB-01-21	40 to 42	23.8	112.8	90.6	1510	29	23	6
SB-02-21	56 to 68	23.1	119.2	96.9	1930	33	22	11
SB-02-21	14 to 16	26.6	115.1	90.9	3450	37	23	14

UNCONFINED COMPRESSION TEST

Project Name: STCPP

Depth: 14-16 ft

Sample Number: 22741069 SB-02-21

Visual Classification: Brown Silty 10/5/2021

Sample data

Bag # 8

Weight of specimen (g)	Initial length (in)	Initial diameter (in)	Initial area (in ²)
1259.78	6.043	2.964	6.899

Water content data

Moist soil (g)	Dry soil (g)	Water (g)
991.56	783.04	208.52

Moisture content and unit weight results

Moisture content (%)	Bulk unit weight (pcf)	Dry unit weight (pcf)
26.63	115.1	90.9

Deformation - load and stress - strain results

Deformation (in)	Vertical Strain ϵ	Corrected Area (in ²)	Load (lb)	Stress (lb/ft ²)
0	0	6.899	0	0
0.05	0.008	6.955	26.1	540
0.1	0.017	7.018	55.7	1140
0.15	0.025	7.076	86.8	1770
0.2	0.033	7.134	108.6	2190
0.25	0.041	7.194	130.2	2610
0.3	0.05	7.262	147	2910
0.35	0.058	7.324	159.9	3140
0.4	0.066	7.387	170.3	3320
0.45	0.074	7.45	177.2	3430
0.5	0.083	7.523	174.8	3350
0.55	0.091	7.59	161.3	3060

UNCONFINED COMPRESSION TEST

Project Name: STCPP

Depth: 18-20 ft

Sample Number: 227410 CA SB-01-21

Visual Classification: Brown Silty 10/4/2021

Sample data

Weight of specimen (g)	Initial length (in)	Initial diameter (in)	Initial area (in ²)
1140.44	6.035	2.864	6.441

Water content data

Moist soil (g)	Dry soil (g)	Water (g)
953.93	756.88	197.05

Moisture content and unit weight results

Moisture content (%)	Bulk unit weight (pcf)	Dry unit weight (pcf)
26.03	111.8	88.7

Deformation - load and stress - strain results

Deformation (in)	Vertical Strain ϵ	Corrected Area (in ²)	Load (lb)	Stress (lb/ft ²)
0	0	6.441	0	0
0.05	0.008	6.493	12.5	280
0.1	0.017	6.552	21.1	460
0.15	0.025	6.606	27.4	600
0.2	0.033	6.661	34	740
0.25	0.041	6.716	39.2	840
0.3	0.05	6.78	44.9	950
0.35	0.058	6.838	49.8	1050
0.4	0.066	6.896	54.7	1140
0.45	0.075	6.963	58.4	1210
0.5	0.083	7.024	61.9	1270
0.55	0.091	7.086	65.5	1330
0.6	0.099	7.149	68.3	1380
0.65	0.108	7.221	71.2	1420
0.7	0.116	7.286	73.1	1440
0.75	0.124	7.353	75.1	1470
0.8	0.133	7.429	77	1490
0.85	0.141	7.498	78.3	1500
0.9	0.149	7.569	80.1	1520

SB-01-2021 18 to 20 feet

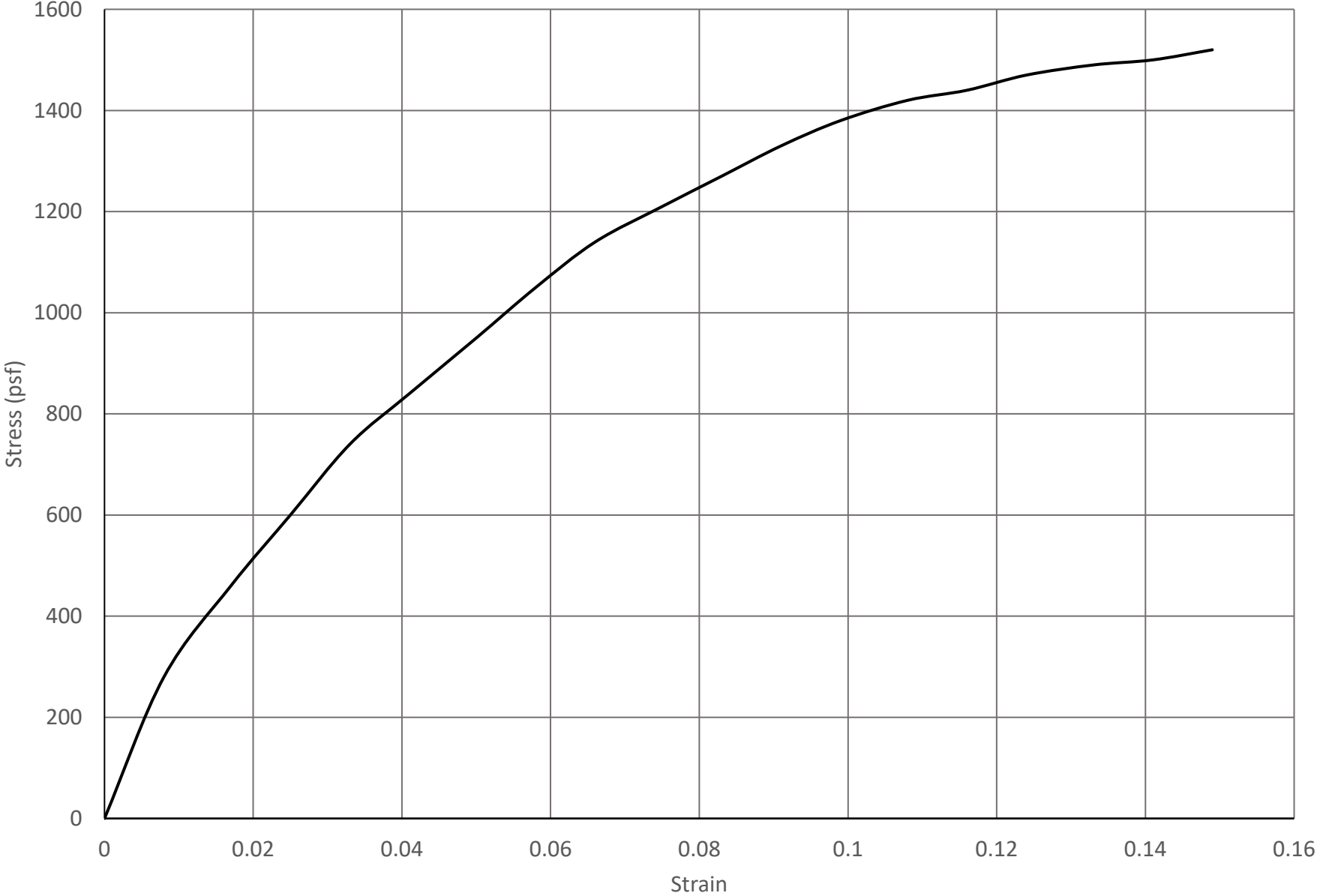

UNCONFINED COMPRESSION TEST

Project Name: STCPP

Depth: 40-42 ft

Sample Number: 27741069 SB-01-21

Visual Classification: Brown Silty 10/4/2021

Sample data

Weight of specimen (g)	Initial length (in)	Initial diameter (in)	Initial area (in ²)
1223.81	6.034	2.964	6.899

Water content data

Moist soil (g)	Dry soil (g)	Water (g)
903	729.17	173.83

Moisture content and unit weight results

Moisture content (%)	Bulk unit weight (pcf)	Dry unit weight (pcf)
23.84	112.0	90.4

Deformation - load and stress - strain results

Deformation (in)	Vertical Strain ϵ	Corrected Area (in ²)	Load (Ib)	Stress (Ib/ft ²)
0	0	6.899	0	0
0.05	0.008	6.955	13.2	270
0.1	0.017	7.018	24.4	500
0.15	0.025	7.076	32.6	660
0.2	0.033	7.134	39.5	800
0.25	0.041	7.194	46.6	930
0.3	0.05	7.262	52	1030
0.35	0.058	7.324	57.3	1130
0.4	0.066	7.387	61.8	1200
0.45	0.075	7.458	66	1270
0.5	0.083	7.523	69.9	1340
0.55	0.091	7.59	72.8	1380
0.6	0.099	7.657	75.9	1430
0.65	0.108	7.734	78	1450
0.7	0.116	7.804	80	1480
0.75	0.124	7.876	81	1480
0.8	0.133	7.957	83.3	1510
0.85	0.141	8.031	83.7	1500
0.9	0.149	8.107	82.9	1470

SB-01-2021 40 to 42 feet

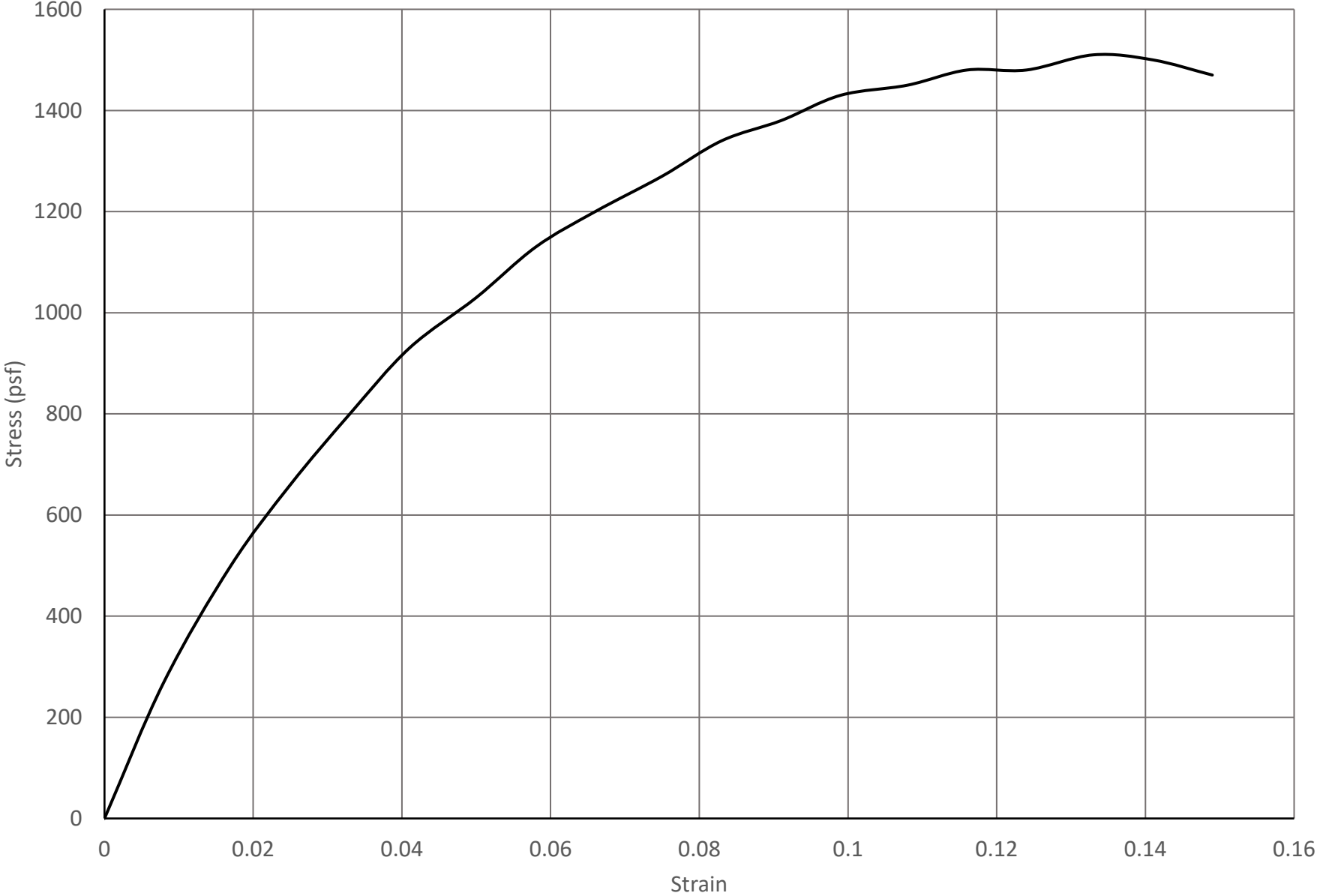

SB-01-2021 56 to 58 feet

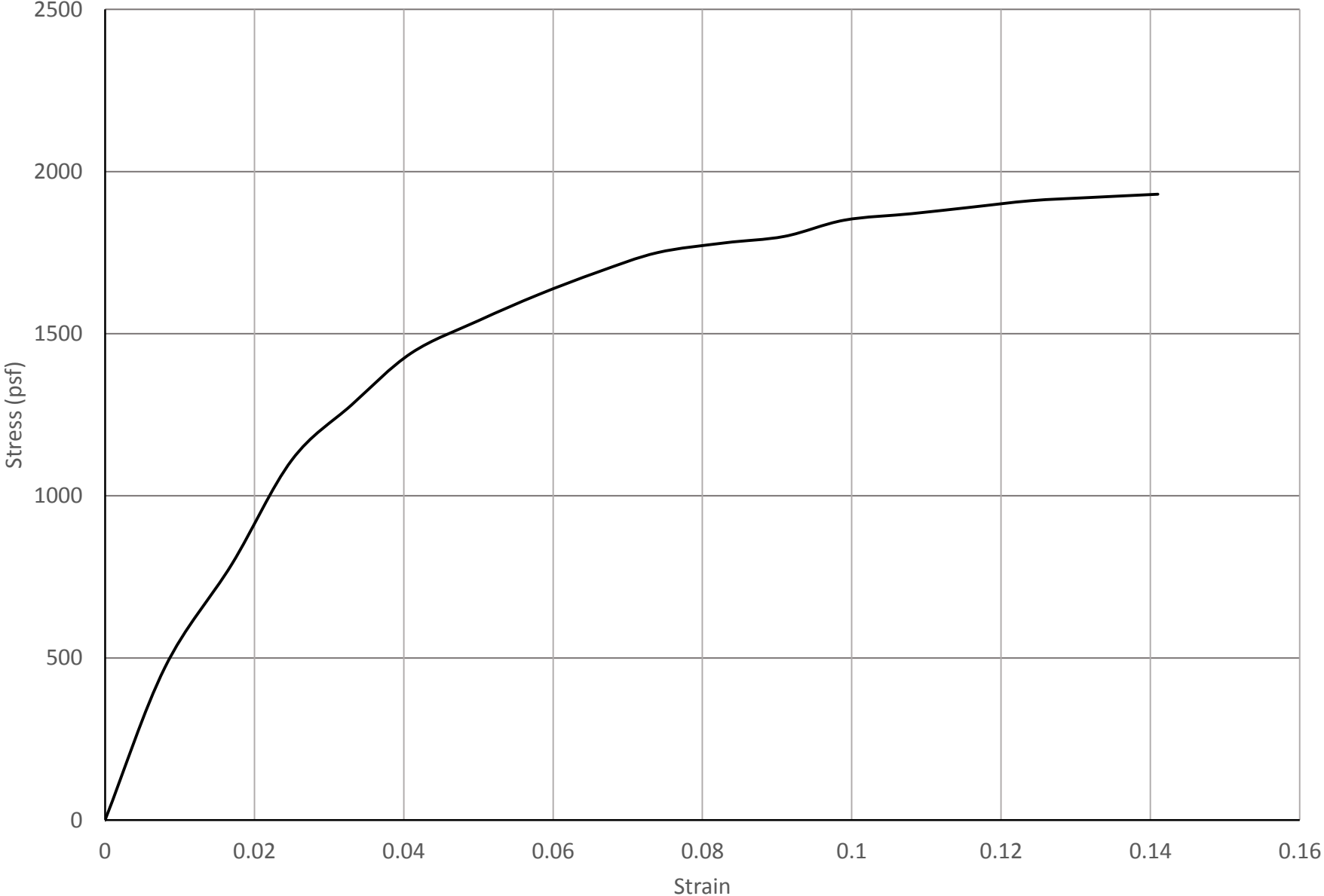

SB-02-2021 14 to 16 feet

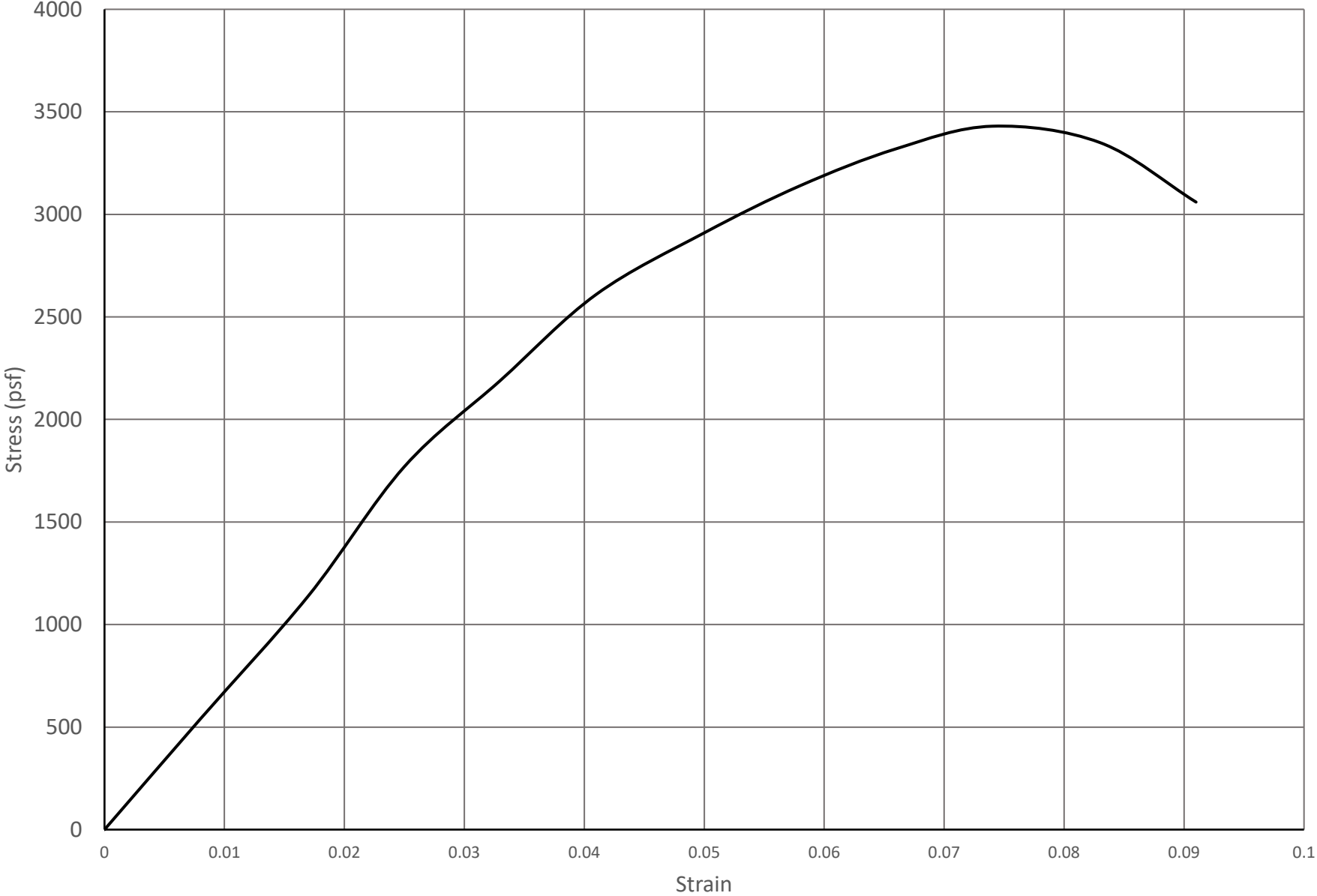

Appendix B

Construction Documentation Drawings

DTE ENERGY

ST. CLAIR COUNTY, EAST CHINA, MICHIGAN

ST. CLAIR POWER PLANT

BOTTOM ASH BASIN CLOSURE PROJECT

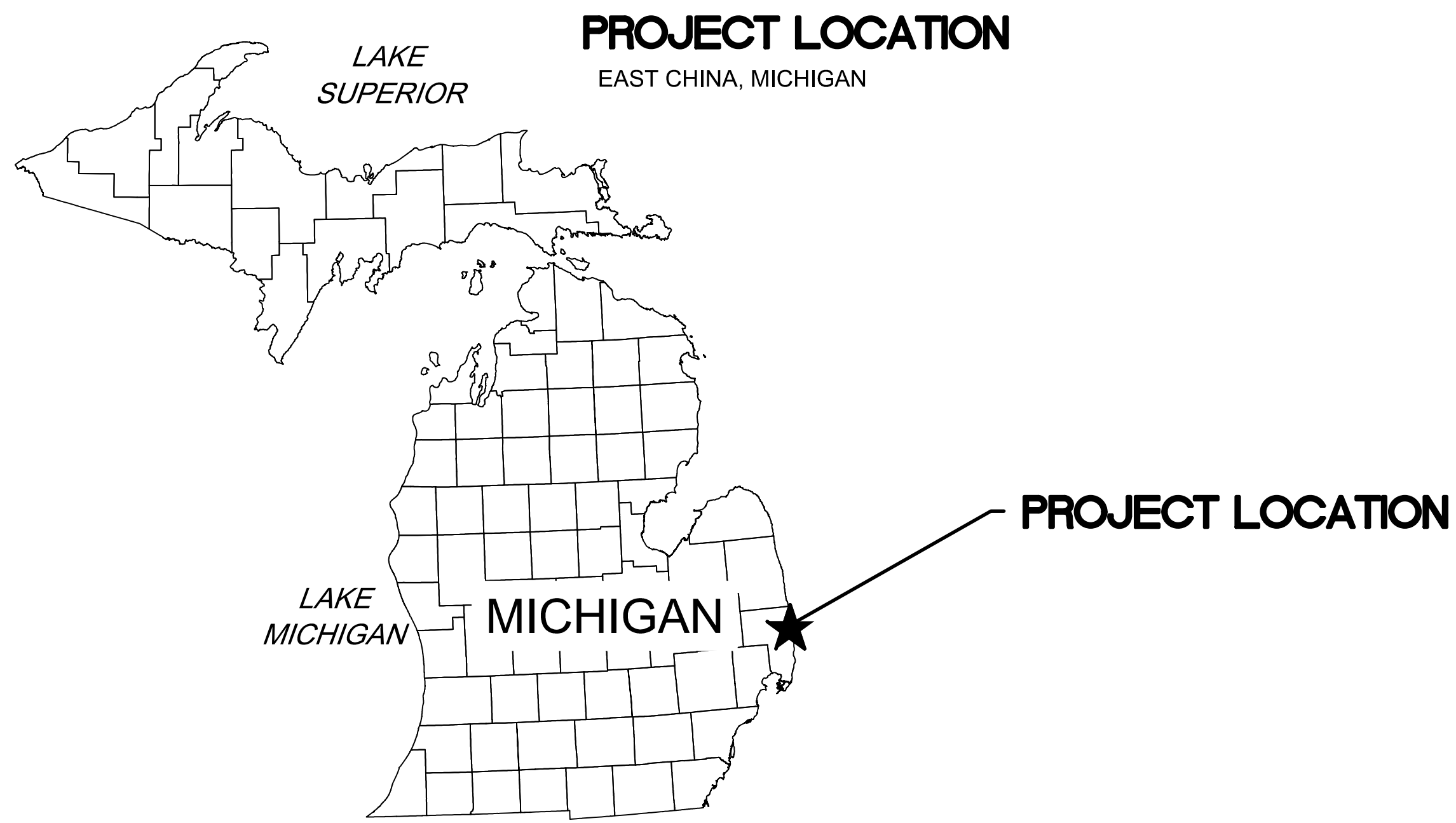

INDEX OF DRAWINGS

DOCUMENT #	REV.	NAME
0516-C-3045		COVER SHEET
0516-C-3046		EXISTING CONDITIONS PLAN
0516-C-3047		SITE DEMOLITION PLAN
0516-C-3048		FINAL GRADING AND RESTORATION PLAN
0516-C-3049		BASE CROSS-SECTIONS
0516-C-3050		EXISTING CONDITIONS STRUCTURAL DETAILS
0516-C-3051		GENERAL DETAILS
0516-C-3052		STORMWATER SECTIONS AND DETAILS
0516-C-3053		SPECIFICATIONS
0516-M-7435		PUMP BUILDING AND SILO DRAIN SUMP PLAN, PROFILES, AND DETAILS
0516-M-7436		UNIT 5 DRAIN SUMP PIPE REROUTE PLAN AND DETAILS

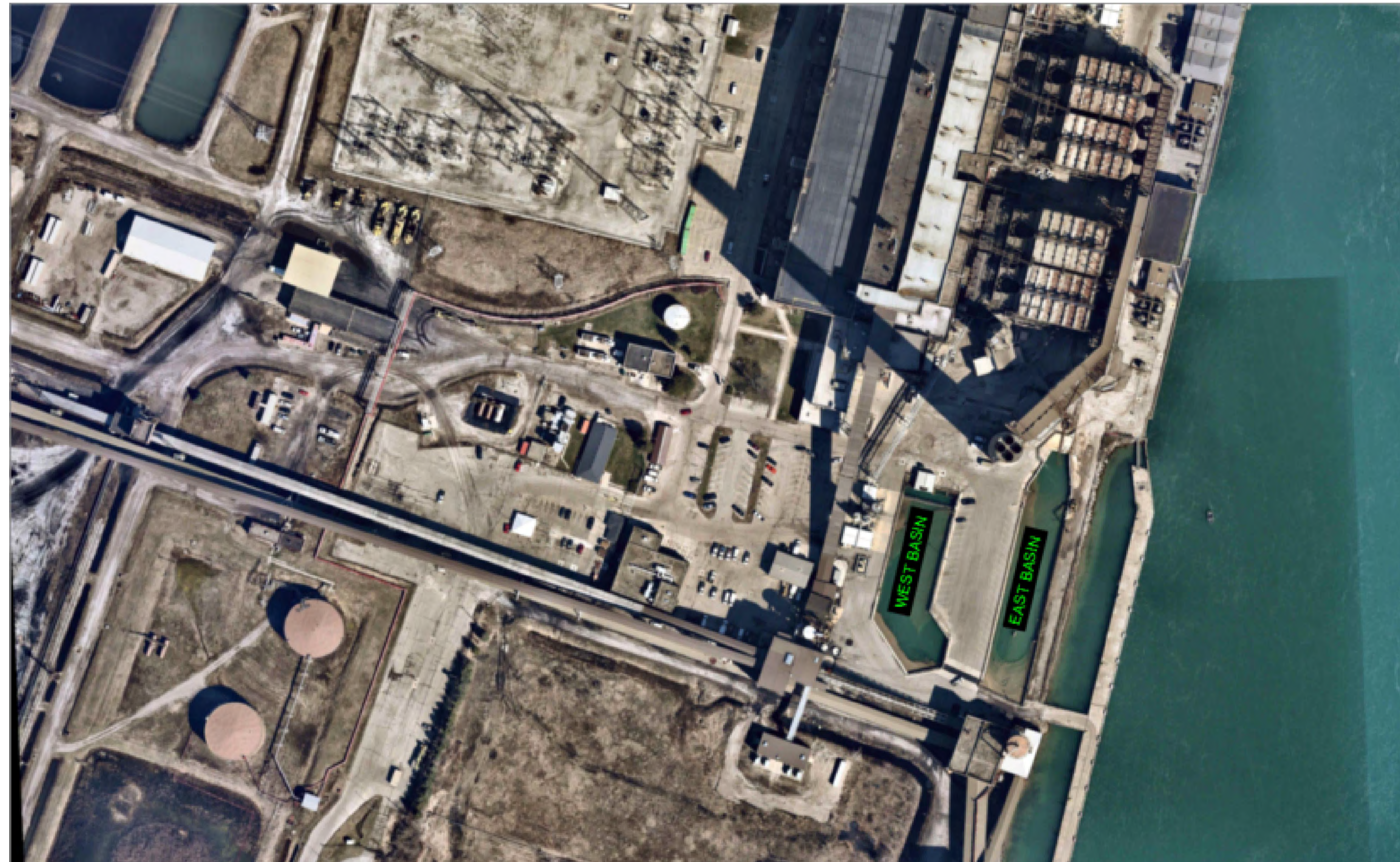

TYPICAL CALL OUTS

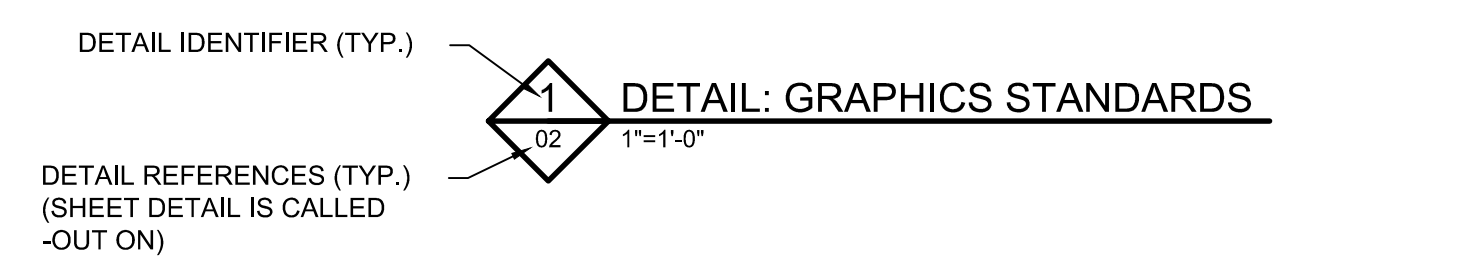
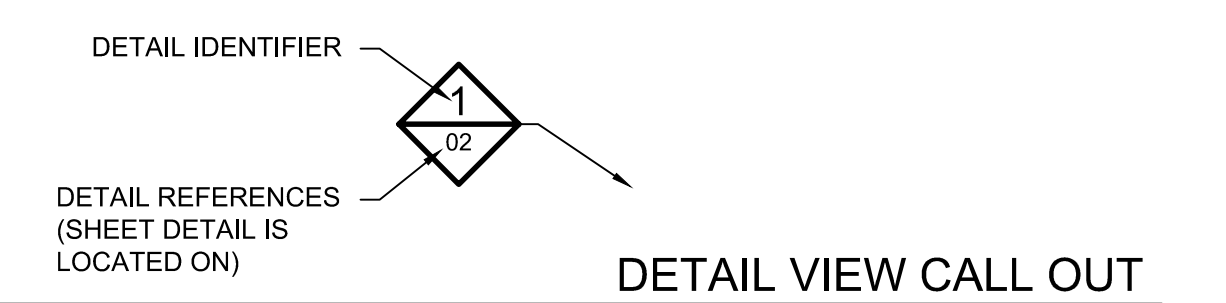
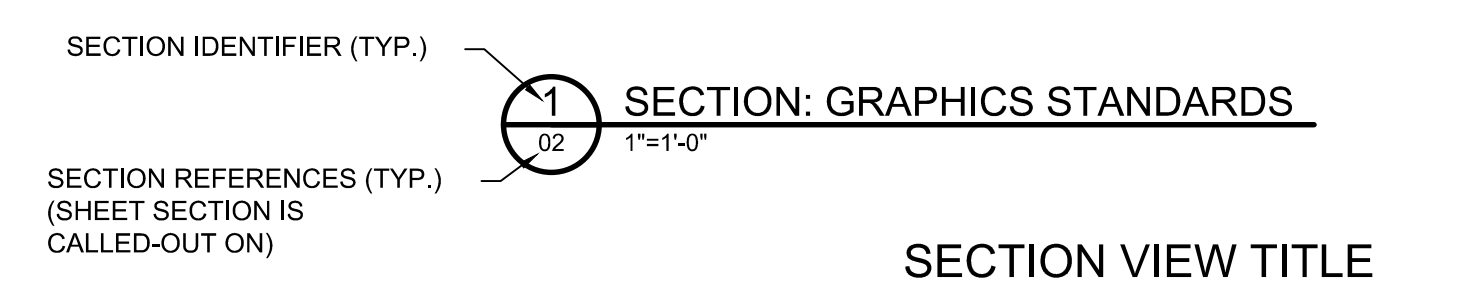
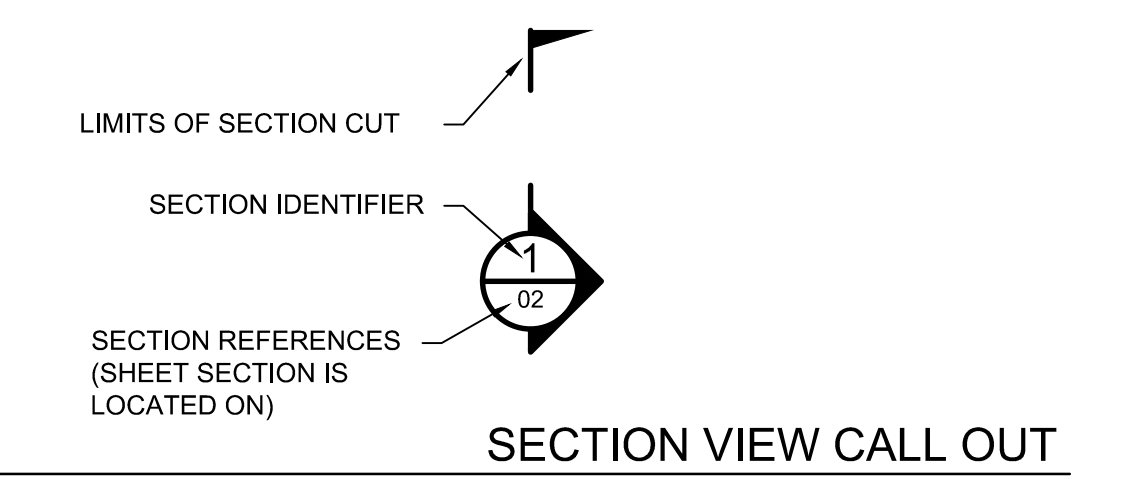

0516-C-3045
LATEST REVISION

NO.	DATE	ISSUED FOR	PROJ. ENG.	RESP. ENG.
6	05JUN23	AS-BUILT		R.CHRISTENSEN
5	01FEB22	CONSTRUCTION	S. MASTERS	R.CHRISTENSEN
4	14JAN22	90% DESIGN REVIEW	S. MASTERS	R.CHRISTENSEN
3	20DEC21	60% DESIGN REVIEW	S. MASTERS	R.CHRISTENSEN
2	29OCT21	50% DESIGN REVIEW	S. MASTERS	R.CHRISTENSEN
1				

PROJECT ENGINEER: S. MASTERS
PRECONSTRUCTION REVISION BLOCK - REV. 0

Vendor:

BARR
BARR ENGINEERING CO.
3005 BENTONVILLE STREET
ANN ARBOR, MI 48106
PH: 734.769.1111

DTE

DESIGNED BY: S. HILCOXMAN 21OCT21
DRAWN BY: J. METTLACH 26OCT21
CHECKED BY: R. CHRISTENSEN 29OCT21
APPROVED BY: R. CHRISTENSEN 01FEB22

PROJECT ENGINEER: S. MASTERS
PROJECT MANAGER: [blank]

LOCATION NAME: ST. CLAIR COUNTY POWER PLANT
UNIT NUMBER: [blank]

ORIGINATING SOURCE: BARR ENGINEERING CO.
SCALE: AS SHOWN
USE DIMENSIONS DO NOT SCALE

DTE ELECTRIC COMPANY DRAWING NUMBER: 0516-C-3045

VICINITY MAP

GENERAL NOTES

- EXISTING TOPOGRAPHIC INFORMATION BASED ON JULY 2016 SCPP ASH BASIN TOPO SURVEY BY MCNEELY & LINCOLN ASSOCIATES, INC. AND UPDATED WITH MAY 2021 BATHYMETRIC DATA BY BMJ ENGINEERS & SURVEYORS, INC.
- ELEVATIONS ARE PRESENTED IN THE DTE PLANT VERTICAL DATUM (ORIGIN UNKNOWN).
- ALL COORDINATES ARE PRESENTED IN THE DTE PLANT HORIZONTAL DATUM (ORIGIN UNKNOWN).

C				B				A			
PROJ.	DESIGN	CHK	DATE	PROJ.	DESIGN	CHK	DATE	PROJ.	DESIGN	CHK	DATE

THIS IS AN CAD PRODUCED DRAWING.
ANY CHANGES OR REVISIONS TO
THIS DRAWING MUST BE COMPLETED
USING THE CAD SYSTEM.

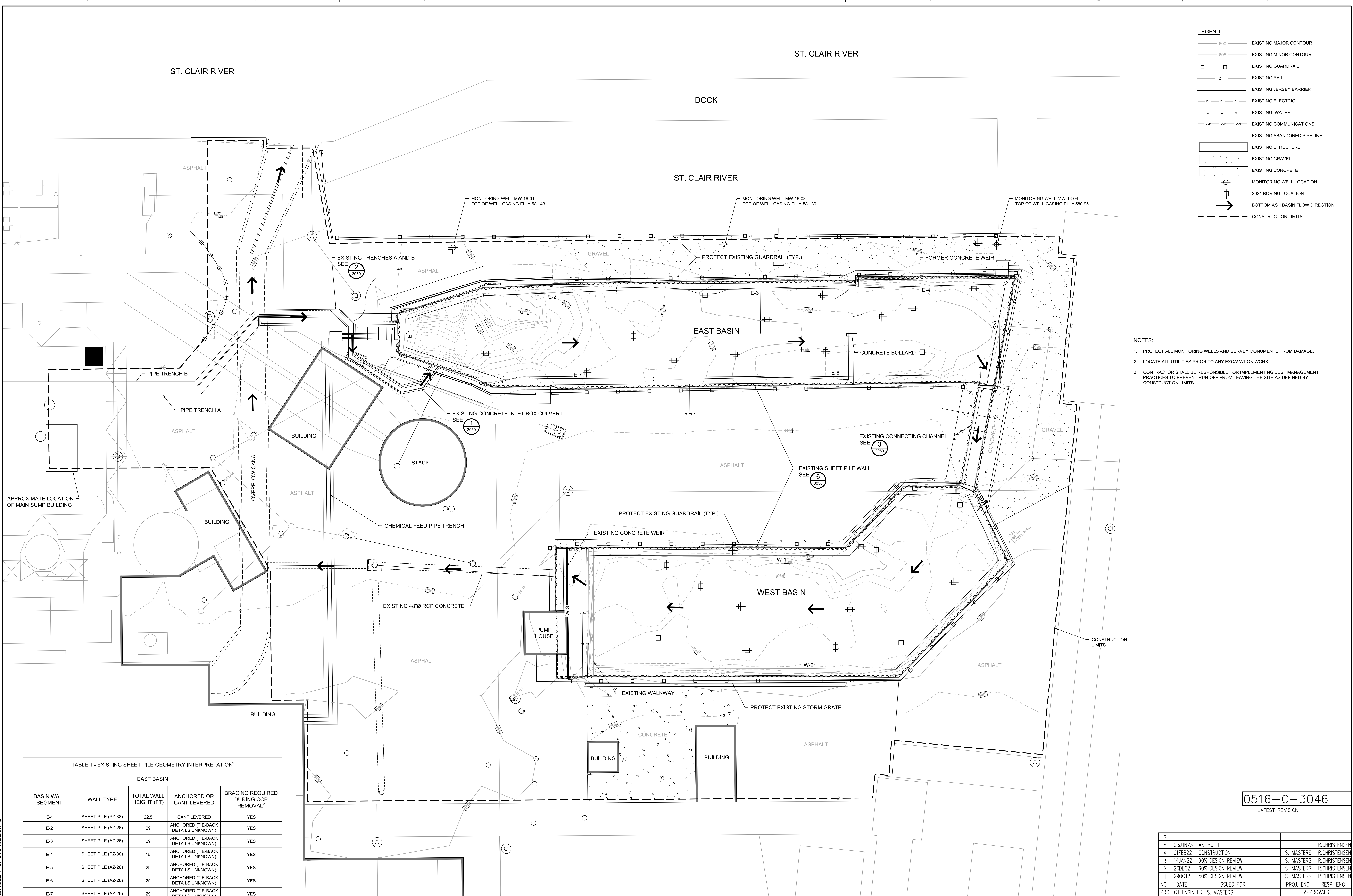

- LEGEND**
- 600 — EXISTING MAJOR CONTOUR
 - 605 — EXISTING MINOR CONTOUR
 - □ — EXISTING GUARDRAIL
 - x — EXISTING RAIL
 - — — EXISTING JERSEY BARRIER
 - e — e — e — EXISTING ELECTRIC
 - w — w — w — EXISTING WATER
 - — — — — EXISTING COMMUNICATIONS
 - — — — — EXISTING ABANDONED PIPELINE
 - ▭ EXISTING STRUCTURE
 - ▨ EXISTING GRAVEL
 - ▩ EXISTING CONCRETE
 - ⊕ MONITORING WELL LOCATION
 - ⊕ BOTTING LOCATION
 - 2021 BORING LOCATION
 - BOTTOM ASH BASIN FLOW DIRECTION
 - - - - - CONSTRUCTION LIMITS

- NOTES:**
- PROTECT ALL MONITORING WELLS AND SURVEY MONUMENTS FROM DAMAGE.
 - LOCATE ALL UTILITIES PRIOR TO ANY EXCAVATION WORK.
 - CONTRACTOR SHALL BE RESPONSIBLE FOR IMPLEMENTING BEST MANAGEMENT PRACTICES TO PREVENT RUN-OFF FROM LEAVING THE SITE AS DEFINED BY CONSTRUCTION LIMITS.

TABLE 1 - EXISTING SHEET PILE GEOMETRY INTERPRETATION¹

EAST BASIN				
BASIN WALL SEGMENT	WALL TYPE	TOTAL WALL HEIGHT (FT)	ANCHORED OR CANTILEVERED	BRACING REQUIRED DURING CCR REMOVAL ²
E-1	SHEET PILE (PZ-38)	22.5	CANTILEVERED	YES
E-2	SHEET PILE (AZ-26)	29	ANCHORED (TIE-BACK DETAILS UNKNOWN)	YES
E-3	SHEET PILE (AZ-26)	29	ANCHORED (TIE-BACK DETAILS UNKNOWN)	YES
E-4	SHEET PILE (PZ-38)	15	ANCHORED (TIE-BACK DETAILS UNKNOWN)	YES
E-5	SHEET PILE (AZ-26)	29	ANCHORED (TIE-BACK DETAILS UNKNOWN)	YES
E-6	SHEET PILE (AZ-26)	29	ANCHORED (TIE-BACK DETAILS UNKNOWN)	YES
E-7	SHEET PILE (AZ-26)	29	ANCHORED (TIE-BACK DETAILS UNKNOWN)	YES
WEST BASIN				
W-1	SHEET PILE (AZ-26)	29	ANCHORED (TIE-BACK DETAILS UNKNOWN)	YES
W-2	SHEET PILE (AZ-26)	29	ANCHORED (TIE-BACK DETAILS UNKNOWN)	YES
W-3	SHEET PILE (AZ-26)	29(7)	CANTILEVERED	YES

TABLE NOTES:

- INFORMATION PRESENTED IN THE SHEET PILE GEOMETRY INTERPRETATION TABLES ARE PER BARR'S REVIEW OF DTE BOTTOM ASH BASIN HISTORIC DOCUMENTS. DOCUMENTS REVIEWED BY BARR ACCOMPANY THE EXECUTION SPECIFICATION. IN-FIELD CONFIRMATION OF SHEET PILE GEOMETRY BY BARR HAS NOT BEEN PERFORMED. CONTRACTOR SHALL CONFIRM SHEET PILE GEOMETRY TO EXTENT REQUIRED TO EXECUTE THEIR BOTTOM ASH BASIN CCR REMOVAL PLAN AS BID.
- SHEET PILE WALL SEGMENT BRACING IS REQUIRED DURING CCR REMOVAL UNLESS OTHERWISE APPROVED BY ENGINEER IN WRITING PRIOR TO CCR REMOVAL. BRACING MAY BE BY TEMPORARY STRUCTURAL ELEMENTS AND/OR BY IMPORTED STRUCTURAL FILL. STRUCTURAL FILL TYPE SHALL BE APPROVED BY ENGINEER. CCR EXCAVATION SEQUENCING BY CONTRACTOR MUST MAINTAIN SHEET PILE STABILITY. BRACING AND/OR SOIL PRESSURE MUST BE MAINTAINED FROM ELEVATION 11 FEET FROM TOP OF WALL DOWNWARD. CONTRACTOR SHALL PROPOSE, FOR ENGINEER APPROVAL, BRACING AND SEQUENTIAL CCR EXCAVATION AND FILL PLACEMENT TO EXPOSE SMALL SEGMENTS OF BAB FOR CLEANOUT AND CLEANOUT DOCUMENTATION.

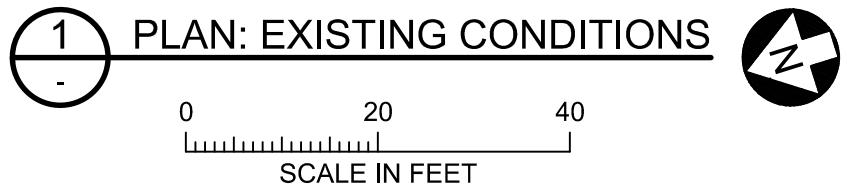

0516-C-3046
LATEST REVISION

NO.	DATE	ISSUED FOR	PROJ. ENG.	RESP. ENG.
6	05JUN23	AS-BUILT	S. MASTERS	R. CHRISTENSEN
5	01FEB22	CONSTRUCTION	S. MASTERS	R. CHRISTENSEN
4	14JAN22	90% DESIGN REVIEW	S. MASTERS	R. CHRISTENSEN
3	20DEC21	80% DESIGN REVIEW	S. MASTERS	R. CHRISTENSEN
2	20DEC21	60% DESIGN REVIEW	S. MASTERS	R. CHRISTENSEN
1	29OCT21	50% DESIGN REVIEW	S. MASTERS	R. CHRISTENSEN

PROJECT ENGINEER: S. MASTERS
PRECONSTRUCTION REVISION BLOCK - REV. 0

Vendor:

BARR
BARR ENGINEERING CO.
3005 BENTONVILLE STREET
SUITE 100
ANN ARBOR, MI 48106
PH: 734.769.0101

DTE
DTE ELECTRIC COMPANY DRAWING NUMBER

ST. CLAIR COUNTY POWER PLANT
UNIT NUMBER

BARR ENGINEERING CO.
SCALE AS SHOWN
USE DIMENSIONS ON NOT SCALE

0516-C-3046
DESIGN FILE NAME: 0516-C-3046.dwg
DATE: 05JUN23 OPERATOR: JAMG

C				B				A			
PROJ. ENG.	DESIGN	CHK BY	DATE	PROJ. ENG.	DESIGN	CHK BY	DATE	PROJ. ENG.	DESIGN	CHK BY	DATE

OTHER APPROVALS

DATE	APPROVED BY	DATE	APPROVED BY

DESIGNED BY: S. MASTERS
DRAWN BY: J. METTLACH
CHECKED BY: R. CHRISTENSEN
APPROVED BY: R. CHRISTENSEN

LEGEND

- 580 EXISTING MAJOR CONTOUR
- 583 EXISTING MINOR CONTOUR
- EXISTING GUARDRAIL
- EXISTING RAIL
- EXISTING JERSEY BARRIER
- EXISTING ELECTRIC
- EXISTING WATER
- EXISTING COMMUNICATIONS
- EXISTING STRUCTURE
- DEMOLITION
- MONITORING WELL LOCATION
- 2021 BORING LOCATION
- 565 PROPOSED CCR EXCAVATION MAJOR CONTOUR (SEE NOTE 1)
- 567 PROPOSED CCR EXCAVATION MINOR CONTOUR (SEE NOTE 1)
- CONSTRUCTION LIMITS

NOTES:

1. PROPOSED CCR EXCAVATION SURFACE BASED OFF OF LIMITED 2021 VIBROCORE BORING DATA AND SHOWN FOR REFERENCE ONLY. ACTUAL BOTTOM OF CCR SURFACE WILL VARY. FIELD VERIFY.

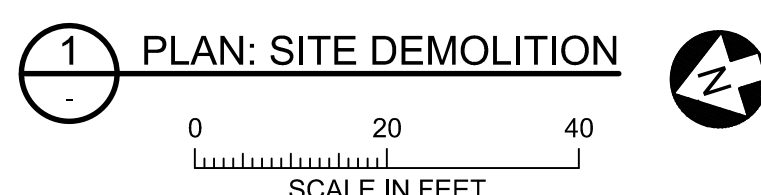
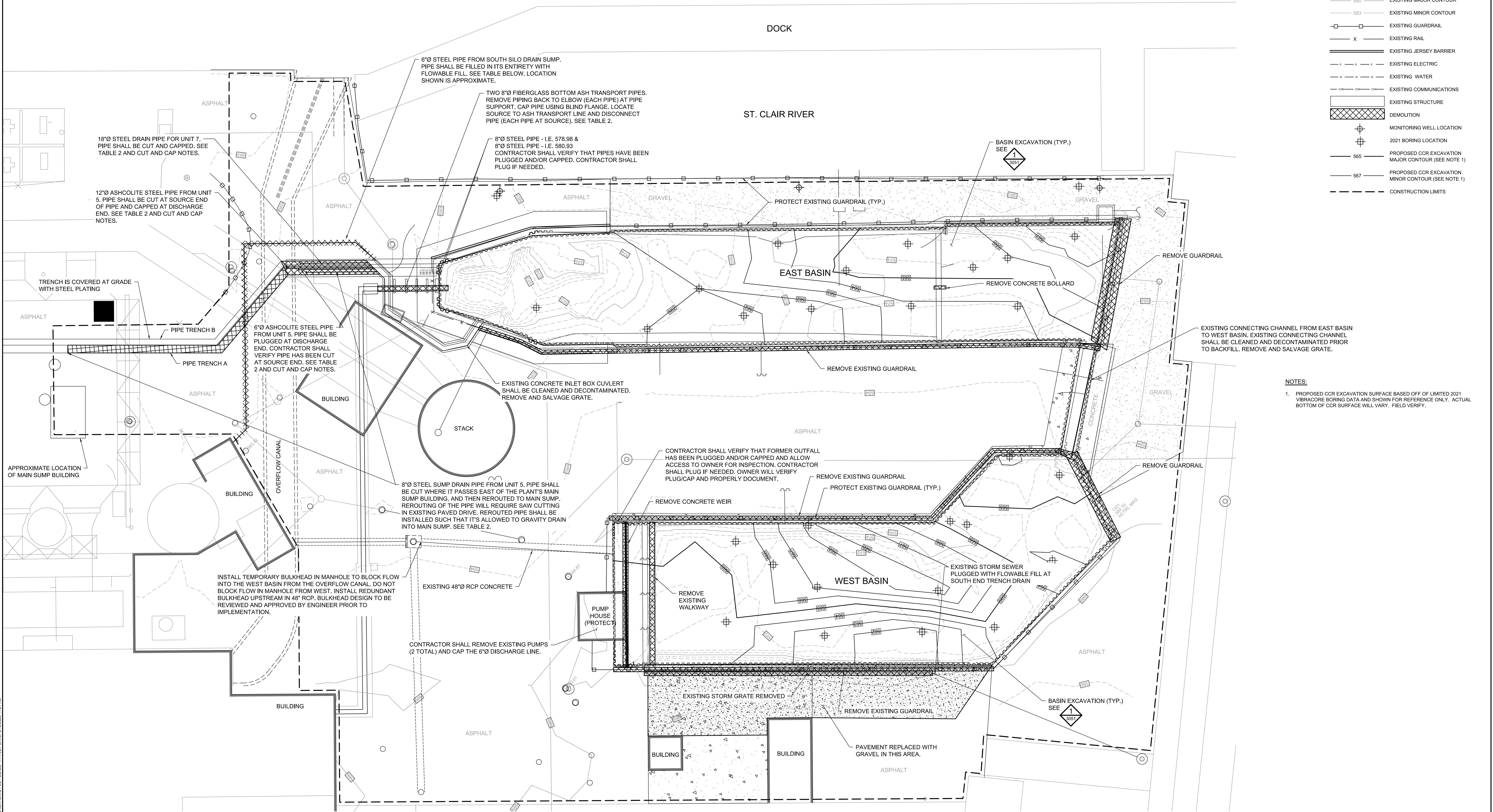

0516-C-3047
LATEST REVISION

TABLE 2 - PIPE ABANDONMENT AND RE-ROUTE SUMMARY

Pipe location	Pipe Size/ID	Material	Current Use	Scope	Abandonment	photolog page #
Trench A	6" Aspholite Pipe	Steel	Inactive pipe. This pipe is no longer active and has been decommissioned upstream of B&B.	Plug pipe where it discharges into the chemical treatment trench with flowable fill a minimum of 30' into pipe.	Pipe plugged with flowable fill.	322, 323
Trench A	8" Unit 5 Drain Sump Pipe	Steel	Active pipe used to drain unit 5 Sump.	Pipe to be rerouted to plants main sump. See details sheet M-7436.	Pipe rerouted used a 8" 90 degree elbow flange. The pipe is located 28' from ENE of the east side of the main sump building.	323
Trench A	12" Aspholite Pipe	Steel	Active pipe used for draining unit 5.	1. Plug pipe where it discharges into the chemical treatment trench with flowable fill a minimum of 30' into pipe. 2. Trace pipe back to the unit 5 source of water. Disconnect pipe from its water source and install cap on each exposed end of pipe. If applicable, remove primary source of water to unit 5.	1. 12" Aspholite pipe plugged with flowable fill. Pipe filled until plugged. 2. Unit 5 - section of discharge piping removed, inlet and outlet capped with a blind flange.	3, 333 2, 332, 333
Trench B	18" Drain Pipe for Unit 7	Steel	Active pipe used for draining unit 7.	1. Plug pipe where it discharges into the chemical treatment trench with flowable fill a minimum of 30' into pipe. 2. Trace pipe back to the unit 7 source of water. Disconnect pipe from its water source and install cap on each exposed end of pipe. If applicable, remove primary source of water to unit 7.	1. 18" Aspholite pipe plugged with flowable fill. Pipe filled until plugged. 2. Unit 7 - section of discharge piping removed, inlet and outlet capped with a blind flange.	392
Chemical Treatment trench	6" Drain Line	Steel	Active Pipe Used to Drain South Silo Sump	1. Fill entire length of pipe with flowable fill. 2. Trace pipe back to the north silo source of water. Disconnect pipe from its water source and install cap on each exposed end of pipe. If applicable, remove primary source of water to north silo.	1. Entire 6" drain line pipe abandoned with flowable fill. 2. Section of the 18" bottom ash drain pipe removed. Ends capped with a blind flange and plastic mesh.	1, 324, 323 2, 307
B&B Above Grade Influent Piping	2 1/2" Ash Transport Pipes	Fiberglass	Active Pipes Used to Transport Bottom Ash to the Bottom Ash Pond	1. Remove and discard the above-grade pipe back to the concrete chamber. 2. Plug the end of each pipe with flowable fill, at least 30' into the pipe. 3. Trace pipe back to the original source of water. Disconnect pipe from its water source and install cap on each exposed end of pipe. Source for both pipes is in the basement of the plant under units 1-4.	1. Pipe capped at elbow with blind flange. 2. Unit 2, 3, 4 and 5 - Section of the discharge outlet piping removed downstream from where the pipes merge. Inlet and outlet capped with a blind flange. Pipes are located in the sub-basement of unit 1.	1, 316 2, 316 3, 314

CUT AND CAP NOTES:

- CUT AND CAP PIPE AT BOTH ENDS OF THE PIPE. AT THE DISCHARGE END, PLUG PIPE WITH CONCRETE. AT THE SOURCE END, CUT THE PIPE AT A PRESELECTED FLANGE OR ELBOW AND PHYSICALLY REMOVE A SECTION OF PIPE. THIS APPROACH ISOLATES THE PIPE FROM THE BOTTOM ASH POND, WHICH ELIMINATES THE POTENTIAL FOR AN ACCIDENTAL RELEASE TO THE POND.
- IF THE SOURCE END OF THE PIPE ORIGINATES AT A UNIT/PROCESS THAT HAS A WATER SUPPLY, THEN THE CONTRACTOR SHALL REMOVE THE SUPPLY OF WATER INTO THE UNIT BY CLOSING ALL WATER SUPPLY VALVES BETWEEN THE UNIT AND THE VALVE. THE SAME PROCESS SHALL BE COMPLETED ON THE WATER SUPPLY DISCHARGE END. THIS APPROACH ELIMINATES THE WATER SUPPLY FROM ACCIDENTALLY BEING TURNED ON, CAUSING A RELEASE FROM THE UNIT.

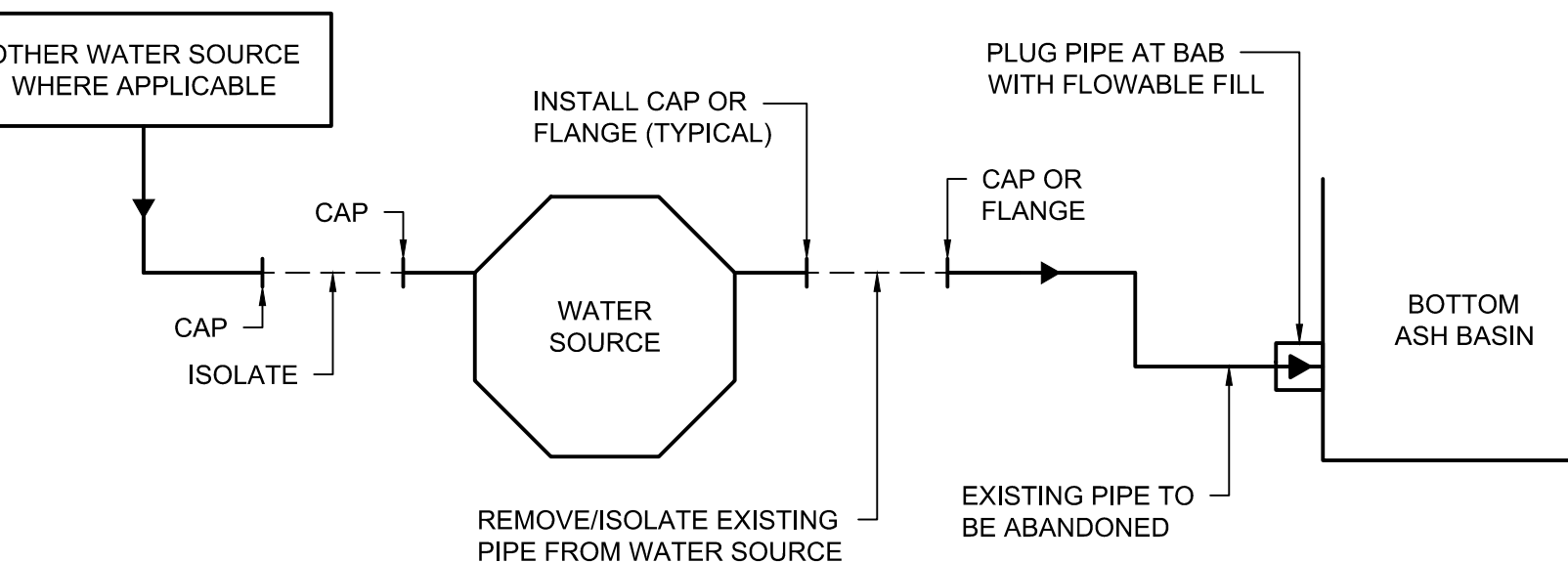

THIS IS AN ADOPTED DRAWING. ANY CHANGES OR REVISIONS TO THIS DRAWING MUST BE COMPLETED USING THE CAD SYSTEM.

APPROVALS

PROJ. ENG.	DESIGNER	CHECKER	APPROVED
S. MASTERS	R. CHRISTENSEN	R. CHRISTENSEN	R. CHRISTENSEN

REVISIONS

NO.	DATE	ISSUED FOR	PROJ. ENG.	RESP. ENG.
6	05JUN23	AS-BUILT	S. MASTERS	R. CHRISTENSEN
5	01FEB22	CONSTRUCTION	S. MASTERS	R. CHRISTENSEN
4	14JAN22	80% DESIGN REVIEW	S. MASTERS	R. CHRISTENSEN
3	20DEC21	60% DESIGN REVIEW	S. MASTERS	R. CHRISTENSEN
2	29OCT21	50% DESIGN REVIEW	S. MASTERS	R. CHRISTENSEN
1	29OCT21	50% DESIGN REVIEW	S. MASTERS	R. CHRISTENSEN

Vendor:
BARR ENGINEERING CO.

DTE

0516-C-3047
LATEST REVISION

0516-C-3047
LATEST REVISION

0516-C-3047
LATEST REVISION

BOTTOM ASH BASIN CLOSURE SITE DEMOLITION PLAN

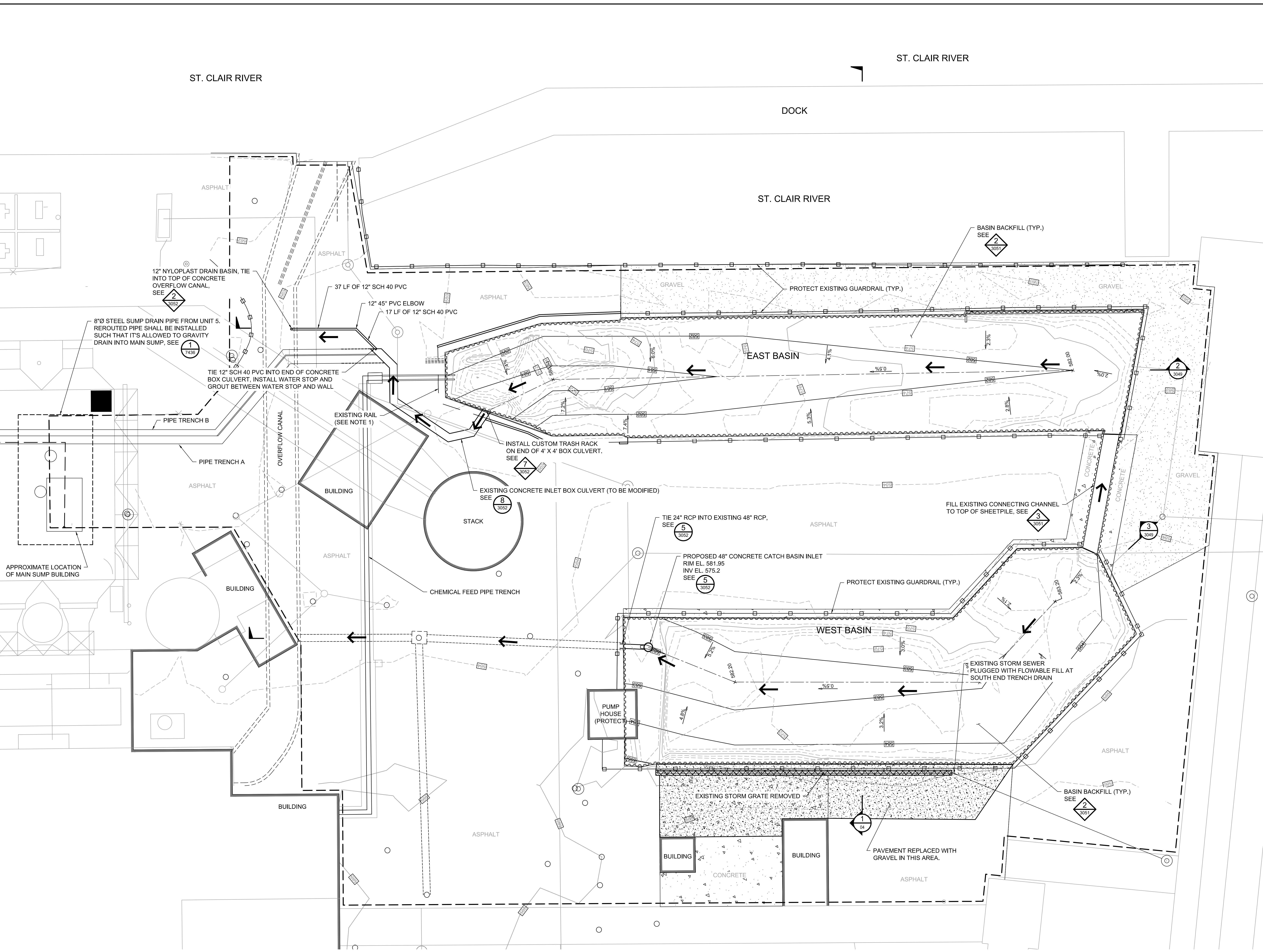

LEGEND

- 600 — EXISTING MAJOR CONTOUR
- 605 — EXISTING MINOR CONTOUR
- [] — EXISTING GUARDRAIL
- [] — EXISTING RAIL
- [] — EXISTING JERSEY BARRIER
- - - - EXISTING ELECTRIC
- - - - EXISTING WATER
- - - - EXISTING COMMUNICATIONS
- [] EXISTING STRUCTURE
- PROPOSED MANHOLE/CATCH BASIN
- 600 — PROPOSED MAJOR CONTOUR
- 605 — PROPOSED MINOR CONTOUR
- - - - PROPOSED PIPE REROUTE
- PROPOSED STORMWATER FLOW DIRECTION
- - - - CONSTRUCTION LIMITS

- NOTES:**
- REPLACE EXISTING RAIL WITH NEW JERSEY BARRIER.
 - FINAL GRADING COMPLETED PER DESIGN.

0516-C-3048
LATEST REVISION

1 PLAN: FINAL GRADING AND RESTORATION

0 20 40
SCALE IN FEET

NO.	DATE	ISSUED FOR	PROJ. ENG.	RESP. ENG.
6	05JUN23	AS-BUILT	S. MASTERS	R. CHRISTENSEN
5	01FEB22	CONSTRUCTION	S. MASTERS	R. CHRISTENSEN
4	14JAN22	90% DESIGN REVIEW	S. MASTERS	R. CHRISTENSEN
3	20DEC21	60% DESIGN REVIEW	S. MASTERS	R. CHRISTENSEN
2	29OCT21	50% DESIGN REVIEW	S. MASTERS	R. CHRISTENSEN
1	29OCT21	50% DESIGN REVIEW	S. MASTERS	R. CHRISTENSEN

PROJECT ENGINEER: S. MASTERS
PRECONSTRUCTION REVISION BLOCK - REV. 0

Vendor:

BARR
BARR ENGINEERING CO.
3005 BENTLEYVILLE STREET
SUITE 100
ANDALUSIA, AL 36826
PH: 205-336-1000
WWW.BARR-ENG.COM

DTE

TITLE: **BOTTOM ASH BASIN CLOSURE FINAL GRADING AND RESTORATION PLAN**

LOCATION NAME: **ST. CLAIR COUNTY POWER PLANT** UNIT NUMBER: _____

ORIGINATING SOURCE: **BARR ENGINEERING CO.** SCALE: **A5 SHOWN** USE DIMENSIONS **DO NOT SCALE**

DTE ELECTRIC COMPANY DRAWING NUMBER: **0516-C-3048**

DESIGN FILE NAME: 0516-C-3048.dwg
DATE: 05JUN23 OPERATOR: JAMG

C PROLOGS				B PROLOGS				A PROLOGS				DTE ELECTRIC APPROVALS		OTHER APPROVALS		DESIGNED BY	
PROLOGS	FOS GEN TECH	INC	CIVIL	PROLOGS	FOS GEN TECH	INC	CIVIL	PROLOGS	FOS GEN TECH	INC	CIVIL	DATE	DATE	DATE	DATE	DATE	
																S. HUECKMAN	
																J. METTLACH	
																R. CHRISTENSEN	
																R. CHRISTENSEN	
																S. MASTERS	
																R. CHRISTENSEN	
																S. MASTERS	
																R. CHRISTENSEN	
																R. CHRISTENSEN	
																R. CHRISTENSEN	

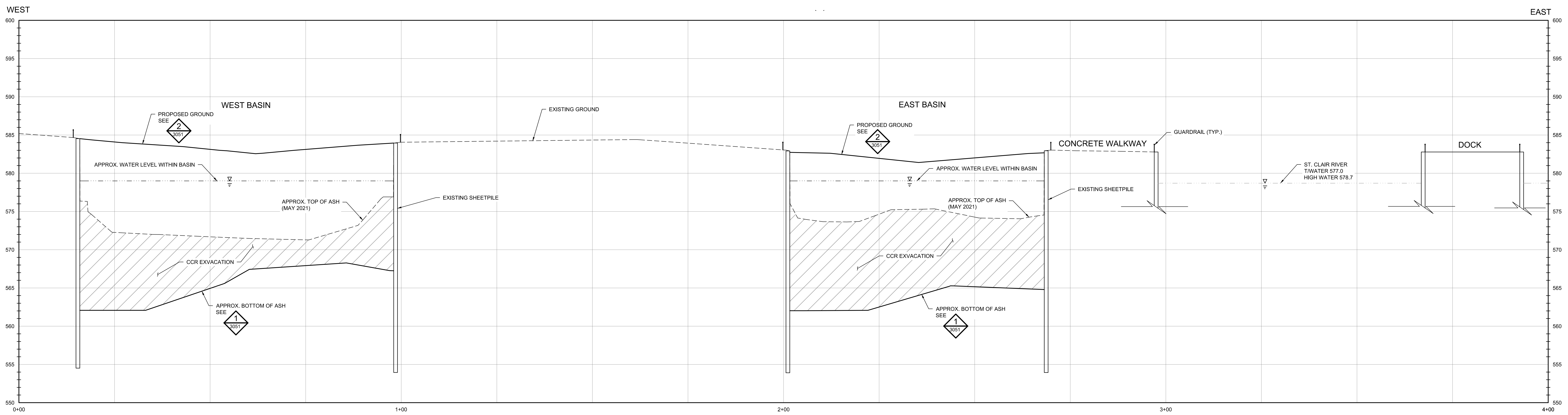

1 SECTION: OVERALL SITE
 HORIZONTAL SCALE IN FEET: 0, 10, 20
 VERTICAL SCALE IN FEET: 0, 5, 10

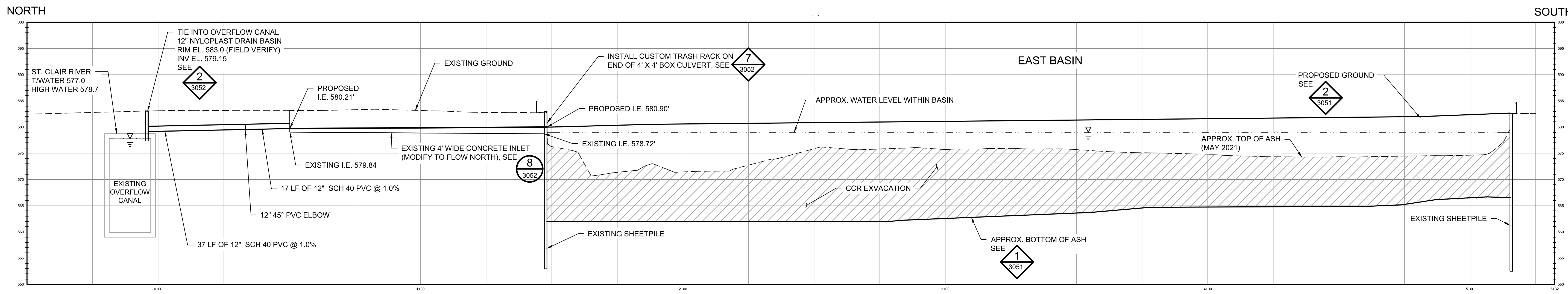

2 SECTION: EAST BASIN
 HORIZONTAL SCALE IN FEET: 0, 20, 40
 VERTICAL SCALE IN FEET: 0, 10, 20

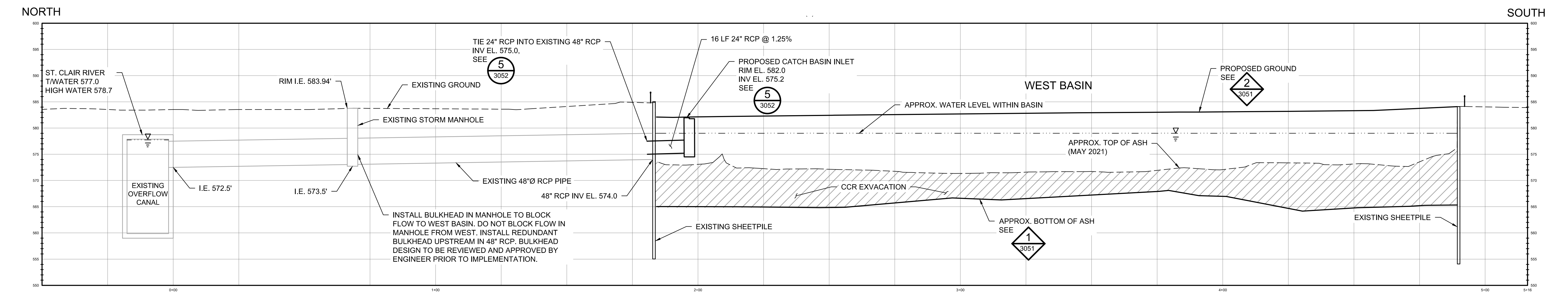

3 SECTION: WEST BASIN
 HORIZONTAL SCALE IN FEET: 0, 20, 40
 VERTICAL SCALE IN FEET: 0, 10, 20

- NOTES:**
1. WATER LEVEL AND TOP OF ASH WILL VARY OVER TIME.
 2. APPROX. TOP OF ASH IS BASED ON MAY 2021 BATHYMETRIC SURVEY. ASH SURFACE LOCATION IS VARIABLE OVER TIME AND WILL REQUIRE VERIFICATION BY CONTRACTOR AT TIME OF BAB CLOSURE BIDDING AND CLOSURE EXECUTION.
 3. APPROX. BOTTOM OF ASH WAS BASED ON THE DEPTH TO CLAY MEASUREMENTS FROM VIBRACORE INVESTIGATION IN SEPTEMBER 2021.
 4. GROUNDWATER LEVEL OUTSIDE THE BASIN APPEARS TO BE APPROX. ELEVATION 580', BASED ON 2020 DATA FROM MONITORING WELLS.

0516-C-3049
 LATEST REVISION

6			
5	05JUN23	AS-BUILT	R. CHRISTENSEN
4	01FEB22	CONSTRUCTION	S. MASTERS R. CHRISTENSEN
3	14JAN22	90% DESIGN REVIEW	S. MASTERS R. CHRISTENSEN
2	20DEC21	60% DESIGN REVIEW	S. MASTERS R. CHRISTENSEN
1	29OCT21	50% DESIGN REVIEW	S. MASTERS R. CHRISTENSEN
NO. DATE	ISSUED FOR	PROJ. ENG.	RESP. ENG.
PROJECT ENGINEER: S. MASTERS		APPROVALS	
PRECONSTRUCTION REVISION BLOCK - REV. 0			

Vendor:
BARR ENGINEERING CO.
 3005 BENTONVILLE STREET
 SUITE 100
 ANDOVER, MA 01810
 PH: 978-232-0171

DTE
 TITLE

**BOTTOM ASH BASIN CLOSURE
 BASIN CROSS-SECTIONS**

LOCATION NAME: ST. CLAIR COUNTY POWER PLANT UNIT NUMBER:
 ORIGINATING SOURCE: BARR ENGINEERING CO. SCALE: AS SHOWN USE DIMENSIONS DO NOT SCALE

DATE: 05JUN23 OPERATOR: JAMG
 0516-C-3049

THIS IS AN CAD PRODUCED DRAWING.
 ANY CHANGES OR REVISIONS TO
 THIS DRAWING MUST BE COMPLETED
 USING THE CAD SYSTEM.

C PROLOGS				B PROLOGS				A PROLOGS				DATE		DATE		DATE	
PROLOGS	DESIGN	CHK	APP	PROLOGS	DESIGN	CHK	APP	PROLOGS	DESIGN	CHK	APP	DATE	DATE	DATE	DATE	DATE	DATE
DESIGNED BY	S. HILCOXMAN	21OCT21		DESIGNED BY	J. METTLACH	26OCT21		DESIGNED BY	R. CHRISTENSEN	29OCT21		DATE	DATE	DATE	DATE	DATE	DATE
CHECKED BY	R. CHRISTENSEN	01FEB22		CHECKED BY	R. CHRISTENSEN	01FEB22		PROJECT ENGINEER	S. MASTERS	05JUN23		DATE	DATE	DATE	DATE	DATE	DATE
PROJECT ENGINEER	S. MASTERS	05JUN23		PROJECT ENGINEER	S. MASTERS	05JUN23		PROJECT ENGINEER	S. MASTERS	05JUN23		DATE	DATE	DATE	DATE	DATE	DATE

CAD USER: and A. Chappaz File: E:\M\ASBESTWORK\BATCHES\3049.dwg Plot Scale: 1:1 Plot Date: 05/20/23 10:38 PM

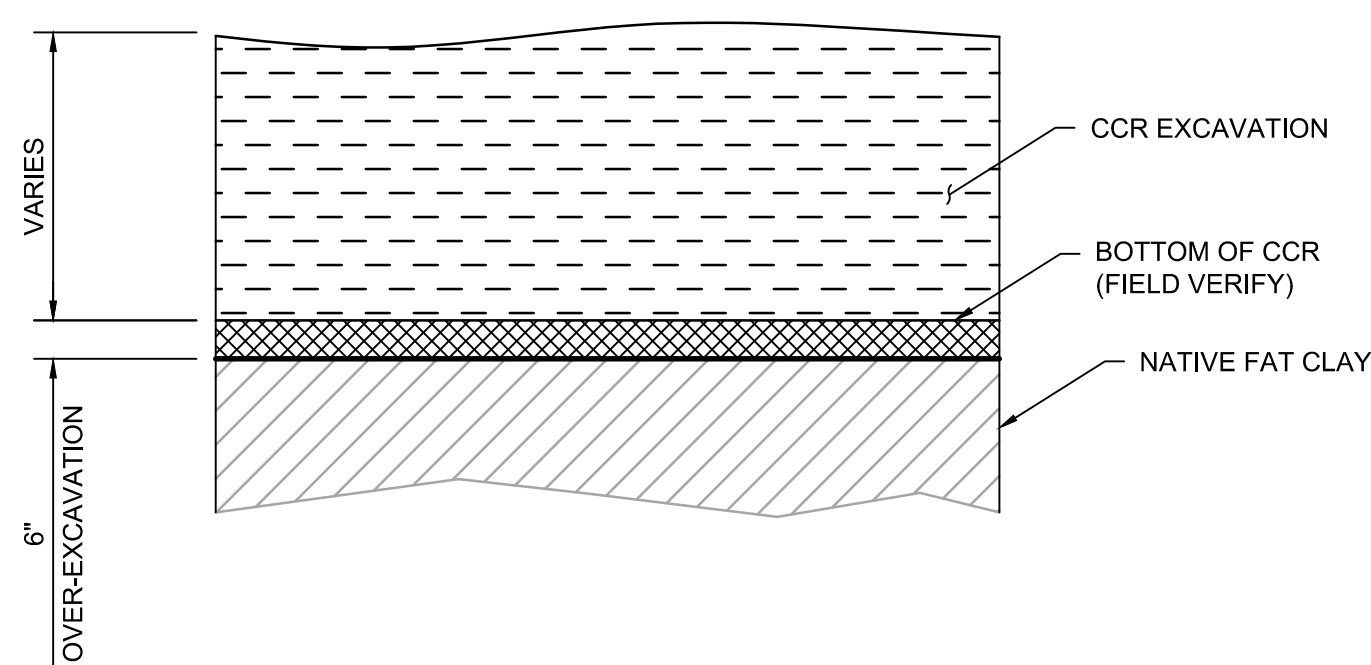

1 **DETAIL: BASIN EXCAVATION (TYP.)**
3047,3049 NOT TO SCALE

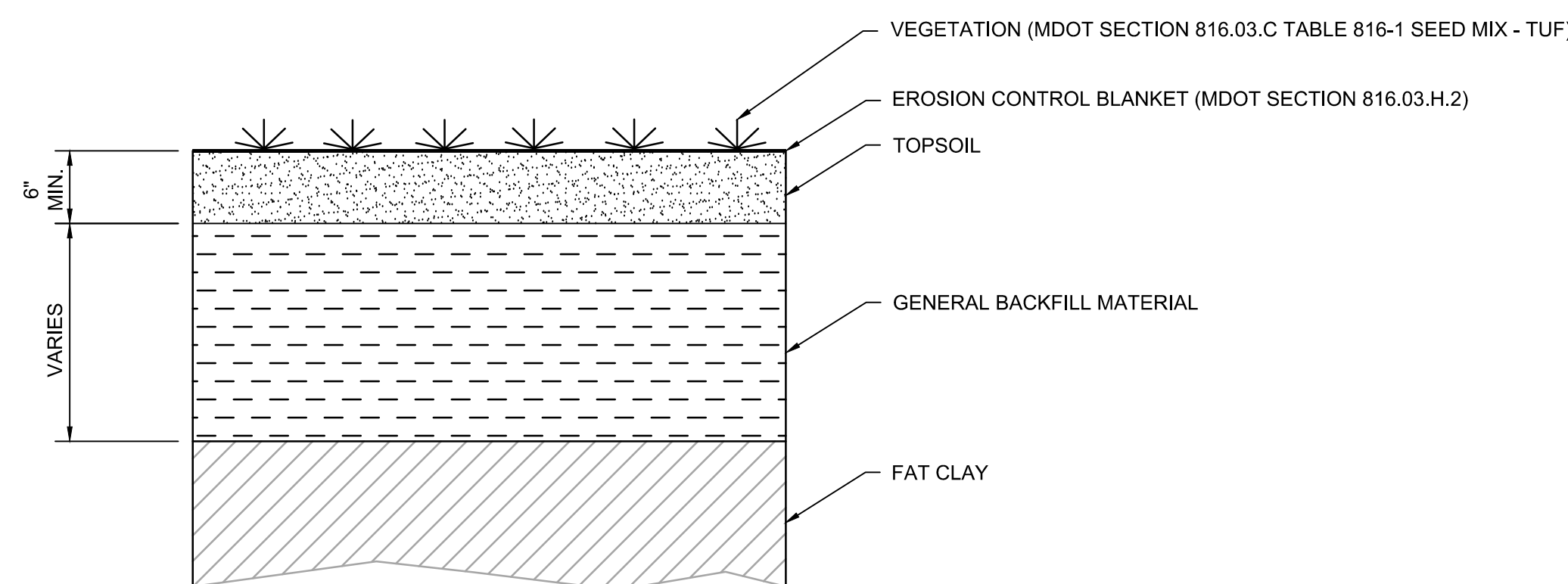

2 **DETAIL: BASIN BACKFILL (TYP.)**
3048,3049 NOT TO SCALE

- NOTES:**
1. ESTABLISH TURF IN ACCORDANCE WITH MDOT SECTION 816 TURF ESTABLISHMENT.
 2. CONTRACTOR SHALL BE RESPONSIBLE FOR ESTABLISHING VEGETATION; CONTRACT SHALL NOT BE CONSIDERED COMPLETE UNTIL VEGETATION HAS BEEN ESTABLISHED.

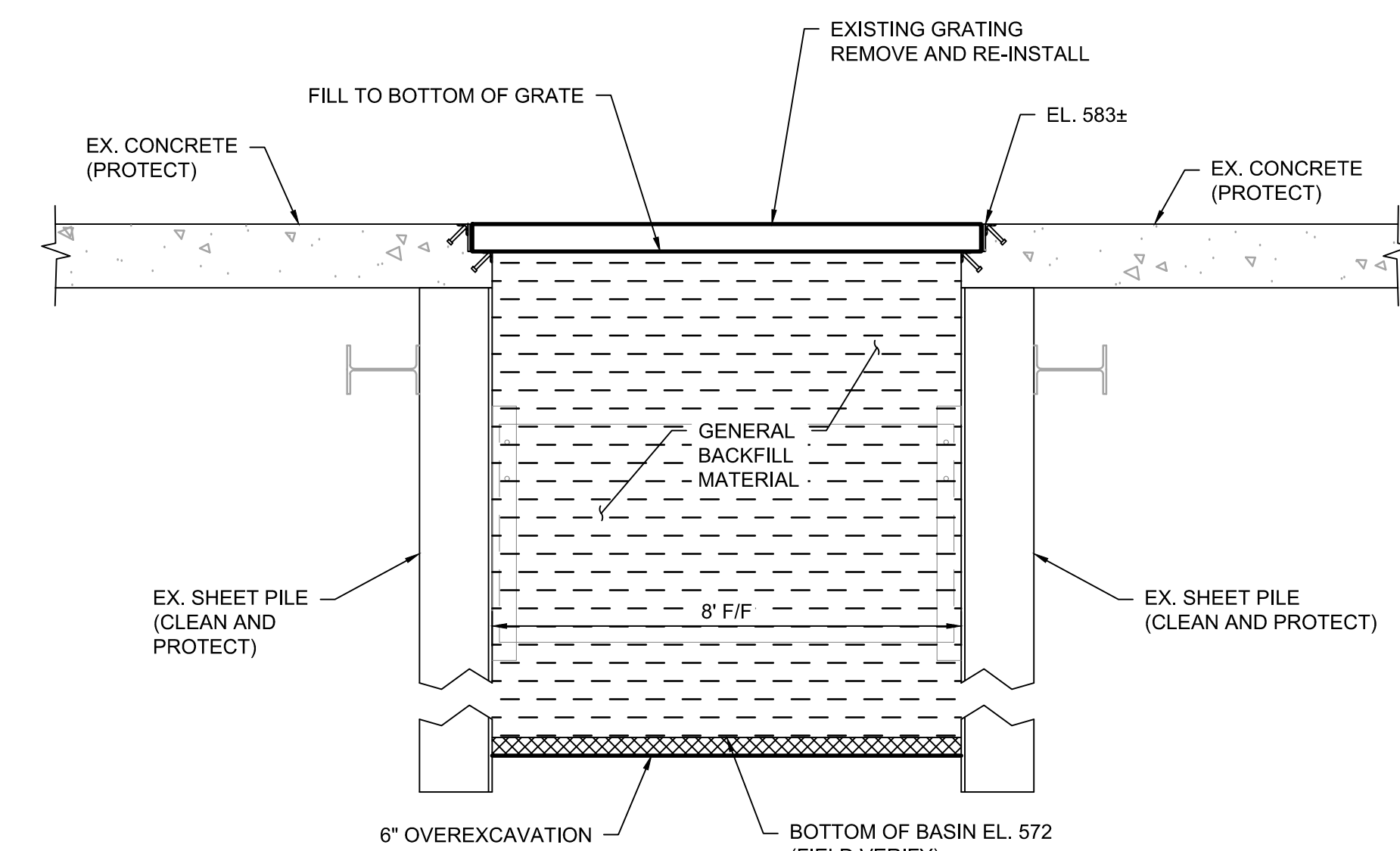

3 **DETAIL: EXISTING CONNECTING CHANNEL BACKFILL (TYP.)**
3048 NOT TO SCALE

- NOTES:**
1. REMOVE AND REPLACE STRUTS AS NECESSARY TO PERFORM THE EXCAVATION AND BACKFILL WORK.

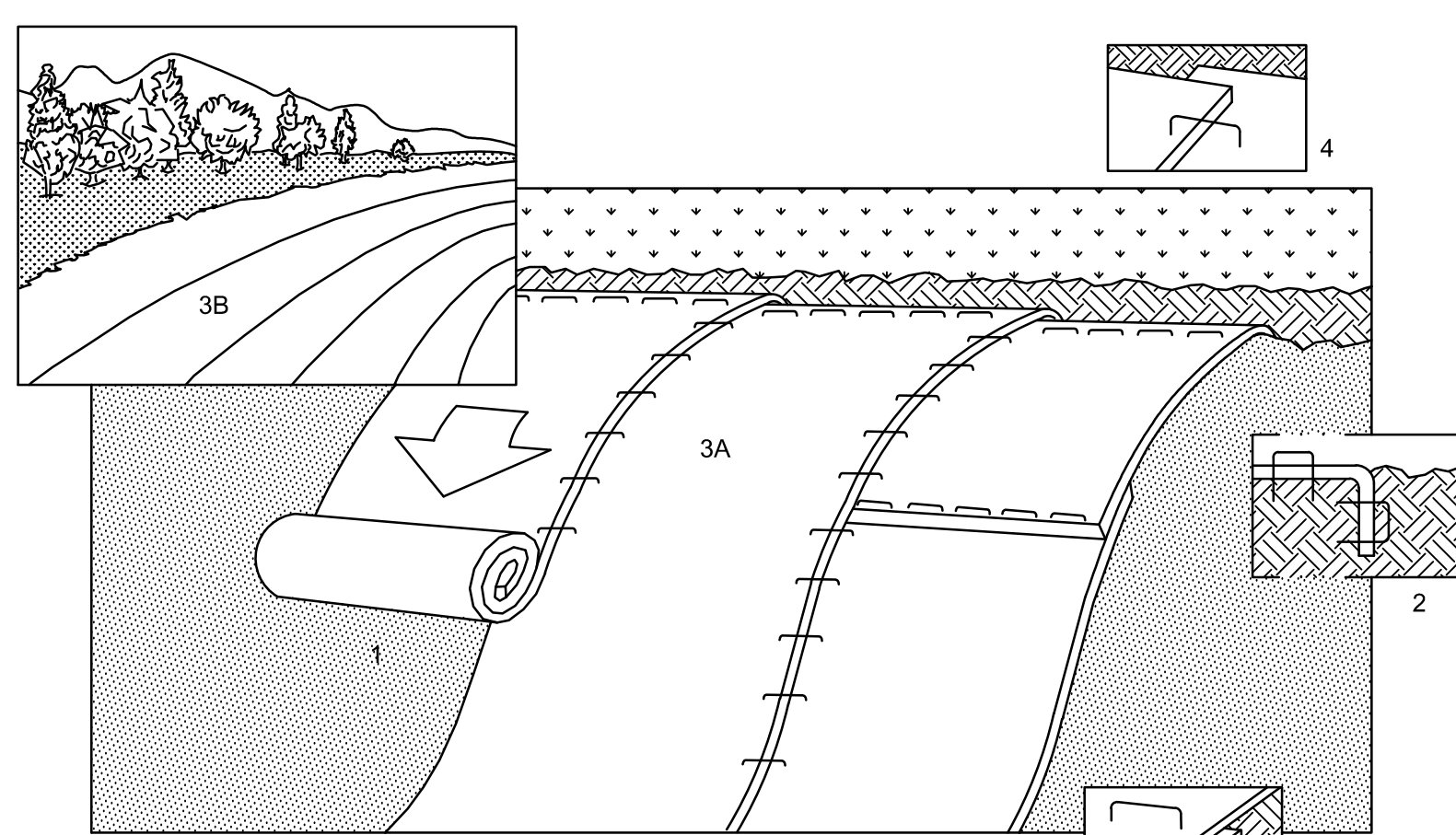

4 **DETAIL: EROSION CONTROL MULCH BLANKET**
NOT TO SCALE

- EROSION CONTROL MULCH BLANKET NOTES:**
1. INSTALL EROSION CONTROL BLANKET ON ALL TOPSOILED AREAS.
 2. PREPARE SOIL BEFORE INSTALLING BLANKETS, INCLUDING APPLICATION OF SEED.
 3. BEGIN AT THE TOP OF THE SLOPE BY ANCHORING THE BLANKET IN 8" DEEP X 6" WIDE TRENCH, BACKFILL AND COMPACT THE TRENCH AFTER STAPLING.
 4. ROLL THE BLANKETS (A.) DOWN OR (B.) HORIZONTALLY ACROSS THE SLOPE.
 5. THE EDGES OF PARALLEL BLANKETS MUST BE STAPLED WITH APPROXIMATELY 2' OVERLAP.
 6. WHEN BLANKETS MUST BE SPLICED DOWN THE SLOPE, PLACE BLANKETS END OVER END (SHINGLE STYLE) WITH APPROXIMATELY 4' OVERLAP. STAPLE THROUGH OVERLAPPED AREA APPROXIMATELY 12" APART.

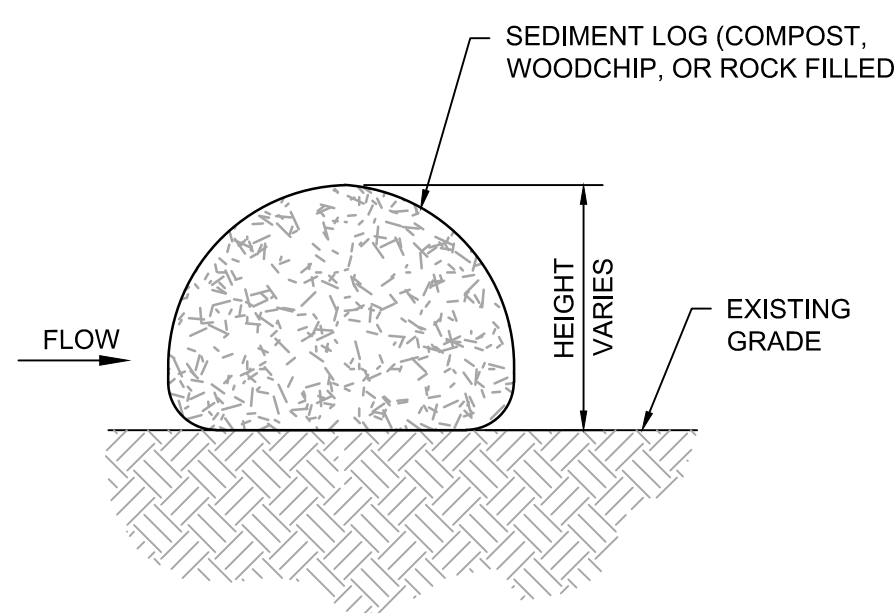

- NOTES:**
1. STAKE FREE SEDIMENT LOG TO BE USED IN AREAS THAT ARE RELATIVELY FLAT AND SHOULD BE INSTALLED ALONG CONTOURS (CONSTANT ELEVATION).
 2. NO GAPS SHALL BE PRESENT UNDER SEDIMENT LOG. PREPARE AREA AS NEEDED TO SMOOTH SURFACE OR REMOVE DEBRIS.
 3. ACCUMULATED SEDIMENT SHALL BE REMOVED WHEN REACHING 1/2 OF LOG HEIGHT.
 4. SEDIMENT LOG SHALL BE MAINTAINED THROUGHOUT THE CONSTRUCTION PERIOD AND REPAIRED OR REPLACED AS REQUIRED.

5 **DETAIL: SEDIMENT LOG - STAKE FREE**
NOT TO SCALE

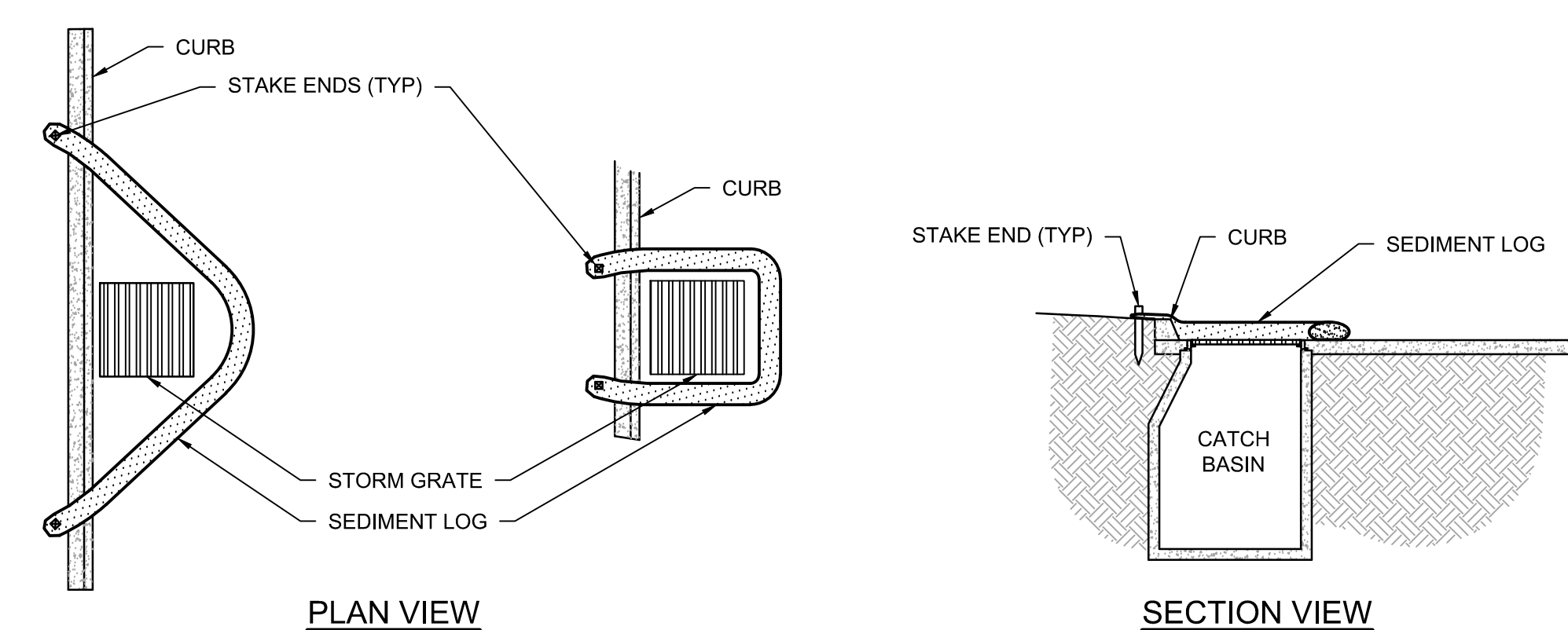

- NOTES:**
1. INLET PROTECTION SHALL BE INSTALLED PRIOR TO ANY GRADING WORK IN THE AREA TO BE PROTECTED OR IMMEDIATELY FOLLOWING CATCHBASIN INSTALLATION, AND SHALL BE MAINTAINED THROUGHOUT THE CONSTRUCTION PERIOD.
 2. MATERIALS SHALL BE SUFFICIENT TO ALLOW FLOW WHILE BLOCKING SEDIMENT. NO HOLES OR GAPS SHALL BE PRESENT IN UNDER SEDIMENT LOG.
 3. INLET PROTECTION SHALL BE CLEANED AS REQUIRED.
 4. MATERIALS AND ANY ACCUMULATED SEDIMENT SHALL BE REMOVED IN CONJUNCTION WITH THE FINAL GRADING AND SITE STABILIZATION.

6 **DETAIL: INLET PROTECTION - SEDIMENT LOG**
NOT TO SCALE

0516-C-3051
LATEST REVISION

6	05JUN23	AS-BUILT		R. CHRISTENSEN
5	01FEB22	CONSTRUCTION	S. MASTERS	R. CHRISTENSEN
4	14JAN22	90% DESIGN REVIEW	S. MASTERS	R. CHRISTENSEN
3	20DEC21	60% DESIGN REVIEW	S. MASTERS	R. CHRISTENSEN
2	29OCT21	50% DESIGN REVIEW	S. MASTERS	R. CHRISTENSEN
1	29OCT21	60% DESIGN REVIEW	S. MASTERS	R. CHRISTENSEN

NO. DATE ISSUED FOR PROJ. ENG. RESP. ENG.
PROJECT ENGINEER: S. MASTERS APPROVALS
PRECONSTRUCTION REVISION BLOCK - REV. 0

Vendor:
BARR BARR ENGINEERING CO.
3005 BENTONVILLE STREET
SUITE 100
ANNANDALE, VA 41108
PH: (703) 221-0111
WWW.BARR-ENG.COM

DTE
TITLE

**BOTTOM ASH BASIN CLOSURE
GENERAL DETAILS**

LOCATION NAME: ST. CLAIR COUNTY POWER PLANT UNIT NUMBER
ORIGINATING SOURCE: BARR ENGINEERING CO. SCALE: AS SHOWN USE DIMENSIONS DO NOT SCALE

DTE ENGINEERING COMPANY DRAWING NUMBER: 0516-C-3051
DATE: 05JUN23 OPERATOR: JAMG

C	PROLOGS.	FIS GEN TECH DRG	CIVIL	B	PROLOGS.	FIS GEN TECH DRG	CIVIL	A	PROLOGS.	FIS GEN TECH DRG	CIVIL
MADE BY	DATE	INC	ELECT.	MADE BY	DATE	INC	ELECT.	MADE BY	DATE	INC	ELECT.
CHK BY	DATE	MECH.	APPROVED BY	CHK BY	DATE	MECH.	APPROVED BY	CHK BY	DATE	MECH.	APPROVED BY

DATE	OTHER APPROVALS	DATE	DESIGNED BY	DATE
	FOR GEN TECH DRG		S. HILCOXMAN	21OCT21
	FOR GEN PLANT ENG		J. METTLACH	26OCT21
	DIST OPR		R. CHRISTENSEN	29OCT21
	PROJECT ENG.		R. CHRISTENSEN	01FEB22
	PROJECT MGR			

DESIGN FILE NAME: 0516-C-3051.dwg
DATE: 05JUN23 OPERATOR: JAMG

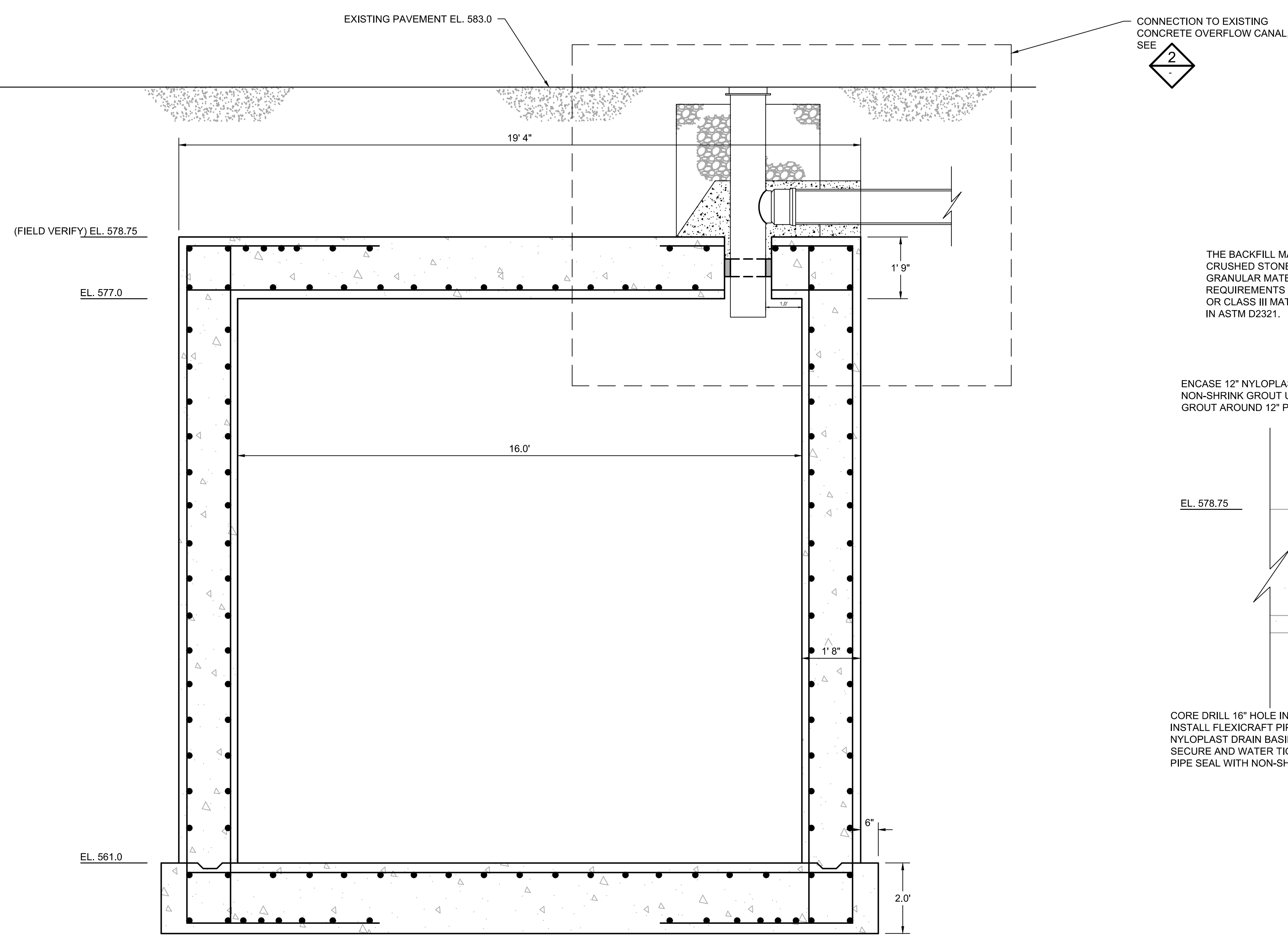

1 SECTION: EXISTING CONCRETE OVERFLOW CANAL
SCALE IN FEET

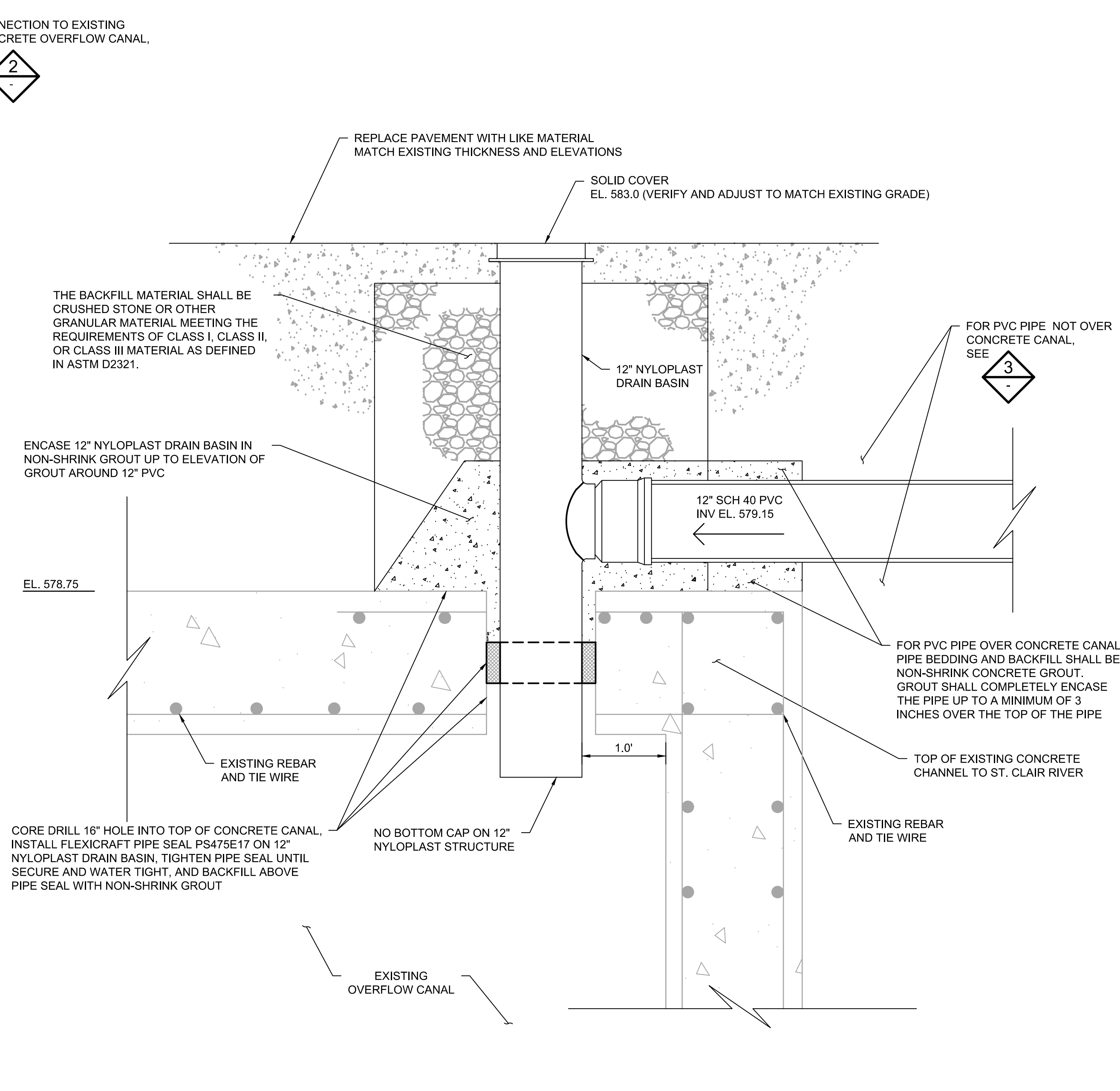

2 DETAIL: NYLOPLAST CONNECTION TO EXISTING CONCRETE OVERFLOW CANAL
SCALE IN FEET

PIPE DIAM. INCHES	MIN. TRENCH WIDTH INCHES
12	30
15	34
18	39
24	48
30	56
36	64
42	72
48	80

- NOTES:
1. ALL PIPE SYSTEMS SHALL BE INSTALLED IN ACCORDANCE WITH ASTM D2321, "STANDARD PRACTICE FOR UNDERGROUND INSTALLATION OF THERMOPLASTIC PIPE FOR SEWERS AND OTHER GRAVITY FLOW APPLICATIONS", LATEST ADDITION.
 2. MEASURES SHOULD BE TAKEN TO PREVENT MIGRATION OF NATIVE FINES INTO BACKFILL MATERIAL, WHEN REQUIRED.
 3. FOUNDATION: WHERE THE TRENCH BOTTOM IS UNSTABLE, THE CONTRACTOR SHALL EXCAVATE TO A DEPTH REQUIRED BY THE ENGINEER AND REPLACE WITH SUITABLE MATERIAL AS SPECIFIED BY THE ENGINEER, AS AN ALTERNATIVE AND AT THE DISCRETION OF THE DESIGN ENGINEER, THE TRENCH BOTTOM MAY BE STABILIZED USING A GEOTEXTILE MATERIAL.
 4. MAINTAIN A DRY TRENCH WHEN BACKFILLING AROUND THE PIPE. MECHANICALLY COMPACT IN ACCORDANCE WITH DTE SPECIFICATION 317.

3 DETAIL: PVC PIPE TRENCH
NOT TO SCALE

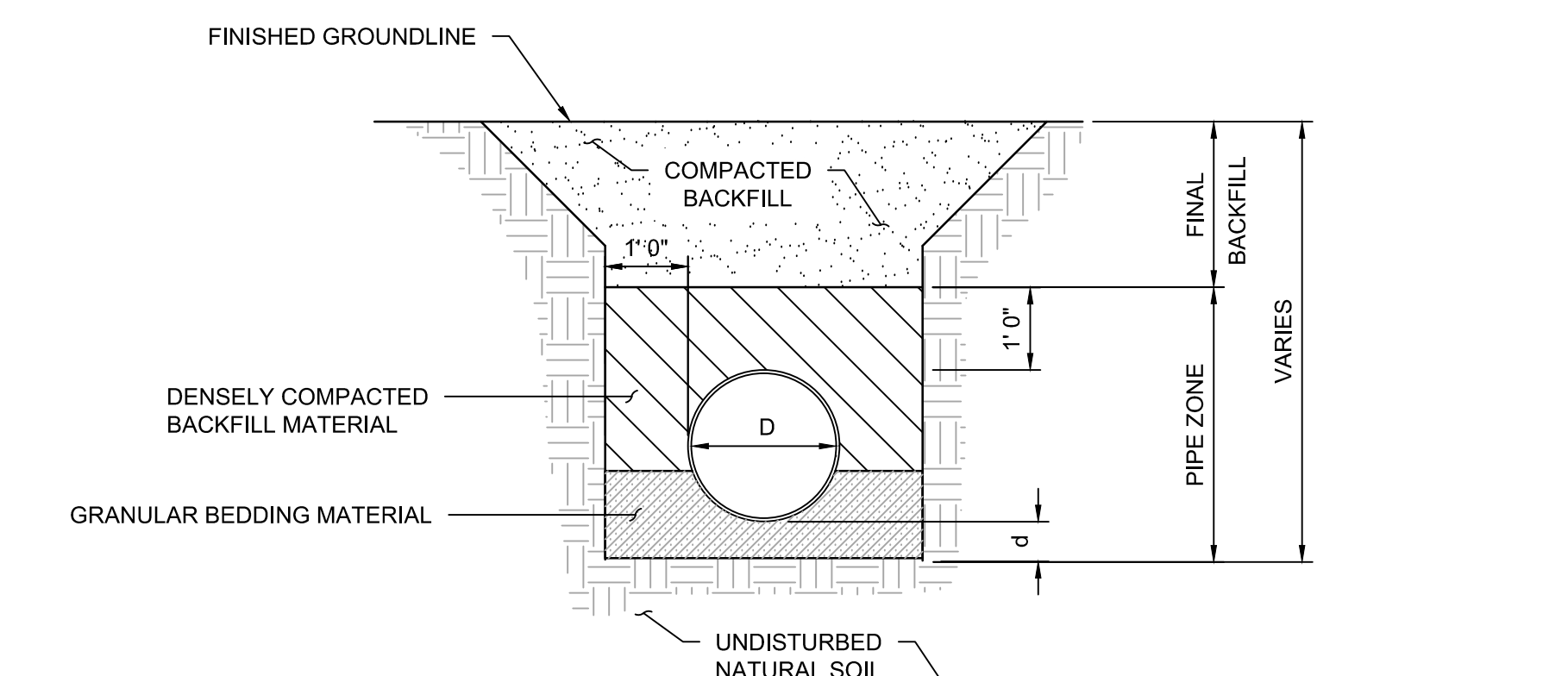

DEPTH OF BEDDING BELOW PIPE	
d	d (MIN.)
27" & LESS	3"
30" TO 60"	4"
66" & LARGER	6"

NOTE: SHAPED SUBGRADE WITH GRANULAR FOUNDATION ALSO PERMITTED

4 DETAIL: RCP STORM SEWER TRENCH
NOT TO SCALE

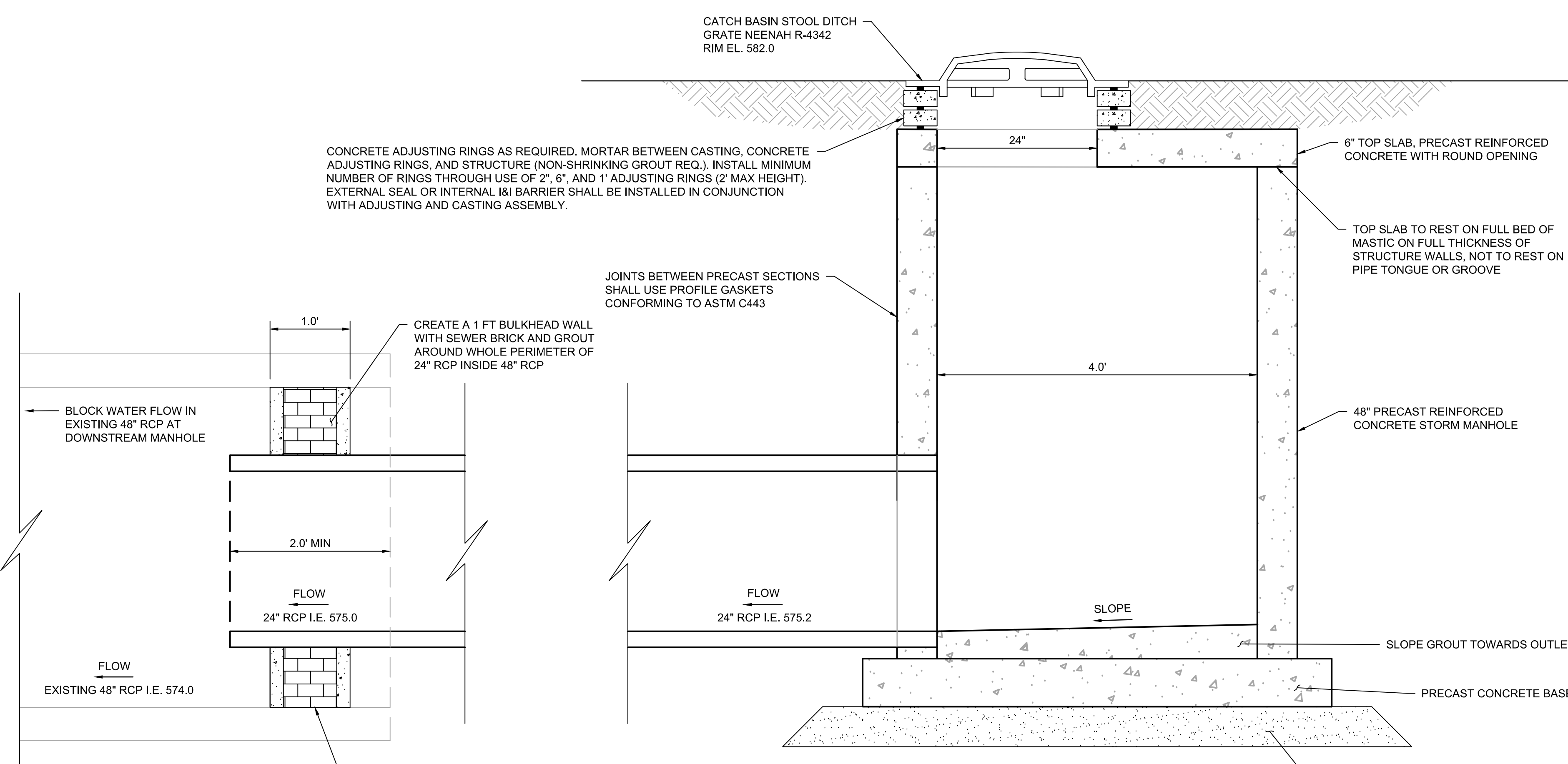

5 SECTION: STORM MANHOLE SIDE VIEW
SCALE IN FEET

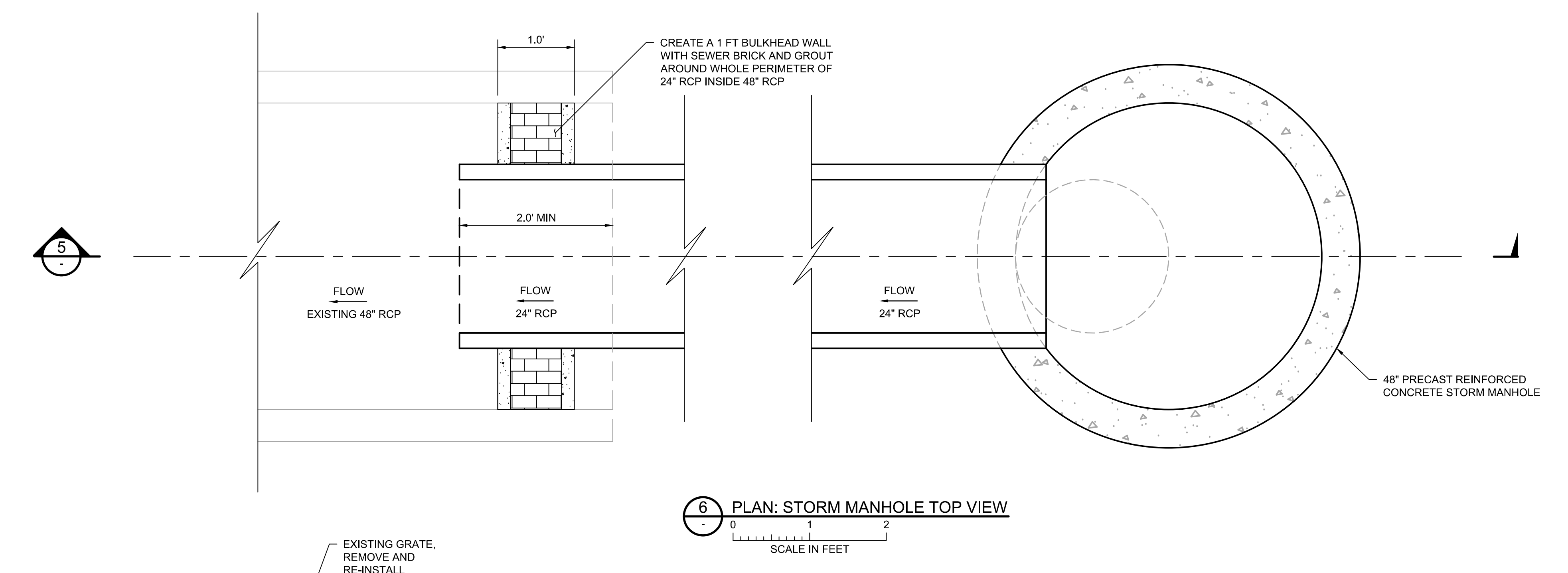

6 PLAN: STORM MANHOLE TOP VIEW
SCALE IN FEET

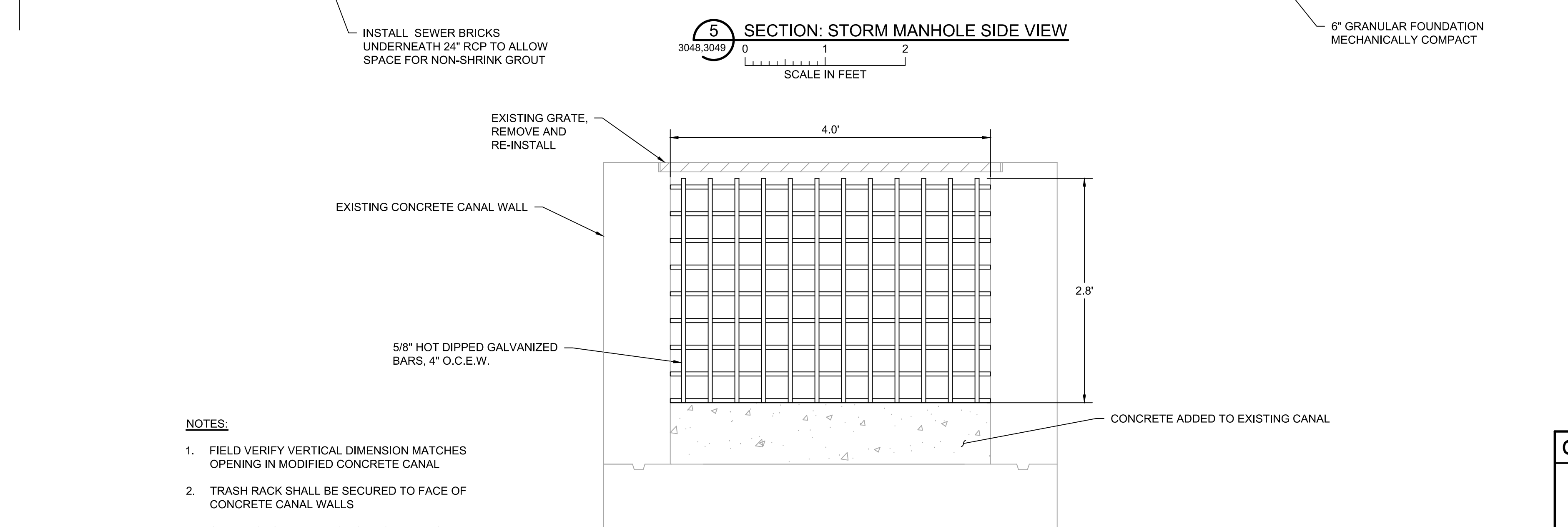

7 DETAIL: CUSTOM TRASH RACK
NOT TO SCALE

- NOTES:
1. FIELD VERIFY VERTICAL DIMENSION MATCHES OPENING IN MODIFIED CONCRETE CANAL.
 2. TRASH RACK SHALL BE SECURED TO FACE OF CONCRETE CANAL WALLS.
 3. SUBMIT SHOP DRAWING TO ENGINEER FOR APPROVAL.

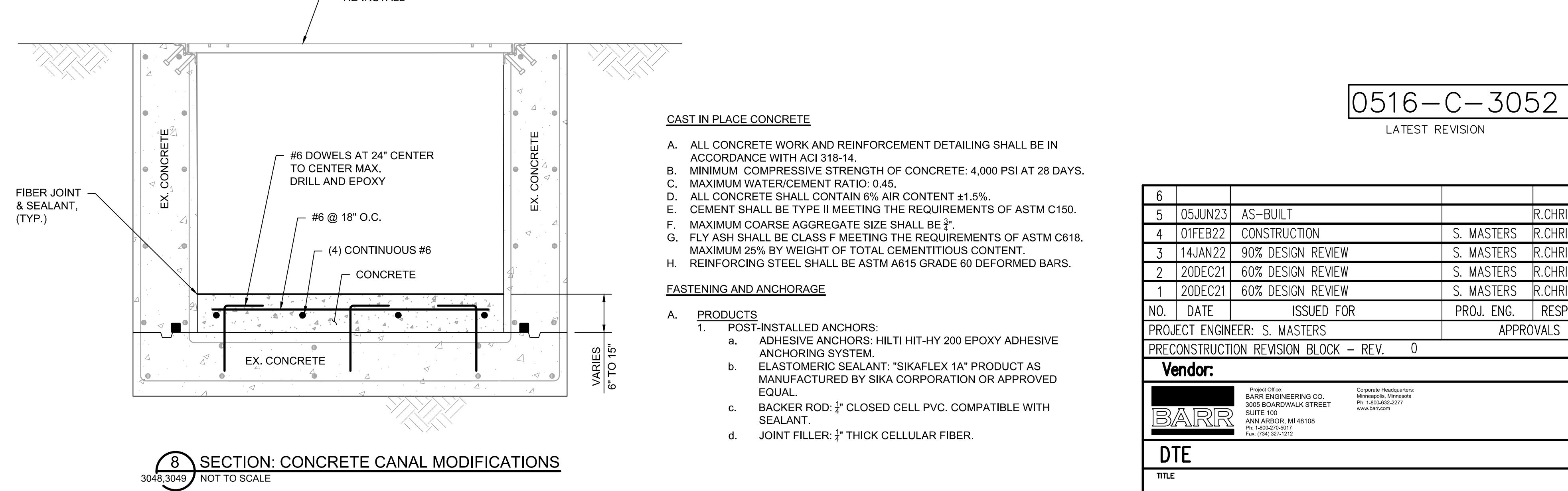

8 SECTION: CONCRETE CANAL MODIFICATIONS
NOT TO SCALE

0516-C-3052
LATEST REVISION

NO.	DATE	ISSUED FOR	PROJ. ENGR.	RESP. ENG.
6	05JUN23	AS-BUILT	S. MASTERS	R. CHRISTENSEN
5	07FEB22	CONSTRUCTION	S. MASTERS	R. CHRISTENSEN
4	14JAN22	80% DESIGN REVIEW	S. MASTERS	R. CHRISTENSEN
3	20DEC21	60% DESIGN REVIEW	S. MASTERS	R. CHRISTENSEN
2	20DEC21	60% DESIGN REVIEW	S. MASTERS	R. CHRISTENSEN
1	20DEC21	60% DESIGN REVIEW	S. MASTERS	R. CHRISTENSEN

NO.	DATE	ISSUED FOR	PROJ. ENGR.	RESP. ENG.
PROJECT ENGINEER: S. MASTERS				
PRECONSTRUCTION REVISION BLOCK - REV. 0				
APPROVALS				
Vendor: BARR ENGINEERING CO.				
DTE				

DESIGNED BY: S. MASTERS
 DATE: 05JUN23
 DRAWN BY: S. MASTERS
 DATE: 05JUN23
 CHECKED BY: R. CHRISTENSEN
 DATE: 05JUN23
 PROJECT ENGINEER: S. MASTERS
 DATE: 05JUN23
 PROJECT MANAGER: R. CHRISTENSEN
 DATE: 05JUN23

PROJ. ENG.	DESIGNER	CHECKER	DATE	PROJ. ENG.	DESIGNER	CHECKER	DATE	PROJ. ENG.	DESIGNER	CHECKER	DATE

ST. CLAIR COUNTY POWER PLANT
 BOTTOM ASH BASIN CLOSURE
 STORMWATER SECTIONS AND DETAILS
 SCALE: AS SHOWN
 DATE: 05JUN23
 OPERATOR: JAMG

TECHNICAL SPECIFICATIONS:

1. **SUMMARY OF WORK**
 - A. SEE ERECTION SPECIFICATION DIVISION 01 - GENERAL REQUIREMENTS SECTION 011100 - SUMMARY OF WORK.
2. **SUBMITTALS**
 - A. SEE ERECTION SPECIFICATION DIVISION 01 - GENERAL REQUIREMENTS SECTION 013300 - SUBMITTALS.
 - B. SUBMIT PRODUCT INFORMATION AND SOURCE IDENTIFICATION FOR ALL MATERIALS.
 - C. CONSTRUCTION SURVEYS DOCUMENTING THE WORK.
 - D. SUBMIT AN EARTHWORK EXECUTION PLAN FOR ENGINEER AND OWNER APPROVAL THAT DESCRIBES EARTHWORK PROCEDURES AND EQUIPMENT TO BE USED TO SAFELY EXCAVATE CCR MATERIALS AND ESTABLISH FINISHED GRADES.
3. **SAFETY**
 - A. CONTRACTOR IS RESPONSIBLE FOR JOBSITE CONDITIONS AND SAFETY PROCEDURES AND PROGRAMS, INCLUDING SAFETY AND HEALTH OF ALL PERSONS AND PROPERTY, ON THOSE PORTIONS OF THE SITE AFFECTED BY OR USED BY CONTRACTOR, CONTRACTOR'S EMPLOYEES, SUBCONTRACTORS, AGENTS, AND OTHERS DURING PERFORMANCE OF THE WORK.
 - B. FURNISH EMPLOYEES, SUBCONTRACTORS, SUPPLIERS AND VISITORS WITH ALL SAFETY EQUIPMENT AND OTHER PROTECTION DEVICES NEEDED TO COMPLY WITH LAWS AND REGULATIONS AND ACCEPTED SAFETY PRACTICES.
 - C. HOLD REGULAR SAFETY MEETINGS WITH ALL EMPLOYEES THAT WILL BE WORKING ON THE JOBSITE. THESE MEETINGS CAN BE AT THE START OF A SHIFT AND SHOULD COVER VARIOUS RELEVANT SAFETY ISSUES THAT PERTAIN TO THE WORK BEING DONE. MAINTAIN A LIST OF EMPLOYEE ATTENDANCE AND PROVIDE THIS LIST TO OWNER IF REQUESTED.
 - D. MAKE ALL PERSONS ON THE SITE FAMILIAR WITH THE SAFETY PRECAUTIONS APPROPRIATE TO THE CONSTRUCTION ZONES AND REFUSE ENTRY BY ANY PERSON NOT AUTHORIZED BY OWNER.
 - E. CONTRACTOR IS RESPONSIBLE FOR ANY SAFETY VIOLATION AND/OR FINE THAT MAY OCCUR BECAUSE OF ANY NEGLIGENCE BY CONTRACTOR, CONTRACTOR'S EMPLOYEES, CONTRACTOR'S SUBCONTRACTORS, OR ANY THIRD PARTY UNDER CONTRACTOR'S SUPERVISION OR DIRECTION.
 - F. PROVIDE SAFE ACCESS TO ALL PORTIONS OF THE WORK FOR USE BY OWNER, ENGINEER AND REGULATORY ENTITIES HAVING JURISDICTION IN THE PERFORMANCE OF THEIR OBSERVATION DUTIES. SAFE ACCESS SHALL CONFORM TO APPLICABLE LAWS AND REGULATIONS AND TO ALL REQUIREMENTS OF ANY REGULATORY AGENCY OR ENTITIES WHO CLAIM JURISDICTION OVER THE SAFETY OF THE PROJECT AREA. IF OWNER IS UNABLE TO OBSERVE CONTRACTOR'S WORK, DUE TO CONDITIONS, WHICH IN THE OPINION OF OWNER ARE UNSAFE, OWNER'S PAYMENT FOR SUCH WORK MAY BE WITHHELD UNTIL WORK HAS BEEN DETERMINED TO BE IN COMPLIANCE WITH THE CONTRACT DOCUMENTS.
 - G. CONTRACTOR SHALL IMPLEMENT EXCAVATION PROCEDURES THAT MEET CURRENT OSHA AND MIOSHA REGULATIONS.
 - H. CONTRACTOR SHALL IMMEDIATELY REPORT TO OWNER ANY ACCIDENT OR INJURY TO PERSONNEL OR PROPERTY DAMAGE THAT MAY OCCUR. ANY DAMAGE TO EXISTING STRUCTURES BY CONTRACTOR SHALL BE REPAIRED PROMPTLY BY CONTRACTOR AT NO COST TO OWNER.
 - I. CONTRACTOR WILL ADHERE TO ALL OTE SAFETY STANDARDS. IN THE ABSENCE OF A OTE SAFETY STANDARD, THE CONTRACTOR SHALL ADHERE TO THE MOST STRINGENT OSH/MIOSHA RULE(S).
 - J. SEE ERECTION SPECIFICATION FOR ADDITIONAL SAFETY REQUIREMENTS.
4. **QUALITY REQUIREMENTS**
 - A. QUALITY-CONTROL SERVICES INCLUDE INSPECTIONS, TESTS, AND RELATED ACTIONS, INCLUDING REPORTS PERFORMED BY CONTRACTOR, BY OWNER, BY INDEPENDENT AGENCIES, AND BY GOVERNING AUTHORITIES.
 - B. SUBMIT A LIST OF THE QUALIFIED TESTING AND SURVEY COMPANIES THAT WILL BE UTILIZED ON THE PROJECT.
 - C. SUBMIT ONE ELECTRONIC COPY OF TESTING, SURVEYING, AND INSPECTION RECORDS SPECIFIED TO THE ENGINEER OF RECORD (EOR).
 - D. THE ENGINEER WILL REVIEW THE TESTING, SURVEYING, AND INSPECTION RECORDS TO CHECK CONFORMANCE WITH THE DRAWINGS AND SPECIFICATIONS. REVIEW DOES NOT RELIEVE THE CONTRACTOR FROM THE RESPONSIBILITY FOR CORRECTING NONCOMPLIANT WORK.
 - E. COORDINATE WITH ENGINEER AND OWNER TO OBTAIN CLARIFICATION OF CONTRACT DOCUMENTS, SPECIFICATIONS AND TESTING CRITERIA WHEN NECESSARY.
 - F. COORDINATE WITH ENGINEER AND OWNER TO OBSERVE ALL SAMPLING AND TESTING ACTIVITIES.
 - G. RETESTING AND RESURVEYING. CONTRACTOR IS RESPONSIBLE FOR RETESTING AND RESURVEYING WHERE RESULTS OF INSPECTIONS, TESTS, CERTIFICATION SURVEYS, OR OTHER QUALITY-CONTROL SERVICES PROVE UNSATISFACTORY AND INDICATE NONCOMPLIANCE WITH CONTRACT DOCUMENT REQUIREMENTS, REGARDLESS OF WHETHER THE ORIGINAL TEST, INSPECTION, OR SURVEY WAS CONTRACTOR'S RESPONSIBILITY.
 - H. SEE ERECTION SPECIFICATION DIVISION 31 - EARTHWORK SECTION 312000 - EARTHWORK, TRANSPORTATION, AND DEPOSITION PART 1, GENERAL 1.03 QUALITY ASSURANCE FOR ADDITIONAL QUALITY ASSURANCE REQUIREMENTS.
5. **OWNER OPERATIONS**
 - A. COORDINATE ALL WORK WITH OWNER OPERATIONS.
6. **CONTROL OF WATER**
 - A. FURNISH ALL LABOR, EQUIPMENT, MATERIALS, AND PERFORM ALL OPERATIONS NECESSARY TO CONTROL WATER IN THE WORK AREAS, INCLUDING THE PROVISION, OPERATION AND MAINTENANCE OF PUMPS AND/OR DEWATERING SYSTEMS ALONG WITH ANY TEMPORARY PIPING OR CHANNELS NECESSARY TO ALLOW THE PROPER EXECUTION OF THE WORK.
 - B. PRIOR TO DEMOBILIZING FROM THE SITE, RESTORE ANY AREAS AFFECTED BY WATER CONTROL ACTIVITIES TO A CONDITION EQUAL TO OR BETTER THAN THE CONDITION PRIOR TO CONSTRUCTION.
 - C. CARRY OUT THE CONTROL OF WATER IN COMPLIANCE WITH ALL FEDERAL, STATE AND LOCAL APPLICABLE DISCHARGE AND POLLUTION REQUIREMENTS.
 - D. SEE ERECTION SPECIFICATION DIVISION 31 - EARTHWORK SECTION 312319 - DEWATERING, AND ADDITIONAL ERECTION SPECIFICATION DEWATERING REQUIREMENTS INCLUDING DEWATERING PLAN PREPARATION AND SUBMITTAL.
7. **SITE PREPARATION**
 - A. LOCATE ALL UTILITIES PRIOR TO ANY EXCAVATION WORK. CONTRACTOR MUST REVIEW YARD MAPS AND CONFIRM LOCATION WITH GPR PRIOR TO WORK. THIS MAY INCLUDE SUBCONTRACTING A PRIVATE UTILITY LOCATE COMPANY.
 - B. COORDINATE REMOVALS, RELOCATIONS, OR REPLACEMENTS OF EXISTING UTILITIES THAT CONFLICT WITH THE WORK.
8. **GENERAL**
 - A. GENERAL SOIL CONDITIONS IN THE WORK AREA INCLUDE NATIVE CLAY MATERIALS AND CCR WASTE MATERIAL.
 - B. PERFORM ALL EXCAVATION, BACKFILLING AND COMPACTION REQUIRED TO ACHIEVE FINAL GRADES SHOWN ON DRAWINGS.
 - C. MICHIGAN DEPARTMENT OF TRANSPORTATION STANDARD SPECIFICATIONS FOR CONSTRUCTION, 2012 EDITION, HEREAFTER REFERRED TO AS MDOT STANDARD SPECIFICATIONS ARE APPLICABLE UNLESS NOTED OTHERWISE.
 - D. PROTECT ALL MONITORING WELLS AND SURVEY MONUMENTS FROM DAMAGE. CONTRACTOR SHALL COVER ALL COSTS INCURRED TO FULLY REPAIR OR REPLACE DAMAGED SURVEY MONUMENTS AND WELLS TO OWNER'S SATISFACTION AND WITH SCHEDULE REQUESTED BY OWNER.
 - E. EXECUTE WORK IN COMPLIANCE WITH DRAWINGS AND ERECTION SPECIFICATION WHETHER OR NOT REQUIREMENTS ON DRAWINGS OR IN ERECTION SPECIFICATIONS ARE SPECIFICALLY HIGHLIGHTED.
9. **PRODUCTS**
 - A. COMMON FILL (BAB BACKFILLING): SEE ERECTION SPECIFICATION DIVISION 31 - EARTHWORK SECTION 312000 - EARTHWORK, TRANSPORTATION, AND DEPOSITION FOR COMMON FILL SPECIFICATION. B. TOPSOIL SHALL MEET MDOT STANDARD SPECIFICATIONS SECTION 917.07.
10. **EXECUTION**
 - A. COORDINATE REMOVALS, RELOCATIONS, OR REPLACEMENTS OF EXISTING UTILITIES THAT CONFLICT WITH THE WORK.
 - B. PROTECT EXISTING FACILITIES FROM DAMAGE CREATED BY EARTHWORK OPERATIONS.
 - C. ALIGN, FILL, AND GRADE FILL MATERIALS IN ACCORDANCE WITH THE DRAWINGS AND ERECTION SPECIFICATIONS.
 - D. VERTICAL AND HORIZONTAL TOLERANCES FOR GRADING (RELATIVE TO GRADES SHOWN ON THE DRAWINGS) SHALL BE AS FOLLOWS:
 - a. VERTICAL: +0.2/-0.1 FEET
 - b. HORIZONTAL: +/- 1.0 FEET
 - c. MATERIAL LAYER THICKNESS: +0.2 FEET, -0.0 FEET
 - d. ANY CHANGES TO GRADE IN ANY AREA MUST BE APPROVED BY ENGINEER.
 - E. WHERE BACKFILL IS PLACED, LAYER OF SOIL MATERIAL MAY REQUIRE MOISTURE CONDITIONING BEFORE COMPACTION. UNIFORMLY APPLY WATER TO SURFACE OF BACKFILL OR LAYER OF SOIL TO PREVENT FREE WATER APPEARING ON SURFACE DURING OR SUBSEQUENT TO COMPACTION OPERATIONS. THOROUGHLY MIX TO DISTRIBUTE ADDED WATER. BACKFILL SHALL BE PLACED IN ACCORDANCE WITH SECTION 0312000 OF THE ERECTION SPECIFICATIONS.
 - F. REMOVE AND REPLACE SOIL MATERIAL THAT IS TOO WET TO PERMIT COMPACTION AS SPECIFIED.
 - G. PERFORM APPROPRIATE DUST CONTROL DURING EARTHWORK ACTIVITIES. KEEP THE SURFACE OF ANY AND ALL CONSTRUCTION WORK AREAS AND HAUL ROADS MOIST BY SPRAYING WITH UNCONTAMINATED WATER SO AS TO PREVENT, NOT JUST REDUCE, AIRBORNE DUST. THIS RESPONSIBILITY SHALL REQUIRE CONTRACTOR TO SUSPEND CONSTRUCTION OR HAUL TRAFFIC UNTIL SUCH TIME AS CONTRACTOR CAN AND DOES PREVENT AIRBORNE DUST. CONTRACTOR SHALL NOT OVERSPRAY SO AS TO CREATE PROBLEMS, SUCH AS TRACKING OF MATERIAL ONTO PAVED SURFACES OR MUDDY HAUL ROADS, DUE TO THE APPLICATION OF EXCESS MOISTURE.
 - H. FINAL GRADING SHALL MEET MDOT STANDARD SPECIFICATION SECTION 205.03.N.
11. **TESTING AND CLEAN CLOSURE VERIFICATION**
 - A. TESTING SHALL BE PERFORMED BY AN APPROVED INDEPENDENT TESTING AGENCY.
 - B. SCOPE OF WORK IS NOT SATISFIED UNTIL THE EOR ACCEPTS REMOVAL BASED ON VISUAL VERIFICATION THAT ALL CCR HAS BEEN REMOVED.
12. **EROSION AND SEDIMENT CONTROL**
 - A. INSTALL ADEQUATE MEANS TO CONTROL SOIL EROSION IN PROJECT SITE.
 - B. WASHOUTS AND ALL EROSION IN PROJECT AREA ARE CONTRACTORS RESPONSIBILITY TO REPAIR AT NO ADDITIONAL COST TO OWNER.
13. **SITE RESTORATION**
 - A. PRIOR TO DEMOBILIZATION FROM SITE, RESTORE ANY AREAS IMPACTED BY CONSTRUCTION ACTIVITIES TO A CONDITION EQUAL TO OR BETTER THAN THE CONDITION PRIOR TO CONSTRUCTION.

0516-C-3053
LATEST REVISION

NO.	DATE	ISSUED FOR	PROJ. ENG.	RESP. ENG.
5	05JUN23	AS-BUILT		R.CHRISTENSEN
4	01FEB22	CONSTRUCTION	S. MASTERS	R.CHRISTENSEN
3	14JAN22	80% DESIGN REVIEW	S. MASTERS	R.CHRISTENSEN
2	20DEC21	60% DESIGN REVIEW	S. MASTERS	R.CHRISTENSEN
1	29OCT21	50% DESIGN REVIEW	S. MASTERS	R.CHRISTENSEN

PROJECT ENGINEER: S. MASTERS APPROVALS

PRECONSTRUCTION REVISION BLOCK - REV. 0

Vendor:

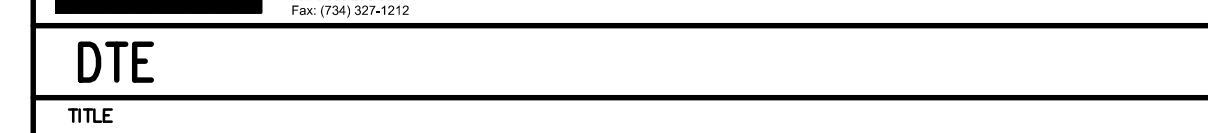

DTE

TITLE

BOTTOM ASH BASIN CLOSURE SPECIFICATIONS

LOCATION NAME: ST. CLAIR COUNTY POWER PLANT UNIT NUMBER

ORIGINATING SOURCE: BARR ENGINEERING CO. SCALE: AS SHOWN USE DIMENSIONS DO NOT SCALE

DTE ELECTRIC COMPANY DRAWING NUMBER: 0516-C-3053

C PROBLEMS				B PROBLEMS				A PROBLEMS				DTE ELECTRIC APPROVALS		OTHER APPROVALS		DESIGNED BY	DATE
PROG.	ISS	REV	CHK	PROG.	ISS	REV	CHK	PROG.	ISS	REV	CHK	DATE	DATE	DATE	DATE	DATE	
																S. HILGEMAN	21OCT21
																J. METTLACH	26OCT21
																R. CHRISTENSEN	29OCT21
																R. CHRISTENSEN	01FEB22

LEGEND
 [Symbol] EXISTING STRUCTURE
 [Symbol] DIRECTION OF TRAFFIC

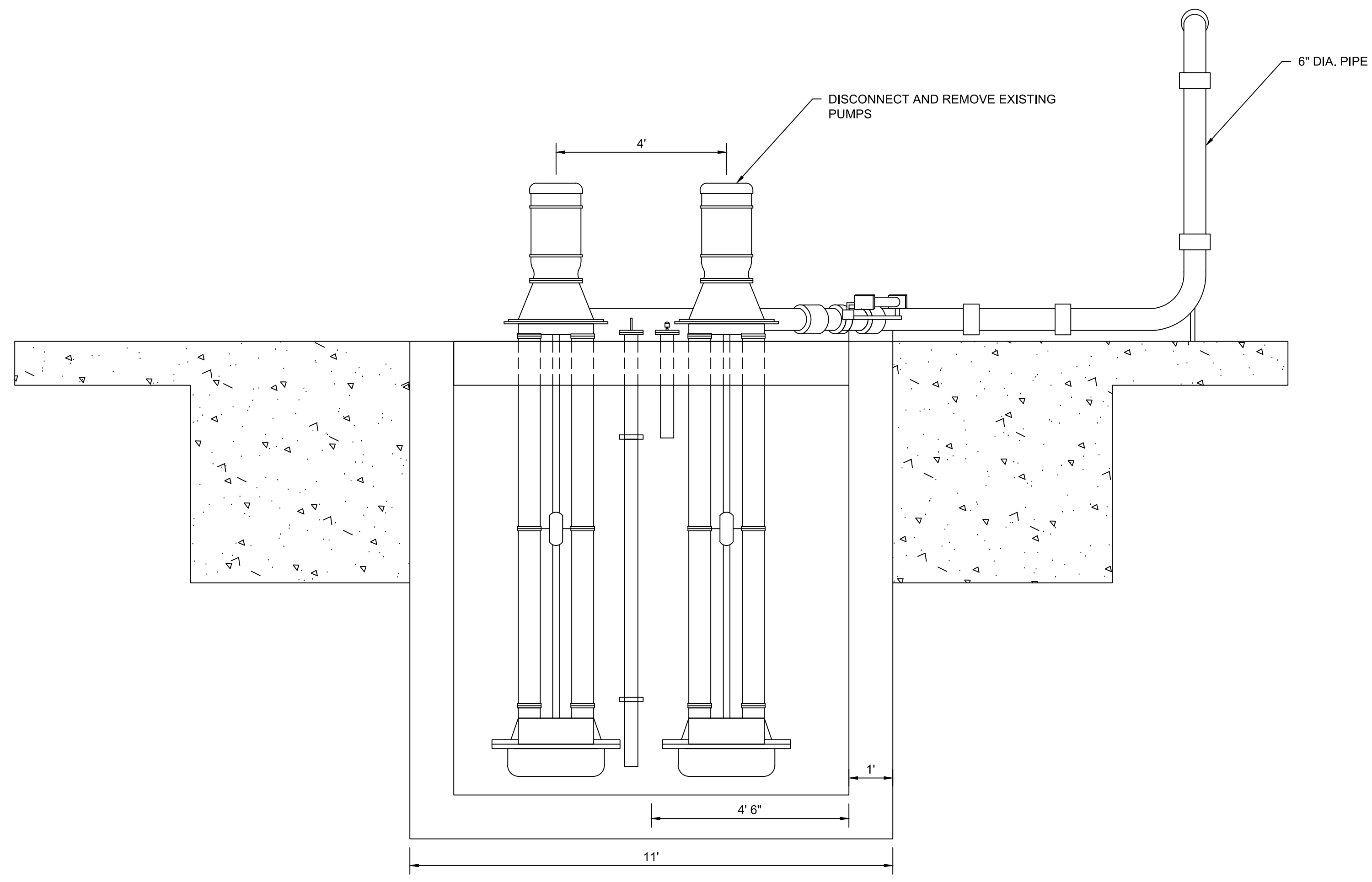

1 PROFILE: PUMP BUILDING PUMPS
 SCALE IN FEET

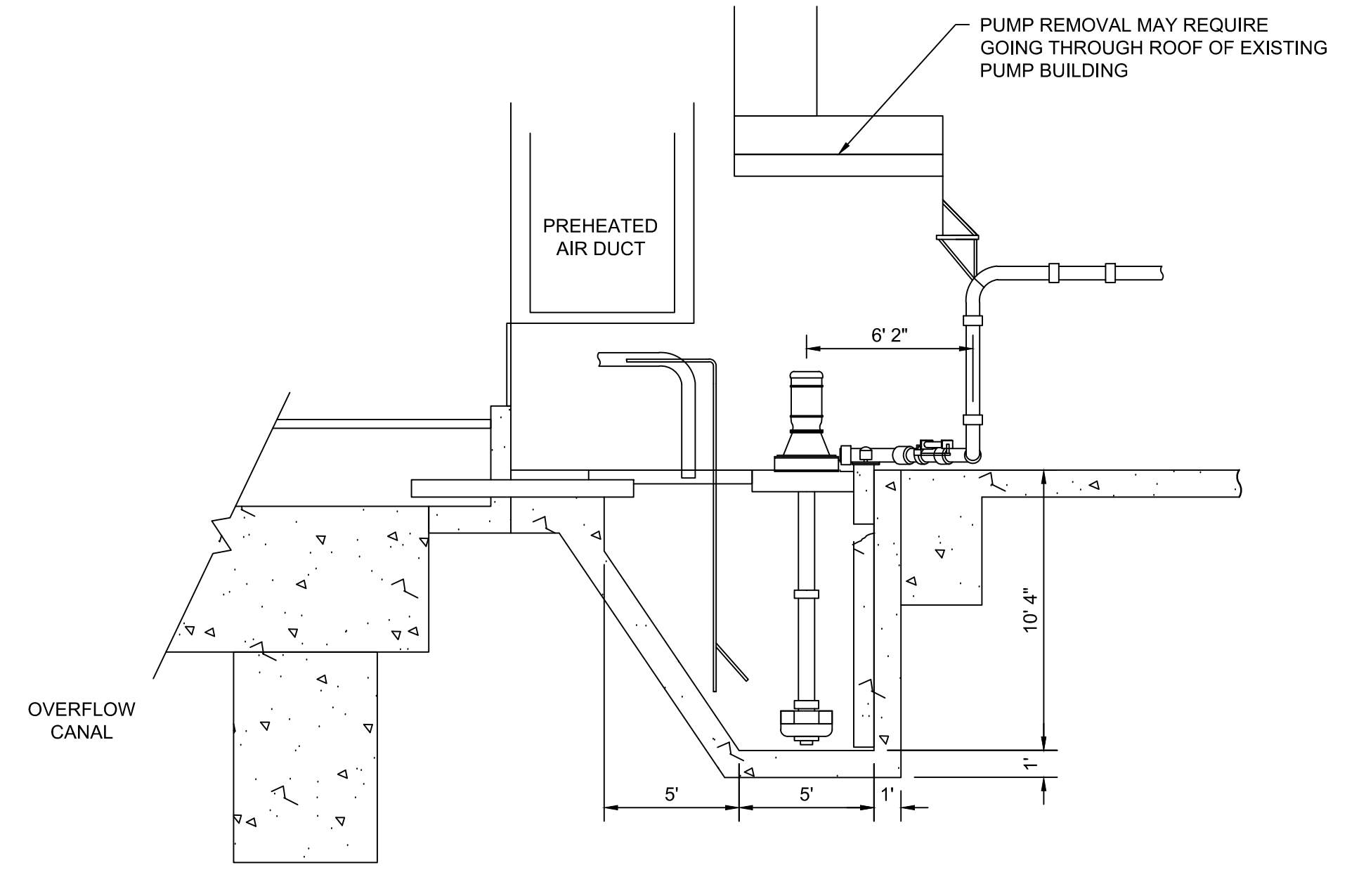

2 PROFILE: PUMP BUILDING PUMPS
 SCALE IN FEET

- NOTES:**
- REMOVE AND DISCARD EXISTING PUMPS AND ANY ASSOCIATED EQUIPMENT/MATERIAL THAT MAY ALSO NEED TO BE REMOVED IN ORDER TO DISCONNECT PUMPS.
 - CAP DISCHARGE PIPING AFTER PUMP REMOVAL.
 - DUE TO SIZE OF PUMPS ITS LIKELY PUMPS WILL NEED TO BE REMOVED THROUGH THE EXISTING ROOF HATCH LOCATED ABOVE THE PUMPS.
 - IT IS THE RESPONSIBILITY OF THE CONTRACTOR TO CONFIRM POWER TO THE PUMP HAS BEEN SHUT DOWN.
 - DRAINAGE SUMPS AT BOTH THE NORTH SILO AND SOUTH SILO DRAIN PITS SHALL BE POWER WASHED AND VACUUMED OUT.
 - CONTRACTOR SHALL REMOVE ALL EQUIPMENT/TOOLS LOCATED DOWN INSIDE SUMP.
 - AFTER THE DISCHARGE LINE HAS BEEN CLEANED THE CONTRACTOR SHALL FLUSH THE DISCHARGE PIPE AS REQUIRED SUCH THAT CLEAN WATER CAN BE VISUALLY OBSERVED COMING OUT OF THE DISCHARGE END.
 - AFTER THE DISCHARGE LINE HAS BEEN VERIFIED "FLUSHED CLEAN" CONTRACTOR SHALL CAP/PLUG DISCHARGE LINE TO PREVENT ACCIDENTAL RELEASE TO THE BOTTOM ASH PONDS.

REFERENCE DRAWINGS:
 0516-M-1073
 0516-C-0484
 0516-C-0485

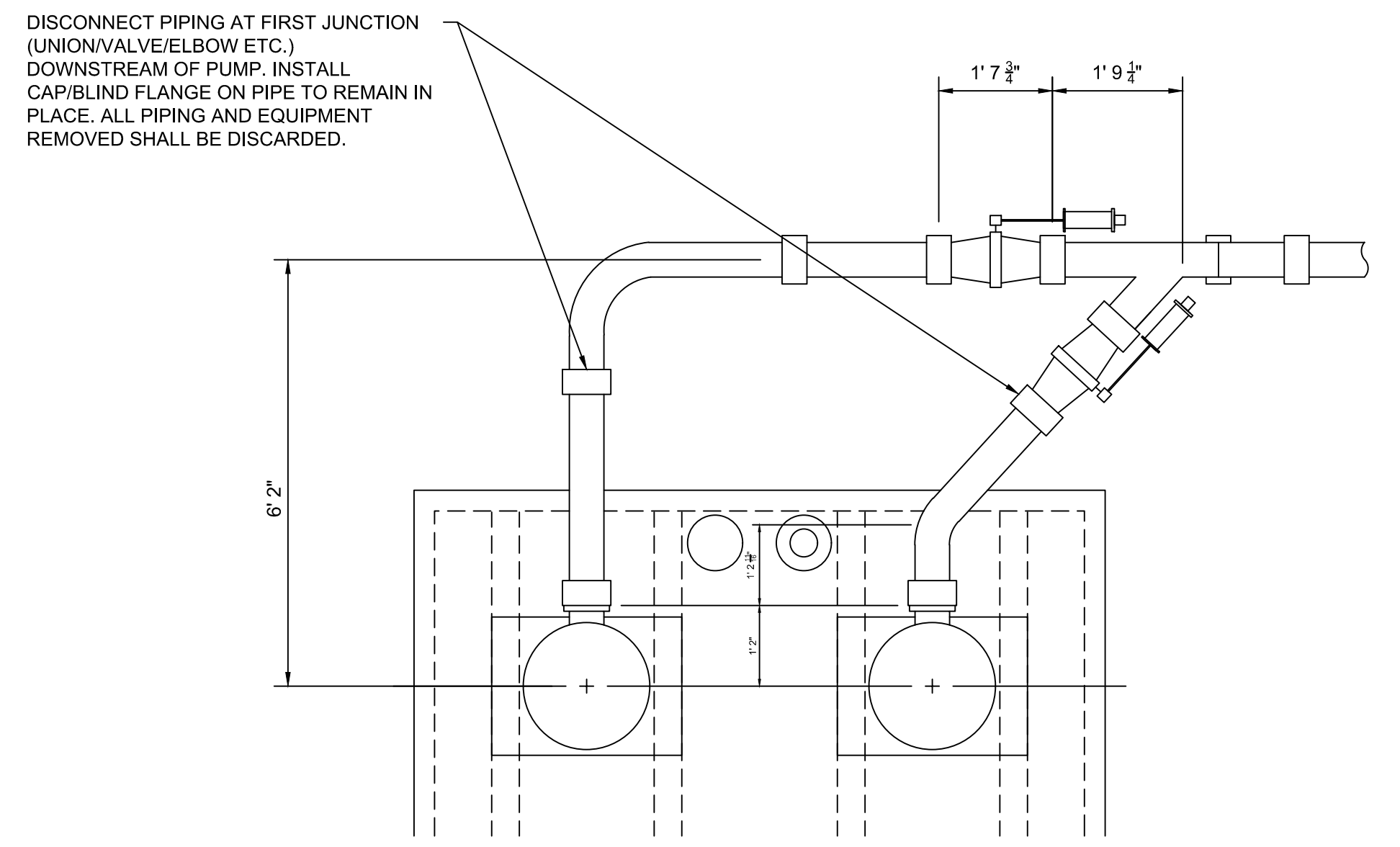

3 DETAIL: PUMP BUILDING PUMPS
 SCALE IN FEET

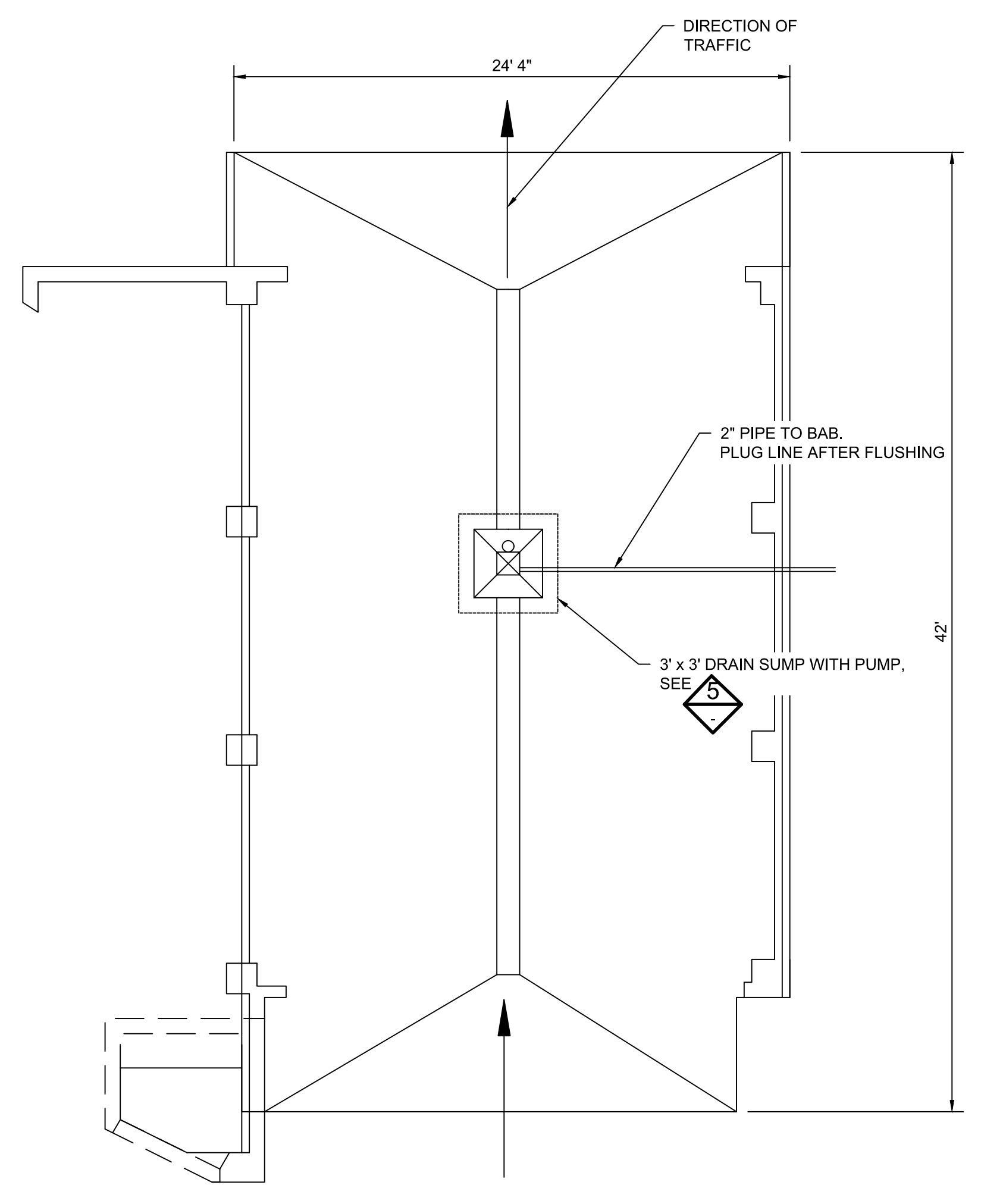

4 PLAN: NORTH AND SOUTH DRAIN SILO TRUCK WASH BAR DRAINAGE SUMP CLEANING
 SCALE IN FEET

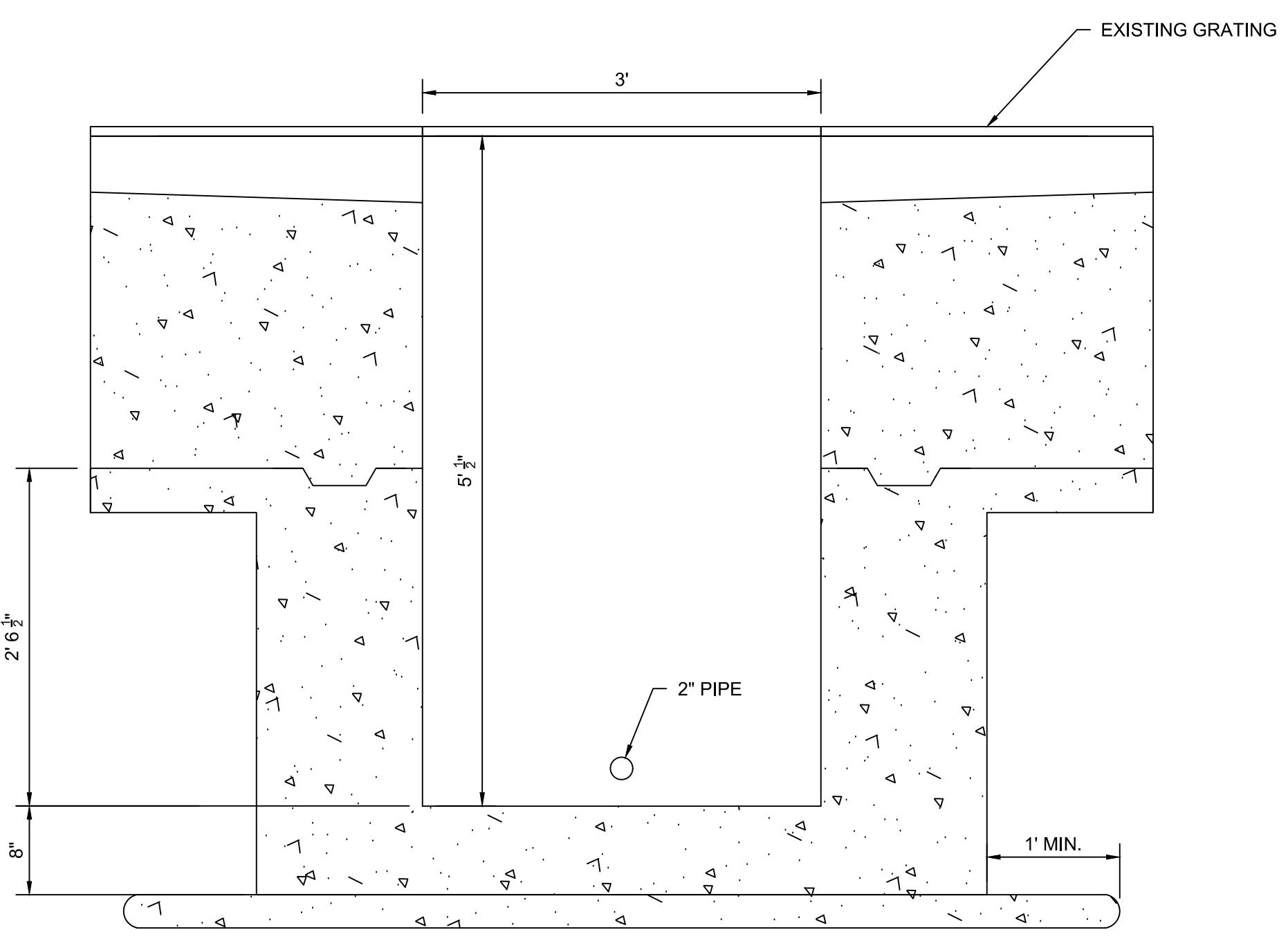

5 DETAIL: DRAIN SUMP
 SCALE IN FEET

0516-M-7435
 LATEST REVISION

6			
5			
4			
3	05JUN23	AS-BUILT	R. CHRISTENSEN
2	01FEB22	CONSTRUCTION	S. MASTERS R. CHRISTENSEN
1	14JAN22	90% DESIGN REVIEW	S. MASTERS R. CHRISTENSEN
NO.	DATE	ISSUED FOR	PROJ. ENG. RESP. ENG.
PROJECT ENGINEER: S. MASTERS		APPROVALS	
PRECONSTRUCTION REVISION BLOCK - REV. 0			

Vendor:
BARR
 BARR ENGINEERING CO.
 3005 BENTONVILLE STREET
 SUITE 100
 ANNANDALE, VA 41108
 PH: (703) 271-0171
 WWW.BARR-ENG.COM

DTE
 TITLE: **BOTTOM ASH BASIN CLOSURE PUMP BUILDING AND SILO DRAIN SUMP PLAN, PROFILES, AND DETAILS**
 LOCATION NAME: **ST. CLAIR COUNTY POWER PLANT** UNIT NUMBER:
 ORIGINATING SOURCE: **BARR ENGINEERING CO.** SCALE: **AS SHOWN** USE DIMENSIONS DO NOT SCALE.
 DTE ELECTRICAL COMPANY DRAWING NUMBER: **0516-M-7435**

THIS IS AN CAD PRODUCED DRAWING. ANY CHANGES OR REVISIONS TO THIS DRAWING MUST BE COMPLETED USING THE CAD SYSTEM.

C PROLOGS				B PROLOGS				A PROLOGS				DTE ELECTRIC APPROVALS		OTHER APPROVALS		DESIGNED BY	
PROJ. ENGR.	DESIGNER	DATE	SCALE	PROJ. ENGR.	DESIGNER	DATE	SCALE	PROJ. ENGR.	DESIGNER	DATE	SCALE	DATE	DATE	DATE	DATE	DATE	
																S. HILGEMAN	21OCT21
																J. METLACH	26OCT21
																R. CHRISTENSEN	29OCT21
																R. CHRISTENSEN	01FEB22

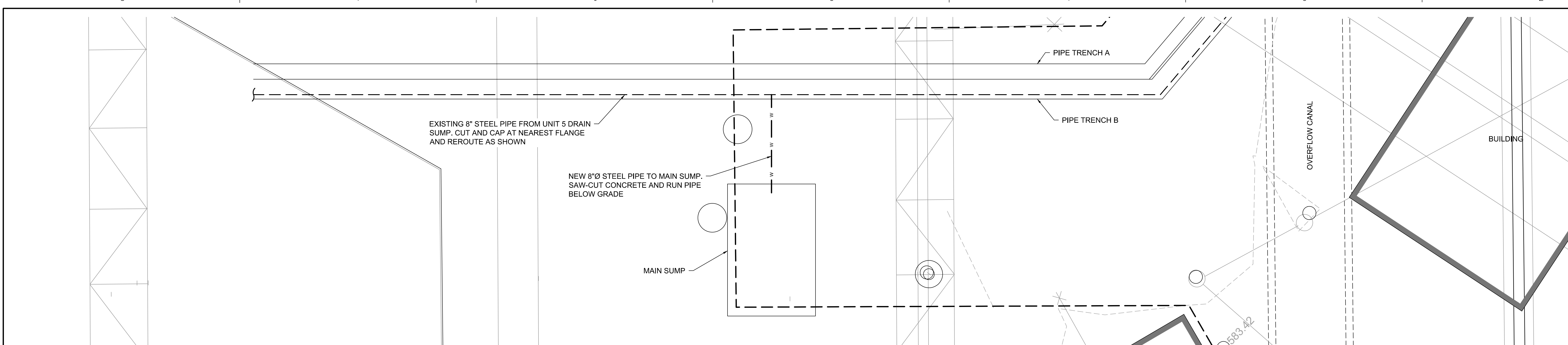

LEGEND

---	EXISTING MAJOR CONTOUR
---	EXISTING MINOR CONTOUR
○	EXISTING GUARDRAIL
---	EXISTING PIPELINE
---	EXISTING ELECTRIC
---	EXISTING WATER
---	EXISTING COMMUNICATIONS
---	EXISTING STRUCTURE

- NOTES:**
- SECTIONS AND DETAILS ARE REDRAWN FROM PREVIOUS RECORD DRAWINGS. DRAWINGS REFERENCED ARE 0516-M-1064, 0516-C-0727, AND 0516-C-W-0134.
 - CUT AND CAP PIPE AT BOTH ENDS OF THE PIPE. AT THE DISCHARGE END, PLUG WITH CONCRETE. AT THE SOURCE END, CUT THE PIPE AT A PRESELECTED FLANGE OR ELBOW AND PHYSICALLY REMOVE A SECTION OF PIPE. THIS APPROACH ISOLATES THE PIPE FROM THE BOTTOM ASH POND, WHICH ELIMINATES THE POTENTIAL FOR AN ACCIDENTAL RELEASE TO THE POND.
 - IF THE SOURCE END OF THE PIPE ORIGINATES AT A UNIT PROCESS THAT HAS A WATER SUPPLY, THEN THE CONTRACTOR SHALL REMOVE THE SUPPLY OF WATER INTO THE UNIT BY CLOSING ALL WATER SUPPLY VALVES TO THE UNIT AND THEN REMOVING A SECTION OF THE PIPE BETWEEN THE UNIT AND THE VALVE. THE SAME PROCESS SHALL BE COMPLETED ON THE WATER SUPPLY DISCHARGE END. THIS APPROACH ELIMINATES THE WATER SUPPLY FROM ACCIDENTALLY BEING TURNED ON, CAUSING A RELEASE FROM THE UNIT.

REFERENCE DRAWINGS:

0516-M-1064
0516-C-0727
0516-C-W-0134

1 PLAN: STEEL PIPE TO MAIN SUMP

SCALE IN FEET

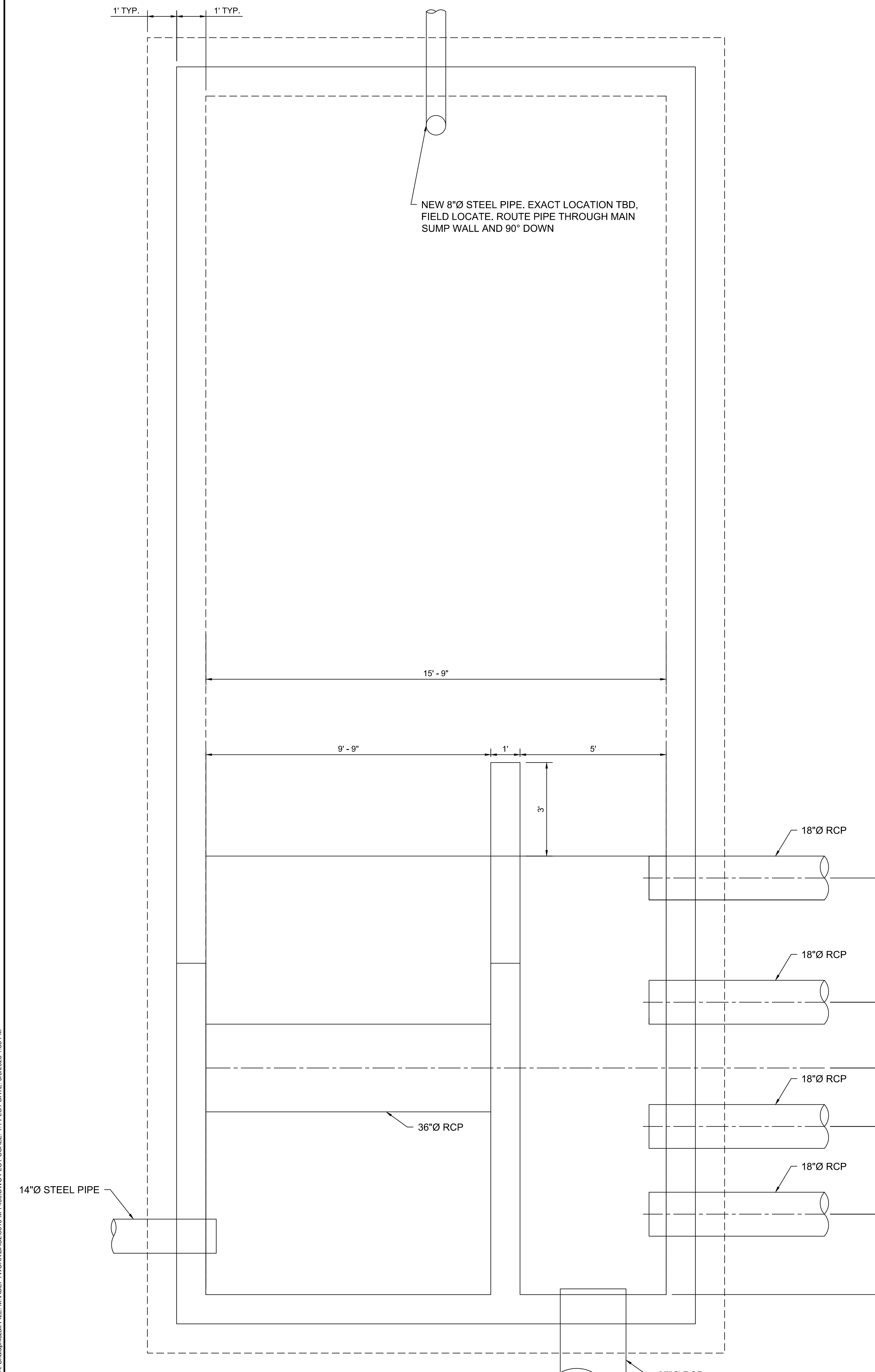

2 PLAN: MAIN SUMP

SCALE IN FEET

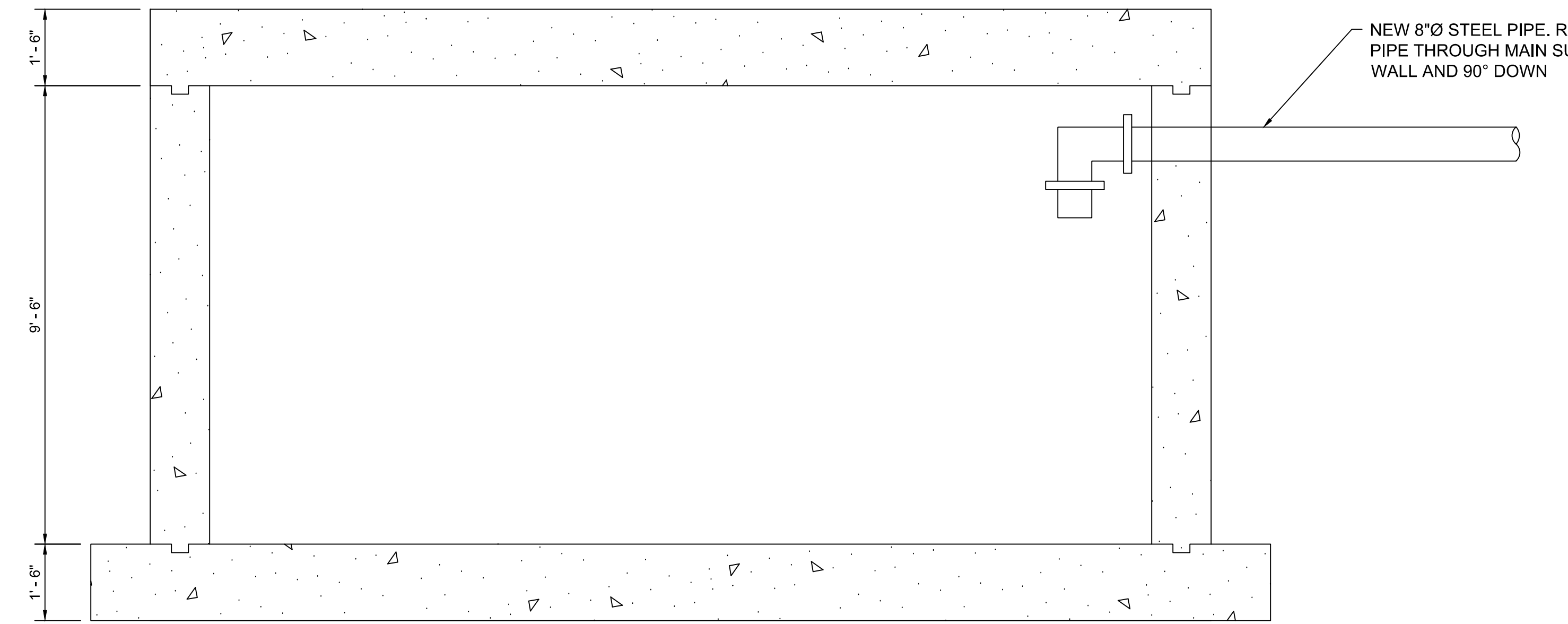

3 SECTION: MAIN SUMP

SCALE IN FEET

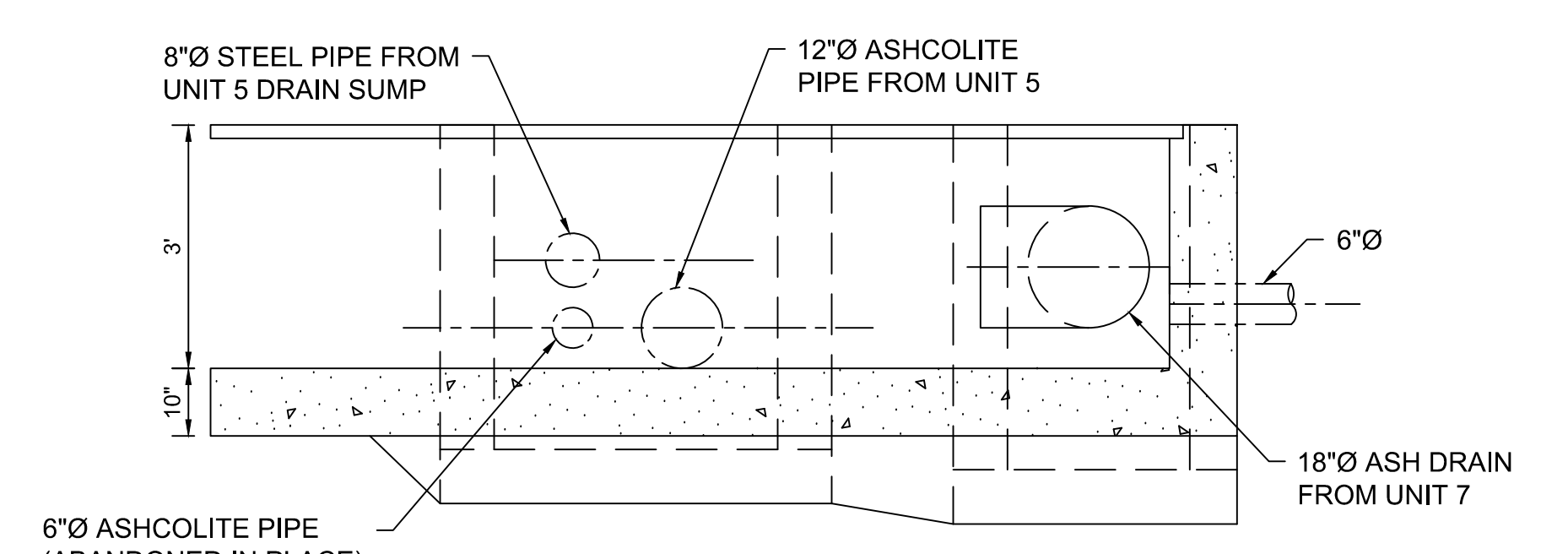

4 DETAIL: EXISTING PIPE TRENCH A AND B

SCALE IN FEET

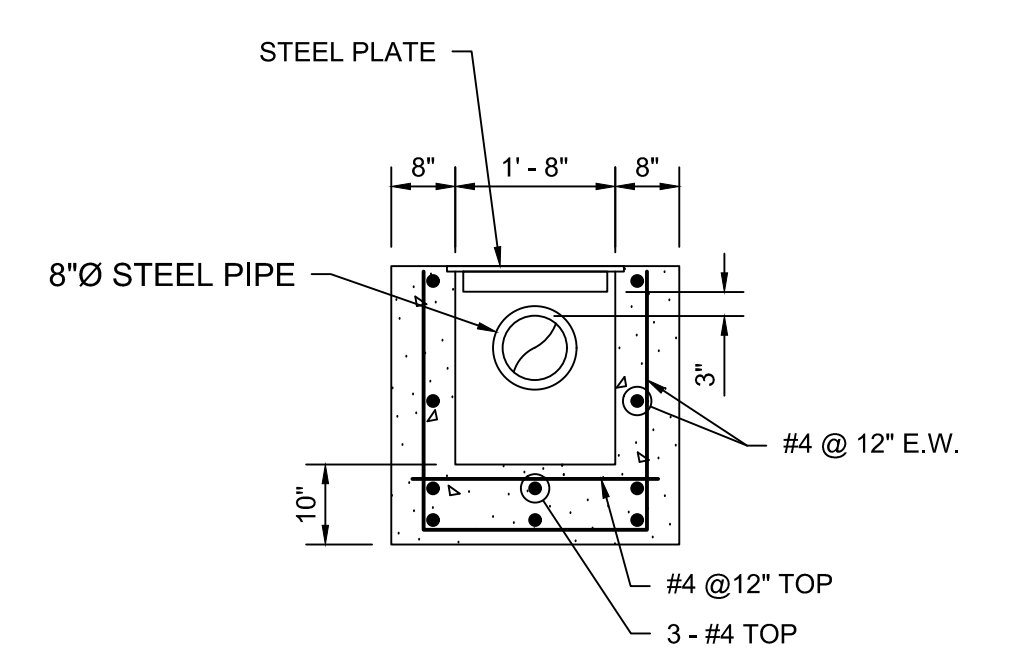

5 DETAIL: PIPE TRENCH

SCALE IN FEET

- CAST IN PLACE CONCRETE**
- ALL CONCRETE WORK AND REINFORCEMENT DETAILING SHALL BE IN ACCORDANCE WITH ACI 318-14.
 - MINIMUM COMPRESSIVE STRENGTH OF CONCRETE: 4,000 PSI AT 28 DAYS.
 - MAXIMUM WATER/CEMENT RATIO: 0.45.
 - ALL CONCRETE SHALL CONTAIN 6% AIR CONTENT ±1.5%.
 - CEMENT SHALL BE TYPE II MEETING THE REQUIREMENTS OF ASTM C150.
 - MAXIMUM COARSE AGGREGATE SIZE SHALL BE 3/4".
 - FLY ASH SHALL BE CLASS F MEETING THE REQUIREMENTS OF ASTM C618. MAXIMUM 25% BY WEIGHT OF TOTAL CEMENTITIOUS CONTENT.
 - REINFORCING STEEL SHALL BE ASTM A615 GRADE 60 DEFORMED BARS.

0516-M-7436
LATEST REVISION

6				
5	05JUN23	AS-BUILT		R. CHRISTENSEN
4	01FEB22	CONSTRUCTION	S. MASTERS	R. CHRISTENSEN
3	14JAN22	90% DESIGN REVIEW	S. MASTERS	R. CHRISTENSEN
2	20DEC21	60% DESIGN REVIEW	S. MASTERS	R. CHRISTENSEN
1	29OCT21	50% DESIGN REVIEW	S. MASTERS	R. CHRISTENSEN
NO. DATE		ISSUED FOR		PROJ. ENG.
PROJECT ENGINEER: S. MASTERS				APPROVALS
PRECONSTRUCTION REVISION BLOCK - REV. 0				

Vendor:

BARR ENGINEERING CO.
3005 EDWARDSVILLE DRIVE
SUITE 100
ANDERSON, IN 46016
PH: 317-921-0171

DTE
TITLE

UNIT 5 DRAIN SUMP PIPE REROUTE
PLAN AND PROFILE

LOCATION NAME: ST. CLAIR COUNTY POWER PLANT UNIT NUMBER

ORIGINATING SOURCE: BARR ENGINEERING CO. SCALE: AS SHOWN USE DIMENSIONS DO NOT SCALE

0516-M-7436
DATE: 05JUN23 OPERATOR: JAMG

C PROLOGS.				B PROLOGS.				A PROLOGS.				DTE ELECTRIC APPROVALS		OTHER APPROVALS		DESIGNED BY	
PROJ.	DATE	CHK BY	APP BY	PROJ.	DATE	CHK BY	APP BY	PROJ.	DATE	CHK BY	APP BY	DATE	DATE	DATE	DATE	DATE	DATE
																S. HEICOMAN	21OCT21
																J. METLACH	26OCT21
																R. CHRISTENSEN	29OCT21
																R. CHRISTENSEN	01FEB22

THIS IS AN CAD PRODUCED DRAWING.
ANY CHANGES OR REVISIONS TO
THIS DRAWING MUST BE COMPLETED
USING THE CAD SYSTEM

CADD USER: andr.A.Christensen; FILE: M:\ASSETS\WORK\BARR\0516-M-7436.dwg; PLOT SCALE: 1:1; PLOT DATE: 05/29/2023 1:33 PM

Appendix C

Photographic Documentation Log

East Basin Excavated Cells

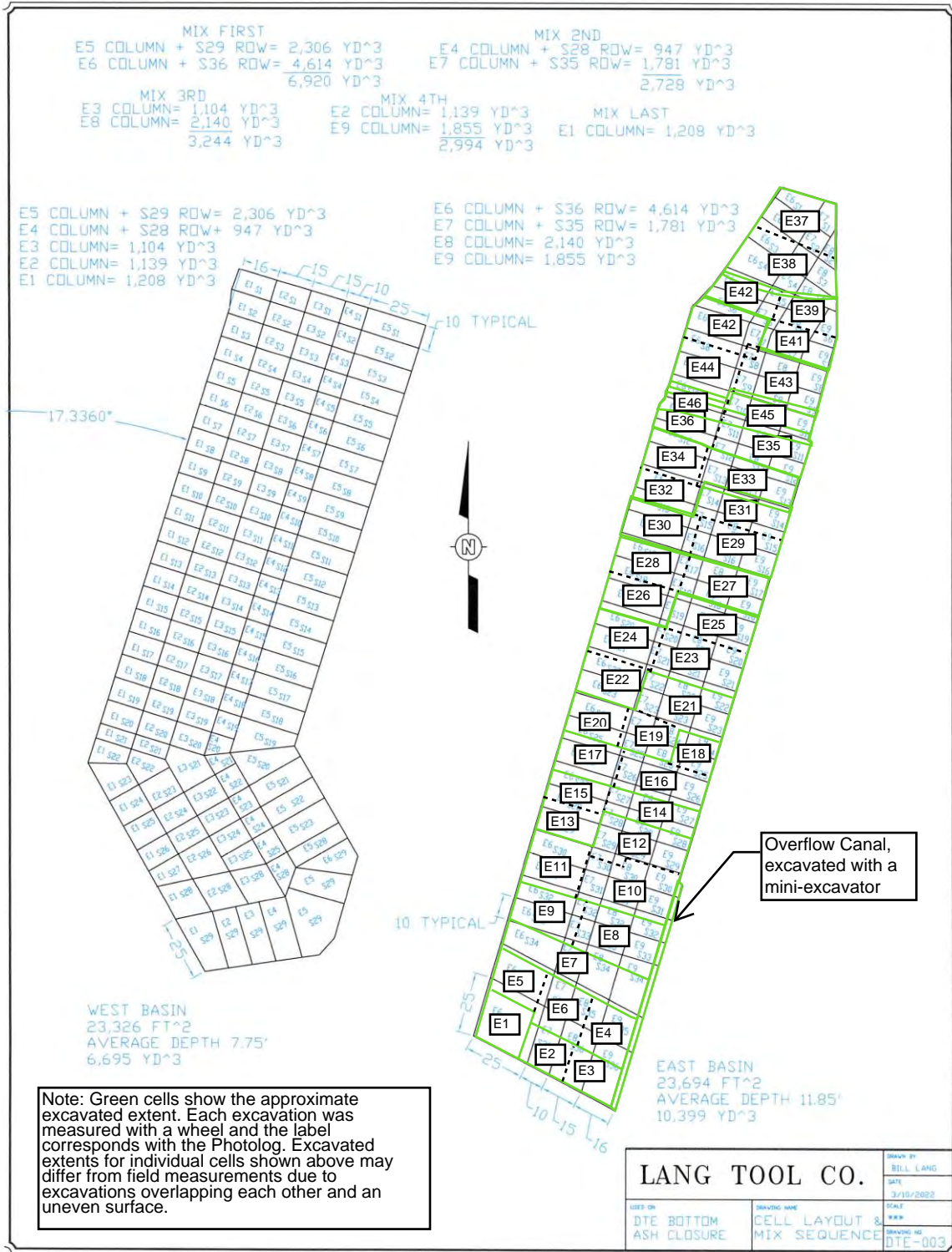

West Basin Excavated Cells

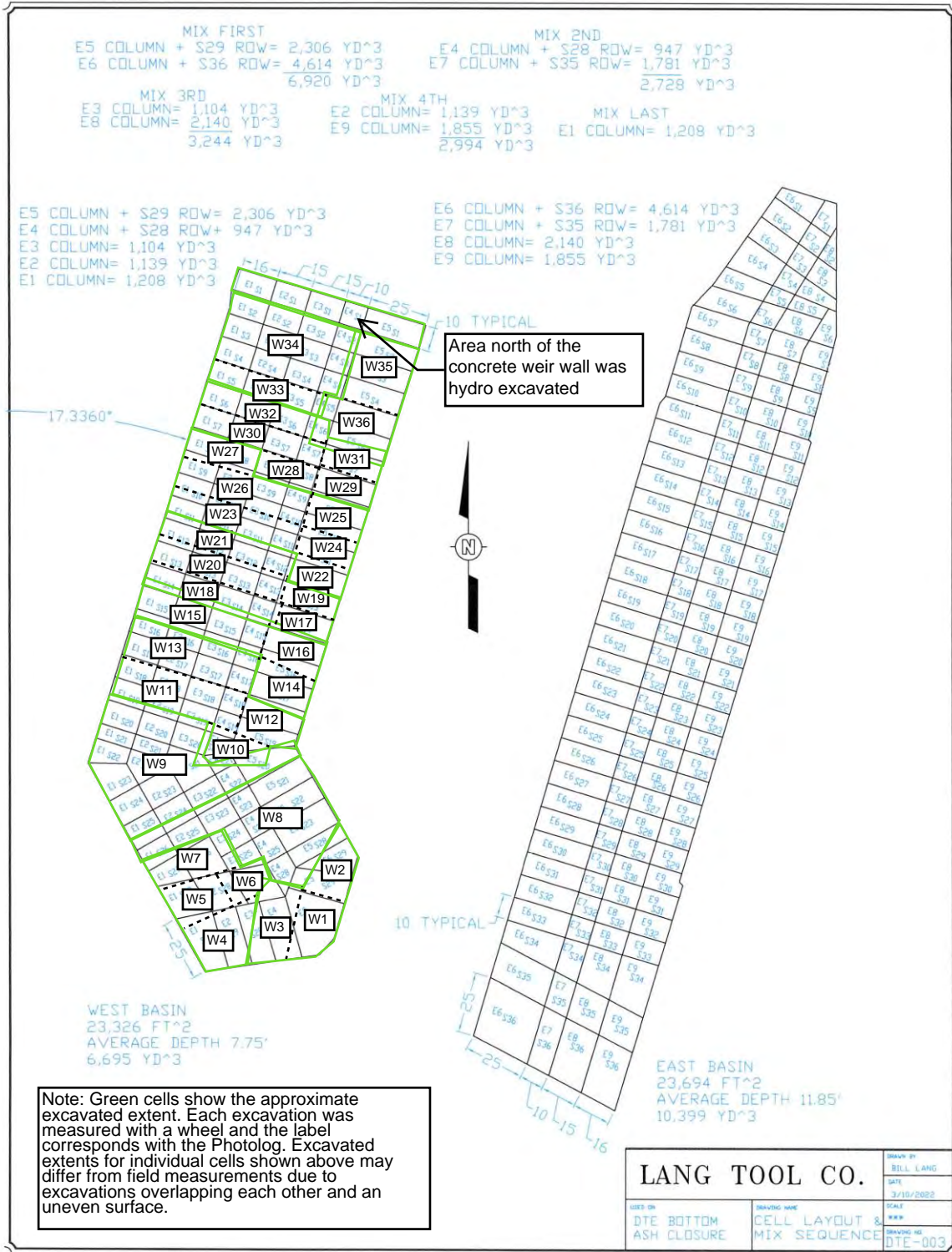
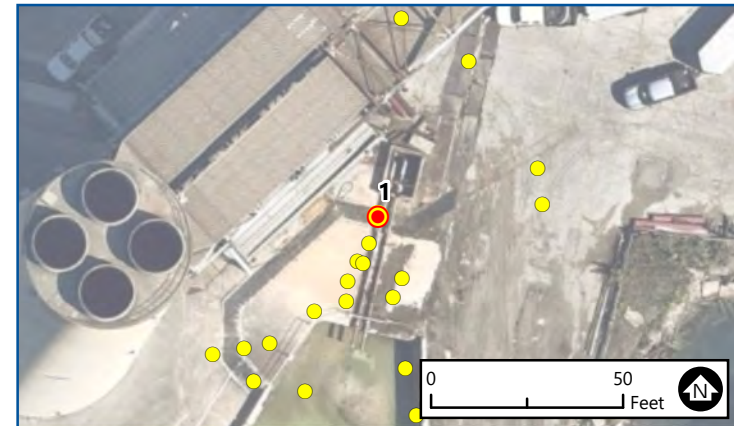

Photo 1-1



Photo 1-2



1 of 269
**CONSTRUCTION
MONITORING**
PHOTO LOCATIONS
St. Clair Power Plant
DTE Energy
East China, Michigan

Aerial Image: NearMap (8/10/2022)
NOTE: Photo locations are approximate.

Date: 11/16/2022
Note: Pipe Isolation

Photo 1-1 Caption:
Chemical trench reroute

Photo 1-2 Caption:
Chemical trench reroute

Photo 2-1



Photo 2-2



2 of 269
**CONSTRUCTION
MONITORING**
PHOTO LOCATIONS
St. Clair Power Plant
DTE Energy
East China, Michigan

Aerial Image: NearMap (8/10/2022)
NOTE: Photo locations are approximate.

Date: 12/8/2022

Note: Pipe Isolation

Photo 2-1 Caption:
18" ash drain line for unit 7 sump.
Located outside north silo.

Photo 2-2 Caption:
18" ash drain line for unit 7 sump.
Located outside north silo.

Photo 3-1



Photo 3-2

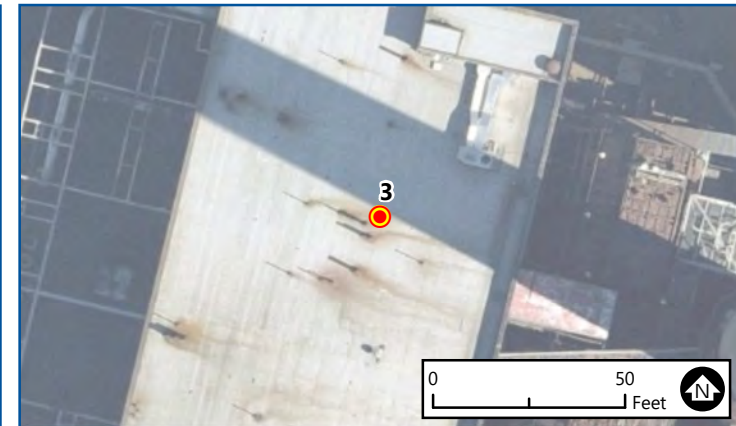

3 of 269
**CONSTRUCTION
MONITORING**
PHOTO LOCATIONS
St. Clair Power Plant
DTE Energy
East China, Michigan

Aerial Image: NearMap (8/10/2022)
NOTE: Photo locations are approximate.

Date: 12/8/2022

Note: Pipe Isolation

Photo 3-1 Caption:
Unit 7 bottom ash discharge inlet

Photo 3-2 Caption:
Unit 7 bottom ash discharge outlet

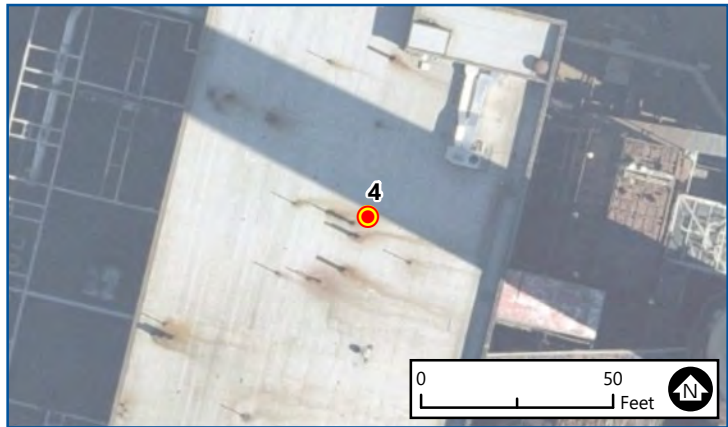
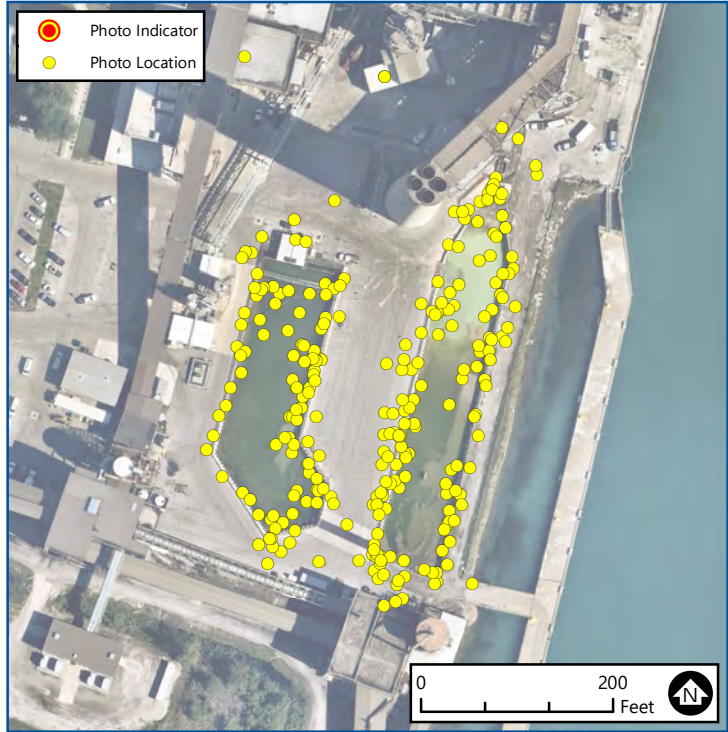

4 of 269
**CONSTRUCTION
MONITORING**
PHOTO LOCATIONS
St. Clair Power Plant
DTE Energy
East China, Michigan

Aerial Image: NearMap (8/10/2022)
NOTE: Photo locations are approximate.

Date: 12/8/2022

Note: Pipe Isolation

Photo 4-1 Caption:
Unit 6 bottom ash discharge pipes

Photo 5-1



Photo 5-2

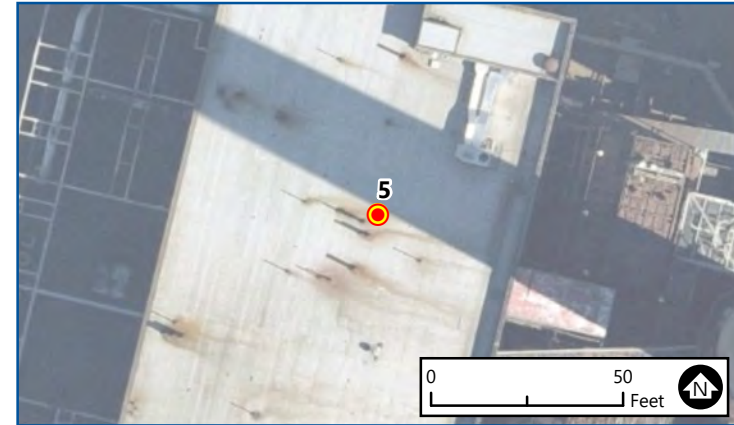

5 of 269
**CONSTRUCTION
MONITORING**
PHOTO LOCATIONS
St. Clair Power Plant
DTE Energy
East China, Michigan

Aerial Image: NearMap (8/10/2022)
NOTE: Photo locations are approximate.

Date: 12/8/2022

Note: Pipe Isolation

Photo 5-1 Caption:
Unit 5 bottom ash discharge inlet 1

Photo 5-2 Caption:
Unit 5 bottom ash discharge inlet 2

Photo 6-1

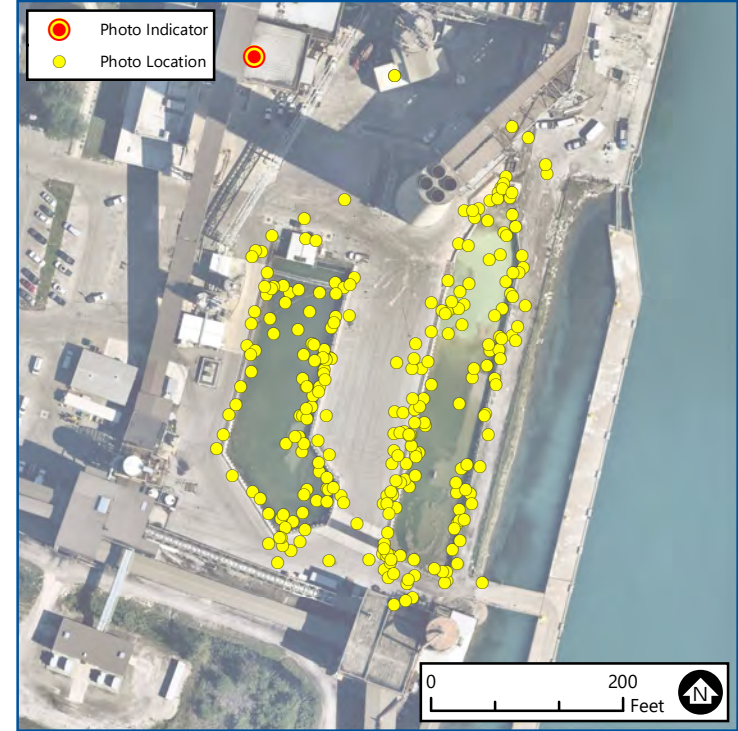
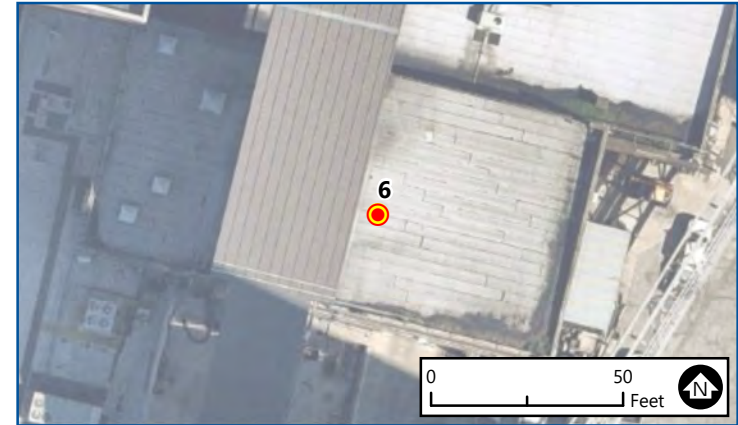

Photo 6-2



6 of 269
**CONSTRUCTION
MONITORING**
PHOTO LOCATIONS
St. Clair Power Plant
DTE Energy
East China, Michigan

Aerial Image: NearMap (8/10/2022)
NOTE: Photo locations are approximate.

Date: 12/8/2022
Note: Pipe Isolation

Photo 6-1 Caption:
Unit 1, 2, 3, 4, and 6 - Bottom ash discharge pipes. Pipes are located in sub-basement of Unit 1.

Photo 6-2 Caption:
Unit 1, 2, 3, 4, and 6 - Bottom ash discharge pipes. Pipes are located in sub-basement of Unit 1.

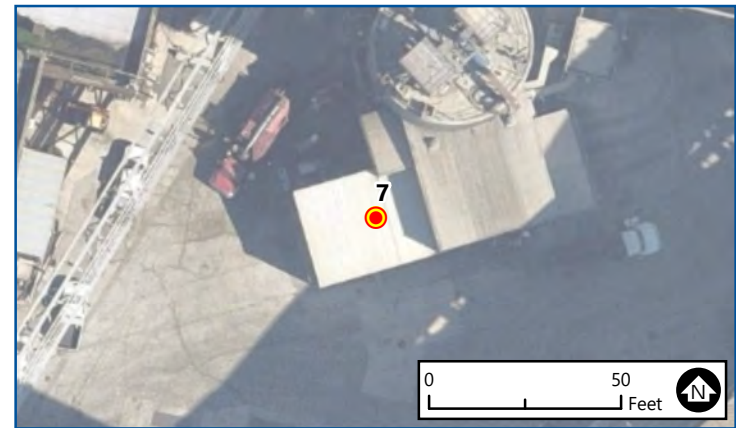

7 of 269
**CONSTRUCTION
MONITORING**
PHOTO LOCATIONS
St. Clair Power Plant
DTE Energy
East China, Michigan

Aerial Image: NearMap (8/10/2022)
NOTE: Photo locations are approximate.

Date: 12/8/2022
Note: Pipe Isolation

Photo 7-1 Caption:
South drain silo pump vault – Pipe plugged with flowable fill from outlet to inlet. Sump pit and pump vault cleaned out.

Photo 8-1

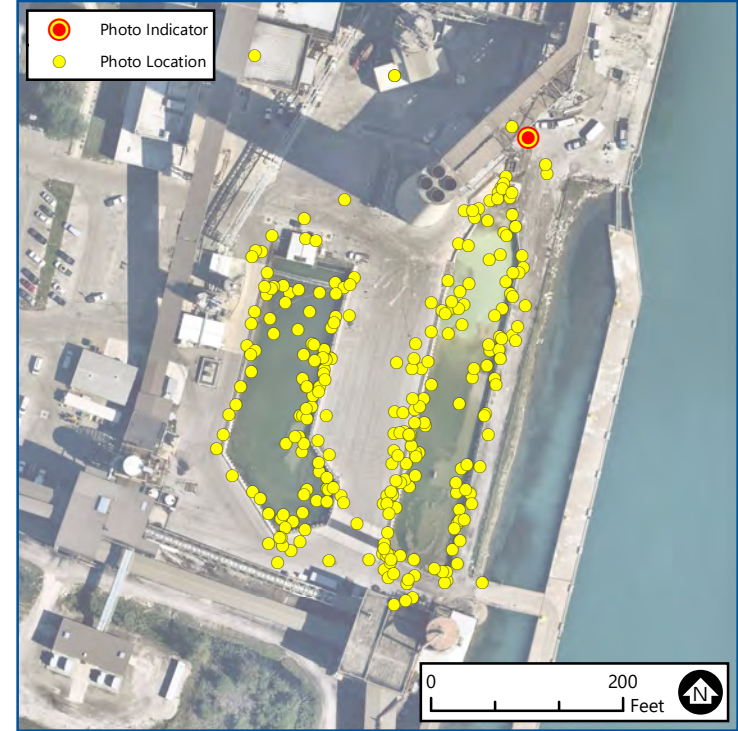

Photo 8-2



8 of 269
**CONSTRUCTION
MONITORING**
PHOTO LOCATIONS
St. Clair Power Plant
DTE Energy
East China, Michigan

Aerial Image: NearMap (8/10/2022)
NOTE: Photo locations are approximate.

Date: 12/8/2022
Note: Pipe Isolation

Photo 8-1 Caption:
Fiberglass bottom ash transport pipes removed (not pictured) back to pipe support structure. Eight inch ash transport pipes capped with a blind flange.

Photo 8-2 Caption:
Eight-inch bottoms ash transport pipes capped with a blind flange

Photo 9-1

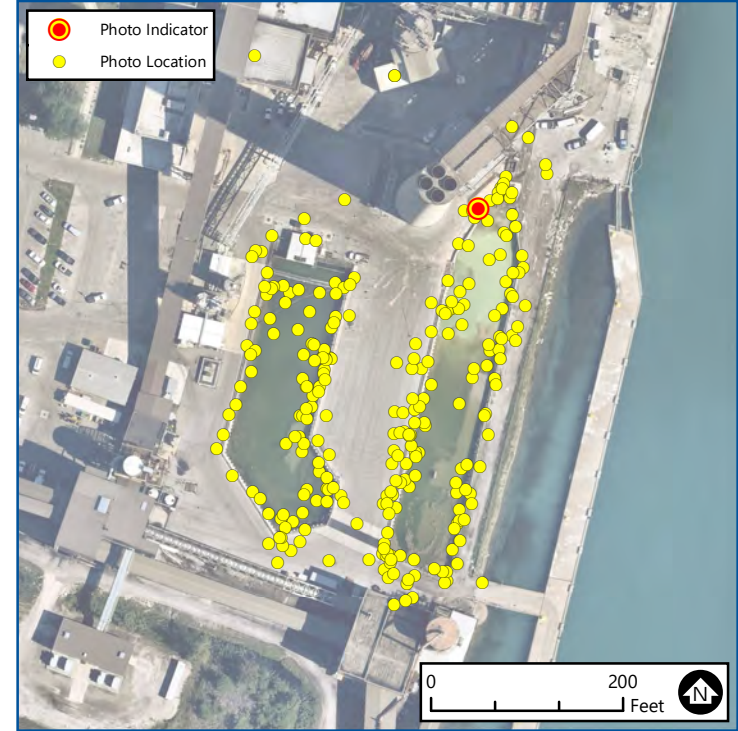
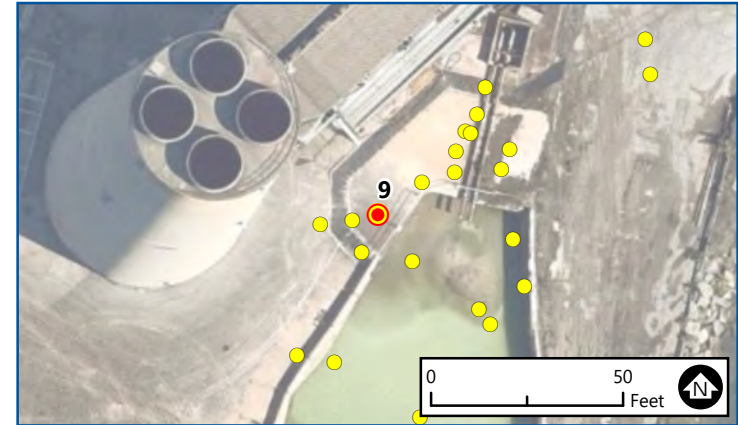

Photo 9-2



9 of 269
**CONSTRUCTION
MONITORING**
PHOTO LOCATIONS
St. Clair Power Plant
DTE Energy
East China, Michigan

Date: 12/8/2022
Note: Pipe Isolation

Photo 9-1 Caption:
3 Steel pipes plugged with flowable fill
in north end of the East basin

Photo 9-2 Caption:
Close up view

Aerial Image: NearMap (8/10/2022)
NOTE: Photo locations are approximate.

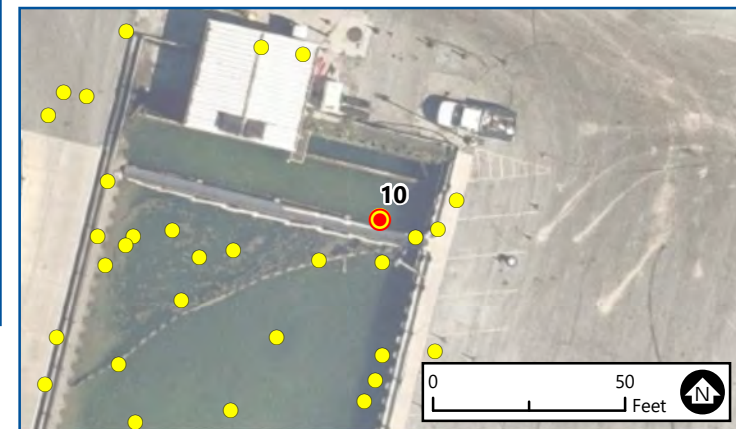

10 of 269
**CONSTRUCTION
MONITORING**
PHOTO LOCATIONS
St. Clair Power Plant
DTE Energy
East China, Michigan

Aerial Image: NearMap (8/10/2022)
NOTE: Photo locations are approximate.

Date: 12/8/2022
Note: Pipe Isolation

Photo 10-1 Caption:
West basin outlet to RCP and overflow canal. The overflow canal connects to the St. Clair River, so the canal was plugged with a bladder throughout construction to prohibit discharge.



11 of 269
**CONSTRUCTION
MONITORING**
PHOTO LOCATIONS
St. Clair Power Plant
DTE Energy
East China, Michigan

Aerial Image: NearMap (8/10/2022)
NOTE: Photo locations are approximate.

Date: 12/8/2022

Note: Pipe Isolation

Photo 11-1 Caption:
Pumps removed from pump house and
discharge piping capped with blind
flanges

Photo 12-1



Photo 12-2



12 of 269
**CONSTRUCTION
MONITORING**
PHOTO LOCATIONS
St. Clair Power Plant
DTE Energy
East China, Michigan

Aerial Image: NearMap (8/10/2022)
NOTE: Photo locations are approximate.

Date: 12/8/2022
Note: Pipe Isolation

Photo 12-1 Caption:
East discharge pipe capped with a blind flange

Photo 12-2 Caption:
West discharge pipe capped with a blind flange

Photo 13-1



Photo 13-2

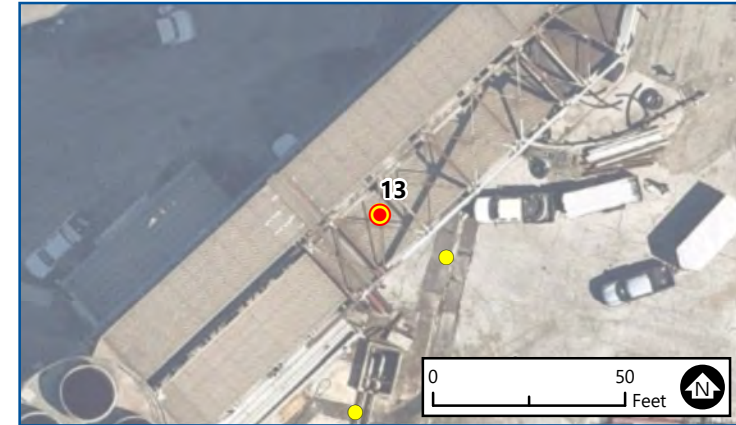

13 of 269
**CONSTRUCTION
MONITORING**
PHOTO LOCATIONS
St. Clair Power Plant
DTE Energy
East China, Michigan

Aerial Image: NearMap (8/10/2022)
NOTE: Photo locations are approximate.

Date: 12/10/2022
Note: Pipe Isolation

Photo 13-1 Caption:
8" unit 5 drain pump reroute tie-in
located 28' east of the main sump
building

Photo 13-2 Caption:
8" unit 5 drain pump pipe tie-in (photo
collected on 8/26/2022)

Photo 14-1



Photo 14-2



14 of 269
**CONSTRUCTION
MONITORING**
PHOTO LOCATIONS
St. Clair Power Plant
DTE Energy
East China, Michigan

Aerial Image: NearMap (8/10/2022)
NOTE: Photo locations are approximate.

Date: 12/13/2022
Note: Pipe Isolation

Photo 14-1 Caption:
Discharge pipes plugged with flowable fill at the trenway A chemical treatment trench. The 6" pipe drained the south silo (plugged from outlet to inlet); the 8" pipe drained the unit 5 sump; and the 12" previously drained unit 5.

Photo 14-2 Caption:
Close up view

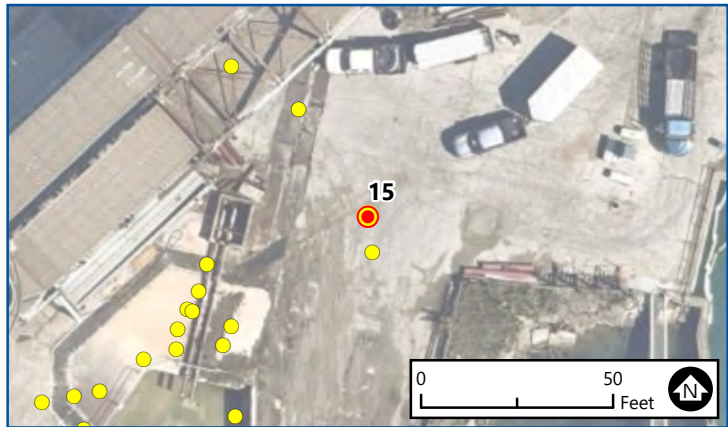
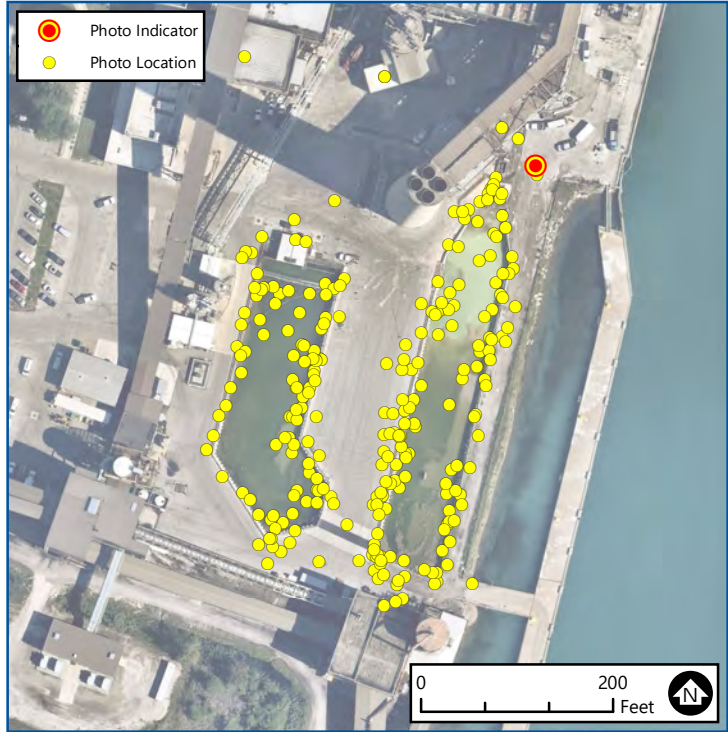

15 of 269
**CONSTRUCTION
MONITORING**
PHOTO LOCATIONS
St. Clair Power Plant
DTE Energy
East China, Michigan

Aerial Image: NearMap (8/10/2022)
NOTE: Photo locations are approximate.

Date: 1/6/2023

Note: Pipe Isolation

Photo 15-1 Caption:
18" discharge pipe for unit 7 plugged
with flowable fill at the trenway B
chemical treatment trench.

Photo 16-1



Photo 16-2

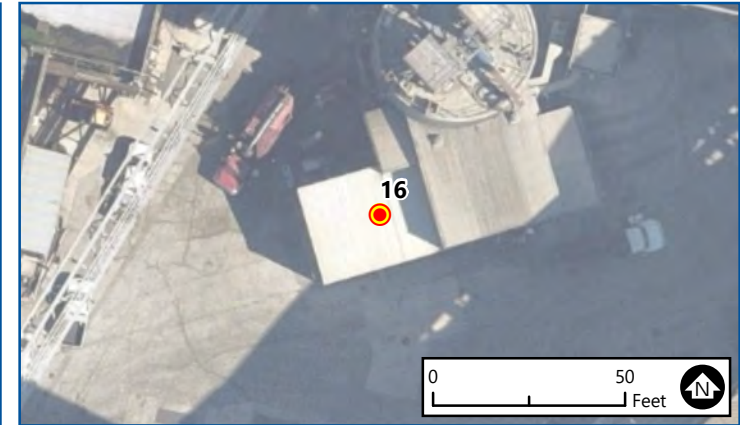

16 of 269
**CONSTRUCTION
MONITORING**
PHOTO LOCATIONS
St. Clair Power Plant
DTE Energy
East China, Michigan

Aerial Image: NearMap (8/10/2022)
NOTE: Photo locations are approximate.

Date: 12/13/2022
Note: Pipe Isolation

Photo 16-1 Caption:
South drain silo pump vault – Pipe plugged with flowable fill from outlet to inlet.

Photo 16-2 Caption:
Sump pit and pump vault cleaned out

Photo 17-1



Photo 17-2



17 of 269
**CONSTRUCTION
MONITORING**
PHOTO LOCATIONS
St. Clair Power Plant
DTE Energy
East China, Michigan

Aerial Image: NearMap (8/10/2022)
NOTE: Photo locations are approximate.

Date: 1/10/2023
Note: Pipe Isolation
Photo 17-1 Caption:
East basin, 4" drain pipe, plugged with flowable fill
Photo 17-2 Caption:
Close up view

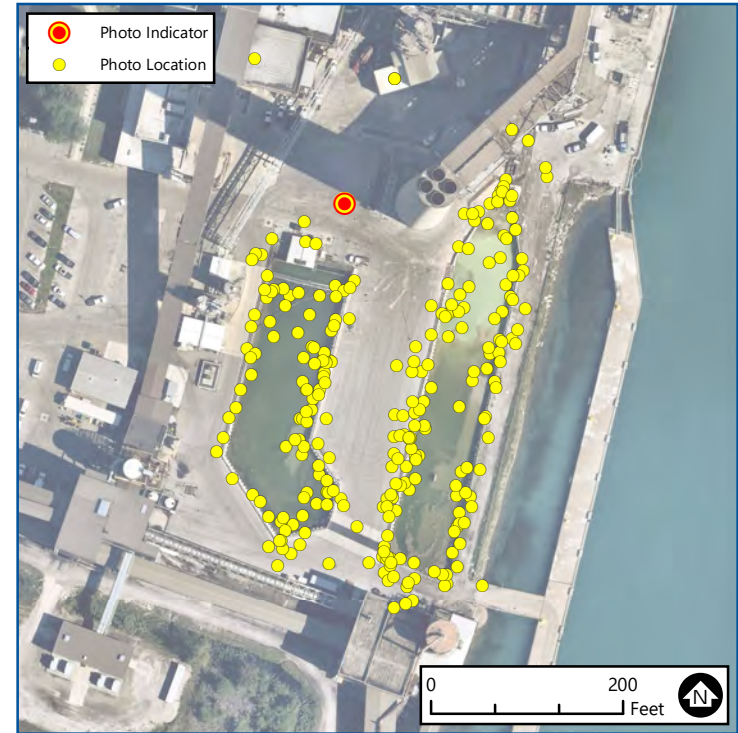
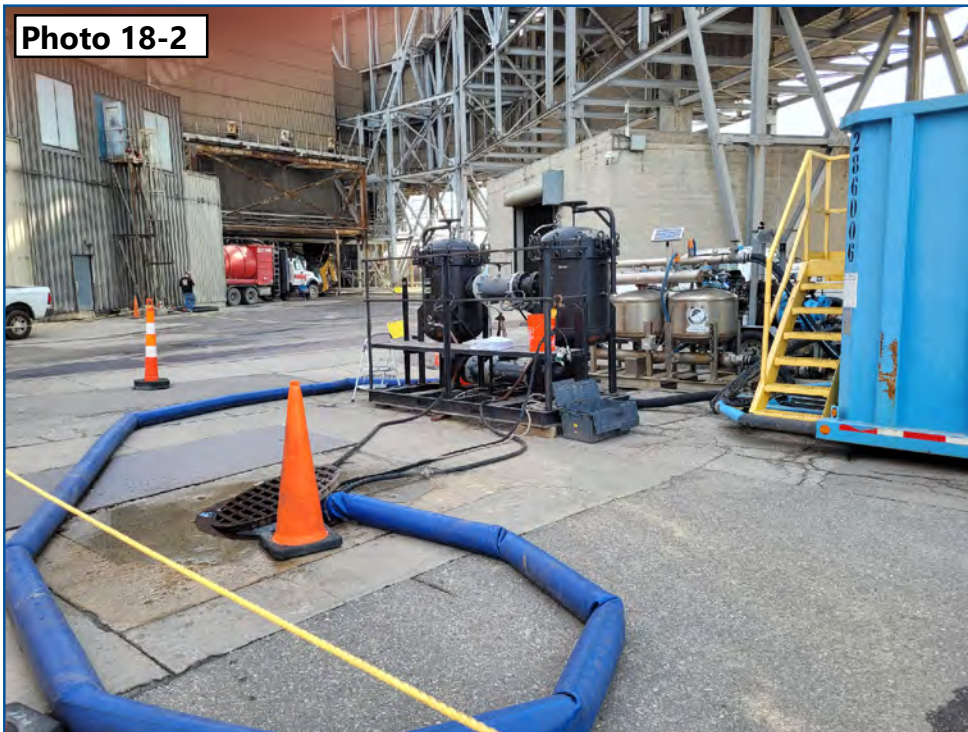

18 of 269
**CONSTRUCTION
MONITORING**
PHOTO LOCATIONS
St. Clair Power Plant
DTE Energy
East China, Michigan

Aerial Image: NearMap (8/10/2022)
NOTE: Photo locations are approximate.

Date: 8/26/2022
Note: General Site Photo

Photo 18-1 Caption:
Water treatment system set up to treat process water pumped from the basins during basin dewatering

Photo 18-2 Caption:
Process water from the basins was treated onsite and discharged to outfall 001D in accordance with the plant's NPDES permit

Photo 19-1



Photo 19-2

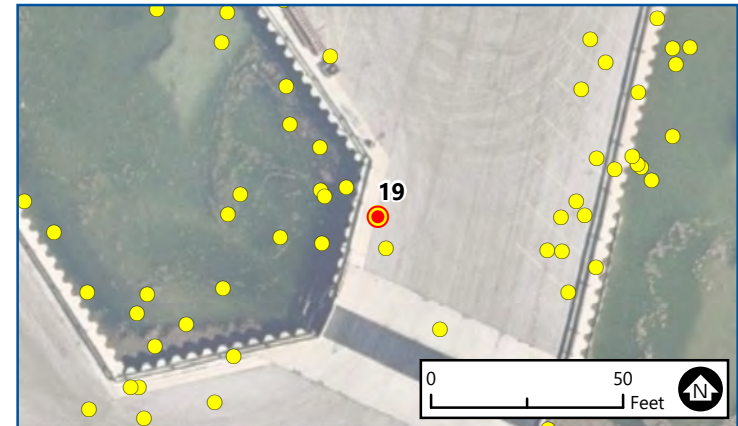

19 of 269
**CONSTRUCTION
MONITORING**
PHOTO LOCATIONS
St. Clair Power Plant
DTE Energy
East China, Michigan

Aerial Image: NearMap (8/10/2022)
NOTE: Photo locations are approximate.

Date: 11/16/2022
Note: General Site Photo

Photo 19-1 Caption:
Portable cement silo

Photo 19-2 Caption:
Cement mixing hopper

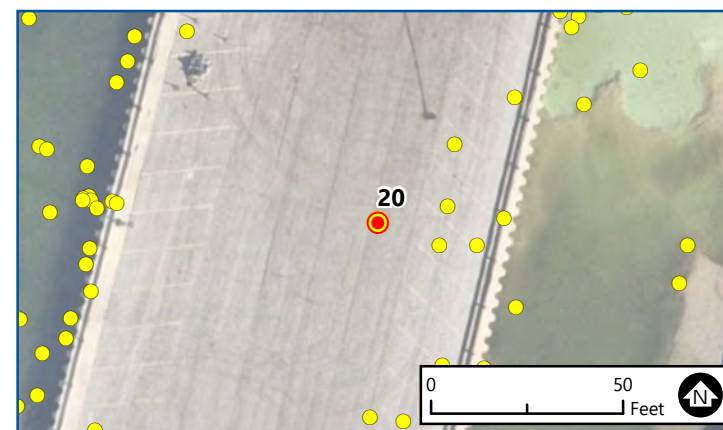

20 of 269
**CONSTRUCTION
MONITORING**
PHOTO LOCATIONS
St. Clair Power Plant
DTE Energy
East China, Michigan

Date: 11/16/2022
Note: Mixing Cement

Photo 20-1 Caption:
East basin initial cement and CCR mix
zone along east side

Aerial Image: NearMap (8/10/2022)
NOTE: Photo locations are approximate.

Photo 21-1



Photo 21-2

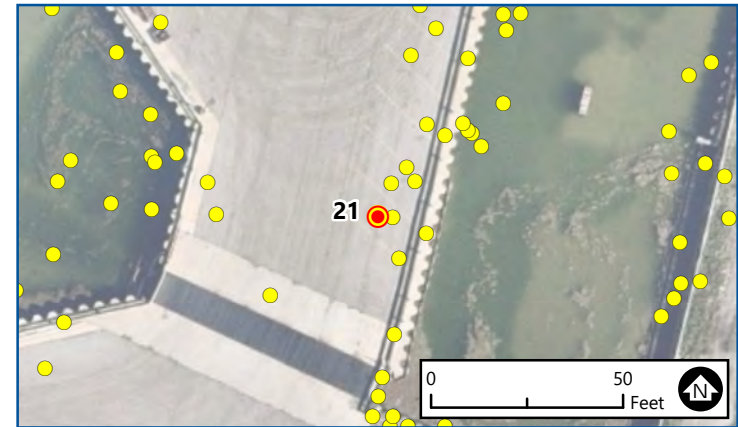

21 of 269
**CONSTRUCTION
MONITORING**
PHOTO LOCATIONS
St. Clair Power Plant
DTE Energy
East China, Michigan

Aerial Image: NearMap (8/10/2022)
NOTE: Photo locations are approximate.

Date: 11/23/2022
Note: Mixing Cement
Photo 21-1 Caption:
Mixing system
Photo 21-2 Caption:
Mixing system

Photo 22-1



Photo 22-2

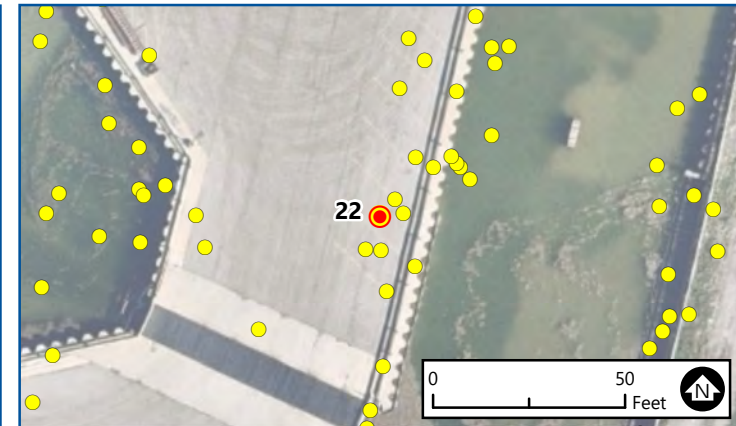

22 of 269
**CONSTRUCTION
MONITORING**
PHOTO LOCATIONS
St. Clair Power Plant
DTE Energy
East China, Michigan

Aerial Image: NearMap (8/10/2022)
NOTE: Photo locations are approximate.

Date: 11/23/2022
Note: Mixing Cement

Photo 22-1 Caption:
Cement injection and mixing

Photo 22-2 Caption:
Mixing in the East basin

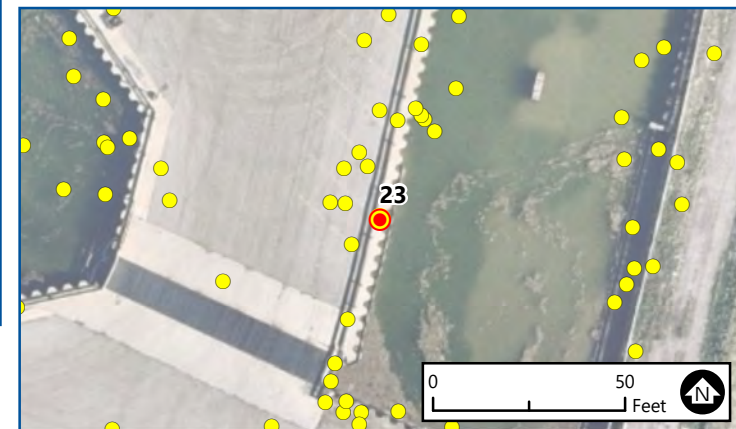

23 of 269
**CONSTRUCTION
MONITORING**
PHOTO LOCATIONS
St. Clair Power Plant
DTE Energy
East China, Michigan

Aerial Image: NearMap (8/10/2022)
NOTE: Photo locations are approximate.

Date: 11/23/2022
Note: Mixing Cement

Photo 23-1 Caption:
General site photo, dewatering and mixing



Photo 24-1

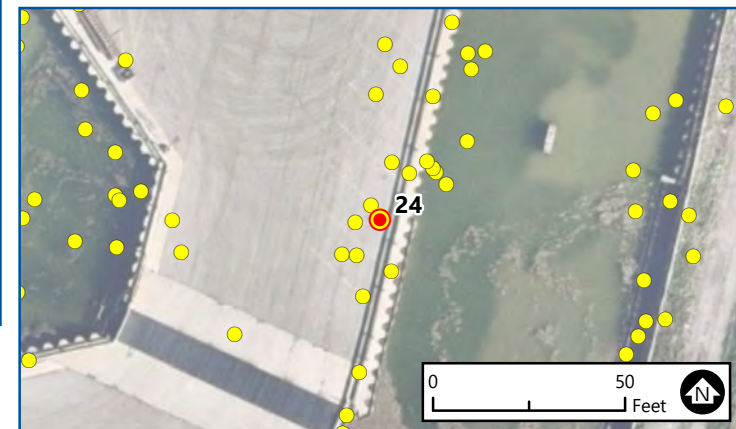

24 of 269
**CONSTRUCTION
MONITORING**
PHOTO LOCATIONS
St. Clair Power Plant
DTE Energy
East China, Michigan

Date: 11/23/2022
Note: Mixing Cement

Photo 24-1 Caption:
Cement injection and mixing in
background

Aerial Image: NearMap (8/10/2022)
NOTE: Photo locations are approximate.

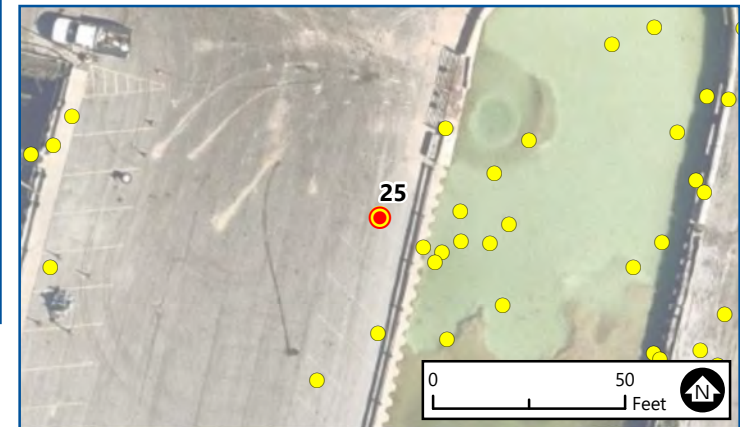

25 of 269
**CONSTRUCTION
MONITORING**
PHOTO LOCATIONS
St. Clair Power Plant
DTE Energy
East China, Michigan

Date: 11/16/2022
Note: General Site Photo
Photo 25-1 Caption:
East basin mixed CCR and cement

Aerial Image: NearMap (8/10/2022)
NOTE: Photo locations are approximate.



Photo 26-1

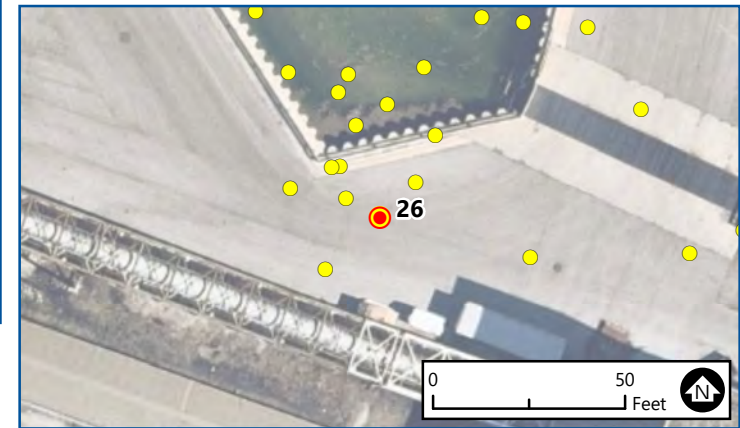

26 of 269
**CONSTRUCTION
MONITORING**
PHOTO LOCATIONS
St. Clair Power Plant
DTE Energy
East China, Michigan

Date: 11/28/2022
Note: General Site Photo

Photo 26-1 Caption:
West basin initial cement and CCR mixed

Aerial Image: NearMap (8/10/2022)
NOTE: Photo locations are approximate.

Photo 27-1



Photo 27-2



27 of 269
**CONSTRUCTION
MONITORING**
PHOTO LOCATIONS
St. Clair Power Plant
DTE Energy
East China, Michigan

Aerial Image: NearMap (8/10/2022)
NOTE: Photo locations are approximate.

Date: 12/5/2022
Note: General Site Photo
Photo 27-1 Caption:
West basin initial cement and CCR mixed
Photo 27-2 Caption:
Sheet pile wall status

Photo 28-1



Photo 28-2

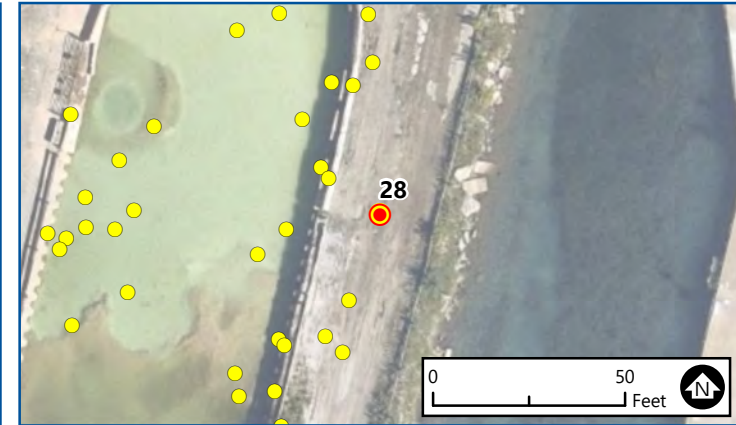

28 of 269
**CONSTRUCTION
MONITORING**
PHOTO LOCATIONS
St. Clair Power Plant
DTE Energy
East China, Michigan

Aerial Image: NearMap (8/10/2022)
NOTE: Photo locations are approximate.

Date: 11/16/2022
Note: General Site Photo

Photo 28-1 Caption:
Erosion control

Photo 28-2 Caption:
Erosion control



Photo 29-1

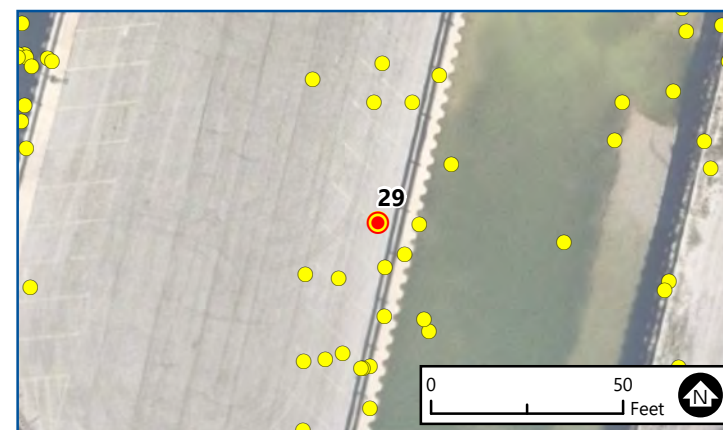
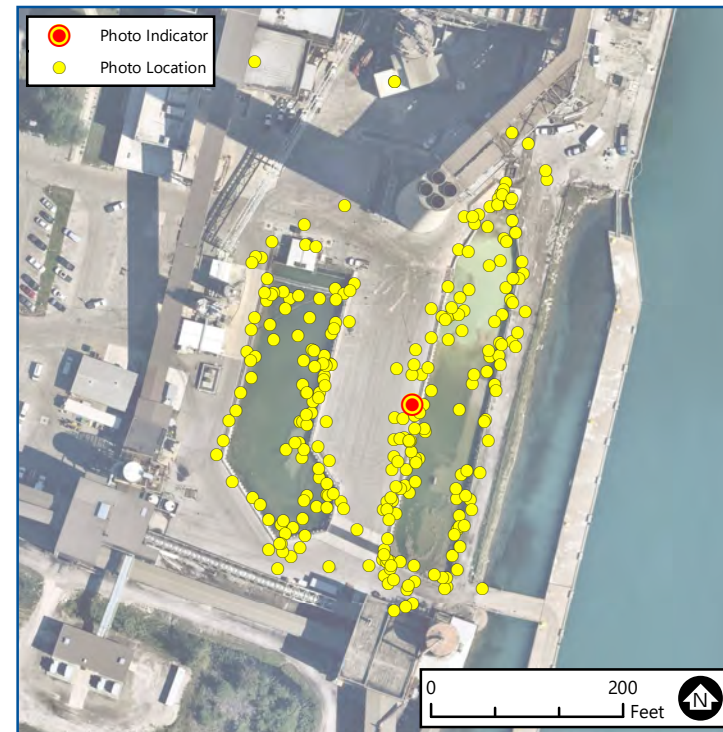

29 of 269
**CONSTRUCTION
MONITORING**
PHOTO LOCATIONS
St. Clair Power Plant
DTE Energy
East China, Michigan

Aerial Image: NearMap (8/10/2022)
NOTE: Photo locations are approximate.

Date: 12/21/2022
Note: General Site Photo

Photo 29-1 Caption:
Compaction of east basin backfill by
sheepsfoot roller



Photo 30-1



30 of 269
**CONSTRUCTION
MONITORING**
PHOTO LOCATIONS
St. Clair Power Plant
DTE Energy
East China, Michigan

Aerial Image: NearMap (8/10/2022)
NOTE: Photo locations are approximate.

Date: 12/22/2022
Note: General Site Photo
Photo 30-1 Caption:
Site sweeping for dust control



Photo 31-1

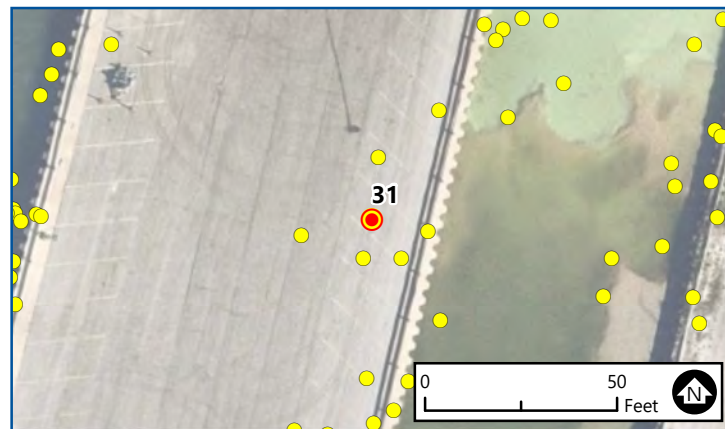
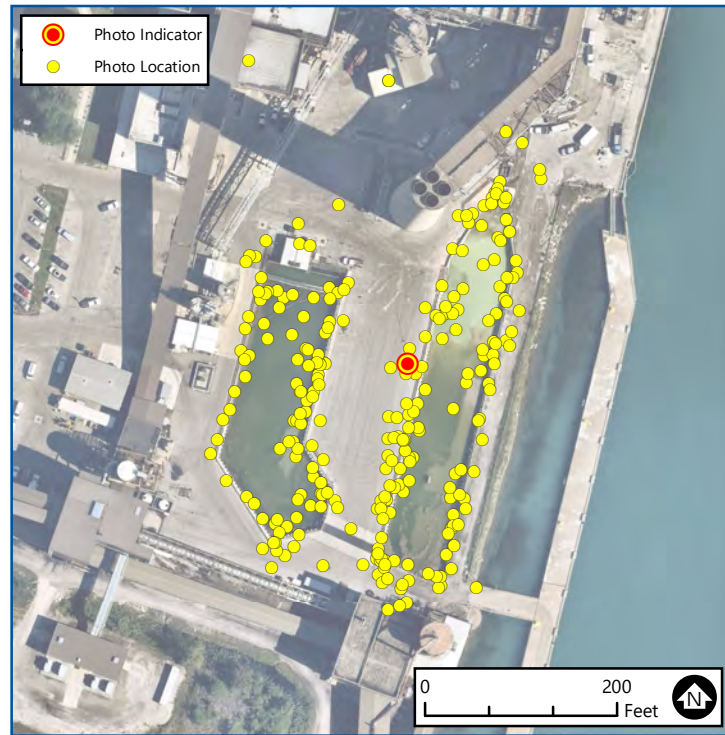

31 of 269
**CONSTRUCTION
MONITORING**
PHOTO LOCATIONS
St. Clair Power Plant
DTE Energy
East China, Michigan

Aerial Image: NearMap (8/10/2022)
NOTE: Photo locations are approximate.

Date: 12/22/2022
Note: General Site Photo

Photo 31-1 Caption:
Dozer D6N used to spread backfill in the basins

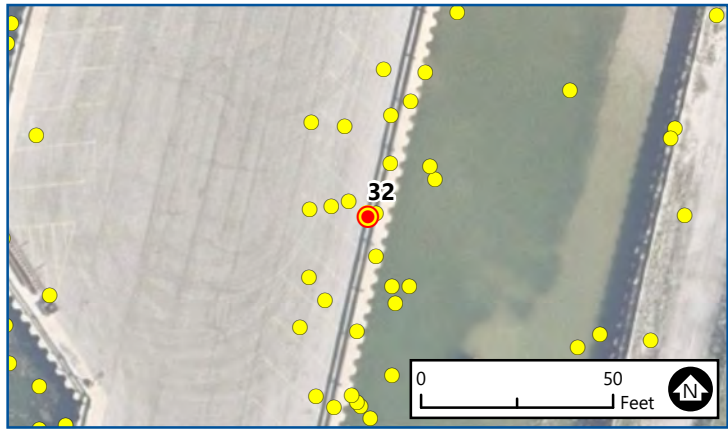
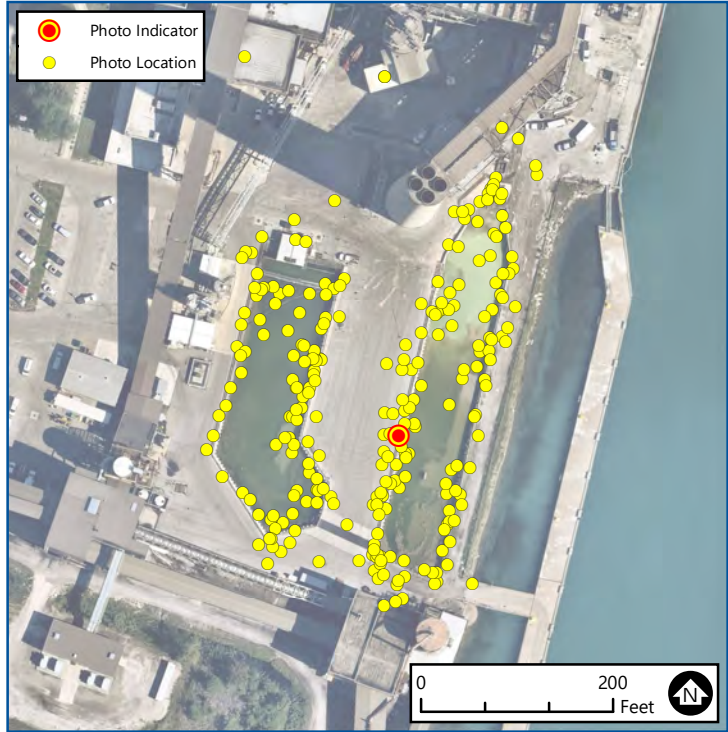

32 of 269
**CONSTRUCTION
MONITORING**
PHOTO LOCATIONS
St. Clair Power Plant
DTE Energy
East China, Michigan

Aerial Image: NearMap (8/10/2022)
NOTE: Photo locations are approximate.

Date: 12/22/2022
Note: General Site Photo

Photo 32-1 Caption:
CAT Mini 305.5E used to scrape CCR
from face of sheet pile wall and East
basin overflow canal, as well as
compacting backfill in the overflow canal

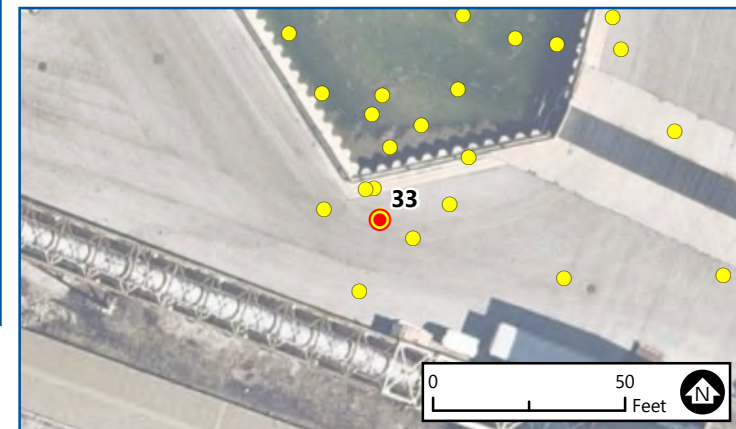

33 of 269
**CONSTRUCTION
MONITORING**
PHOTO LOCATIONS
St. Clair Power Plant
DTE Energy
East China, Michigan

Aerial Image: NearMap (8/10/2022)
NOTE: Photo locations are approximate.

Date: 12/22/2022
Note: General Site Photo

Photo 33-1 Caption:
CAT 336E excavator used to excavate
CCR and assist with basin backfilling

Photo 34-1



Photo 34-2

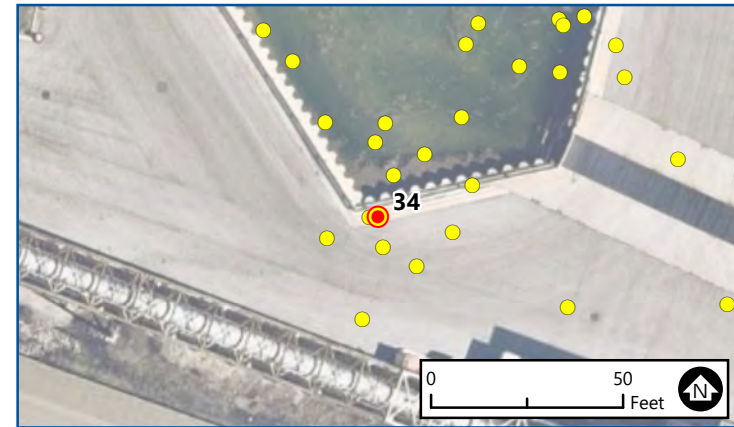

34 of 269
**CONSTRUCTION
MONITORING**
PHOTO LOCATIONS
St. Clair Power Plant
DTE Energy
East China, Michigan

Date: 12/22/2022
Note: General Site Photo

Photo 34-1 Caption:
CAT 349E excavator used to remove CCR
from the basins and load trucks

Photo 34-2 Caption:
CAT 349E excavator used to remove CCR
from the basins and load trucks

Aerial Image: NearMap (8/10/2022)
NOTE: Photo locations are approximate.



Photo 35-1

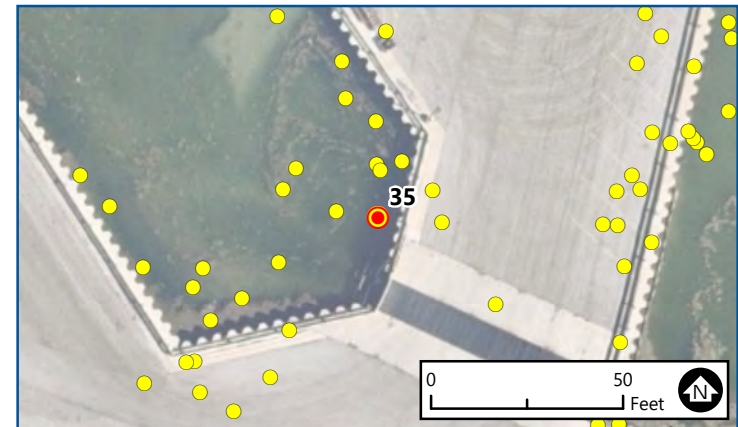
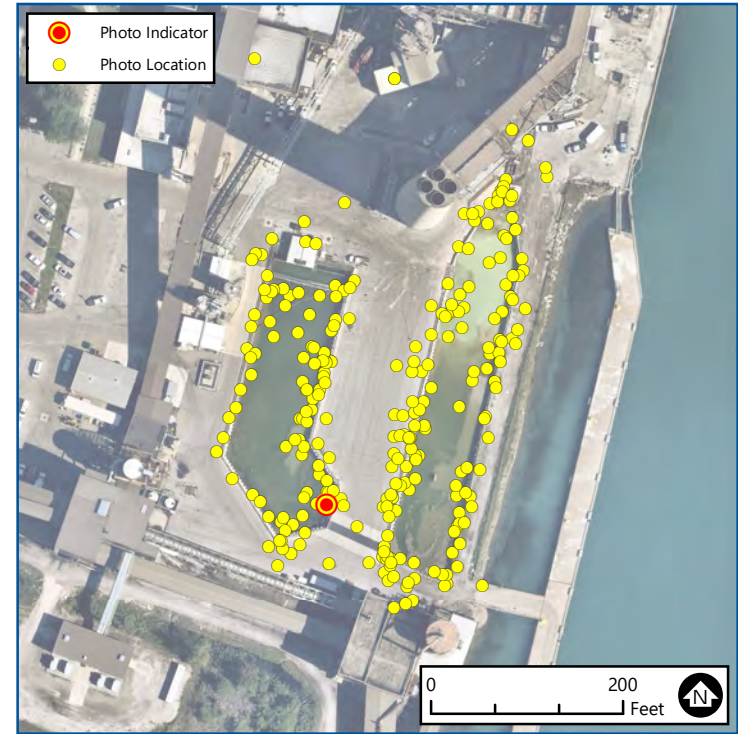

35 of 269
**CONSTRUCTION
MONITORING**
PHOTO LOCATIONS
St. Clair Power Plant
DTE Energy
East China, Michigan

Date: 12/22/2022
Note: General Site Photo

Photo 35-1 Caption:
Truck unloading soil for basin backfill

Aerial Image: NearMap (8/10/2022)
NOTE: Photo locations are approximate.



36 of 269
**CONSTRUCTION
MONITORING**
PHOTO LOCATIONS
St. Clair Power Plant
DTE Energy
East China, Michigan

Aerial Image: NearMap (8/10/2022)
NOTE: Photo locations are approximate.

Date: 12/22/2022
Note: General Site Photo

Photo 36-1 Caption:
CAT 938M loader used to push soil
backfill into the basins

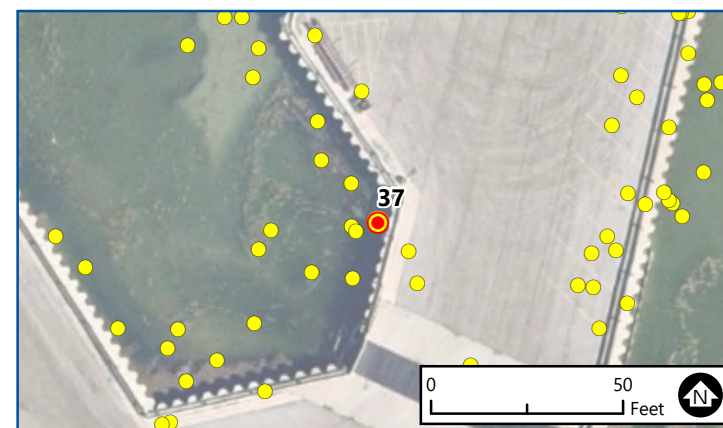
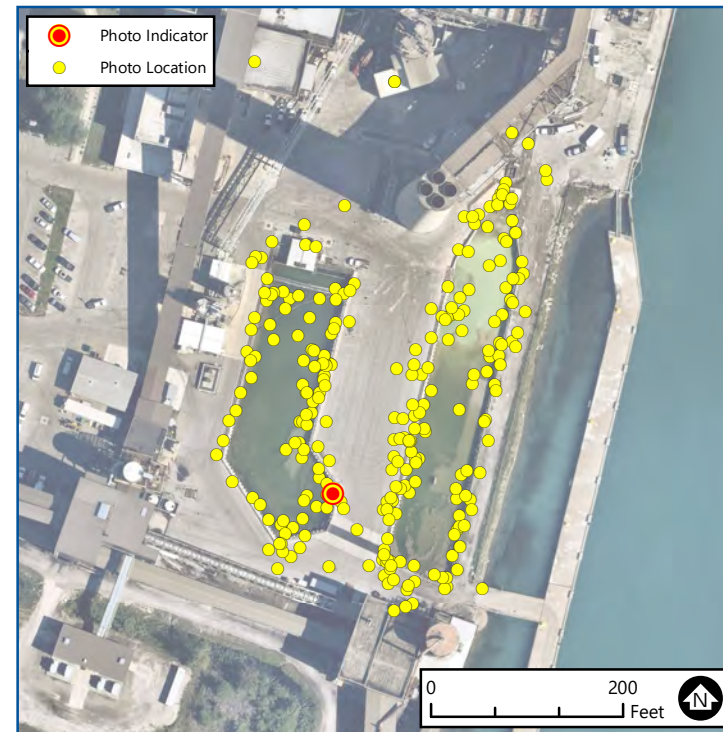

37 of 269
**CONSTRUCTION
MONITORING**
PHOTO LOCATIONS
St. Clair Power Plant
DTE Energy
East China, Michigan

Aerial Image: NearMap (8/10/2022)
NOTE: Photo locations are approximate.

Date: 12/22/2022
Note: General Site Photo

Photo 37-1 Caption:
Excavator with hole packer 321 D, used
to compact backfill in excavated cells



38 of 269
**CONSTRUCTION
MONITORING**
PHOTO LOCATIONS
St. Clair Power Plant
DTE Energy
East China, Michigan

Aerial Image: NearMap (8/10/2022)
NOTE: Photo locations are approximate.

Date: 1/7/2023
Note: General Site Photo
Photo 38-1 Caption:
St. Clair River adjacent to the East basin

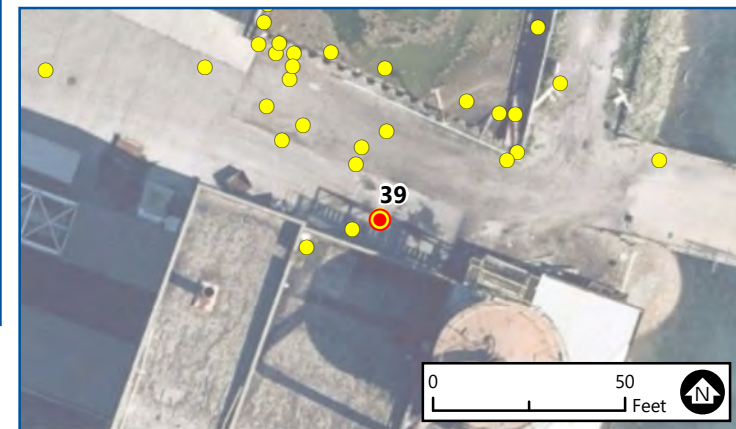

39 of 269
**CONSTRUCTION
MONITORING**
PHOTO LOCATIONS
St. Clair Power Plant
DTE Energy
East China, Michigan

Aerial Image: NearMap (8/10/2022)
NOTE: Photo locations are approximate.

Date: 11/21/2022

Note: East Basin

Photo 39-1 Caption:
E1, excavated to clay, looking east

Photo 40-1

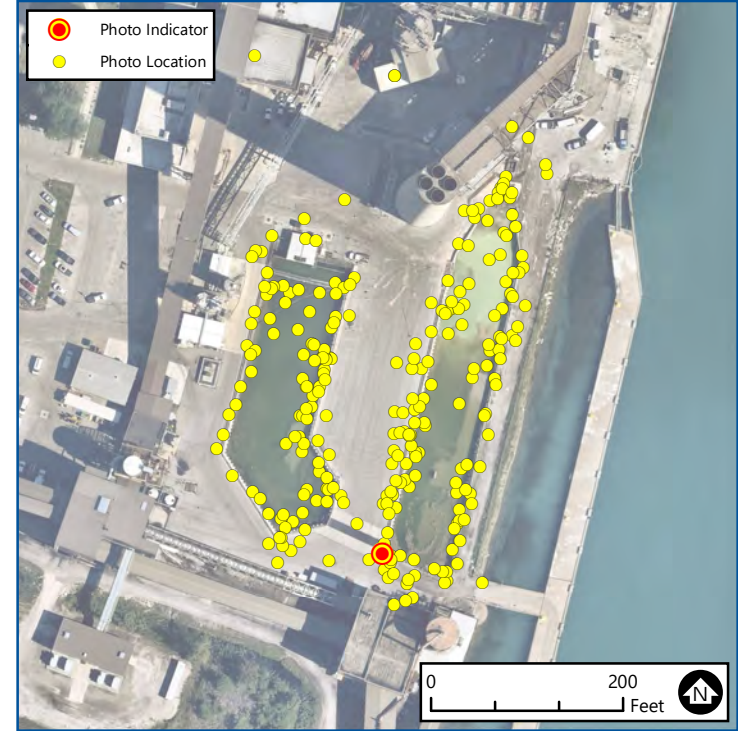
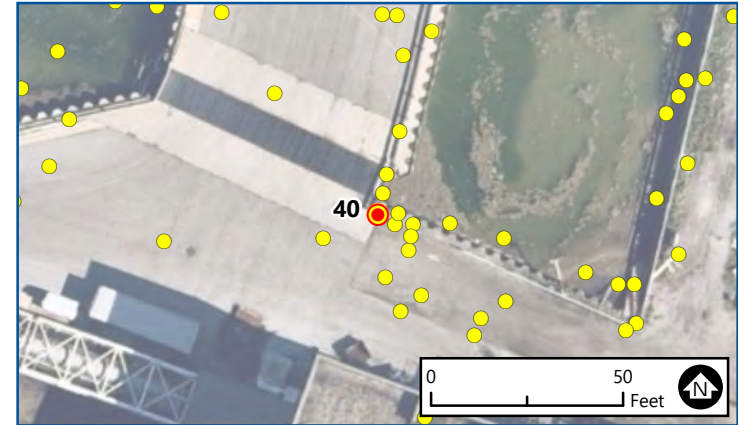

Photo 40-2



40 of 269
**CONSTRUCTION
MONITORING**
PHOTO LOCATIONS
St. Clair Power Plant
DTE Energy
East China, Michigan

Aerial Image: NearMap (8/10/2022)
NOTE: Photo locations are approximate.

Date: 11/21/2022

Note: East Basin

Photo 40-1 Caption:
E1, excavated to clay, looking west

Photo 40-2 Caption:
E1, excavated to clay, looking west

Photo 41-1



Photo 41-2

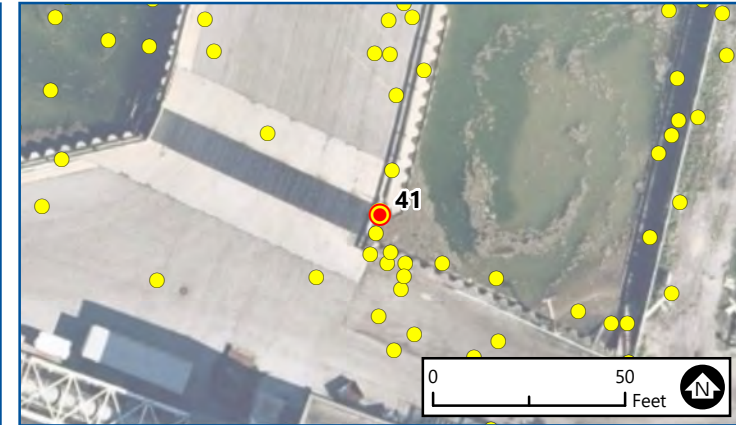

41 of 269
**CONSTRUCTION
MONITORING**
PHOTO LOCATIONS
St. Clair Power Plant
DTE Energy
East China, Michigan

Aerial Image: NearMap (8/10/2022)
NOTE: Photo locations are approximate.

Date: 11/22/2022

Note: East Basin

Photo 41-1 Caption:
E2, excavated to clay, looking east

Photo 41-2 Caption:
E2, excavated to clay, looking east



Photo 42-1

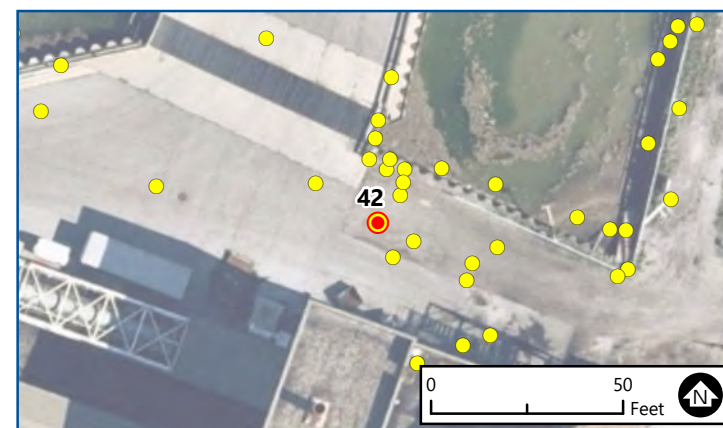

42 of 269
**CONSTRUCTION
MONITORING**
PHOTO LOCATIONS
St. Clair Power Plant
DTE Energy
East China, Michigan

Date: 11/22/2022

Note: East Basin

Photo 42-1 Caption:
E2, excavated to clay, looking west

Aerial Image: NearMap (8/10/2022)
NOTE: Photo locations are approximate.

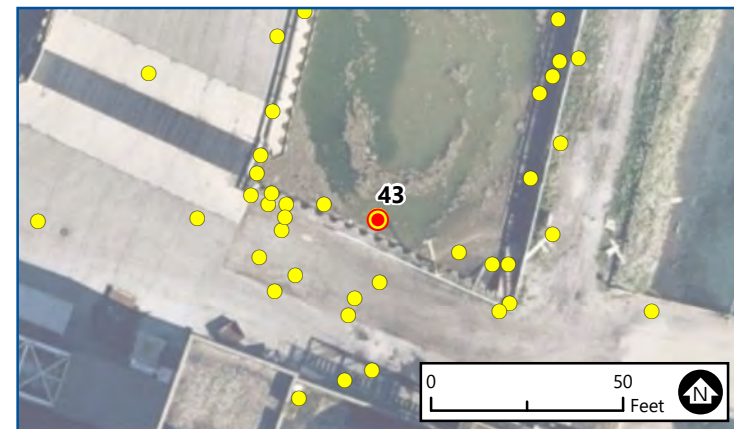

43 of 269
**CONSTRUCTION
MONITORING**
PHOTO LOCATIONS
St. Clair Power Plant
DTE Energy
East China, Michigan

Date: 11/22/2022

Note: East Basin

Photo 43-1 Caption:
E3, excavated to clay, looking NE

Aerial Image: NearMap (8/10/2022)
NOTE: Photo locations are approximate.

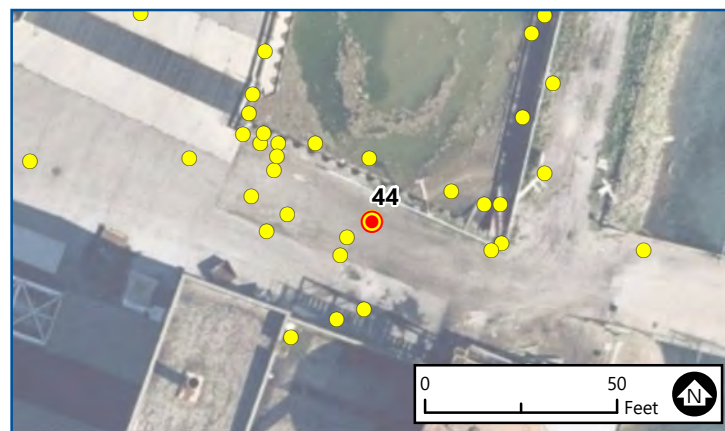
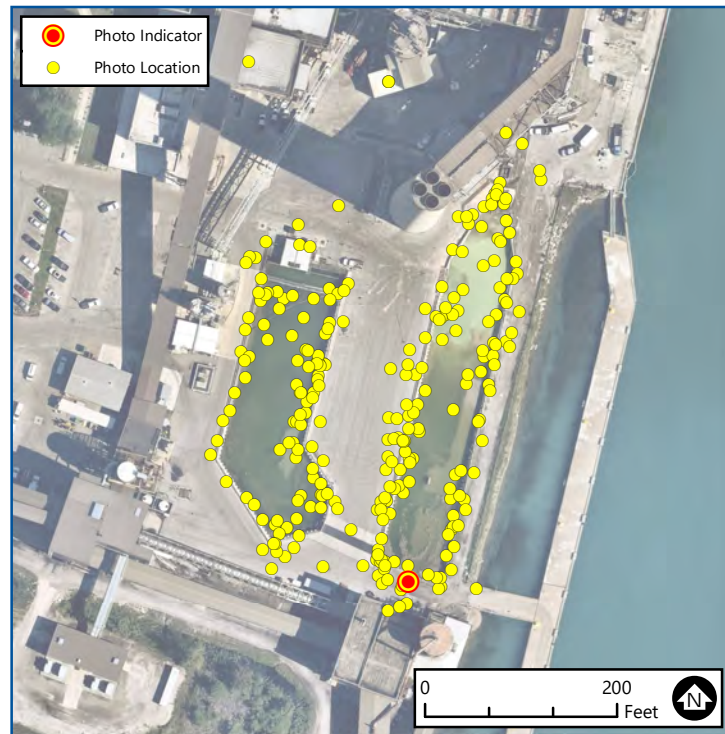

44 of 269
**CONSTRUCTION
MONITORING**
PHOTO LOCATIONS
St. Clair Power Plant
DTE Energy
East China, Michigan

Date: 11/22/2022

Note: East Basin

Photo 44-1 Caption:
E3, excavated to clay, looking east

Aerial Image: NearMap (8/10/2022)
NOTE: Photo locations are approximate.

Photo 45-1

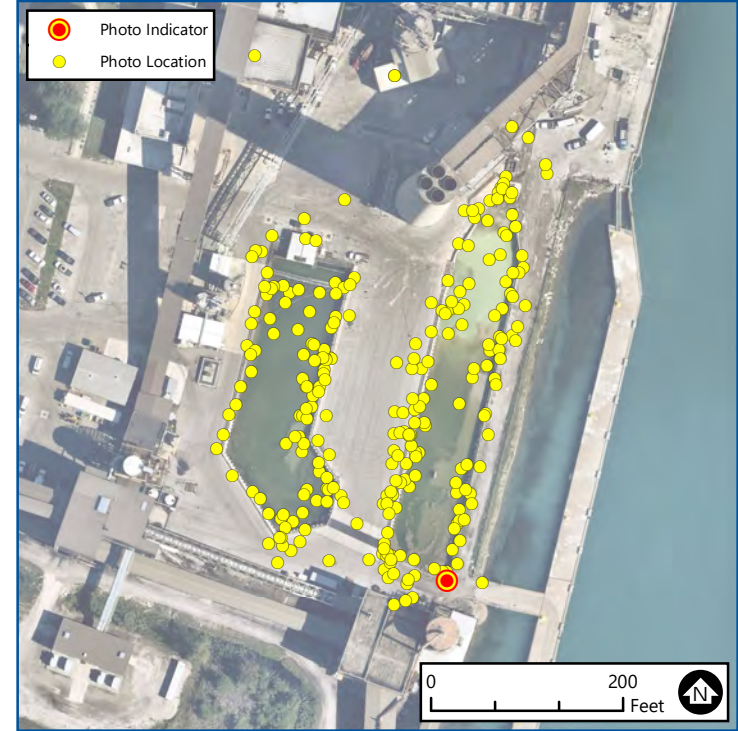
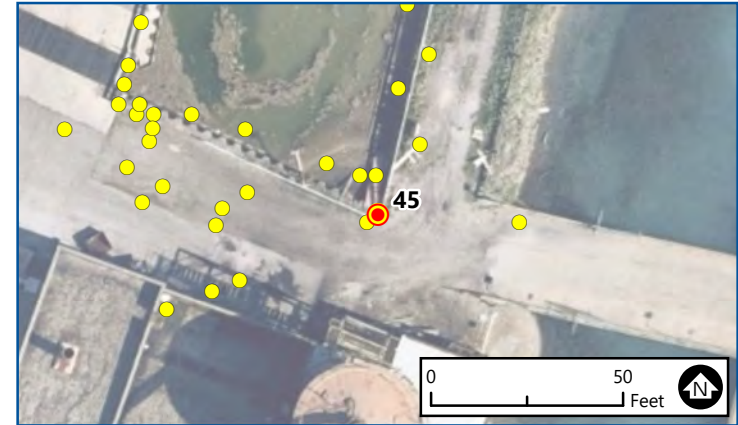

Photo 45-2



45 of 269
**CONSTRUCTION
MONITORING**
PHOTO LOCATIONS
St. Clair Power Plant
DTE Energy
East China, Michigan

Aerial Image: NearMap (8/10/2022)
NOTE: Photo locations are approximate.

Date: 11/22/2022

Note: East Basin

Photo 45-1 Caption:
E3, excavated to clay, looking north

Photo 45-2 Caption:
E3, excavated to clay, looking north

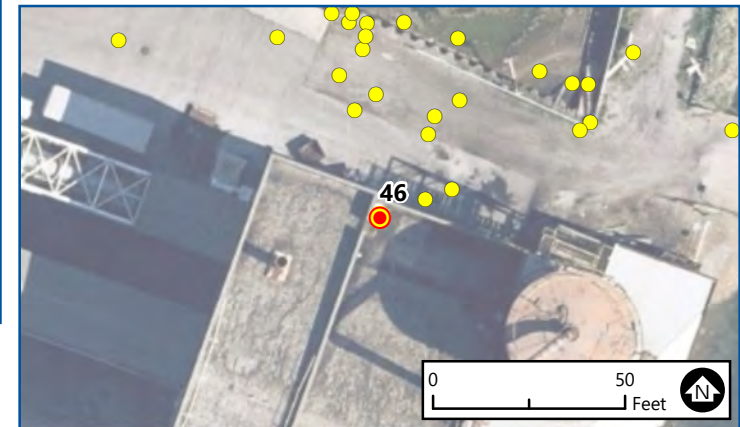

46 of 269
**CONSTRUCTION
MONITORING**
PHOTO LOCATIONS
St. Clair Power Plant
DTE Energy
East China, Michigan

Date: 11/23/2022

Note: East Basin

Photo 46-1 Caption:
E4, excavated to clay, looking NE

Aerial Image: NearMap (8/10/2022)
NOTE: Photo locations are approximate.

Photo 47-1



Photo 47-2

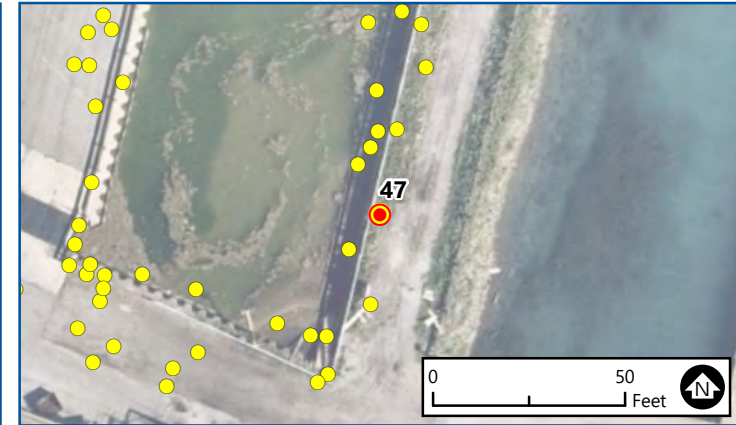

47 of 269
**CONSTRUCTION
MONITORING**
PHOTO LOCATIONS
St. Clair Power Plant
DTE Energy
East China, Michigan

Aerial Image: NearMap (8/10/2022)
NOTE: Photo locations are approximate.

Date: 11/23/2022

Note: East Basin

Photo 47-1 Caption:
E4, excavated to clay, looking west

Photo 47-2 Caption:
E4, excavated to clay, looking west

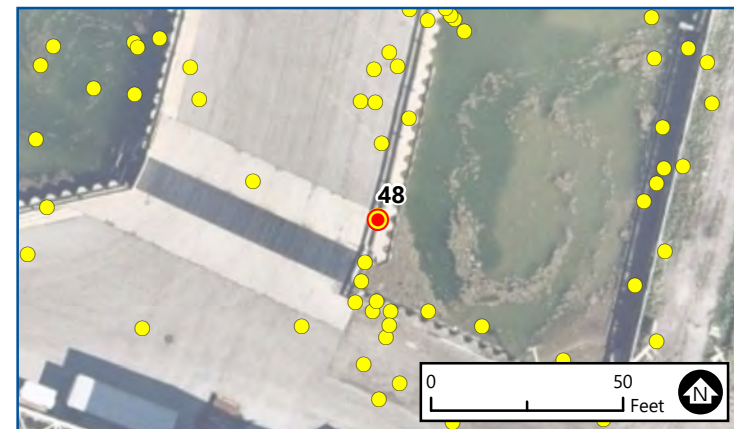

48 of 269
**CONSTRUCTION
MONITORING**
PHOTO LOCATIONS
St. Clair Power Plant
DTE Energy
East China, Michigan

Date: 11/23/2022

Note: East Basin

Photo 48-1 Caption:
E5, excavated to clay, looking north

Aerial Image: NearMap (8/10/2022)
NOTE: Photo locations are approximate.



49 of 269
**CONSTRUCTION
MONITORING**
PHOTO LOCATIONS
St. Clair Power Plant
DTE Energy
East China, Michigan

Date: 11/23/2022

Note: East Basin

Photo 49-1 Caption:
E5, excavated to clay, looking west

Aerial Image: NearMap (8/10/2022)
NOTE: Photo locations are approximate.

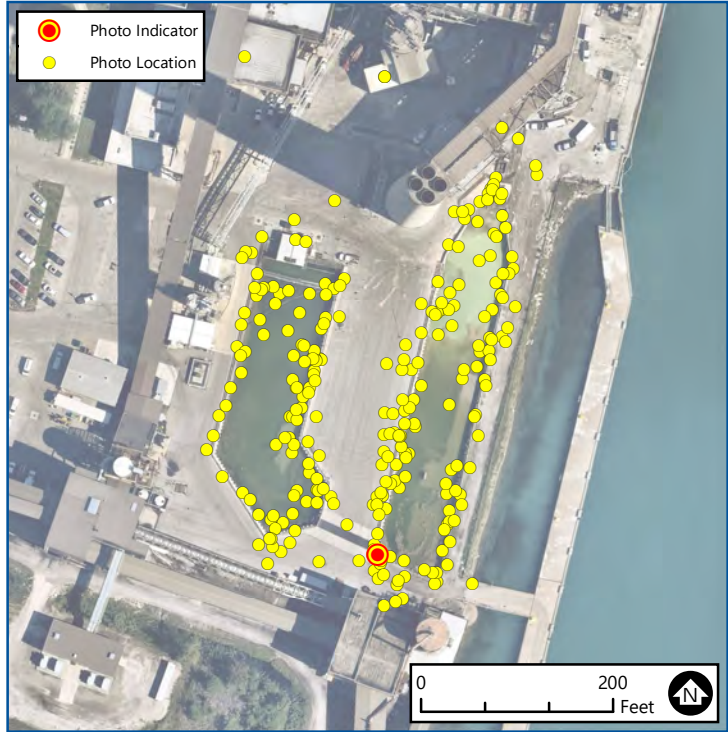

50 of 269
**CONSTRUCTION
MONITORING**
PHOTO LOCATIONS
St. Clair Power Plant
DTE Energy
East China, Michigan

Aerial Image: NearMap (8/10/2022)
NOTE: Photo locations are approximate.

Date: 11/23/2022

Note: East Basin

Photo 50-1 Caption:
E6, excavated to clay, looking NE



Photo 51-1

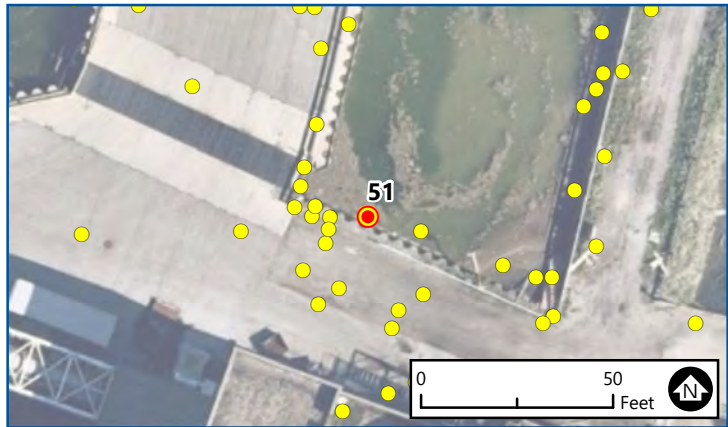
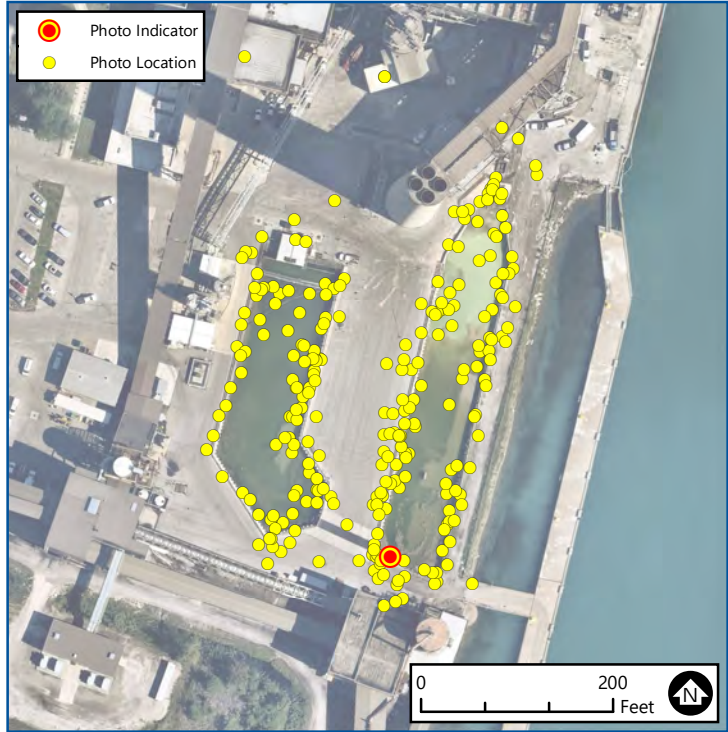

51 of 269
CONSTRUCTION MONITORING
PHOTO LOCATIONS
St. Clair Power Plant
DTE Energy
East China, Michigan

Date: 11/23/2022
Note: East Basin
Photo 51-1 Caption:
E6, excavated to clay, looking north

Aerial Image: NearMap (8/10/2022)
NOTE: Photo locations are approximate.

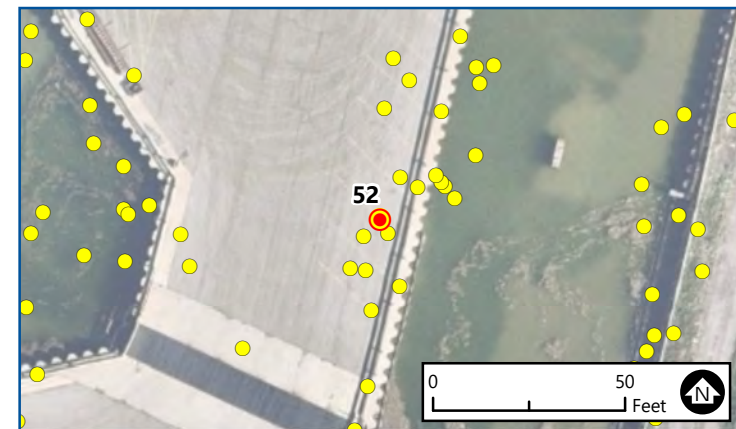

52 of 269
**CONSTRUCTION
MONITORING**
PHOTO LOCATIONS
St. Clair Power Plant
DTE Energy
East China, Michigan

Date: 11/25/2022

Note: East Basin

Photo 52-1 Caption:
E7, excavated to clay, looking east

Aerial Image: NearMap (8/10/2022)
NOTE: Photo locations are approximate.

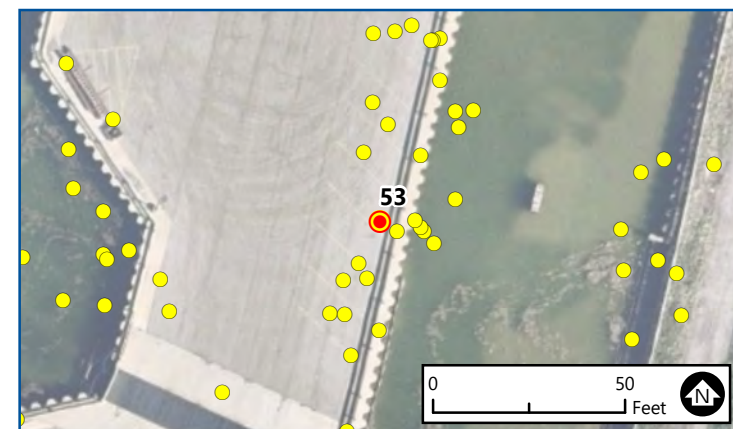

53 of 269
**CONSTRUCTION
MONITORING**
PHOTO LOCATIONS
St. Clair Power Plant
DTE Energy
East China, Michigan

Date: 11/27/2022

Note: East Basin

Photo 53-1 Caption:
E8, excavated to clay, looking east

Aerial Image: NearMap (8/10/2022)
NOTE: Photo locations are approximate.

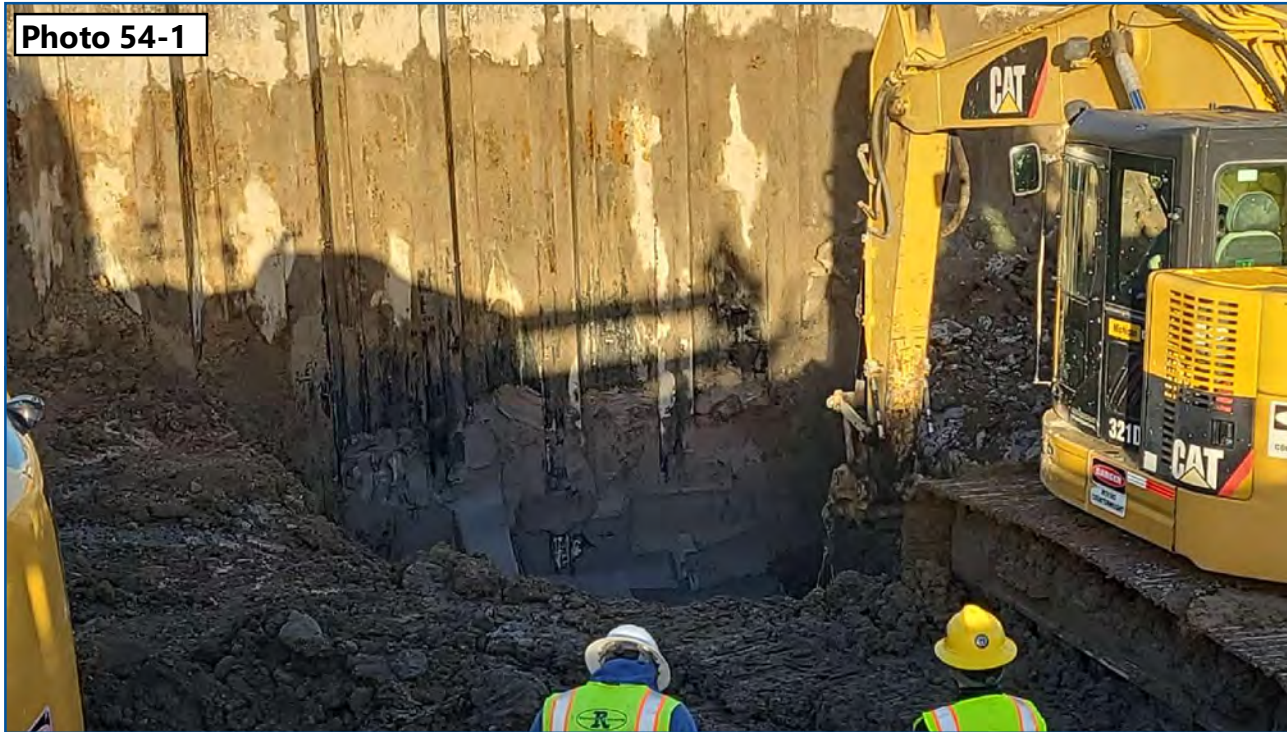
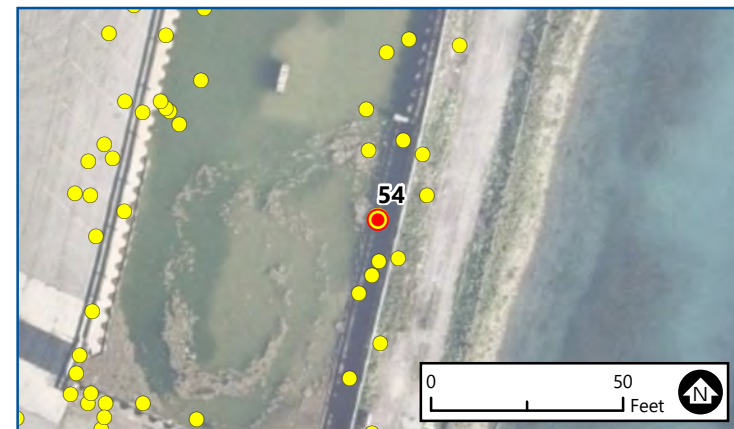
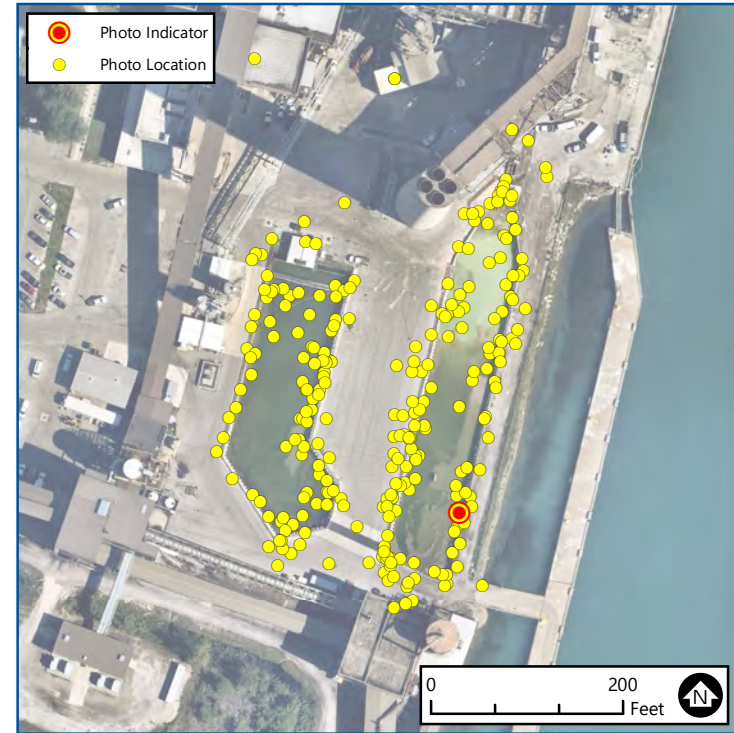

Photo 54-1



54 of 269
**CONSTRUCTION
MONITORING**
PHOTO LOCATIONS
St. Clair Power Plant
DTE Energy
East China, Michigan

Date: 11/28/2022

Note: East Basin

Photo 54-1 Caption:
E9, excavated to clay, looking NW

Aerial Image: NearMap (8/10/2022)
NOTE: Photo locations are approximate.

Photo 55-1



Photo 55-2



55 of 269
**CONSTRUCTION
MONITORING**
PHOTO LOCATIONS
St. Clair Power Plant
DTE Energy
East China, Michigan

Aerial Image: NearMap (8/10/2022)
NOTE: Photo locations are approximate.

Date: 11/28/2022

Note: East Basin

Photo 55-1 Caption:
E9, excavated to clay, looking east

Photo 55-2 Caption:
E9, excavated to clay, looking east

Photo 56-1



Photo 56-2



56 of 269
**CONSTRUCTION
MONITORING**
PHOTO LOCATIONS
St. Clair Power Plant
DTE Energy
East China, Michigan

Aerial Image: NearMap (8/10/2022)
NOTE: Photo locations are approximate.

Date: 12/1/2022

Note: East Basin

Photo 56-1 Caption:
E10, excavated to clay, looking east

Photo 56-2 Caption:
E10, excavated to clay, looking east



Photo 57-1

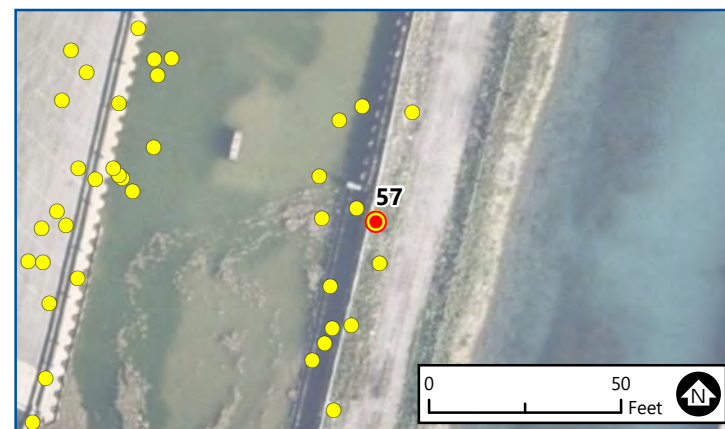
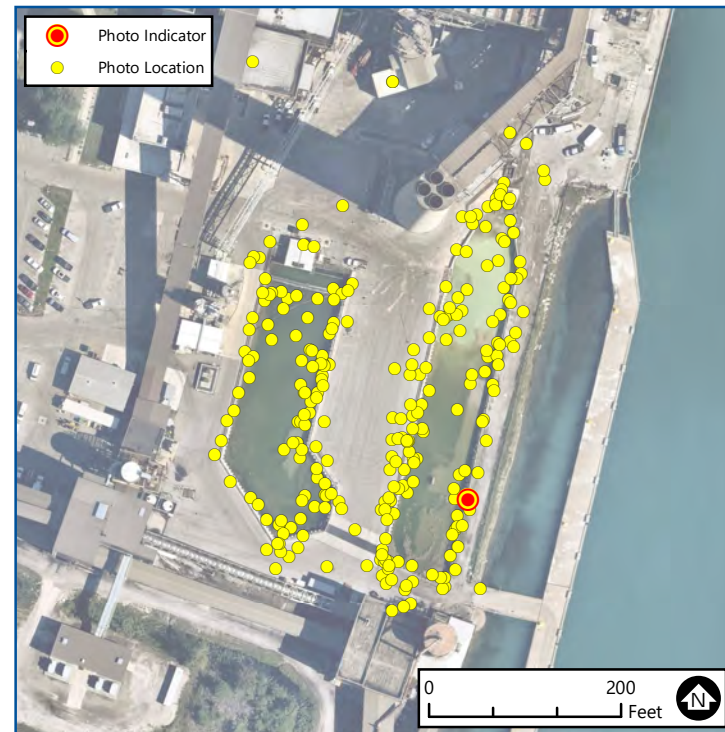

57 of 269
**CONSTRUCTION
MONITORING**
PHOTO LOCATIONS
St. Clair Power Plant
DTE Energy
East China, Michigan

Date: 12/1/2022
Note: East Basin

Photo 57-1 Caption:
E10, excavated to clay, looking west

Aerial Image: NearMap (8/10/2022)
NOTE: Photo locations are approximate.

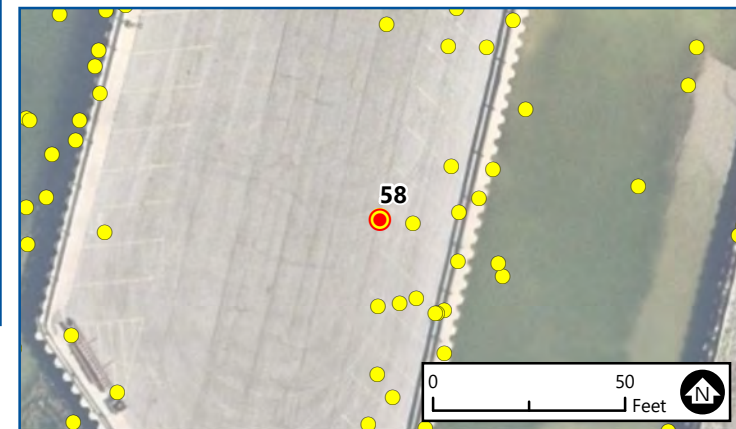

58 of 269
**CONSTRUCTION
MONITORING**
PHOTO LOCATIONS
St. Clair Power Plant
DTE Energy
East China, Michigan

Aerial Image: NearMap (8/10/2022)
NOTE: Photo locations are approximate.

Date: 12/1/2022
Note: East Basin

Photo 58-1 Caption:
North portion of the East basin - CCR
removal to Elev. 572'

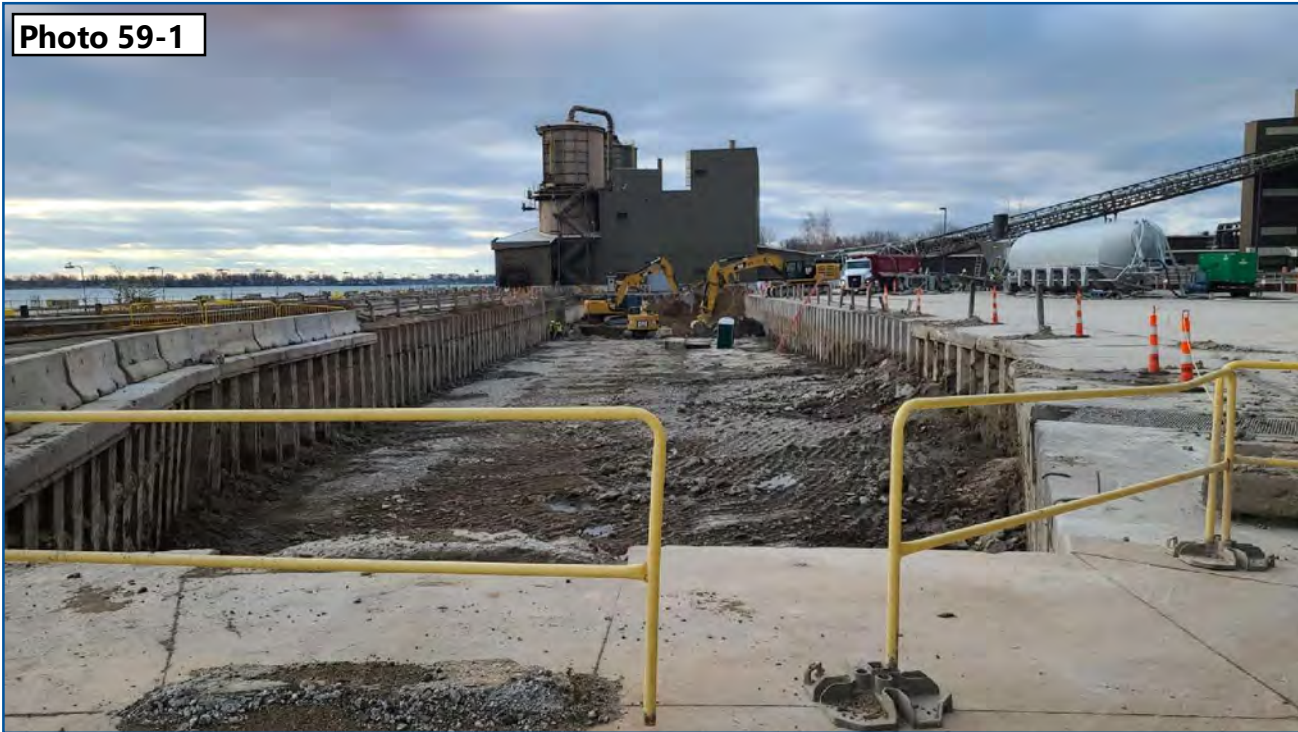
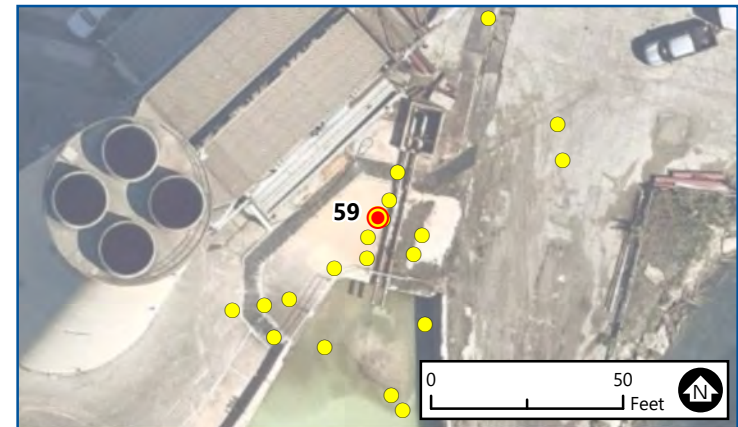

Photo 59-1



59 of 269
**CONSTRUCTION
MONITORING**
PHOTO LOCATIONS
St. Clair Power Plant
DTE Energy
East China, Michigan

Aerial Image: NearMap (8/10/2022)
NOTE: Photo locations are approximate.

Date: 12/1/2022
Note: East Basin

Photo 59-1 Caption:
East basin - CCR removal to Elev. 572',
viewed from north to south

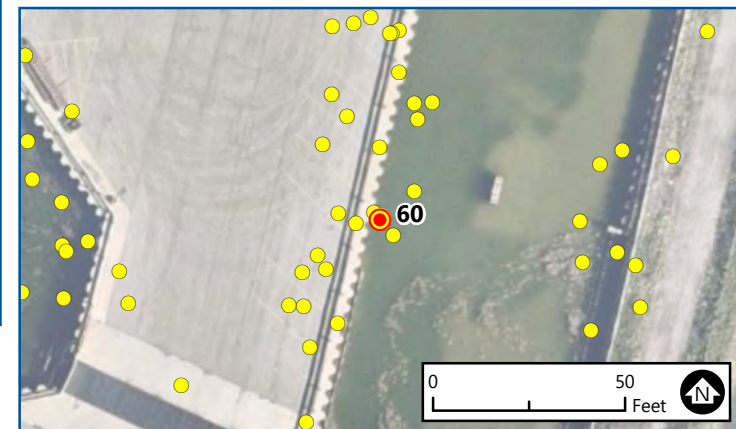

60 of 269
**CONSTRUCTION
MONITORING**
PHOTO LOCATIONS
St. Clair Power Plant
DTE Energy
East China, Michigan

Date: 12/1/2022

Note: East Basin

Photo 60-1 Caption:
E11, excavated to clay, looking east

Aerial Image: NearMap (8/10/2022)
NOTE: Photo locations are approximate.



Photo 61-1

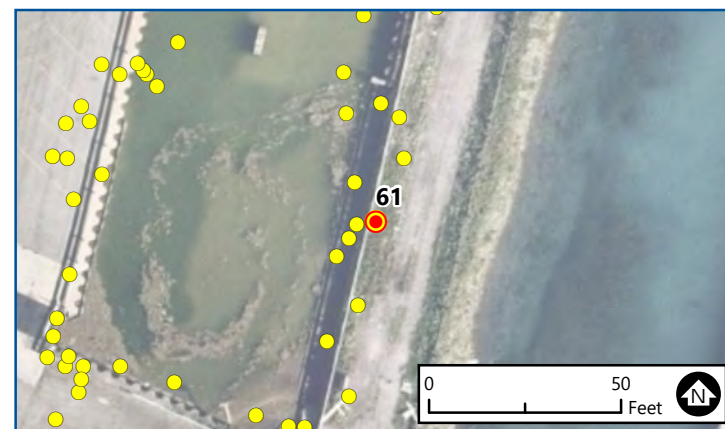
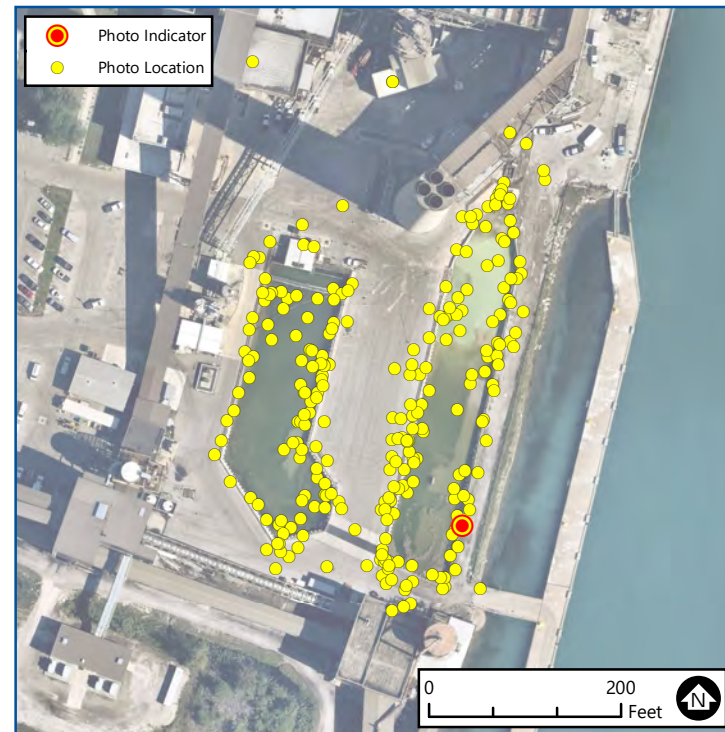

61 of 269
**CONSTRUCTION
MONITORING**
PHOTO LOCATIONS
St. Clair Power Plant
DTE Energy
East China, Michigan

Date: 12/1/2022
Note: East Basin

Photo 61-1 Caption:
E11, excavated to clay, looking west

Aerial Image: NearMap (8/10/2022)
NOTE: Photo locations are approximate.

Photo 62-1



Photo 62-2



62 of 269
**CONSTRUCTION
MONITORING**
PHOTO LOCATIONS
St. Clair Power Plant
DTE Energy
East China, Michigan

Aerial Image: NearMap (8/10/2022)
NOTE: Photo locations are approximate.

Date: 12/1/2022

Note: East Basin

Photo 62-1 Caption:
E12, excavated to clay, looking NE

Photo 62-2 Caption:
E12, excavated to clay, looking NE

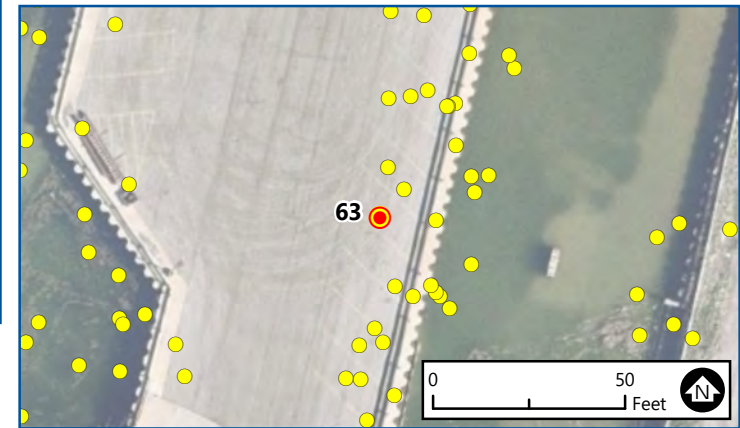

63 of 269
**CONSTRUCTION
MONITORING**
PHOTO LOCATIONS
St. Clair Power Plant
DTE Energy
East China, Michigan

Date: 12/2/2022
Note: East Basin

Photo 63-1 Caption:
E13, excavated to clay, looking east

Aerial Image: NearMap (8/10/2022)
NOTE: Photo locations are approximate.

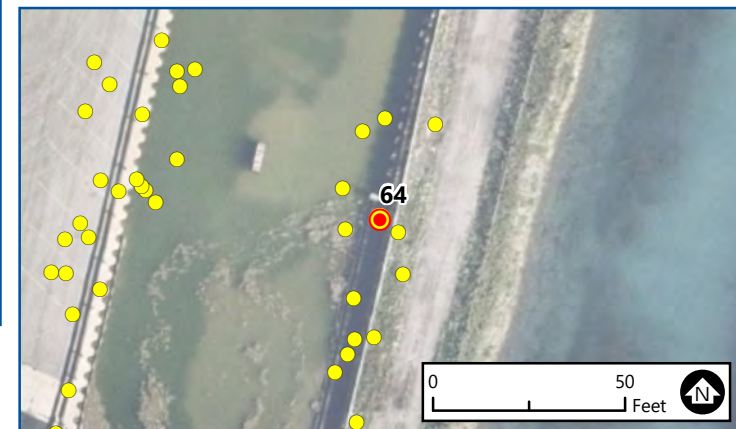

64 of 269
**CONSTRUCTION
MONITORING**
PHOTO LOCATIONS
St. Clair Power Plant
DTE Energy
East China, Michigan

Date: 12/2/2022

Note: East Basin

Photo 64-1 Caption:
E13, excavated to clay, looking east

Aerial Image: NearMap (8/10/2022)
NOTE: Photo locations are approximate.

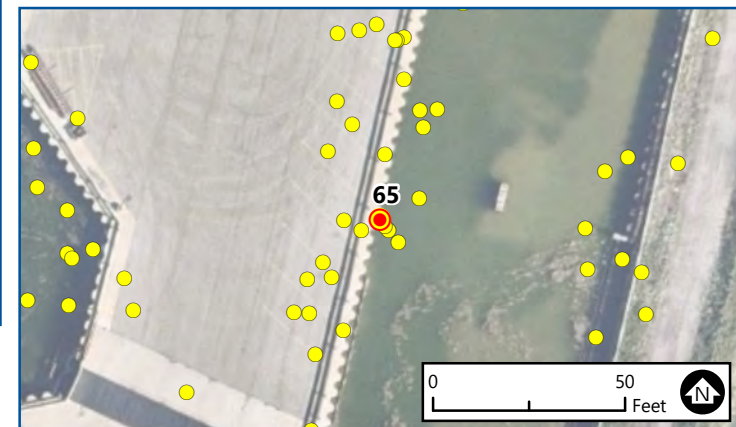

65 of 269
**CONSTRUCTION
MONITORING**
PHOTO LOCATIONS
St. Clair Power Plant
DTE Energy
East China, Michigan

Date: 12/2/2022

Note: East Basin

Photo 65-1 Caption:
E14, excavated to clay, looking east

Aerial Image: NearMap (8/10/2022)
NOTE: Photo locations are approximate.

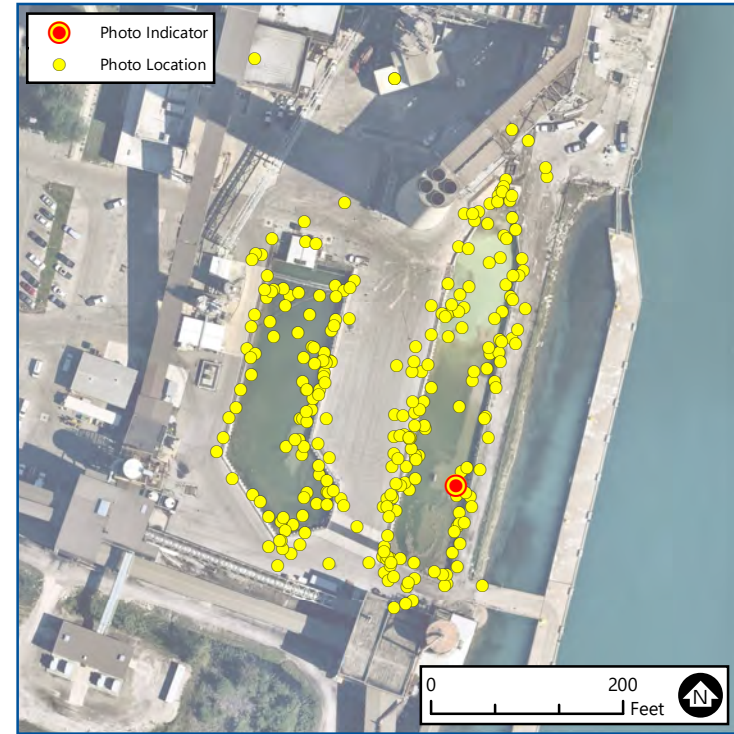

66 of 269
**CONSTRUCTION
MONITORING**
PHOTO LOCATIONS
St. Clair Power Plant
DTE Energy
East China, Michigan

Aerial Image: NearMap (8/10/2022)
NOTE: Photo locations are approximate.

Date: 12/2/2022

Note: East Basin

Photo 66-1 Caption:
E14, excavated to clay, looking NW

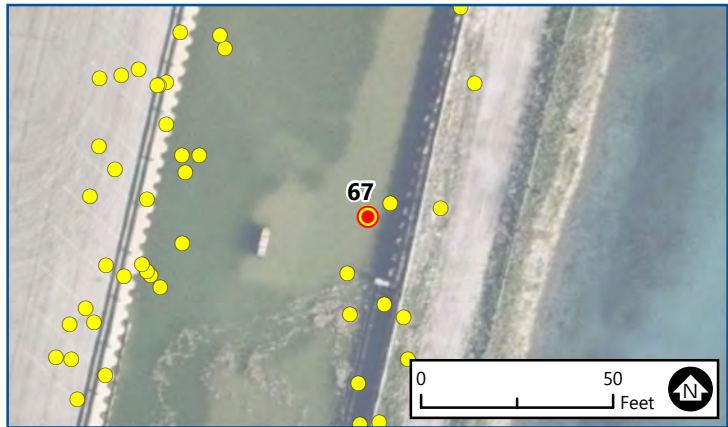
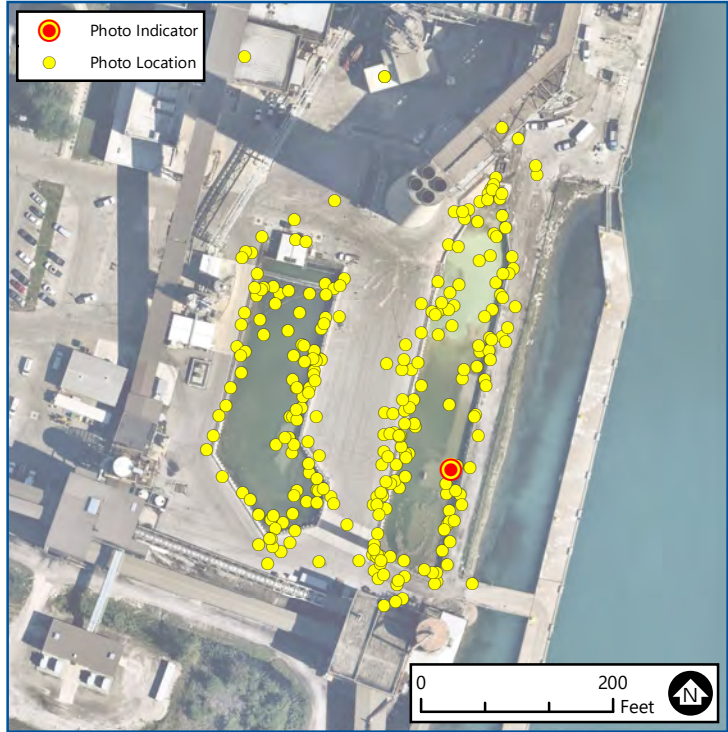

67 of 269
CONSTRUCTION MONITORING
PHOTO LOCATIONS
St. Clair Power Plant
DTE Energy
East China, Michigan

Date: 12/2/2022
Note: East Basin

Photo 67-1 Caption:
E14, excavated to clay, looking west

Aerial Image: NearMap (8/10/2022)
NOTE: Photo locations are approximate.

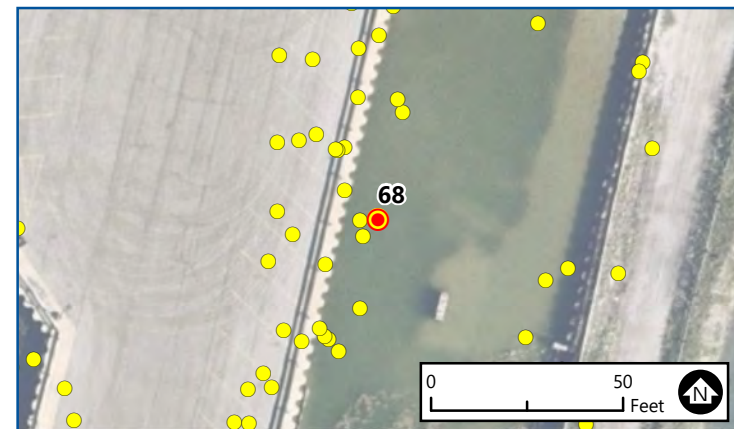

68 of 269
**CONSTRUCTION
MONITORING**
PHOTO LOCATIONS
St. Clair Power Plant
DTE Energy
East China, Michigan

Date: 12/2/2022

Note: East Basin

Photo 68-1 Caption:
E15, excavated to clay, looking SE

Aerial Image: NearMap (8/10/2022)
NOTE: Photo locations are approximate.



Photo 69-1

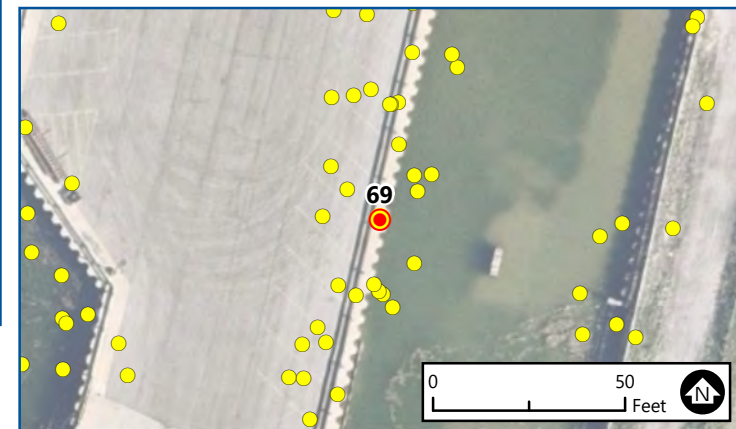

69 of 269
**CONSTRUCTION
MONITORING**
PHOTO LOCATIONS
St. Clair Power Plant
DTE Energy
East China, Michigan

Aerial Image: NearMap (8/10/2022)
NOTE: Photo locations are approximate.

Date: 12/2/2022

Note: East Basin

Photo 69-1 Caption:
E15, excavated to clay, looking NE

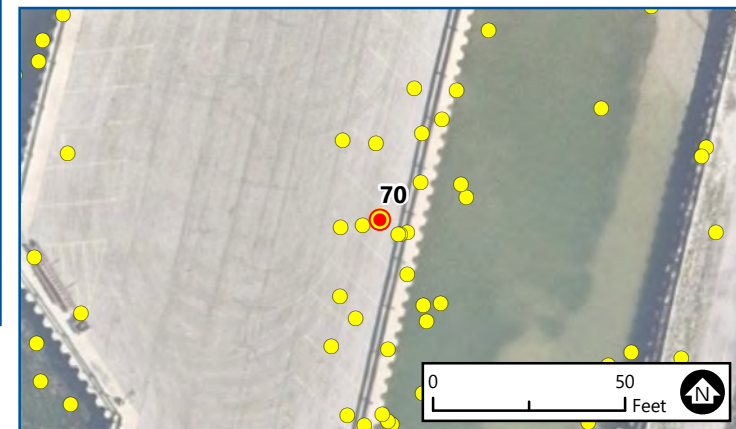

70 of 269
**CONSTRUCTION
MONITORING**
PHOTO LOCATIONS
St. Clair Power Plant
DTE Energy
East China, Michigan

Date: 12/3/2022

Note: East Basin

Photo 70-1 Caption:
E16, excavated to clay, looking NE

Aerial Image: NearMap (8/10/2022)
NOTE: Photo locations are approximate.

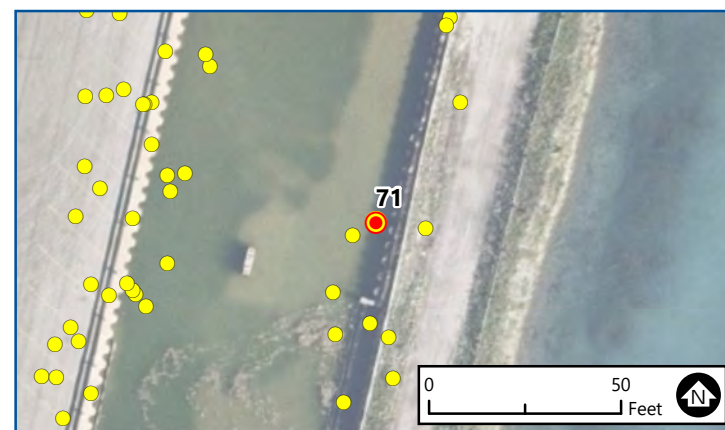
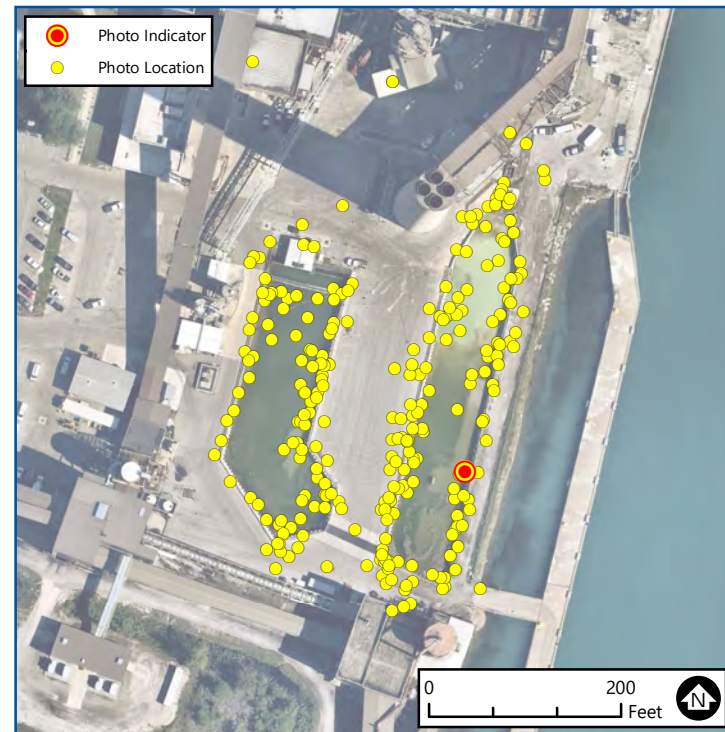

71 of 269
**CONSTRUCTION
MONITORING**
PHOTO LOCATIONS
St. Clair Power Plant
DTE Energy
East China, Michigan

Date: 12/3/2022
Note: East Basin

Photo 71-1 Caption:
E16, excavated to clay, looking NW

Aerial Image: NearMap (8/10/2022)
NOTE: Photo locations are approximate.

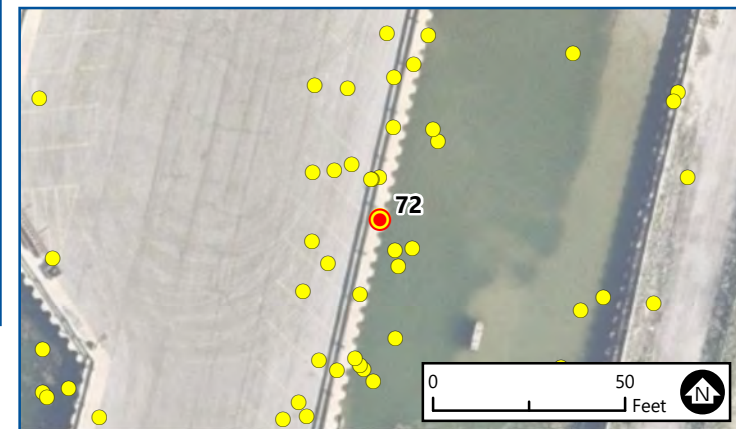

72 of 269
**CONSTRUCTION
MONITORING**
PHOTO LOCATIONS
St. Clair Power Plant
DTE Energy
East China, Michigan

Date: 12/3/2022
Note: East Basin

Photo 72-1 Caption:
E17, excavated to clay, looking NE

Aerial Image: NearMap (8/10/2022)
NOTE: Photo locations are approximate.

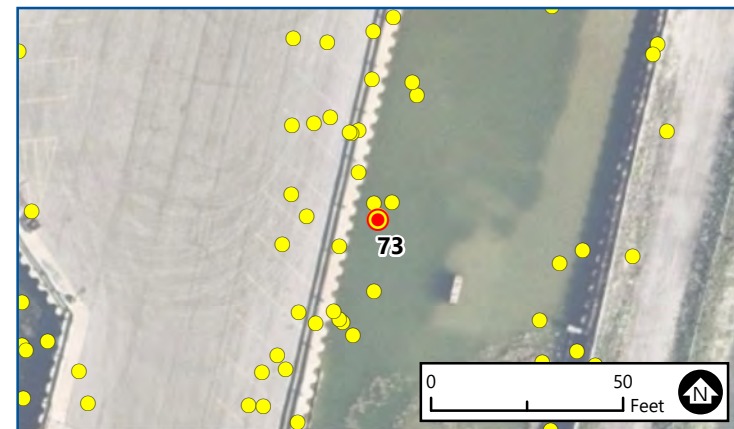

73 of 269
**CONSTRUCTION
MONITORING**
PHOTO LOCATIONS
St. Clair Power Plant
DTE Energy
East China, Michigan

Date: 12/3/2022

Note: East Basin

Photo 73-1 Caption:
E17, excavated to clay, looking SE

Aerial Image: NearMap (8/10/2022)
NOTE: Photo locations are approximate.

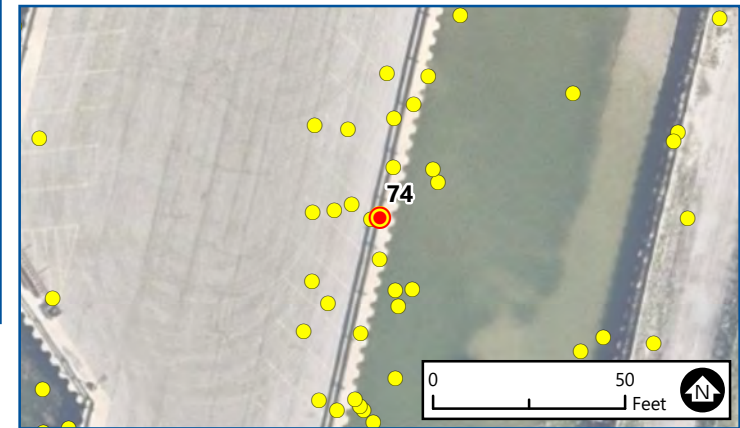

74 of 269
**CONSTRUCTION
MONITORING**
PHOTO LOCATIONS
St. Clair Power Plant
DTE Energy
East China, Michigan

Date: 12/3/2022
Note: East Basin

Photo 74-1 Caption:
E18, excavated to clay, looking east

Aerial Image: NearMap (8/10/2022)
NOTE: Photo locations are approximate.

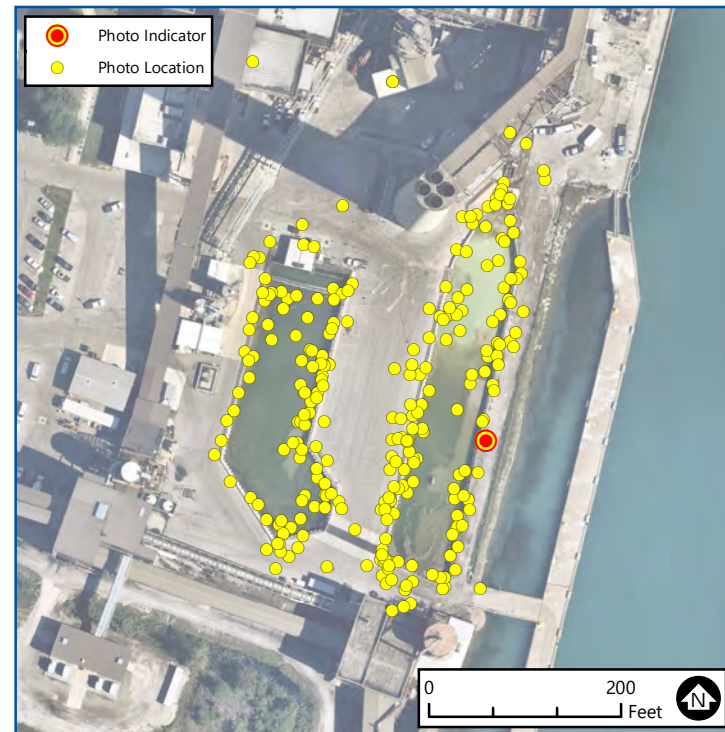

75 of 269
**CONSTRUCTION
MONITORING**
PHOTO LOCATIONS
St. Clair Power Plant
DTE Energy
East China, Michigan

Date: 12/3/2022
Note: East Basin

Photo 75-1 Caption:
E18, excavated to clay, looking east

Aerial Image: NearMap (8/10/2022)
NOTE: Photo locations are approximate.



Photo 76-1



76 of 269
**CONSTRUCTION
MONITORING**
PHOTO LOCATIONS
St. Clair Power Plant
DTE Energy
East China, Michigan

Date: 12/5/2022

Note: East Basin

Photo 76-1 Caption:
E19, excavated to clay, looking east

Aerial Image: NearMap (8/10/2022)
NOTE: Photo locations are approximate.

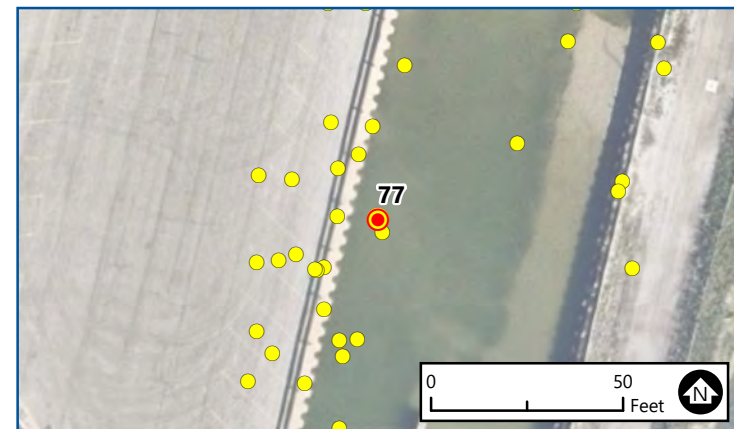

77 of 269
**CONSTRUCTION
MONITORING**
PHOTO LOCATIONS
St. Clair Power Plant
DTE Energy
East China, Michigan

Aerial Image: NearMap (8/10/2022)
NOTE: Photo locations are approximate.

Date: 12/5/2022

Note: East Basin

Photo 77-1 Caption:
E19, excavated to clay, looking NE



Photo 78-1

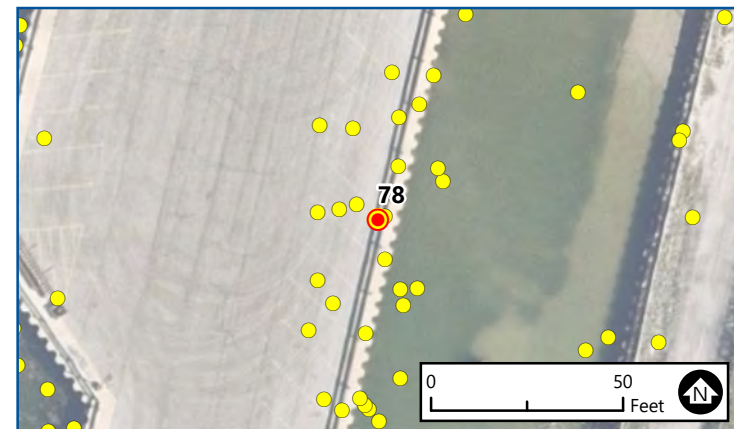

78 of 269
**CONSTRUCTION
MONITORING**
PHOTO LOCATIONS
St. Clair Power Plant
DTE Energy
East China, Michigan

Date: 12/5/2022
Note: East Basin

Photo 78-1 Caption:
E20, excavated to clay, looking NE

Aerial Image: NearMap (8/10/2022)
NOTE: Photo locations are approximate.



Photo 79-1

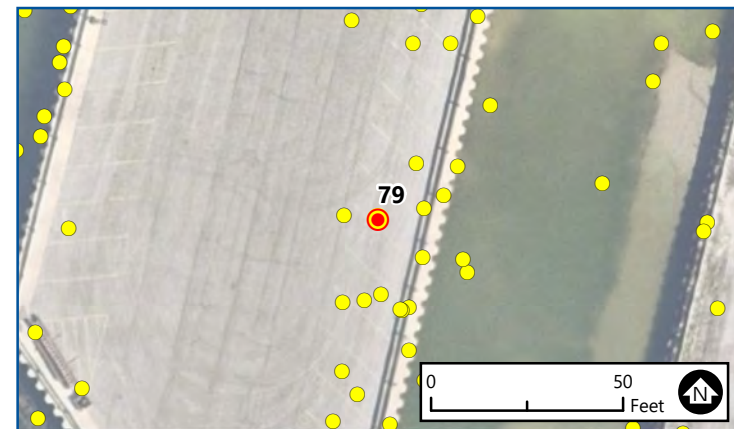

79 of 269
**CONSTRUCTION
MONITORING**
PHOTO LOCATIONS
St. Clair Power Plant
DTE Energy
East China, Michigan

Date: 12/5/2022

Note: East Basin

Photo 79-1 Caption:
E21, excavated to clay, looking SE

Aerial Image: NearMap (8/10/2022)
NOTE: Photo locations are approximate.



80 of 269
**CONSTRUCTION
MONITORING**
PHOTO LOCATIONS
St. Clair Power Plant
DTE Energy
East China, Michigan

Aerial Image: NearMap (8/10/2022)
NOTE: Photo locations are approximate.

Date: 12/5/2022

Note: East Basin

Photo 80-1 Caption:
E21, excavated to clay, looking west

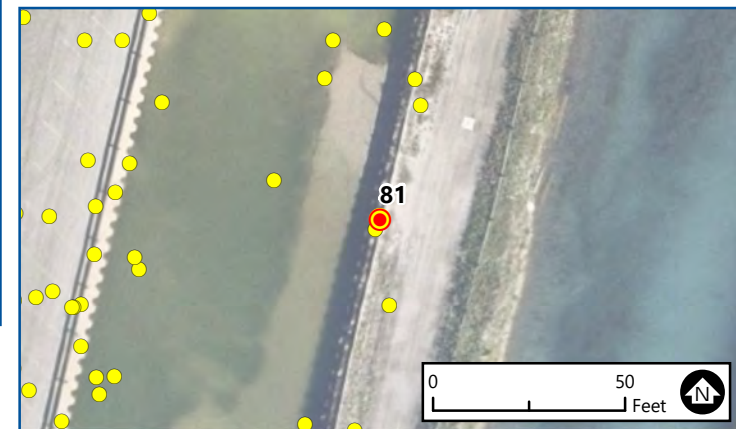

81 of 269
**CONSTRUCTION
MONITORING**
PHOTO LOCATIONS
St. Clair Power Plant
DTE Energy
East China, Michigan

Date: 12/5/2022

Note: East Basin

Photo 81-1 Caption:
E21, excavated to clay, looking SW

Aerial Image: NearMap (8/10/2022)
NOTE: Photo locations are approximate.

Photo 82-1



Photo 82-2

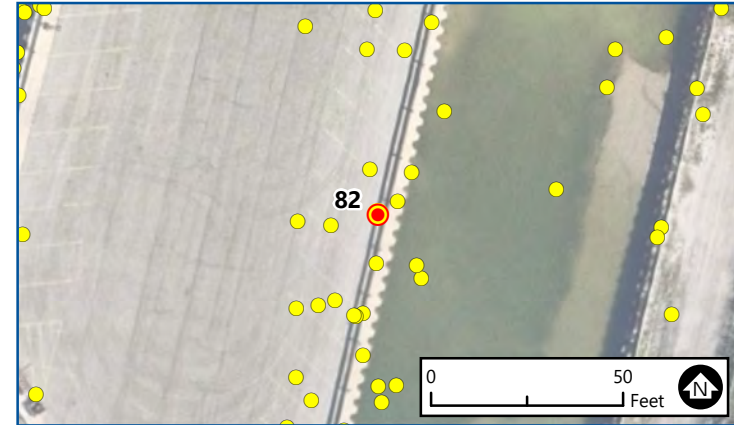

82 of 269
**CONSTRUCTION
MONITORING**
PHOTO LOCATIONS
St. Clair Power Plant
DTE Energy
East China, Michigan

Date: 12/6/2022
Note: East Basin

Photo 82-1 Caption:
E22, excavated to clay, looking NE

Photo 82-2 Caption:
E22, excavated to clay, looking SE

Aerial Image: NearMap (8/10/2022)
NOTE: Photo locations are approximate.

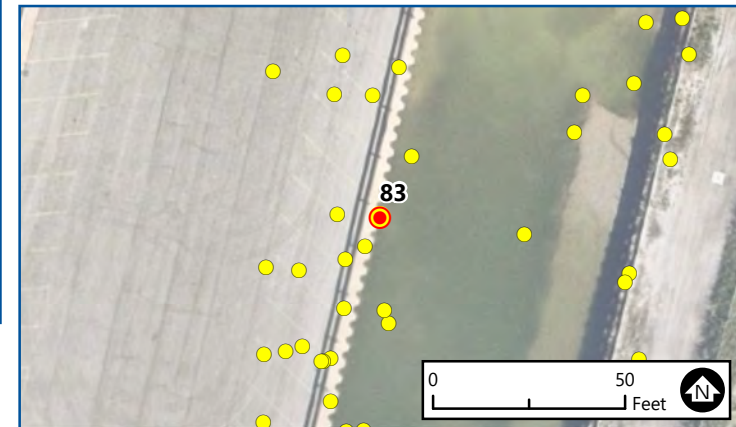

83 of 269
**CONSTRUCTION
MONITORING**
PHOTO LOCATIONS
St. Clair Power Plant
DTE Energy
East China, Michigan

Date: 12/6/2022
Note: East Basin

Photo 83-1 Caption:
E23, excavated to clay, looking east

Aerial Image: NearMap (8/10/2022)
NOTE: Photo locations are approximate.

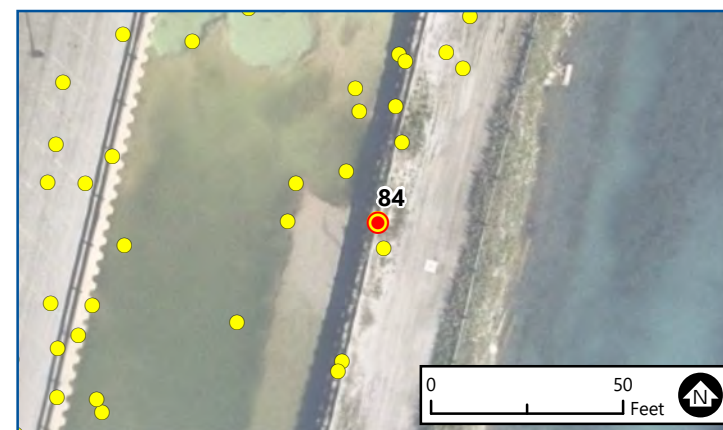
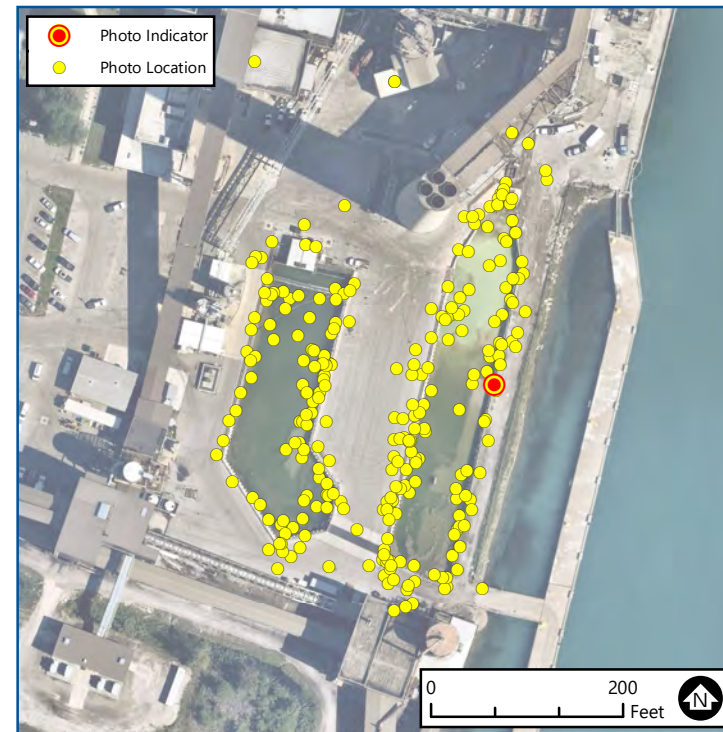

84 of 269
**CONSTRUCTION
MONITORING**
PHOTO LOCATIONS
St. Clair Power Plant
DTE Energy
East China, Michigan

Date: 12/6/2022
Note: East Basin

Photo 84-1 Caption:
E23, excavated to clay, looking west

Aerial Image: NearMap (8/10/2022)
NOTE: Photo locations are approximate.

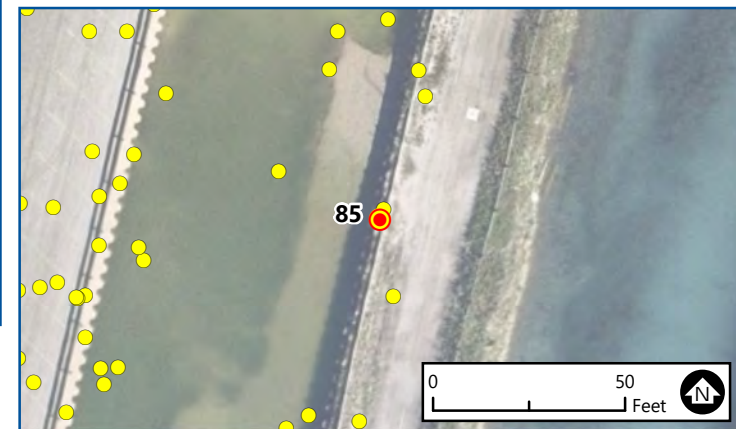

85 of 269
**CONSTRUCTION
MONITORING**
PHOTO LOCATIONS
St. Clair Power Plant
DTE Energy
East China, Michigan

Date: 12/6/2022

Note: East Basin

Photo 85-1 Caption:
E23, excavated to clay, looking NW

Aerial Image: NearMap (8/10/2022)
NOTE: Photo locations are approximate.

Photo 86-1



Photo 86-2

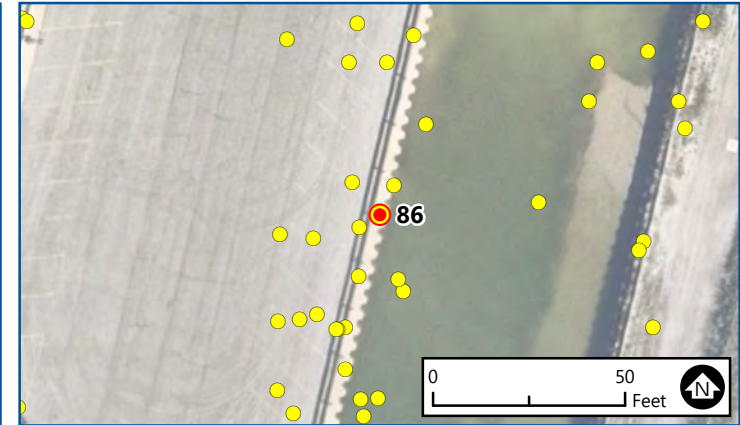

86 of 269
**CONSTRUCTION
MONITORING**
PHOTO LOCATIONS
St. Clair Power Plant
DTE Energy
East China, Michigan

Aerial Image: NearMap (8/10/2022)
NOTE: Photo locations are approximate.

Date: 12/6/2022
Note: East Basin
Photo 86-1 Caption:
E24, excavated to clay, looking NE
Photo 86-2 Caption:
E24, excavated to clay, looking SE

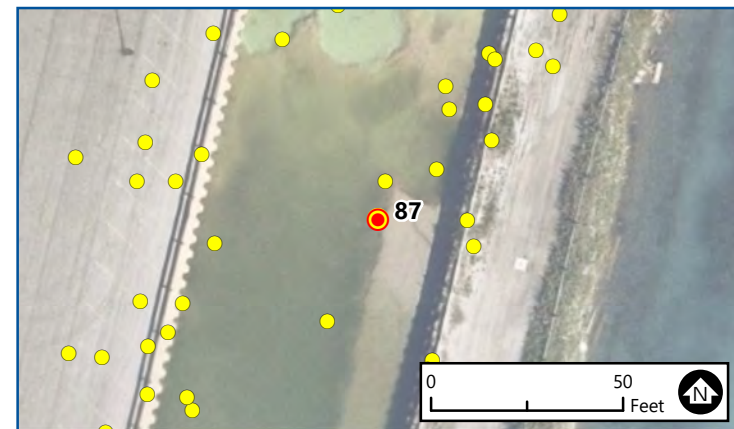

87 of 269
**CONSTRUCTION
MONITORING**
PHOTO LOCATIONS
St. Clair Power Plant
DTE Energy
East China, Michigan

Date: 12/6/2022
Note: East Basin

Photo 87-1 Caption:
E25, excavated to clay, looking east

Aerial Image: NearMap (8/10/2022)
NOTE: Photo locations are approximate.



Photo 88-1

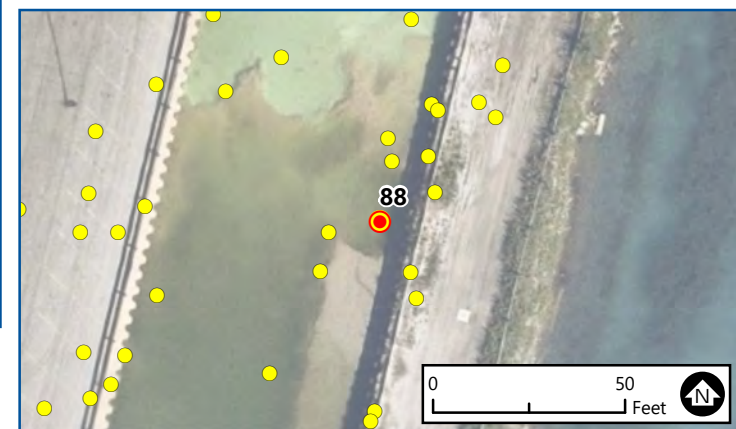
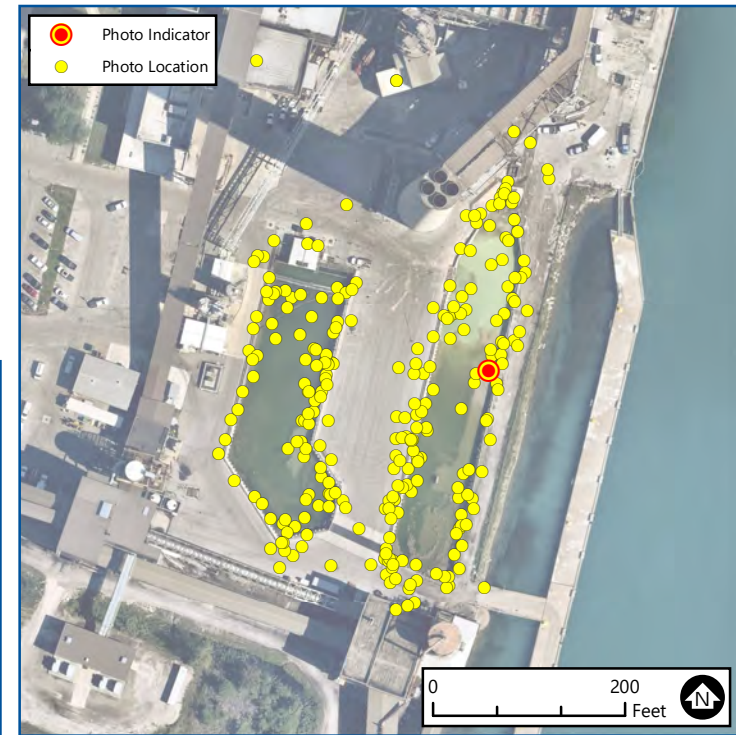

88 of 269
**CONSTRUCTION
MONITORING**
PHOTO LOCATIONS
St. Clair Power Plant
DTE Energy
East China, Michigan

Date: 12/6/2022

Note: East Basin

Photo 88-1 Caption:
E25, excavated to clay, looking SW

Aerial Image: NearMap (8/10/2022)
NOTE: Photo locations are approximate.

Photo 89-1

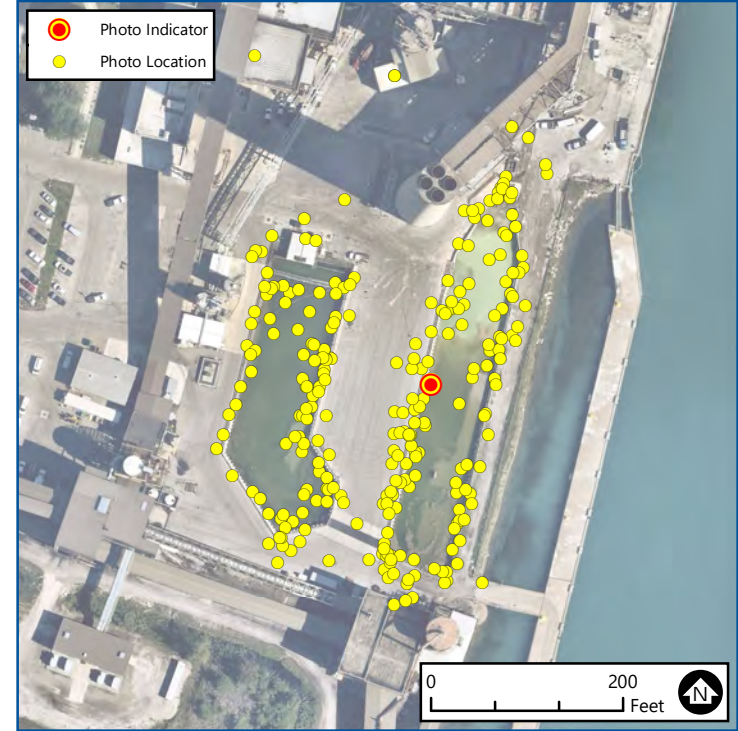

Photo 89-2



89 of 269
**CONSTRUCTION
MONITORING**
PHOTO LOCATIONS
St. Clair Power Plant
DTE Energy
East China, Michigan

Date: 12/7/2022
Note: East Basin

Photo 89-1 Caption:
E26, excavated to clay, looking NE

Photo 89-2 Caption:
E26, excavated to clay, looking SE

Aerial Image: NearMap (8/10/2022)
NOTE: Photo locations are approximate.



Photo 90-1

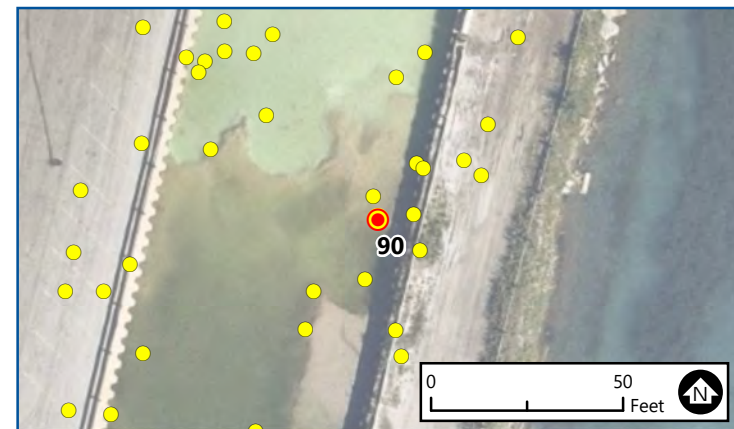
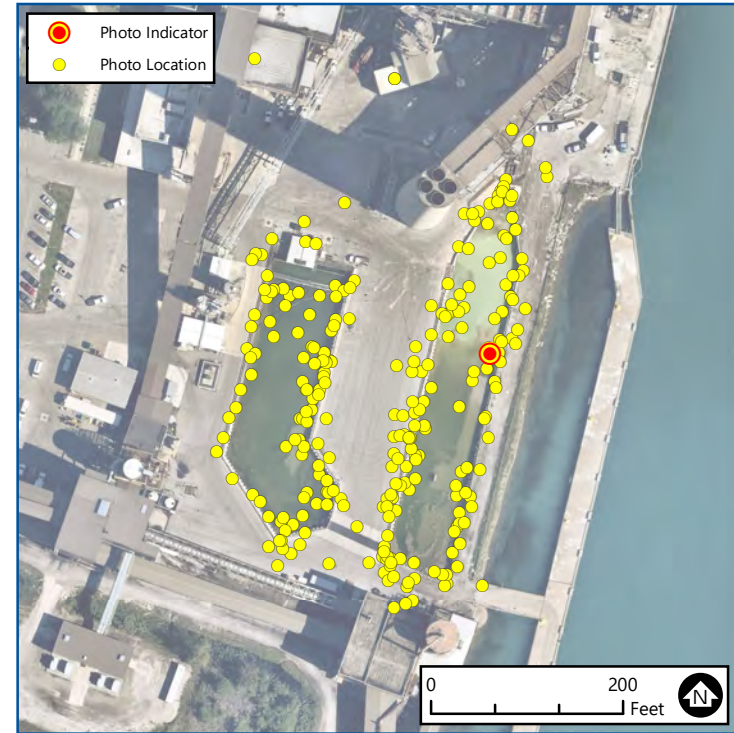

90 of 269
**CONSTRUCTION
MONITORING**
PHOTO LOCATIONS
St. Clair Power Plant
DTE Energy
East China, Michigan

Date: 12/7/2022

Note: East Basin

Photo 90-1 Caption:
E27, excavated to clay, looking west

Aerial Image: NearMap (8/10/2022)
NOTE: Photo locations are approximate.

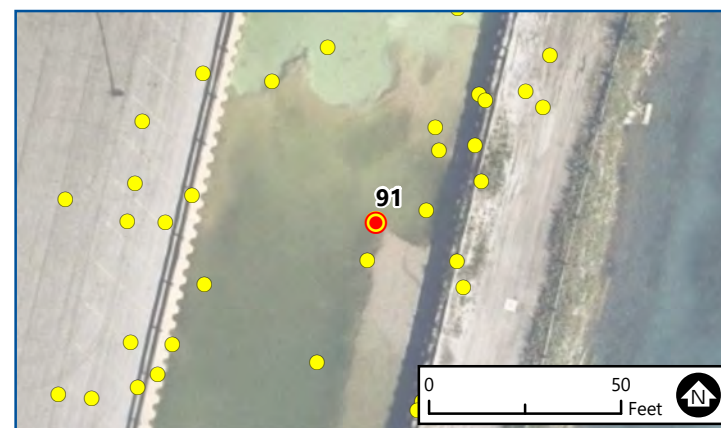
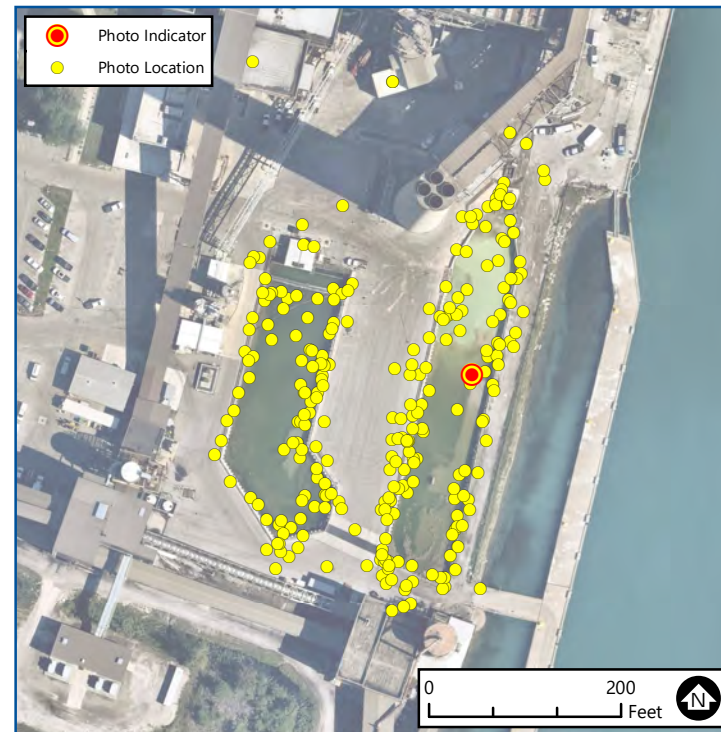

91 of 269
**CONSTRUCTION
MONITORING**
PHOTO LOCATIONS
St. Clair Power Plant
DTE Energy
East China, Michigan

Date: 12/7/2022
Note: East Basin

Photo 91-1 Caption:
E27, excavated to clay, looking west

Aerial Image: NearMap (8/10/2022)
NOTE: Photo locations are approximate.

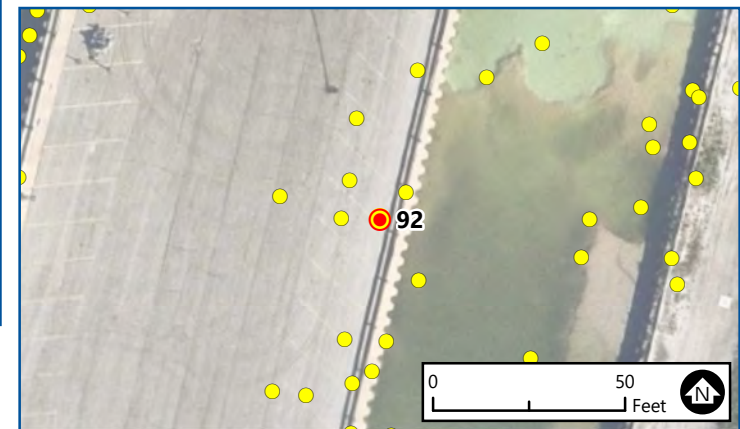

92 of 269
**CONSTRUCTION
MONITORING**
PHOTO LOCATIONS
St. Clair Power Plant
DTE Energy
East China, Michigan

Date: 12/7/2022
Note: East Basin

Photo 92-1 Caption:
E27, excavated to clay, looking east

Aerial Image: NearMap (8/10/2022)
NOTE: Photo locations are approximate.

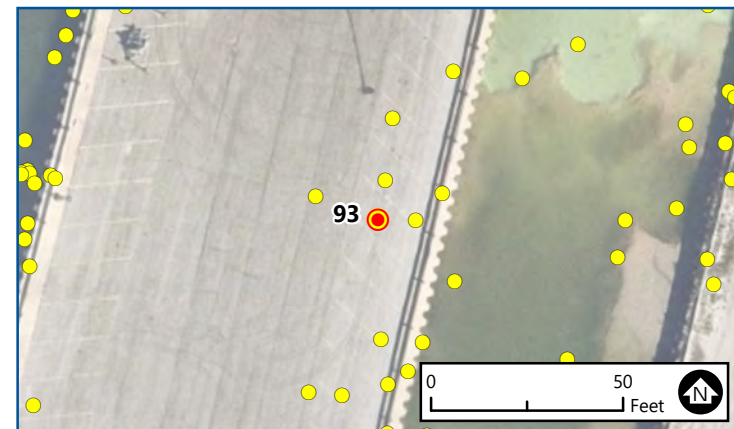

93 of 269
**CONSTRUCTION
MONITORING**
PHOTO LOCATIONS
St. Clair Power Plant
DTE Energy
East China, Michigan

Date: 12/7/2022
Note: East Basin

Photo 93-1 Caption:
E28, excavated to clay, looking NE

Aerial Image: NearMap (8/10/2022)
NOTE: Photo locations are approximate.

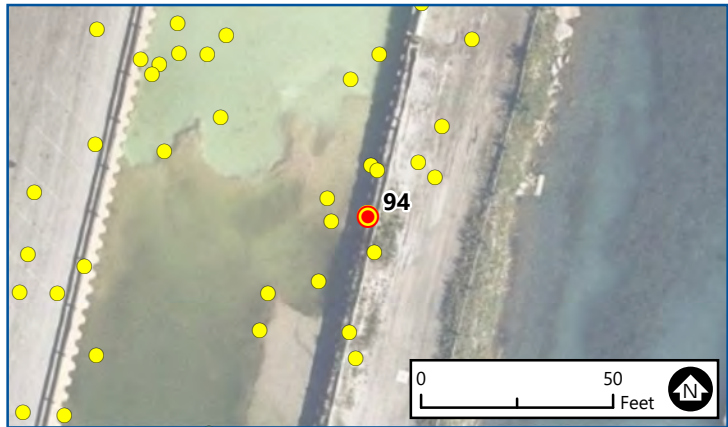
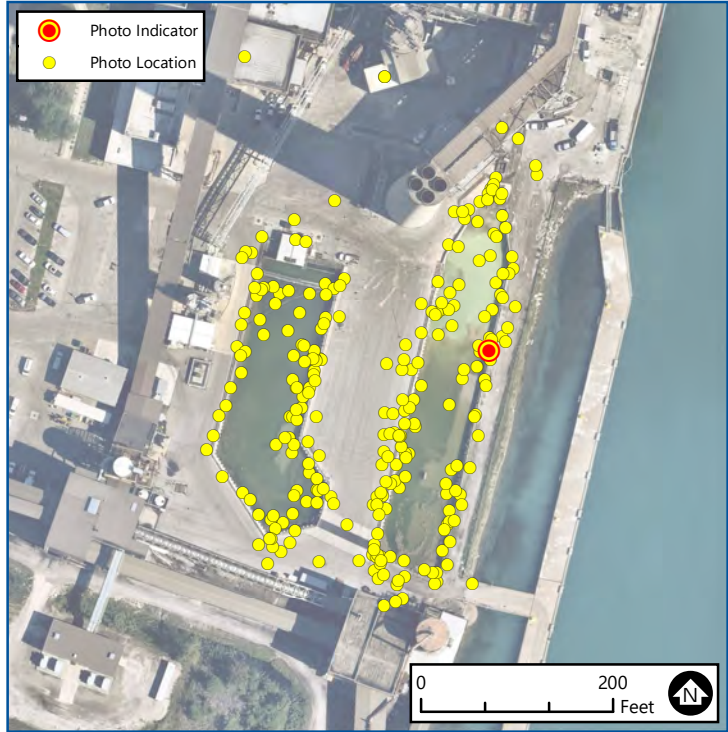

94 of 269
**CONSTRUCTION
MONITORING**
PHOTO LOCATIONS
St. Clair Power Plant
DTE Energy
East China, Michigan

Date: 12/8/2022
Note: East Basin

Photo 94-1 Caption:
E29, excavated to clay, looking west

Aerial Image: NearMap (8/10/2022)
NOTE: Photo locations are approximate.

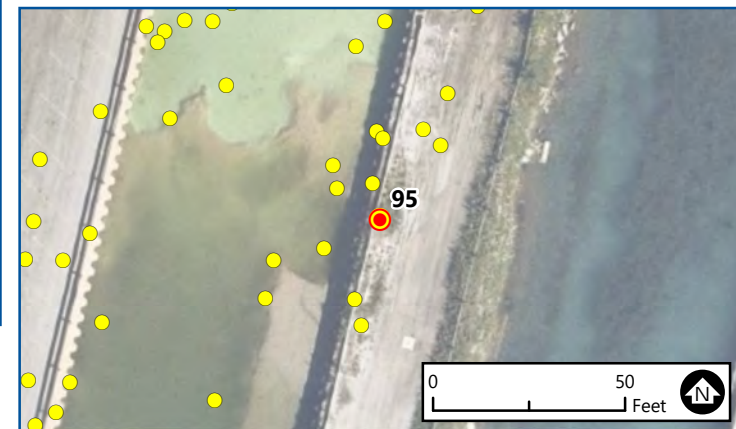

95 of 269
**CONSTRUCTION
MONITORING**
PHOTO LOCATIONS
St. Clair Power Plant
DTE Energy
East China, Michigan

Date: 12/8/2022
Note: East Basin

Photo 95-1 Caption:
E29, excavated to clay, looking NE

Aerial Image: NearMap (8/10/2022)
NOTE: Photo locations are approximate.

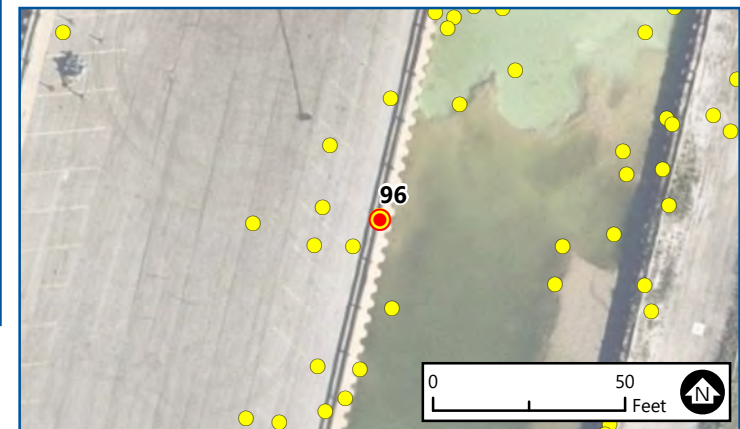

96 of 269
**CONSTRUCTION
MONITORING**
PHOTO LOCATIONS
St. Clair Power Plant
DTE Energy
East China, Michigan

Date: 12/8/2022
Note: East Basin

Photo 96-1 Caption:
E30, excavated to clay, looking NE

Aerial Image: NearMap (8/10/2022)
NOTE: Photo locations are approximate.



Photo 97-1

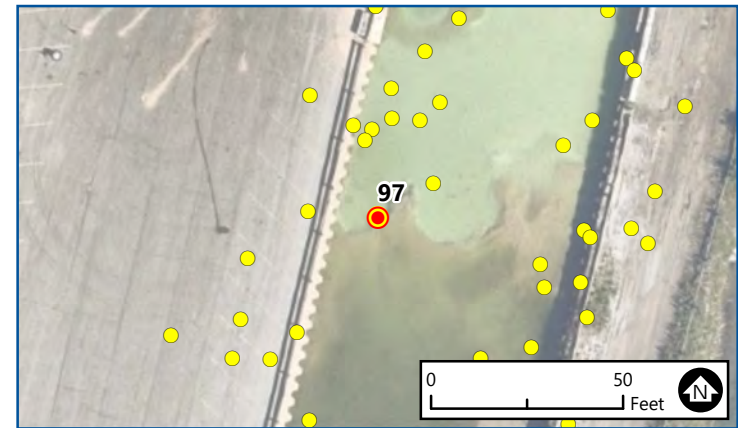

97 of 269
**CONSTRUCTION
MONITORING**
PHOTO LOCATIONS
St. Clair Power Plant
DTE Energy
East China, Michigan

Date: 12/8/2022
Note: East Basin

Photo 97-1 Caption:
E31, excavated to clay, looking east

Aerial Image: NearMap (8/10/2022)
NOTE: Photo locations are approximate.

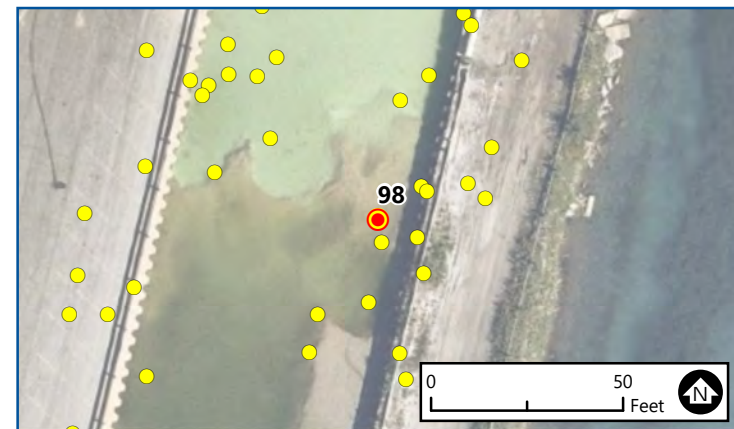

98 of 269
**CONSTRUCTION
MONITORING**
PHOTO LOCATIONS
St. Clair Power Plant
DTE Energy
East China, Michigan

Date: 12/8/2022

Note: East Basin

Photo 98-1 Caption:
E31, excavated to clay, looking west

Aerial Image: NearMap (8/10/2022)
NOTE: Photo locations are approximate.

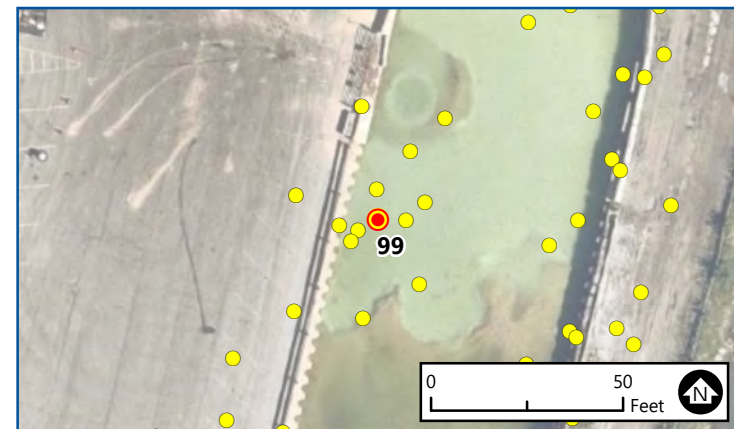

99 of 269
**CONSTRUCTION
MONITORING**
PHOTO LOCATIONS
St. Clair Power Plant
DTE Energy
East China, Michigan

Date: 12/9/2022
Note: East Basin

Photo 99-1 Caption:
E32, excavated to clay, looking east

Aerial Image: NearMap (8/10/2022)
NOTE: Photo locations are approximate.

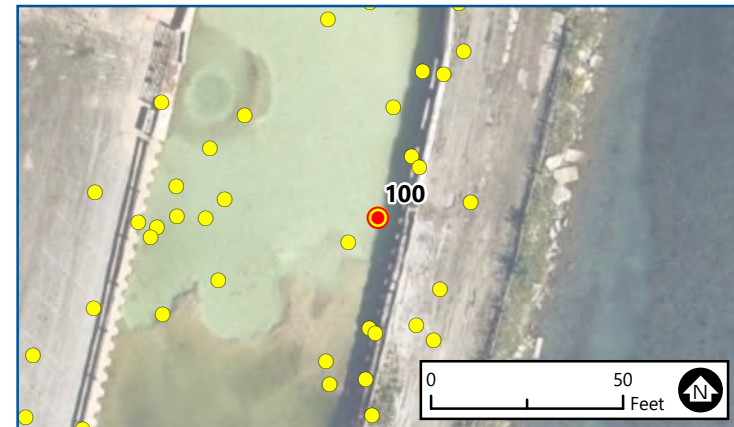

100 of 269
**CONSTRUCTION
MONITORING**
PHOTO LOCATIONS
St. Clair Power Plant
DTE Energy
East China, Michigan

Date: 12/9/2022
Note: East Basin

Photo 100-1 Caption:
E33, excavated to clay, looking west

Aerial Image: NearMap (8/10/2022)
NOTE: Photo locations are approximate.

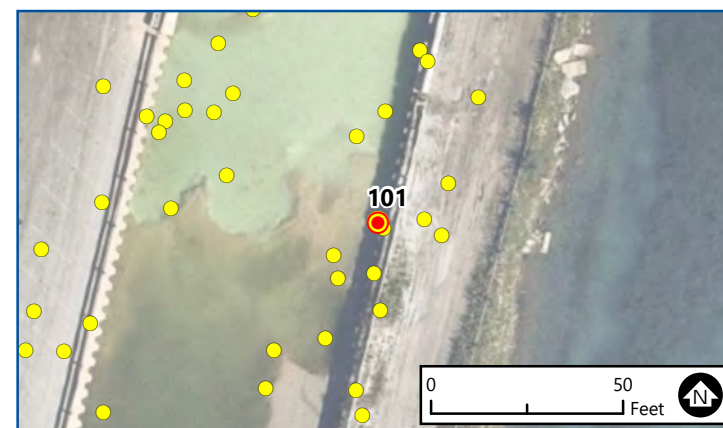
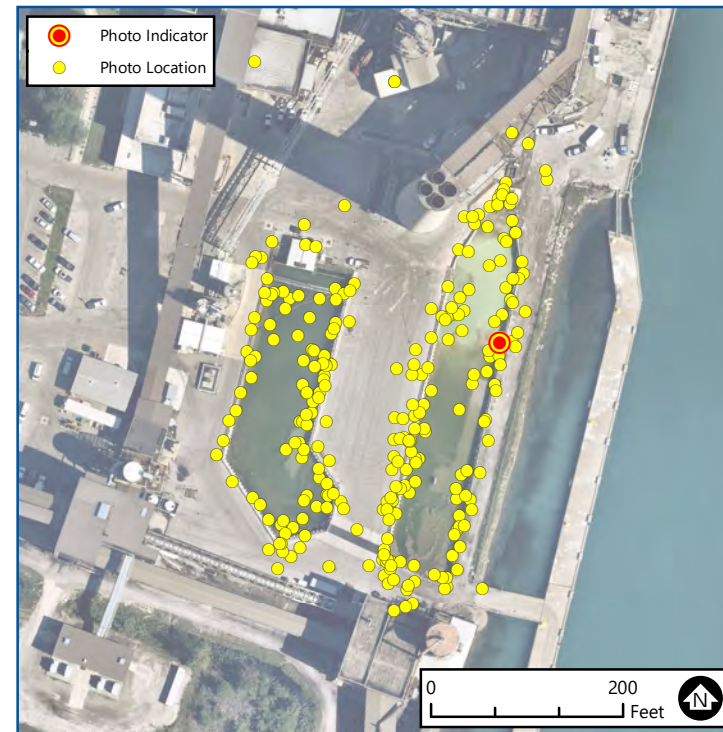

101 of 269
**CONSTRUCTION
MONITORING**
PHOTO LOCATIONS
St. Clair Power Plant
DTE Energy
East China, Michigan

Date: 12/9/2022
Note: East Basin

Photo 101-1 Caption:
E33, excavated to clay, looking NW

Aerial Image: NearMap (8/10/2022)
NOTE: Photo locations are approximate.



Photo 102-1

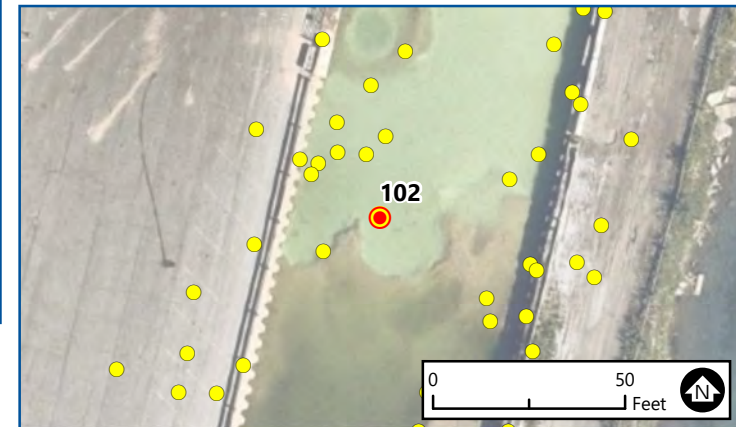

102 of 269
**CONSTRUCTION
MONITORING**
PHOTO LOCATIONS
St. Clair Power Plant
DTE Energy
East China, Michigan

Date: 12/9/2022

Note: East Basin

Photo 102-1 Caption:
E33, excavated to clay, looking east

Aerial Image: NearMap (8/10/2022)
NOTE: Photo locations are approximate.

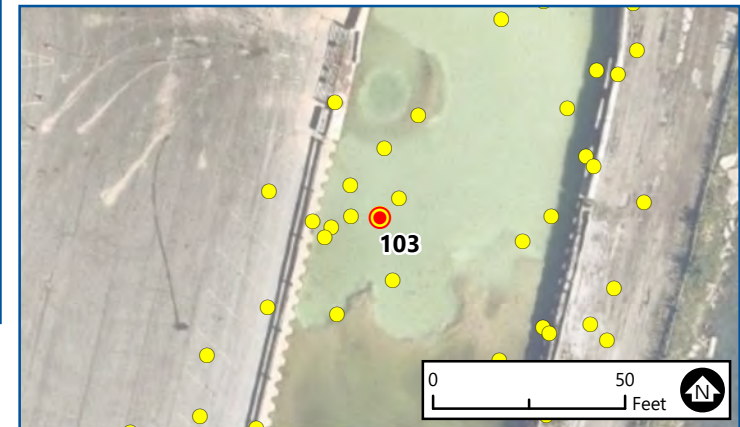

103 of 269
**CONSTRUCTION
MONITORING**
PHOTO LOCATIONS
St. Clair Power Plant
DTE Energy
East China, Michigan

Date: 12/9/2022
Note: East Basin

Photo 103-1 Caption:
E34, excavated to clay, looking east

Aerial Image: NearMap (8/10/2022)
NOTE: Photo locations are approximate.

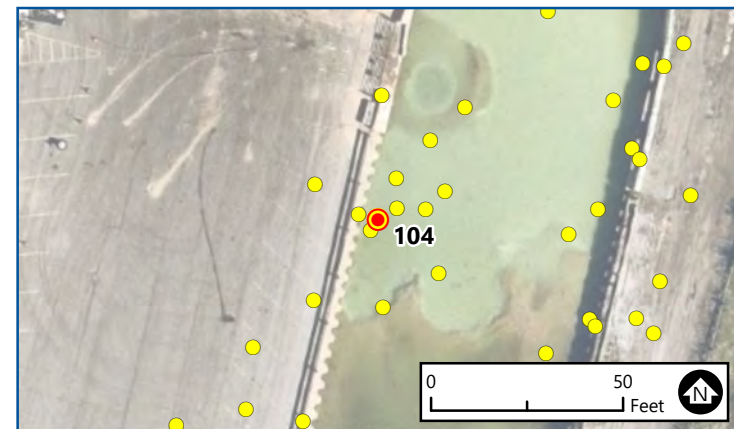

104 of 269
**CONSTRUCTION
MONITORING**
PHOTO LOCATIONS
St. Clair Power Plant
DTE Energy
East China, Michigan

Date: 12/9/2022
Note: East Basin

Photo 104-1 Caption:
E34, excavated to clay, looking NE

Aerial Image: NearMap (8/10/2022)
NOTE: Photo locations are approximate.

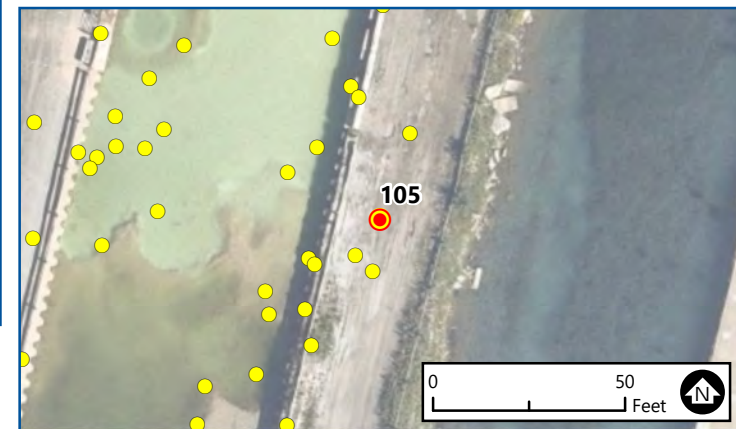

105 of 269
**CONSTRUCTION
MONITORING**
PHOTO LOCATIONS
St. Clair Power Plant
DTE Energy
East China, Michigan

Date: 12/10/2022

Note: East Basin

Photo 105-1 Caption:
E35, excavated to clay, looking west

Aerial Image: NearMap (8/10/2022)
NOTE: Photo locations are approximate.

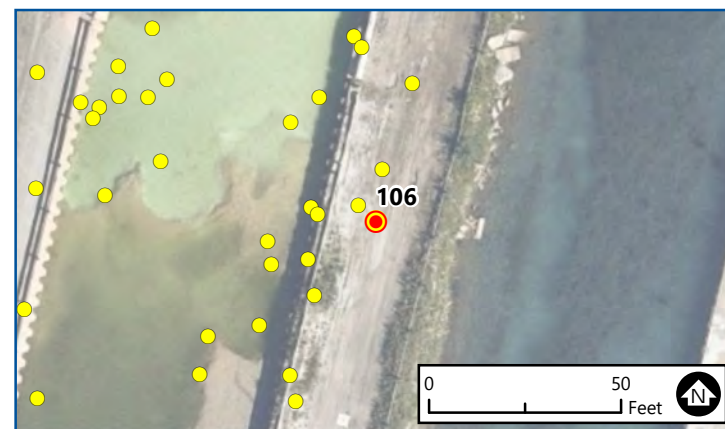
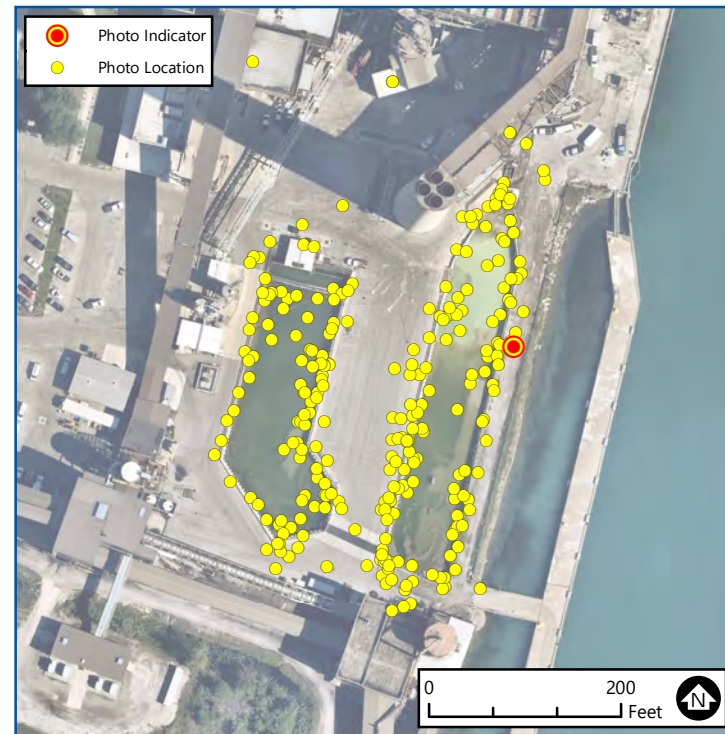

106 of 269
**CONSTRUCTION
MONITORING**
PHOTO LOCATIONS
St. Clair Power Plant
DTE Energy
East China, Michigan

Date: 12/10/2022

Note: East Basin

Photo 106-1 Caption:
E35, excavated to clay, looking NW

Aerial Image: NearMap (8/10/2022)
NOTE: Photo locations are approximate.



Photo 107-1

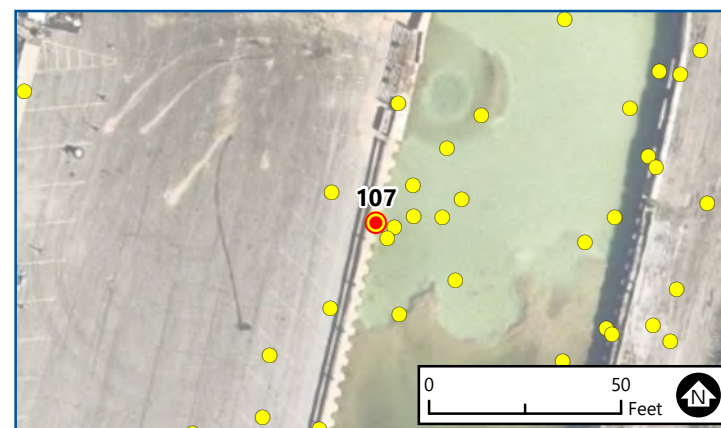
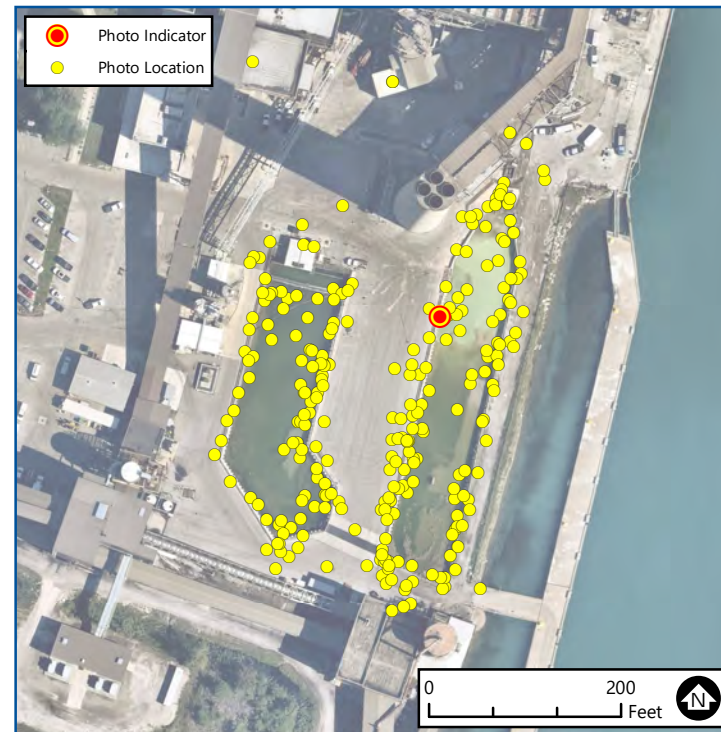

107 of 269
**CONSTRUCTION
MONITORING**
PHOTO LOCATIONS
St. Clair Power Plant
DTE Energy
East China, Michigan

Date: 12/10/2022

Note: East Basin

Photo 107-1 Caption:
E35, excavated to clay, looking east

Aerial Image: NearMap (8/10/2022)
NOTE: Photo locations are approximate.

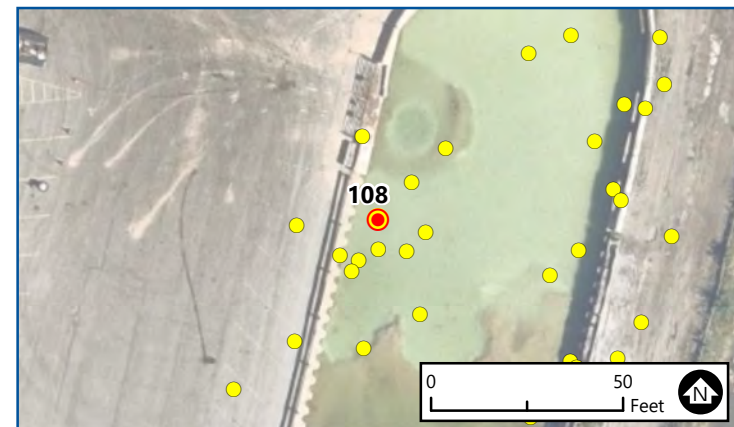

108 of 269
**CONSTRUCTION
MONITORING**
PHOTO LOCATIONS
St. Clair Power Plant
DTE Energy
East China, Michigan

Date: 12/10/2022

Note: East Basin

Photo 108-1 Caption:
E36, excavated to clay, looking east

Aerial Image: NearMap (8/10/2022)
NOTE: Photo locations are approximate.

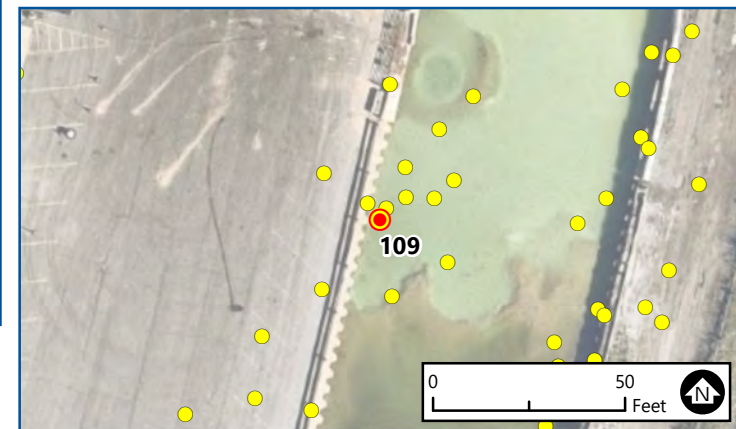

109 of 269
**CONSTRUCTION
MONITORING**
PHOTO LOCATIONS
St. Clair Power Plant
DTE Energy
East China, Michigan

Date: 12/10/2022

Note: East Basin

Photo 109-1 Caption:
E36, excavated to clay, looking NE

Aerial Image: NearMap (8/10/2022)
NOTE: Photo locations are approximate.

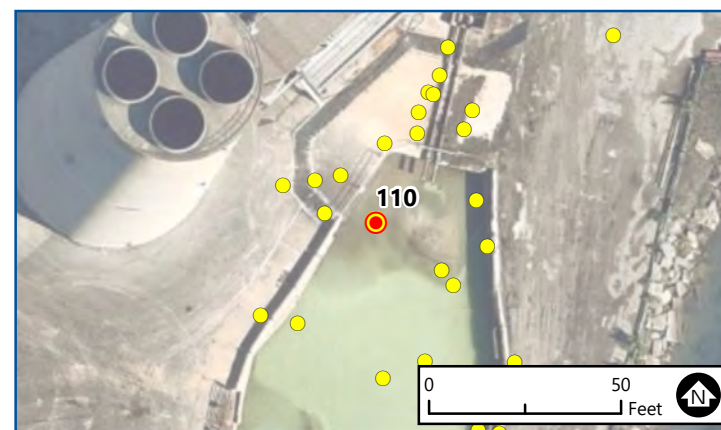
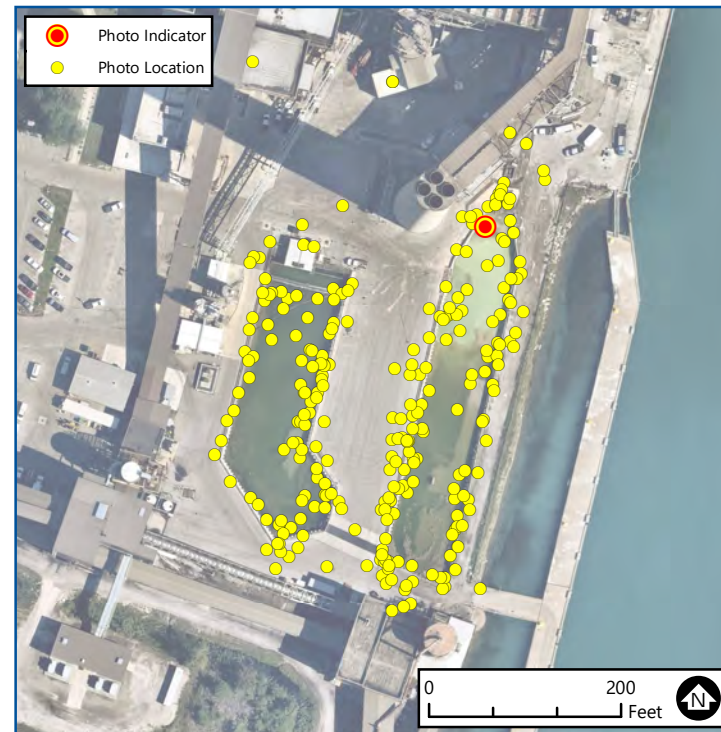

110 of 269
**CONSTRUCTION
MONITORING**
PHOTO LOCATIONS
St. Clair Power Plant
DTE Energy
East China, Michigan

Date: 12/12/2022

Note: East Basin

Photo 110-1 Caption:
E37,excavated to clay, looking east

Aerial Image: NearMap (8/10/2022)
NOTE: Photo locations are approximate.

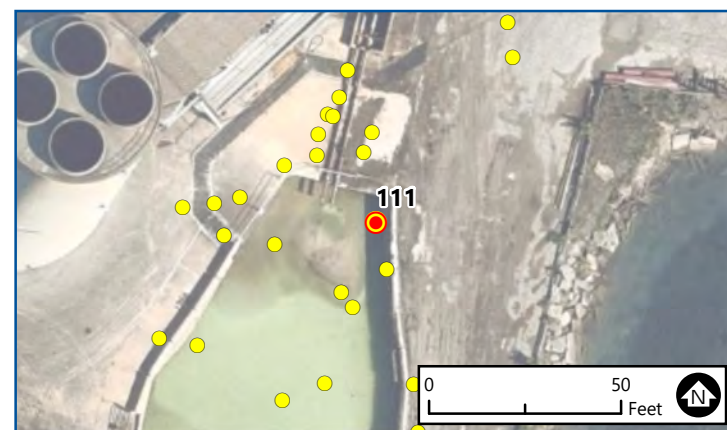
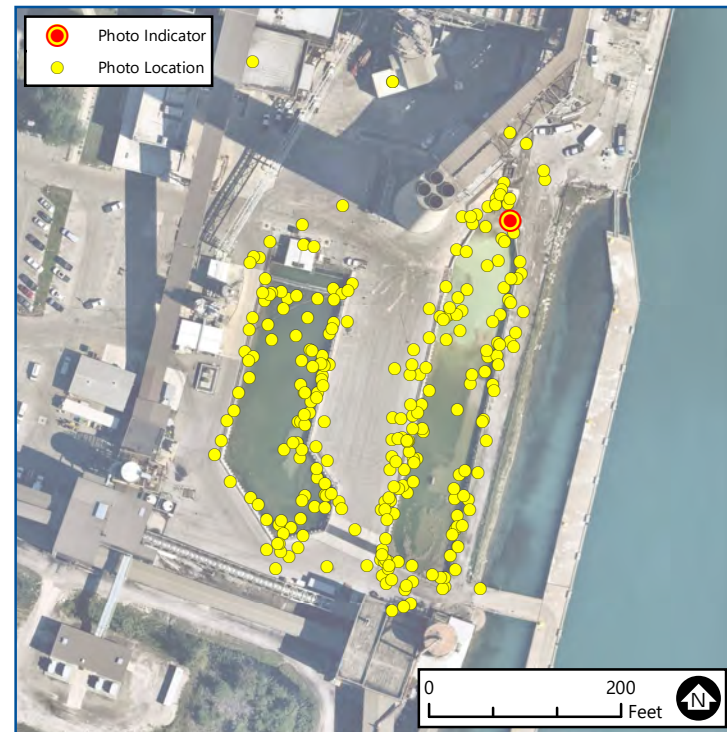
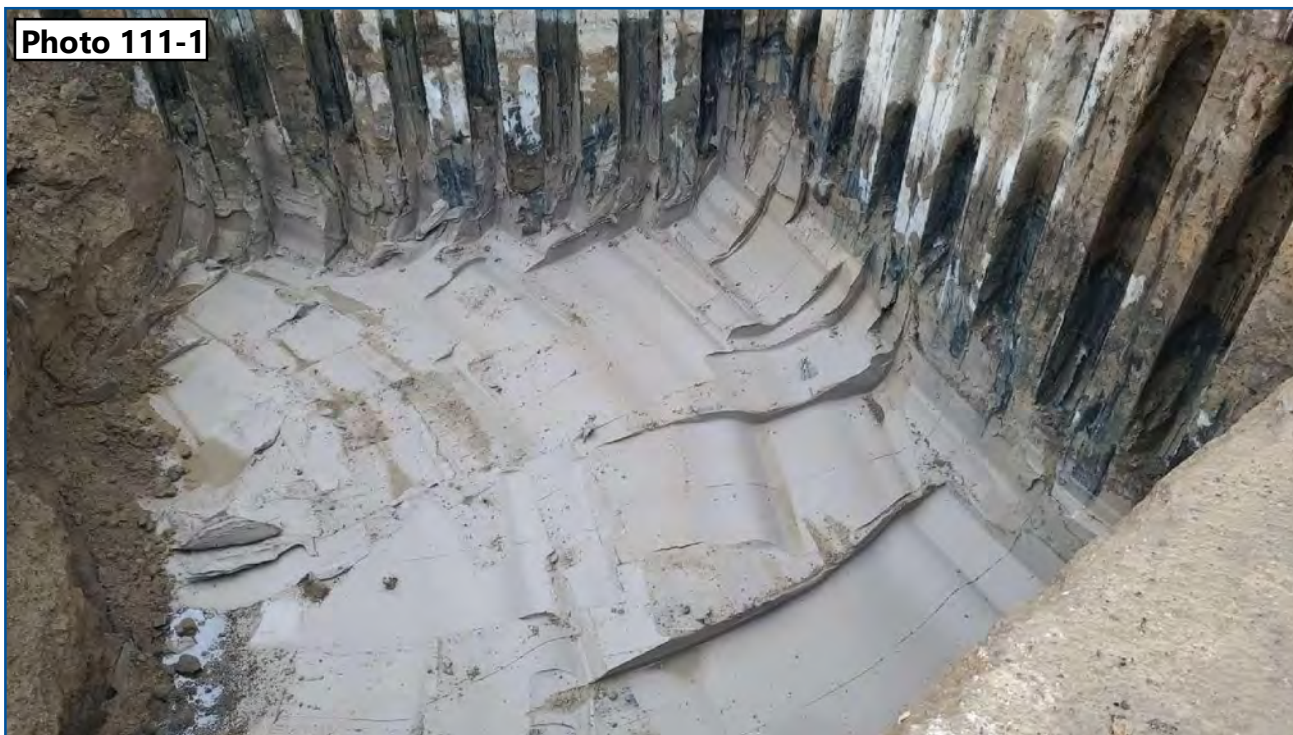

111 of 269
**CONSTRUCTION
MONITORING**
PHOTO LOCATIONS
St. Clair Power Plant
DTE Energy
East China, Michigan

Date: 12/12/2022
Note: East Basin

Photo 111-1 Caption:
E37, excavated to clay, looking west

Aerial Image: NearMap (8/10/2022)
NOTE: Photo locations are approximate.

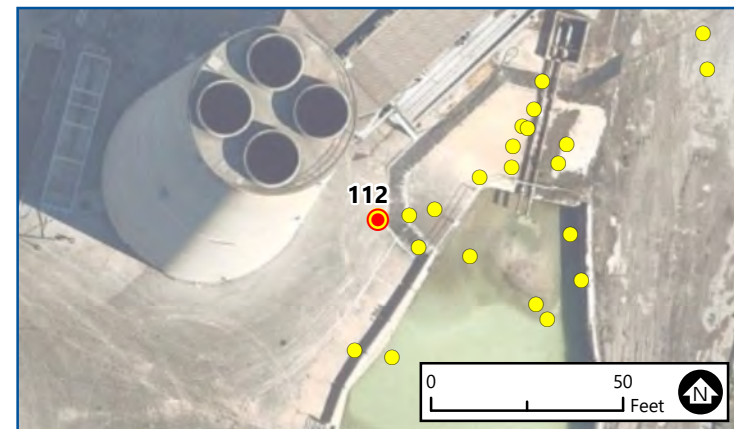

112 of 269
**CONSTRUCTION
MONITORING**
PHOTO LOCATIONS
St. Clair Power Plant
DTE Energy
East China, Michigan

Date: 12/12/2022

Note: East Basin

Photo 112-1 Caption:
E38, excavated to clay, looking east

Aerial Image: NearMap (8/10/2022)
NOTE: Photo locations are approximate.



Photo 113-1

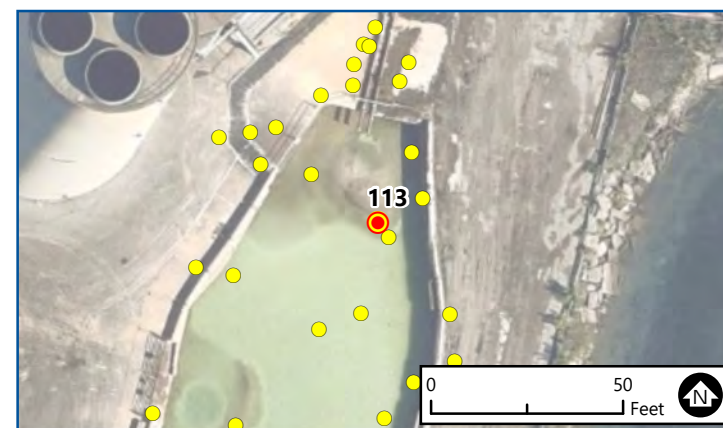
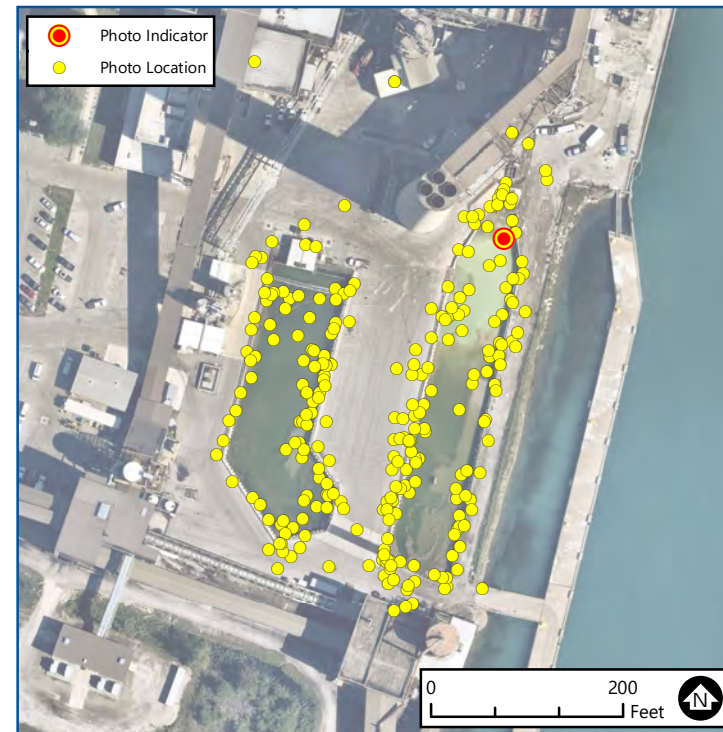

113 of 269
**CONSTRUCTION
MONITORING**
PHOTO LOCATIONS
St. Clair Power Plant
DTE Energy
East China, Michigan

Aerial Image: NearMap (8/10/2022)
NOTE: Photo locations are approximate.

Date: 12/12/2022

Note: East Basin

Photo 113-1 Caption:
E38, excavated to clay, looking west

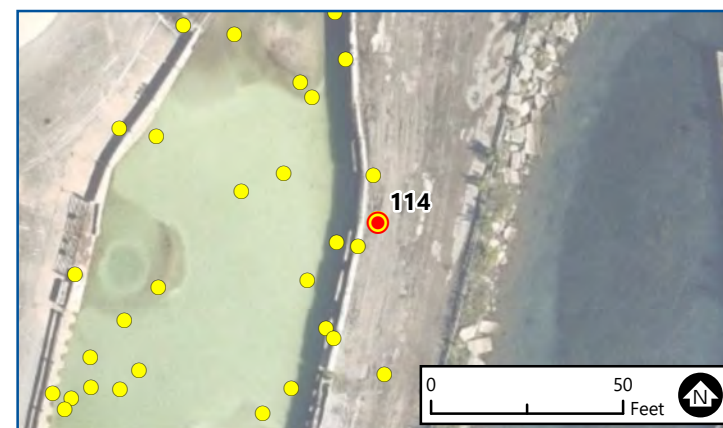
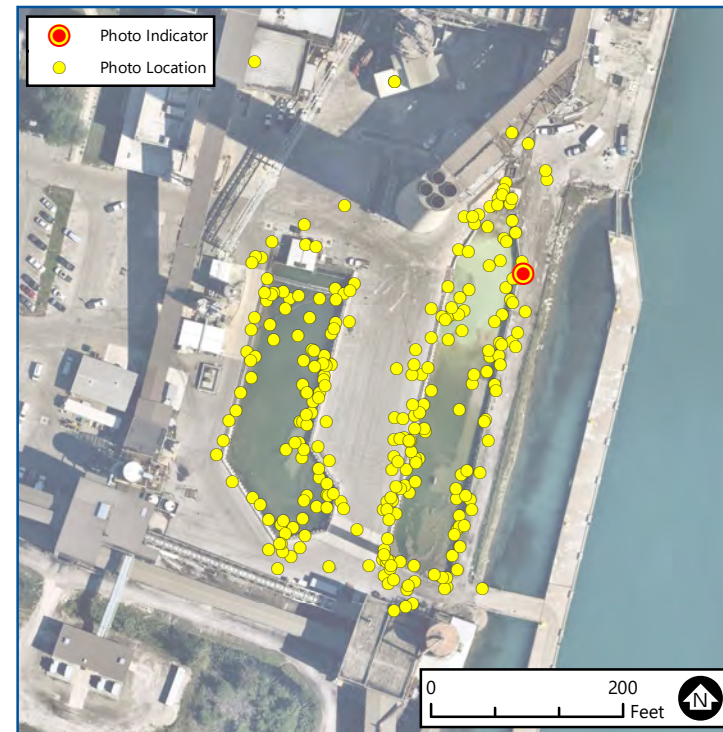

114 of 269
**CONSTRUCTION
MONITORING**
PHOTO LOCATIONS
St. Clair Power Plant
DTE Energy
East China, Michigan

Date: 12/13/2022

Note: East Basin

Photo 114-1 Caption:
E39, excavated to clay, looking west

Aerial Image: NearMap (8/10/2022)
NOTE: Photo locations are approximate.

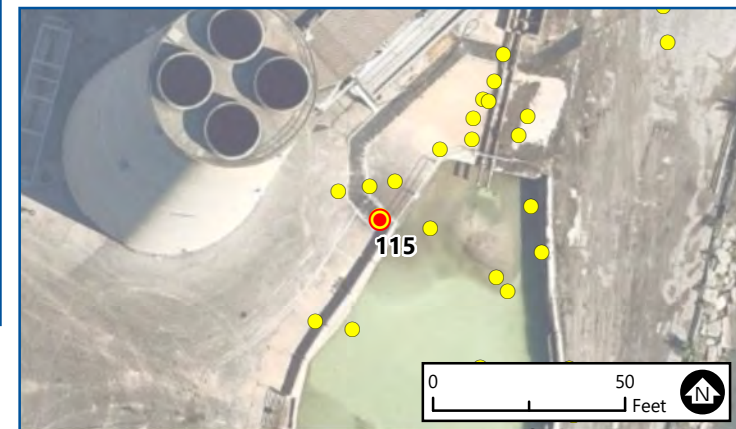

115 of 269
**CONSTRUCTION
MONITORING**
PHOTO LOCATIONS
St. Clair Power Plant
DTE Energy
East China, Michigan

Date: 12/13/2022

Note: East Basin

Photo 115-1 Caption:
E39, excavated to clay, looking east

Aerial Image: NearMap (8/10/2022)
NOTE: Photo locations are approximate.

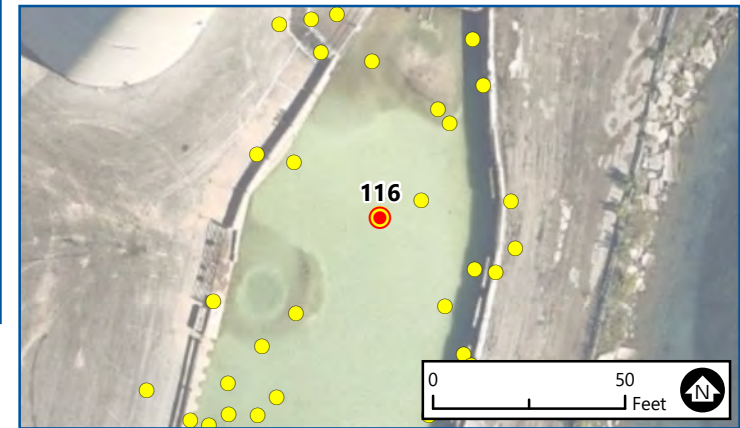

116 of 269
**CONSTRUCTION
MONITORING**
PHOTO LOCATIONS
St. Clair Power Plant
DTE Energy
East China, Michigan

Date: 12/13/2022

Note: East Basin

Photo 116-1 Caption:
E40, excavated to clay, looking east

Aerial Image: NearMap (8/10/2022)
NOTE: Photo locations are approximate.

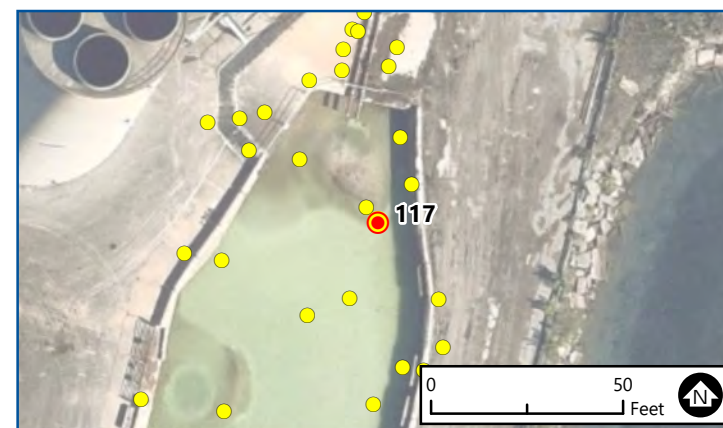
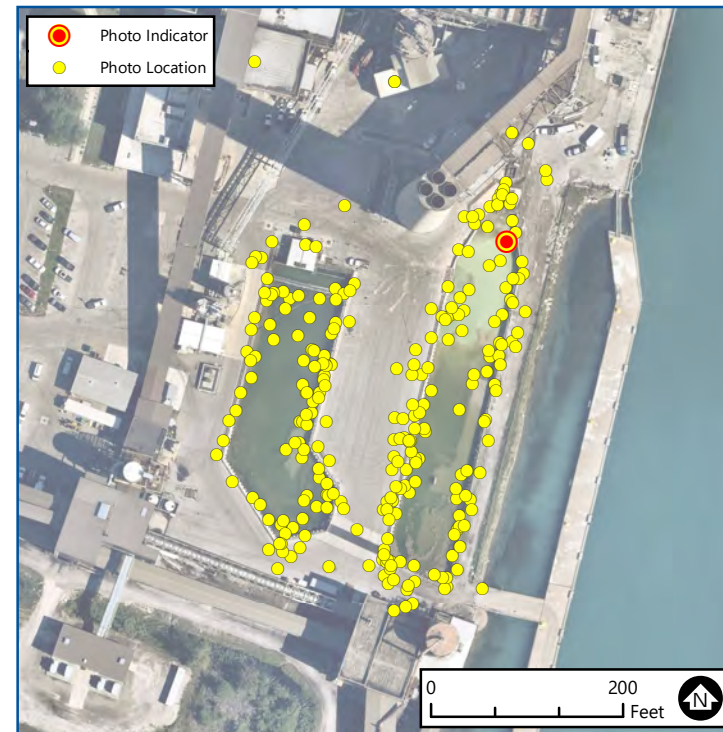

117 of 269
**CONSTRUCTION
MONITORING**
PHOTO LOCATIONS
St. Clair Power Plant
DTE Energy
East China, Michigan

Date: 12/13/2022
Note: East Basin

Photo 117-1 Caption:
E40, excavated to clay, looking west

Aerial Image: NearMap (8/10/2022)
NOTE: Photo locations are approximate.

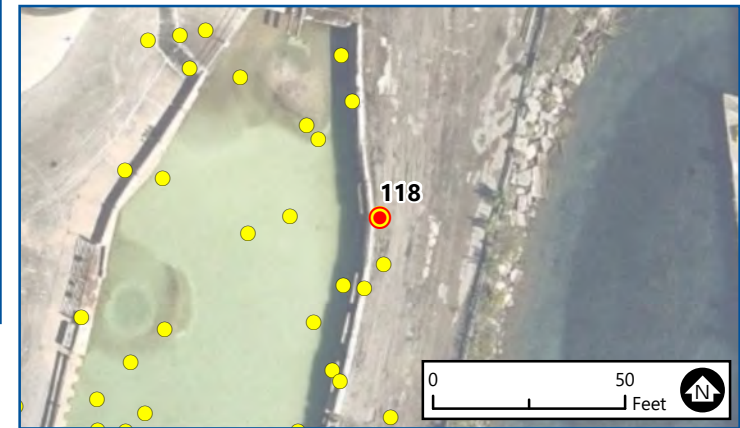

118 of 269
**CONSTRUCTION
MONITORING**
PHOTO LOCATIONS
St. Clair Power Plant
DTE Energy
East China, Michigan

Date: 12/13/2022

Note: East Basin

Photo 118-1 Caption:
E41, excavated to clay, looking SW

Aerial Image: NearMap (8/10/2022)
NOTE: Photo locations are approximate.

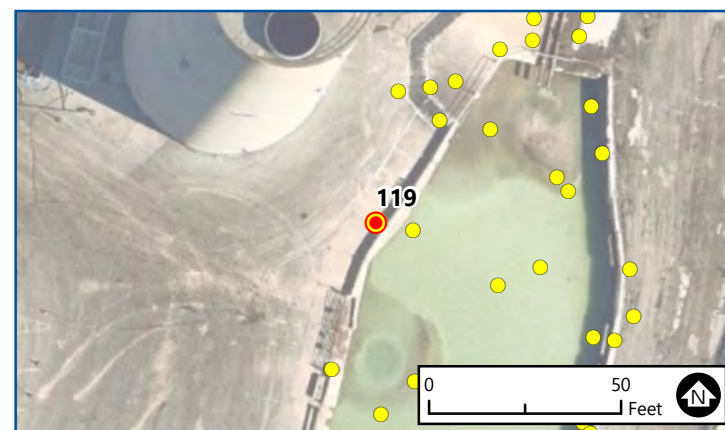
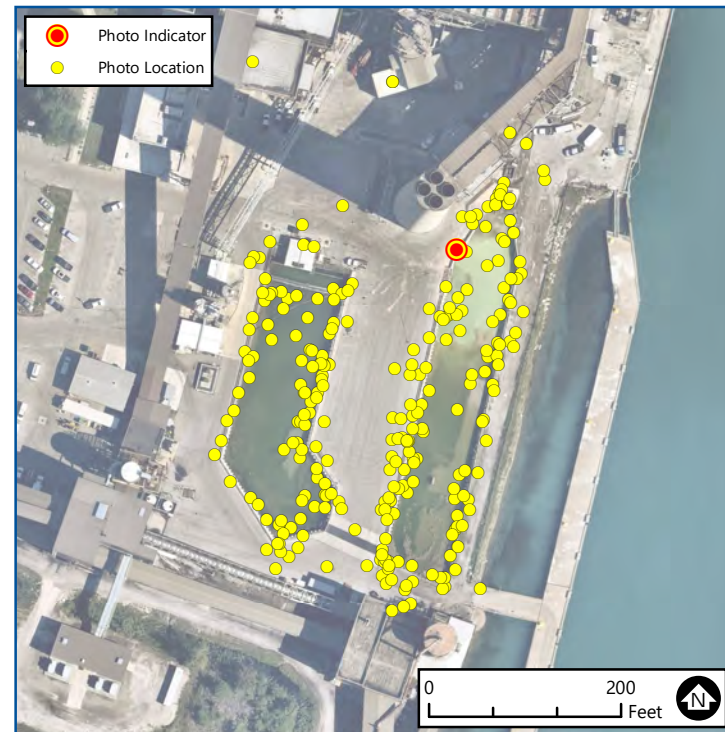

119 of 269
**CONSTRUCTION
MONITORING**
PHOTO LOCATIONS
St. Clair Power Plant
DTE Energy
East China, Michigan

Date: 12/13/2022

Note: East Basin

Photo 119-1 Caption:
E41, excavated to clay, looking east

Aerial Image: NearMap (8/10/2022)
NOTE: Photo locations are approximate.



Photo 120-1

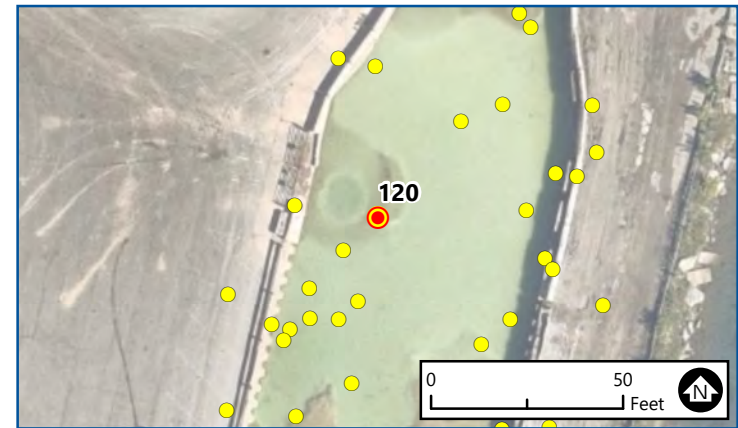
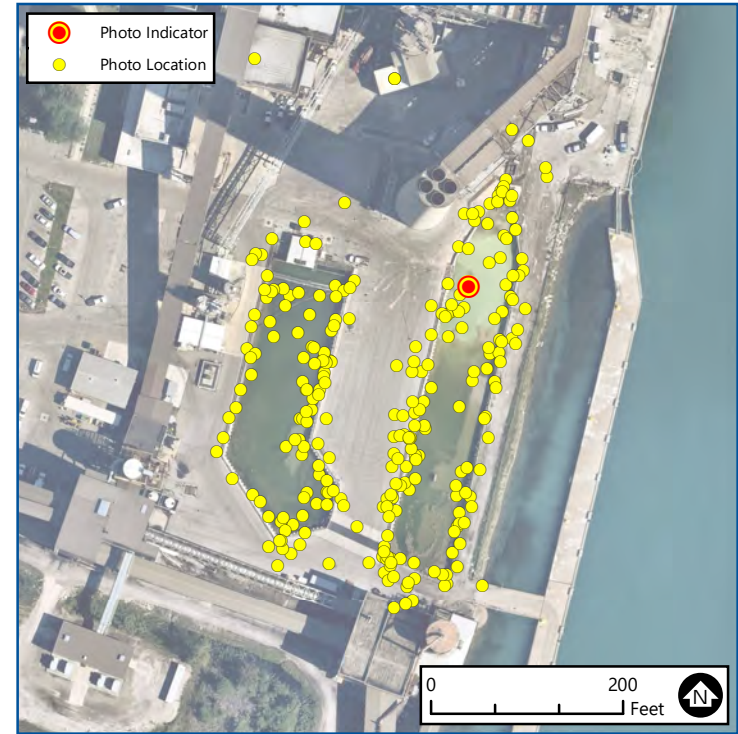

120 of 269
**CONSTRUCTION
MONITORING**
PHOTO LOCATIONS
St. Clair Power Plant
DTE Energy
East China, Michigan

Aerial Image: NearMap (8/10/2022)
NOTE: Photo locations are approximate.

Date: 12/14/2022

Note: East Basin

Photo 120-1 Caption:
E42, excavated to clay, looking east



Photo 121-1



121 of 269
**CONSTRUCTION
MONITORING**
PHOTO LOCATIONS
St. Clair Power Plant
DTE Energy
East China, Michigan

Date: 12/14/2022

Note: East Basin

Photo 121-1 Caption:
E42, excavated to clay, looking west

Aerial Image: NearMap (8/10/2022)
NOTE: Photo locations are approximate.



Photo 122-1

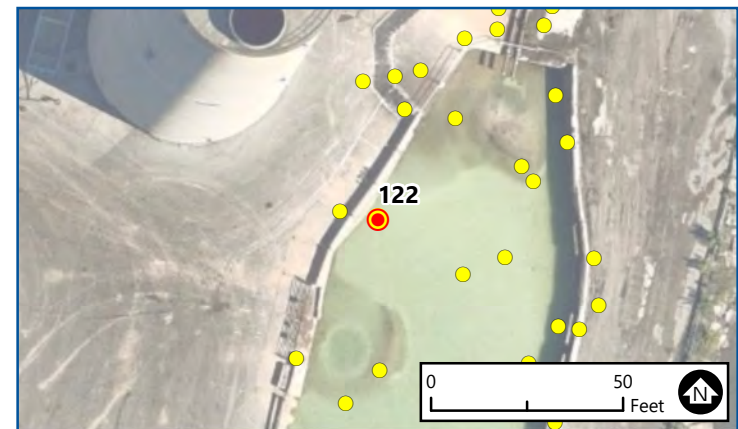
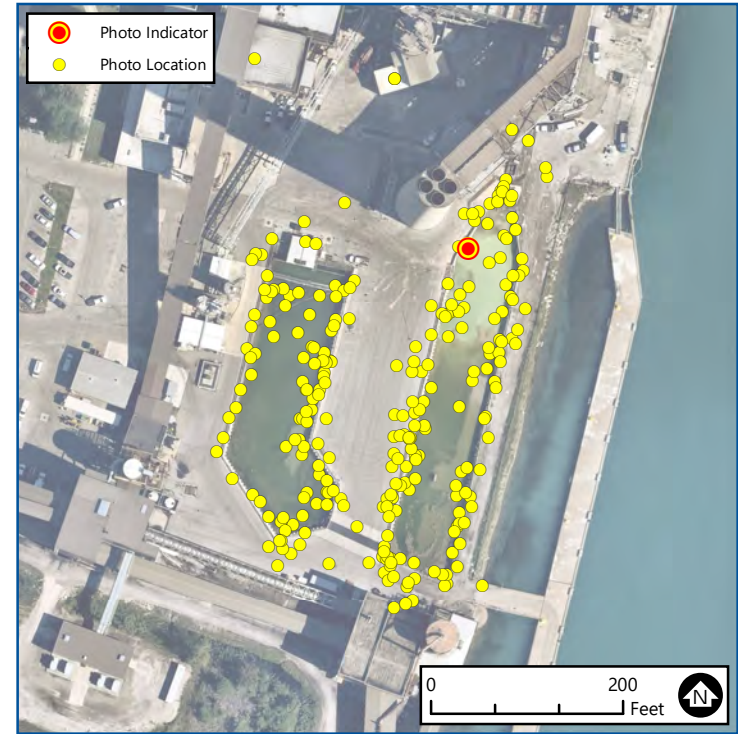

122 of 269
**CONSTRUCTION
MONITORING**
PHOTO LOCATIONS
St. Clair Power Plant
DTE Energy
East China, Michigan

Date: 12/14/2022

Note: East Basin

Photo 122-1 Caption:
E43, excavated to clay, looking SE

Aerial Image: NearMap (8/10/2022)
NOTE: Photo locations are approximate.

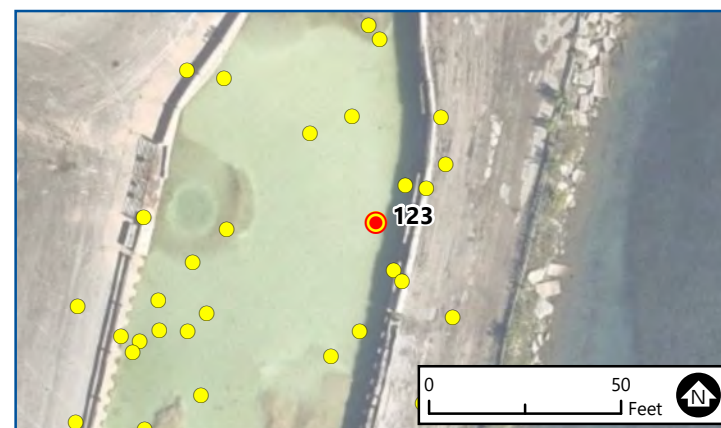
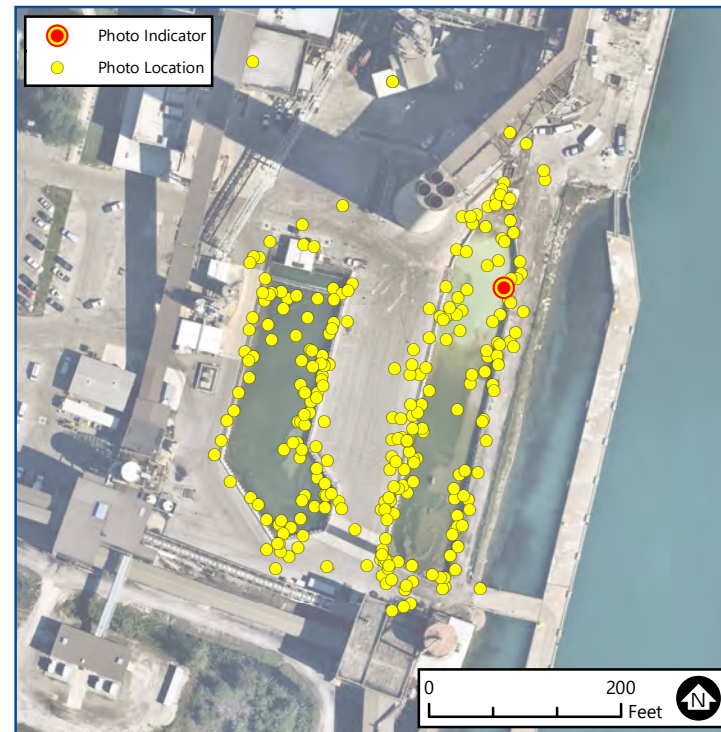

123 of 269
**CONSTRUCTION
MONITORING**
PHOTO LOCATIONS
St. Clair Power Plant
DTE Energy
East China, Michigan

Date: 12/14/2022

Note: East Basin

Photo 123-1 Caption:
E43, excavated to clay, looking SW

Aerial Image: NearMap (8/10/2022)
NOTE: Photo locations are approximate.

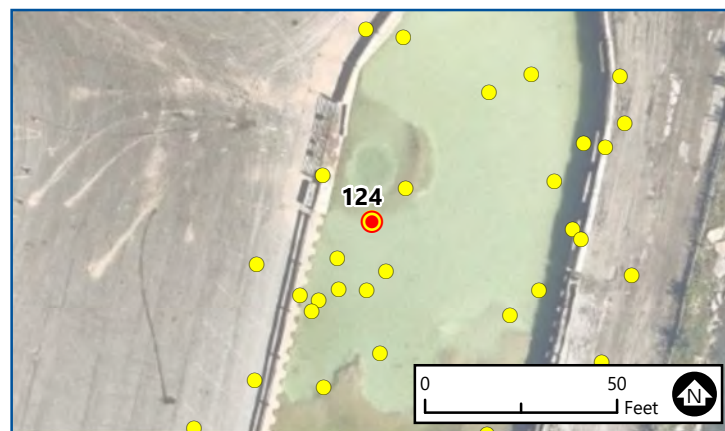
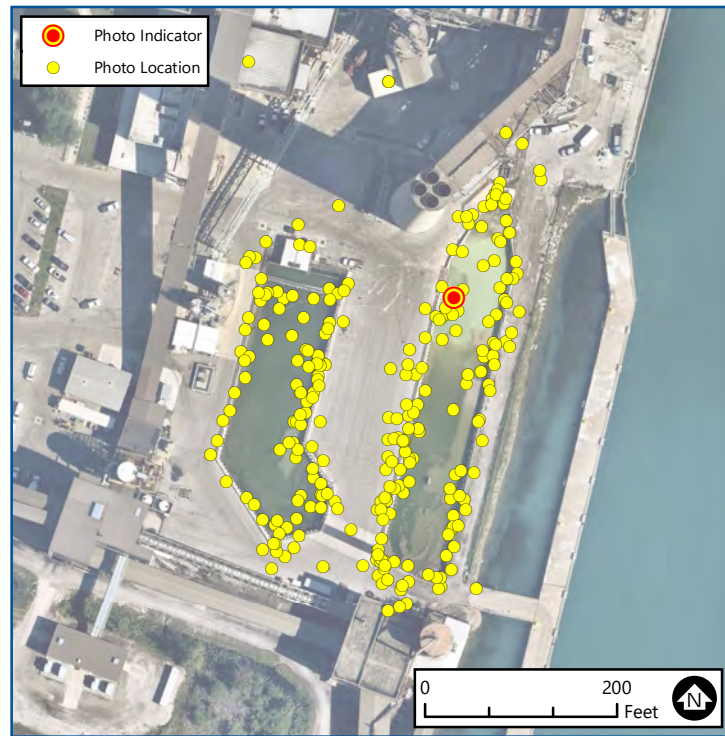

124 of 269
**CONSTRUCTION
MONITORING**
PHOTO LOCATIONS
St. Clair Power Plant
DTE Energy
East China, Michigan

Date: 12/14/2022
Note: East Basin

Photo 124-1 Caption:
E44, excavated to clay, looking east

Aerial Image: NearMap (8/10/2022)
NOTE: Photo locations are approximate.

Photo 125-1



Photo 125-2

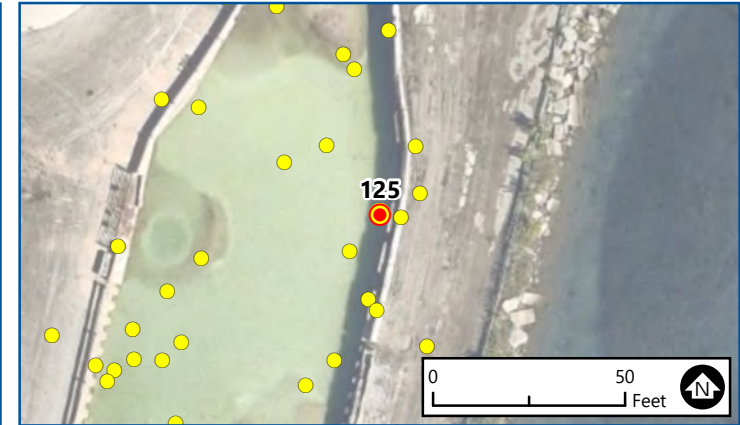

125 of 269
**CONSTRUCTION
MONITORING**
PHOTO LOCATIONS
St. Clair Power Plant
DTE Energy
East China, Michigan

Aerial Image: NearMap (8/10/2022)
NOTE: Photo locations are approximate.

Date: 12/16/2022

Note: East Basin

Photo 125-1 Caption:
E45, excavated to clay, looking west

Photo 125-2 Caption:
E45, excavated to clay, looking west

Photo 126-1



Photo 126-2

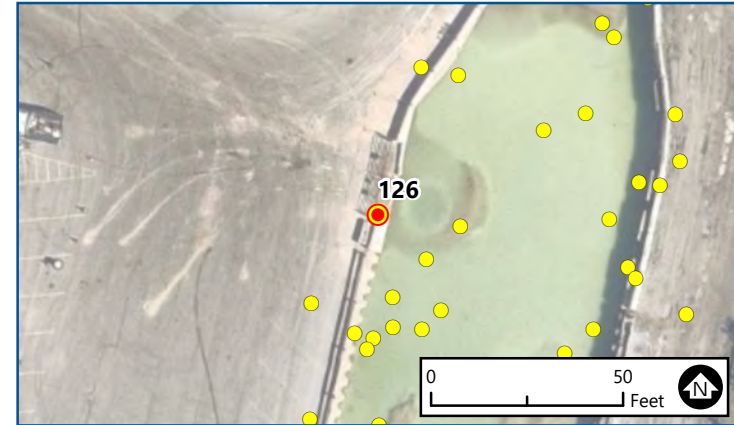

126 of 269
**CONSTRUCTION
MONITORING**
PHOTO LOCATIONS
St. Clair Power Plant
DTE Energy
East China, Michigan

Aerial Image: NearMap (8/10/2022)
NOTE: Photo locations are approximate.

Date: 12/16/2022

Note: East Basin

Photo 126-1 Caption:
E46, excavated to clay, looking SE

Photo 126-2 Caption:
E46, excavated to clay, looking NE



Photo 127-1

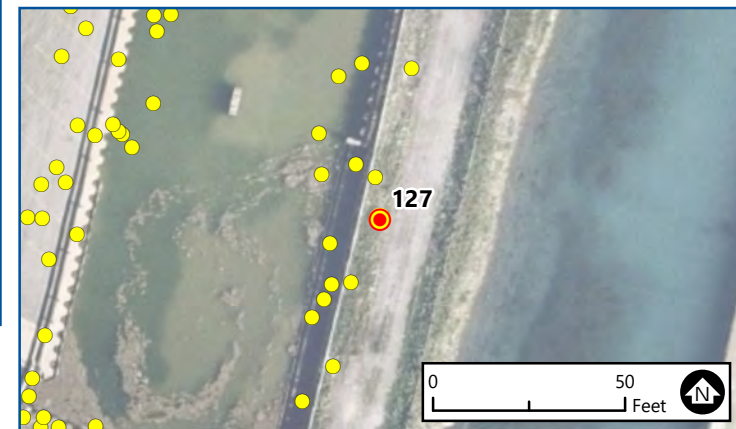

127 of 269
**CONSTRUCTION
MONITORING**
PHOTO LOCATIONS
St. Clair Power Plant
DTE Energy
East China, Michigan

Date: 12/21/2022

Note: East Basin

Photo 127-1 Caption:
CCR excavated from overflow canal,
looking south

Aerial Image: NearMap (8/10/2022)
NOTE: Photo locations are approximate.

Photo 128-1



Photo 128-2

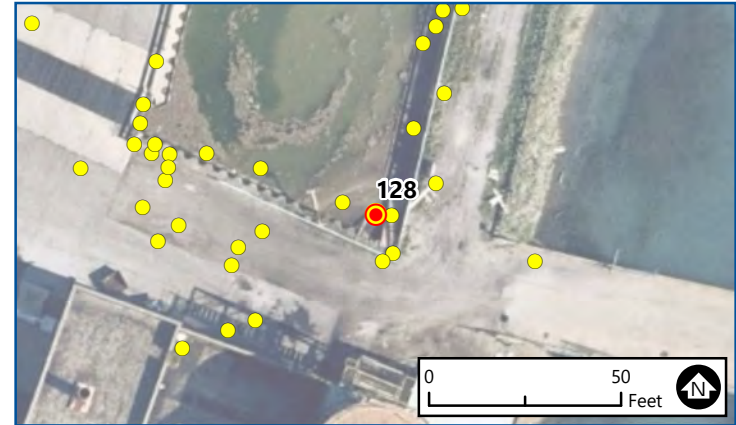

128 of 269
**CONSTRUCTION
MONITORING**
PHOTO LOCATIONS
St. Clair Power Plant
DTE Energy
East China, Michigan

Aerial Image: NearMap (8/10/2022)
NOTE: Photo locations are approximate.

Date: 12/21/2022

Note: East Basin

Photo 128-1 Caption:
CCR excavated from overflow canal,
looking north

Photo 128-2 Caption:
CCR excavated from overflow canal,
looking NE

Photo 129-1



Photo 129-2

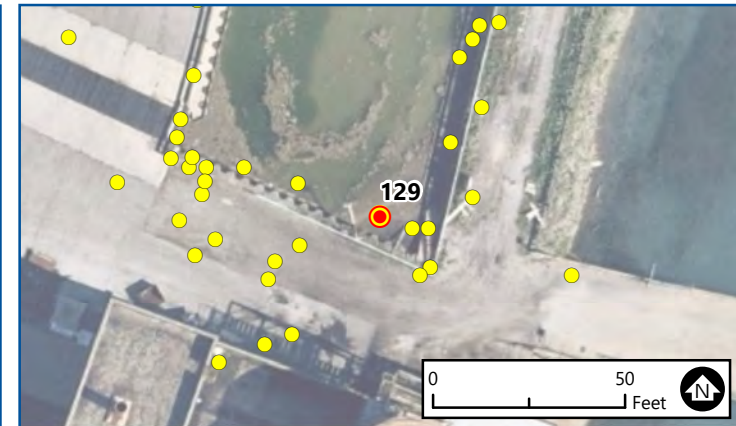

129 of 269
**CONSTRUCTION
MONITORING**
PHOTO LOCATIONS
St. Clair Power Plant
DTE Energy
East China, Michigan

Aerial Image: NearMap (8/10/2022)
NOTE: Photo locations are approximate.

Date: 12/21/2022

Note: East Basin

Photo 129-1 Caption:
Overflow canal inlet 1

Photo 129-2 Caption:
Overflow canal inlet 2

Photo 130-1



Photo 130-2



130 of 269
**CONSTRUCTION
MONITORING**
PHOTO LOCATIONS
St. Clair Power Plant
DTE Energy
East China, Michigan

Aerial Image: NearMap (8/10/2022)
NOTE: Photo locations are approximate.

Date: 12/21/2022

Note: East Basin

Photo 130-1 Caption:
Overflow canal inlet 3

Photo 130-2 Caption:
Overflow canal inlet 4

Photo 131-1



Photo 131-2

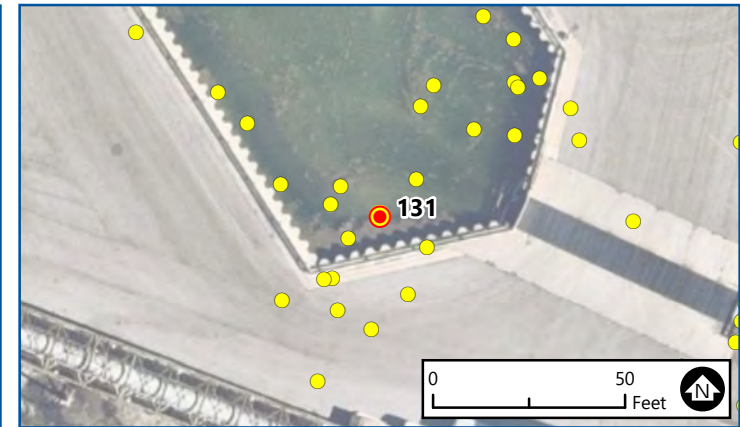

131 of 269
**CONSTRUCTION
MONITORING**
PHOTO LOCATIONS
St. Clair Power Plant
DTE Energy
East China, Michigan

Aerial Image: NearMap (8/10/2022)
NOTE: Photo locations are approximate.

Date: 12/21/2022

Note: West Basin

Photo 131-1 Caption:
West basin looking south - CCR removal
to Elev. 572'

Photo 131-2 Caption:
West basin looking north - CCR removal
to Elev. 572'

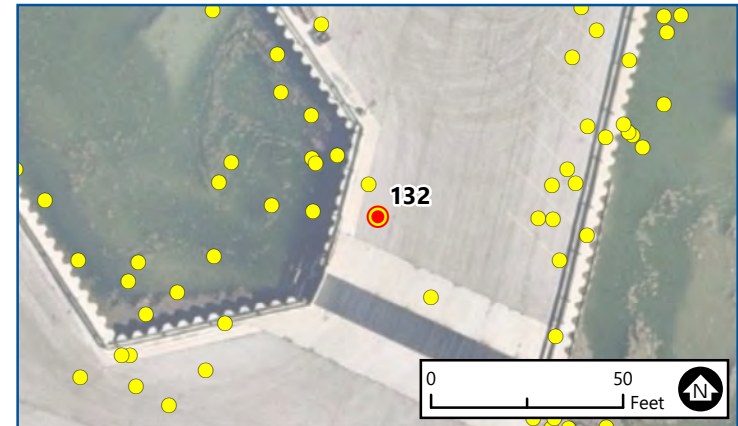
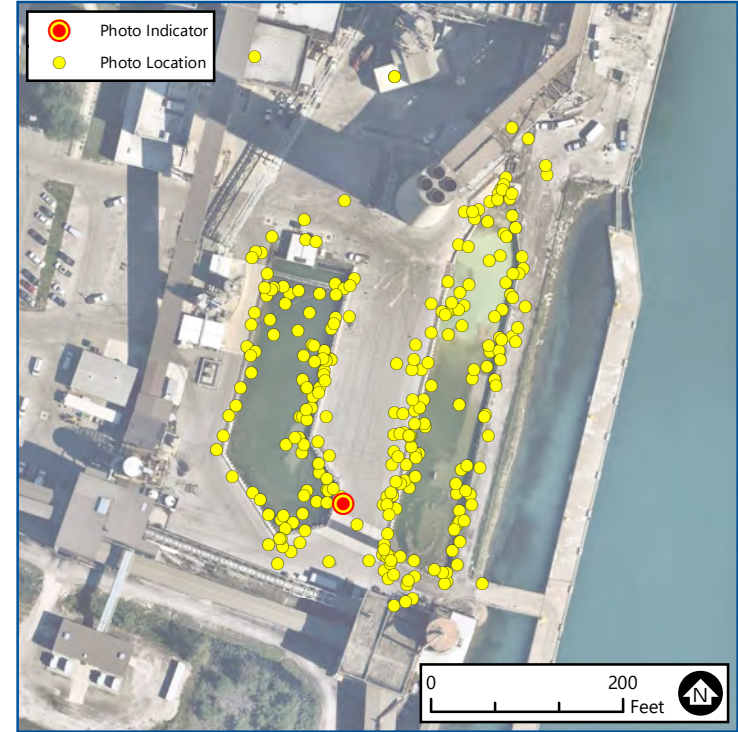
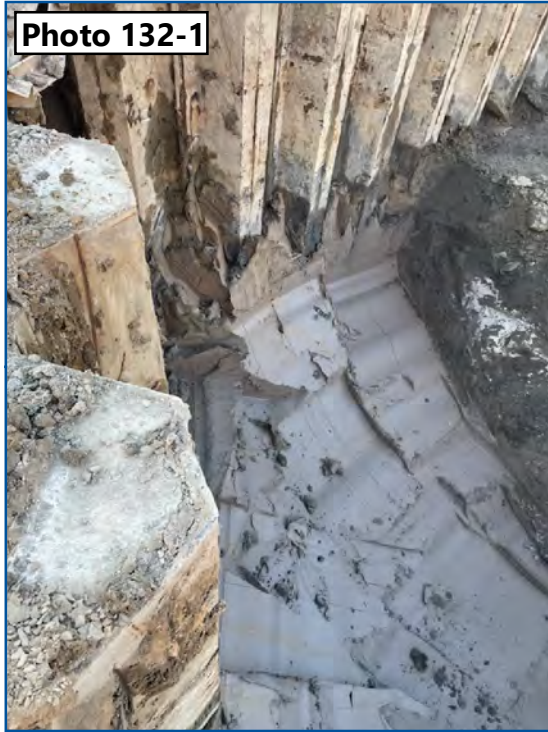

132 of 269
**CONSTRUCTION
MONITORING**
PHOTO LOCATIONS
St. Clair Power Plant
DTE Energy
East China, Michigan

Aerial Image: NearMap (8/10/2022)
NOTE: Photo locations are approximate.

Date: 12/21/2022

Note: West Basin

Photo 132-1 Caption:
W1, excavated to clay, looking south

Photo 132-2 Caption:
W1, excavated to clay, looking north

Photo 133-1



Photo 133-2

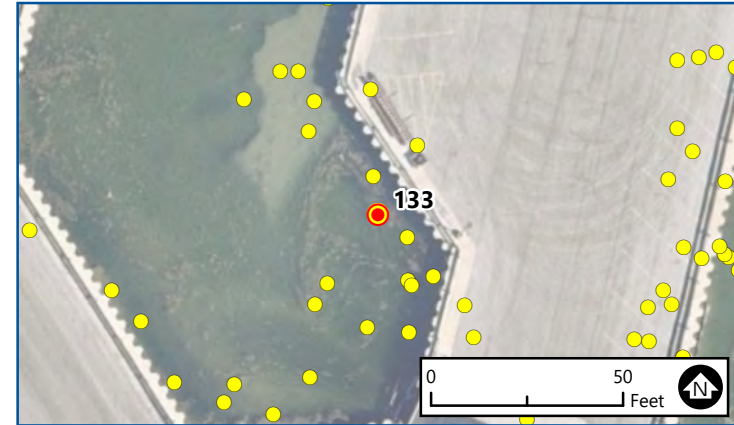

133 of 269
**CONSTRUCTION
MONITORING**
PHOTO LOCATIONS
St. Clair Power Plant
DTE Energy
East China, Michigan

Aerial Image: NearMap (8/10/2022)
NOTE: Photo locations are approximate.

Date: 12/21/2022

Note: West Basin

Photo 133-1 Caption:
W2, excavated to clay, looking north

Photo 133-2 Caption:
W2, excavated to clay, looking north

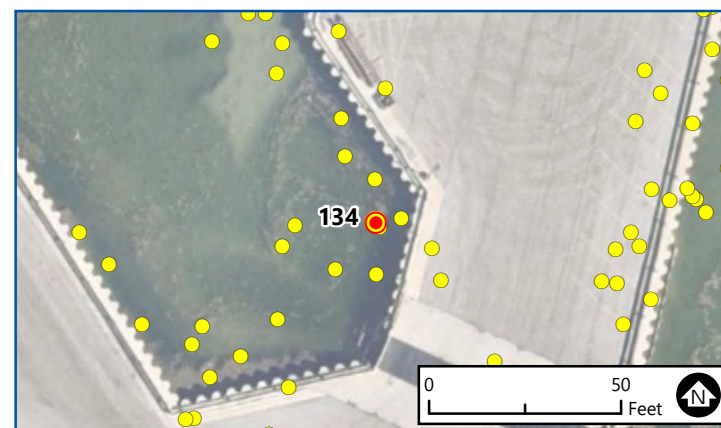
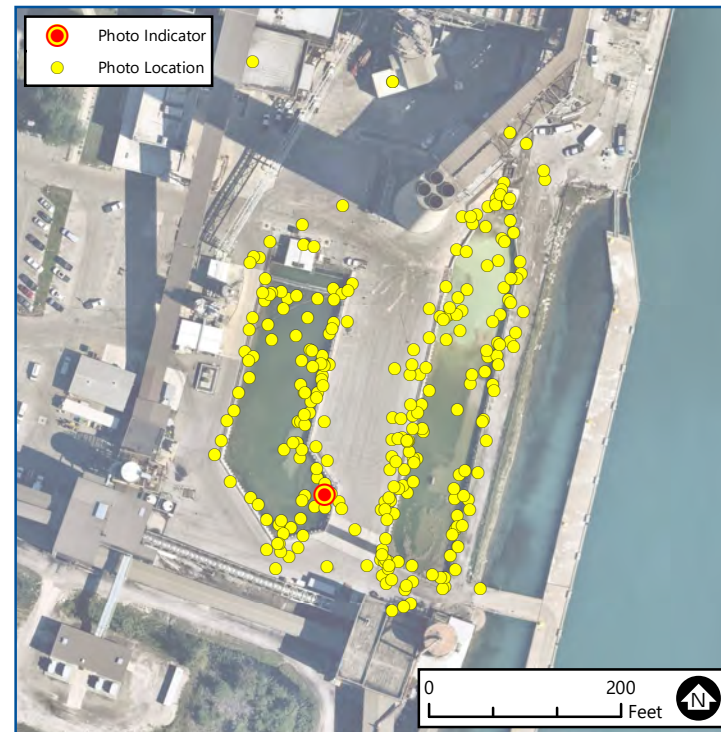

134 of 269
**CONSTRUCTION
MONITORING**
PHOTO LOCATIONS
St. Clair Power Plant
DTE Energy
East China, Michigan

Date: 12/21/2022
Note: West Basin

Photo 134-1 Caption:
W2, excavated to clay, looking west

Aerial Image: NearMap (8/10/2022)
NOTE: Photo locations are approximate.

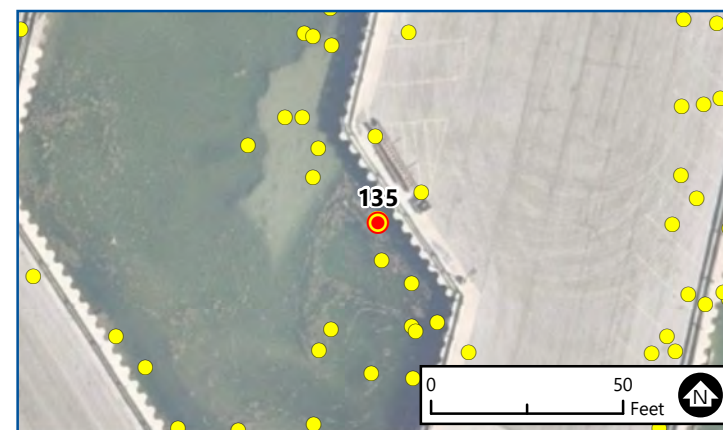
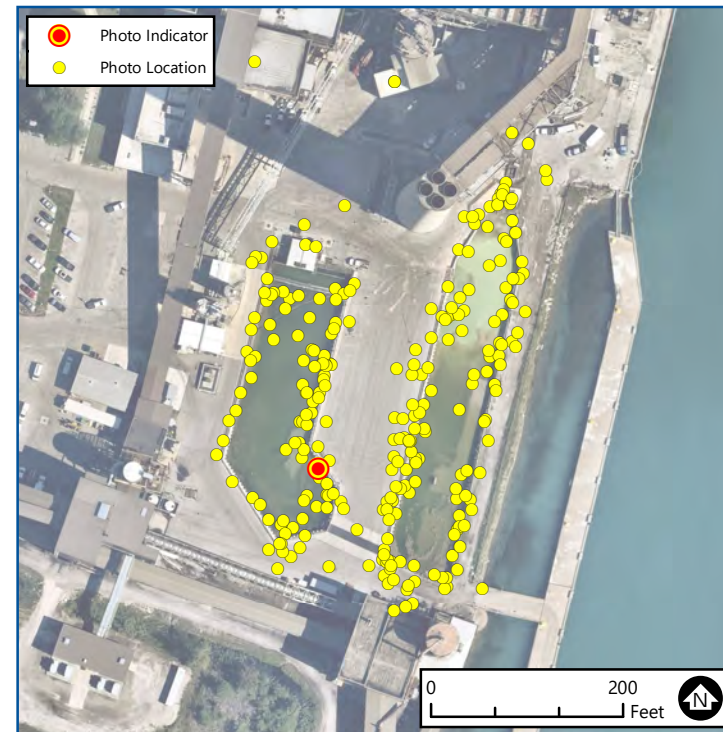

135 of 269
**CONSTRUCTION
MONITORING**
PHOTO LOCATIONS
St. Clair Power Plant
DTE Energy
East China, Michigan

Aerial Image: NearMap (8/10/2022)
NOTE: Photo locations are approximate.

Date: 12/21/2022
Note: West Basin

Photo 135-1 Caption:
W2, excavated to clay, looking south

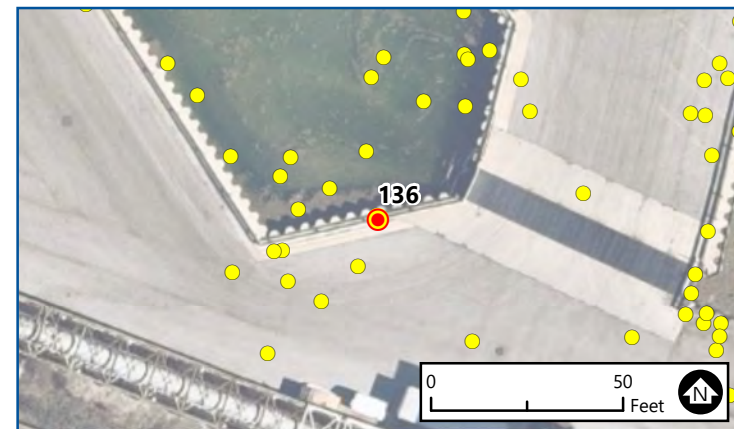

136 of 269
**CONSTRUCTION
MONITORING**
PHOTO LOCATIONS
St. Clair Power Plant
DTE Energy
East China, Michigan

Aerial Image: NearMap (8/10/2022)
NOTE: Photo locations are approximate.

Date: 12/21/2022

Note: West Basin

Photo 136-1 Caption:
W3, excavated to clay, looking NW



137 of 269
**CONSTRUCTION
MONITORING**
PHOTO LOCATIONS
St. Clair Power Plant
DTE Energy
East China, Michigan

Date: 12/21/2022

Note: West Basin

Photo 137-1 Caption:
W3, excavated to clay, looking north

Aerial Image: NearMap (8/10/2022)
NOTE: Photo locations are approximate.



Photo 138-1

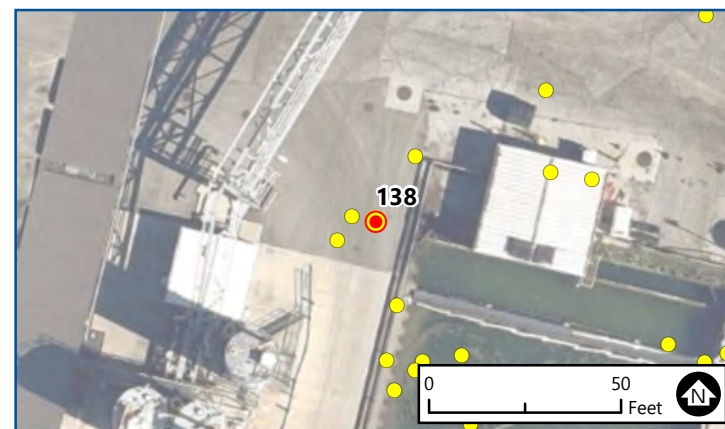
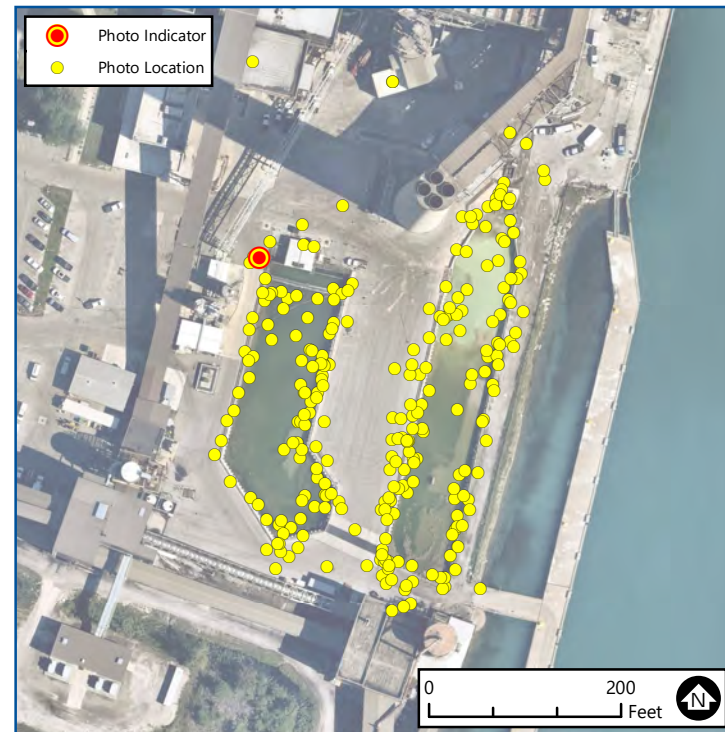

138 of 269
**CONSTRUCTION
MONITORING**
PHOTO LOCATIONS
St. Clair Power Plant
DTE Energy
East China, Michigan

Aerial Image: NearMap (8/10/2022)
NOTE: Photo locations are approximate.

Date: 12/21/2022
Note: General Site Photo

Photo 138-1 Caption:
West basin looking south - CCR removal
in progress



Photo 139-1

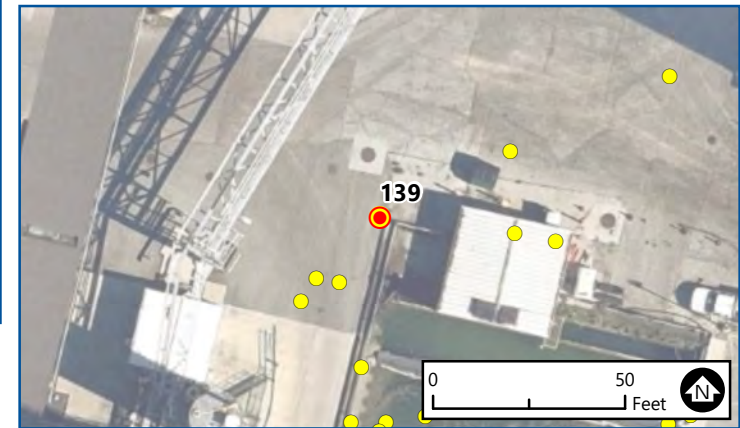

139 of 269
**CONSTRUCTION
MONITORING**
PHOTO LOCATIONS
St. Clair Power Plant
DTE Energy
East China, Michigan

Aerial Image: NearMap (8/10/2022)
NOTE: Photo locations are approximate.

Date: 12/21/2022
Note: General Site Photo
Photo 139-1 Caption:
West basin looking south - CCR removal
in progress



Photo 140-1

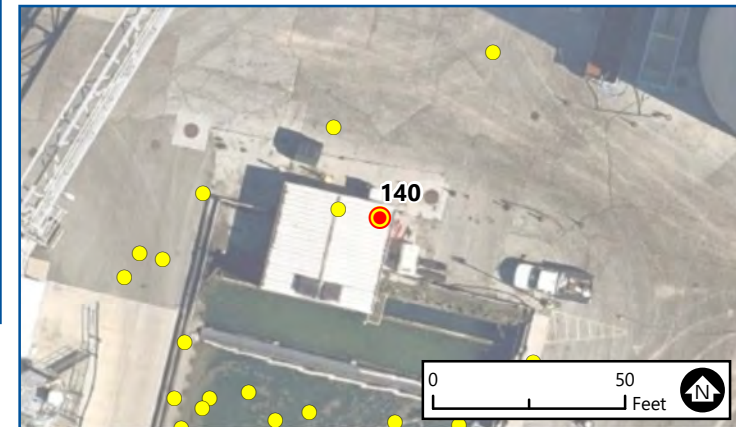

140 of 269
**CONSTRUCTION
MONITORING**
PHOTO LOCATIONS
St. Clair Power Plant
DTE Energy
East China, Michigan

Aerial Image: NearMap (8/10/2022)
NOTE: Photo locations are approximate.

Date: 12/21/2022
Note: General Site Photo

Photo 140-1 Caption:
West basin looking south - CCR removal
to Elev. 572'

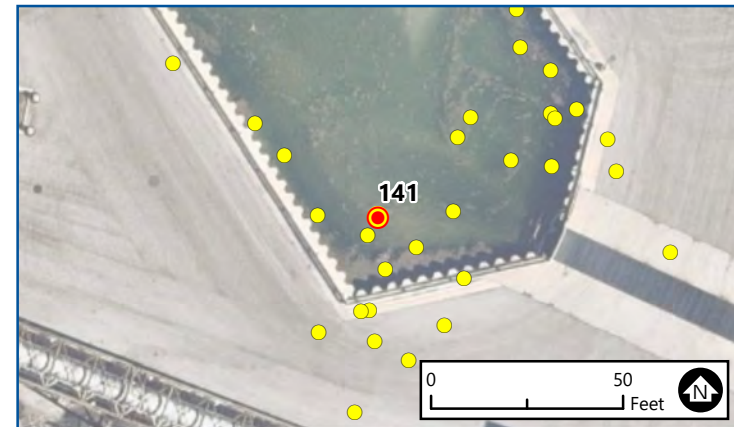

141 of 269
**CONSTRUCTION
MONITORING**
PHOTO LOCATIONS
St. Clair Power Plant
DTE Energy
East China, Michigan

Aerial Image: NearMap (8/10/2022)
NOTE: Photo locations are approximate.

Date: 12/22/2022

Note: West Basin

Photo 141-1 Caption:
W4, excavated to clay, looking NW

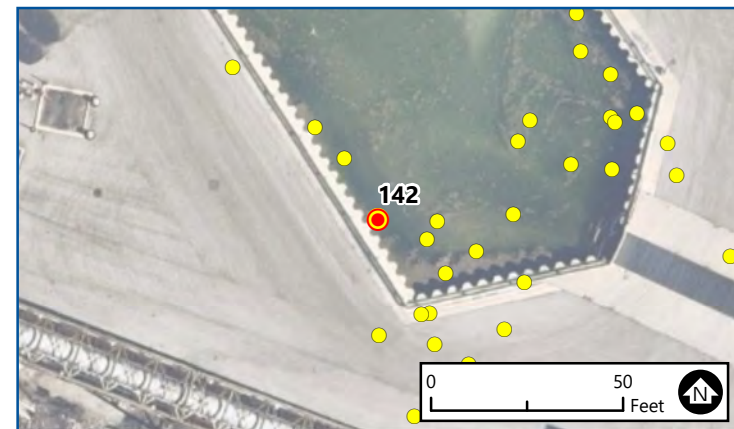

142 of 269
**CONSTRUCTION
MONITORING**
PHOTO LOCATIONS
St. Clair Power Plant
DTE Energy
East China, Michigan

Date: 12/22/2022

Note: West Basin

Photo 142-1 Caption:
W4, excavated to clay, looking east

Aerial Image: NearMap (8/10/2022)
NOTE: Photo locations are approximate.

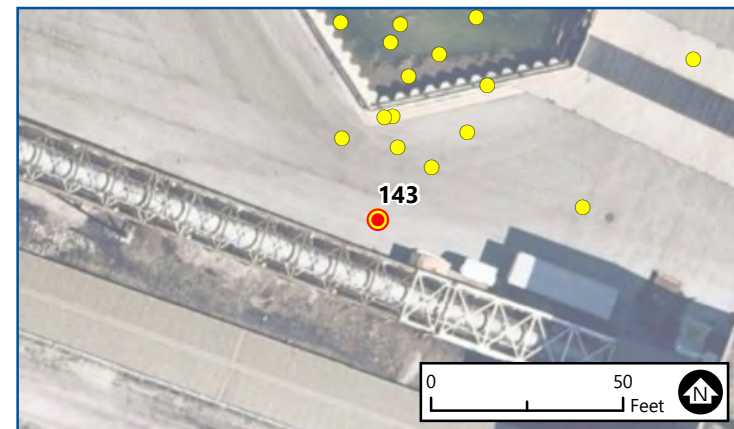

143 of 269
**CONSTRUCTION
MONITORING**
PHOTO LOCATIONS
St. Clair Power Plant
DTE Energy
East China, Michigan

Aerial Image: NearMap (8/10/2022)
NOTE: Photo locations are approximate.

Date: 12/22/2022

Note: West Basin

Photo 143-1 Caption:
W5, excavated to clay by sheet pile,
looking NW

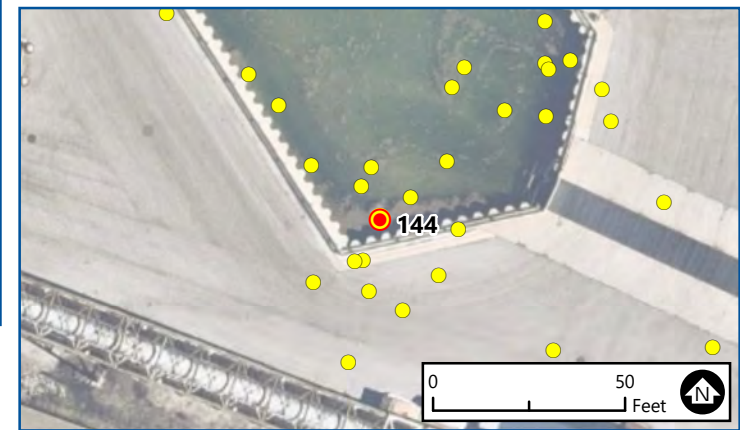

144 of 269
**CONSTRUCTION
MONITORING**
PHOTO LOCATIONS
St. Clair Power Plant
DTE Energy
East China, Michigan

Aerial Image: NearMap (8/10/2022)
NOTE: Photo locations are approximate.

Date: 12/22/2022

Note: West Basin

Photo 144-1 Caption:
W5, excavated to clay, looking north



Photo 145-1



145 of 269
**CONSTRUCTION
MONITORING**
PHOTO LOCATIONS
St. Clair Power Plant
DTE Energy
East China, Michigan

Date: 12/22/2022

Note: West Basin

Photo 145-1 Caption:
W6, excavated to clay, looking NE

Aerial Image: NearMap (8/10/2022)
NOTE: Photo locations are approximate.



Photo 146-1

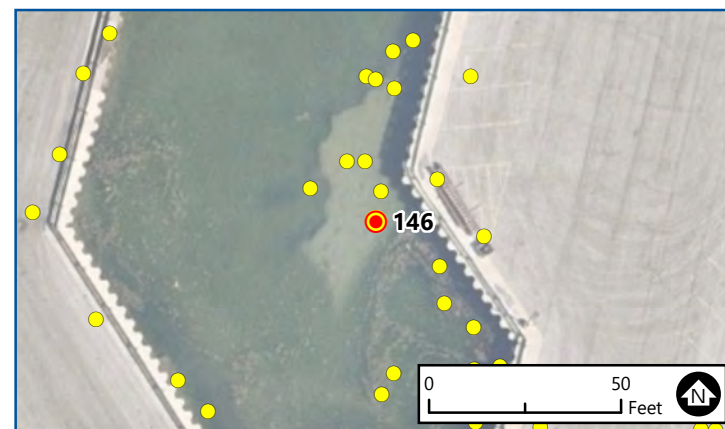
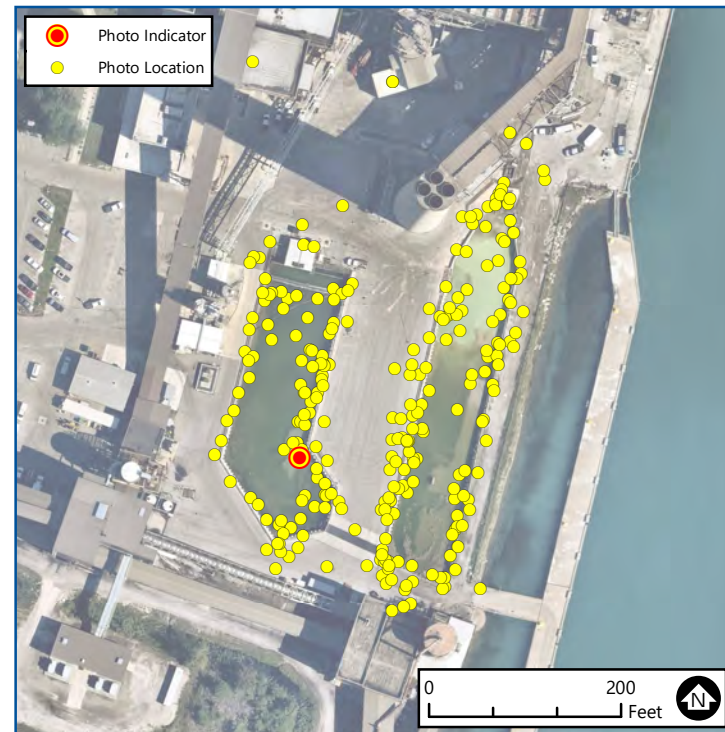

146 of 269
**CONSTRUCTION
MONITORING**
PHOTO LOCATIONS
St. Clair Power Plant
DTE Energy
East China, Michigan

Date: 12/22/2022
Note: West Basin

Photo 146-1 Caption:
W6, excavated to clay, looking south

Aerial Image: NearMap (8/10/2022)
NOTE: Photo locations are approximate.



Photo 147-1

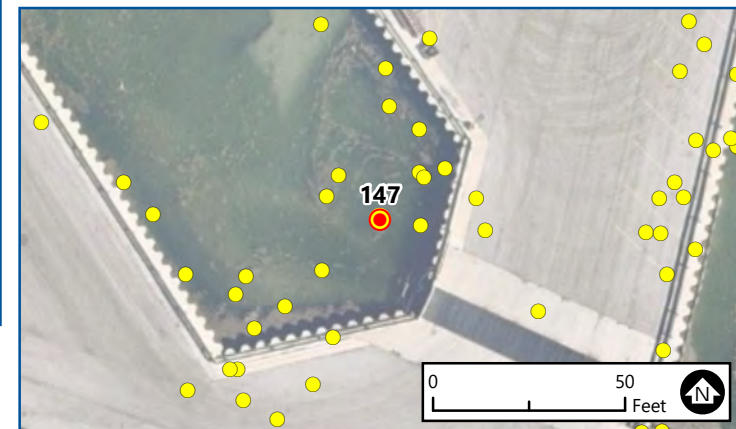

147 of 269
**CONSTRUCTION
MONITORING**
PHOTO LOCATIONS
St. Clair Power Plant
DTE Energy
East China, Michigan

Date: 12/22/2022

Note: West Basin

Photo 147-1 Caption:
W7, excavated to clay, looking SW

Aerial Image: NearMap (8/10/2022)
NOTE: Photo locations are approximate.

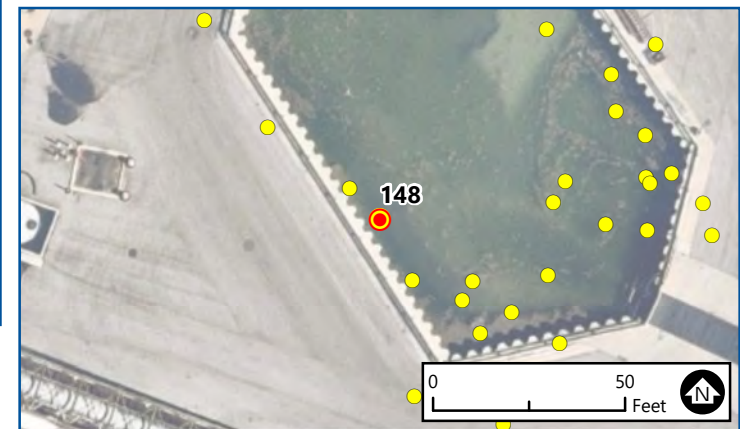

148 of 269
**CONSTRUCTION
MONITORING**
PHOTO LOCATIONS
St. Clair Power Plant
DTE Energy
East China, Michigan

Date: 12/22/2022

Note: West Basin

Photo 148-1 Caption:
W7, excavated to clay, looking NE

Aerial Image: NearMap (8/10/2022)
NOTE: Photo locations are approximate.

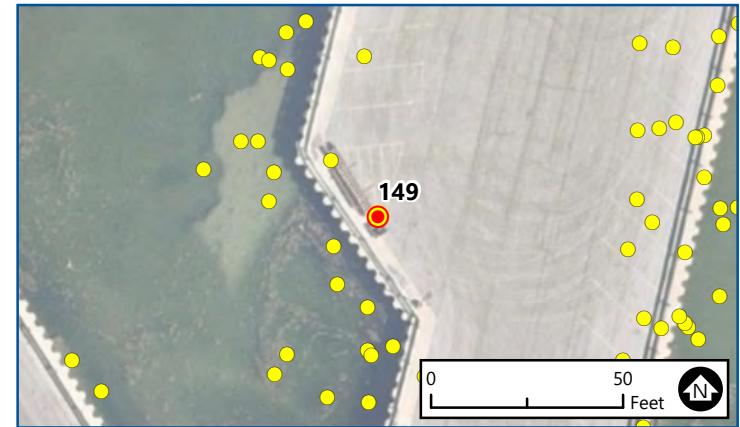
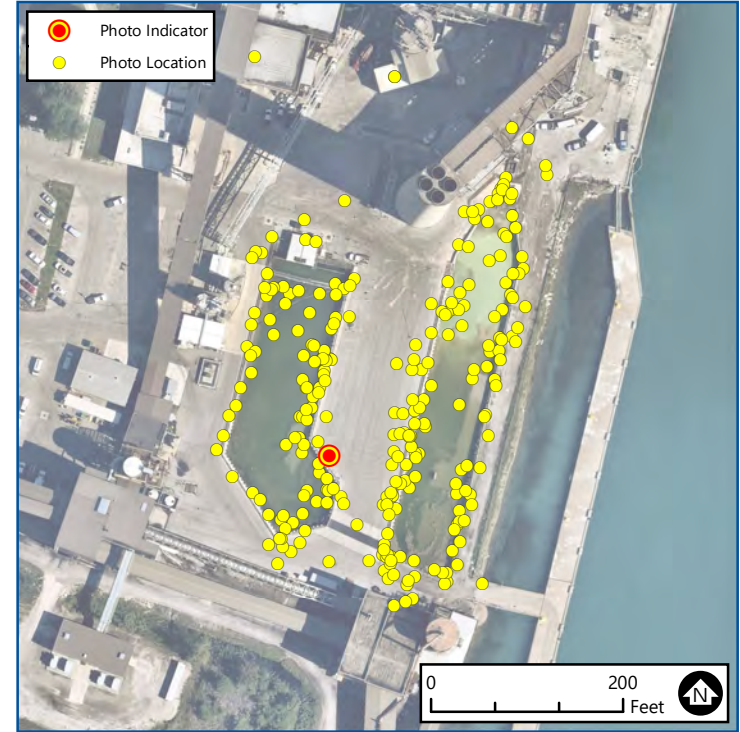

149 of 269
CONSTRUCTION MONITORING
PHOTO LOCATIONS
St. Clair Power Plant
DTE Energy
East China, Michigan

Date: 12/28/2022
Note: West Basin

Photo 149-1 Caption:
W8, excavated to clay, looking east

Photo 149-2 Caption:
W8, excavated to clay, looking west

Aerial Image: NearMap (8/10/2022)
NOTE: Photo locations are approximate.



150 of 269
**CONSTRUCTION
MONITORING**
PHOTO LOCATIONS
St. Clair Power Plant
DTE Energy
East China, Michigan

Aerial Image: NearMap (8/10/2022)
NOTE: Photo locations are approximate.

Date: 12/28/2022

Note: West Basin

Photo 150-1 Caption:
W9, excavated to clay, looking west

Photo 150-2 Caption:
W9, excavated to clay, looking east

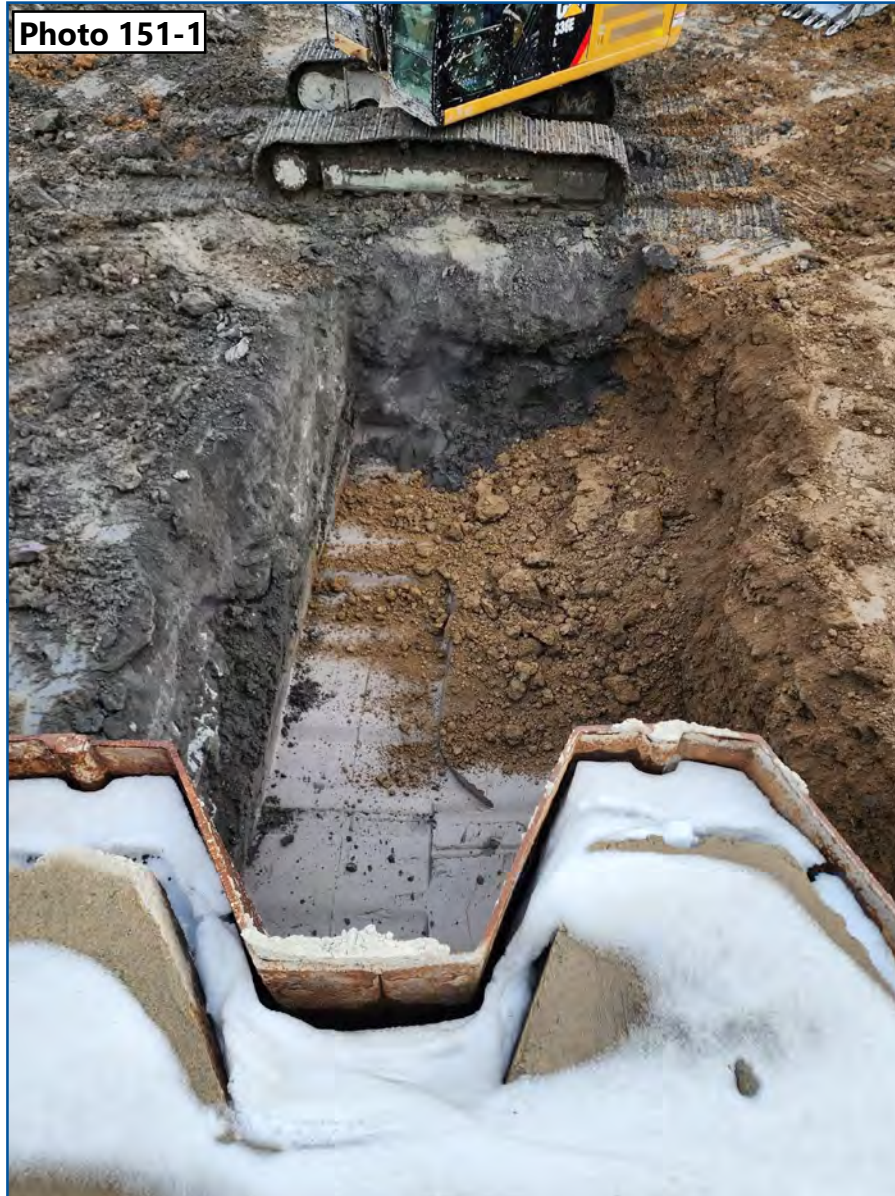
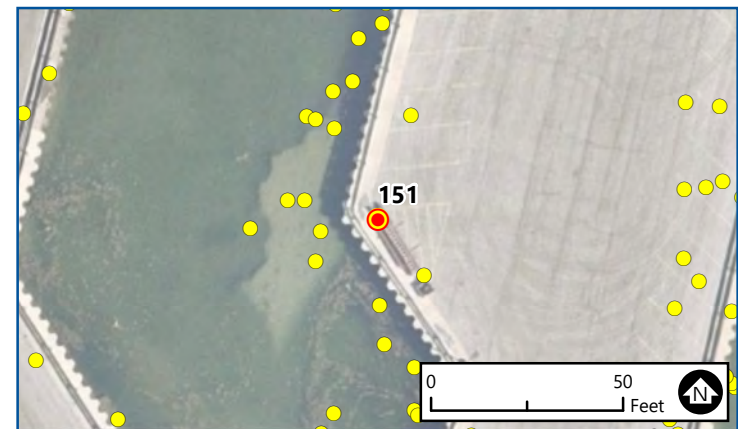
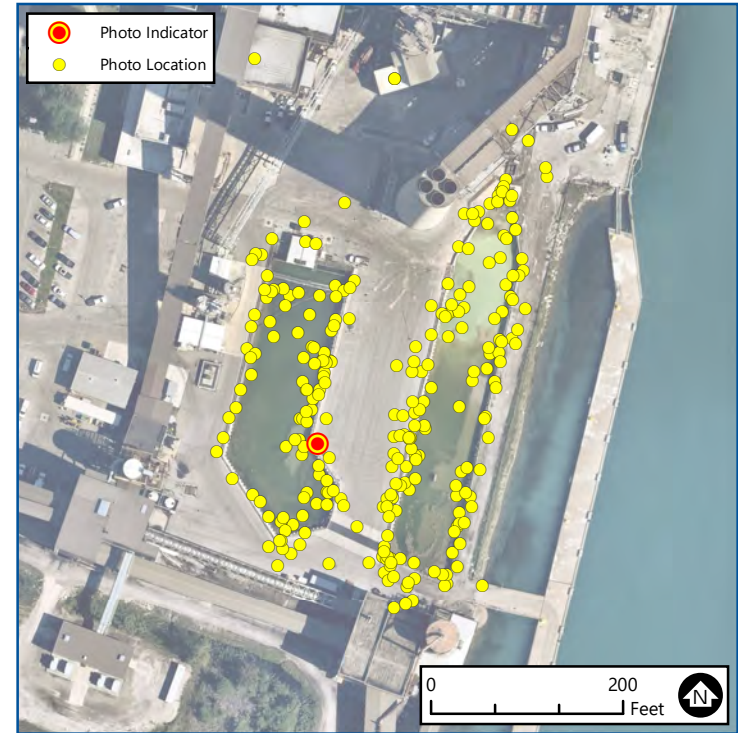

Photo 151-1



151 of 269
**CONSTRUCTION
MONITORING**
PHOTO LOCATIONS
St. Clair Power Plant
DTE Energy
East China, Michigan

Date: 12/28/2022

Note: West Basin

Photo 151-1 Caption:
W9, excavated to clay, looking east

Aerial Image: NearMap (8/10/2022)
NOTE: Photo locations are approximate.



152 of 269
**CONSTRUCTION
MONITORING**
PHOTO LOCATIONS
St. Clair Power Plant
DTE Energy
East China, Michigan

Date: 12/30/2022

Note: West Basin

Photo 152-1 Caption:
W10, excavated to clay, looking east

Aerial Image: NearMap (8/10/2022)
NOTE: Photo locations are approximate.



153 of 269
**CONSTRUCTION
MONITORING**
PHOTO LOCATIONS
St. Clair Power Plant
DTE Energy
East China, Michigan

Aerial Image: NearMap (8/10/2022)
NOTE: Photo locations are approximate.

Date: 12/29/2022

Note: West Basin

Photo 153-1 Caption:
W11, excavated to clay, looking west

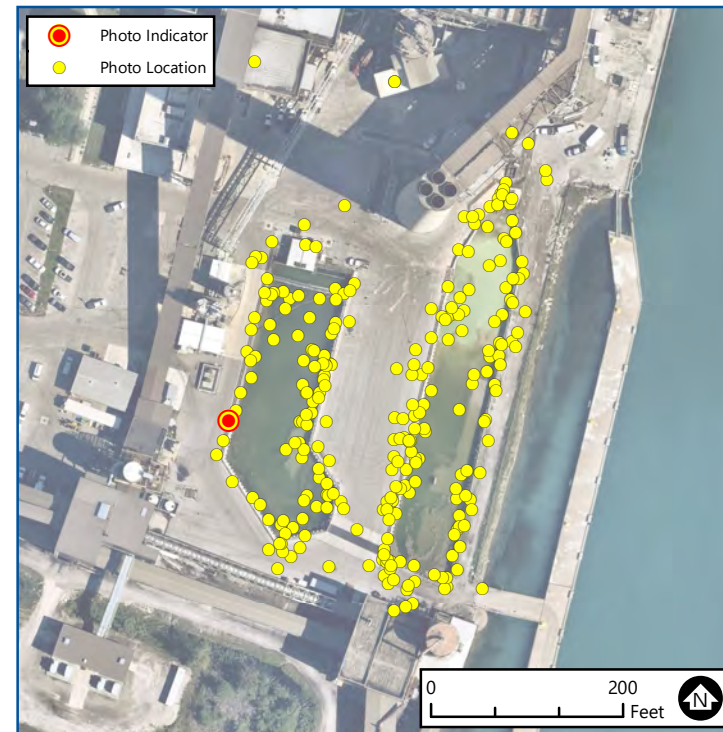

154 of 269
**CONSTRUCTION
MONITORING**
PHOTO LOCATIONS
St. Clair Power Plant
DTE Energy
East China, Michigan

Date: 12/29/2022

Note: West Basin

Photo 154-1 Caption:
W11, excavated to clay, looking east

Aerial Image: NearMap (8/10/2022)
NOTE: Photo locations are approximate.

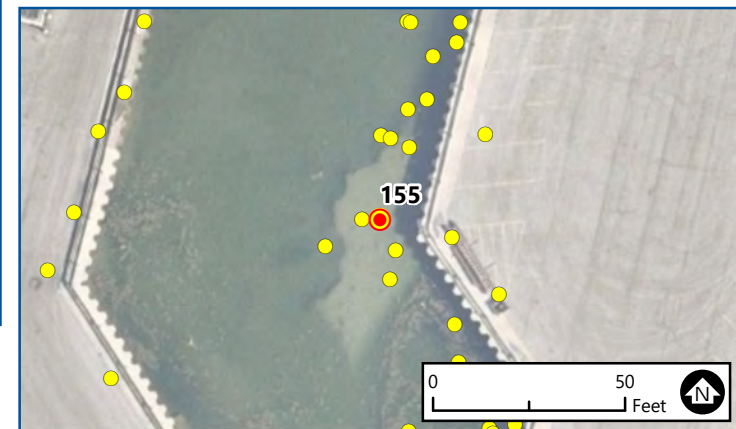

155 of 269
**CONSTRUCTION
MONITORING**
PHOTO LOCATIONS
St. Clair Power Plant
DTE Energy
East China, Michigan

Date: 12/29/2022

Note: West Basin

Photo 155-1 Caption:
W12, excavated to clay, looking west

Aerial Image: NearMap (8/10/2022)
NOTE: Photo locations are approximate.



Photo 156-1

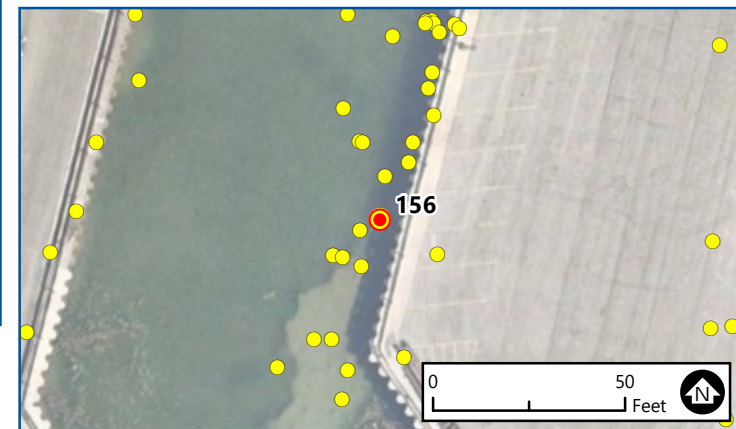

156 of 269
**CONSTRUCTION
MONITORING**
PHOTO LOCATIONS
St. Clair Power Plant
DTE Energy
East China, Michigan

Date: 12/29/2022

Note: West Basin

Photo 156-1 Caption:
W13, excavated to clay, looking west

Aerial Image: NearMap (8/10/2022)
NOTE: Photo locations are approximate.

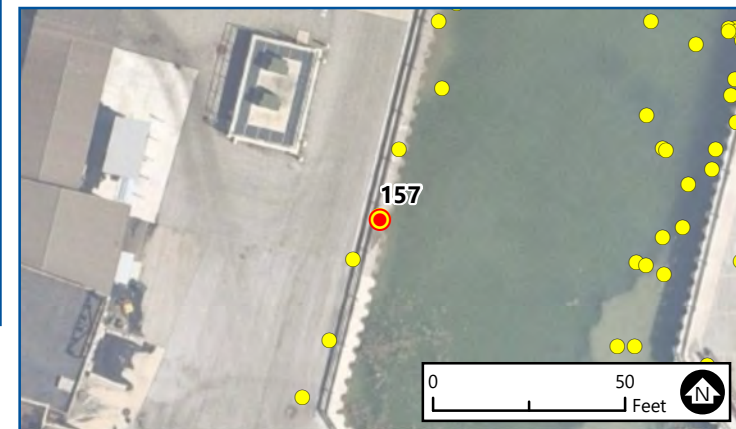

157 of 269
**CONSTRUCTION
MONITORING**
PHOTO LOCATIONS
St. Clair Power Plant
DTE Energy
East China, Michigan

Aerial Image: NearMap (8/10/2022)
NOTE: Photo locations are approximate.

Date: 12/29/2022

Note: West Basin

Photo 157-1 Caption:
W13, excavated to clay, looking NE



Photo 158-1

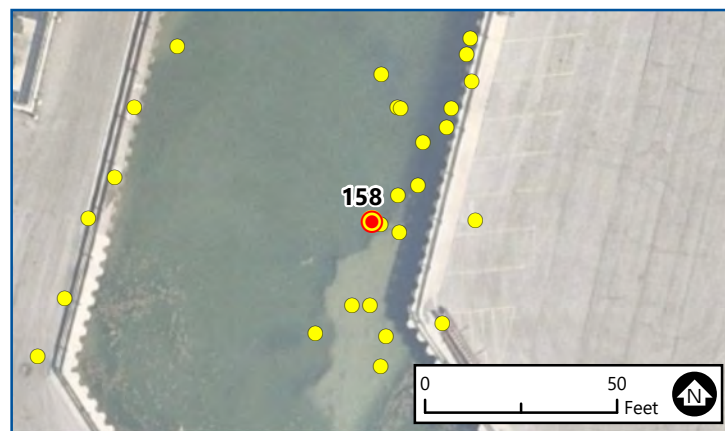
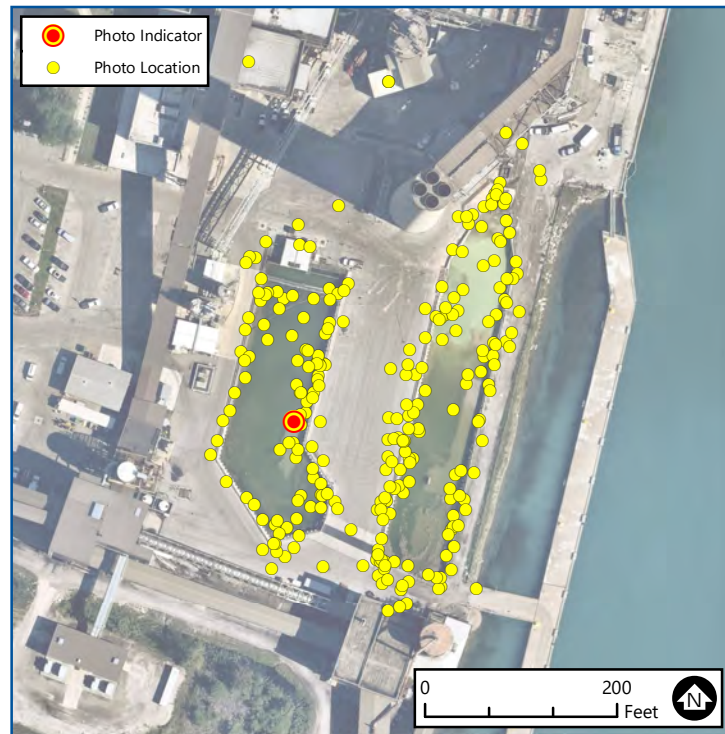

158 of 269
**CONSTRUCTION
MONITORING**
PHOTO LOCATIONS
St. Clair Power Plant
DTE Energy
East China, Michigan

Date: 12/30/2022

Note: West Basin

Photo 158-1 Caption:
W14, excavated to clay, looking west

Aerial Image: NearMap (8/10/2022)
NOTE: Photo locations are approximate.

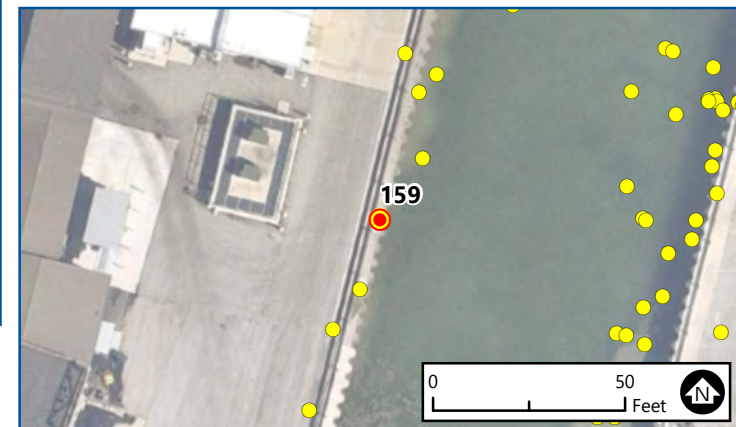

159 of 269
**CONSTRUCTION
MONITORING**
PHOTO LOCATIONS
St. Clair Power Plant
DTE Energy
East China, Michigan

Aerial Image: NearMap (8/10/2022)
NOTE: Photo locations are approximate.

Date: 12/30/2022

Note: West Basin

Photo 159-1 Caption:
W15, excavated to clay, looking east

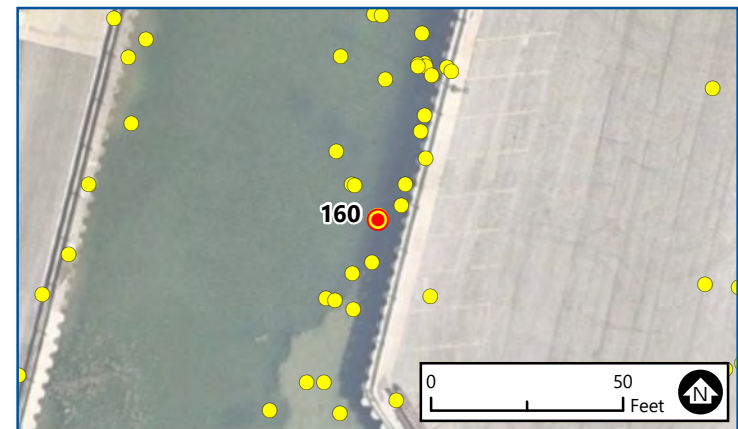

160 of 269
**CONSTRUCTION
MONITORING**
PHOTO LOCATIONS
St. Clair Power Plant
DTE Energy
East China, Michigan

Date: 12/30/2022

Note: West Basin

Photo 160-1 Caption:
W15, excavated to clay, looking west

Aerial Image: NearMap (8/10/2022)
NOTE: Photo locations are approximate.

Photo 161-1

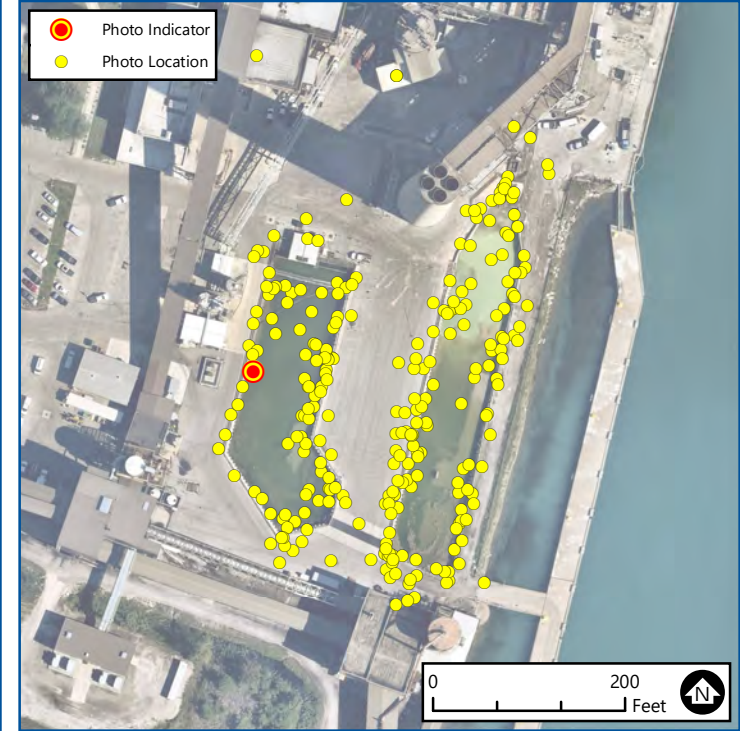
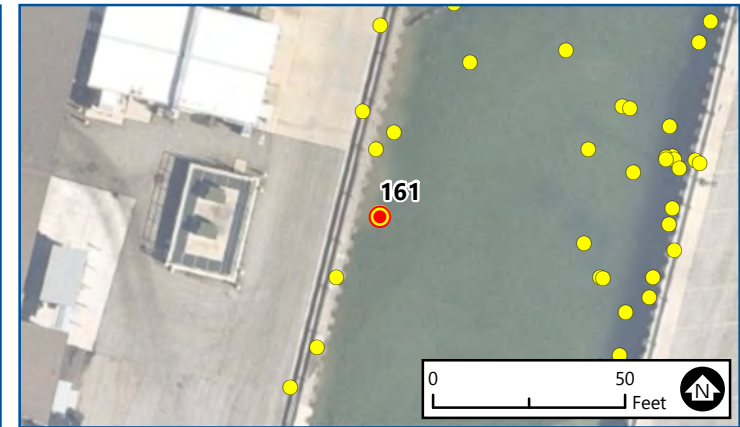

Photo 161-2



161 of 269
**CONSTRUCTION
MONITORING**
PHOTO LOCATIONS
St. Clair Power Plant
DTE Energy
East China, Michigan

Aerial Image: NearMap (8/10/2022)
NOTE: Photo locations are approximate.

Date: 12/30/2022
Note: General Site Photo

Photo 161-1 Caption:
West basin, excavating CCR and
stockpiling for removal

Photo 161-2 Caption:
CCR removal from West basin for
hauling to landfill

Photo 162-1



Photo 162-2

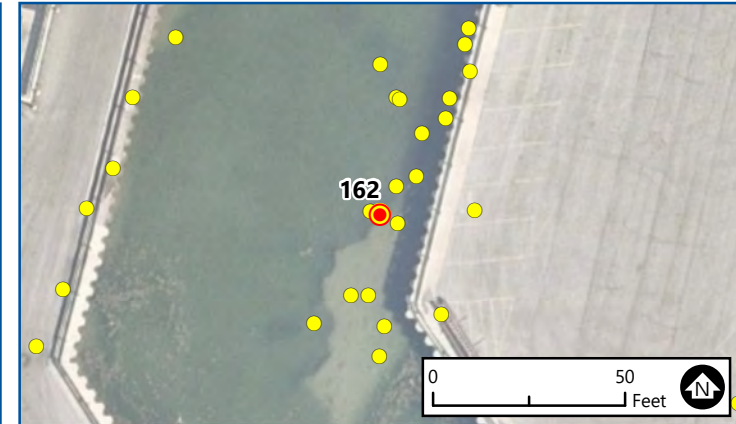

162 of 269
**CONSTRUCTION
MONITORING**
PHOTO LOCATIONS
St. Clair Power Plant
DTE Energy
East China, Michigan

Aerial Image: NearMap (8/10/2022)
NOTE: Photo locations are approximate.

Date: 12/30/2022

Note: West Basin

Photo 162-1 Caption:
W16, excavated to clay, looking west

Photo 162-2 Caption:
W16, excavated to clay, looking west

Photo 163-1

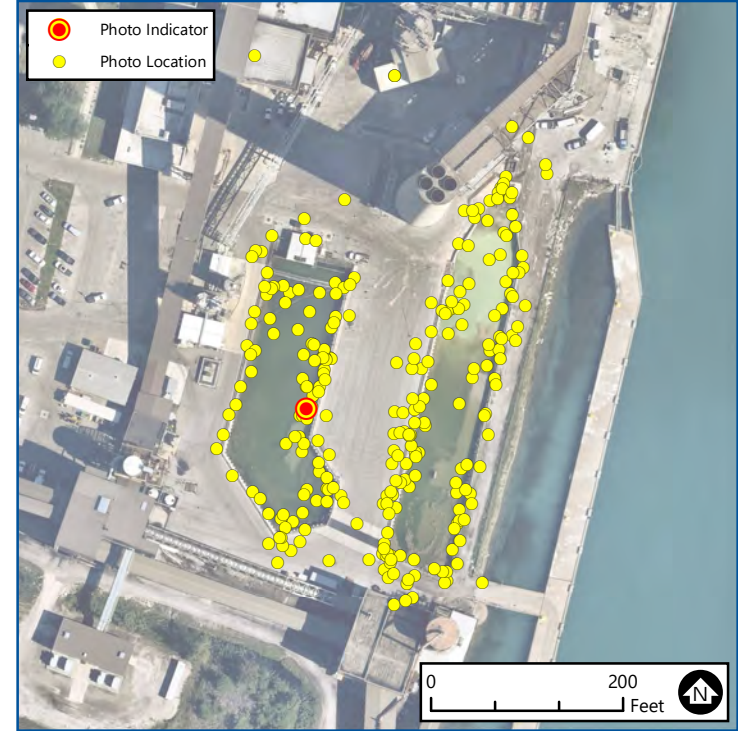
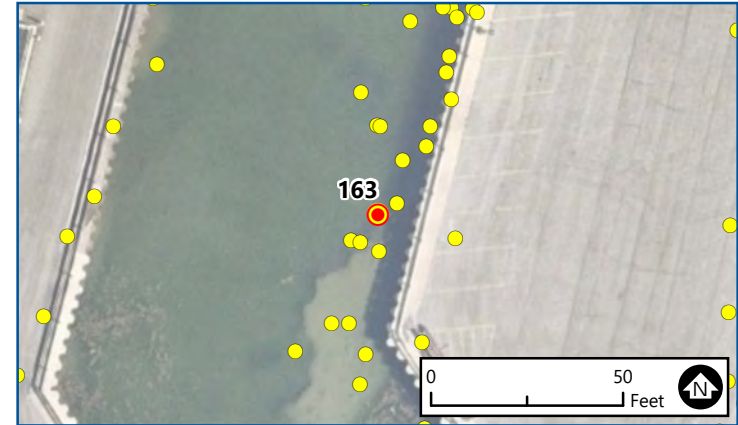

Photo 163-2



163 of 269
**CONSTRUCTION
MONITORING**
PHOTO LOCATIONS
St. Clair Power Plant
DTE Energy
East China, Michigan

Aerial Image: NearMap (8/10/2022)
NOTE: Photo locations are approximate.

Date: 1/5/2023
Note: West Basin

Photo 163-1 Caption:
W17, excavated to clay, looking west

Photo 163-2 Caption:
W17, excavated to clay, looking west

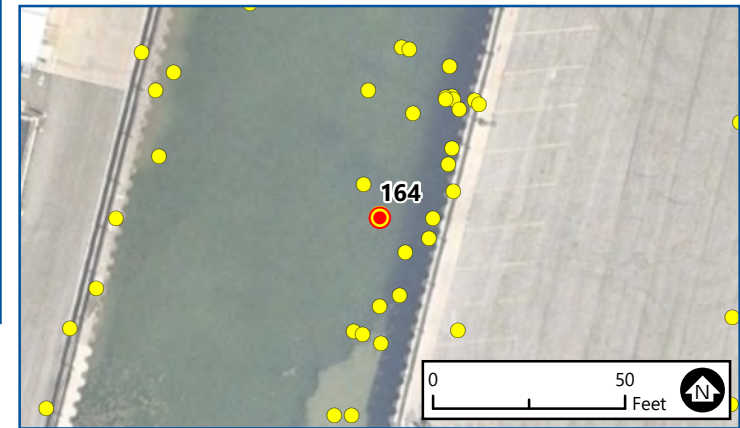

164 of 269
**CONSTRUCTION
MONITORING**
PHOTO LOCATIONS
St. Clair Power Plant
DTE Energy
East China, Michigan

Date: 1/5/2023
Note: West Basin

Photo 164-1 Caption:
W18, excavated to clay, looking west

Aerial Image: NearMap (8/10/2022)
NOTE: Photo locations are approximate.

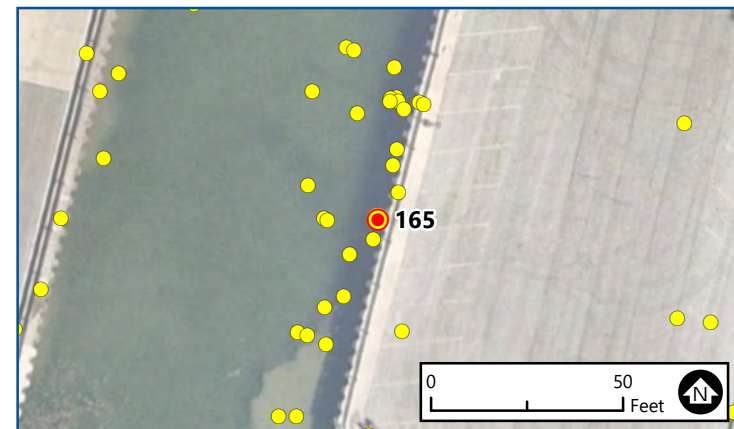

165 of 269
**CONSTRUCTION
MONITORING**
PHOTO LOCATIONS
St. Clair Power Plant
DTE Energy
East China, Michigan

Date: 1/5/2023
Note: West Basin

Photo 165-1 Caption:
W18, excavated to clay, looking SW

Aerial Image: NearMap (8/10/2022)
NOTE: Photo locations are approximate.

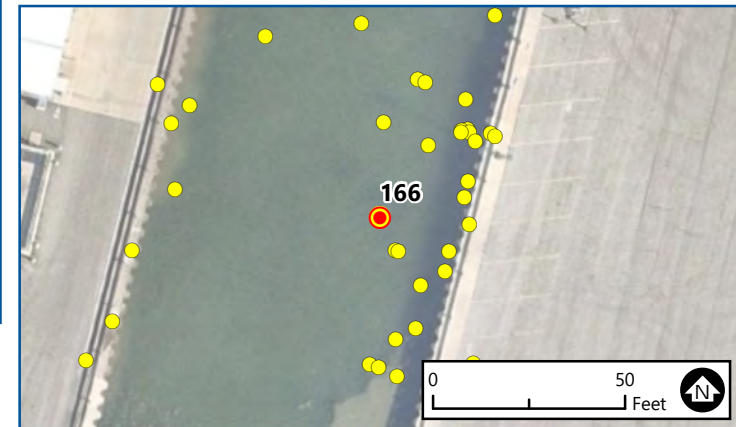

166 of 269
**CONSTRUCTION
MONITORING**
PHOTO LOCATIONS
St. Clair Power Plant
DTE Energy
East China, Michigan

Date: 1/5/2023
Note: West Basin

Photo 166-1 Caption:
W19, excavated to clay, looking west

Aerial Image: NearMap (8/10/2022)
NOTE: Photo locations are approximate.

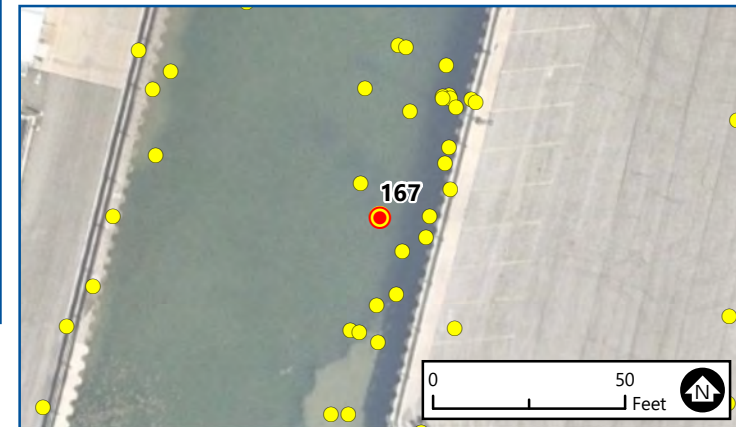

167 of 269
**CONSTRUCTION
MONITORING**
PHOTO LOCATIONS
St. Clair Power Plant
DTE Energy
East China, Michigan

Date: 1/5/2023
Note: West Basin

Photo 167-1 Caption:
W20, excavated to clay, looking west

Aerial Image: NearMap (8/10/2022)
NOTE: Photo locations are approximate.



Photo 168-1

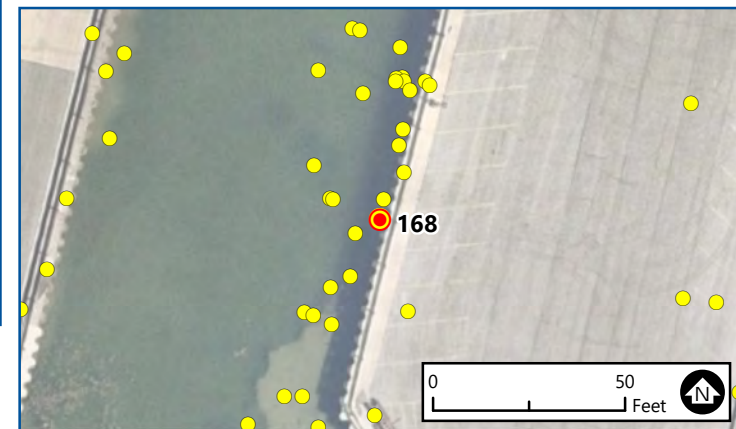

168 of 269
**CONSTRUCTION
MONITORING**
PHOTO LOCATIONS
St. Clair Power Plant
DTE Energy
East China, Michigan

Date: 1/5/2023
Note: West Basin

Photo 168-1 Caption:
W21, excavated to clay, looking NW

Aerial Image: NearMap (8/10/2022)
NOTE: Photo locations are approximate.

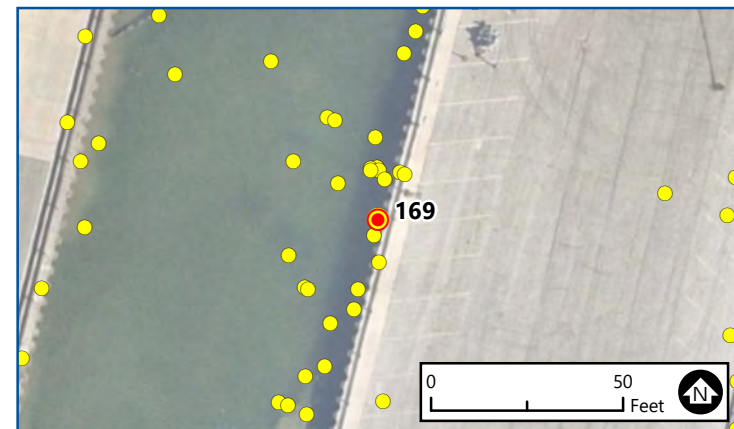

169 of 269
**CONSTRUCTION
MONITORING**
PHOTO LOCATIONS
St. Clair Power Plant
DTE Energy
East China, Michigan

Date: 1/5/2023
Note: West Basin

Photo 169-1 Caption:
W21, excavated to clay, looking west

Aerial Image: NearMap (8/10/2022)
NOTE: Photo locations are approximate.

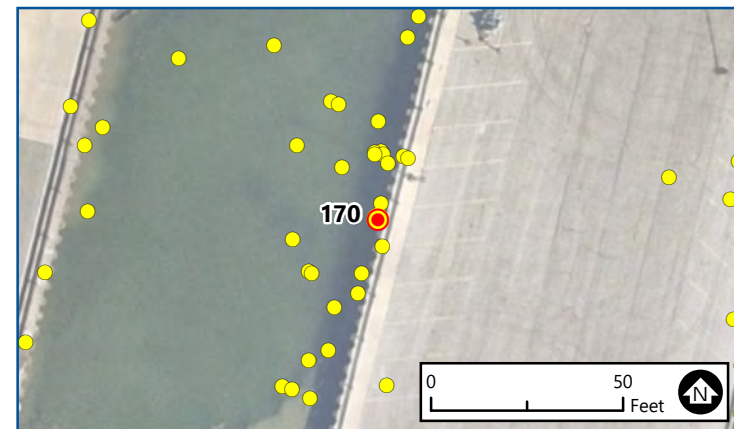

170 of 269
**CONSTRUCTION
MONITORING**
PHOTO LOCATIONS
St. Clair Power Plant
DTE Energy
East China, Michigan

Aerial Image: NearMap (8/10/2022)
NOTE: Photo locations are approximate.

Date: 1/6/2023
Note: West Basin

Photo 170-1 Caption:
W22, excavated to clay, looking west



Photo 171-1

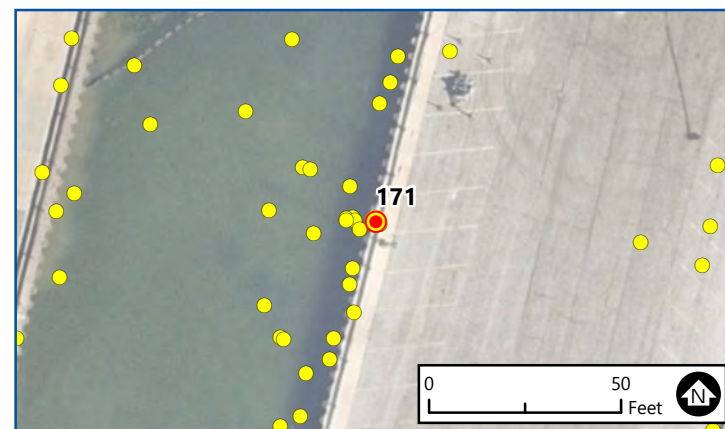
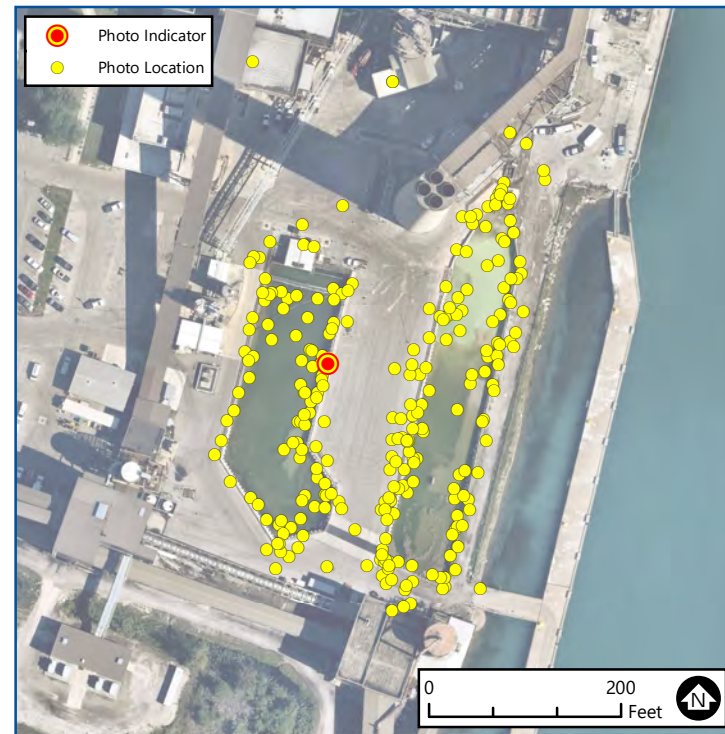

171 of 269
**CONSTRUCTION
MONITORING**
PHOTO LOCATIONS
St. Clair Power Plant
DTE Energy
East China, Michigan

Date: 1/6/2023
Note: West Basin

Photo 171-1 Caption:
W23, excavated to clay, looking west

Aerial Image: NearMap (8/10/2022)
NOTE: Photo locations are approximate.



Photo 172-1

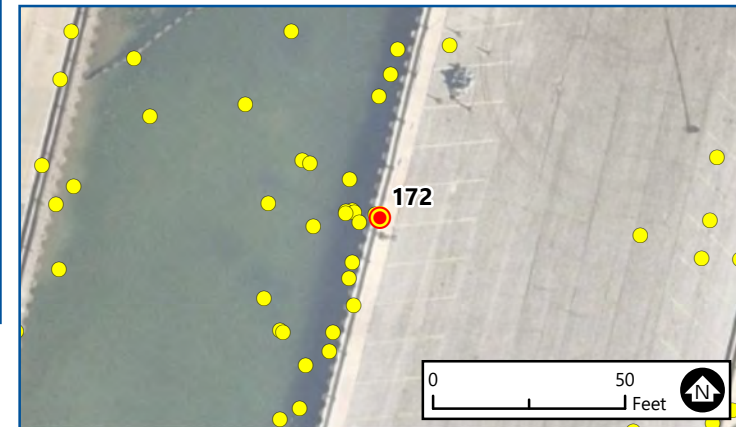

172 of 269
**CONSTRUCTION
MONITORING**
PHOTO LOCATIONS
St. Clair Power Plant
DTE Energy
East China, Michigan

Date: 1/6/2023
Note: West Basin

Photo 172-1 Caption:
W23, excavated to clay, looking west

Aerial Image: NearMap (8/10/2022)
NOTE: Photo locations are approximate.

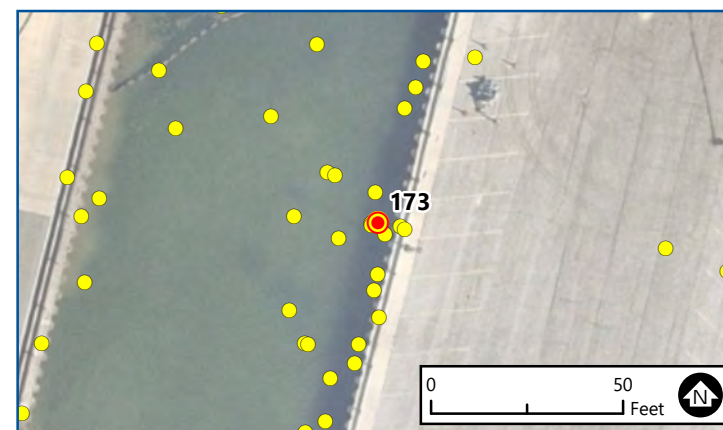
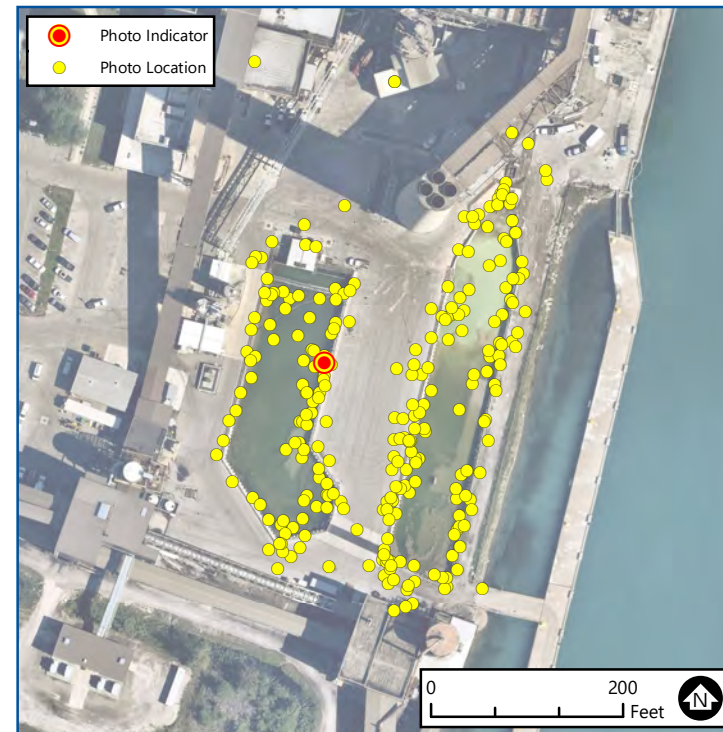

173 of 269
**CONSTRUCTION
MONITORING**
PHOTO LOCATIONS
St. Clair Power Plant
DTE Energy
East China, Michigan

Aerial Image: NearMap (8/10/2022)
NOTE: Photo locations are approximate.

Date: 1/6/2023
Note: West Basin

Photo 173-1 Caption:
W24, excavated to clay, looking NW



Photo 174-1

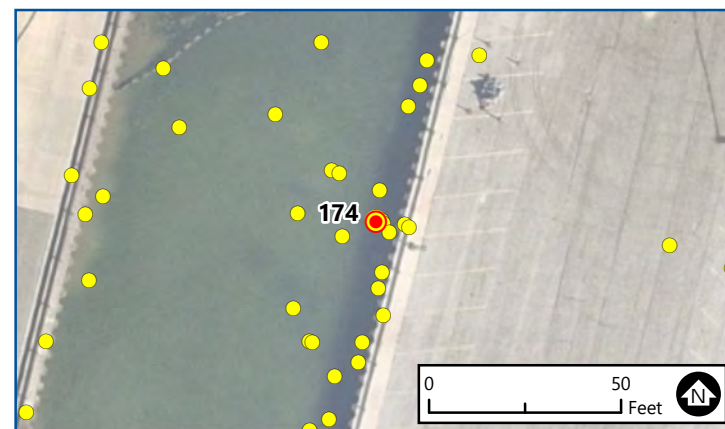
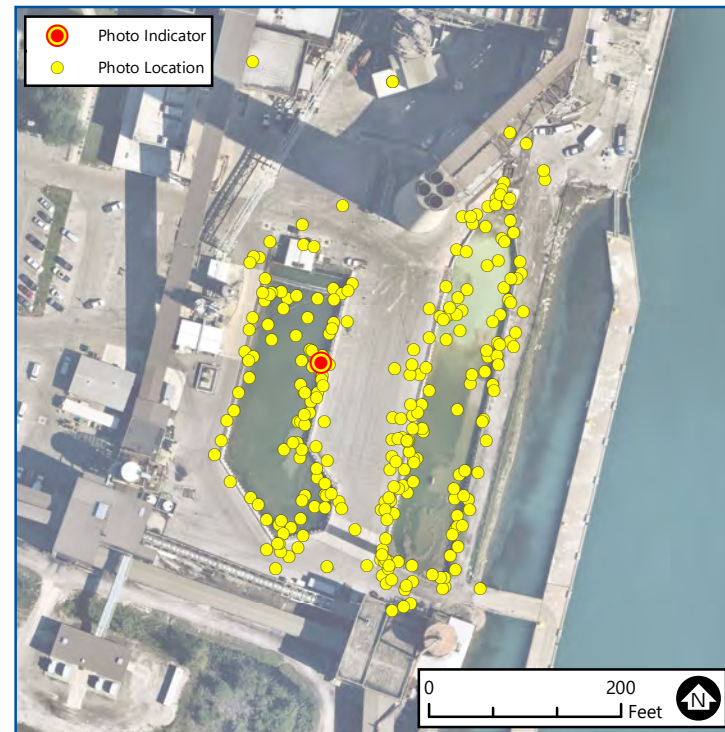

174 of 269
**CONSTRUCTION
MONITORING**
PHOTO LOCATIONS
St. Clair Power Plant
DTE Energy
East China, Michigan

Date: 1/6/2023
Note: West Basin

Photo 174-1 Caption:
W24, excavated to clay, looking west

Aerial Image: NearMap (8/10/2022)
NOTE: Photo locations are approximate.



Photo 175-1

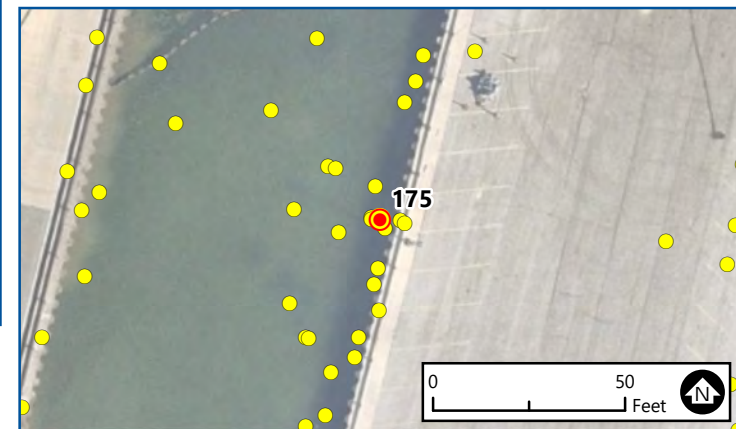

175 of 269
**CONSTRUCTION
MONITORING**
PHOTO LOCATIONS
St. Clair Power Plant
DTE Energy
East China, Michigan

Date: 1/6/2023
Note: West Basin

Photo 175-1 Caption:
W25, excavated to clay, looking west

Aerial Image: NearMap (8/10/2022)
NOTE: Photo locations are approximate.



Photo 176-1

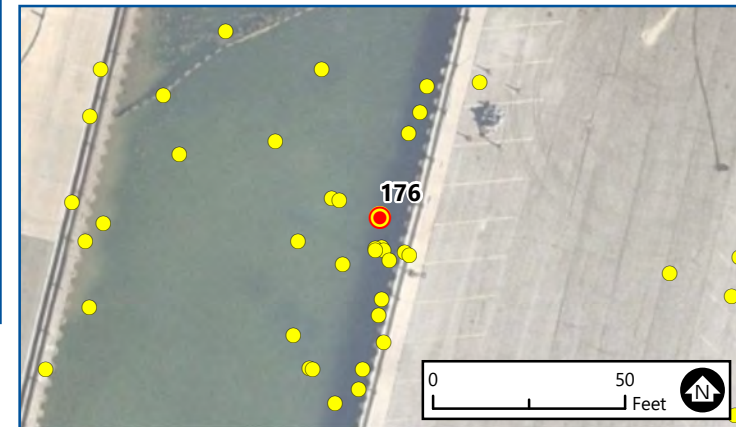

176 of 269
**CONSTRUCTION
MONITORING**
PHOTO LOCATIONS
St. Clair Power Plant
DTE Energy
East China, Michigan

Date: 1/6/2023
Note: West Basin

Photo 176-1 Caption:
W25, excavated to clay, looking west

Aerial Image: NearMap (8/10/2022)
NOTE: Photo locations are approximate.



Photo 177-1

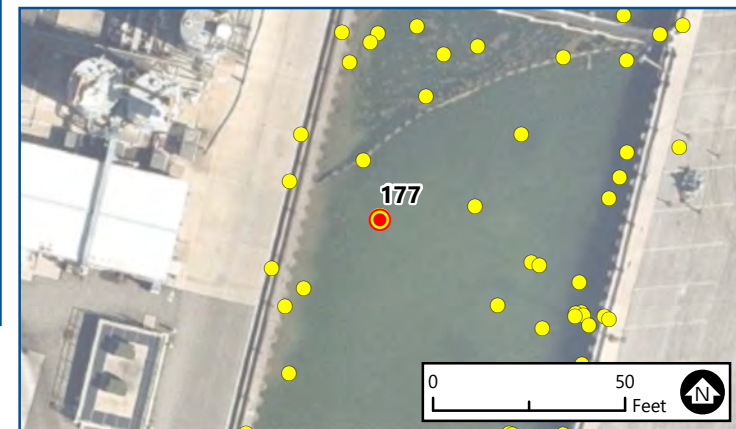

177 of 269
**CONSTRUCTION
MONITORING**
PHOTO LOCATIONS
St. Clair Power Plant
DTE Energy
East China, Michigan

Aerial Image: NearMap (8/10/2022)
NOTE: Photo locations are approximate.

Date: 1/6/2023
Note: West Basin

Photo 177-1 Caption:
W26, excavating to clay, view of the
sheet pile

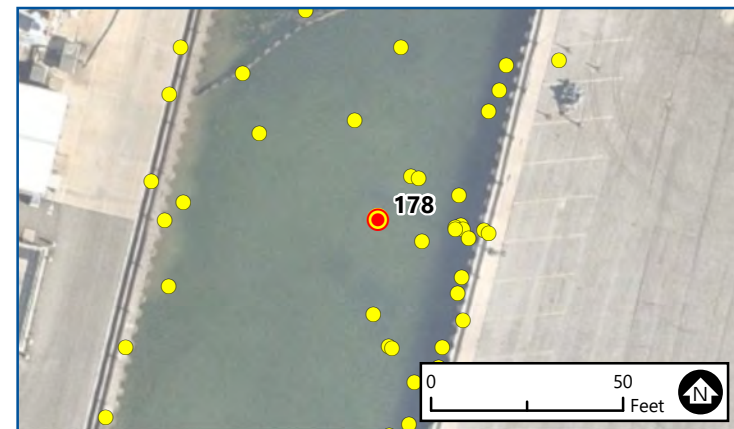

178 of 269
**CONSTRUCTION
MONITORING**
PHOTO LOCATIONS
St. Clair Power Plant
DTE Energy
East China, Michigan

Aerial Image: NearMap (8/10/2022)
NOTE: Photo locations are approximate.

Date: 1/6/2023
Note: West Basin

Photo 178-1 Caption:
W26, excavated to clay, looking NW

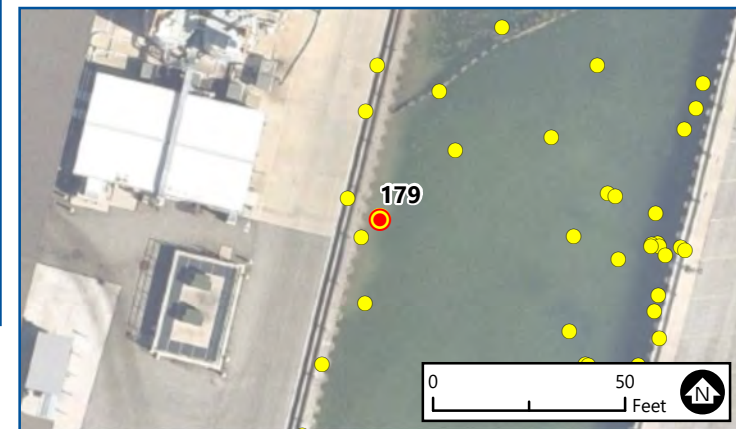

179 of 269
**CONSTRUCTION
MONITORING**
PHOTO LOCATIONS
St. Clair Power Plant
DTE Energy
East China, Michigan

Date: 1/6/2023
Note: West Basin

Photo 179-1 Caption:
W27, excavated to clay, looking east

Aerial Image: NearMap (8/10/2022)
NOTE: Photo locations are approximate.

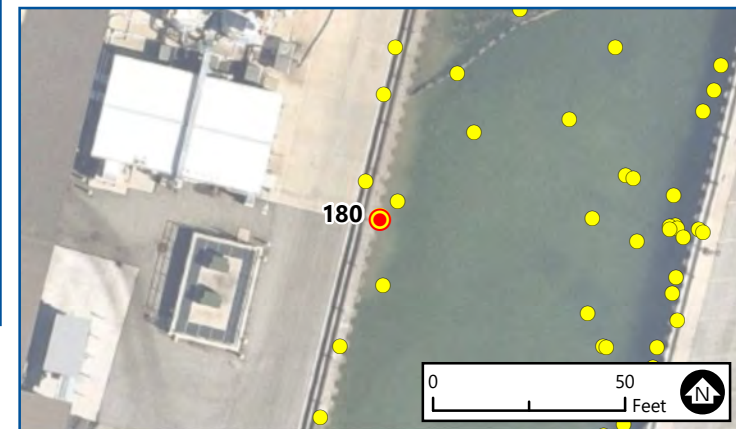

180 of 269
**CONSTRUCTION
MONITORING**
PHOTO LOCATIONS
St. Clair Power Plant
DTE Energy
East China, Michigan

Date: 1/6/2023
Note: West Basin

Photo 180-1 Caption:
W27, excavated to clay, looking east

Aerial Image: NearMap (8/10/2022)
NOTE: Photo locations are approximate.

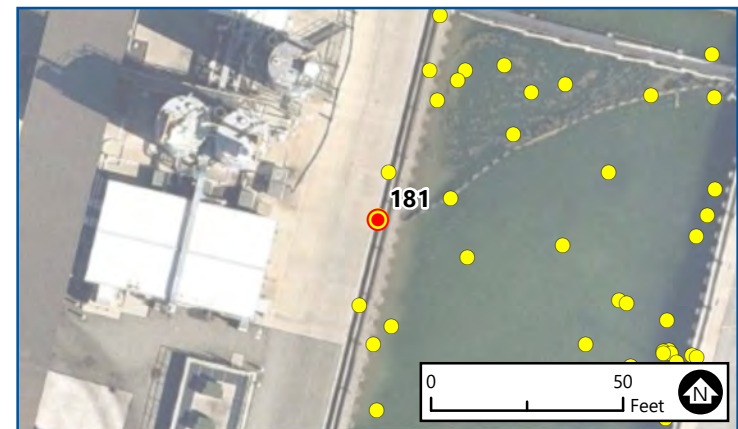
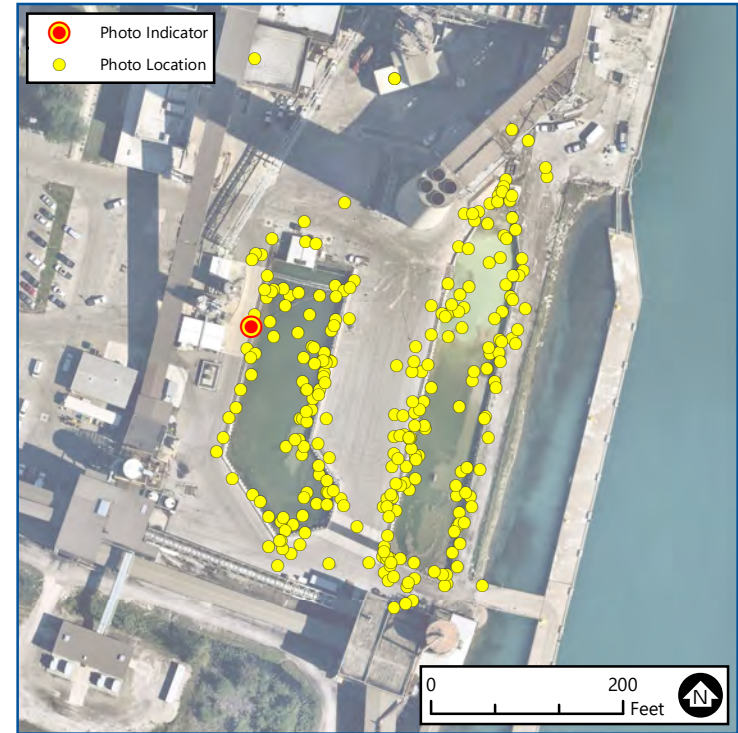

181 of 269
**CONSTRUCTION
MONITORING**
PHOTO LOCATIONS
St. Clair Power Plant
DTE Energy
East China, Michigan

Aerial Image: NearMap (8/10/2022)
NOTE: Photo locations are approximate.

Date: 1/9/2023
Note: West Basin

Photo 181-1 Caption:
W28, excavated to clay, looking east

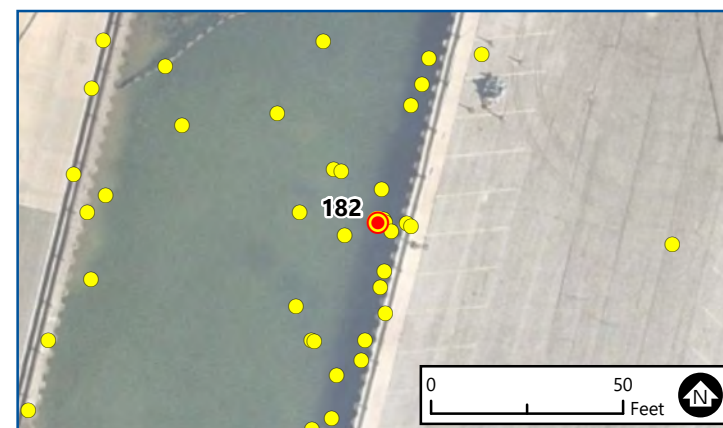

182 of 269
**CONSTRUCTION
MONITORING**
PHOTO LOCATIONS
St. Clair Power Plant
DTE Energy
East China, Michigan

Date: 1/7/2023
Note: West Basin

Photo 182-1 Caption:
W29, excavated to clay, looking west

Aerial Image: NearMap (8/10/2022)
NOTE: Photo locations are approximate.

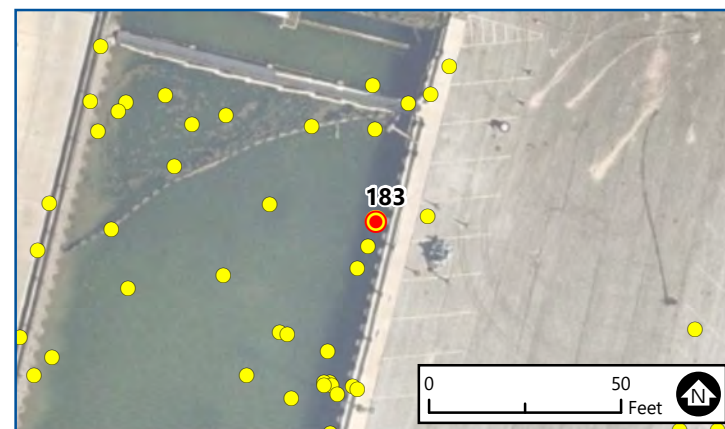
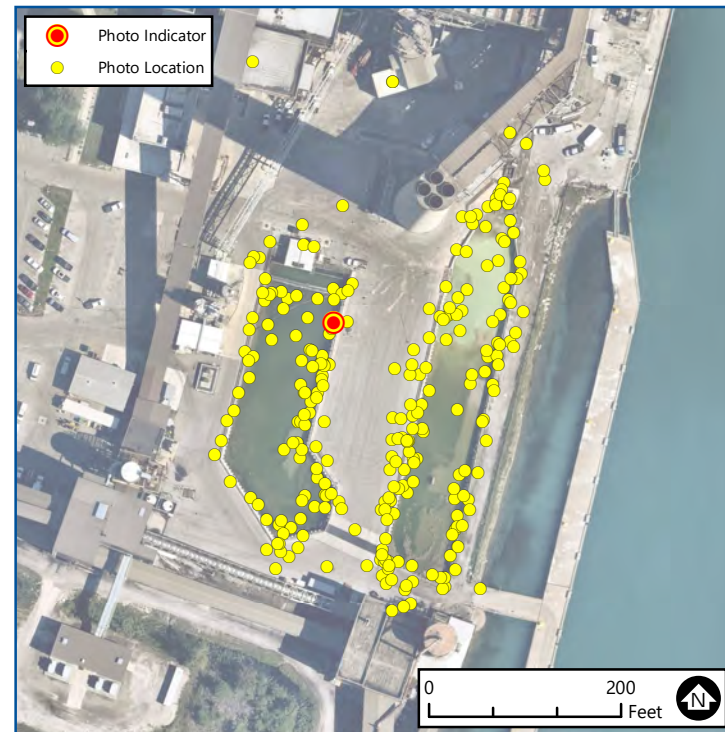

183 of 269
**CONSTRUCTION
MONITORING**
PHOTO LOCATIONS
St. Clair Power Plant
DTE Energy
East China, Michigan

Date: 1/7/2023
Note: West Basin

Photo 183-1 Caption:
W29, excavated to clay, looking west

Aerial Image: NearMap (8/10/2022)
NOTE: Photo locations are approximate.

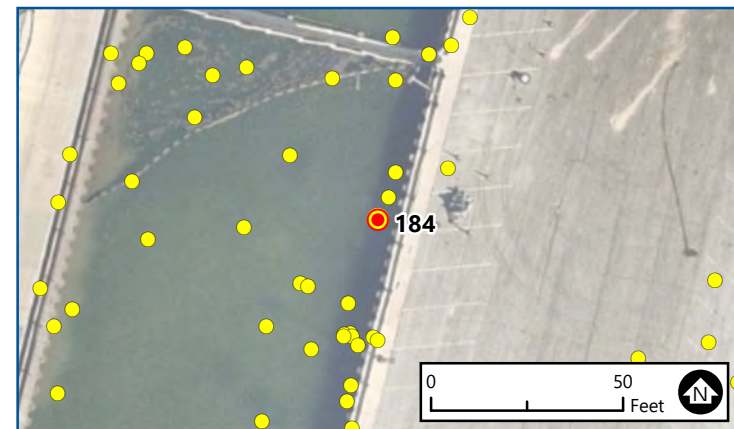

184 of 269
**CONSTRUCTION
MONITORING**
PHOTO LOCATIONS
St. Clair Power Plant
DTE Energy
East China, Michigan

Date: 1/7/2023
Note: West Basin

Photo 184-1 Caption:
W30, partially excavated to clay, looking west

Aerial Image: NearMap (8/10/2022)
NOTE: Photo locations are approximate.

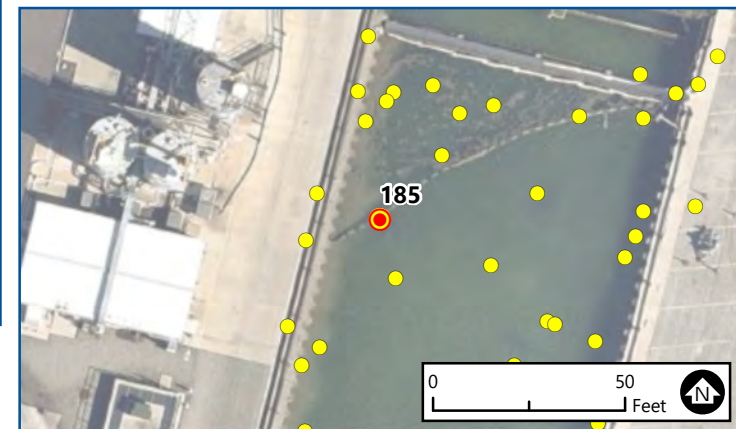
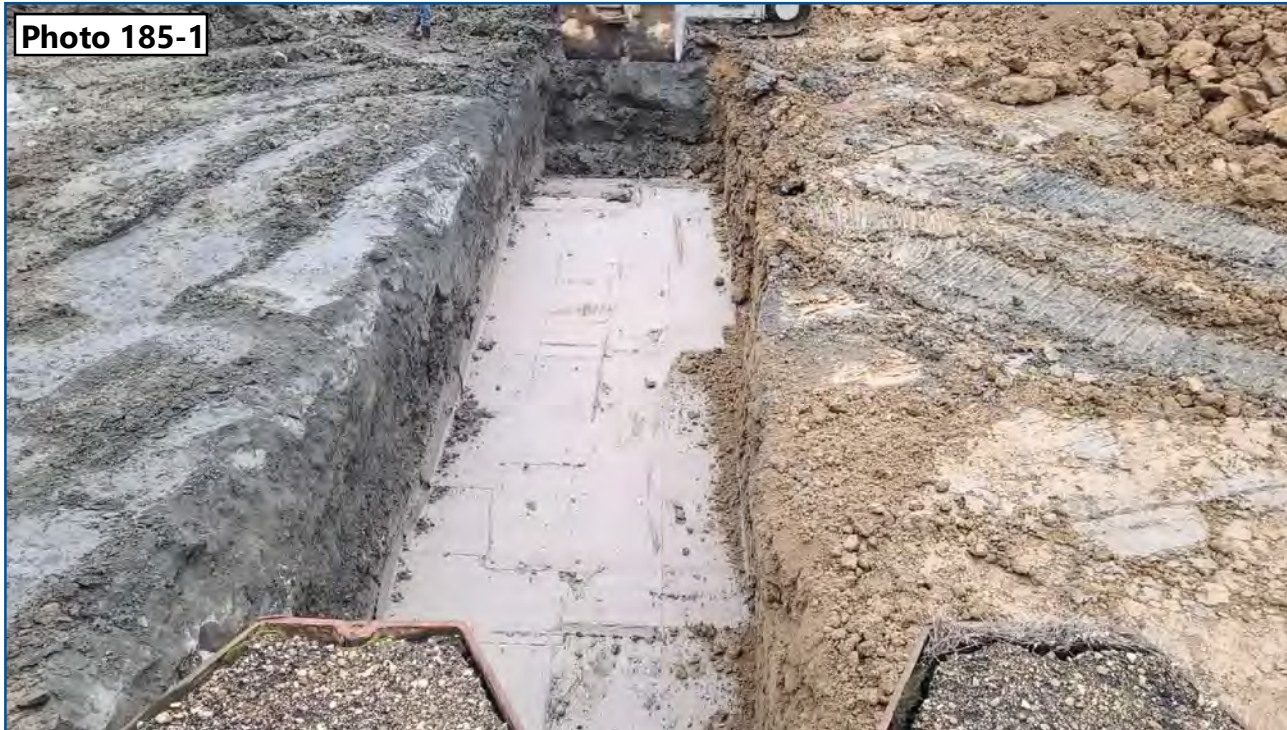

185 of 269
**CONSTRUCTION
MONITORING**
PHOTO LOCATIONS
St. Clair Power Plant
DTE Energy
East China, Michigan

Date: 1/7/2023
Note: West Basin

Photo 185-1 Caption:
W30, excavated to clay, looking east

Aerial Image: NearMap (8/10/2022)
NOTE: Photo locations are approximate.

Photo 186-1

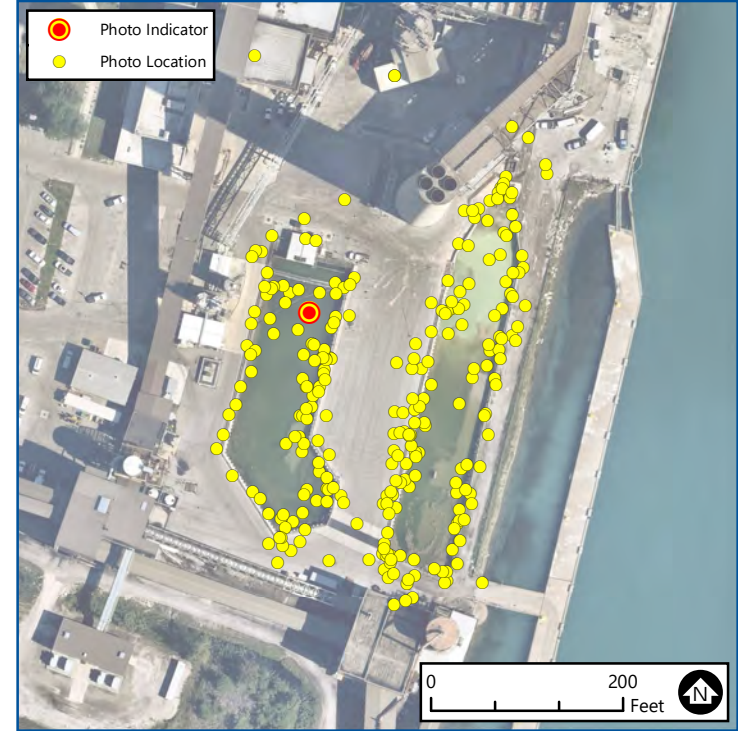
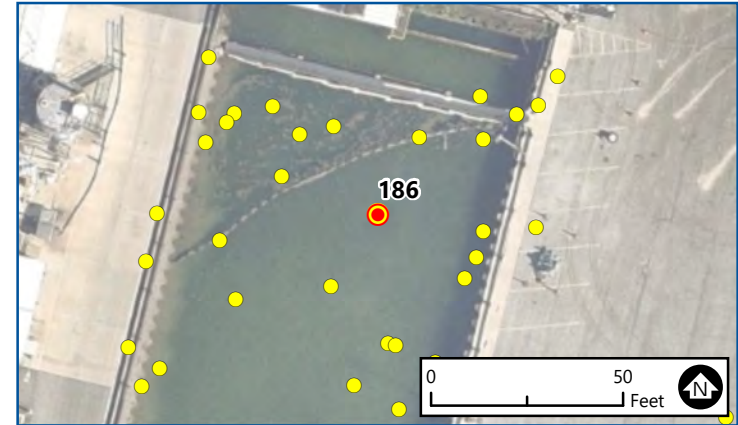

Photo 186-2



186 of 269
**CONSTRUCTION
MONITORING**
PHOTO LOCATIONS
St. Clair Power Plant
DTE Energy
East China, Michigan

Aerial Image: NearMap (8/10/2022)
NOTE: Photo locations are approximate.

Date: 1/7/2023
Note: West Basin

Photo 186-1 Caption:
W31, excavated to clay, looking SW

Photo 186-2 Caption:
W31, excavated to clay, looking NW



Photo 187-1

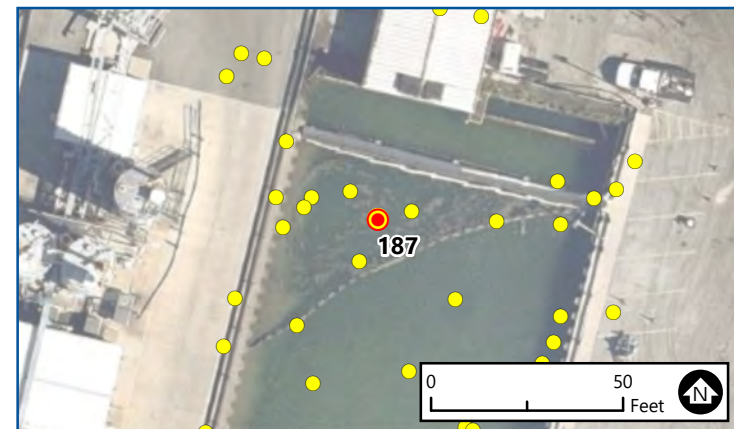

187 of 269
**CONSTRUCTION
MONITORING**
PHOTO LOCATIONS
St. Clair Power Plant
DTE Energy
East China, Michigan

Date: 1/7/2023
Note: West Basin

Photo 187-1 Caption:
W32, excavating to clay, looking east

Aerial Image: NearMap (8/10/2022)
NOTE: Photo locations are approximate.

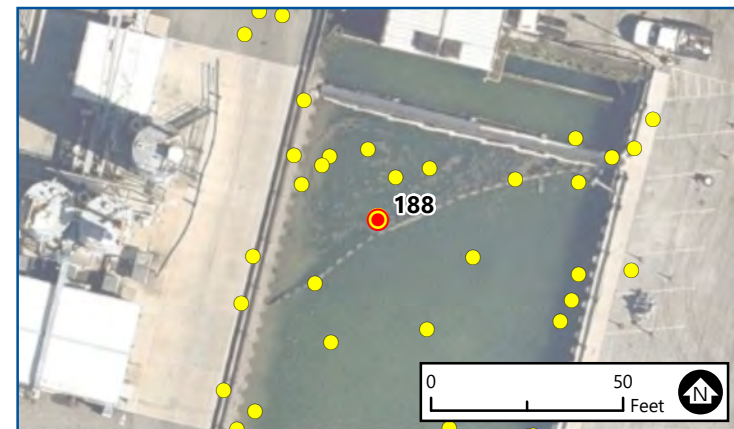

188 of 269
**CONSTRUCTION
MONITORING**
PHOTO LOCATIONS
St. Clair Power Plant
DTE Energy
East China, Michigan

Date: 1/7/2023
Note: West Basin

Photo 188-1 Caption:
W32, excavating to clay, looking NE

Aerial Image: NearMap (8/10/2022)
NOTE: Photo locations are approximate.



189 of 269
**CONSTRUCTION
MONITORING**
PHOTO LOCATIONS
St. Clair Power Plant
DTE Energy
East China, Michigan

Date: 1/9/2023
Note: West Basin

Photo 189-1 Caption:
W33, excavated to clay, looking NE

Aerial Image: NearMap (8/10/2022)
NOTE: Photo locations are approximate.

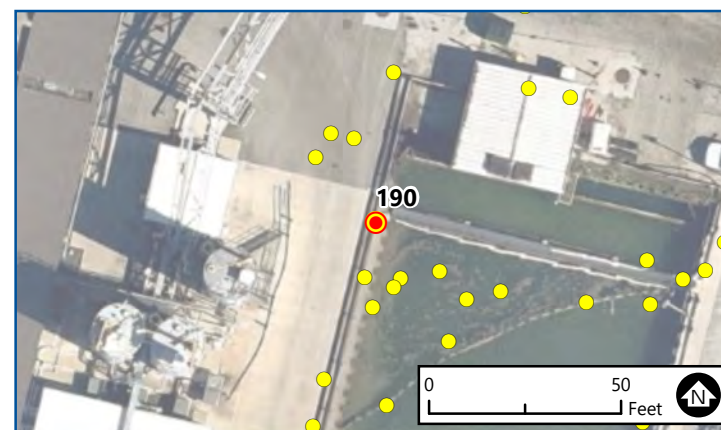

190 of 269
**CONSTRUCTION
MONITORING**
PHOTO LOCATIONS
St. Clair Power Plant
DTE Energy
East China, Michigan

Date: 1/9/2023
Note: West Basin

Photo 190-1 Caption:
W33, excavated to clay, looking SE

Aerial Image: NearMap (8/10/2022)
NOTE: Photo locations are approximate.

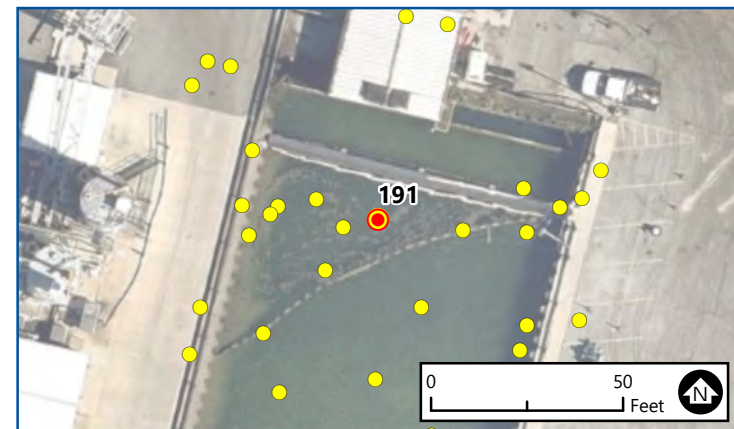
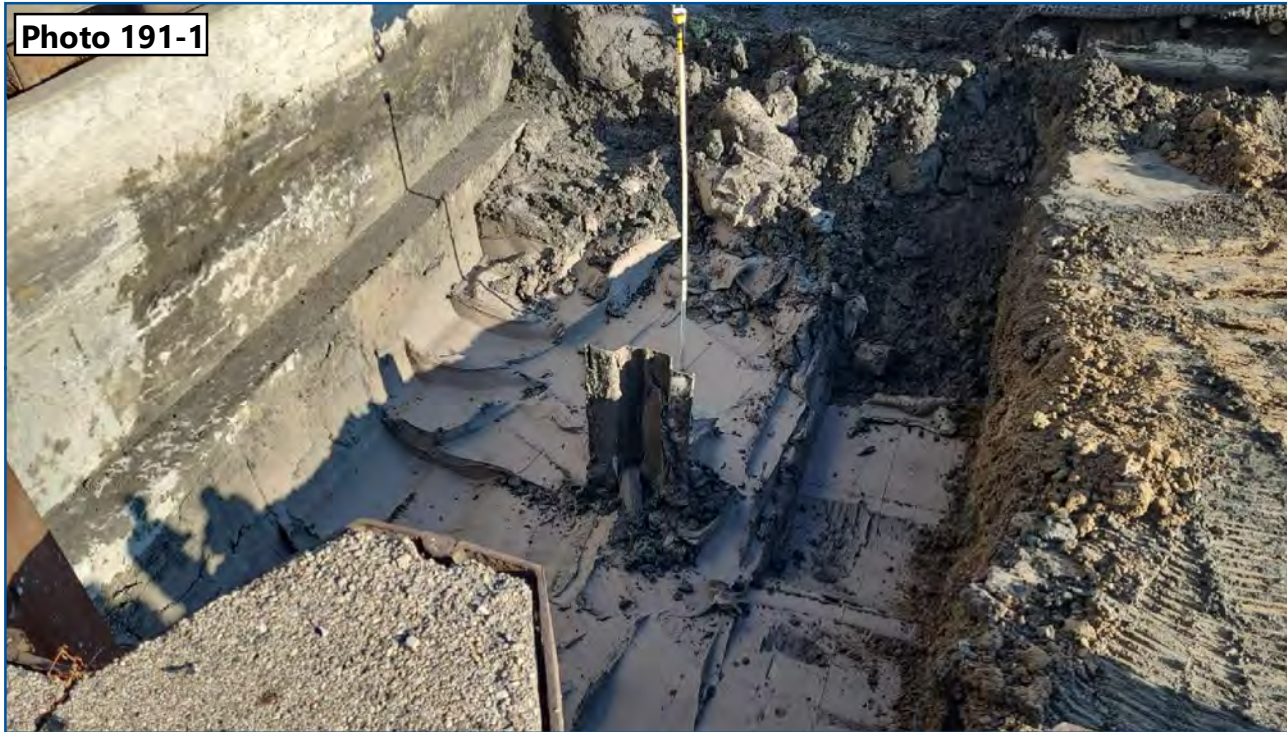

191 of 269
**CONSTRUCTION
MONITORING**
PHOTO LOCATIONS
St. Clair Power Plant
DTE Energy
East China, Michigan

Date: 1/9/2023
Note: West Basin

Photo 191-1 Caption:
W34, excavated to clay, looking east

Aerial Image: NearMap (8/10/2022)
NOTE: Photo locations are approximate.



192 of 269
**CONSTRUCTION
MONITORING**
PHOTO LOCATIONS
St. Clair Power Plant
DTE Energy
East China, Michigan

Date: 1/9/2023
Note: West Basin

Photo 192-1 Caption:
W34, excavated to clay, looking west

Aerial Image: NearMap (8/10/2022)
NOTE: Photo locations are approximate.



Photo 193-1

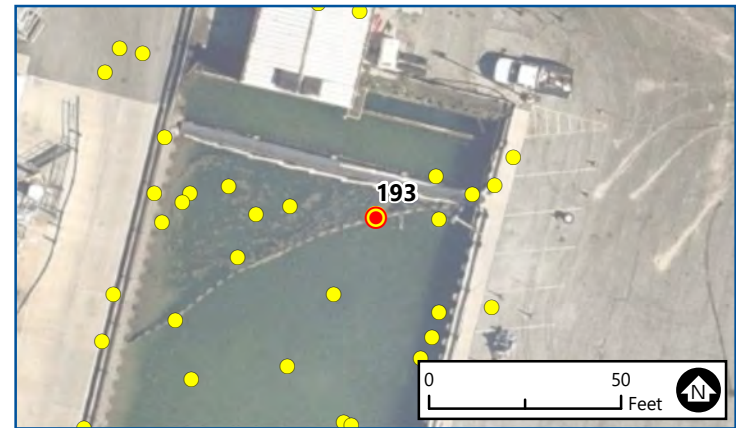

193 of 269
**CONSTRUCTION
MONITORING**
PHOTO LOCATIONS
St. Clair Power Plant
DTE Energy
East China, Michigan

Date: 1/10/2023
Note: West Basin

Photo 193-1 Caption:
W35, excavated to clay, looking west

Aerial Image: NearMap (8/10/2022)
NOTE: Photo locations are approximate.

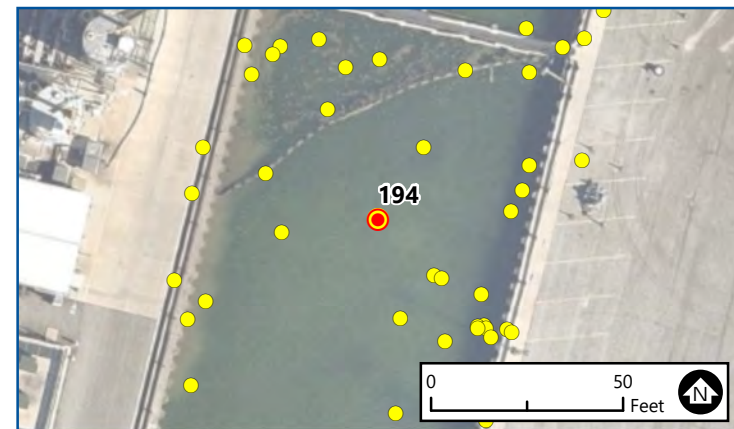

194 of 269
**CONSTRUCTION
MONITORING**
PHOTO LOCATIONS
St. Clair Power Plant
DTE Energy
East China, Michigan

Date: 1/10/2023
Note: West Basin

Photo 194-1 Caption:
W36, excavated to clay, looking west

Aerial Image: NearMap (8/10/2022)
NOTE: Photo locations are approximate.

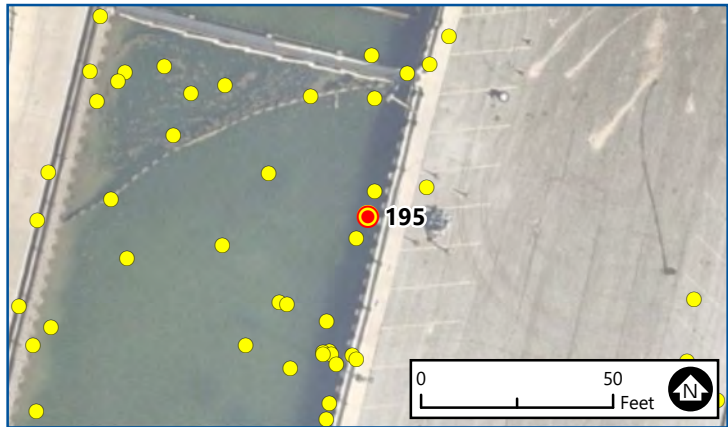
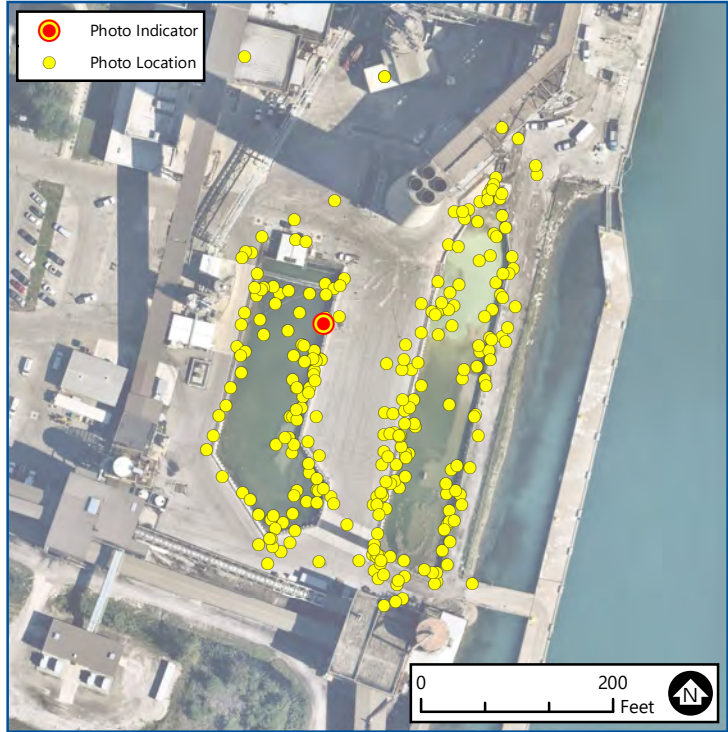

195 of 269
**CONSTRUCTION
MONITORING**
PHOTO LOCATIONS
St. Clair Power Plant
DTE Energy
East China, Michigan

Aerial Image: NearMap (8/10/2022)
NOTE: Photo locations are approximate.

Date: 1/10/2023
Note: West Basin

Photo 195-1 Caption:
W36, excavated to clay, looking SW



Photo 196-1

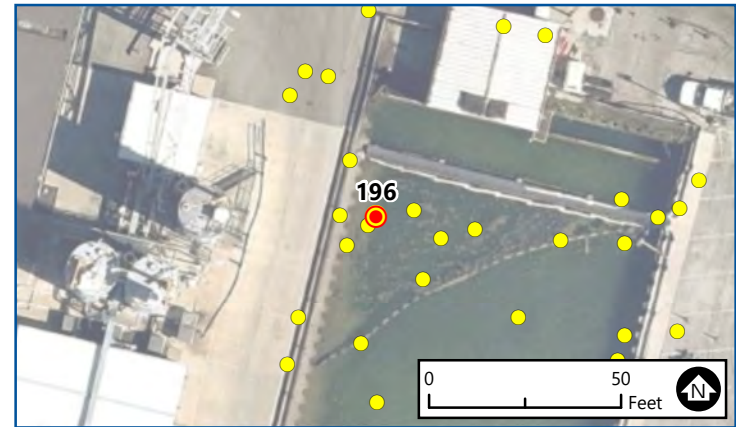
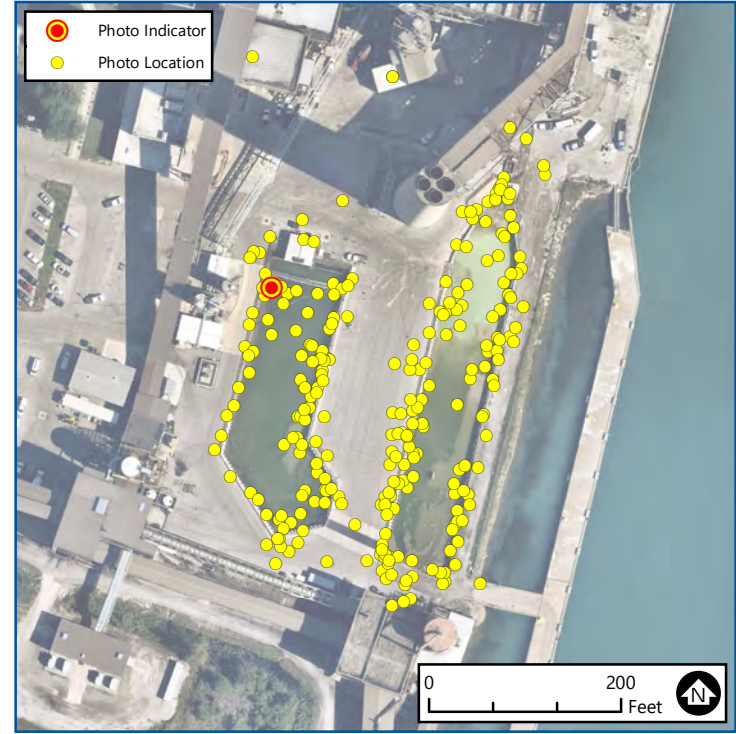

196 of 269
**CONSTRUCTION
MONITORING**
PHOTO LOCATIONS
St. Clair Power Plant
DTE Energy
East China, Michigan

Aerial Image: NearMap (8/10/2022)
NOTE: Photo locations are approximate.

Date: 1/10/2023
Note: CCR Removal Methods

Photo 196-1 Caption:
Removing the remaining CCR from the west basin

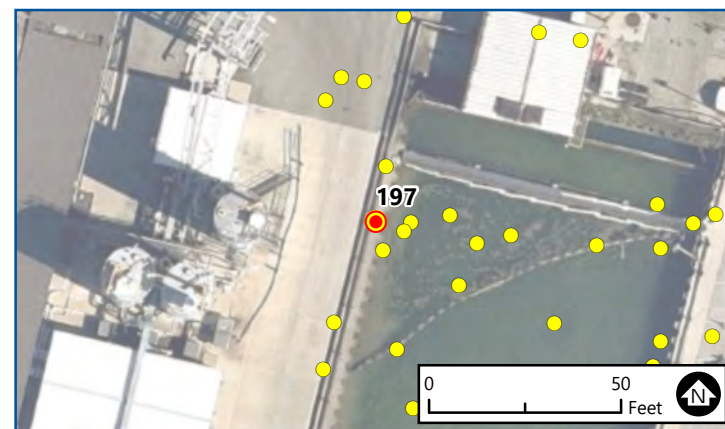
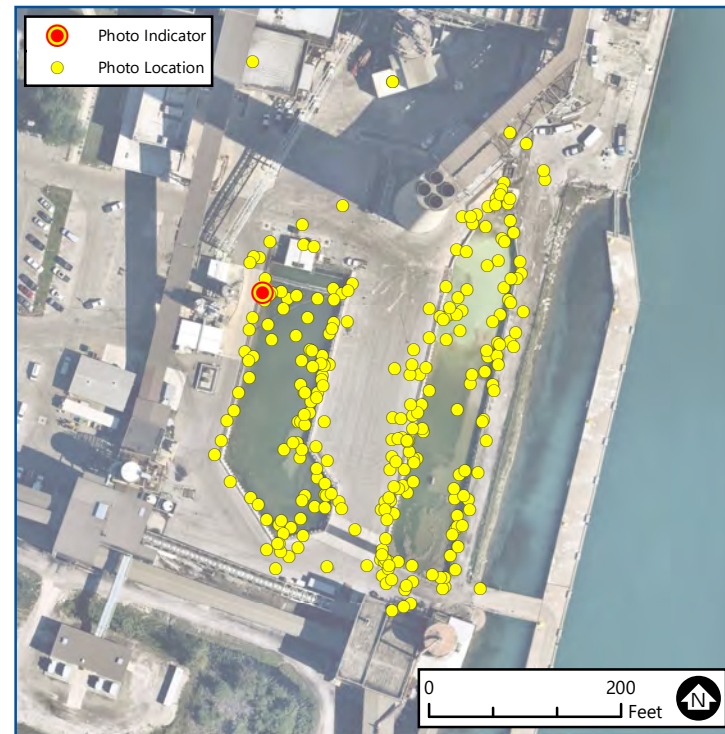

197 of 269
**CONSTRUCTION
MONITORING**
PHOTO LOCATIONS
St. Clair Power Plant
DTE Energy
East China, Michigan

Aerial Image: NearMap (8/10/2022)
NOTE: Photo locations are approximate.

Date: 1/10/2023
Note: CCR Removal Methods

Photo 197-1 Caption:
Removing the remaining CCR from the west basin



Photo 198-1

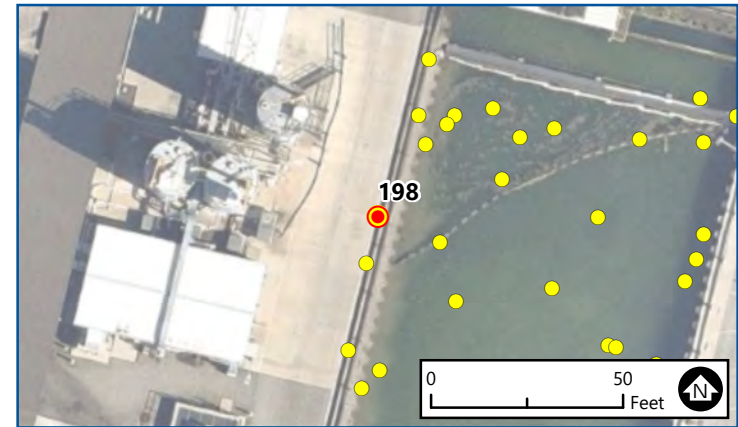

198 of 269
**CONSTRUCTION
MONITORING**
PHOTO LOCATIONS
St. Clair Power Plant
DTE Energy
East China, Michigan

Aerial Image: NearMap (8/10/2022)
NOTE: Photo locations are approximate.

Date: 1/10/2023
Note: CCR Removal Methods

Photo 198-1 Caption:
Removing the remaining CCR from the west basin



Photo 199-1

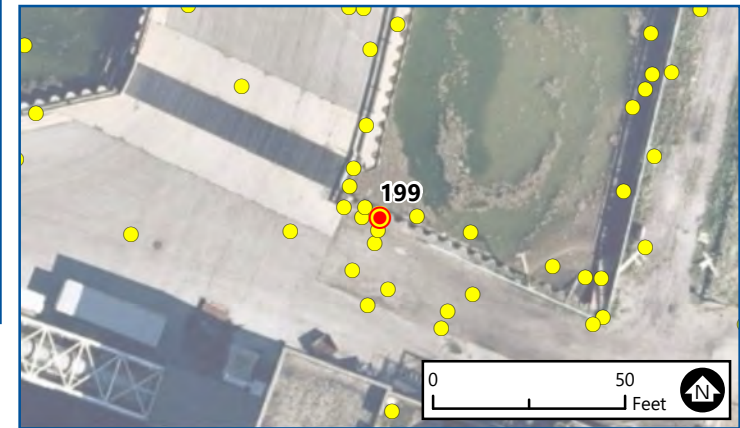

199 of 269
**CONSTRUCTION
MONITORING**
PHOTO LOCATIONS
St. Clair Power Plant
DTE Energy
East China, Michigan

Aerial Image: NearMap (8/10/2022)
NOTE: Photo locations are approximate.

Date: 11/21/2022
Note: CCR Removal Methods

Photo 199-1 Caption:
E1, scraping the sheet pile

Photo 200-1



Photo 200-2

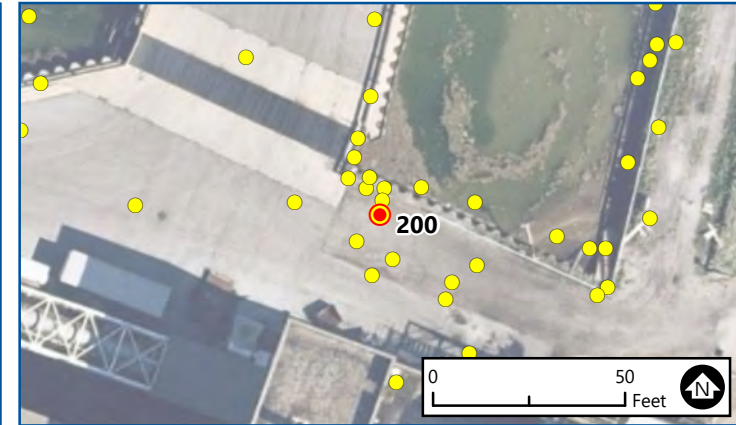

200 of 269
**CONSTRUCTION
MONITORING**
PHOTO LOCATIONS
St. Clair Power Plant
DTE Energy
East China, Michigan

Aerial Image: NearMap (8/10/2022)
NOTE: Photo locations are approximate.

Date: 11/22/2022
Note: CCR Removal Methods

Photo 200-1 Caption:
E2, CCR scraped from top of sheet pile

Photo 200-2 Caption:
E2, CCR scraped from top of sheet pile

Photo 201-1



Photo 201-2

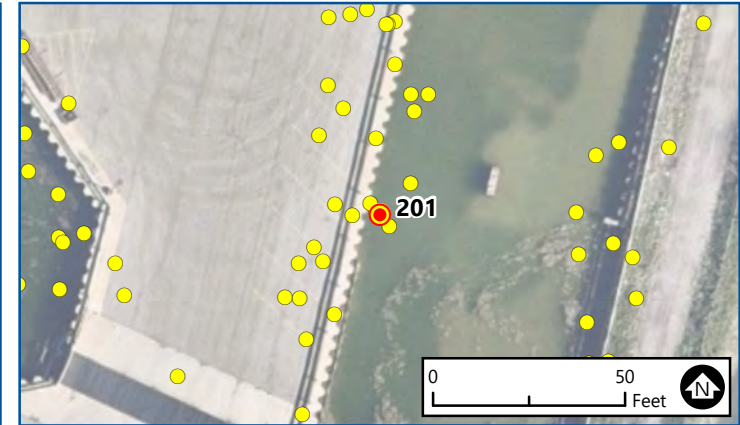

201 of 269
**CONSTRUCTION
MONITORING**
PHOTO LOCATIONS
St. Clair Power Plant
DTE Energy
East China, Michigan

Date: 11/28/2022
Note: CCR Removal Methods

Photo 201-1 Caption:
CCR scraped from cement support structure, looking east

Photo 201-2 Caption:
CCR scraped from cement support structure, looking east

Aerial Image: NearMap (8/10/2022)
NOTE: Photo locations are approximate.

Photo 202-1

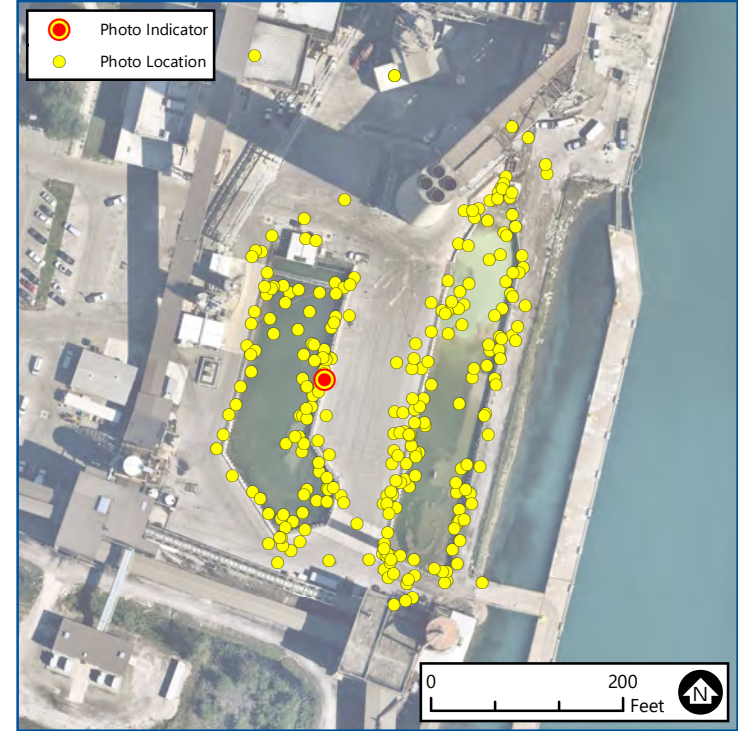
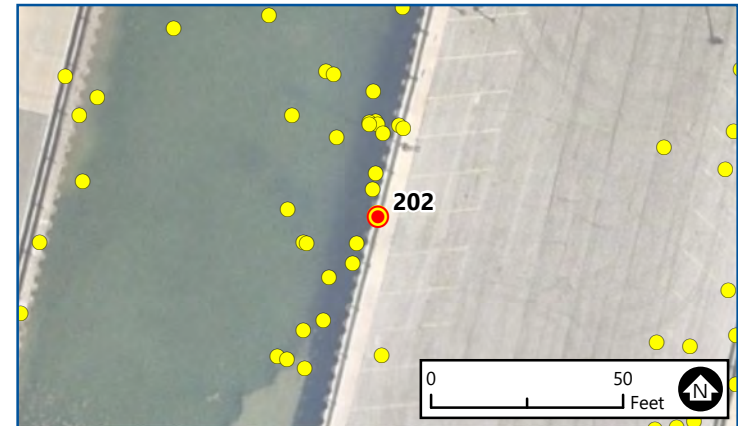

Photo 202-2



202 of 269
**CONSTRUCTION
MONITORING**
PHOTO LOCATIONS
St. Clair Power Plant
DTE Energy
East China, Michigan

Aerial Image: NearMap (8/10/2022)
NOTE: Photo locations are approximate.

Date: 1/6/2023

Note: CCR Removal Methods

Photo 202-1 Caption:
West basin, scraping CCR from sheet pile wall by hand

Photo 202-2 Caption:
West basin, scraping CCR from sheet pile wall by hand

Photo 203-1



Photo 203-2

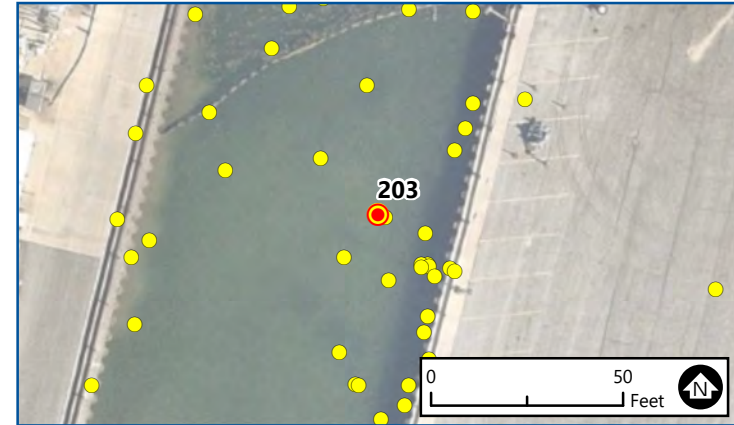

203 of 269
**CONSTRUCTION
MONITORING**
PHOTO LOCATIONS
St. Clair Power Plant
DTE Energy
East China, Michigan

Aerial Image: NearMap (8/10/2022)
NOTE: Photo locations are approximate.

Date: 1/6/2023
Note: CCR Removal Methods

Photo 203-1 Caption:
Digging bucket used to break up CCR mixed with cement

Photo 203-2 Caption:
Digging bucket used to break up CCR mixed with cement



Photo 204-1

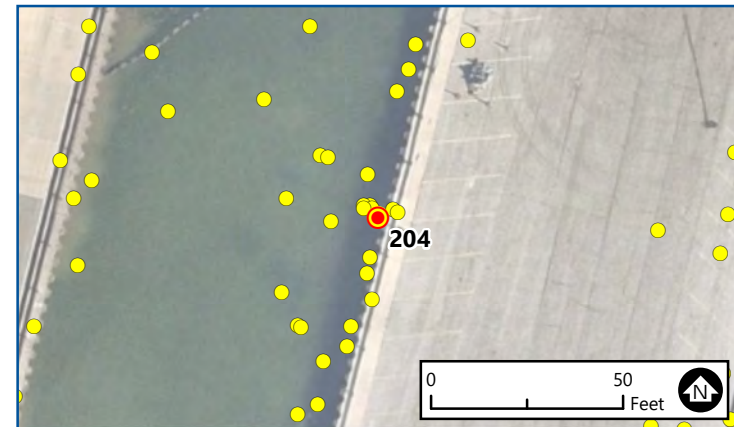

204 of 269
**CONSTRUCTION
MONITORING**
PHOTO LOCATIONS
St. Clair Power Plant
DTE Energy
East China, Michigan

Aerial Image: NearMap (8/10/2022)
NOTE: Photo locations are approximate.

Date: 1/6/2023
Note: CCR Removal Methods

Photo 204-1 Caption:
Scraping CCR from sheet pile wall with
the ditching bucket

Photo 205-1



Photo 205-2

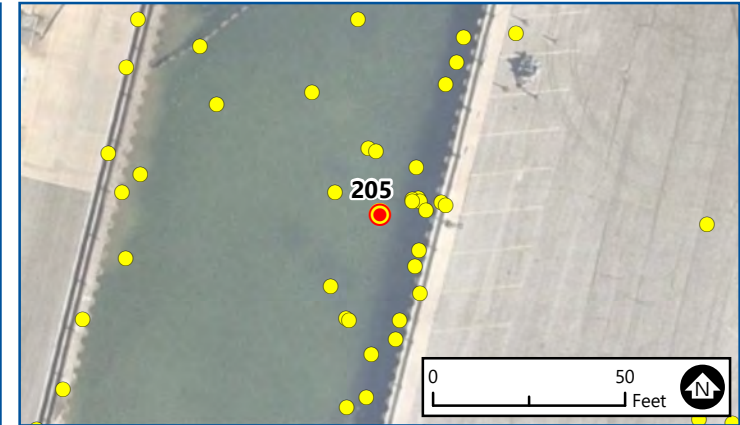

205 of 269
**CONSTRUCTION
MONITORING**
PHOTO LOCATIONS
St. Clair Power Plant
DTE Energy
East China, Michigan

Aerial Image: NearMap (8/10/2022)
NOTE: Photo locations are approximate.

Date: 1/7/2023
Note: CCR Removal Methods

Photo 205-1 Caption:
Scraping CCR from sheet pile wall by hand

Photo 205-2 Caption:
Scraping CCR from sheet pile wall by hand

Photo 206-1



Photo 206-2

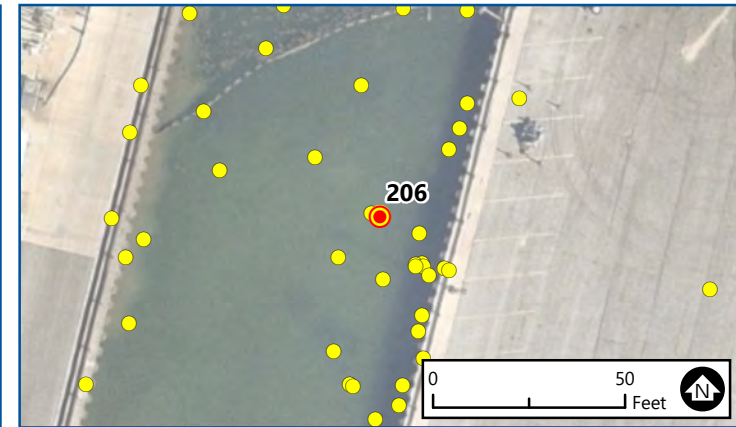
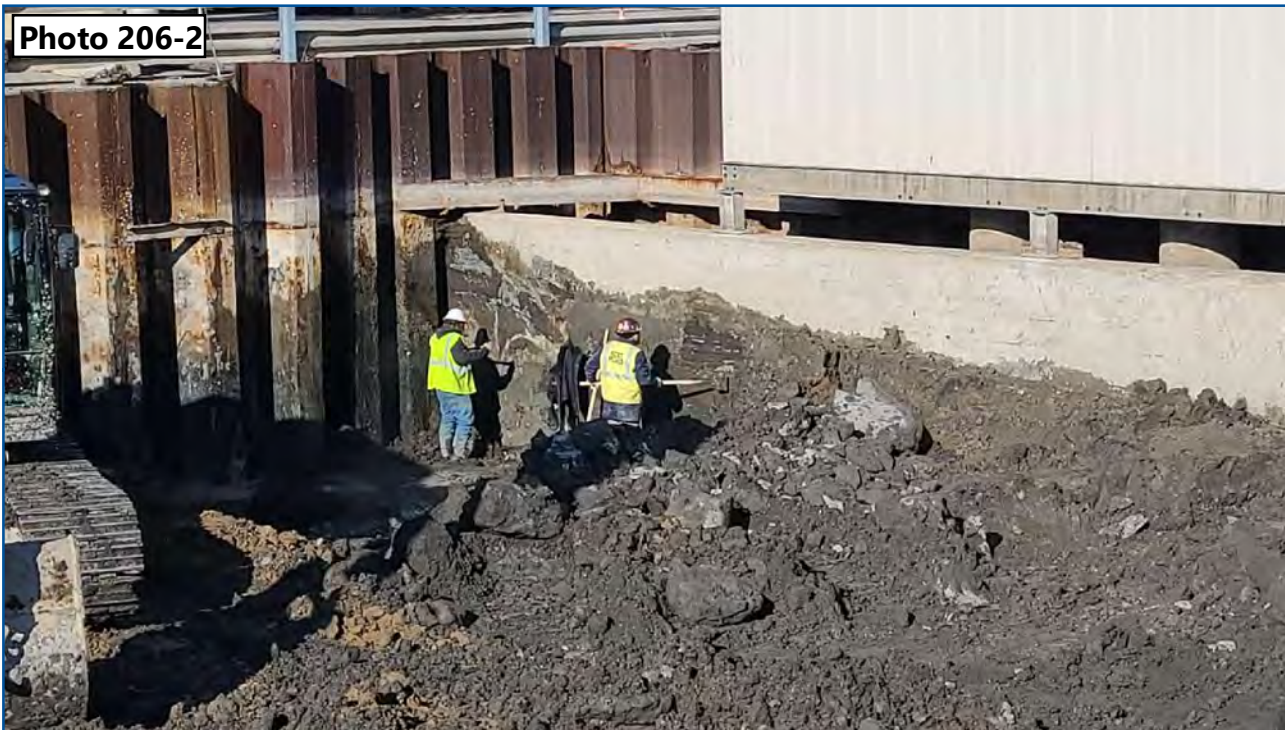

206 of 269
**CONSTRUCTION
MONITORING**
PHOTO LOCATIONS
St. Clair Power Plant
DTE Energy
East China, Michigan

Date: 1/9/2023
Note: CCR Removal Methods

Photo 206-1 Caption:
Scraping CCR from weir wall and NW corner of the sheet pile

Photo 206-2 Caption:
Scraping CCR from weir wall and NW corner of the sheet pile

Aerial Image: NearMap (8/10/2022)
NOTE: Photo locations are approximate.

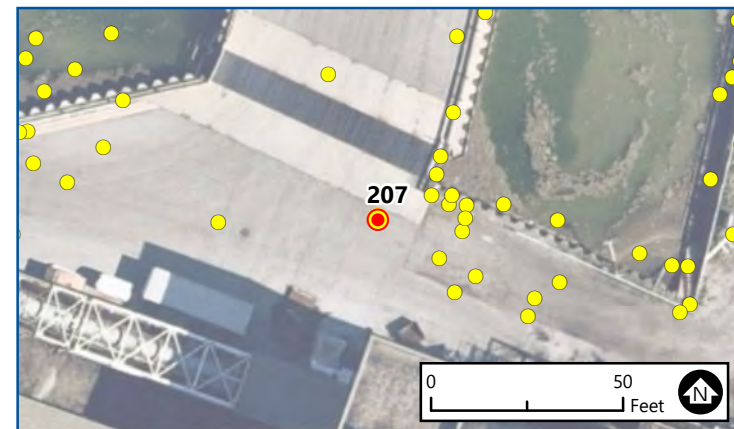

207 of 269
**CONSTRUCTION
MONITORING**
PHOTO LOCATIONS
St. Clair Power Plant
DTE Energy
East China, Michigan

Aerial Image: NearMap (8/10/2022)
NOTE: Photo locations are approximate.

Date: 11/21/2022
Note: General Site Photo
Photo 207-1 Caption:
E1, compaction testing



Photo 208-1

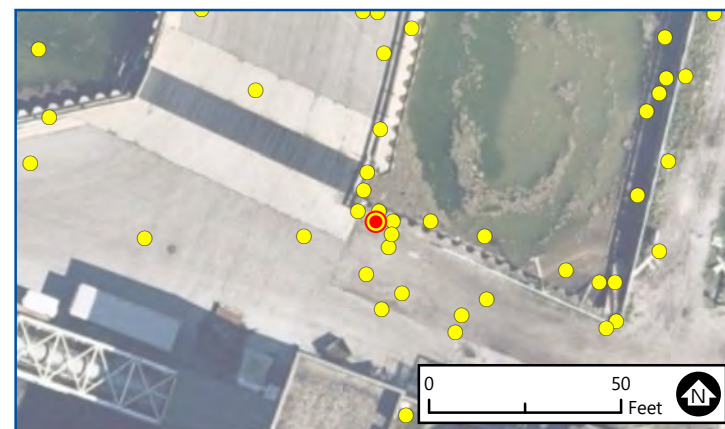
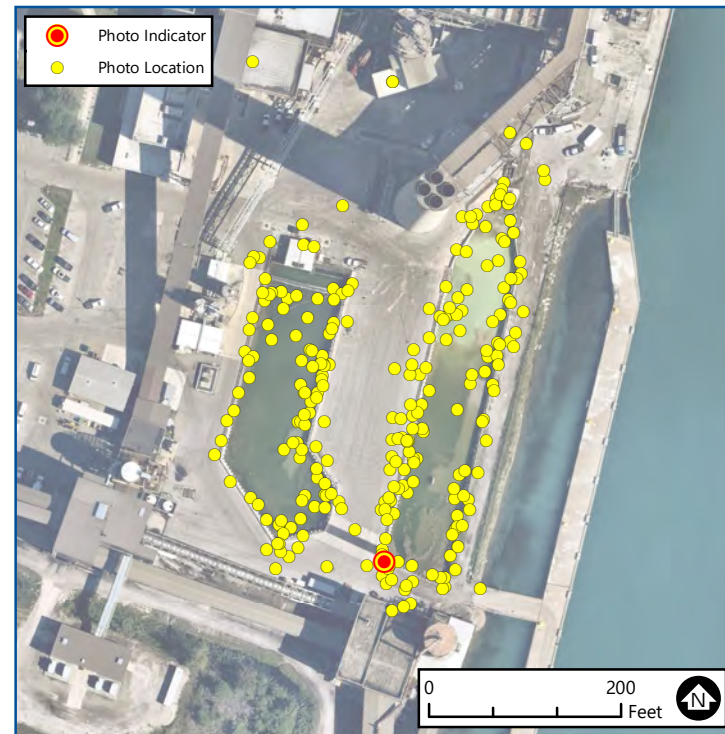

208 of 269
**CONSTRUCTION
MONITORING**
PHOTO LOCATIONS
St. Clair Power Plant
DTE Energy
East China, Michigan

Aerial Image: NearMap (8/10/2022)
NOTE: Photo locations are approximate.

Date: 11/22/2022
Note: General Site Photo

Photo 208-1 Caption:
E1/E2 backfilling, 5th lift

Photo 209-1

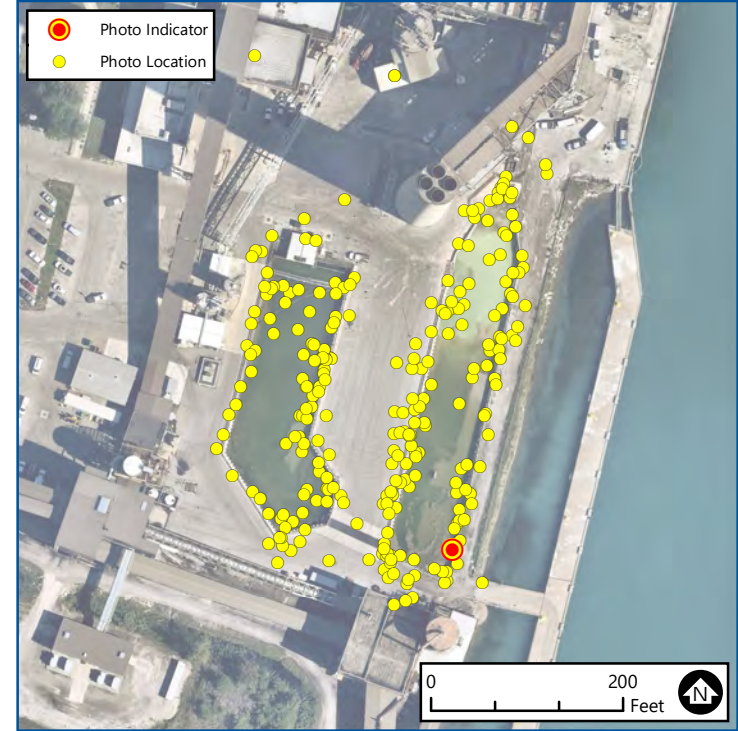
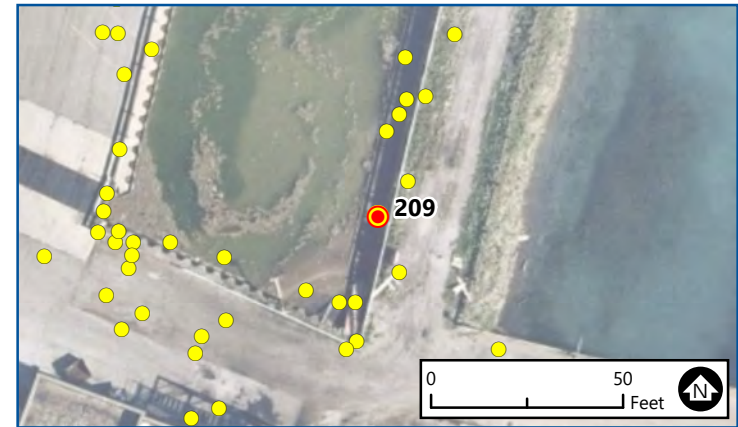

Photo 209-2



209 of 269
**CONSTRUCTION
MONITORING**
PHOTO LOCATIONS
St. Clair Power Plant
DTE Energy
East China, Michigan

Aerial Image: NearMap (8/10/2022)
NOTE: Photo locations are approximate.

Date: 11/22/2022
Note: General Site Photo

Photo 209-1 Caption:
E2, backfilled to Elev. 572'

Photo 209-2 Caption:
E2, backfilled to Elev. 572'

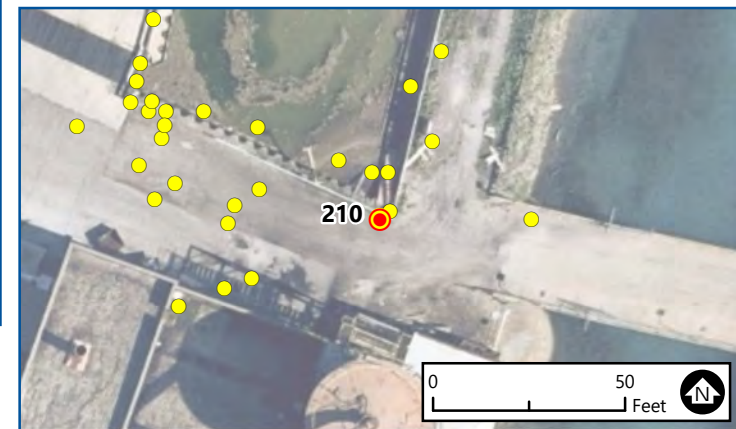

210 of 269
**CONSTRUCTION
MONITORING**
PHOTO LOCATIONS
St. Clair Power Plant
DTE Energy
East China, Michigan

Aerial Image: NearMap (8/10/2022)
NOTE: Photo locations are approximate.

Date: 11/22/2022
Note: General Site Photo

Photo 210-1 Caption:
E3, backfilled to Elev. 572'

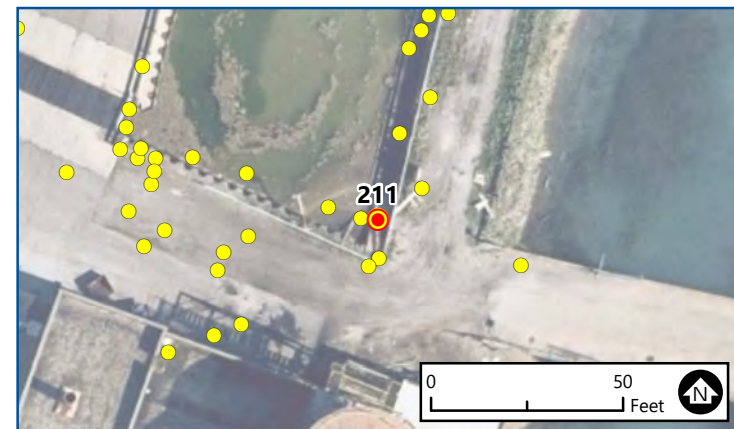

211 of 269
**CONSTRUCTION
MONITORING**
PHOTO LOCATIONS
St. Clair Power Plant
DTE Energy
East China, Michigan

Date: 11/23/2022
Note: General Site Photo

Photo 211-1 Caption:
East basin looking north - clay backfill in basin (foreground of photo)

Aerial Image: NearMap (8/10/2022)
NOTE: Photo locations are approximate.

Photo 212-1



Photo 212-2



212 of 269
**CONSTRUCTION
MONITORING**
PHOTO LOCATIONS
St. Clair Power Plant
DTE Energy
East China, Michigan

Aerial Image: NearMap (8/10/2022)
NOTE: Photo locations are approximate.

Date: 11/23/2022
Note: General Site Photo

Photo 212-1 Caption:
E5/E6/E7 backfilled, looking SW

Photo 212-2 Caption:
E5/E6/E7 backfilled, looking SW

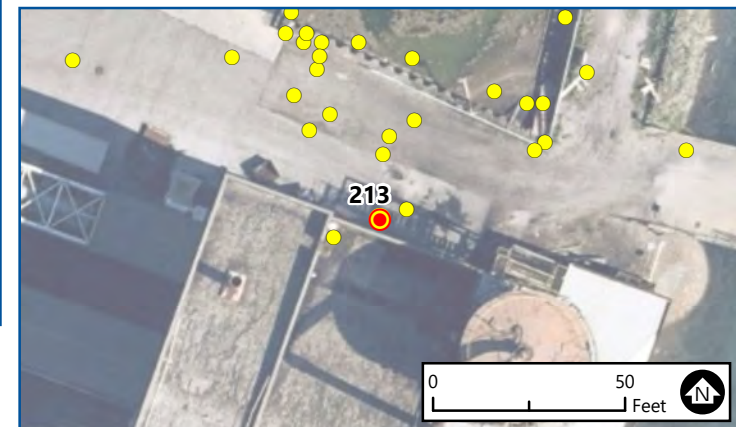

213 of 269
**CONSTRUCTION
MONITORING**
PHOTO LOCATIONS
St. Clair Power Plant
DTE Energy
East China, Michigan

Aerial Image: NearMap (8/10/2022)
NOTE: Photo locations are approximate.

Date: 11/28/2022
Note: General Site Photo

Photo 213-1 Caption:
East basin looking north - clay backfill in basin (foreground of photo) and CCR mix zone along west side (background)



Photo 214-1



214 of 269
**CONSTRUCTION
MONITORING**
PHOTO LOCATIONS
St. Clair Power Plant
DTE Energy
East China, Michigan

Aerial Image: NearMap (8/10/2022)
NOTE: Photo locations are approximate.

Date: 11/28/2022
Note: General Site Photo
Photo 214-1 Caption:
E9, backfilling, looking west

Photo 215-1



215 of 269
**CONSTRUCTION
MONITORING**
PHOTO LOCATIONS
St. Clair Power Plant
DTE Energy
East China, Michigan

Aerial Image: NearMap (8/10/2022)
NOTE: Photo locations are approximate.

Date: 11/28/2022
Note: General Site Photo

Photo 215-1 Caption:
E9, backfilled to Elev. 572'



216 of 269
**CONSTRUCTION
MONITORING**
PHOTO LOCATIONS
St. Clair Power Plant
DTE Energy
East China, Michigan

Aerial Image: NearMap (8/10/2022)
NOTE: Photo locations are approximate.

Date: 12/1/2022
Note: General Site Photo
Photo 216-1 Caption:
E11, backfilled to Elev. 572'; looking west



Photo 217-1

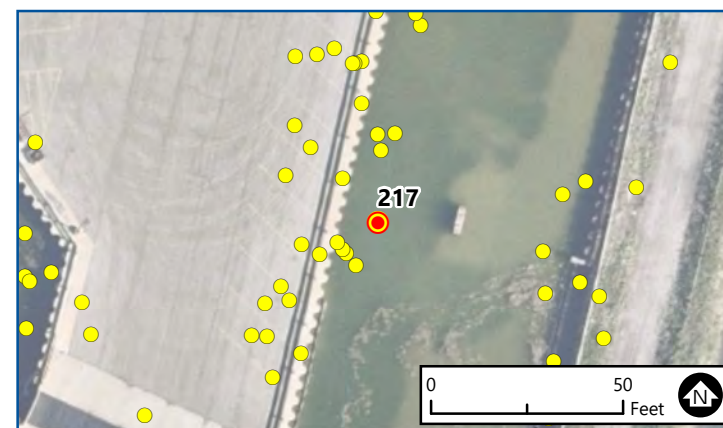
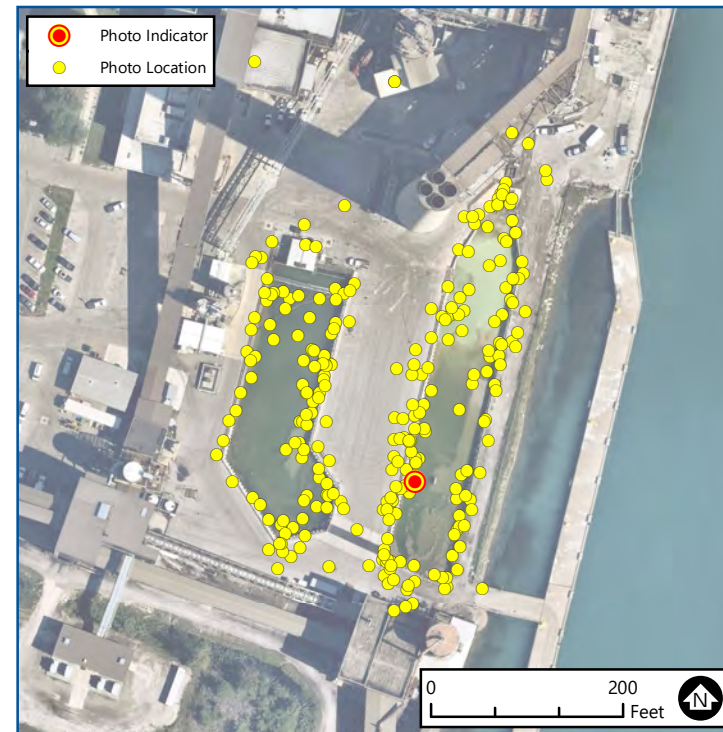

217 of 269
**CONSTRUCTION
MONITORING**
PHOTO LOCATIONS
St. Clair Power Plant
DTE Energy
East China, Michigan

Aerial Image: NearMap (8/10/2022)
NOTE: Photo locations are approximate.

Date: 12/2/2022
Note: General Site Photo
Photo 217-1 Caption:
E14, backfilled to Elev. 572', looking east

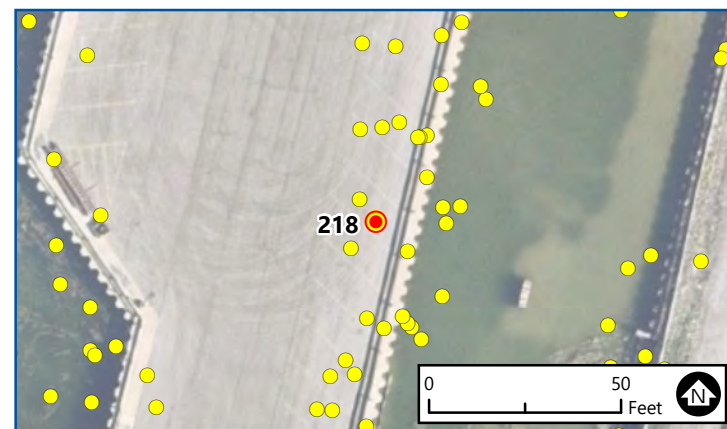

218 of 269
**CONSTRUCTION
MONITORING**
PHOTO LOCATIONS
St. Clair Power Plant
DTE Energy
East China, Michigan

Aerial Image: NearMap (8/10/2022)
NOTE: Photo locations are approximate.

Date: 12/2/2022
Note: General Site Photo

Photo 218-1 Caption:
E15, backfilled to approximate Elev. 572';
looking east

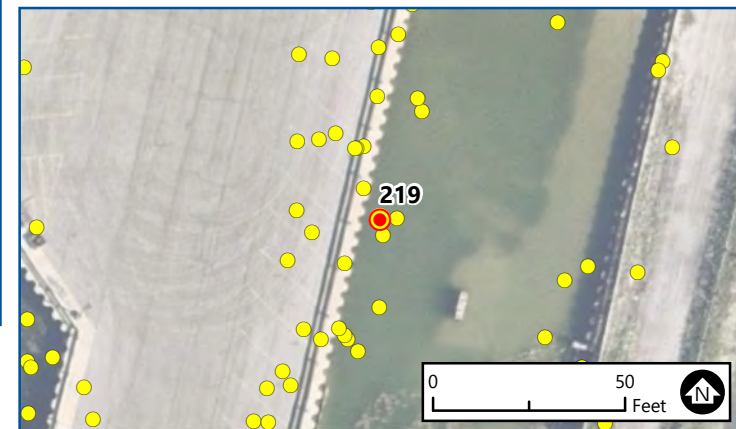

219 of 269
**CONSTRUCTION
MONITORING**
PHOTO LOCATIONS
St. Clair Power Plant
DTE Energy
East China, Michigan

Aerial Image: NearMap (8/10/2022)
NOTE: Photo locations are approximate.

Date: 12/3/2022
Note: General Site Photo

Photo 219-1 Caption:
E16, backfilled to Elev. 572', looking east



Photo 220-1



220 of 269
**CONSTRUCTION
MONITORING**
PHOTO LOCATIONS
St. Clair Power Plant
DTE Energy
East China, Michigan

Aerial Image: NearMap (8/10/2022)
NOTE: Photo locations are approximate.

Date: 12/3/2022
Note: General Site Photo
Photo 220-1 Caption:
E17, backfilled to Elev. 572', looking east

Photo 221-1

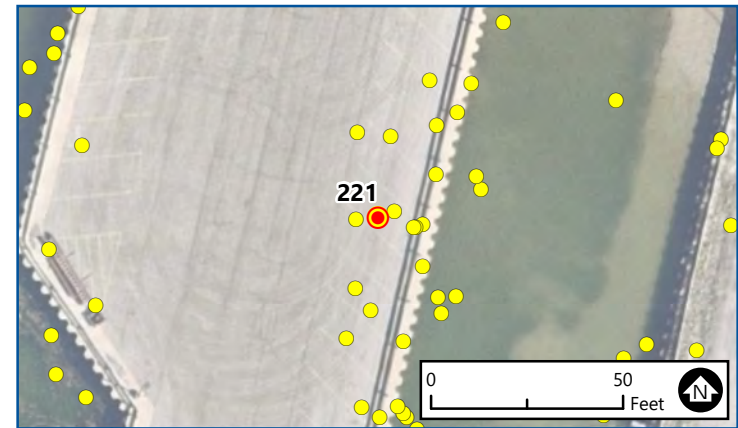

221 of 269
**CONSTRUCTION
MONITORING**
PHOTO LOCATIONS
St. Clair Power Plant
DTE Energy
East China, Michigan

Aerial Image: NearMap (8/10/2022)
NOTE: Photo locations are approximate.

Date: 12/3/2022
Note: General Site Photo
Photo 221-1 Caption:
E18, backfilling

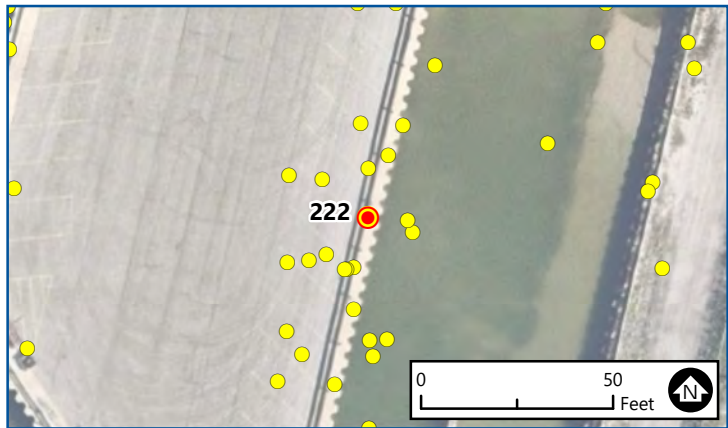
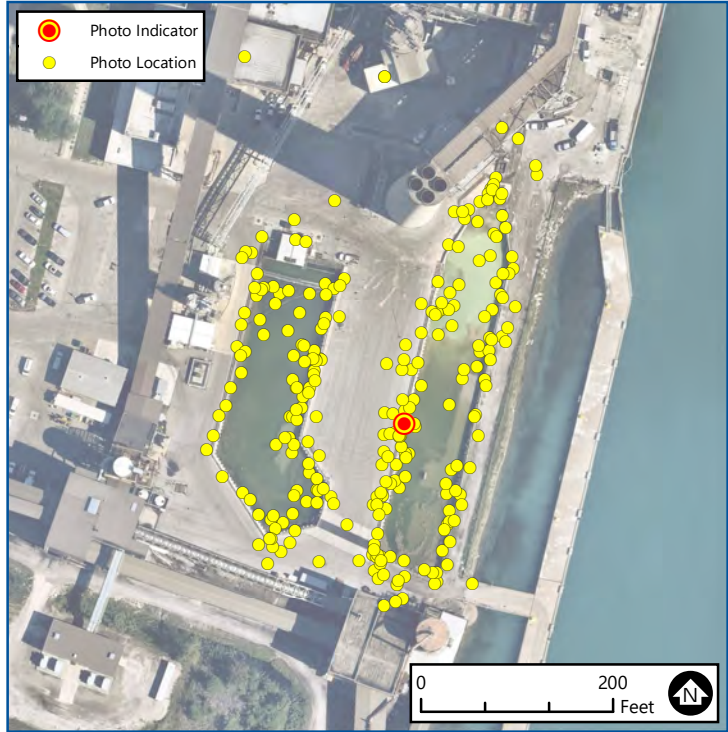

222 of 269
**CONSTRUCTION
MONITORING**
PHOTO LOCATIONS
St. Clair Power Plant
DTE Energy
East China, Michigan

Aerial Image: NearMap (8/10/2022)
NOTE: Photo locations are approximate.

Date: 12/5/2022
Note: General Site Photo
Photo 222-1 Caption:
E12, backfilling, looking east

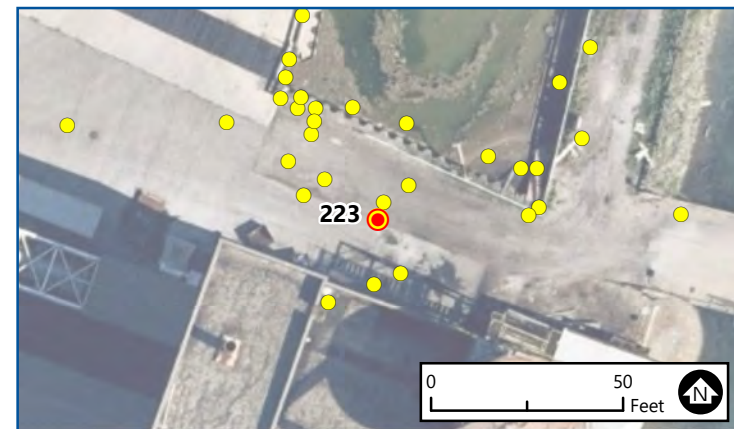

223 of 269
**CONSTRUCTION
MONITORING**
PHOTO LOCATIONS
St. Clair Power Plant
DTE Energy
East China, Michigan

Aerial Image: NearMap (8/10/2022)
NOTE: Photo locations are approximate.

Date: 12/5/2022
Note: General Site Photo

Photo 223-1 Caption:
East basin looking north - soil backfilling
in progress

Photo 224-1



Photo 224-2

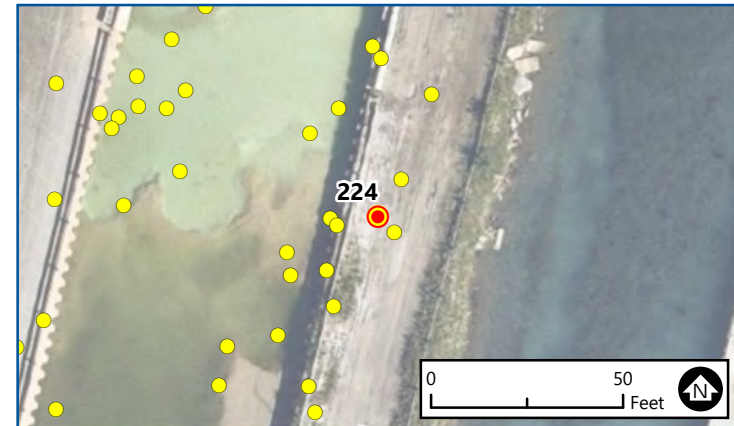

224 of 269
**CONSTRUCTION
MONITORING**
PHOTO LOCATIONS
St. Clair Power Plant
DTE Energy
East China, Michigan

Aerial Image: NearMap (8/10/2022)
NOTE: Photo locations are approximate.

Date: 12/8/2022
Note: General Site Photo

Photo 224-1 Caption:
E30, backfilling

Photo 224-2 Caption:
E30, backfilling



Photo 225-1

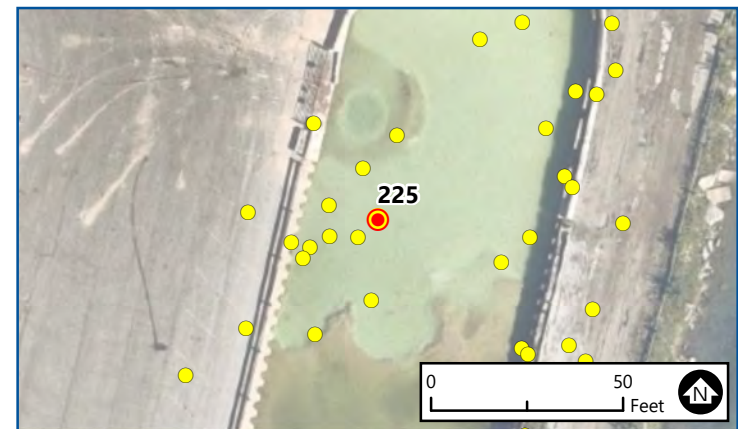
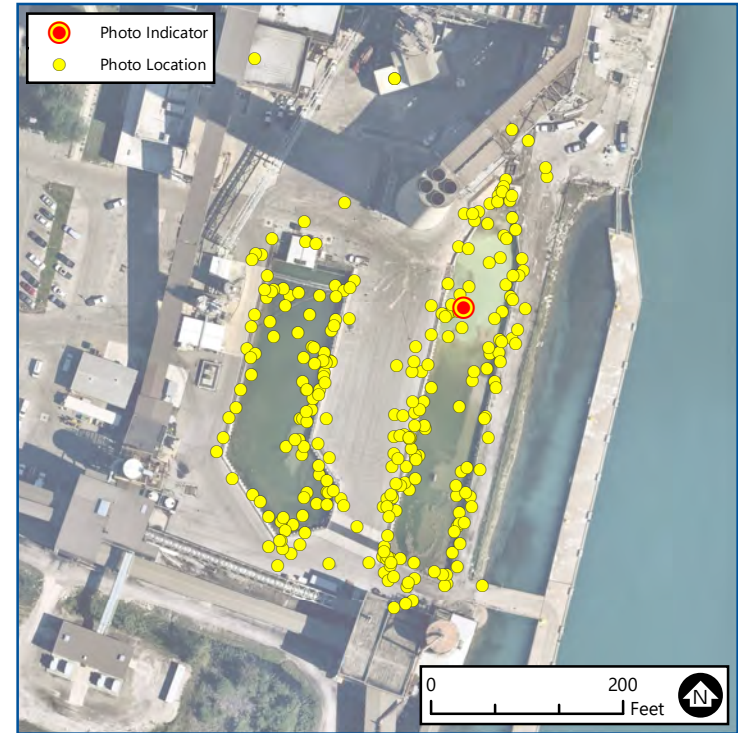

225 of 269
**CONSTRUCTION
MONITORING**
PHOTO LOCATIONS
St. Clair Power Plant
DTE Energy
East China, Michigan

Aerial Image: NearMap (8/10/2022)
NOTE: Photo locations are approximate.

Date: 12/8/2022
Note: General Site Photo
Photo 225-1 Caption:
E31, backfilling

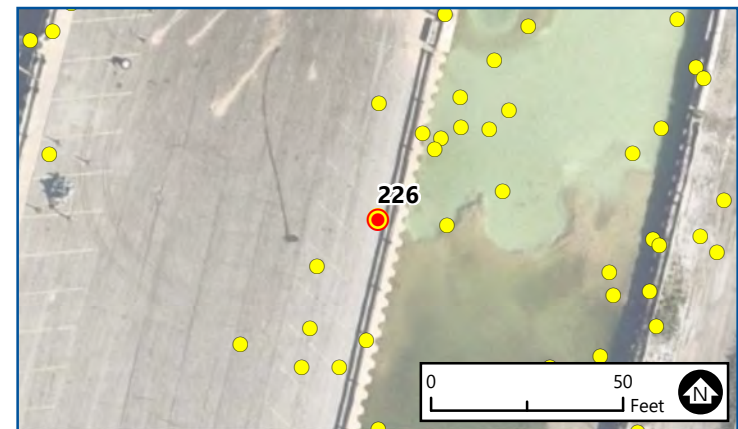
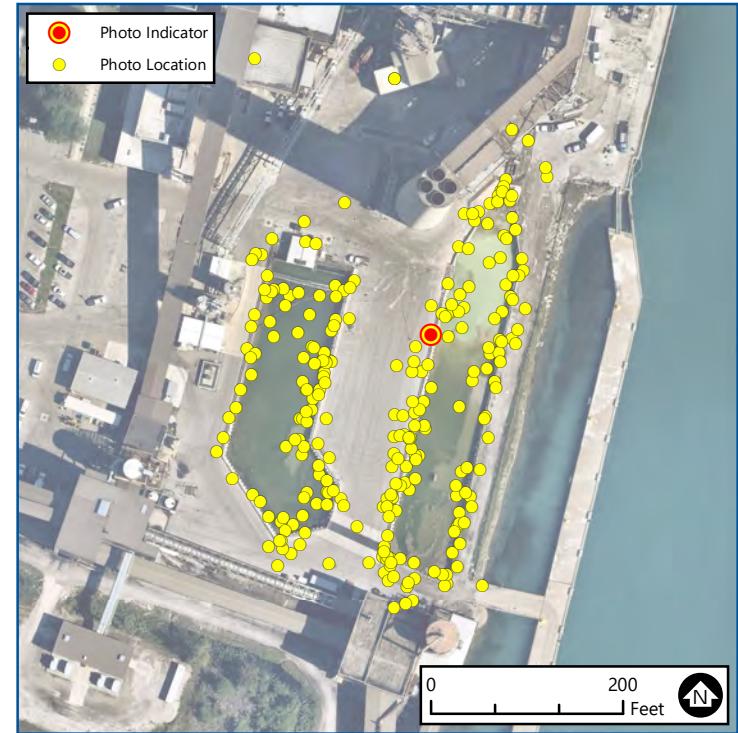

226 of 269
**CONSTRUCTION
MONITORING**
PHOTO LOCATIONS
St. Clair Power Plant
DTE Energy
East China, Michigan

Aerial Image: NearMap (8/10/2022)
NOTE: Photo locations are approximate.

Date: 12/8/2022
Note: General Site Photo

Photo 226-1 Caption:
E31, backfilled to approximate Elev. 572'

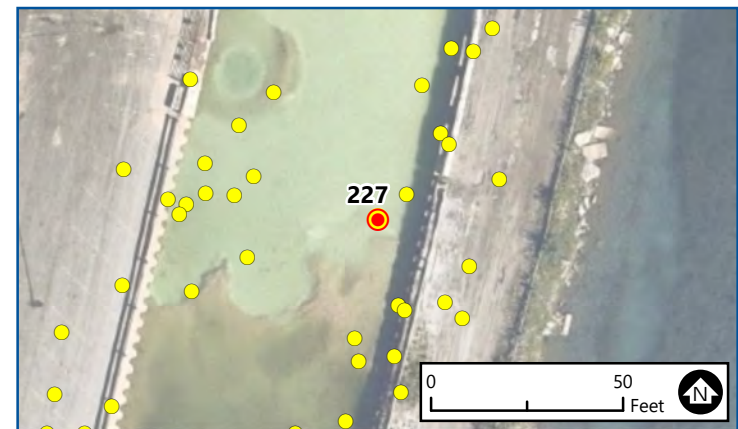

227 of 269
**CONSTRUCTION
MONITORING**
PHOTO LOCATIONS
St. Clair Power Plant
DTE Energy
East China, Michigan

Aerial Image: NearMap (8/10/2022)
NOTE: Photo locations are approximate.

Date: 12/9/2022
Note: General Site Photo

Photo 227-1 Caption:
Stockpiling backfill in the basin



Photo 228-1

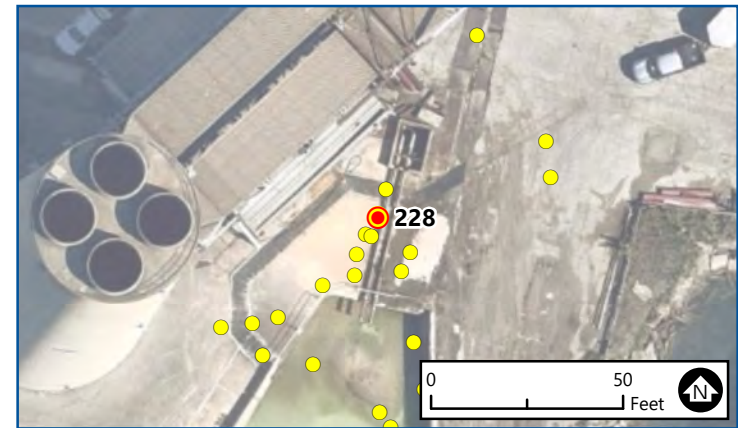

228 of 269
**CONSTRUCTION
MONITORING**
PHOTO LOCATIONS
St. Clair Power Plant
DTE Energy
East China, Michigan

Aerial Image: NearMap (8/10/2022)
NOTE: Photo locations are approximate.

Date: 12/10/2022
Note: General Site Photo

Photo 228-1 Caption:
East basin looking south - dewatering
and CCR removal in foreground,
backfilling in background



Photo 229-1

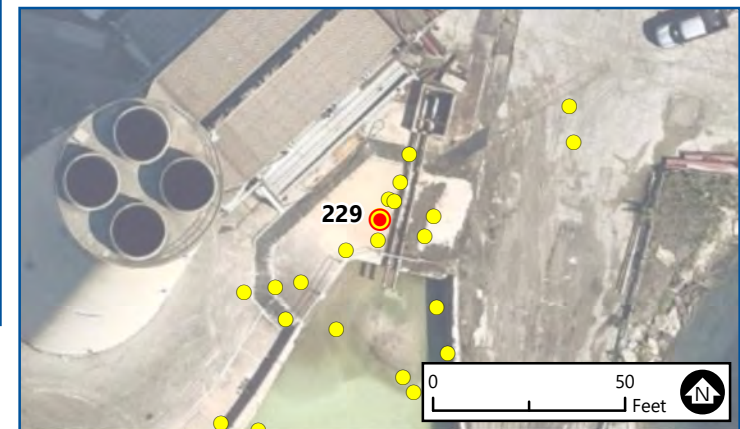

229 of 269
**CONSTRUCTION
MONITORING**
PHOTO LOCATIONS
St. Clair Power Plant
DTE Energy
East China, Michigan

Aerial Image: NearMap (8/10/2022)
NOTE: Photo locations are approximate.

Date: 12/12/2022
Note: General Site Photo

Photo 229-1 Caption:
East basin looking south - dewatering
and CCR removal in foreground,
backfilling in background

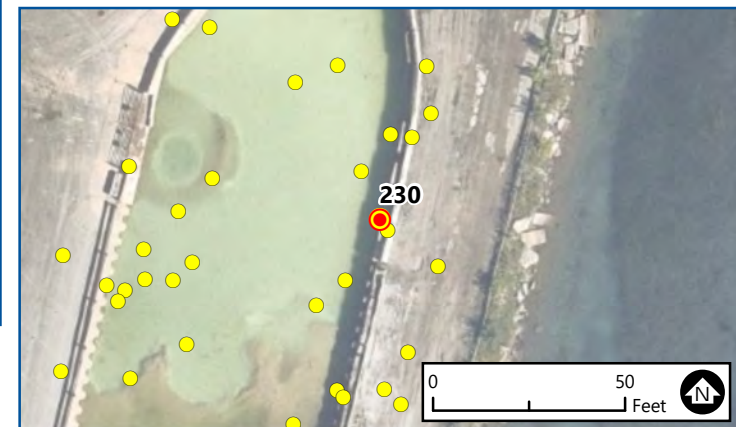

230 of 269
**CONSTRUCTION
MONITORING**
PHOTO LOCATIONS
St. Clair Power Plant
DTE Energy
East China, Michigan

Date: 12/10/2022
Note: General Site Photo

Photo 230-1 Caption:
E35 and E36 backfilling

Aerial Image: NearMap (8/10/2022)
NOTE: Photo locations are approximate.

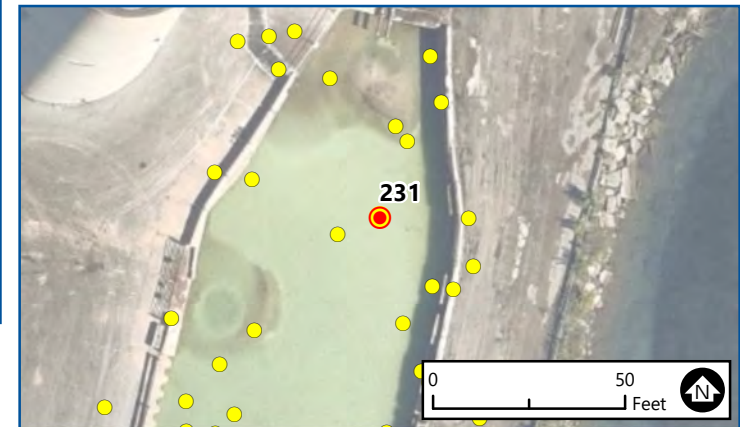

231 of 269
**CONSTRUCTION
MONITORING**
PHOTO LOCATIONS
St. Clair Power Plant
DTE Energy
East China, Michigan

Date: 12/12/2022
Note: General Site Photo

Photo 231-1 Caption:
E38, backfilling

Aerial Image: NearMap (8/10/2022)
NOTE: Photo locations are approximate.

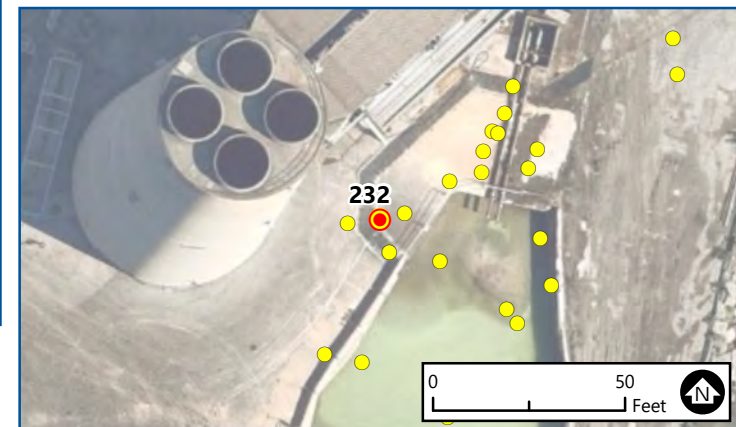

232 of 269
**CONSTRUCTION
MONITORING**
PHOTO LOCATIONS
St. Clair Power Plant
DTE Energy
East China, Michigan

Date: 12/13/2022
Note: General Site Photo
Photo 232-1 Caption:
E41, backfilling, looking east

Aerial Image: NearMap (8/10/2022)
NOTE: Photo locations are approximate.

Photo 233-1



Photo 233-2

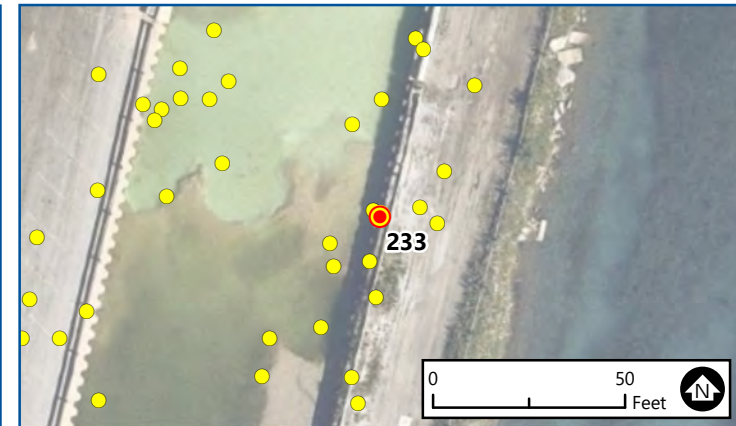

233 of 269
**CONSTRUCTION
MONITORING**
PHOTO LOCATIONS
St. Clair Power Plant
DTE Energy
East China, Michigan

Aerial Image: NearMap (8/10/2022)
NOTE: Photo locations are approximate.

Date: 12/14/2022
Note: General Site Photo

Photo 233-1 Caption:
East basin backfilling

Photo 233-2 Caption:
East basin backfilling and final CCR
removal

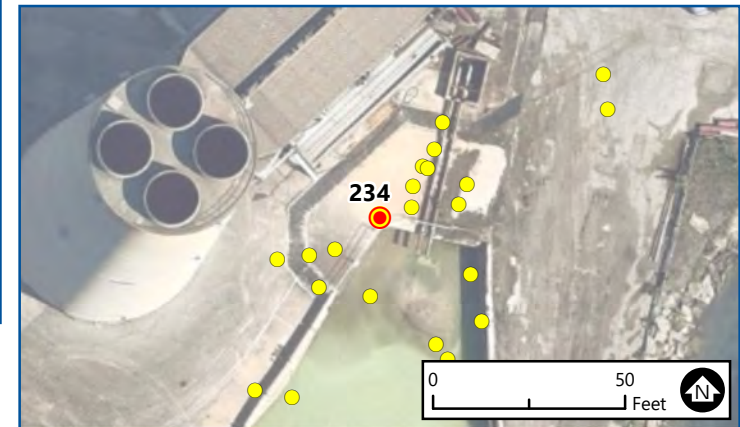

234 of 269
**CONSTRUCTION
MONITORING**
PHOTO LOCATIONS
St. Clair Power Plant
DTE Energy
East China, Michigan

Aerial Image: NearMap (8/10/2022)
NOTE: Photo locations are approximate.

Date: 12/16/2022
Note: General Site Photo

Photo 234-1 Caption:
East basin looking south - basin
backfilling

Photo 235-1

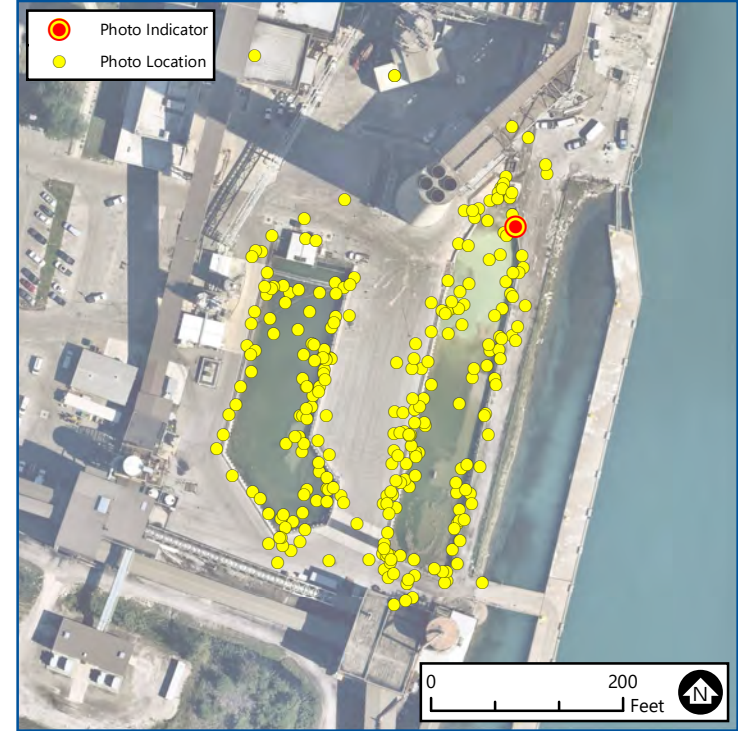
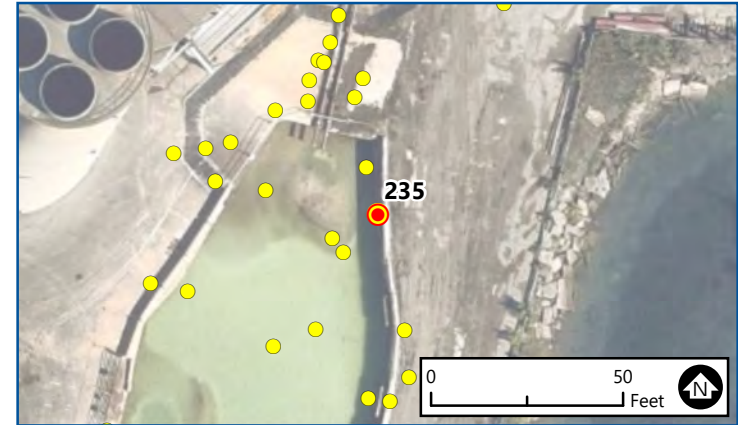

Photo 235-2



235 of 269
**CONSTRUCTION
MONITORING**
PHOTO LOCATIONS
St. Clair Power Plant
DTE Energy
East China, Michigan

Aerial Image: NearMap (8/10/2022)
NOTE: Photo locations are approximate.

Date: 12/16/2022
Note: General Site Photo

Photo 235-1 Caption:
East basin backfilling and final CCR
removal

Photo 235-2 Caption:
East basin backfilling and final CCR
removal

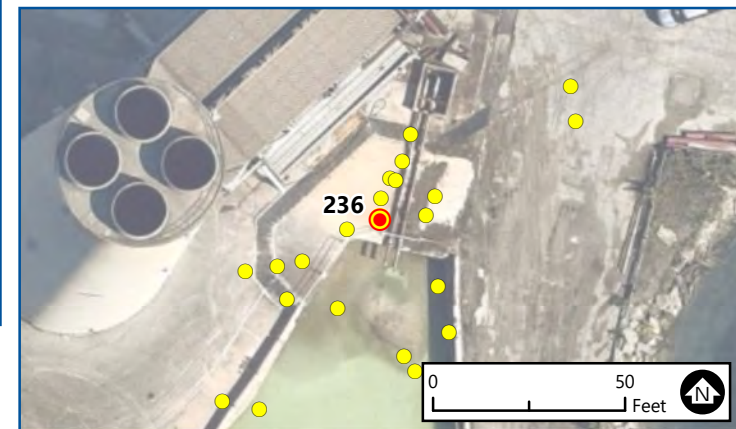

236 of 269
**CONSTRUCTION
MONITORING**
PHOTO LOCATIONS
St. Clair Power Plant
DTE Energy
East China, Michigan

Aerial Image: NearMap (8/10/2022)
NOTE: Photo locations are approximate.

Date: 12/21/2022
Note: General Site Photo

Photo 236-1 Caption:
East basin, backfilling, looking south

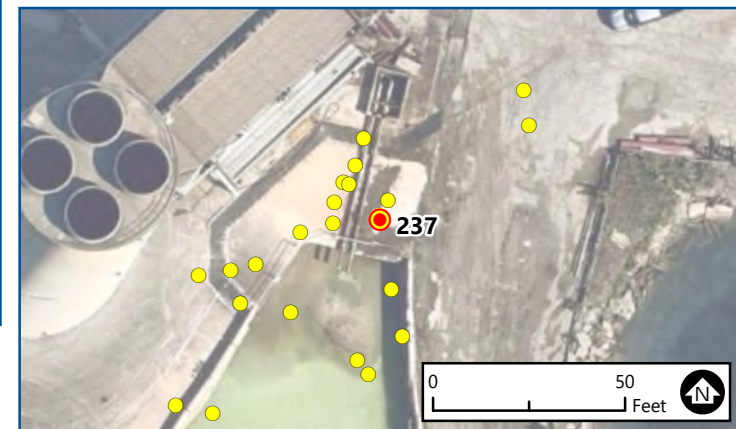

237 of 269
**CONSTRUCTION
MONITORING**
PHOTO LOCATIONS
St. Clair Power Plant
DTE Energy
East China, Michigan

Aerial Image: NearMap (8/10/2022)
NOTE: Photo locations are approximate.

Date: 12/21/2022
Note: General Site Photo

Photo 237-1 Caption:
East basin, backfilling, looking SW

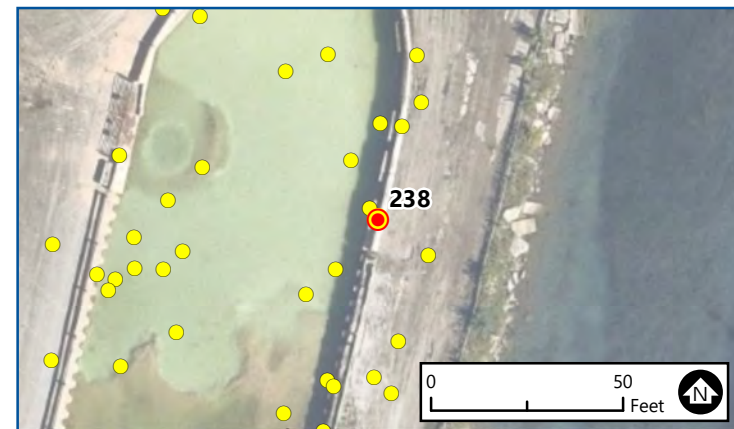
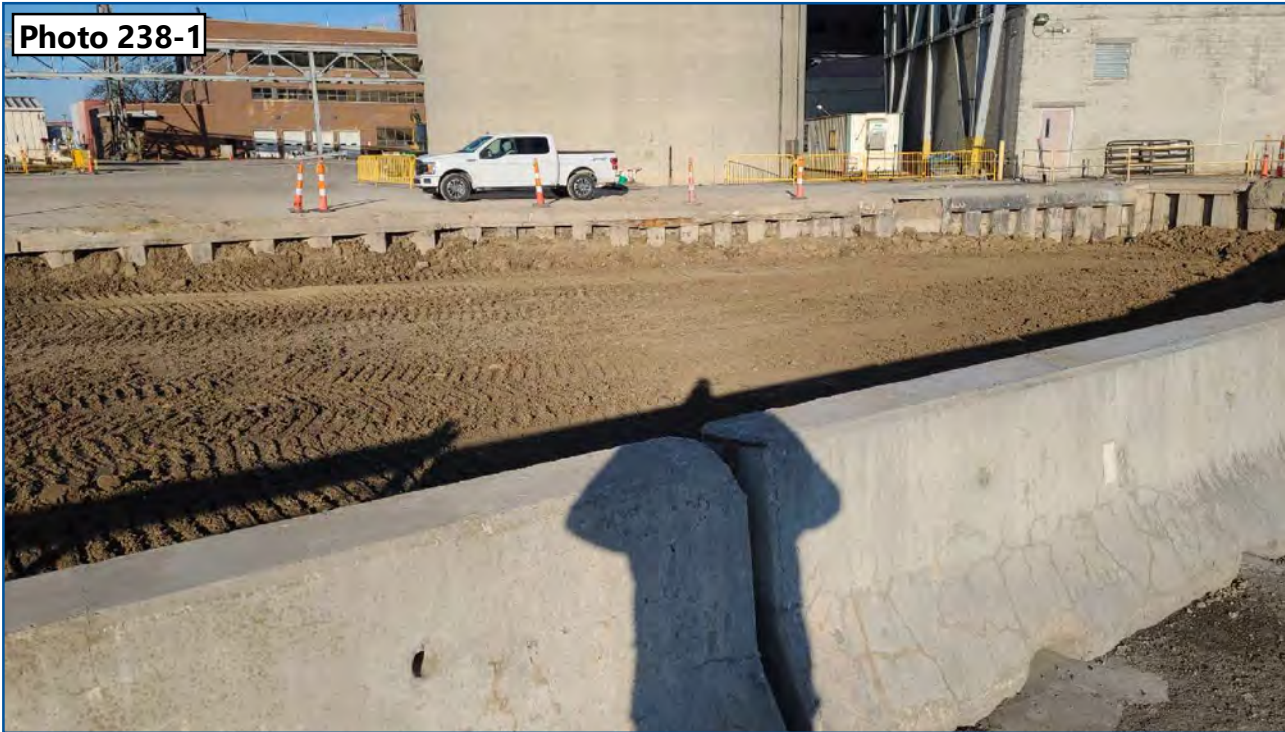

238 of 269
**CONSTRUCTION
MONITORING**
PHOTO LOCATIONS
St. Clair Power Plant
DTE Energy
East China, Michigan

Aerial Image: NearMap (8/10/2022)
NOTE: Photo locations are approximate.

Date: 12/21/2022
Note: General Site Photo
Photo 238-1 Caption:
East basin, backfilling, looking west

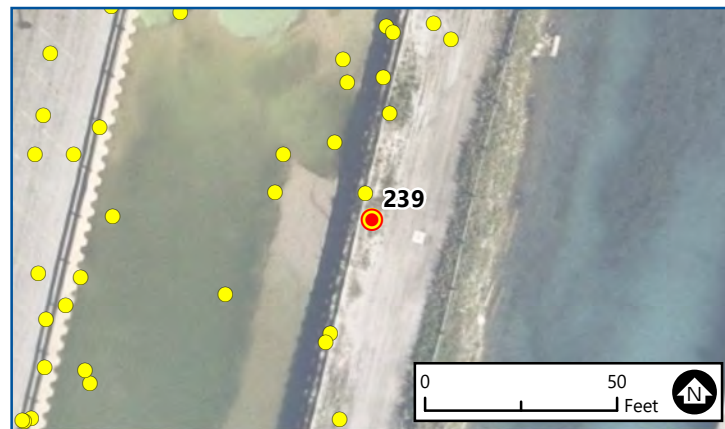
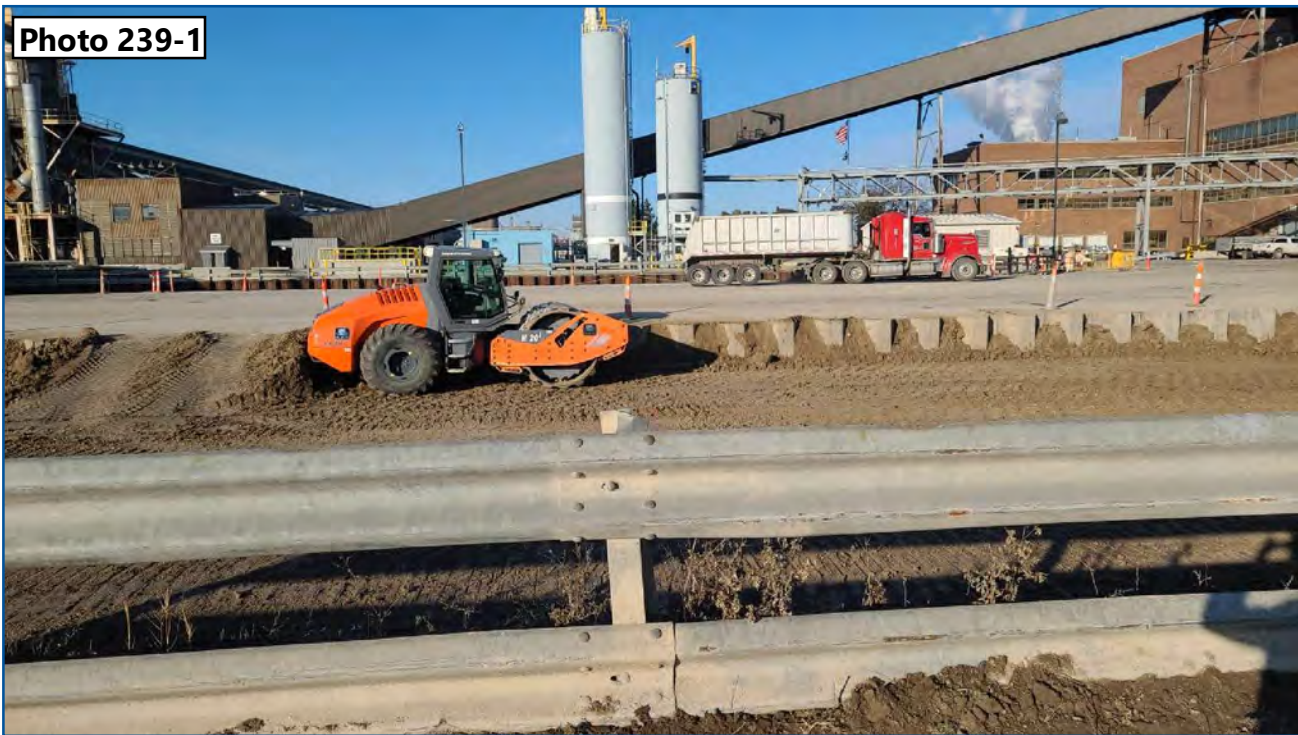

239 of 269
CONSTRUCTION MONITORING
PHOTO LOCATIONS
St. Clair Power Plant
DTE Energy
East China, Michigan

Date: 12/21/2022
Note: General Site Photo

Photo 239-1 Caption:
East basin, backfilling, looking west

Aerial Image: NearMap (8/10/2022)
NOTE: Photo locations are approximate.

Photo 240-1



Photo 240-2

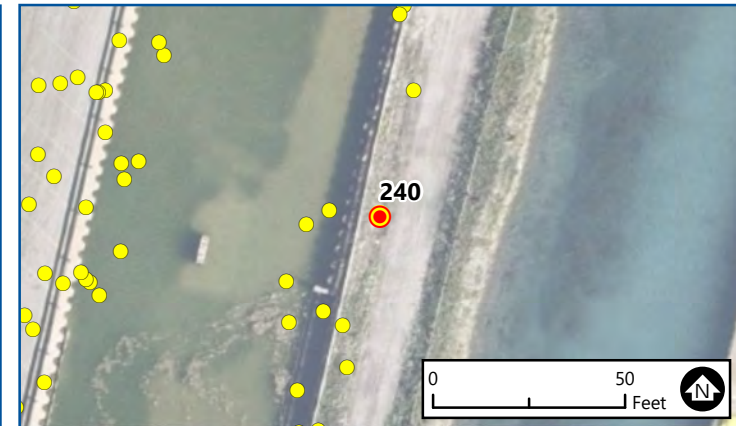

240 of 269
**CONSTRUCTION
MONITORING**
PHOTO LOCATIONS
St. Clair Power Plant
DTE Energy
East China, Michigan

Aerial Image: NearMap (8/10/2022)
NOTE: Photo locations are approximate.

Date: 12/21/2022
Note: General Site Photo

Photo 240-1 Caption:
East basin, backfilling, looking NW

Photo 240-2 Caption:
East basin, backfilling, looking SW

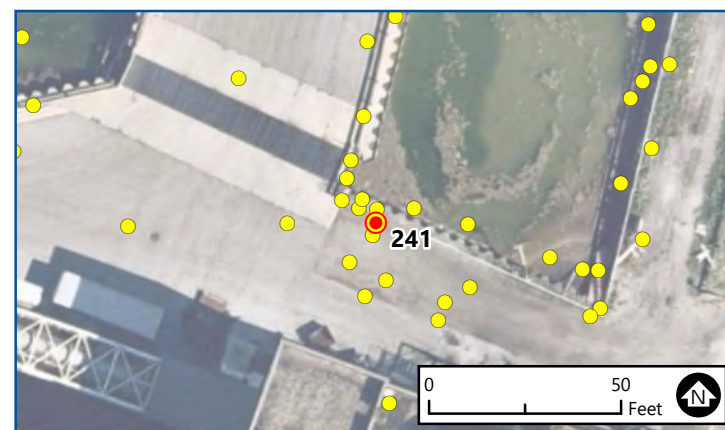
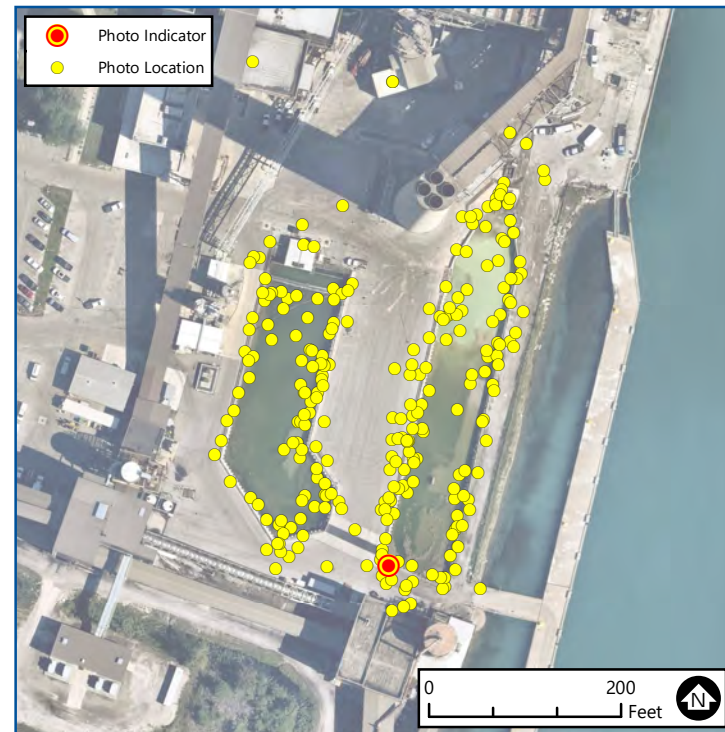

241 of 269
**CONSTRUCTION
MONITORING**
PHOTO LOCATIONS
St. Clair Power Plant
DTE Energy
East China, Michigan

Aerial Image: NearMap (8/10/2022)
NOTE: Photo locations are approximate.

Date: 12/21/2022
Note: General Site Photo

Photo 241-1 Caption:
East basin, backfilling, looking south



Photo 242-1

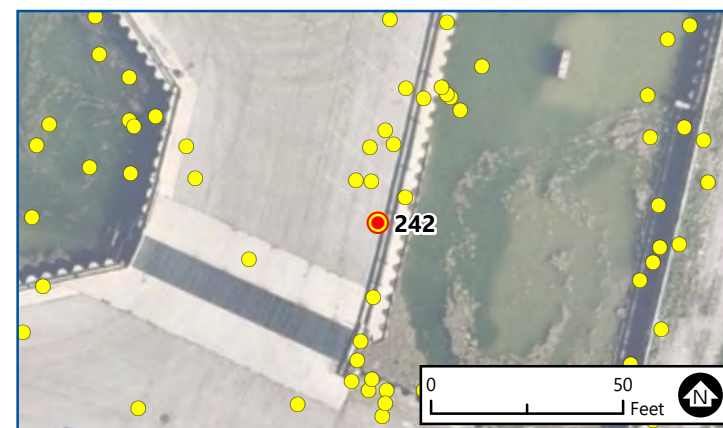

242 of 269
**CONSTRUCTION
MONITORING**
PHOTO LOCATIONS
St. Clair Power Plant
DTE Energy
East China, Michigan

Aerial Image: NearMap (8/10/2022)
NOTE: Photo locations are approximate.

Date: 12/21/2022
Note: General Site Photo
Photo 242-1 Caption:
East basin, backfilling, looking NE

Photo 243-1

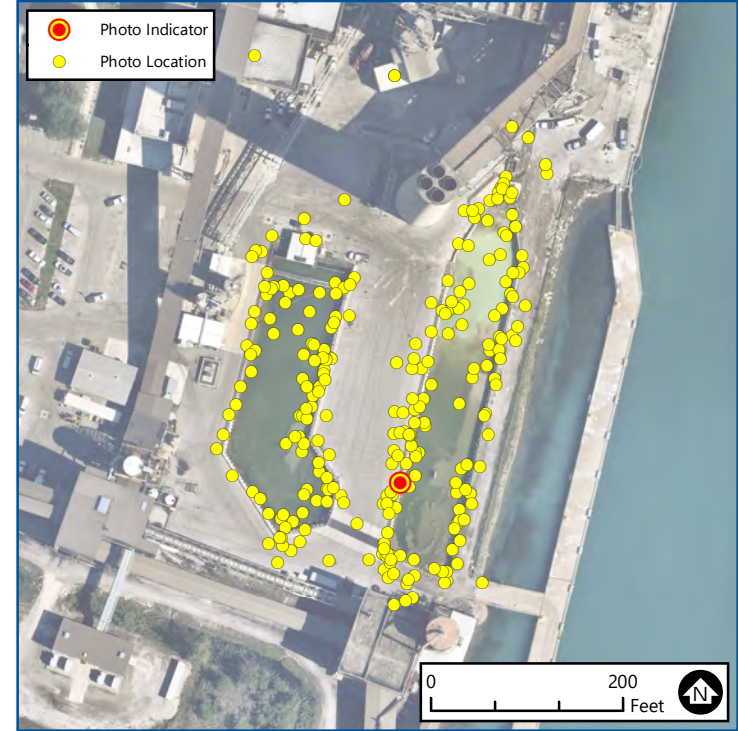

Photo 243-2



243 of 269
**CONSTRUCTION
MONITORING**
PHOTO LOCATIONS
St. Clair Power Plant
DTE Energy
East China, Michigan

Aerial Image: NearMap (8/10/2022)
NOTE: Photo locations are approximate.

Date: 12/21/2022
Note: General Site Photo
Photo 243-1 Caption:
Overflow canal, backfilling
Photo 243-2 Caption:
Overflow canal, backfilling



Photo 244-1



244 of 269
**CONSTRUCTION
MONITORING**
PHOTO LOCATIONS
St. Clair Power Plant
DTE Energy
East China, Michigan

Aerial Image: NearMap (8/10/2022)
NOTE: Photo locations are approximate.

Date: 1/5/2023
Note: General Site Photo

Photo 244-1 Caption:
East basin looking north, with basin
backfill ongoing

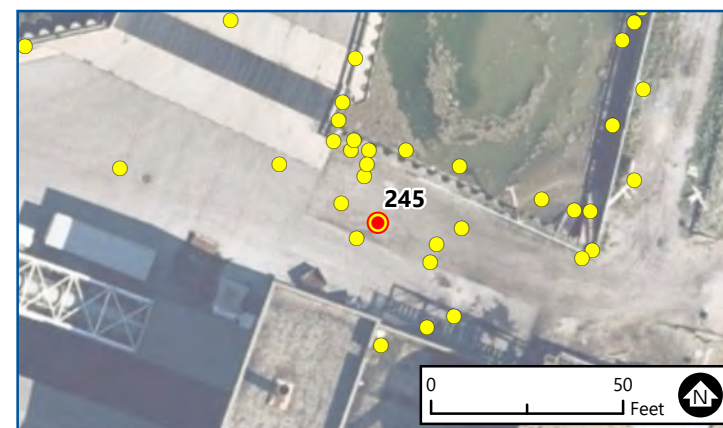

245 of 269
**CONSTRUCTION
MONITORING**
PHOTO LOCATIONS
St. Clair Power Plant
DTE Energy
East China, Michigan

Aerial Image: NearMap (8/10/2022)
NOTE: Photo locations are approximate.

Date: 1/5/2023
Note: General Site Photo

Photo 245-1 Caption:
Southern end of East basin nearly
backfilled - water ponding in SE corner
of basin after two days of moderate rain

Photo 246-1



Photo 246-2

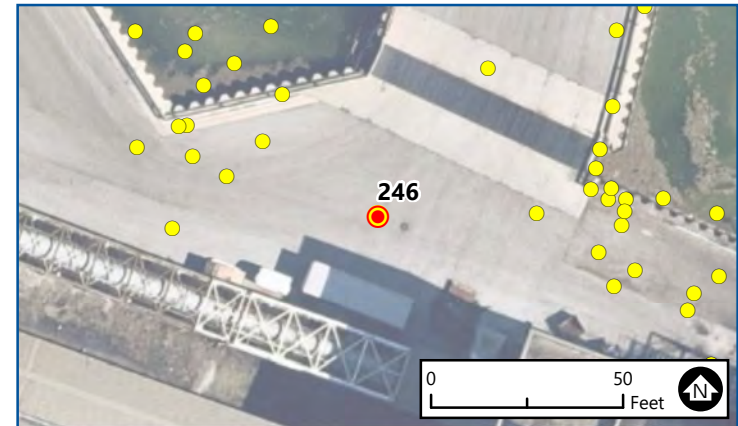

246 of 269
**CONSTRUCTION
MONITORING**
PHOTO LOCATIONS
St. Clair Power Plant
DTE Energy
East China, Michigan

Aerial Image: NearMap (8/10/2022)
NOTE: Photo locations are approximate.

Date: 1/5/2023
Note: General Site Photo

Photo 246-1 Caption:
West basin backfill activities - viewed
from south to north

Photo 246-2 Caption:
West basin backfill activities - viewed
from south to northwest

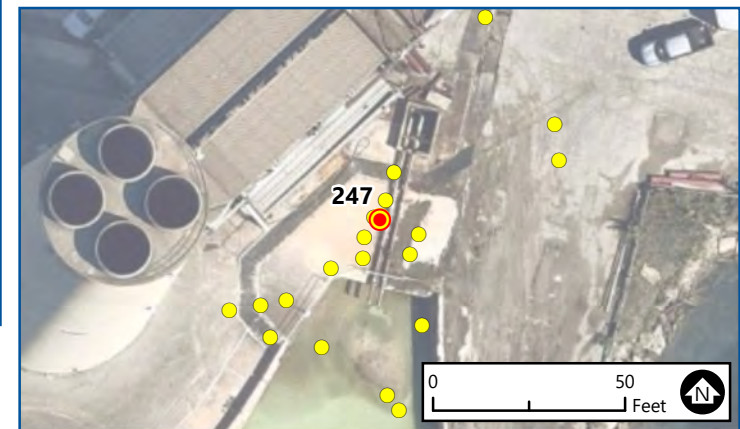

247 of 269
**CONSTRUCTION
MONITORING**
PHOTO LOCATIONS
St. Clair Power Plant
DTE Energy
East China, Michigan

Aerial Image: NearMap (8/10/2022)
NOTE: Photo locations are approximate.

Date: 1/10/2023
Note: General Site Photo

Photo 247-1 Caption:
East basin backfill - viewed from north to south



Photo 248-1

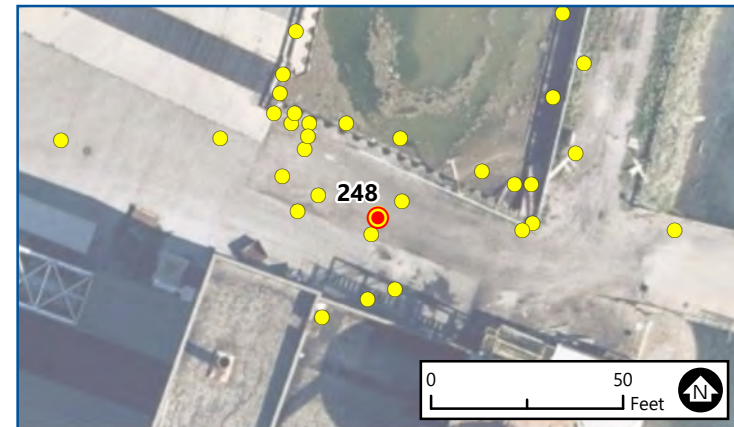

248 of 269
**CONSTRUCTION
MONITORING**
PHOTO LOCATIONS
St. Clair Power Plant
DTE Energy
East China, Michigan

Aerial Image: NearMap (8/10/2022)
NOTE: Photo locations are approximate.

Date: 1/10/2023
Note: General Site Photo

Photo 248-1 Caption:
East basin backfill - viewed from south
to north



Photo 249-1

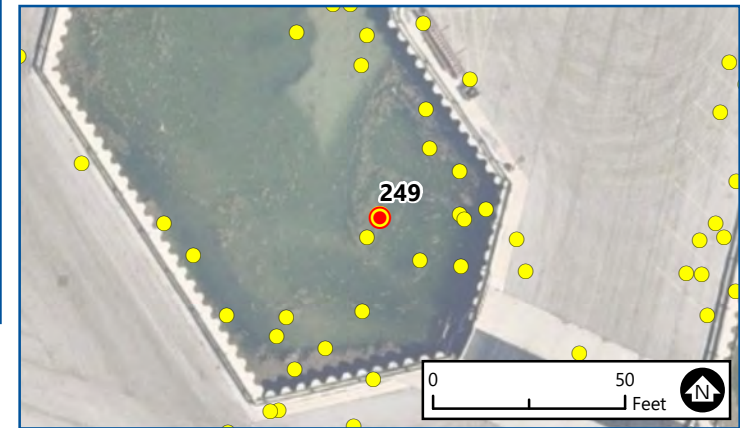

249 of 269
**CONSTRUCTION
MONITORING**
PHOTO LOCATIONS
St. Clair Power Plant
DTE Energy
East China, Michigan

Aerial Image: NearMap (8/10/2022)
NOTE: Photo locations are approximate.

Date: 12/21/2022
Note: General Site Photo
Photo 249-1 Caption:
W3, backfilling, looking SW



Photo 250-1



250 of 269
**CONSTRUCTION
MONITORING**
PHOTO LOCATIONS
St. Clair Power Plant
DTE Energy
East China, Michigan

Aerial Image: NearMap (8/10/2022)
NOTE: Photo locations are approximate.

Date: 12/22/2022
Note: General Site Photo
Photo 250-1 Caption:
W5, backfilling

Photo 251-1

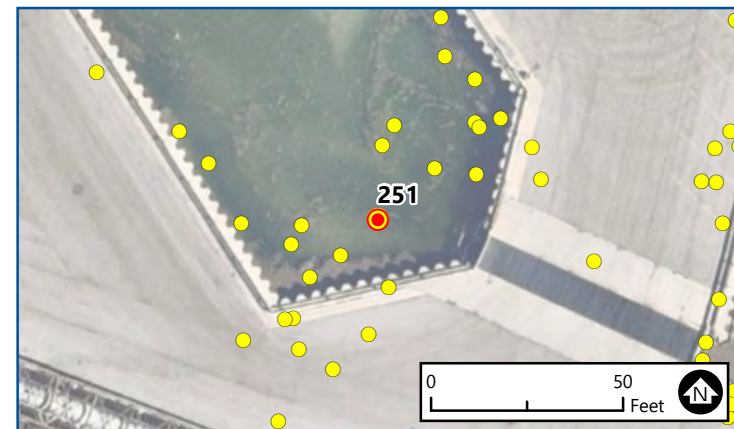

251 of 269
**CONSTRUCTION
MONITORING**
PHOTO LOCATIONS
St. Clair Power Plant
DTE Energy
East China, Michigan

Aerial Image: NearMap (8/10/2022)
NOTE: Photo locations are approximate.

Date: 12/22/2022

Note: West Basin

Photo 251-1 Caption:
West basin backfilling in foreground,
CCR removal in background

Photo 252-1



Photo 252-2

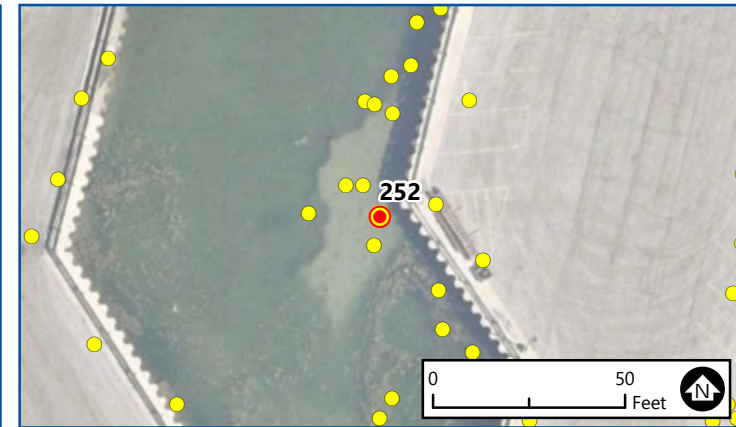

252 of 269
**CONSTRUCTION
MONITORING**
PHOTO LOCATIONS
St. Clair Power Plant
DTE Energy
East China, Michigan

Aerial Image: NearMap (8/10/2022)
NOTE: Photo locations are approximate.

Date: 12/29/2022
Note: General Site Photo

Photo 252-1 Caption:
W13 backfilled to approximate Elev. 572'

Photo 252-2 Caption:
W13 backfilled to approximate Elev. 572'

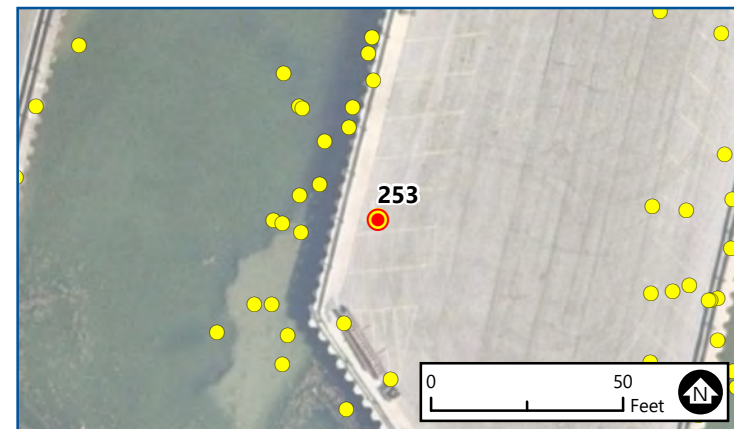

253 of 269
**CONSTRUCTION
MONITORING**
PHOTO LOCATIONS
St. Clair Power Plant
DTE Energy
East China, Michigan

Aerial Image: NearMap (8/10/2022)
NOTE: Photo locations are approximate.

Date: 12/30/2022
Note: General Site Photo

Photo 253-1 Caption:
W15 backfilled, working on backfilling
W16

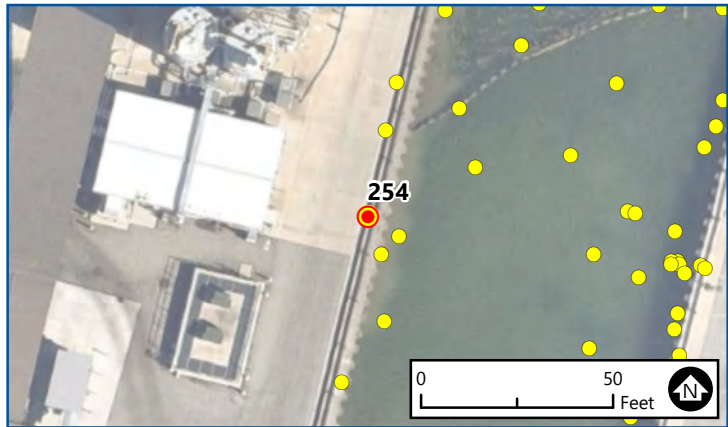
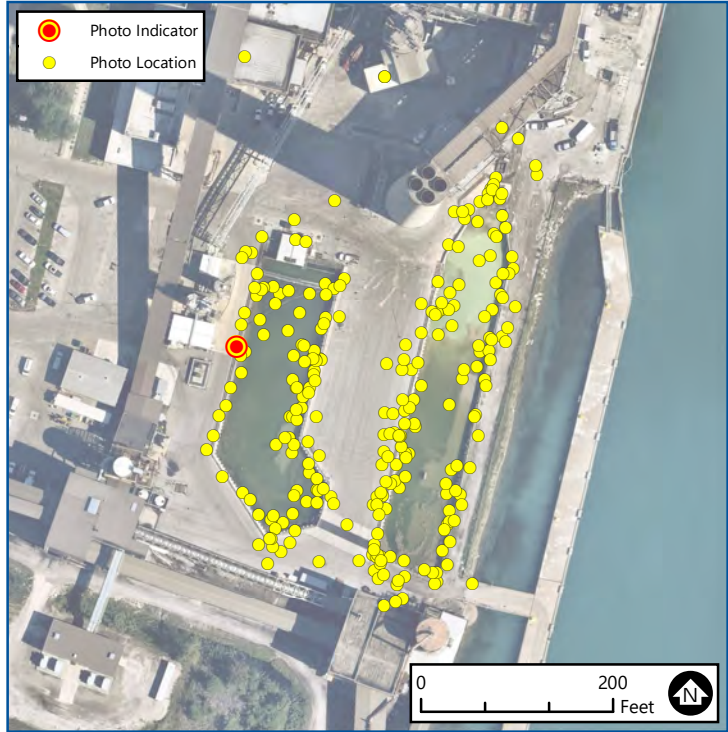

254 of 269
CONSTRUCTION MONITORING
PHOTO LOCATIONS
St. Clair Power Plant
DTE Energy
East China, Michigan

Date: 1/5/2023
Note: General Site Photo

Photo 254-1 Caption:
W21, backfilled to Elev. 572'

Aerial Image: NearMap (8/10/2022)
NOTE: Photo locations are approximate.

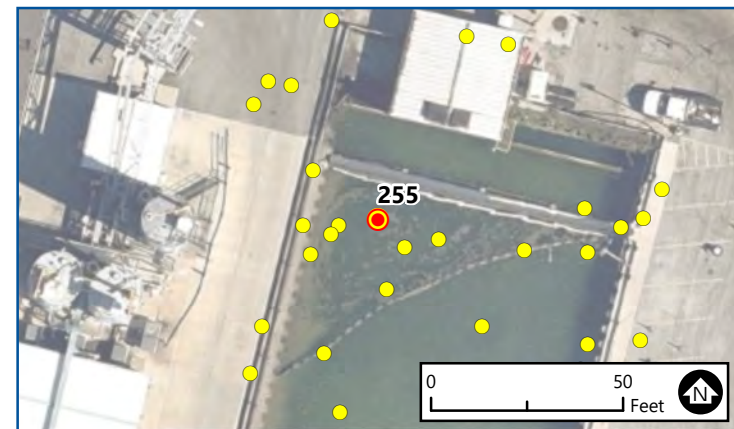

255 of 269
**CONSTRUCTION
MONITORING**
PHOTO LOCATIONS
St. Clair Power Plant
DTE Energy
East China, Michigan

Date: 1/9/2023
Note: General Site Photo
Photo 255-1 Caption:
W34, backfilling

Aerial Image: NearMap (8/10/2022)
NOTE: Photo locations are approximate.

Photo 256-1

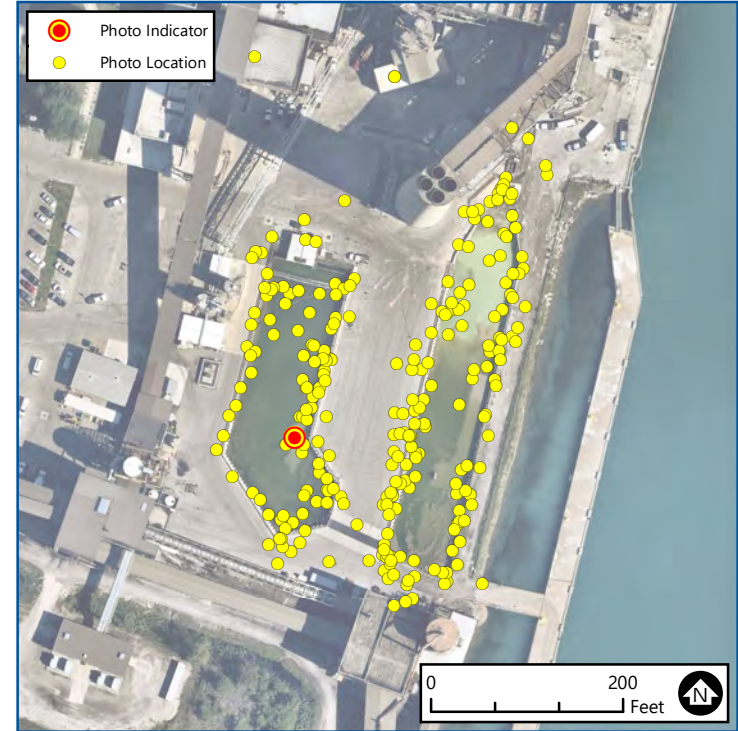
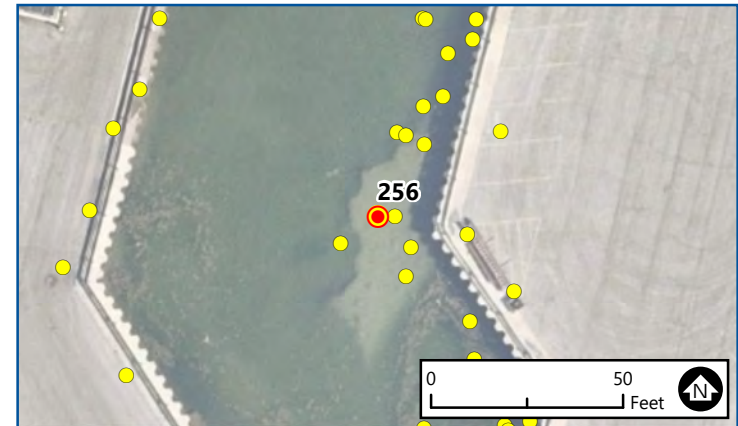

Photo 256-2



256 of 269
**CONSTRUCTION
MONITORING**
PHOTO LOCATIONS
St. Clair Power Plant
DTE Energy
East China, Michigan

Aerial Image: NearMap (8/10/2022)
NOTE: Photo locations are approximate.

Date: 12/30/2022
Note: General Site Photo

Photo 256-1 Caption:
Backfill placed and stockpiled in southern portion of West basin

Photo 256-2 Caption:
Backfill placed and stockpiled in southern portion of West basin

Photo 257-1



Photo 257-2

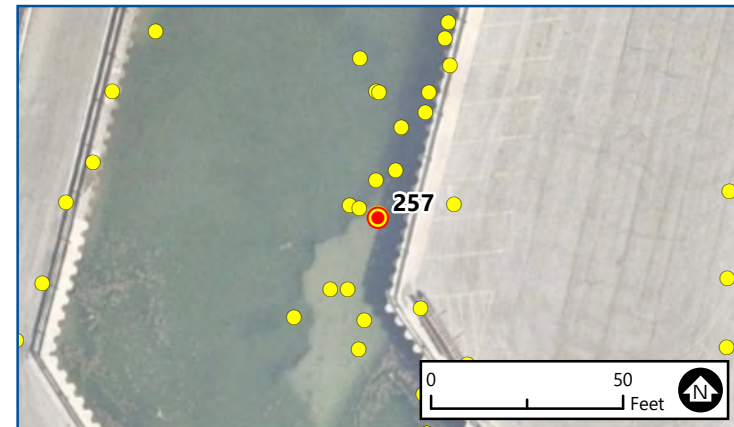

257 of 269
**CONSTRUCTION
MONITORING**
PHOTO LOCATIONS
St. Clair Power Plant
DTE Energy
East China, Michigan

Aerial Image: NearMap (8/10/2022)
NOTE: Photo locations are approximate.

Date: 12/30/2022
Note: General Site Photo

Photo 257-1 Caption:
West basin backfilling

Photo 257-2 Caption:
Example of CCR scraped from sheet pile wall in West basin

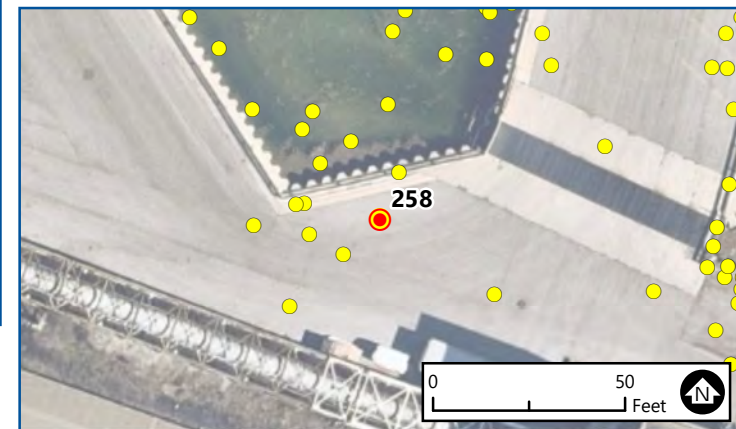

258 of 269
**CONSTRUCTION
MONITORING**
PHOTO LOCATIONS
St. Clair Power Plant
DTE Energy
East China, Michigan

Aerial Image: NearMap (8/10/2022)
NOTE: Photo locations are approximate.

Date: 12/30/2022
Note: General Site Photo

Photo 258-1 Caption:
West basin, looking north, with backfill
in foreground and CCR removal in
background

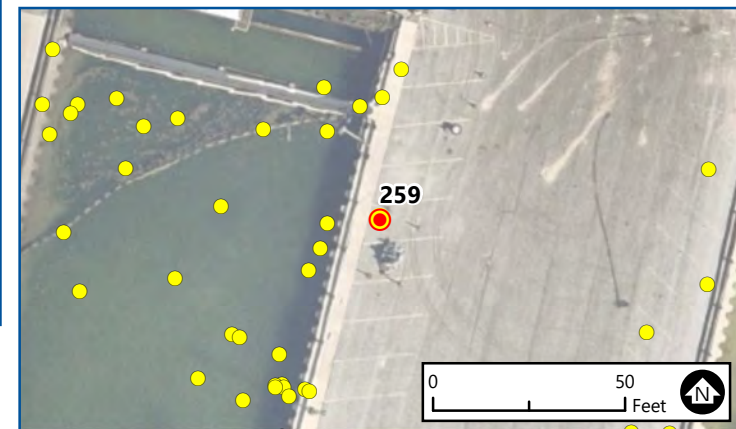

259 of 269
**CONSTRUCTION
MONITORING**
PHOTO LOCATIONS
St. Clair Power Plant
DTE Energy
East China, Michigan

Date: 1/9/2023
Note: General Site Photo
Photo 259-1 Caption:
W34 backfilling

Aerial Image: NearMap (8/10/2022)
NOTE: Photo locations are approximate.

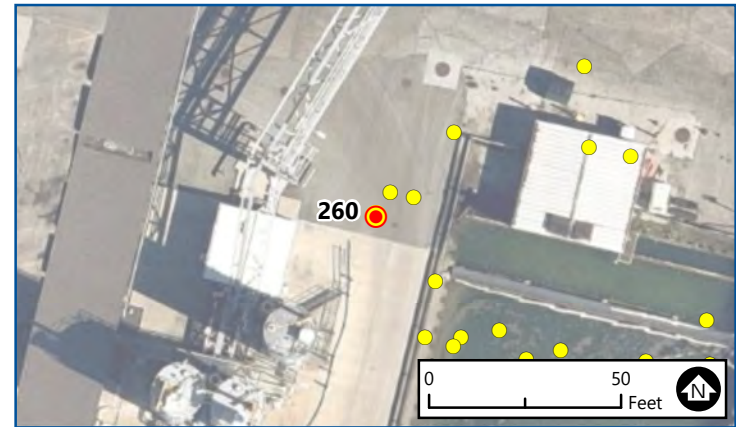
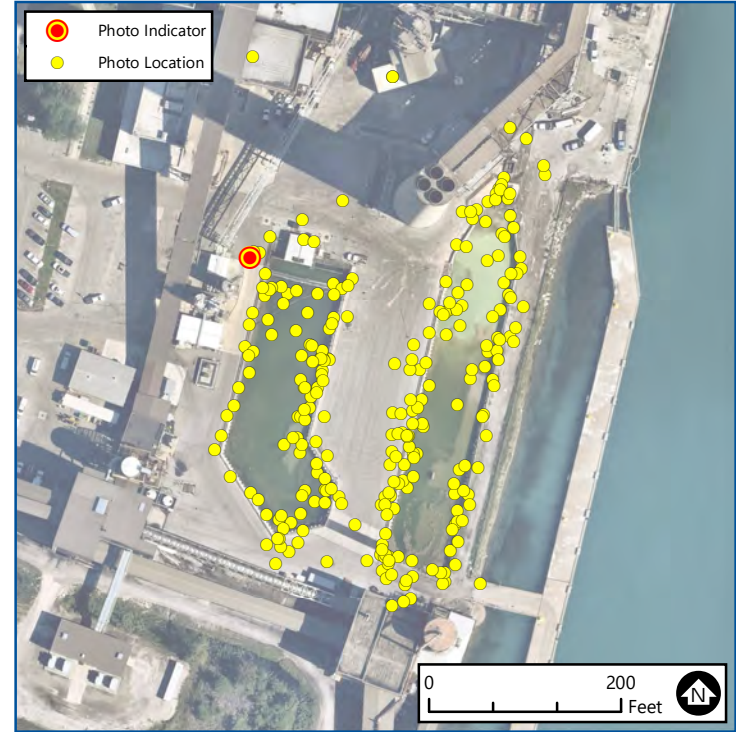

260 of 269
**CONSTRUCTION
MONITORING**
PHOTO LOCATIONS
St. Clair Power Plant
DTE Energy
East China, Michigan

Aerial Image: NearMap (8/10/2022)
NOTE: Photo locations are approximate.

Date: 1/10/2023
Note: General Site Photo
Photo 260-1 Caption:
Compaction testing at W36

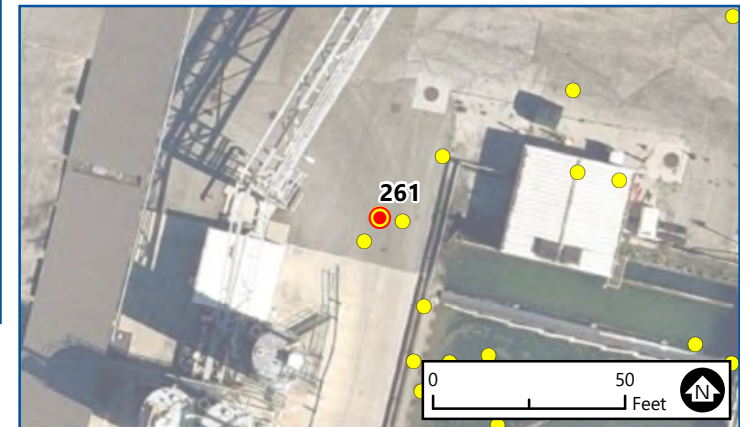
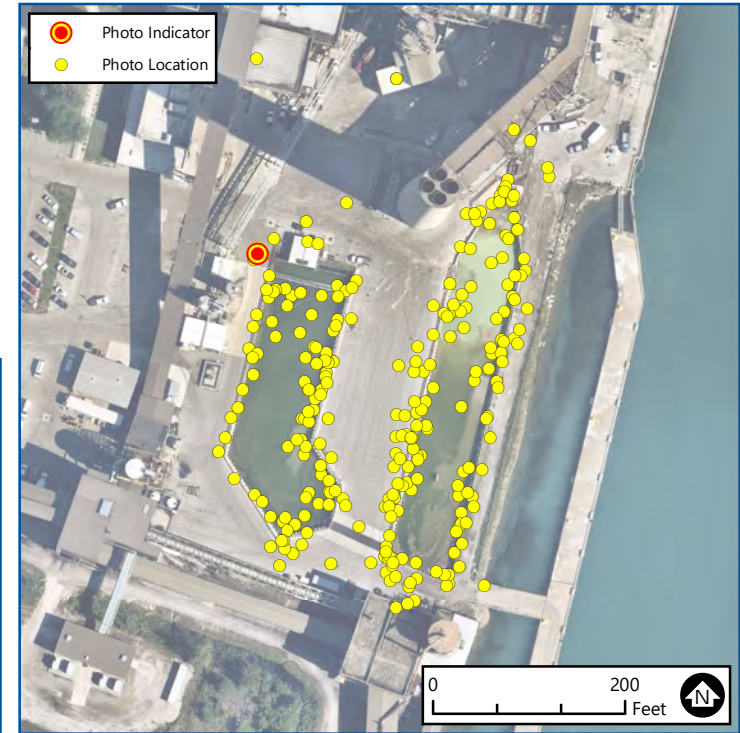

261 of 269
**CONSTRUCTION
MONITORING**
PHOTO LOCATIONS
St. Clair Power Plant
DTE Energy
East China, Michigan

Aerial Image: NearMap (8/10/2022)
NOTE: Photo locations are approximate.

Date: 1/10/2023
Note: General Site Photo

Photo 261-1 Caption:
West basin backfill activities - viewed
from north to south



Photo 262-1

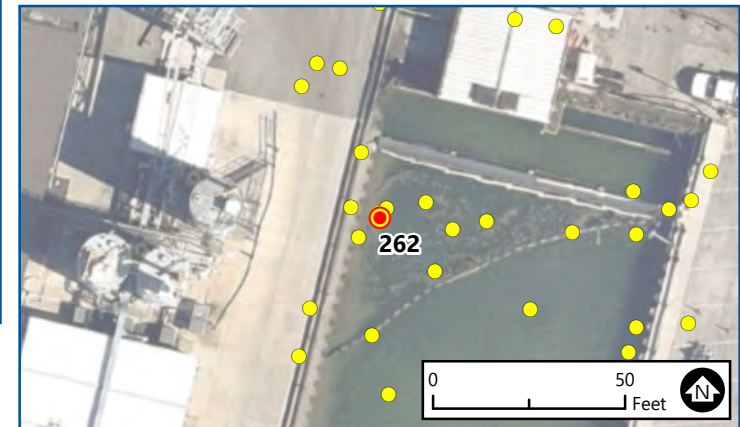

262 of 269
**CONSTRUCTION
MONITORING**
PHOTO LOCATIONS
St. Clair Power Plant
DTE Energy
East China, Michigan

Aerial Image: NearMap (8/10/2022)
NOTE: Photo locations are approximate.

Date: 1/10/2023
Note: General Site Photo

Photo 262-1 Caption:
West basin backfill activities - viewed
from north to south

Photo 263-1



Photo 263-2

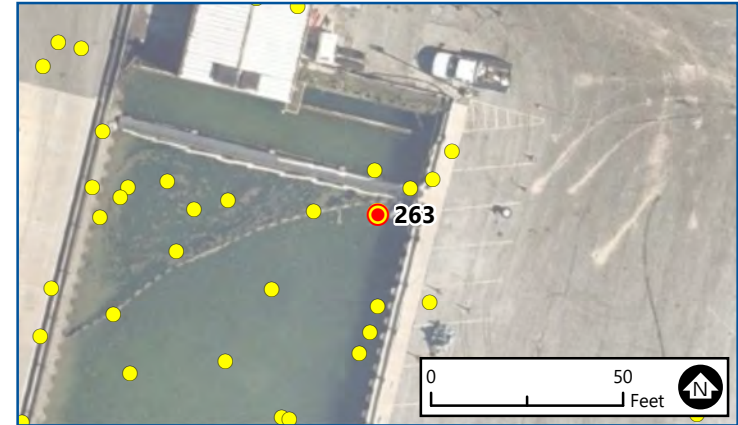

263 of 269
**CONSTRUCTION
MONITORING**
PHOTO LOCATIONS
St. Clair Power Plant
DTE Energy
East China, Michigan

Aerial Image: NearMap (8/10/2022)
NOTE: Photo locations are approximate.

Date: 1/10/2023
Note: General Site Photo

Photo 263-1 Caption:
West basin backfilling, looking south

Photo 263-2 Caption:
West basin backfilling, looking east



Photo 264-1

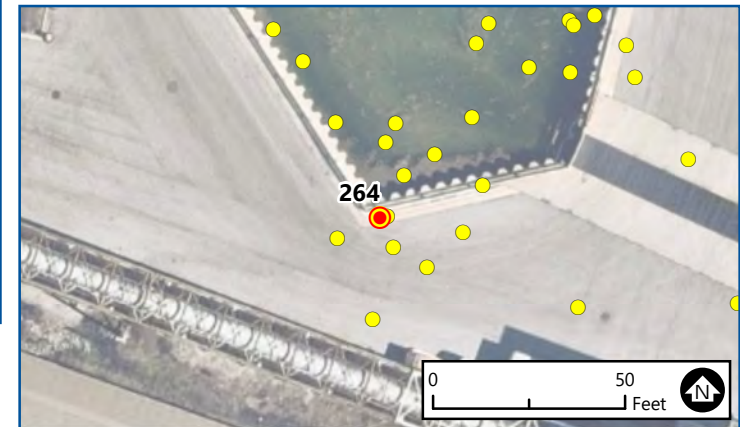

264 of 269
**CONSTRUCTION
MONITORING**
PHOTO LOCATIONS
St. Clair Power Plant
DTE Energy
East China, Michigan

Aerial Image: NearMap (8/10/2022)
NOTE: Photo locations are approximate.

Date: 1/10/2023
Note: General Site Photo
Photo 264-1 Caption:
West basin backfilling, looking north

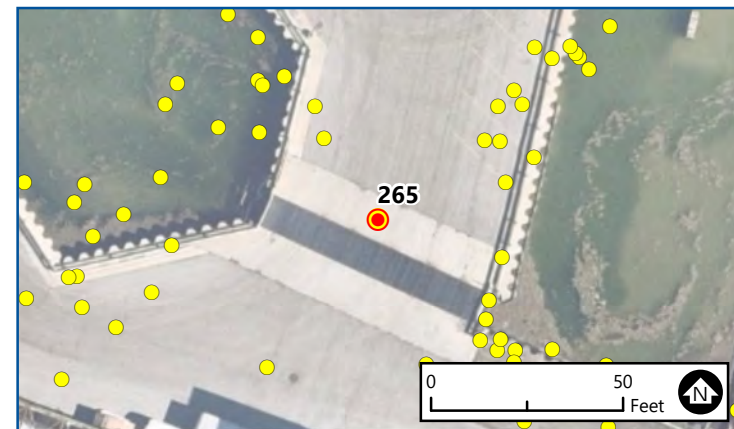

265 of 269
**CONSTRUCTION
MONITORING**
PHOTO LOCATIONS
St. Clair Power Plant
DTE Energy
East China, Michigan

Aerial Image: NearMap (8/10/2022)
NOTE: Photo locations are approximate.

Date: 1/11/2023
Note: General Site Photo

Photo 265-1 Caption:
CCR removed from the canal between
the East and West basin by hydro-
excavation and backfilled

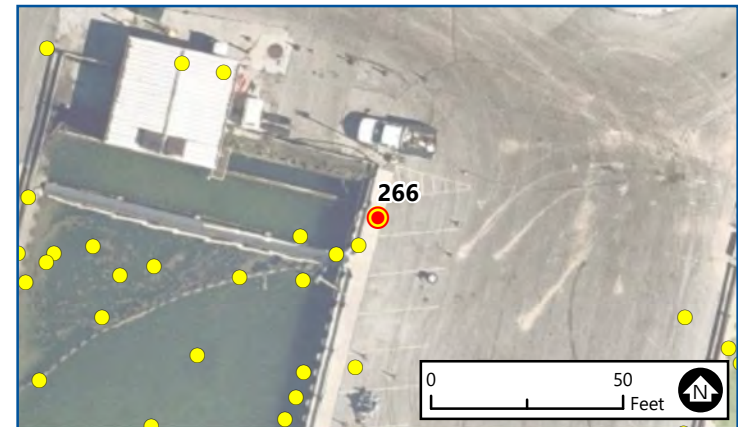

266 of 269
**CONSTRUCTION
MONITORING**
PHOTO LOCATIONS
St. Clair Power Plant
DTE Energy
East China, Michigan

Aerial Image: NearMap (8/10/2022)
NOTE: Photo locations are approximate.

Date: 2/15/2023
Note: General Site Photo

Photo 266-1 Caption:
CCR removed from behind the West
basin weir wall by hydro excavation and
a new storm water pipe was installed

Photo 267-1



Photo 267-2

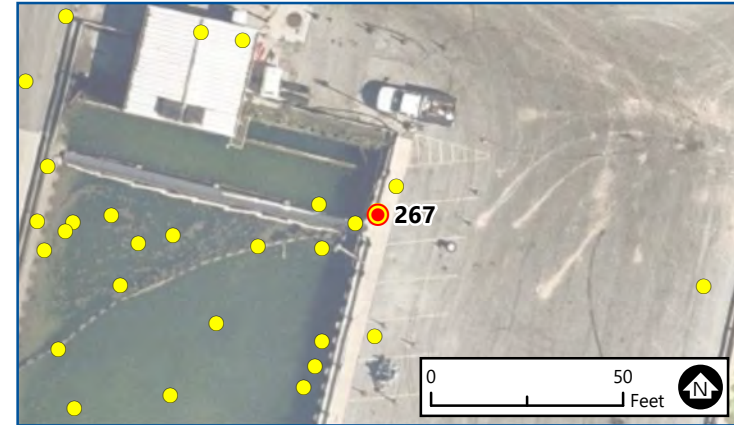

267 of 269
**CONSTRUCTION
MONITORING**
PHOTO LOCATIONS
St. Clair Power Plant
DTE Energy
East China, Michigan

Aerial Image: NearMap (8/10/2022)
NOTE: Photo locations are approximate.

Date: 2/24/2023
Note: Site Restoration

Photo 267-1 Caption:
Area behind the weir and around stormwater pipe backfilled, and a catch basin installed

Photo 267-2 Caption:
Catch basin installed

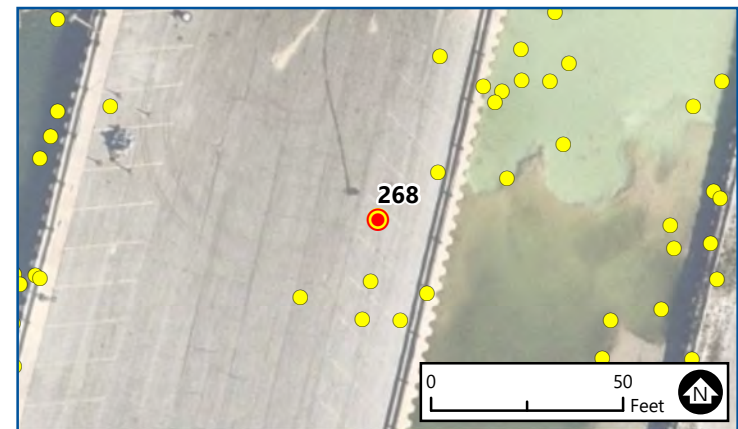

268 of 269
**CONSTRUCTION
MONITORING**
PHOTO LOCATIONS
St. Clair Power Plant
DTE Energy
East China, Michigan

Aerial Image: NearMap (8/10/2022)
NOTE: Photo locations are approximate.

Date: 5/19/2023
Note: Site Restoration

Photo 268-1 Caption:
East basin topsoil, seed, and mulch
applied, looking south



Photo 269-1

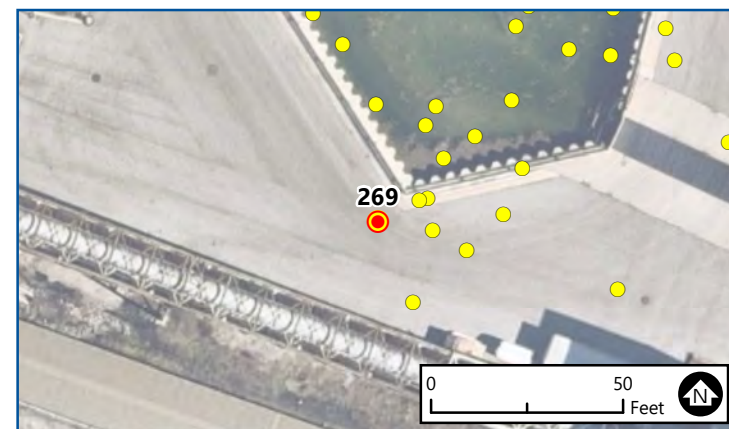
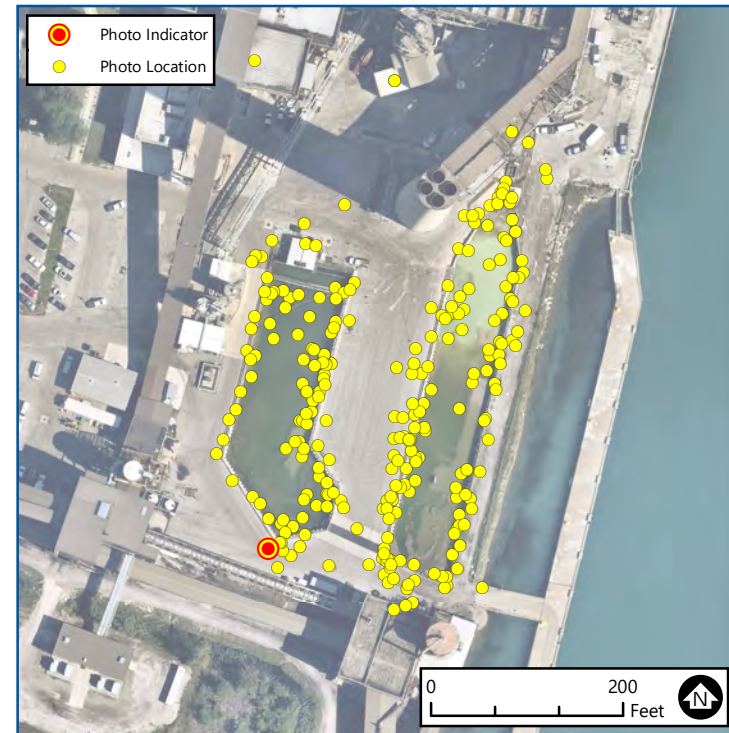

269 of 269
**CONSTRUCTION
MONITORING**
PHOTO LOCATIONS
St. Clair Power Plant
DTE Energy
East China, Michigan

Aerial Image: NearMap (8/10/2022)
NOTE: Photo locations are approximate.

Date: 5/19/2023
Note: Site Restoration

Photo 269-1 Caption:
West basin topsoil, seed, and mulch
applied, looking north

Appendix D

Excavated Extent Survey

Surveyed Elevations for the Base of the Excavations



Appendix E

Backfill Data

Appendix E - 1 Backfill Physical Properties

McDowell & Associates

Geotechnical, Environmental & Hydrogeological Services • Materials Testing & Inspection

21355 Hatcher Avenue, Ferndale, MI 48220
Phone: (248) 399-2066 • Fax: (248) 399-2157
www.mcdowasc.com

August 8, 2022

BMJ Engineers and Surveyors, Inc.
519 Huron Avenue
Port Huron, Michigan 48060

Job No. 22-310

Attention: Mr. Patrick Phelan

Subject: Stockpile Soil Testing
MAGNA Facility Site
1811 South Range Road
St. Clair, Michigan

Gentlemen:

In accordance with your request, our field representative collected three (3) representative samples of the stockpile at the above referenced site. Mr. Duke Dunn of Raymond Excavating met our representative on July 25, 2022 and showed him where to collect our samples.

An Atterberg Limit Test (ASTM D-4318), a Particle Size Distribution Test (ASTM D-422) and a Modified Proctor Test (ASTM D-1557) were performed on each of the three (3) samples.

The test results are presented on the attached Atterberg Limit Test Summary, Gradation Curves and Moisture-Density Relationship (Modified Proctor) Curves.

It appears the samples can be classified according to ASTM as low plasticity clay "CL" with a maximum dry density of 123.6 to 128.9 pounds per cubic foot (pcf) and an optimum moisture of 9.3% to 14.0%.

If you have any questions or if we can be of any further service, please feel free to call.

Very truly yours,

McDOWELL & ASSOCIATES

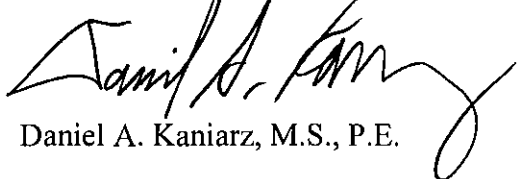

Daniel A. Kaniarz, M.S., P.E.

DAK/jb

Mid-Michigan Office

3730 James Savage Road, Midland, MI 48642
Phone: (989) 496-3610 • Fax: (989) 496-3190

Atterberg Limit Test Summary

Sample	Liquid Limit (%)	Plastic Limit (%)	Plasticity Index (%)	ASTM Classification
1	28.3	13.3	15.0	CL
2	30.63	15.2	15.4	CL
3	27.5	12.8	14.7	CL

Gradation Curve

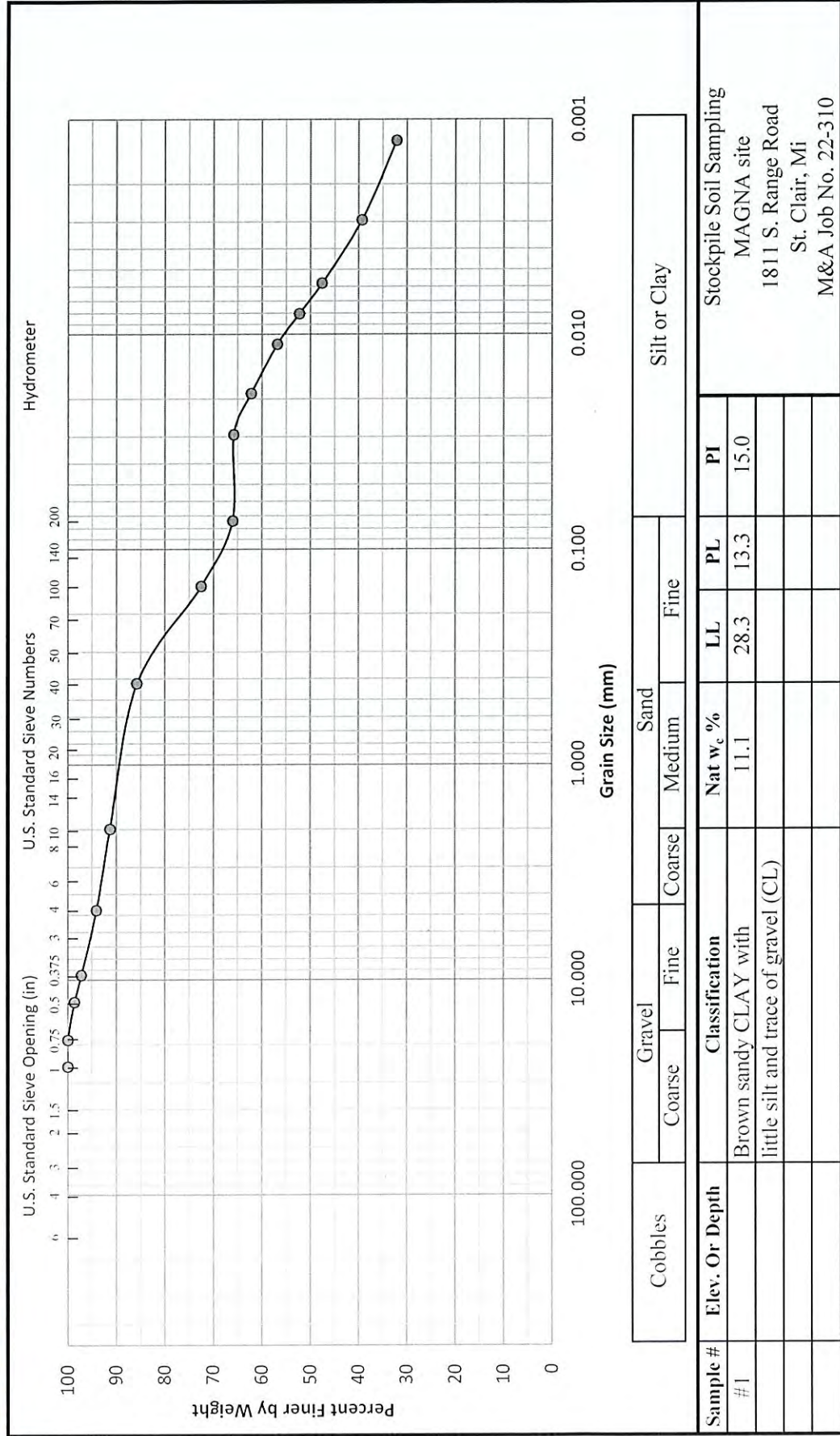

Stockpile Soil Sampling
 MAGNA site
 1811 S. Range Road
 St. Clair, Mi
 M&A Job No. 22-310

Gradation Curve

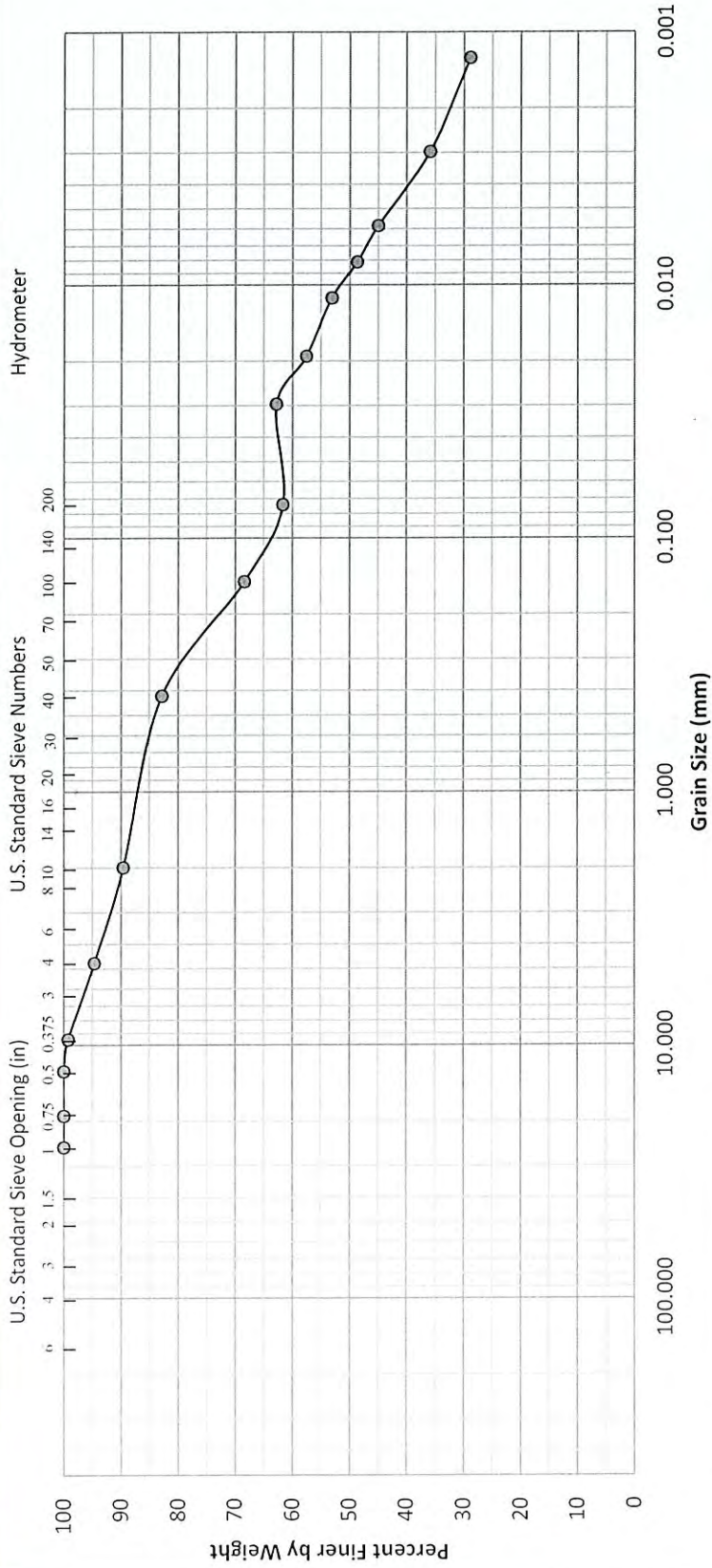

Sample #	Elev. Or Depth	Classification	Sand			PI
			Nat w _c %	LL	PL	
#2		Brown sandy CLAY with little silt and trace of gravel (CL)	12.9	30.6	15.2	15.4

Cobbles	Gravel	Coarse	Medium	Fine	Silt or Clay
---------	--------	--------	--------	------	--------------

Stockpile Soil Sampling MAGNA site 1811 S. Range Road St. Clair, Mi	M&A Job No. 22-310
--	--------------------

Gradation Curve

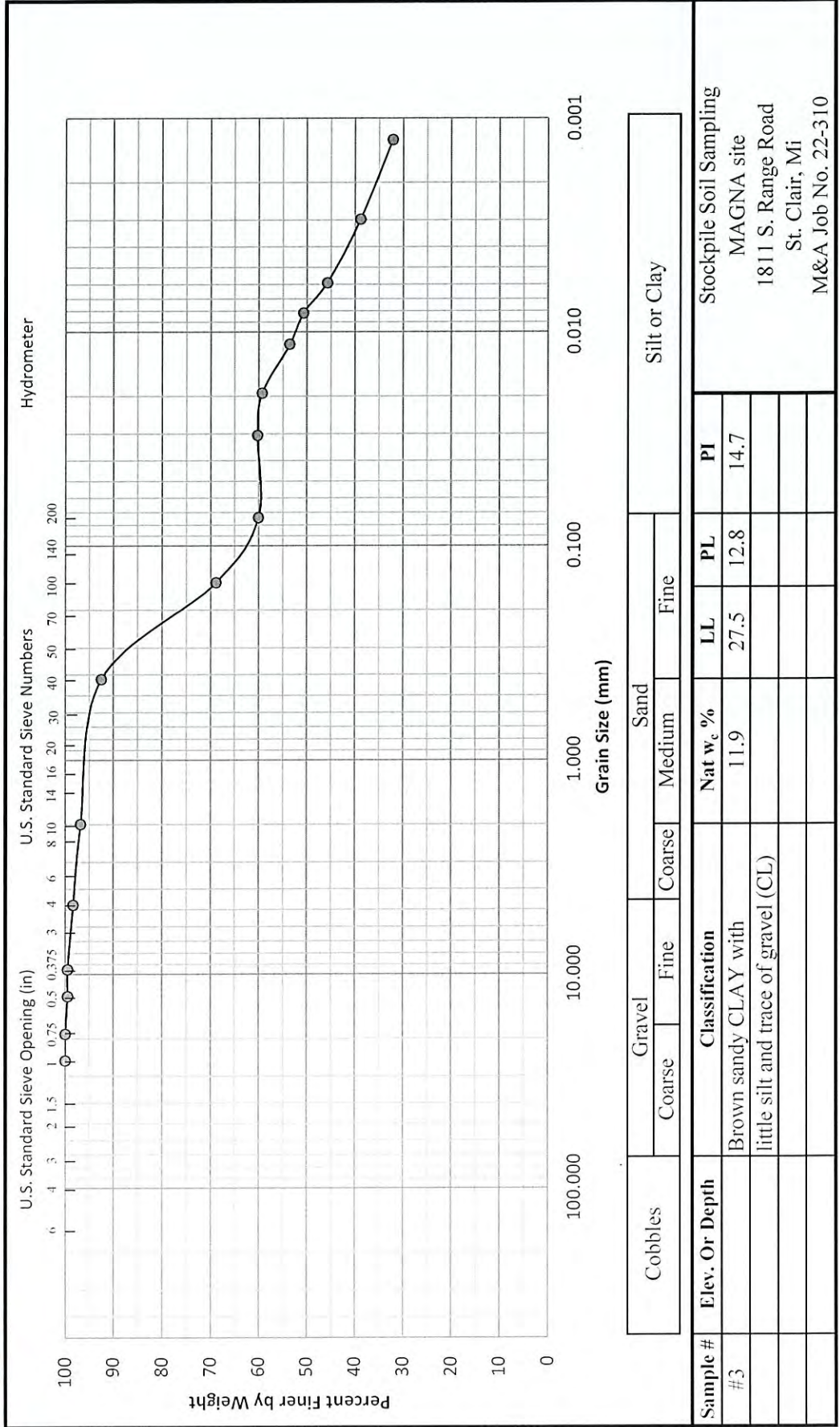

Sample #	Elev. Or Depth	Classification	Nat w _c %	LL	PL	PI
#3		Brown sandy CLAY with little silt and trace of gravel (CL)	11.9	27.5	12.8	14.7

Stockpile Soil Sampling
 MAGNA site
 1811 S. Range Road
 St. Clair, Mi
 M&A Job No. 22-310



Moisture - Density Relationship

Project Name: Stockpile Testing
Project No.: 22-310
Date Tested: 7/29/2022
Source: #2
Utilization:
Description: Brown Sandy Clay

Sample No:
Test Procedure: ASTM D-1557
Test Method: A
Maximum Dry Density: 123.6 pcf
Optimum Moisture: 14.0 %
Tested By: DB

Moisture - Density Relationship

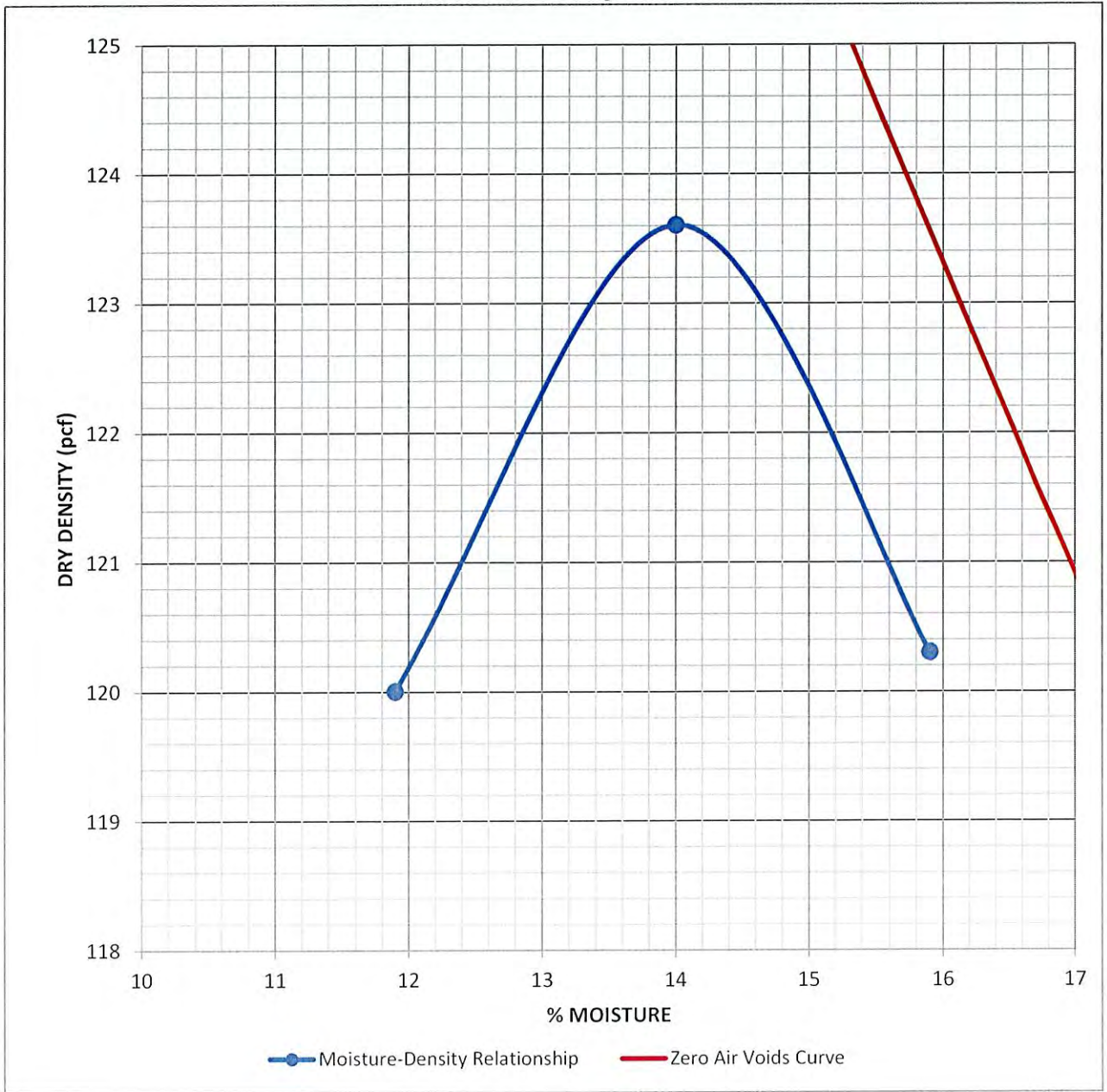



Moisture - Density Relationship

Project Name: Stockpile Testing
Project No.: 22-310
Date Tested: 7/27/2022
Source: Stockpile #1
Utilization:
Description: Brown Clay

Sample No:
Test Procedure: ASTM D-1557
Test Method: A
Maximum Dry Density: 124.2 pcf
Optimum Moisture: 9.3 %
Tested By: DB

Moisture - Density Relationship

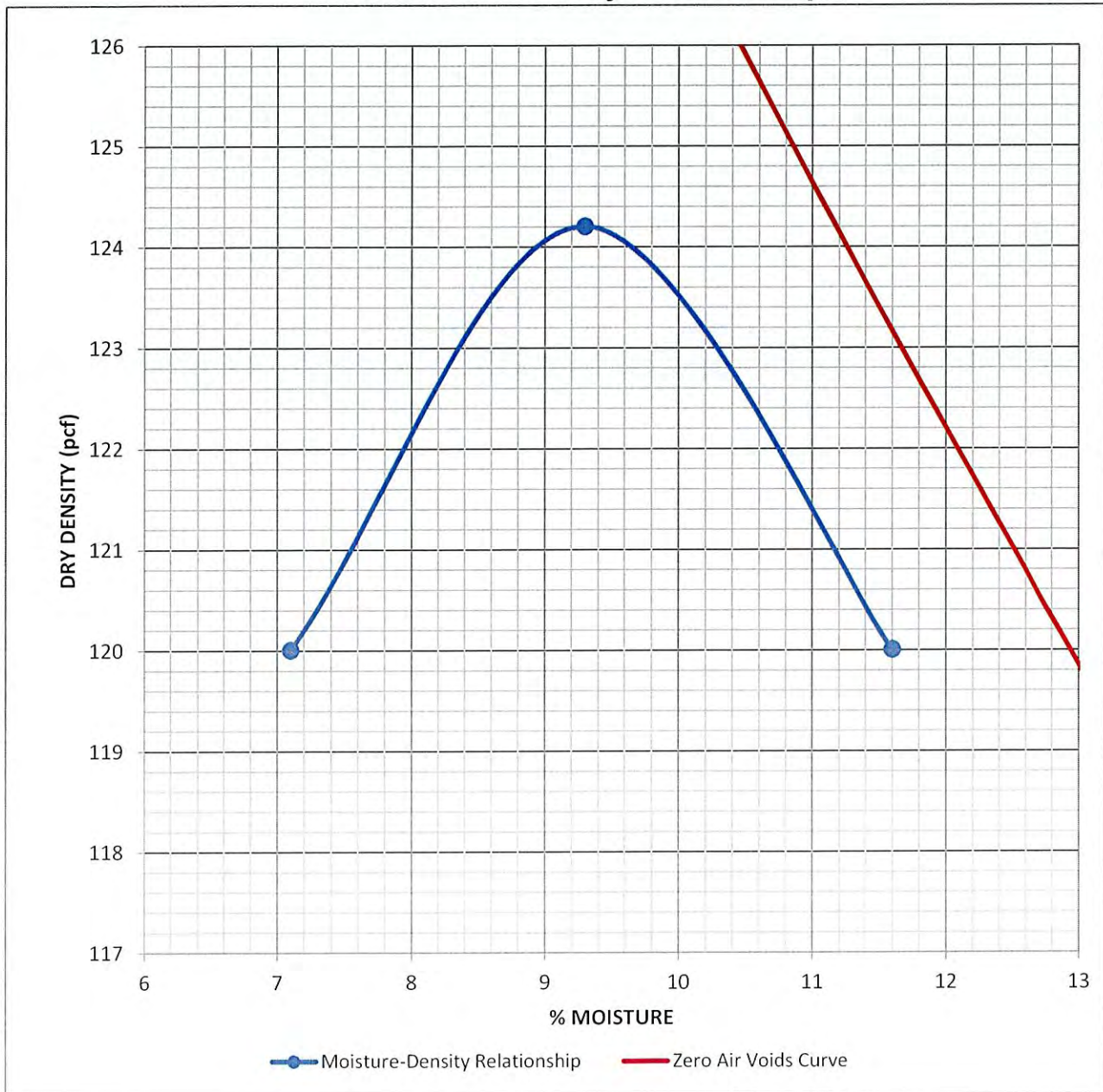



Moisture - Density Relationship

Project Name: Stockpile Testing
Project No.: 22-310
Date Tested: 8/4/2022
Source: #3
Utilization:
Description: Brown Clay

Sample No:
Test Procedure: ASTM D-1557
Test Method: A
Maximum Dry Density: 128.9 pcf
Optimum Moisture: 10.5 %
Tested By: DB

Moisture - Density Relationship

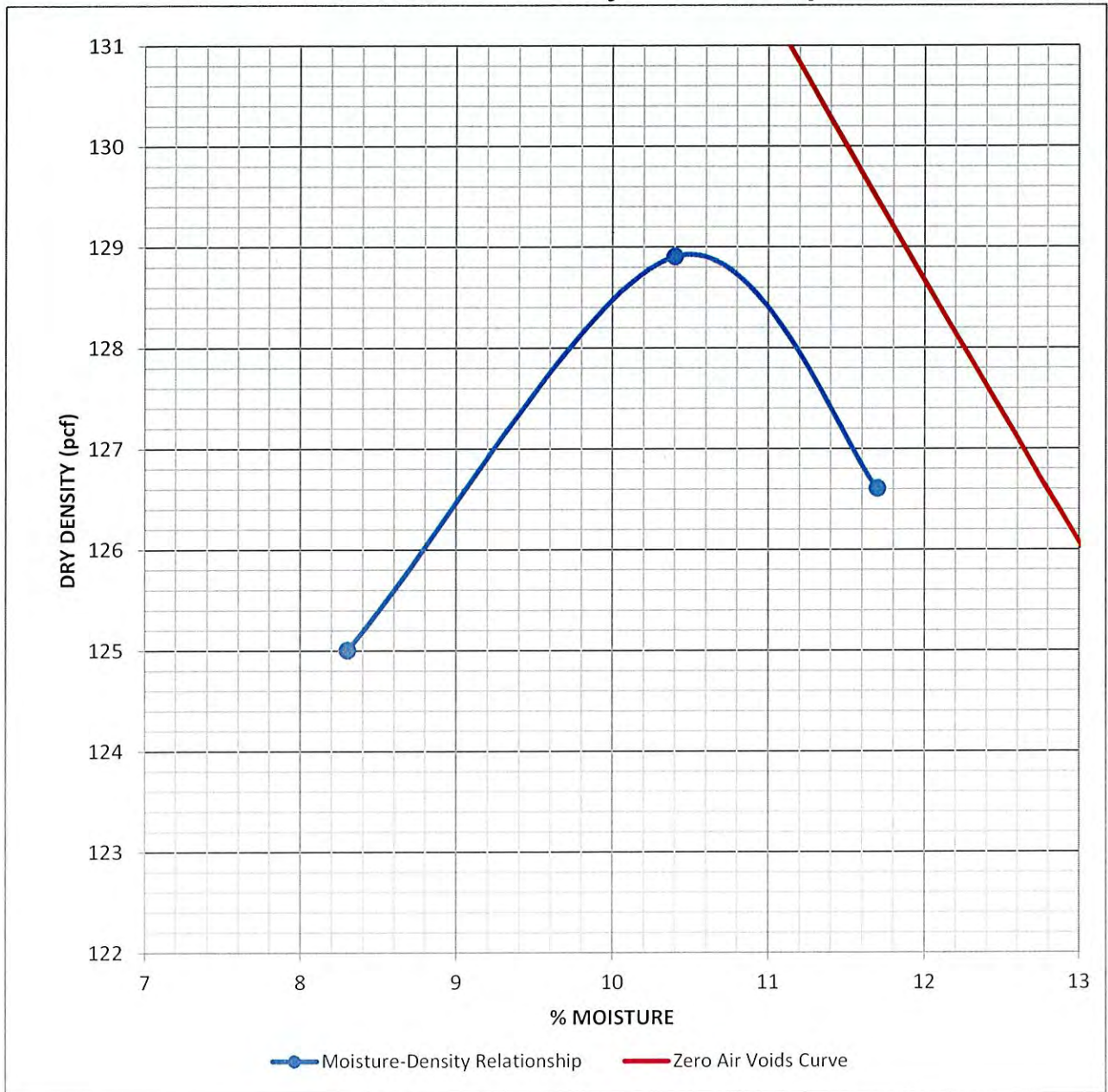

Appendix E - 2 Analytical Results

Integrated Environmental

Sample Delivery Group: L1518962
Samples Received: 07/27/2022
Project Number: 348001
Description:

Report To: Nikki Mckenna
21435 Gill Road
Farmington Hills, MI 48335

Entire Report Reviewed By:



John Hawkins
Project Manager

Results relate only to the items tested or calibrated and are reported as rounded values. This test report shall not be reproduced, except in full, without written approval of the laboratory. Where applicable, sampling conducted by Pace Analytical National is performed per guidance provided in laboratory standard operating procedures ENV-SOP-MTJL-0067 and ENV-SOP-MTJL-0068. Where sampling conducted by the customer, results relate to the accuracy of the information provided, and as the samples are received.

Pace Analytical National

12065 Lebanon Rd Mount Juliet, TN 37122 615-758-5858 800-767-5859 www.pacenational.com

TABLE OF CONTENTS

Cp: Cover Page	1	1 Cp
Tc: Table of Contents	2	
Ss: Sample Summary	3	2 Tc
Cn: Case Narrative	4	
Sr: Sample Results	5	3 Ss
SSP-1 L1518962-01	5	
ESP-2 L1518962-02	7	4 Cn
NSP-3 L1518962-03	9	5 Sr
Qc: Quality Control Summary	11	
Total Solids by Method 2540 G-2011	11	6 Qc
Semi-Volatile Organic Compounds (LCMS) by Method SW-846 8321	12	
OP Pesticides by Method 8141	14	7 Gl
Pesticides (GC) by Method 8081	17	
Gl: Glossary of Terms	19	8 Al
Al: Accreditations & Locations	20	
Sc: Sample Chain of Custody	21	9 Sc

SAMPLE SUMMARY

SSP-1 L1518962-01 Solid

Collected by: Nikki McKenna
 Collected date/time: 07/25/22 10:05
 Received date/time: 07/27/22 09:00

Method	Batch	Dilution	Preparation date/time	Analysis date/time	Analyst	Location
Total Solids by Method 2540 G-2011	WG1902057	1	07/28/22 11:47	07/28/22 12:03	CMK	Mt. Juliet, TN
Semi-Volatile Organic Compounds (LCMS) by Method SW-846 8321	WG1903819	1	08/02/22 08:21	08/02/22 17:15	GKM	Mt. Juliet, TN
OP Pesticides by Method 8141	WG1902909	1	07/29/22 17:30	07/30/22 06:51	HLA	Mt. Juliet, TN
Pesticides (GC) by Method 8081	WG1902902	1	07/29/22 17:33	07/30/22 05:03	JMB	Mt. Juliet, TN

1 Cp

2 Tc

3 Ss

4 Cn

5 Sr

6 Qc

7 Gl

8 Al

9 Sc

ESP-2 L1518962-02 Solid

Collected by: Nikki McKenna
 Collected date/time: 07/25/22 10:07
 Received date/time: 07/27/22 09:00

Method	Batch	Dilution	Preparation date/time	Analysis date/time	Analyst	Location
Total Solids by Method 2540 G-2011	WG1902057	1	07/28/22 11:47	07/28/22 12:03	CMK	Mt. Juliet, TN
Semi-Volatile Organic Compounds (LCMS) by Method SW-846 8321	WG1903819	1	08/02/22 08:21	08/02/22 20:50	GKM	Mt. Juliet, TN
OP Pesticides by Method 8141	WG1902909	1	07/29/22 17:30	07/30/22 08:31	HLA	Mt. Juliet, TN
Pesticides (GC) by Method 8081	WG1902902	1	07/29/22 17:33	07/30/22 05:15	JMB	Mt. Juliet, TN

NSP-3 L1518962-03 Solid

Collected by: Nikki McKenna
 Collected date/time: 07/25/22 10:09
 Received date/time: 07/27/22 09:00

Method	Batch	Dilution	Preparation date/time	Analysis date/time	Analyst	Location
Total Solids by Method 2540 G-2011	WG1902057	1	07/28/22 11:47	07/28/22 12:03	CMK	Mt. Juliet, TN
Semi-Volatile Organic Compounds (LCMS) by Method SW-846 8321	WG1903819	1	08/02/22 08:21	08/02/22 21:08	GKM	Mt. Juliet, TN
OP Pesticides by Method 8141	WG1902909	1	07/29/22 17:30	07/30/22 09:05	HLA	Mt. Juliet, TN
Pesticides (GC) by Method 8081	WG1902902	1	07/29/22 17:33	08/01/22 15:10	AMM	Mt. Juliet, TN

CASE NARRATIVE

All sample aliquots were received at the correct temperature, in the proper containers, with the appropriate preservatives, and within method specified holding times, unless qualified or notated within the report. Where applicable, all MDL (LOD) and RDL (LOQ) values reported for environmental samples have been corrected for the dilution factor used in the analysis. All Method and Batch Quality Control are within established criteria except where addressed in this case narrative, a non-conformance form or properly qualified within the sample results. By my digital signature below, I affirm to the best of my knowledge, all problems/anomalies observed by the laboratory as having the potential to affect the quality of the data have been identified by the laboratory, and no information or data have been knowingly withheld that would affect the quality of the data.



John Hawkins
Project Manager

¹ Cp

² Tc

³ Ss

⁴ Cn

⁵ Sr

⁶ Qc

⁷ Gl

⁸ Al

⁹ Sc

Total Solids by Method 2540 G-2011

Analyte	Result	Qualifier	Dilution	Analysis	Batch
Total Solids	85.1		1	07/28/2022 12:03	WG1902057

Semi-Volatile Organic Compounds (LCMS) by Method SW-846 8321

Analyte	Result (dry)	Qualifier	MDL (dry)	RDL (dry)	Dilution	Analysis	Batch
2,4-D	U		0.00609	0.0235	1	08/02/2022 17:15	WG1903819
Dalapon	U		0.00372	0.0235	1	08/02/2022 17:15	WG1903819
2,4-DB	U	J5	0.0107	0.0235	1	08/02/2022 17:15	WG1903819
Dicamba	U	J5	0.00506	0.0235	1	08/02/2022 17:15	WG1903819
Dichloroprop	U		0.00391	0.0235	1	08/02/2022 17:15	WG1903819
Dinoseb	U		0.00234	0.0235	1	08/02/2022 17:15	WG1903819
MCPA	U		0.00402	0.0235	1	08/02/2022 17:15	WG1903819
MCPP	U		0.00275	0.0235	1	08/02/2022 17:15	WG1903819
2,4,5-T	U		0.00806	0.0235	1	08/02/2022 17:15	WG1903819
2,4,5-TP (Silvex)	U		0.00201	0.0235	1	08/02/2022 17:15	WG1903819
(S) 2,4-DB-D3	124			70.0-130		08/02/2022 17:15	WG1903819

OP Pesticides by Method 8141

Analyte	Result (dry)	Qualifier	MDL (dry)	RDL (dry)	Dilution	Analysis	Batch
Azinphos-Methyl	U		0.0374	0.117	1	07/30/2022 06:51	WG1902909
Bolstar (Sulprofos)	U		0.0175	0.117	1	07/30/2022 06:51	WG1902909
Chlorpyrifos	U		0.0184	0.117	1	07/30/2022 06:51	WG1902909
Coumaphos	U		0.0285	0.117	1	07/30/2022 06:51	WG1902909
Demeton,-O and -S	U		0.00686	0.0822	1	07/30/2022 06:51	WG1902909
Diazinon	U		0.0264	0.117	1	07/30/2022 06:51	WG1902909
Dichlorvos	U		0.0352	0.117	1	07/30/2022 06:51	WG1902909
Dimethoate	U		0.0392	0.117	1	07/30/2022 06:51	WG1902909
Disulfoton	U		0.0298	0.117	1	07/30/2022 06:51	WG1902909
EPN	U		0.0324	0.117	1	07/30/2022 06:51	WG1902909
Ethoprop	U		0.0139	0.117	1	07/30/2022 06:51	WG1902909
Ethyl Parathion	U		0.0193	0.117	1	07/30/2022 06:51	WG1902909
Fensulfothion	U		0.0415	0.117	1	07/30/2022 06:51	WG1902909
Fenthion	U		0.0156	0.117	1	07/30/2022 06:51	WG1902909
Malathion	U		0.0210	0.117	1	07/30/2022 06:51	WG1902909
Merphos	U		0.0273	0.117	1	07/30/2022 06:51	WG1902909
Methyl parathion	U		0.0238	0.117	1	07/30/2022 06:51	WG1902909
Mevinphos	U		0.0270	0.117	1	07/30/2022 06:51	WG1902909
Naled	U		0.0564	0.117	1	07/30/2022 06:51	WG1902909
Phorate	U		0.0247	0.117	1	07/30/2022 06:51	WG1902909
Ronnel	U		0.0175	0.117	1	07/30/2022 06:51	WG1902909
Stirophos	U		0.0209	0.117	1	07/30/2022 06:51	WG1902909
Sulfotep	U		0.0116	0.117	1	07/30/2022 06:51	WG1902909
TEPP	U		0.184	1.17	1	07/30/2022 06:51	WG1902909
Tokuthion (Prothothiofos)	U		0.0176	0.117	1	07/30/2022 06:51	WG1902909
Trichloronate	U		0.0236	0.117	1	07/30/2022 06:51	WG1902909
(S) Triphenyl Phosphate	86.6			36.0-121		07/30/2022 06:51	WG1902909

Pesticides (GC) by Method 8081

Analyte	Result (dry)	Qualifier	MDL (dry)	RDL (dry)	Dilution	Analysis	Batch
Aldrin	U		0.00442	0.0235	1	07/30/2022 05:03	WG1902902
Alpha BHC	U		0.00432	0.0235	1	07/30/2022 05:03	WG1902902
Beta BHC	U		0.00445	0.0235	1	07/30/2022 05:03	WG1902902

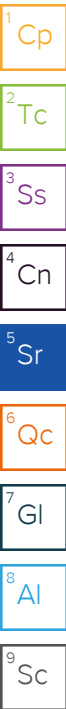

Pesticides (GC) by Method 8081

Analyte	Result (dry) mg/kg	Qualifier	MDL (dry) mg/kg	RDL (dry) mg/kg	Dilution	Analysis date / time	Batch
Delta BHC	U		0.00406	0.0235	1	07/30/2022 05:03	WG1902902
Gamma BHC	U		0.00404	0.0235	1	07/30/2022 05:03	WG1902902
Chlordane	U		0.121	0.352	1	07/30/2022 05:03	WG1902902
4,4-DDD	U		0.00435	0.0235	1	07/30/2022 05:03	WG1902902
4,4-DDE	U		0.00430	0.0235	1	07/30/2022 05:03	WG1902902
4,4-DDT	U		0.00737	0.0235	1	07/30/2022 05:03	WG1902902
Dieldrin	U		0.00404	0.0235	1	07/30/2022 05:03	WG1902902
Endosulfan I	U		0.00426	0.0235	1	07/30/2022 05:03	WG1902902
Endosulfan II	U		0.00394	0.0235	1	07/30/2022 05:03	WG1902902
Endosulfan sulfate	U		0.00428	0.0235	1	07/30/2022 05:03	WG1902902
Endrin	U		0.00411	0.0235	1	07/30/2022 05:03	WG1902902
Endrin aldehyde	U		0.00398	0.0235	1	07/30/2022 05:03	WG1902902
Endrin ketone	U		0.00835	0.0235	1	07/30/2022 05:03	WG1902902
Hexachlorobenzene	U		0.00406	0.0235	1	07/30/2022 05:03	WG1902902
Heptachlor	U		0.00503	0.0235	1	07/30/2022 05:03	WG1902902
Heptachlor epoxide	U		0.00398	0.0235	1	07/30/2022 05:03	WG1902902
Methoxychlor	U		0.00569	0.0235	1	07/30/2022 05:03	WG1902902
Toxaphene	U		0.146	0.470	1	07/30/2022 05:03	WG1902902
(S) Decachlorobiphenyl	80.6			10.0-135		07/30/2022 05:03	WG1902902
(S) Tetrachloro-m-xylene	64.3			10.0-139		07/30/2022 05:03	WG1902902

1
Cp

2
Tc

3
Ss

4
Cn

5
Sr

6
Qc

7
Gl

8
Al

9
Sc

Total Solids by Method 2540 G-2011

Analyte	Result	Qualifier	Dilution	Analysis	Batch
	%			date / time	
Total Solids	77.3		1	07/28/2022 12:03	WG1902057

Semi-Volatile Organic Compounds (LCMS) by Method SW-846 8321

Analyte	Result (dry)	Qualifier	MDL (dry)	RDL (dry)	Dilution	Analysis	Batch
	mg/kg		mg/kg	mg/kg		date / time	
2,4-D	U		0.00670	0.0259	1	08/02/2022 20:50	WG1903819
Dalapon	U		0.00410	0.0259	1	08/02/2022 20:50	WG1903819
2,4-DB	U		0.0118	0.0259	1	08/02/2022 20:50	WG1903819
Dicamba	U		0.00558	0.0259	1	08/02/2022 20:50	WG1903819
Dichloroprop	U		0.00431	0.0259	1	08/02/2022 20:50	WG1903819
Dinoseb	U		0.00258	0.0259	1	08/02/2022 20:50	WG1903819
MCPA	U		0.00443	0.0259	1	08/02/2022 20:50	WG1903819
MCPP	U		0.00303	0.0259	1	08/02/2022 20:50	WG1903819
2,4,5-T	U		0.00888	0.0259	1	08/02/2022 20:50	WG1903819
2,4,5-TP (Silvex)	U		0.00221	0.0259	1	08/02/2022 20:50	WG1903819
(S) 2,4-DB-D3	118			70.0-130		08/02/2022 20:50	WG1903819

OP Pesticides by Method 8141

Analyte	Result (dry)	Qualifier	MDL (dry)	RDL (dry)	Dilution	Analysis	Batch
	mg/kg		mg/kg	mg/kg		date / time	
Azinphos-Methyl	U		0.0412	0.129	1	07/30/2022 08:31	WG1902909
Bolstar (Sulprofos)	U		0.0193	0.129	1	07/30/2022 08:31	WG1902909
Chlorpyrifos	U		0.0203	0.129	1	07/30/2022 08:31	WG1902909
Coumaphos	U		0.0314	0.129	1	07/30/2022 08:31	WG1902909
Demeton,-O and -S	U		0.00756	0.0906	1	07/30/2022 08:31	WG1902909
Diazinon	U		0.0291	0.129	1	07/30/2022 08:31	WG1902909
Dichlorvos	U		0.0388	0.129	1	07/30/2022 08:31	WG1902909
Dimethoate	U		0.0432	0.129	1	07/30/2022 08:31	WG1902909
Disulfoton	U		0.0329	0.129	1	07/30/2022 08:31	WG1902909
EPN	U		0.0357	0.129	1	07/30/2022 08:31	WG1902909
Ethoprop	U		0.0153	0.129	1	07/30/2022 08:31	WG1902909
Ethyl Parathion	U		0.0212	0.129	1	07/30/2022 08:31	WG1902909
Fensulfothion	U		0.0457	0.129	1	07/30/2022 08:31	WG1902909
Fenthion	U		0.0172	0.129	1	07/30/2022 08:31	WG1902909
Malathion	U		0.0232	0.129	1	07/30/2022 08:31	WG1902909
Merphos	U		0.0300	0.129	1	07/30/2022 08:31	WG1902909
Methyl parathion	U		0.0263	0.129	1	07/30/2022 08:31	WG1902909
Mevinphos	U		0.0298	0.129	1	07/30/2022 08:31	WG1902909
Naled	U		0.0621	0.129	1	07/30/2022 08:31	WG1902909
Phorate	U		0.0272	0.129	1	07/30/2022 08:31	WG1902909
Ronnel	U		0.0193	0.129	1	07/30/2022 08:31	WG1902909
Stirophos	U		0.0230	0.129	1	07/30/2022 08:31	WG1902909
Sulfotep	U		0.0128	0.129	1	07/30/2022 08:31	WG1902909
TEPP	U		0.203	1.29	1	07/30/2022 08:31	WG1902909
Tokuthion (Prothothiofos)	U		0.0194	0.129	1	07/30/2022 08:31	WG1902909
Trichloronate	U		0.0260	0.129	1	07/30/2022 08:31	WG1902909
(S) Triphenyl Phosphate	78.0			36.0-121		07/30/2022 08:31	WG1902909

Pesticides (GC) by Method 8081

Analyte	Result (dry)	Qualifier	MDL (dry)	RDL (dry)	Dilution	Analysis	Batch
	mg/kg		mg/kg	mg/kg		date / time	
Aldrin	U		0.00487	0.0259	1	07/30/2022 05:15	WG1902902
Alpha BHC	U		0.00476	0.0259	1	07/30/2022 05:15	WG1902902
Beta BHC	U		0.00491	0.0259	1	07/30/2022 05:15	WG1902902

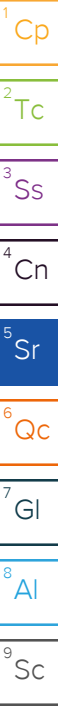

Pesticides (GC) by Method 8081

Analyte	Result (dry) mg/kg	Qualifier	MDL (dry) mg/kg	RDL (dry) mg/kg	Dilution	Analysis date / time	Batch
Delta BHC	U		0.00448	0.0259	1	07/30/2022 05:15	WG1902902
Gamma BHC	U		0.00445	0.0259	1	07/30/2022 05:15	WG1902902
Chlordane	U		0.133	0.388	1	07/30/2022 05:15	WG1902902
4,4-DDD	U		0.00479	0.0259	1	07/30/2022 05:15	WG1902902
4,4-DDE	U		0.00474	0.0259	1	07/30/2022 05:15	WG1902902
4,4-DDT	U		0.00811	0.0259	1	07/30/2022 05:15	WG1902902
Dieldrin	U		0.00445	0.0259	1	07/30/2022 05:15	WG1902902
Endosulfan I	U		0.00470	0.0259	1	07/30/2022 05:15	WG1902902
Endosulfan II	U		0.00434	0.0259	1	07/30/2022 05:15	WG1902902
Endosulfan sulfate	U		0.00471	0.0259	1	07/30/2022 05:15	WG1902902
Endrin	U		0.00453	0.0259	1	07/30/2022 05:15	WG1902902
Endrin aldehyde	U		0.00439	0.0259	1	07/30/2022 05:15	WG1902902
Endrin ketone	U		0.00920	0.0259	1	07/30/2022 05:15	WG1902902
Hexachlorobenzene	U		0.00448	0.0259	1	07/30/2022 05:15	WG1902902
Heptachlor	U		0.00554	0.0259	1	07/30/2022 05:15	WG1902902
Heptachlor epoxide	U		0.00439	0.0259	1	07/30/2022 05:15	WG1902902
Methoxychlor	U		0.00626	0.0259	1	07/30/2022 05:15	WG1902902
Toxaphene	U		0.160	0.518	1	07/30/2022 05:15	WG1902902
(S) Decachlorobiphenyl	76.2			10.0-135		07/30/2022 05:15	WG1902902
(S) Tetrachloro-m-xylene	69.3			10.0-139		07/30/2022 05:15	WG1902902

1 Cp

2 Tc

3 Ss

4 Cn

5 Sr

6 Qc

7 Gl

8 Al

9 Sc

Total Solids by Method 2540 G-2011

Analyte	Result	Qualifier	Dilution	Analysis	Batch
Total Solids	88.7		1	07/28/2022 12:03	WG1902057

Semi-Volatile Organic Compounds (LCMS) by Method SW-846 8321

Analyte	Result (dry)	Qualifier	MDL (dry)	RDL (dry)	Dilution	Analysis	Batch
2,4-D	U		0.00584	0.0225	1	08/02/2022 21:08	WG1903819
Dalapon	U		0.00357	0.0225	1	08/02/2022 21:08	WG1903819
2,4-DB	U		0.0102	0.0225	1	08/02/2022 21:08	WG1903819
Dicamba	U		0.00486	0.0225	1	08/02/2022 21:08	WG1903819
Dichloroprop	U		0.00375	0.0225	1	08/02/2022 21:08	WG1903819
Dinoseb	U		0.00224	0.0225	1	08/02/2022 21:08	WG1903819
MCPA	U		0.00385	0.0225	1	08/02/2022 21:08	WG1903819
MCPP	U		0.00264	0.0225	1	08/02/2022 21:08	WG1903819
2,4,5-T	U		0.00773	0.0225	1	08/02/2022 21:08	WG1903819
2,4,5-TP (Silvex)	U		0.00193	0.0225	1	08/02/2022 21:08	WG1903819
(S) 2,4-DB-D3	116			70.0-130		08/02/2022 21:08	WG1903819

OP Pesticides by Method 8141

Analyte	Result (dry)	Qualifier	MDL (dry)	RDL (dry)	Dilution	Analysis	Batch
Azinphos-Methyl	U		0.0358	0.113	1	07/30/2022 09:05	WG1902909
Bolstar (Sulprofos)	U		0.0168	0.113	1	07/30/2022 09:05	WG1902909
Chlorpyrifos	U		0.0177	0.113	1	07/30/2022 09:05	WG1902909
Coumaphos	U		0.0274	0.113	1	07/30/2022 09:05	WG1902909
Demeton,-O and -S	U		0.00658	0.0789	1	07/30/2022 09:05	WG1902909
Diazinon	U		0.0254	0.113	1	07/30/2022 09:05	WG1902909
Dichlorvos	U		0.0338	0.113	1	07/30/2022 09:05	WG1902909
Dimethoate	U		0.0376	0.113	1	07/30/2022 09:05	WG1902909
Disulfoton	U		0.0286	0.113	1	07/30/2022 09:05	WG1902909
EPN	U		0.0311	0.113	1	07/30/2022 09:05	WG1902909
Ethoprop	U		0.0133	0.113	1	07/30/2022 09:05	WG1902909
Ethyl Parathion	U		0.0185	0.113	1	07/30/2022 09:05	WG1902909
Fensulfothion	U		0.0398	0.113	1	07/30/2022 09:05	WG1902909
Fenthion	U		0.0150	0.113	1	07/30/2022 09:05	WG1902909
Malathion	U		0.0202	0.113	1	07/30/2022 09:05	WG1902909
Merphos	U		0.0261	0.113	1	07/30/2022 09:05	WG1902909
Methyl parathion	U		0.0229	0.113	1	07/30/2022 09:05	WG1902909
Mevinphos	U		0.0259	0.113	1	07/30/2022 09:05	WG1902909
Naled	U		0.0541	0.113	1	07/30/2022 09:05	WG1902909
Phorate	U		0.0237	0.113	1	07/30/2022 09:05	WG1902909
Ronnel	U		0.0168	0.113	1	07/30/2022 09:05	WG1902909
Stirophos	U		0.0201	0.113	1	07/30/2022 09:05	WG1902909
Sulfotep	U		0.0111	0.113	1	07/30/2022 09:05	WG1902909
TEPP	U		0.177	1.13	1	07/30/2022 09:05	WG1902909
Tokuthion (Prothothiofos)	U		0.0169	0.113	1	07/30/2022 09:05	WG1902909
Trichloronate	U		0.0227	0.113	1	07/30/2022 09:05	WG1902909
(S) Triphenyl Phosphate	87.5			36.0-121		07/30/2022 09:05	WG1902909

Pesticides (GC) by Method 8081

Analyte	Result (dry)	Qualifier	MDL (dry)	RDL (dry)	Dilution	Analysis	Batch
Aldrin	U		0.00424	0.0225	1	08/01/2022 15:10	WG1902902
Alpha BHC	U		0.00415	0.0225	1	08/01/2022 15:10	WG1902902
Beta BHC	U		0.00427	0.0225	1	08/01/2022 15:10	WG1902902

Pesticides (GC) by Method 8081

Analyte	Result (dry) mg/kg	Qualifier	MDL (dry) mg/kg	RDL (dry) mg/kg	Dilution	Analysis date / time	Batch
Delta BHC	U		0.00390	0.0225	1	08/01/2022 15:10	WG1902902
Gamma BHC	U		0.00388	0.0225	1	08/01/2022 15:10	WG1902902
Chlordane	U		0.116	0.338	1	08/01/2022 15:10	WG1902902
4,4-DDD	U		0.00417	0.0225	1	08/01/2022 15:10	WG1902902
4,4-DDE	U		0.00412	0.0225	1	08/01/2022 15:10	WG1902902
4,4-DDT	U		0.00707	0.0225	1	08/01/2022 15:10	WG1902902
Dieldrin	U		0.00388	0.0225	1	08/01/2022 15:10	WG1902902
Endosulfan I	U		0.00409	0.0225	1	08/01/2022 15:10	WG1902902
Endosulfan II	U		0.00378	0.0225	1	08/01/2022 15:10	WG1902902
Endosulfan sulfate	U		0.00410	0.0225	1	08/01/2022 15:10	WG1902902
Endrin	U		0.00394	0.0225	1	08/01/2022 15:10	WG1902902
Endrin aldehyde	U		0.00382	0.0225	1	08/01/2022 15:10	WG1902902
Endrin ketone	U		0.00801	0.0225	1	08/01/2022 15:10	WG1902902
Hexachlorobenzene	U		0.00390	0.0225	1	08/01/2022 15:10	WG1902902
Heptachlor	U		0.00482	0.0225	1	08/01/2022 15:10	WG1902902
Heptachlor epoxide	U		0.00382	0.0225	1	08/01/2022 15:10	WG1902902
Methoxychlor	U		0.00545	0.0225	1	08/01/2022 15:10	WG1902902
Toxaphene	U		0.140	0.451	1	08/01/2022 15:10	WG1902902
(S) Decachlorobiphenyl	68.8			10.0-135		08/01/2022 15:10	WG1902902
(S) Tetrachloro-m-xylene	85.5			10.0-139		08/01/2022 15:10	WG1902902

1 Cp

2 Tc

3 Ss

4 Cn

5 Sr

6 Qc

7 Gl

8 Al

9 Sc

Method Blank (MB)

(MB) R3820649-1 07/28/22 12:03

Analyte	MB Result	MB Qualifier	MB MDL	MB RDL
	%		%	%
Total Solids	0.00100			

1 Cp

2 Tc

3 Ss

L1518914-01 Original Sample (OS) • Duplicate (DUP)

(OS) L1518914-01 07/28/22 12:03 • (DUP) R3820649-3 07/28/22 12:03

Analyte	Original Result	DUP Result	Dilution	DUP RPD	DUP Qualifier	DUP RPD Limits
	%	%		%		%
Total Solids	80.4	81.4	1	1.28		10

4 Cn

5 Sr

Laboratory Control Sample (LCS)

(LCS) R3820649-2 07/28/22 12:03

Analyte	Spike Amount	LCS Result	LCS Rec.	Rec. Limits	LCS Qualifier
	%	%	%	%	
Total Solids	50.0	50.0	99.9	85.0-115	

6 Qc

7 Gl

8 Al

9 Sc

Method Blank (MB)

(MB) R3822048-2 08/02/22 16:21

Analyte	MB Result	MB Qualifier	MB MDL	MB RDL
	mg/kg		mg/kg	mg/kg
2,4-D	U		0.00518	0.0200
Dalapon	U		0.00317	0.0200
2,4-DB	U		0.00908	0.0200
Dicamba	U		0.00431	0.0200
Dichloroprop	U		0.00333	0.0200
Dinoseb	U		0.00199	0.0200
MCPA	U		0.00342	0.0200
MCPP	U		0.00234	0.0200
2,4,5-T	U		0.00686	0.0200
2,4,5-TP (Silvex)	U		0.00171	0.0200
(S) 2,4-DB-D3	129			70.0-130

Laboratory Control Sample (LCS)

(LCS) R3822048-1 08/02/22 16:03

Analyte	Spike Amount	LCS Result	LCS Rec.	Rec. Limits	LCS Qualifier
	mg/kg	mg/kg	%	%	
2,4-D	0.200	0.208	104	70.0-130	
Dalapon	0.200	0.226	113	70.0-130	
2,4-DB	0.200	0.213	106	70.0-130	
Dicamba	0.200	0.214	107	70.0-130	
Dichloroprop	0.200	0.207	104	70.0-130	
Dinoseb	0.200	0.178	89.0	70.0-130	
MCPA	0.200	0.220	110	70.0-130	
MCPP	0.200	0.205	103	70.0-130	
2,4,5-T	0.200	0.216	108	70.0-130	
2,4,5-TP (Silvex)	0.200	0.205	103	70.0-130	
(S) 2,4-DB-D3			116	70.0-130	

L1518962-01 Original Sample (OS) • Matrix Spike (MS) • Matrix Spike Duplicate (MSD)

(OS) L1518962-01 08/02/22 17:15 • (MS) R3822048-3 08/02/22 16:39 • (MSD) R3822048-4 08/02/22 16:57

Analyte	Spike Amount (dry)	Original Result (dry)	MS Result (dry)	MSD Result (dry)	MS Rec.	MSD Rec.	Dilution	Rec. Limits	MS Qualifier	MSD Qualifier	RPD	RPD Limits
	mg/kg	mg/kg	mg/kg	mg/kg	%	%		%			%	%
2,4-D	0.228	U	0.247	0.261	108	116	1	70.0-130			5.56	30
Dalapon	0.228	U	0.268	0.293	118	130	1	70.0-130			8.81	30
2,4-DB	0.228	U	0.271	0.296	119	131	1	70.0-130		J5	8.70	30
Dicamba	0.228	U	0.263	0.295	115	131	1	70.0-130		J5	11.4	30

1 Cp

2 Tc

3 Ss

4 Cn

5 Sr

6 Qc

7 Gl

8 Al

9 Sc

L1518962-01 Original Sample (OS) • Matrix Spike (MS) • Matrix Spike Duplicate (MSD)

(OS) L1518962-01 08/02/22 17:15 • (MS) R3822048-3 08/02/22 16:39 • (MSD) R3822048-4 08/02/22 16:57

Analyte	Spike Amount (dry) mg/kg	Original Result (dry) mg/kg	MS Result (dry) mg/kg	MSD Result (dry) mg/kg	MS Rec. %	MSD Rec. %	Dilution	Rec. Limits %	MS Qualifier	MSD Qualifier	RPD %	RPD Limits %
Dichloroprop	0.228	U	0.256	0.268	112	119	1	70.0-130			4.48	30
Dinoseb	0.228	U	0.211	0.211	92.8	93.8	1	70.0-130			0.000	30
MCPA	0.228	U	0.264	0.287	116	127	1	70.0-130			8.10	30
MCPP	0.228	U	0.249	0.270	109	120	1	70.0-130			8.14	30
2,4,5-T	0.228	U	0.265	0.277	116	123	1	70.0-130			4.33	30
2,4,5-TP (Silvex)	0.228	U	0.253	0.268	111	119	1	70.0-130			5.87	30
(S) 2,4-DB-D3					118	127		70.0-130				

1 Cp

2 Tc

3 Ss

4 Cn

5 Sr

6 Qc

7 Gl

8 Al

9 Sc

Method Blank (MB)

(MB) R3821061-1 07/30/22 04:37

Analyte	MB Result mg/kg	MB Qualifier	MB MDL mg/kg	MB RDL mg/kg
Azinphos-Methyl	U		0.0318	0.100
Bolstar (Sulprofos)	U		0.0149	0.100
Chlorpyrifos	U		0.0157	0.100
Coumaphos	U		0.0243	0.100
Demeton,-O and -S	U		0.00584	0.0700
Diazinon	U		0.0225	0.100
Dichlorvos	U		0.0300	0.100
Dimethoate	U		0.0334	0.100
Disulfoton	U		0.0254	0.100
EPN	U		0.0276	0.100
Ethoprop	U		0.0118	0.100
Ethyl Parathion	U		0.0164	0.100
Fensulfothion	U		0.0353	0.100
Fenthion	U		0.0133	0.100
Malathion	U		0.0179	0.100
Merphos	U		0.0232	0.100
Methyl parathion	U		0.0203	0.100
Mevinphos	U		0.0230	0.100
Naled	U		0.0480	0.100
Phorate	U		0.0210	0.100
Ronnel	U		0.0149	0.100
Stirophos	U		0.0178	0.100
Sulfotep	U		0.00986	0.100
TEPP	U		0.157	1.00
Tokuthion (Prothothiofos)	U		0.0150	0.100
Trichloronate	U		0.0201	0.100
(S) Triphenyl Phosphate	91.0			36.0-121

¹Cp

²Tc

³Ss

⁴Cn

⁵Sr

⁶Qc

⁷Gl

⁸Al

⁹Sc

Laboratory Control Sample (LCS)

(LCS) R3821061-2 07/30/22 05:10

Analyte	Spike Amount mg/kg	LCS Result mg/kg	LCS Rec. %	Rec. Limits %	LCS Qualifier
Azinphos-Methyl	0.333	0.336	101	58.0-125	
Bolstar (Sulprofos)	0.333	0.329	98.8	64.0-120	
Chlorpyrifos	0.333	0.338	102	62.0-120	
Coumaphos	0.333	0.330	99.1	60.0-120	
Demeton,-O and -S	0.167	0.161	96.4	59.0-120	
Diazinon	0.333	0.301	90.4	49.0-120	

Laboratory Control Sample (LCS)

(LCS) R3821061-2 07/30/22 05:10

Analyte	Spike Amount mg/kg	LCS Result mg/kg	LCS Rec. %	Rec. Limits %	<u>LCS Qualifier</u>
Dichlorvos	0.333	0.249	74.8	37.0-120	
Dimethoate	0.333	0.310	93.1	46.0-127	
Disulfoton	0.333	0.328	98.5	60.0-121	
EPN	0.333	0.344	103	60.0-121	
Ethoprop	0.333	0.338	102	59.0-120	
Ethyl Parathion	0.333	0.337	101	62.0-120	
Fensulfothion	0.333	0.327	98.2	58.0-123	
Fenthion	0.333	0.333	100	61.0-121	
Malathion	0.333	0.330	99.1	59.0-120	
Merphos	0.333	0.312	93.7	59.0-120	
Methyl parathion	0.333	0.336	101	63.0-120	
Mevinphos	0.333	0.305	91.6	50.0-120	
Naled	0.333	0.185	55.6	10.0-125	
Phorate	0.333	0.335	101	60.0-120	
Ronnel	0.333	0.342	103	62.0-120	
Stirophos	0.333	0.328	98.5	62.0-120	
Sulfotep	0.333	0.333	100	62.0-122	
TEPP	3.33	0.383	11.5	10.0-135	
Tokuthion (Prothothiofos)	0.333	0.328	98.5	63.0-120	
Trichloronate	0.333	0.320	96.1	62.0-120	
(S) Triphenyl Phosphate			93.7	36.0-121	

1 Cp

2 Tc

3 Ss

4 Cn

5 Sr

6 Qc

7 Gl

8 Al

9 Sc

L1518962-01 Original Sample (OS) • Matrix Spike (MS) • Matrix Spike Duplicate (MSD)

(OS) L1518962-01 07/30/22 06:51 • (MS) R3821061-3 07/30/22 07:24 • (MSD) R3821061-4 07/30/22 07:58

Analyte	Spike Amount (dry) mg/kg	Original Result (dry) mg/kg	MS Result (dry) mg/kg	MSD Result (dry) mg/kg	MS Rec. %	MSD Rec. %	Dilution	Rec. Limits %	<u>MS Qualifier</u>	<u>MSD Qualifier</u>	RPD %	RPD Limits %
Azinphos-Methyl	0.391	U	0.337	0.350	86.2	89.5	1	10.0-160			3.76	22
Bolstar (Sulprofos)	0.391	U	0.331	0.347	84.7	88.6	1	10.0-151			4.51	20
Chlorpyrifos	0.391	U	0.342	0.355	87.4	90.7	1	12.0-149			3.71	20
Coumaphos	0.391	U	0.316	0.331	80.8	84.7	1	10.0-160			4.72	22
Demeton,-O and -S	0.196	U	0.168	0.175	85.6	89.2	1	10.0-160			4.11	23
Diazinon	0.391	U	0.329	0.341	84.1	87.1	1	11.0-157			3.51	20
Dichlorvos	0.391	U	0.398	0.412	102	105	1	10.0-160			3.48	24
Dimethoate	0.391	U	0.348	0.348	88.9	88.9	1	10.0-150			0.000	27
Disulfoton	0.391	U	0.327	0.348	83.5	88.9	1	12.0-155			6.27	20
EPN	0.391	U	0.352	0.361	90.1	92.2	1	10.0-159			2.31	20
Ethoprop	0.391	U	0.351	0.364	89.8	93.1	1	11.0-156			3.61	20
Ethyl Parathion	0.391	U	0.354	0.355	90.4	90.7	1	10.0-147			0.332	20

L1518962-01 Original Sample (OS) • Matrix Spike (MS) • Matrix Spike Duplicate (MSD)

(OS) L1518962-01 07/30/22 06:51 • (MS) R3821061-3 07/30/22 07:24 • (MSD) R3821061-4 07/30/22 07:58

Analyte	Spike Amount (dry) mg/kg	Original Result (dry) mg/kg	MS Result (dry) mg/kg	MSD Result (dry) mg/kg	MS Rec. %	MSD Rec. %	Dilution	Rec. Limits %	MS Qualifier	MSD Qualifier	RPD %	RPD Limits %
Fensulfothion	0.391	U	0.350	0.364	89.5	93.1	1	10.0-157			3.95	27
Fenthion	0.391	U	0.330	0.344	84.4	88.0	1	13.0-155			4.18	20
Malathion	0.391	U	0.345	0.349	88.3	89.2	1	13.0-137			1.02	21
Merphos	0.391	U	0.276	0.285	70.6	73.0	1	10.0-147	P		3.35	26
Methyl parathion	0.391	U	0.347	0.358	88.6	91.6	1	10.0-150			3.33	21
Mevinphos	0.391	U	0.358	0.364	91.6	93.1	1	10.0-158			1.63	24
Naled	0.391	U	0.200	0.189	51.1	48.3	1	10.0-137			5.44	40
Phorate	0.391	U	0.337	0.357	86.2	91.3	1	13.0-154			5.75	20
Ronnel	0.391	U	0.343	0.361	87.7	92.2	1	14.0-149			5.01	20
Stirophos	0.391	U	0.331	0.344	84.7	88.0	1	10.0-150			3.83	20
Sulfotep	0.391	U	0.347	0.351	88.6	89.8	1	10.0-160			1.35	20
TEPP	3.91	U	3.30	3.27	84.4	83.5	1	10.0-142			1.07	28
Tokuthion (Prothothiofos)	0.391	U	0.329	0.344	84.1	88.0	1	12.0-153			4.54	20
Trichloronate	0.391	U	0.322	0.344	82.3	88.0	1	12.0-152			6.70	20
(S) Triphenyl Phosphate					88.9	88.3		36.0-121				

1 Cp

2 Tc

3 Ss

4 Cn

5 Sr

6 Qc

7 Gl

8 Al

9 Sc

Method Blank (MB)

(MB) R3821191-1 07/30/22 04:13

Analyte	MB Result mg/kg	MB Qualifier	MB MDL mg/kg	MB RDL mg/kg
Aldrin	U		0.00376	0.0200
Alpha BHC	U		0.00368	0.0200
Beta BHC	U		0.00379	0.0200
Delta BHC	U		0.00346	0.0200
Gamma BHC	U		0.00344	0.0200
Chlordane	U		0.103	0.300
4,4-DDD	U		0.00370	0.0200
4,4-DDE	U		0.00366	0.0200
4,4-DDT	U		0.00627	0.0200
Dieldrin	U		0.00344	0.0200
Endosulfan I	U		0.00363	0.0200
Endosulfan II	U		0.00335	0.0200
Endosulfan sulfate	U		0.00364	0.0200
Endrin	U		0.00350	0.0200
Endrin aldehyde	U		0.00339	0.0200
Endrin ketone	U		0.00711	0.0200
Hexachlorobenzene	U		0.00346	0.0200
Heptachlor	U		0.00428	0.0200
Heptachlor epoxide	U		0.00339	0.0200
Methoxychlor	U		0.00484	0.0200
Toxaphene	U		0.124	0.400
(S) Decachlorobiphenyl	101			10.0-135
(S) Tetrachloro-m-xylene	80.6			10.0-139

¹Cp

²Tc

³Ss

⁴Cn

⁵Sr

⁶Qc

⁷Gl

⁸Al

⁹Sc

Laboratory Control Sample (LCS)

(LCS) R3821191-2 07/30/22 04:25

Analyte	Spike Amount mg/kg	LCS Result mg/kg	LCS Rec. %	Rec. Limits %	LCS Qualifier
Aldrin	0.0666	0.0480	72.1	34.0-136	
Alpha BHC	0.0666	0.0504	75.7	34.0-139	
Beta BHC	0.0666	0.0475	71.3	34.0-133	
Delta BHC	0.0666	0.0491	73.7	34.0-135	
Gamma BHC	0.0666	0.0496	74.5	34.0-136	
4,4-DDD	0.0666	0.0473	71.0	33.0-141	
4,4-DDE	0.0666	0.0553	83.0	34.0-134	
4,4-DDT	0.0666	0.0438	65.8	30.0-143	
Dieldrin	0.0666	0.0493	74.0	35.0-137	
Endosulfan I	0.0666	0.0499	74.9	34.0-134	

Laboratory Control Sample (LCS)

(LCS) R3821191-2 07/30/22 04:25

Analyte	Spike Amount mg/kg	LCS Result mg/kg	LCS Rec. %	Rec. Limits %	<u>LCS Qualifier</u>
Endosulfan II	0.0666	0.0492	73.9	35.0-132	
Endosulfan sulfate	0.0666	0.0490	73.6	35.0-132	
Endrin	0.0666	0.0485	72.8	34.0-137	
Endrin aldehyde	0.0666	0.0423	63.5	23.0-121	
Endrin ketone	0.0666	0.0379	56.9	35.0-144	
Hexachlorobenzene	0.0666	0.0461	69.2	33.0-129	
Heptachlor	0.0666	0.0458	68.8	36.0-141	
Heptachlor epoxide	0.0666	0.0489	73.4	36.0-134	
Methoxychlor	0.0666	0.0430	64.6	28.0-150	
<i>(S) Decachlorobiphenyl</i>			90.7	10.0-135	
<i>(S) Tetrachloro-m-xylene</i>			69.7	10.0-139	

L1518962-03 Original Sample (OS) • Matrix Spike (MS) • Matrix Spike Duplicate (MSD)

(OS) L1518962-03 08/01/22 15:10 • (MS) R3821664-1 08/01/22 15:21 • (MSD) R3821664-2 08/01/22 15:32

Analyte	Spike Amount (dry) mg/kg	Original Result (dry) mg/kg	MS Result (dry) mg/kg	MSD Result (dry) mg/kg	MS Rec. %	MSD Rec. %	Dilution	Rec. Limits %	<u>MS Qualifier</u>	<u>MSD Qualifier</u>	RPD %	RPD Limits %
Aldrin	0.0731	U	0.0545	0.0486	74.6	65.7	1	20.0-135			11.6	37
Alpha BHC	0.0731	U	0.0618	0.0600	84.4	81.1	1	27.0-140			2.96	35
Beta BHC	0.0731	U	0.0559	0.0539	76.4	72.9	1	23.0-141			3.70	37
Delta BHC	0.0731	U	0.0638	0.0616	87.2	83.4	1	21.0-138			3.41	35
Gamma BHC	0.0731	U	0.0605	0.0588	82.7	79.6	1	27.0-137			2.83	36
4,4-DDD	0.0731	U	0.0595	0.0538	81.4	72.7	1	15.0-152			10.1	39
4,4-DDE	0.0731	U	0.0584	0.0523	79.8	70.7	1	10.0-152			11.0	40
4,4-DDT	0.0731	U	0.0514	0.0467	70.3	63.1	1	10.0-151			9.66	40
Dieldrin	0.0731	U	0.0581	0.0526	79.5	71.2	1	17.0-145			9.97	37
Endosulfan I	0.0731	U	0.0580	0.0534	79.4	72.3	1	20.0-137			8.29	36
Endosulfan II	0.0731	U	0.0614	0.0571	84.0	77.3	1	15.0-141			7.22	37
Endosulfan sulfate	0.0731	U	0.0641	0.0609	87.7	82.3	1	15.0-143			5.23	38
Endrin	0.0731	U	0.0592	0.0547	80.9	73.9	1	19.0-143			7.92	37
Endrin aldehyde	0.0731	U	0.0614	0.0604	84.0	81.7	1	10.0-139			1.67	40
Endrin ketone	0.0731	U	0.0596	0.0565	81.5	76.4	1	17.0-149			5.44	38
Hexachlorobenzene	0.0731	U	0.0666	0.0607	91.1	82.2	1	25.0-126			9.20	35
Heptachlor	0.0731	U	0.0585	0.0536	80.0	72.6	1	22.0-138			8.64	37
Heptachlor epoxide	0.0731	U	0.0591	0.0551	80.7	74.5	1	22.0-138			6.91	36
Methoxychlor	0.0731	U	0.0529	0.0498	72.3	67.4	1	10.0-159			5.93	40
<i>(S) Decachlorobiphenyl</i>					77.3	76.7		10.0-135				
<i>(S) Tetrachloro-m-xylene</i>					93.8	96.5		10.0-139				

1 Cp

2 Tc

3 Ss

4 Cn

5 Sr

6 Qc

7 Gl

8 Al

9 Sc

GLOSSARY OF TERMS

Guide to Reading and Understanding Your Laboratory Report

The information below is designed to better explain the various terms used in your report of analytical results from the Laboratory. This is not intended as a comprehensive explanation, and if you have additional questions please contact your project representative.

Results Disclaimer - Information that may be provided by the customer, and contained within this report, include Permit Limits, Project Name, Sample ID, Sample Matrix, Sample Preservation, Field Blanks, Field Spikes, Field Duplicates, On-Site Data, Sampling Collection Dates/Times, and Sampling Location. Results relate to the accuracy of this information provided, and as the samples are received.

Abbreviations and Definitions

(dry)	Results are reported based on the dry weight of the sample. [this will only be present on a dry report basis for soils].
MDL	Method Detection Limit.
MDL (dry)	Method Detection Limit.
RDL	Reported Detection Limit.
RDL (dry)	Reported Detection Limit.
Rec.	Recovery.
RPD	Relative Percent Difference.
SDG	Sample Delivery Group.
(S)	Surrogate (Surrogate Standard) - Analytes added to every blank, sample, Laboratory Control Sample/Duplicate and Matrix Spike/Duplicate; used to evaluate analytical efficiency by measuring recovery. Surrogates are not expected to be detected in all environmental media.
U	Not detected at the Reporting Limit (or MDL where applicable).
Analyte	The name of the particular compound or analysis performed. Some Analyses and Methods will have multiple analytes reported.
Dilution	If the sample matrix contains an interfering material, the sample preparation volume or weight values differ from the standard, or if concentrations of analytes in the sample are higher than the highest limit of concentration that the laboratory can accurately report, the sample may be diluted for analysis. If a value different than 1 is used in this field, the result reported has already been corrected for this factor.
Limits	These are the target % recovery ranges or % difference value that the laboratory has historically determined as normal for the method and analyte being reported. Successful QC Sample analysis will target all analytes recovered or duplicated within these ranges.
Original Sample	The non-spiked sample in the prep batch used to determine the Relative Percent Difference (RPD) from a quality control sample. The Original Sample may not be included within the reported SDG.
Qualifier	This column provides a letter and/or number designation that corresponds to additional information concerning the result reported. If a Qualifier is present, a definition per Qualifier is provided within the Glossary and Definitions page and potentially a discussion of possible implications of the Qualifier in the Case Narrative if applicable.
Result	The actual analytical final result (corrected for any sample specific characteristics) reported for your sample. If there was no measurable result returned for a specific analyte, the result in this column may state "ND" (Not Detected) or "BDL" (Below Detectable Levels). The information in the results column should always be accompanied by either an MDL (Method Detection Limit) or RDL (Reporting Detection Limit) that defines the lowest value that the laboratory could detect or report for this analyte.
Uncertainty (Radiochemistry)	Confidence level of 2 sigma.
Case Narrative (Cn)	A brief discussion about the included sample results, including a discussion of any non-conformances to protocol observed either at sample receipt by the laboratory from the field or during the analytical process. If present, there will be a section in the Case Narrative to discuss the meaning of any data qualifiers used in the report.
Quality Control Summary (Qc)	This section of the report includes the results of the laboratory quality control analyses required by procedure or analytical methods to assist in evaluating the validity of the results reported for your samples. These analyses are not being performed on your samples typically, but on laboratory generated material.
Sample Chain of Custody (Sc)	This is the document created in the field when your samples were initially collected. This is used to verify the time and date of collection, the person collecting the samples, and the analyses that the laboratory is requested to perform. This chain of custody also documents all persons (excluding commercial shippers) that have had control or possession of the samples from the time of collection until delivery to the laboratory for analysis.
Sample Results (Sr)	This section of your report will provide the results of all testing performed on your samples. These results are provided by sample ID and are separated by the analyses performed on each sample. The header line of each analysis section for each sample will provide the name and method number for the analysis reported.
Sample Summary (Ss)	This section of the Analytical Report defines the specific analyses performed for each sample ID, including the dates and times of preparation and/or analysis.

Qualifier	Description
J5	The sample matrix interfered with the ability to make any accurate determination; spike value is high.
P	RPD between the primary and confirmatory analysis exceeded 40%.

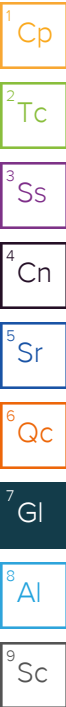

ACCREDITATIONS & LOCATIONS

Pace Analytical National 12065 Lebanon Rd Mount Juliet, TN 37122

Alabama	40660	Nebraska	NE-OS-15-05
Alaska	17-026	Nevada	TN000032021-1
Arizona	AZ0612	New Hampshire	2975
Arkansas	88-0469	New Jersey–NELAP	TN002
California	2932	New Mexico ¹	TN00003
Colorado	TN00003	New York	11742
Connecticut	PH-0197	North Carolina	Env375
Florida	E87487	North Carolina ¹	DW21704
Georgia	NELAP	North Carolina ³	41
Georgia ¹	923	North Dakota	R-140
Idaho	TN00003	Ohio–VAP	CL0069
Illinois	200008	Oklahoma	9915
Indiana	C-TN-01	Oregon	TN200002
Iowa	364	Pennsylvania	68-02979
Kansas	E-10277	Rhode Island	LA000356
Kentucky ^{1,6}	KY90010	South Carolina	84004002
Kentucky ²	16	South Dakota	n/a
Louisiana	AI30792	Tennessee ^{1,4}	2006
Louisiana	LA018	Texas	T104704245-20-18
Maine	TN00003	Texas ⁵	LAB0152
Maryland	324	Utah	TN000032021-11
Massachusetts	M-TN003	Vermont	VT2006
Michigan	9958	Virginia	110033
Minnesota	047-999-395	Washington	C847
Mississippi	TN00003	West Virginia	233
Missouri	340	Wisconsin	998093910
Montana	CERT0086	Wyoming	A2LA
A2LA – ISO 17025	1461.01	AIHA-LAP,LLC EMLAP	100789
A2LA – ISO 17025 ⁵	1461.02	DOD	1461.01
Canada	1461.01	USDA	P330-15-00234
EPA–Crypto	TN00003		

¹ Drinking Water ² Underground Storage Tanks ³ Aquatic Toxicity ⁴ Chemical/Microbiological ⁵ Mold ⁶ Wastewater n/a Accreditation not applicable

* Not all certifications held by the laboratory are applicable to the results reported in the attached report.

* Accreditation is only applicable to the test methods specified on each scope of accreditation held by Pace Analytical.

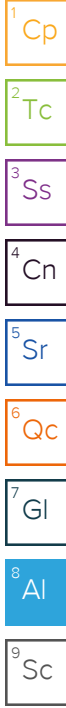

Company Name/Address:
Integrated Environmental
 21435 Gill Road
 Farmington Hills, MI 48335

Billing Information:
Accounts Payable
 21435 Gill Road
 Farmington Hills, MI 48335

Report to:
Nikki Mckenna

Email To: nmckenna@intenv.com

Project Description:

City/State: **St. Clair / MI**

Please Circle:
 PT MT CT ET

Phone: **248-477-5021**

Client Project #
348001

Lab Project #
INTENVLMI-348001

Collected by (print):
NIKKI MCKENNA

Site/Facility ID #

P.O. #

Collected by (signature):
Nikki Mckenna

Rush? (Lab MUST Be Notified)
 ___ Same Day ___ Five Day
 ___ Next Day ___ 5 Day (Rad Only)
 ___ Two Day ___ 10 Day (Rad Only)
 Three Day

Quote #
 Date Results Needed

Immediately
 Packed on Ice N ___ Y

No. of Cntrs

Sample ID	Comp/Grab	Matrix *	Depth	Date	Time	No. of Cntrs	SV8081,SV8141,SV8151 4ozClir-NoPres	TS 2ozClir-NoPres	Analysis / Container / Preservative	Chain of Custody	Page 1 of 1
SSP-1	Grab	SS	0.5	7-25-22	10:07	2	X	X			
ESP-2	Grab	SS	0.5	7-25-22	10:07	2	X	X			
NSP-3	Grab	SS	0.5	7-25-22	10:09	2	X	X			

Pace
 PEOPLE ADVANCING SCIENCE

MT JULIET, TN

12065 Lebanon Rd Mount Juliet, TN 37122
 Submitting a sample via this chain of custody constitutes acknowledgment and acceptance of the Pace Terms and Conditions found at: <https://info.pacelabs.com/hubs/pas-standard-terms.pdf>

SDG # **1518962**
M058

Acctnum: INTENVLMI
 Template: T213116
 Prelogin: P938747
 PM: 341 - John Hawkins
 PB: **BF 7/19/22**

Shipped Via: **FedEX Ground**

* Matrix:
 SS - Soil AIR - Air F - Filter
 GW - Groundwater B - Bioassay
 WW - WasteWater
 DW - Drinking Water
 OT - Other _____

Remarks:
 pH _____ Temp _____
 Flow _____ Other _____

Samples returned via:
 ___ UPS ___ FedEx ___ Courier _____

Tracking # **5913 6266 7550**

Sample Receipt Checklist	
COC Seal Present/Intact:	___ NP <input checked="" type="checkbox"/> N
COC Signed/Accurate:	<input checked="" type="checkbox"/> N
Bottles arrive intact:	<input checked="" type="checkbox"/> N
Correct bottles used:	<input checked="" type="checkbox"/> N
Sufficient volume sent:	<input checked="" type="checkbox"/> N
If Applicable	
VOA Zero Headspace:	___ Y ___ N
Preservation Correct/Checked:	<input checked="" type="checkbox"/> Y ___ N
RAD Screen <0.5 mR/hr:	<input checked="" type="checkbox"/> Y ___ N

Relinquished by: (Signature)
Nikki Mckenna

Date: **7-25-22**
 Time: **11:27**

Received by: (Signature)

Trip Blank Received: Yes/No
 No
 HCL/MeOH
 TBR

Relinquished by: (Signature)

Date: _____
 Time: _____

Received by: (Signature)

Temp: _____ °C
 Bottles Received: **10.910 = 10.9 6**

If preservation required by Login: Date/Time

Relinquished by: (Signature)

Date: _____
 Time: _____

Received for lab by: (Signature)
[Signature]

Date: **7/28/22**
 Time: **9:00**

Hold: _____
 Condition: **OK**

Appendix E - 3

Soil Compaction Data

MOISTURE AND DENSITY DETERMINATION

NUCLEAR METHOD

DISTRIBUTION: ORIGINAL - Construction Engineer, COPIES - Area Density Specialist, Density Technology Unit (Lansing).

* SEE REVERSE SIDE

DATE <i>11/21/22</i>	CONTROL SECTION ID <i>DTE Bohem Ash Basins</i>	JOB NUMBER <i>2207.19</i>	ROUTE NO. or STREET <i>Pointe Dr</i>	GAUGE NO. <i>36231</i>	
DENSITY INSPECTOR <i>Tim Smith</i>		CERTIFICATION NO. <i>12047-0224</i>	DENSITY INSPECTOR PHONE NO. <i>8109845376</i>	CONSTRUCTION ENG. (MDOT) <i>PATRICK PHELAN</i>	ASST. CON. ENG. / CONSULTANT ENG.

TEST			DETERMINATION OF IN-PLACE DENSITY									LOCATION OF TEST			
ORIGINAL	RECHECK	TEST DEPTH inch	COUNTS (MC)	COUNTS (DC)	DRY DENSITY PCF	WET DENSITY PCF	MOIS- TURE PCF	MOIS- TURE %	MAX DENSITY PCF	PERCENT OF COM- PACTION	STATION	DISTANCE FROM CL ft		DEPTH BELOW PLAN GRADE ft	ITEM OF WORK
												LEFT	RIGHT		
1	2	3	4	5	6	7	8	9	10	11	12	13	14	15	16
1		<i>12"</i>	<i>130</i>	<i>470</i>	<i>107.6</i>	<i>119.2</i>	<i>11.6</i>	<i>10.8</i>	<i>113.0</i>	<i>95.2</i>	<i>C1L1</i>			<i>22'</i>	<i>5</i>
2			<i>141</i>	<i>467</i>	<i>107.5</i>	<i>119.4</i>	<i>11.9</i>	<i>11.1</i>		<i>95.1</i>	<i>C1L2</i>			<i>20.5</i>	
3			<i>163</i>	<i>423</i>	<i>108.3</i>	<i>122.4</i>	<i>14.0</i>	<i>13.0</i>		<i>95.9</i>	<i>C1L3</i>			<i>19'</i>	
4			<i>165</i>	<i>438</i>	<i>108.0</i>	<i>122.2</i>	<i>14.2</i>	<i>13.1</i>		<i>95.6</i>	<i>C1L4</i>			<i>17.5</i>	
5			<i>133</i>	<i>483</i>	<i>107.4</i>	<i>118.4</i>	<i>11.1</i>	<i>10.4</i>		<i>95.0</i>	<i>C1L5</i>			<i>16</i>	
6			<i>142</i>	<i>465</i>	<i>107.6</i>	<i>119.6</i>	<i>12.0</i>	<i>11.6</i>		<i>95.2</i>	<i>C1L6</i>			<i>14.5</i>	

TEST NO.	MOIS- TURE %	VOLUME OF MOLD CU. FT.	DETERMINATION OF MAXIMUM DENSITY (SOIL & HMA)							OPTIMUM MOISTURE %	NOTE: To convert (g) to (lbs): Wt. (g) + 453.59 = Wt. (lbs)
			WET SOIL + MOLD g	MOLD g	WET SOIL g	WET SOIL lbs	COMPACTED SOIL WET PCF	MAX DENSITY PCF			
A	B	C	D	E	F	G	H	I	J		
<i>1</i>	<i>10.8</i>	<i>0.0364</i>	<i>4579</i>	<i>2602</i>	<i>1977</i>	<i>4.36</i>	<i>119.7</i>	<i>113.0</i>	<i>15.4</i>		
										CHART STANDARDS	
										DENSITY	MOISTURE
										<i>1885</i>	<i>583</i>
										<i>1923</i>	<i>617</i>
										OPERATING STANDARDS	
										DENSITY	MOISTURE
										<i>1908</i>	<i>603</i>

REMARKS
*CLAY BASE - Begin in SW corner of East Basin - Lifts inside
TRENCH Box Cell 1 = C1 LH = Lift*

20/10 Weights	1st	2nd	DENSITY INSPECTOR'S SIGNATURE <i>[Signature]</i>	AGENCY / COMPANY <i>BNS Inc</i>
3rd	4th	5th		

DENSITY REQUIREMENTS

	MINIMUM % OF COMPACTION	ITEM OF WORK	DEPTH
Original Ground			
Road Embankment Areas (if specified on the plans)	90.0	OG	9"
Bridges – as shown on the plans	95.0	OG	9"
Cut Areas			
Cuts requiring Sand Subbase	95.0	CS	9"
Cuts not requiring Sand Subbase	95.0	CN	12"
Subgrade for HMA Base, Aggregate Base and Concrete Widening	95.0	SG	9"
Embankments			
Regular	95.0	E	
Abutments with Piling	95.0	AP	
Abutments without Piling – within the limits for Structure Embankment as shown on the plans	100.0	AN	
Backfill			
Foundation Undercut Backfill for Retaining Walls, Grade Separation or Bridges	100.0	FB	
Backfill for Bridges, Culverts, Sewers, Water Main, Manholes, Catch Basins, Edge Drains and Subgrade Undercuts	95.0	B	
Pavement Structure			
Subbase	95.0	S	
Subbase for Slope Paving	90.0	SP	
Aggregate Base-used under Concrete Pavement	95.0	SS	
Aggregate Base-used under HMA Pavement	98.0	AB	
OGDC – used under Concrete and HMA Pavement	95.0	OGDC	
OGDC – used under Concrete and HMA Pavement (recycled material)	95.0	OGR	
HMA Aggregate Base (pulverized HMA used as Aggregate Base)	98.0	BAB	
Aggregate Base – used under Concrete Pavement (recycled material)	95.0	CAC	
Aggregate Base – used under HMA Pavement (recycled material)	98.0	CAB	
OGDC – Sleeper slab footprint and approach area	95.0	SLO	
OGDC – Sleeper slab footprint and approach area (recycled material)	95.0	SLOR	
Aggregate Base – Sleeper slab footprint and approach area	98.0	SLA	
Trenching – under concrete pavement	95.0	TC	
Trenching – under HMA pavement	98.0	TB	
Shoulders – Class I	98.0	SAA	
Shoulders – Class II and III	95.0	SA	
HMA Stabilization	98.0	BS	
HMA Paving – Base Course	92.0*	BB	
HMA Paving – Leveling Course	92.0*	BL	
HMA Paving – Top Course	92.0*	BT	

See JMF (form 1911) for G_{mm} value for target density value. $TMD = G_{mm} \times 62.4$

*Minimum % compaction of JMF TMD

MOISTURE AND DENSITY DETERMINATION NUCLEAR METHOD

DISTRIBUTION: ORIGINAL – Construction Engineer, COPIES – Area Density Specialist, Density Technology Unit (Lansing).

* SEE REVERSE SIDE

DATE 11/22/22	CONTROL SECTION ID DTE Bottom Ash Basin	JOB NUMBER 2207-19	ROUTE NO. or STREET Point Dr	GAUGE NO. 36231	
DENSITY INSPECTOR Tim Smith		CERTIFICATION NO. 12047-0224	DENSITY INSPECTOR PHONE NO. 810 984 5596	CONSTRUCTION ENG. (MDOT)	ASST. CON. ENG. / CONSULTANT ENG. PATRICK PUELAN

TEST			DETERMINATION OF IN-PLACE DENSITY									LOCATION OF TEST			
ORIGINAL 1	RECHECK 2	TEST DEPTH inch 3	COUNTS (MC) 4	COUNTS (DC) 5	DRY DENSITY PCF 6	WET DENSITY PCF 7	MOIS- TURE PCF 8	MOIS- TURE % 9	MAX DENSITY PCF 10	PERCENT OF COM- PACTION 11	STATION 12	DISTANCE FROM CL ft		DEPTH BELOW PLAN GRADE ft 15	ITEM OF WORK 16
												LEFT 13	RIGHT 14		
1		12"	150	469	106.7	119.4	12.7	11.9	108.7	98.2	C242				S

TEST NO. A	MOIS- TURE % B	VOLUME OF MOLD CU. FT. C	DETERMINATION OF MAXIMUM DENSITY (SOIL & HMA)							OPTIMUM MOISTURE % J	NOTE: To convert (g) to (lbs): Wt. (g) + 453.59 = Wt. (lbs)
			WET SOIL + MOLD g D	MOLD g E	WET SOIL g F	WET SOIL lbs G	COMPACTED SOIL WET PCF H	MAX DENSITY PCF I			
2	11.9	0.0364	4515	2602	1913	4.22	115.9	108.7	17.2		

REMARKS
 clay Base middle of 5' and of East basin Cell 2
 It was decided to do 1 or 2 tests per week, no more testing today

20/10 Weights	1st	2nd	DENSITY INSPECTOR'S SIGNATURE 	AGENCY / COMPANY BMS Inc
3rd	4th	5th		

DENSITY REQUIREMENTS

	MINIMUM % OF COMPACTION	ITEM OF WORK	DEPTH
Original Ground			
Road Embankment Areas (if specified on the plans)	90.0	OG	9"
Bridges – as shown on the plans	95.0	OG	9"
Cut Areas			
Cuts requiring Sand Subbase	95.0	CS	9"
Cuts not requiring Sand Subbase	95.0	CN	12"
Subgrade for HMA Base, Aggregate Base and Concrete Widening	95.0	SG	9"
Embankments			
Regular	95.0	E	
Abutments with Piling	95.0	AP	
Abutments without Piling – within the limits for Structure Embankment as shown on the plans	100.0	AN	
Backfill			
Foundation Undercut Backfill for Retaining Walls, Grade Separation or Bridges	100.0	FB	
Backfill for Bridges, Culverts, Sewers, Water Main, Manholes, Catch Basins, Edge Drains and Subgrade Undercuts	95.0	B	
Pavement Structure			
Subbase	95.0	S	
Subbase for Slope Paving	90.0	SP	
Aggregate Base-used under Concrete Pavement	95.0	SS	
Aggregate Base-used under HMA Pavement	98.0	AB	
OGDC – used under Concrete and HMA Pavement	95.0	OGDC	
OGDC – used under Concrete and HMA Pavement (recycled material)	95.0	OGR	
HMA Aggregate Base (pulverized HMA used as Aggregate Base)	98.0	BAB	
Aggregate Base – used under Concrete Pavement (recycled material)	95.0	CAC	
Aggregate Base – used under HMA Pavement (recycled material)	98.0	CAB	
OGDC – Sleeper slab footprint and approach area	95.0	SLO	
OGDC – Sleeper slab footprint and approach area (recycled material)	95.0	SLOR	
Aggregate Base – Sleeper slab footprint and approach area	98.0	SLA	
Trenching – under concrete pavement	95.0	TC	
Trenching – under HMA pavement	98.0	TB	
Shoulders – Class I	98.0	SAA	
Shoulders – Class II and III	95.0	SA	
HMA Stabilization	98.0	BS	
HMA Paving – Base Course	92.0*	BB	
HMA Paving – Leveling Course	92.0*	BL	
HMA Paving – Top Course	92.0*	BT	

See JMF (form 1911) for G_{mm} value for target density value, $TMD = G_{mm} \times 62.4$

*Minimum % compaction of JMF TMD

MOISTURE AND DENSITY DETERMINATION

NUCLEAR METHOD

DISTRIBUTION: ORIGINAL – Construction Engineer, COPIES – Area Density Specialist, Density Technology Unit (Lansing).

* SEE REVERSE SIDE

DATE 12/1/20	CONTROL SECTION ID DTE Bottom Ash Basin	JOB NUMBER 2207.19	ROUTE NO. or STREET Pointe Dr	GAUGE NO. 36231	
DENSITY INSPECTOR Tim Smith		CERTIFICATION NO. 12447-0224	DENSITY INSPECTOR PHONE NO. 5149845596	CONSTRUCTION ENG. (MDOT)	ASST. CON.ENG. / CONSULTANT ENG. PATRICK PHELAN

TEST			DETERMINATION OF IN-PLACE DENSITY								LOCATION OF TEST				
ORIGINAL	RECHECK	TEST DEPTH inch	COUNTS (MC)	COUNTS (DC)	DRY DENSITY PCF	WET DENSITY PCF	MOIS- TURE PCF	MOIS- TURE %	MAX DENSITY PCF	PERCENT OF COM- PACTION	STATION	DISTANCE FROM CL ft		DEPTH BELOW PLAN GRADE ft	ITEM OF WORK
												LEFT	RIGHT		
1	2	3	4	5	6	7	8	9	10	11	12	13	14	15	16
1		12"	173	582	105.5	120.3	14.8	13.5	108.7	97.1	E10	W			B
2		↓	179	594	104.9	120.4	15.1	14.5		96.5	E10	E			
3		↓	172	571	106.5	121.3	14.8	13.4		98.0	E10	L3			
		↓													

TEST NO.	MOIS- TURE %	VOLUME OF MOLD CU. FT.	DETERMINATION OF MAXIMUM DENSITY (SOIL & HMA)							OPTIMUM MOISTURE %	NOTE: To convert (g) to (lbs): Wt. (g) + 453.59 = Wt. (lbs)
			WET SOIL + MOLD g	MOLD g	WET SOIL g	WET SOIL lbs	COMPACTED SOIL WET PCF	MAX DENSITY PCF			
A	B	C	D	E	F	G	H	I	J		
2	11.9	0.0364	4515	2602	1913	4.22	115.9	180.7	17.2		

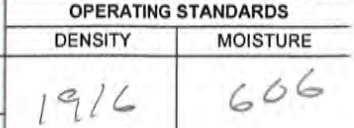
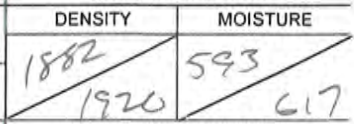

REMARKS

20/10 Weights	1st	2nd	DENSITY INSPECTOR'S SIGNATURE 	AGENCY / COMPANY BMT INC
3rd	4th	5th		

DENSITY REQUIREMENTS

	MINIMUM % OF COMPACTION	ITEM OF WORK	DEPTH
Original Ground			
Road Embankment Areas (If specified on the plans)	90.0	OG	9"
Bridges – as shown on the plans	95.0	OG	9"
Cut Areas			
Cuts requiring Sand Subbase	95.0	CS	9"
Cuts not requiring Sand Subbase	95.0	CN	12"
Subgrade for HMA Base, Aggregate Base and Concrete Widening	95.0	SG	9"
Embankments			
Regular	95.0	E	
Abutments with Piling	95.0	AP	
Abutments without Piling – within the limits for Structure Embankment as shown on the plans	100.0	AN	
Backfill			
Foundation Undercut Backfill for Retaining Walls, Grade Separation or Bridges	100.0	FB	
Backfill for Bridges, Culverts, Sewers, Water Main, Manholes, Catch Basins, Edge Drains and Subgrade Undercuts	95.0	B	
Pavement Structure			
Subbase	95.0	S	
Subbase for Slope Paving	90.0	SP	
Aggregate Base-used under Concrete Pavement	95.0	SS	
Aggregate Base-used under HMA Pavement	98.0	AB	
OGDC – used under Concrete and HMA Pavement	95.0	OGDC	
OGDC – used under Concrete and HMA Pavement (recycled material)	95.0	OGR	
HMA Aggregate Base (pulverized HMA used as Aggregate Base)	98.0	BAB	
Aggregate Base – used under Concrete Pavement (recycled material)	95.0	CAC	
Aggregate Base – used under HMA Pavement (recycled material)	98.0	CAB	
OGDC – Sleeper slab footprint and approach area	95.0	SLO	
OGDC – Sleeper slab footprint and approach area (recycled material)	95.0	SLOR	
Aggregate Base – Sleeper slab footprint and approach area	98.0	SLA	
Trenching – under concrete pavement	95.0	TC	
Trenching – under HMA pavement	98.0	TB	
Shoulders – Class I	98.0	SAA	
Shoulders – Class II and III	95.0	SA	
HMA Stabilization	98.0	BS	
HMA Paving – Base Course	92.0*	BB	
HMA Paving – Leveling Course	92.0*	BL	
HMA Paving – Top Course	92.0*	BT	

See JMF (form 1911) for G_{mm} value for target density value. $TMD = G_{mm} \times 62.4$

*Minimum % compaction of JMF TMD

MOISTURE AND DENSITY DETERMINATION NUCLEAR METHOD

DISTRIBUTION: ORIGINAL – Construction Engineer, COPIES – Area Density Specialist, Density Technology Unit (Lansing).

* SEE REVERSE SIDE

DATE <i>12/7/22</i>	CONTROL SECTION ID <i>POINTE DR ASH BASIN</i>	JOB NUMBER <i>2207-19</i>	ROUTE NO. or STREET <i>POINTE DR</i>	GAUGE NO. <i>37703</i>
DENSITY INSPECTOR <i>TIM SMITH</i>		CERTIFICATION NO. <i>12047-0224</i>	DENSITY INSPECTOR PHONE NO. <i>810 9845596</i>	CONSTRUCTION ENG. (MDOT) <i>PATRICK PHILAN</i>

TEST			DETERMINATION OF IN-PLACE DENSITY									LOCATION OF TEST			
ORIGINAL	RECHECK	TEST DEPTH inch	COUNTS (MC)	COUNTS (DC)	DRY DENSITY PCF	WET DENSITY PCF	MOIS- TURE PCF	MOIS- TURE %	MAX DENSITY PCF	PERCENT OF COM- PACTION	STATION	DISTANCE FROM CL ft		DEPTH BELOW PLAN GRADE ft	ITEM OF WORK
												LEFT	RIGHT		
1	2	3	4	5	6	7	8	9	10	11	12	13	14	15	16
<i>1</i>		<i>12"</i>	<i>178</i>	<i>530</i>	<i>106.9</i>	<i>120.4</i>	<i>13.5</i>	<i>13.2</i>	<i>111.2</i>	<i>96.1</i>	<i>E24</i>			<i>15</i>	<i>B</i>
<i>2</i>		<i>↓</i>	<i>175</i>	<i>535</i>	<i>106.3</i>	<i>119.9</i>	<i>13.6</i>	<i>13.2</i>	<i>↓</i>	<i>95.6</i>	<i>E27E</i>			<i>↓</i>	<i>↓</i>
<i>3</i>		<i>↓</i>	<i>207</i>	<i>428</i>	<i>108.3</i>	<i>124.7</i>	<i>16.4</i>	<i>14.1</i>	<i>↓</i>	<i>97.4</i>	<i>E27W</i>			<i>↓</i>	<i>↓</i>

TEST NO.	MOIS- TURE %	VOLUME OF MOLD CU. FT.	DETERMINATION OF MAXIMUM DENSITY (SOIL & HMA)							OPTIMUM MOISTURE %	NOTE: To convert (g) to (lbs): Wt. (g) + 453.59 = Wt. (lbs)
			WET SOIL + MOLD g	MOLD g	WET SOIL g	WET SOIL lbs	COMPACTED SOIL WET PCF	MAX DENSITY PCF			
A	B	C	D	E	F	G	H	I	J		
<i>1</i>	<i>13.2</i>	<i>0.0364</i>	<i>4627</i>	<i>2602</i>	<i>2025</i>	<i>4.46</i>	<i>122.6</i>	<i>111.2</i>	<i>16.1</i>		

CHART STANDARDS	
DENSITY	MOISTURE
<i>2032</i>	<i>654</i>
<i>2073</i>	<i>680</i>
OPERATING STANDARDS	
DENSITY	MOISTURE
<i>2032</i>	<i>666</i>

REMARKS
T-99 - Clay backfill
E cell

20/10 Weights	1st	2nd	DENSITY INSPECTOR'S SIGNATURE <i>[Signature]</i>	AGENCY / COMPANY <i>BHI Inc</i>
3rd	4th	5th		

DENSITY REQUIREMENTS

	MINIMUM % OF COMPACTION	ITEM OF WORK	DEPTH
Original Ground			
Road Embankment Areas (if specified on the plans)	90.0	OG	9"
Bridges – as shown on the plans	95.0	OG	9"
Cut Areas			
Cuts requiring Sand Subbase	95.0	CS	9"
Cuts not requiring Sand Subbase	95.0	CN	12"
Subgrade for HMA Base, Aggregate Base and Concrete Widening	95.0	SG	9"
Embankments			
Regular	95.0	E	
Abutments with Piling	95.0	AP	
Abutments without Piling – within the limits for Structure Embankment as shown on the plans	100.0	AN	
Backfill			
Foundation Undercut Backfill for Retaining Walls, Grade Separation or Bridges	100.0	FB	
Backfill for Bridges, Culverts, Sewers, Water Main, Manholes, Catch Basins, Edge Drains and Subgrade Undercuts	95.0	B	
Pavement Structure			
Subbase	95.0	S	
Subbase for Slope Paving	90.0	SP	
Aggregate Base-used under Concrete Pavement	95.0	SS	
Aggregate Base-used under HMA Pavement	98.0	AB	
OGDC – used under Concrete and HMA Pavement	95.0	OGDC	
OGDC – used under Concrete and HMA Pavement (recycled material)	95.0	OGR	
HMA Aggregate Base (pulverized HMA used as Aggregate Base)	98.0	BAB	
Aggregate Base – used under Concrete Pavement (recycled material)	95.0	CAC	
Aggregate Base – used under HMA Pavement (recycled material)	98.0	CAB	
OGDC – Sleeper slab footprint and approach area	95.0	SLO	
OGDC – Sleeper slab footprint and approach area (recycled material)	95.0	SLOR	
Aggregate Base – Sleeper slab footprint and approach area	98.0	SLA	
Trenching – under concrete pavement	95.0	TC	
Trenching – under HMA pavement	98.0	TB	
Shoulders – Class I	98.0	SAA	
Shoulders – Class II and III	95.0	SA	
HMA Stabilization	98.0	BS	
HMA Paving – Base Course	92.0*	BB	
HMA Paving – Leveling Course	92.0*	BL	
HMA Paving – Top Course	92.0*	BT	

See JMF (form 1911) for G_{mm} value for target density value. $TMD = G_{mm} \times 62.4$

*Minimum % compaction of JMF TMD

MOISTURE AND DENSITY DETERMINATION NUCLEAR METHOD

DISTRIBUTION: ORIGINAL - Construction Engineer, COPIES - Area Density Specialist, Density Technology Unit (Lansing).

* SEE REVERSE SIDE

DATE 12/13/22	CONTROL SECTION ID POINTE DR BOTTOM ASH BRUSH	JOB NUMBER 2207.19	ROUTE NO. or STREET POINTE DR	GAUGE NO. 37703	
DENSITY INSPECTOR TIM SMITH		CERTIFICATION NO. 12047-0224	DENSITY INSPECTOR PHONE NO. 870 9845596	CONSTRUCTION ENG. (MDOT)	ASST. CON.ENG. / CONSULTANT ENG. PATRICK PHELAN

TEST			DETERMINATION OF IN-PLACE DENSITY								LOCATION OF TEST				
ORIGINAL	RECHECK	TEST DEPTH inch	COUNTS (MC)	COUNTS (DC)	DRY DENSITY PCF	WET DENSITY PCF	MOIS- TURE PCF	MOIS- TURE %	MAX DENSITY PCF	PERCENT OF COM- PACTION	STATION	DISTANCE FROM CL ft		DEPTH BELOW PLAN GRADE ft	ITEM OF WORK
												LEFT	RIGHT		
1	2	3	4	5	6	7	8	9	10	11	12	13	14	15	16
1		12"	190	479	106.5	121.3	14.9	13.9	111.2	95.8	E40 L8				B
2		↓	182	402	110.2	125.1	15.0	13.5	↓	99.0	E39				↓

TEST NO.	MOIS- TURE %	VOLUME OF MOLD CU. FT.	DETERMINATION OF MAXIMUM DENSITY (SOIL & HMA)							MAX DENSITY PCF	OPTIMUM MOISTURE %	NOTE: To convert (g) to (lbs): Wt. (g) + 453.59 = Wt. (lbs)
			WET SOIL + MOLD g	MOLD g	WET SOIL g	WET SOIL lbs	COMPACTED SOIL WET PCF	CHART STANDARDS				
A	B	C	D	E	F	G	H	I	J	DENSITY	MOISTURE	
2	13.2	0.364	4627	2602	2025	4.46	122.6	111.2	16.1		2028	
											2029	680
											OPERATING STANDARDS	
											DENSITY	MOISTURE
											2028	668

REMARKS
clay backfill

20/10 Weights	1st	2nd	DENSITY INSPECTOR'S SIGNATURE 	AGENCY / COMPANY BMS Inc
3rd	4th	5th		

DENSITY REQUIREMENTS

	MINIMUM % OF COMPACTION	ITEM OF WORK	DEPTH
Original Ground			
Road Embankment Areas (if specified on the plans)	90.0	OG	9"
Bridges – as shown on the plans	95.0	OG	9"
Cut Areas			
Cuts requiring Sand Subbase	95.0	CS	9"
Cuts not requiring Sand Subbase	95.0	CN	12"
Subgrade for HMA Base, Aggregate Base and Concrete Widening	95.0	SG	9"
Embankments			
Regular	95.0	E	
Abutments with Piling	95.0	AP	
Abutments without Piling – within the limits for Structure Embankment as shown on the plans	100.0	AN	
Backfill			
Foundation Undercut Backfill for Retaining Walls, Grade Separation or Bridges	100.0	FB	
Backfill for Bridges, Culverts, Sewers, Water Main, Manholes, Catch Basins, Edge Drains and Subgrade Undercuts	95.0	B	
Pavement Structure			
Subbase	95.0	S	
Subbase for Slope Paving	90.0	SP	
Aggregate Base-used under Concrete Pavement	95.0	SS	
Aggregate Base-used under HMA Pavement	98.0	AB	
OGDC – used under Concrete and HMA Pavement	95.0	OGDC	
OGDC – used under Concrete and HMA Pavement (recycled material)	95.0	OGR	
HMA Aggregate Base (pulverized HMA used as Aggregate Base)	98.0	BAB	
Aggregate Base – used under Concrete Pavement (recycled material)	95.0	CAC	
Aggregate Base – used under HMA Pavement (recycled material)	98.0	CAB	
OGDC – Sleeper slab footprint and approach area	95.0	SLO	
OGDC – Sleeper slab footprint and approach area (recycled material)	95.0	SLOR	
Aggregate Base – Sleeper slab footprint and approach area	98.0	SLA	
Trenching – under concrete pavement	95.0	TC	
Trenching – under HMA pavement	98.0	TB	
Shoulders – Class I	98.0	SAA	
Shoulders – Class II and III	95.0	SA	
HMA Stabilization	98.0	BS	
HMA Paving – Base Course	92.0*	BB	
HMA Paving – Leveling Course	92.0*	BL	
HMA Paving – Top Course	92.0*	BT	

See JMF (form 1911) for G_{mm} value for target density value. $TMD = G_{mm} \times 62.4$

*Minimum % compaction of JMF TMD

MOISTURE AND DENSITY DETERMINATION

NUCLEAR METHOD

DISTRIBUTION: ORIGINAL – Construction Engineer, COPIES – Area Density Specialist, Density Technology Unit (Lansing).

* SEE REVERSE SIDE

DATE 2/15/22	CONTROL SECTION ID Pointe De Bottom Basin	JOB NUMBER 2207-19	ROUTE NO. or STREET Pointe De	GAUGE NO. 37703	
DENSITY INSPECTOR Tom Smith		CERTIFICATION NO. 12047-0224	DENSITY INSPECTOR PHONE NO. 810 984 5596	CONSTRUCTION ENG. (MDOT)	ASST. CON. ENG. / CONSULTANT ENG. PATRICK PHELAN

TEST			DETERMINATION OF IN-PLACE DENSITY									LOCATION OF TEST			
ORIGINAL	RECHECK	TEST DEPTH inch	COUNTS (MC)	COUNTS (DC)	DRY DENSITY PCF	WET DENSITY PCF	MOIS- TURE PCF	MOIS- TURE %	MAX DENSITY PCF	PERCENT OF COM- PACTION	STATION	DISTANCE FROM CL ft		DEPTH BELOW PLAN GRADE ft	ITEM OF WORK
												LEFT	RIGHT		
1	2	3	4	5	6	7	8	9	10	11	12	13	14	15	16
1		12	219	433	106.8	124.3	17.6	12.1	111.2	96.0	E45				B
2		↓	200	421	109.4	125.3	15.9	14.5		98.4	WL1				↓
3		↓	202	445	107.5	123.6	16.1	14.7		96.7	WL2				↓

TEST NO.	MOIS- TURE %	VOLUME OF MOLD CU. FT.	DETERMINATION OF MAXIMUM DENSITY (SOIL & HMA)							MAX DENSITY PCF	OPTIMUM MOISTURE %	NOTE: To convert (g) to (lbs): Wt. (g) ÷ 453.59 = Wt. (lbs)
			WET SOIL + MOLD g	MOLD g	WET SOIL g	WET SOIL lbs	COMPACTED SOIL WET PCF	CHART STANDARDS				
A	B	C	D	E	F	G	H		I	J		
2	13.2	0.0364	4627	2602	2025	4.46	122.6	111.2	16.1		DENSITY	
											2028	654
											2069	680
											OPERATING STANDARDS	
											DENSITY	MOISTURE
											2032	662

REMARKS
2, 3 South EWB East basin lifts with Dazora and Sheeps feet

20/10 Weights	1st	2nd	DENSITY INSPECTOR'S SIGNATURE 	AGENCY / COMPANY BMS Inc
3rd	4th	5th		

DENSITY REQUIREMENTS

	MINIMUM % OF COMPACTION	ITEM OF WORK	DEPTH
Original Ground			
Road Embankment Areas (if specified on the plans)	90.0	OG	9"
Bridges – as shown on the plans	95.0	OG	9"
Cut Areas			
Cuts requiring Sand Subbase	95.0	CS	9"
Cuts not requiring Sand Subbase	95.0	CN	12"
Subgrade for HMA Base, Aggregate Base and Concrete Widening	95.0	SG	9"
Embankments			
Regular	95.0	E	
Abutments with Piling	95.0	AP	
Abutments without Piling – within the limits for Structure Embankment as shown on the plans	100.0	AN	
Backfill			
Foundation Undercut Backfill for Retaining Walls, Grade Separation or Bridges.....	100.0	FB	
Backfill for Bridges, Culverts, Sewers, Water Main, Manholes, Catch Basins, Edge Drains and Subgrade Undercuts	95.0	B	
Pavement Structure			
Subbase	95.0	S	
Subbase for Slope Paving	90.0	SP	
Aggregate Base-used under Concrete Pavement.....	95.0	SS	
Aggregate Base-used under HMA Pavement.....	98.0	AB	
OGDC – used under Concrete and HMA Pavement.....	95.0	OGDC	
OGDC – used under Concrete and HMA Pavement (recycled material).....	95.0	OGR	
HMA Aggregate Base (pulverized HMA used as Aggregate Base)	98.0	BAB	
Aggregate Base – used under Concrete Pavement (recycled material).....	95.0	CAC	
Aggregate Base – used under HMA Pavement (recycled material).....	98.0	CAB	
OGDC – Sleeper slab footprint and approach area.....	95.0	SLO	
OGDC – Sleeper slab footprint and approach area (recycled material)	95.0	SLOR	
Aggregate Base – Sleeper slab footprint and approach area.....	98.0	SLA	
Trenching – under concrete pavement	95.0	TC	
Trenching – under HMA pavement	98.0	TB	
Shoulders – Class I	98.0	SAA	
Shoulders – Class II and III	95.0	SA	
HMA Stabilization	98.0	BS	
HMA Paving – Base Course	92.0*	BB	
HMA Paving – Leveling Course	92.0*	BL	
HMA Paving – Top Course	92.0*	BT	

See JMF (form 1911) for G_{mm} value for target density value. $TMD = G_{mm} \times 62.4$

*Minimum % compaction of JMF TMD

MOISTURE AND DENSITY DETERMINATION NUCLEAR METHOD

DISTRIBUTION: ORIGINAL – Construction Engineer, COPIES – Area Density Specialist, Density Technology Unit (Lansing).

* SEE REVERSE SIDE

DATE 12/21/22	CONTROL SECTION ID Pointe DR Ash Pond Basin	JOB NUMBER 2207.19	ROUTE NO. or STREET Pointe DR	GAUGE NO. 37763
DENSITY INSPECTOR TIM SMITH		CERTIFICATION NO. 12047-0224	DENSITY INSPECTOR PHONE NO. 8109845596	CONSTRUCTION ENG. (MDOT) PATRICK PIRZAN

TEST			DETERMINATION OF IN-PLACE DENSITY									LOCATION OF TEST			
ORIGINAL	RECHECK	TEST DEPTH inch	COUNTS (MC)	COUNTS (DC)	DRY DENSITY PCF	WET DENSITY PCF	MOIS- TURE PCF	MOIS- TURE %	MAX DENSITY PCF	PERCENT OF COM- PACTION	STATION	DISTANCE FROM CL ft		DEPTH BELOW PLAN GRADE ft	ITEM OF WORK
												LEFT	RIGHT		
1	2	3	4	5	6	7	8	9	10	11	12	13	14	15	16
1		12"	166	491	110.4	123.3	12.9	11.7	111.2	99.3	W1				B
2		↓	183	506	109.2	123.6	14.4	12.7		98.2	L4				↓
3		↓	135	485	111.6	121.2	10.2	9.2		99.9	L3				↓

TEST NO.	MOIS- TURE %	VOLUME OF MOLD CU. FT.	DETERMINATION OF MAXIMUM DENSITY (SOIL & HMA)							NOTE: To convert (g) to (lbs): Wt. (g) + 453.59 = Wt. (lbs)	
			WET SOIL + MOLD g	MOLD g	WET SOIL g	WET SOIL lbs	COMPACTED SOIL WET PCF	MAX DENSITY PCF	OPTIMUM MOISTURE %	CHART STANDARDS	
A	B	C	D	E	F	G	H	I	J	DENSITY	MOISTURE
2	13.2	0.0364	4627	2602	2025	4.46	122.6	111.2	16.1	2028	654
										2069	680
										OPERATING STANDARDS	
										DENSITY	MOISTURE
										2032	660

REMARKS

1- West Pond Front SE corner

2- East Pond East side South end of Middle 1/3

3- East Pond North end Center of North 1/3

20/10 Weights	1st	2nd	DENSITY INSPECTOR'S SIGNATURE 	AGENCY / COMPANY BMT Inc
3rd	4th	5th		

DENSITY REQUIREMENTS

	MINIMUM % OF COMPACTION	ITEM OF WORK	DEPTH
Original Ground			
Road Embankment Areas (if specified on the plans)	90.0	OG	9"
Bridges – as shown on the plans	95.0	OG	9"
Cut Areas			
Cuts requiring Sand Subbase	95.0	CS	9"
Cuts not requiring Sand Subbase	95.0	CN	12"
Subgrade for HMA Base, Aggregate Base and Concrete Widening	95.0	SG	9"
Embankments			
Regular	95.0	E	
Abutments with Piling	95.0	AP	
Abutments without Piling – within the limits for Structure Embankment as shown on the plans	100.0	AN	
Backfill			
Foundation Undercut Backfill for Retaining Walls, Grade Separation or Bridges	100.0	FB	
Backfill for Bridges, Culverts, Sewers, Water Main, Manholes, Catch Basins, Edge Drains and Subgrade Undercuts	95.0	B	
Pavement Structure			
Subbase	95.0	S	
Subbase for Slope Paving	90.0	SP	
Aggregate Base-used under Concrete Pavement	95.0	SS	
Aggregate Base-used under HMA Pavement	98.0	AB	
OGDC – used under Concrete and HMA Pavement	95.0	OGDC	
OGDC – used under Concrete and HMA Pavement (recycled material)	95.0	OGR	
HMA Aggregate Base (pulverized HMA used as Aggregate Base)	98.0	BAB	
Aggregate Base – used under Concrete Pavement (recycled material)	95.0	CAC	
Aggregate Base – used under HMA Pavement (recycled material)	98.0	CAB	
OGDC – Sleeper slab footprint and approach area	95.0	SLO	
OGDC – Sleeper slab footprint and approach area (recycled material)	95.0	SLOR	
Aggregate Base – Sleeper slab footprint and approach area	98.0	SLA	
Trenching – under concrete pavement	95.0	TC	
Trenching – under HMA pavement	98.0	TB	
Shoulders – Class I	98.0	SAA	
Shoulders – Class II and III	95.0	SA	
HMA Stabilization	98.0	BS	
HMA Paving – Base Course	92.0*	BB	
HMA Paving – Leveling Course	92.0*	BL	
HMA Paving – Top Course	92.0*	BT	

See JMF (form 1911) for G_{mm} value for target density value. $TMD = G_{mm} \times 62.4$

*Minimum % compaction of JMF TMD

MOISTURE AND DENSITY DETERMINATION NUCLEAR METHOD

DISTRIBUTION: ORIGINAL – Construction Engineer, COPIES – Area Density Specialist, Density Technology Unit (Lansing).

* SEE REVERSE SIDE

DATE 12/27/22	CONTROL SECTION ID DTE Bottom Ash Basin	JOB NUMBER 2207.19	ROUTE NO. or STREET POINT DR	GAUGE NO. 36231
DENSITY INSPECTOR TIMOTHY M. KELCH	CERTIFICATION NO. 11262-0226	DENSITY INSPECTOR PHONE NO. 810-984-5596	CONSTRUCTION ENG. (MDOT)	ASST. CON. ENG. / CONSULTANT ENG. PATRICK PHELAN

TEST			DETERMINATION OF IN-PLACE DENSITY								LOCATION OF TEST				
ORIGINAL	RECHECK	TEST DEPTH inch	COUNTS (MC)	COUNTS (DC)	DRY DENSITY PCF	WET DENSITY PCF	MOIS- TURE PCF	MOIS- TURE %	MAX DENSITY PCF	PERCENT OF COM- PACTION	STATION	DISTANCE FROM CL ft		DEPTH BELOW PLAN GRADE ft	ITEM OF WORK *
												LEFT	RIGHT		
1	2	3	4	5	6	7	8	9	10	11	12	13	14	15	16
1		12"	153	507	103.0	116.9	131	12.6	108.7	95.6					S

TEST NO.	MOIS- TURE %	VOLUME OF MOLD CU. FT.	DETERMINATION OF MAXIMUM DENSITY (SOIL & HMA)							NOTE: To convert (g) to (lbs): Wt. (g) ÷ 453.59 = Wt. (lbs)		
			WET SOIL + MOLD g	MOLD g	WET SOIL g	WET SOIL lbs	COMPACTED SOIL WET PCF	MAX DENSITY PCF	OPTIMUM MOISTURE %			
A	B	C	D	E	F	G	H	I	J	CHART STANDARDS		
											DENSITY	MOISTURE
											1920	617
											1882	593
											OPERATING STANDARDS	
											DENSITY	MOISTURE
											1918	604

REMARKS

20/10 Weights	1st	2nd	DENSITY INSPECTOR'S SIGNATURE	AGENCY / COMPANY
3rd	4th	5th	<i>Timothy M. Kelch</i>	BMS

MOISTURE AND DENSITY DETERMINATION NUCLEAR METHOD

DISTRIBUTION: ORIGINAL - Construction Engineer, COPIES - Area Density Specialist, Density Technology Unit (Lansing).

* SEE REVERSE SIDE

DATE 11/5/22	CONTROL SECTION ID Pointe DE Bottom Ash Basin	JOB NUMBER 2207.19	ROUTE NO. or STREET Pointe DE	GAUGE NO. 57703
DENSITY INSPECTOR Tim Smith		CERTIFICATION NO. 12047-0224	DENSITY INSPECTOR PHONE NO. 8109845596	CONSTRUCTION ENG. (MDOT) ASST. CON. ENG. / CONSULTANT ENG. PATRICK P KOLAN

TEST			DETERMINATION OF IN-PLACE DENSITY									LOCATION OF TEST			
ORIGINAL 1	RECHECK 2	TEST DEPTH inch 3	COUNTS (MC) 4	COUNTS (DC) 5	DRY DENSITY PCF 6	WET DENSITY PCF 7	MOIS- TURE PCF 8	MOIS- TURE % 9	MAX DENSITY PCF 10	PERCENT OF COM- PACTION 11	STATION 12	DISTANCE FROM CL ft		DEPTH BELOW PLAN GRADE ft 15	ITEM OF WORK 16
												LEFT 13	RIGHT 14		
1		12	201	433	108.7	124.8	16.1	14.8	111.2	97.8	W24				B

TEST NO. A	MOIS- TURE % B	VOLUME OF MOLD CU. FT. C	DETERMINATION OF MAXIMUM DENSITY (SOIL & HMA)							OPTIMUM MOISTURE % J	NOTE: To convert (g) to (lbs): Wt. (g) + 453.59 = Wt. (lbs)
			WET SOIL + MOLD g D	MOLD g E	WET SOIL g F	WET SOIL lbs G	COMPACTED SOIL WET PCF H	MAX DENSITY PCF I			
2	13.2	0.0364	4627	2602	2025	4.46	122.6	111.2	16.1	CHART STANDARDS DENSITY MOISTURE 2024 654 2065 680	
										OPERATING STANDARDS DENSITY MOISTURE 2059 658	

REMARKS

20/10 Weights	1st	2nd	DENSITY INSPECTOR'S SIGNATURE 	AGENCY / COMPANY BMJ Inc
	4th	5th		

DENSITY REQUIREMENTS

	MINIMUM % OF COMPACTION	ITEM OF WORK	DEPTH
Original Ground			
Road Embankment Areas (if specified on the plans)	90.0	OG	9"
Bridges – as shown on the plans	95.0	OG	9"
Cut Areas			
Cuts requiring Sand Subbase	95.0	CS	9"
Cuts not requiring Sand Subbase	95.0	CN	12"
Subgrade for HMA Base, Aggregate Base and Concrete Widening	95.0	SG	9"
Embankments			
Regular	95.0	E	
Abutments with Piling	95.0	AP	
Abutments without Piling – within the limits for Structure Embankment as shown on the plans	100.0	AN	
Backfill			
Foundation Undercut Backfill for Retaining Walls, Grade Separation or Bridges	100.0	FB	
Backfill for Bridges, Culverts, Sewers, Water Main, Manholes, Catch Basins, Edge Drains and Subgrade Undercuts	95.0	B	
Pavement Structure			
Subbase	95.0	S	
Subbase for Slope Paving	90.0	SP	
Aggregate Base-used under Concrete Pavement	95.0	SS	
Aggregate Base-used under HMA Pavement	98.0	AB	
OGDC – used under Concrete and HMA Pavement	95.0	OGDC	
OGDC – used under Concrete and HMA Pavement (recycled material)	95.0	OGR	
HMA Aggregate Base (pulverized HMA used as Aggregate Base)	98.0	BAB	
Aggregate Base – used under Concrete Pavement (recycled material)	95.0	CAC	
Aggregate Base – used under HMA Pavement (recycled material)	98.0	CAB	
OGDC – Sleeper slab footprint and approach area	95.0	SLO	
OGDC – Sleeper slab footprint and approach area (recycled material)	95.0	SLOR	
Aggregate Base – Sleeper slab footprint and approach area	98.0	SLA	
Trenching – under concrete pavement	95.0	TC	
Trenching – under HMA pavement	98.0	TB	
Shoulders – Class I	98.0	SAA	
Shoulders – Class II and III	95.0	SA	
HMA Stabilization	98.0	BS	
HMA Paving – Base Course	92.0*	BB	
HMA Paving – Leveling Course	92.0*	BL	
HMA Paving – Top Course	92.0*	BT	

See JMF (form 1911) for G_{mm} value for target density value. $TMD = G_{mm} \times 62.4$

*Minimum % compaction of JMF TMD

MOISTURE AND DENSITY DETERMINATION

NUCLEAR METHOD

DISTRIBUTION: ORIGINAL – Construction Engineer, COPIES – Area Density Specialist, Density Technology Unit (Lansing).

* SEE REVERSE SIDE

DATE <u>1/10/22</u>	CONTROL SECTION ID <u>Pointe Dr Boffman/Asht, Basil</u>	JOB NUMBER <u>2207-19</u>	ROUTE NO. or STREET <u>Pointe Dr</u>	GAUGE NO. <u>37703</u>
DENSITY INSPECTOR <u>Tim Smith</u>		CERTIFICATION NO. <u>12047-0224</u>	DENSITY INSPECTOR PHONE NO. <u>810 984 5596</u>	CONSTRUCTION ENG. (MDOT) <u>PATRICK PHELWAN</u>

TEST			DETERMINATION OF IN-PLACE DENSITY									LOCATION OF TEST			
ORIGINAL	RECHECK	TEST DEPTH inch	COUNTS (MC)	COUNTS (DC)	DRY DENSITY PCF	WET DENSITY PCF	MOIS- TURE PCF	MOIS- TURE %	MAX DENSITY PCF	PERCENT OF COM- PACTION	STATION	DISTANCE FROM CL ft		DEPTH BELOW PLAN GRADE ft	ITEM OF WORK
												LEFT	RIGHT		
1	2	3	4	5	6	7	8	9	10	11	12	13	14	15	16
<u>1</u>		<u>12"</u>	<u>196</u>	<u>509</u>	<u>109.2</u>	<u>124.7</u>	<u>15.5</u>	<u>13.6</u>	<u>111.2</u>	<u>98.52</u>	<u>W36L1</u>				<u>B</u>
<u>2</u>		<u>↓</u>	<u>168</u>	<u>511</u>	<u>109.1</u>	<u>122.1</u>	<u>13.0</u>	<u>12.0</u>	<u>111.2</u>	<u>98.1</u>	<u>W36</u>				<u>↓</u>

TEST NO.	MOIS- TURE %	VOLUME OF MOLD CU. FT.	DETERMINATION OF MAXIMUM DENSITY (SOIL & HMA)							MAX DENSITY PCF	OPTIMUM MOISTURE %	NOTE: To convert (g) to (lbs): Wt. (g) + 453.59 = Wt. (lbs)
			WET SOIL + MOLD g	MOLD g	WET SOIL g	WET SOIL lbs	COMPACTED SOIL WET PCF					
A	B	C	D	E	F	G	H	I	J			
<u>2</u>	<u>13.2</u>	<u>0.0364</u>	<u>4627</u>	<u>2602</u>	<u>2025</u>	<u>4.46</u>	<u>122.6</u>	<u>111.2</u>	<u>16.1</u>			

CHART STANDARDS	
DENSITY	MOISTURE
<u>2024</u>	<u>654</u>
<u>2065</u>	<u>680</u>

OPERATING STANDARDS	
DENSITY	MOISTURE
<u>2042</u>	<u>665</u>

REMARKS

20/10 Weights	1st	2nd	DENSITY INSPECTOR'S SIGNATURE 	AGENCY / COMPANY <u>BMS Inc</u>
3rd	4th	5th		

DENSITY REQUIREMENTS

	MINIMUM % OF COMPACTION	ITEM OF WORK	DEPTH
Original Ground			
Road Embankment Areas (if specified on the plans)	90.0	OG	9"
Bridges – as shown on the plans	95.0	OG	9"
Cut Areas			
Cuts requiring Sand Subbase	95.0	CS	9"
Cuts not requiring Sand Subbase	95.0	CN	12"
Subgrade for HMA Base, Aggregate Base and Concrete Widening	95.0	SG	9"
Embankments			
Regular	95.0	E	
Abutments with Piling	95.0	AP	
Abutments without Piling – within the limits for Structure Embankment as shown on the plans	100.0	AN	
Backfill			
Foundation Undercut Backfill for Retaining Walls, Grade Separation or Bridges	100.0	FB	
Backfill for Bridges, Culverts, Sewers, Water Main, Manholes, Catch Basins, Edge Drains and Subgrade Undercuts	95.0	B	
Pavement Structure			
Subbase	95.0	S	
Subbase for Slope Paving	90.0	SP	
Aggregate Base-used under Concrete Pavement	95.0	SS	
Aggregate Base-used under HMA Pavement	98.0	AB	
OGDC – used under Concrete and HMA Pavement	95.0	OGDC	
OGDC – used under Concrete and HMA Pavement (recycled material)	95.0	OGR	
HMA Aggregate Base (pulverized HMA used as Aggregate Base)	98.0	BAB	
Aggregate Base – used under Concrete Pavement (recycled material)	95.0	CAC	
Aggregate Base – used under HMA Pavement (recycled material)	98.0	CAB	
OGDC – Sleeper slab footprint and approach area	95.0	SLO	
OGDC – Sleeper slab footprint and approach area (recycled material)	95.0	SLOR	
Aggregate Base – Sleeper slab footprint and approach area	98.0	SLA	
Trenching – under concrete pavement	95.0	TC	
Trenching – under HMA pavement	98.0	TB	
Shoulders – Class I	98.0	SAA	
Shoulders – Class II and III	95.0	SA	
HMA Stabilization	98.0	BS	
HMA Paving – Base Course	92.0*	BB	
HMA Paving – Leveling Course	92.0*	BL	
HMA Paving – Top Course	92.0*	BT	

See JMF (form 1911) for G_{mm} value for target density value. $TMD = G_{mm} \times 62.4$

*Minimum % compaction of JMF TMD

MOISTURE AND DENSITY DETERMINATION

NUCLEAR METHOD

DISTRIBUTION: ORIGINAL - Construction Engineer, COPIES - Area Density Specialist, Density Technology Unit (Lansing).

* SEE REVERSE SIDE

DATE 2/2/23	CONTROL SECTION ID POINTE DR Bottom Ash	JOB NUMBER 2207.19	ROUTE NO. or STREET POINTE DR	GAUGE NO. 36231
DENSITY INSPECTOR Tim Smith		CERTIFICATION NO. 12047-0224	DENSITY INSPECTOR PHONE NO. 810 984 5576	CONSTRUCTION ENG. (MDOT) FATRICK PHELAN
ASST. CON.ENG. / CONSULTANT ENG.				

TEST			DETERMINATION OF IN-PLACE DENSITY									LOCATION OF TEST			
ORIGINAL	RECHECK	TEST DEPTH inch	COUNTS (MC)	COUNTS (DC)	DRY DENSITY PCF	WET DENSITY PCF	MOIS- TURE PCF	MOIS- TURE %	MAX DENSITY PCF	PERCENT OF COM- PACTION	STATION	DISTANCE FROM CL ft		DEPTH BELOW PLAN GRADE ft	ITEM OF WORK *
												LEFT	RIGHT		
1	2	3	4	5	6	7	8	9	10	11	12	13	14	15	16
1		12	178	336	113.9	129.5	15.4	13.7	115.4	98.7	W-S				B
2		12	179	346	112.9	128.6	15.7	13.9	115.4	97.8	W-M				B

TEST NO.	MOIS- TURE %	VOLUME OF MOLD CU. FT.	DETERMINATION OF MAXIMUM DENSITY (SOIL & HMA)							NOTE:													
			WET SOIL + MOLD g	MOLD g	WET SOIL g	WET SOIL lbs	COMPACTED SOIL WET PCF	MAX DENSITY PCF	OPTIMUM MOISTURE %	To convert (g) to (lbs): Wt. (g) ÷ 453.59 = Wt. (lbs)													
A	B	C	D	E	F	G	H	I	J	CHART STANDARDS													
3	13.7	0.0364	4751	2602	2149	4.74	130.2	115.4	14.5	<table border="1" style="width: 100%; text-align: center;"> <tr><td>DENSITY</td><td>MOISTURE</td></tr> <tr><td>1878</td><td>593</td></tr> <tr><td>1916</td><td>617</td></tr> <tr><td colspan="2">OPERATING STANDARDS</td></tr> <tr><td>DENSITY</td><td>MOISTURE</td></tr> <tr><td>1903</td><td>601</td></tr> </table>		DENSITY	MOISTURE	1878	593	1916	617	OPERATING STANDARDS		DENSITY	MOISTURE	1903	601
DENSITY	MOISTURE																						
1878	593																						
1916	617																						
OPERATING STANDARDS																							
DENSITY	MOISTURE																						
1903	601																						

REMARKS

1 - West pond center of South 1/3

2 - West pond East side of Middle 1/3

20/10 Weights	1st	2nd	DENSITY INSPECTOR'S SIGNATURE 	AGENCY / COMPANY BMT Inc
3rd	4th	5th		

DENSITY REQUIREMENTS

	MINIMUM % OF COMPACTION	ITEM OF WORK	DEPTH
Original Ground			
Road Embankment Areas (if specified on the plans)	90.0	OG	9"
Bridges – as shown on the plans	95.0	OG	9"
Cut Areas			
Cuts requiring Sand Subbase	95.0	CS	9"
Cuts not requiring Sand Subbase	95.0	CN	12"
Subgrade for HMA Base, Aggregate Base and Concrete Widening	95.0	SG	9"
Embankments			
Regular	95.0	E	
Abutments with Piling	95.0	AP	
Abutments without Piling – within the limits for Structure Embankment as shown on the plans	100.0	AN	
Backfill			
Foundation Undercut Backfill for Retaining Walls, Grade Separation or Bridges	100.0	FB	
Backfill for Bridges, Culverts, Sewers, Water Main, Manholes, Catch Basins, Edge Drains and Subgrade Undercuts	95.0	B	
Pavement Structure			
Subbase	95.0	S	
Subbase for Slope Paving	90.0	SP	
Aggregate Base-used under Concrete Pavement	95.0	SS	
Aggregate Base-used under HMA Pavement	98.0	AB	
OGDC – used under Concrete and HMA Pavement	95.0	OGDC	
OGDC – used under Concrete and HMA Pavement (recycled material)	95.0	OGR	
HMA Aggregate Base (pulverized HMA used as Aggregate Base)	98.0	BAB	
Aggregate Base – used under Concrete Pavement (recycled material)	95.0	CAC	
Aggregate Base – used under HMA Pavement (recycled material)	98.0	CAB	
OGDC – Sleeper slab footprint and approach area	95.0	SLO	
OGDC – Sleeper slab footprint and approach area (recycled material)	95.0	SLOR	
Aggregate Base – Sleeper slab footprint and approach area	98.0	SLA	
Trenching – under concrete pavement	95.0	TC	
Trenching – under HMA pavement	98.0	TB	
Shoulders – Class I	98.0	SAA	
Shoulders – Class II and III	95.0	SA	
HMA Stabilization	98.0	BS	
HMA Paving – Base Course	92.0*	BB	
HMA Paving – Leveling Course	92.0*	BL	
HMA Paving – Top Course	92.0*	BT	

See JMF (form 1911) for G_{mm} value for target density value. $TMD = G_{mm} \times 62.4$

*Minimum % compaction of JMF TMD

MOISTURE AND DENSITY DETERMINATION
NUCLEAR METHOD

FILE 301

DISTRIBUTION: ORIGINAL - Construction Engineer, COPIES - Area Density Specialist, Density Technology Unit (Lansing).

* SEE REVERSE SIDE

DATE <i>2/8/23</i>	CONTROL SECTION ID <i>Prince Dr Bottom Ash</i>	JOB NUMBER <i>2207.19</i>	ROUTE NO. or STREET <i>Prince Dr</i>	GAUGE NO. <i>36231</i>
DENSITY INSPECTOR <i>Tim Smith</i>	CERTIFICATION NO. <i>12047-0201</i>	DENSITY INSPECTOR PHONE NO. <i>8109845596</i>	CONSTRUCTION ENG. (MDOT)	ASST. CON.ENG. / CONSULTANT ENG. <i>DARRELL PHELAN</i>

TEST			DETERMINATION OF IN-PLACE DENSITY								LOCATION OF TEST				
ORIGINAL	RECHECK	TEST DEPTH inch	COUNTS (MC)	COUNTS (DC)	DRY DENSITY PCF	WET DENSITY PCF	MOIS- TURE PCF	MOIS- TURE %	MAX DENSITY PCF	PERCENT OF COM- PACTION	STATION	DISTANCE FROM CL ft		DEPTH BELOW PLAN GRADE ft	ITEM OF WORK
												LEFT	RIGHT		
1	2	3	4	5	6	7	8	9	10	11	12	13	14	15	16
<i>1</i>		<i>12</i>	<i>183</i>	<i>355</i>	<i>112.1</i>	<i>128.1</i>	<i>16.0</i>	<i>13.6</i>	<i>115.4</i>	<i>97.1</i>		<i>See</i>		<i>3</i>	<i>B</i>
<i>2</i>		<i>12</i>	<i>176</i>	<i>362</i>	<i>111.8</i>	<i>127.1</i>	<i>15.4</i>	<i>13.7</i>	<i>115.4</i>	<i>96.9</i>		<i>Rem. 225</i>		<i>3</i>	<i>B</i>

TEST NO.	MOIS- TURE %	VOLUME OF MOLD CU. FT.	DETERMINATION OF MAXIMUM DENSITY (SOIL & HMA)							MAX DENSITY PCF	OPTIMUM MOISTURE %	NOTE: To convert (g) to (lbs): Wt. (g) ÷ 453.59 = Wt. (lbs)	
			WET SOIL + MOLD g	MOLD g	WET SOIL g	WET SOIL lbs	COMPACTED SOIL WET PCF	CHART STANDARDS					
D	E	F	G	H	I	J	DENSITY		MOISTURE				
							OPERATING STANDARDS		DENSITY	MOISTURE			
<i>3</i>	<i>13.9</i>	<i>.6364</i>	<i>4751</i>	<i>2602</i>	<i>2149</i>	<i>4.74</i>	<i>130.2</i>	<i>115.4</i>	<i>14.5</i>			<i>1874</i>	<i>573</i>
												<i>1912</i>	<i>617</i>
												<i>1903</i>	<i>601</i>

REMARKS
1 - middle of North 1/3 west part
2 - middle of center 1/3 west part

20/10 Weights	1st	2nd	DENSITY INSPECTOR'S SIGNATURE <i>[Signature]</i>	AGENCY / COMPANY <i>BMS Inc</i>
3rd	4th	5th		

MOISTURE AND DENSITY DETERMINATION NUCLEAR METHOD

DISTRIBUTION: ORIGINAL - Construction Engineer, COPIES - Area Density Specialist, Density Technology Unit (Lansing).

* SEE REVERSE SIDE

DATE 2/22/23	CONTROL SECTION ID Pointe De Bottom 4th	JOB NUMBER 2207-19	ROUTE NO. or STREET Pointe DE	GAUGE NO. 36231
DENSITY INSPECTOR Tim Smith		CERTIFICATION NO. 12047-0224	DENSITY INSPECTOR PHONE NO. 810 984 5596	CONSTRUCTION ENG. (MDOT) PATRICK PHELAN

TEST			DETERMINATION OF IN-PLACE DENSITY									LOCATION OF TEST			
ORIGINAL	RECHECK	TEST DEPTH inch	COUNTS (MC)	COUNTS (DC)	DRY DENSITY PCF	WET DENSITY PCF	MOIS- TURE PCF	MOIS- TURE %	MAX DENSITY PCF	PERCENT OF COM- PACTION	STATION	DISTANCE FROM CL ft		DEPTH BELOW PLAN GRADE ft	ITEM OF WORK *
												LEFT	RIGHT		
1	2	3	4	5	6	7	8	9	10	11	12	13	14	15	16
1		12	171	338	114.3	129.3	15.0	13.1	115.4	99.1	SEE			1	B
2		12	176	336	114.5	129.5	15.0	13.1	115.4	99.6	NOTES			3	B

TEST NO.	MOIS- TURE %	VOLUME OF MOLD CU. FT.	DETERMINATION OF MAXIMUM DENSITY (SOIL & HMA)								NOTE: To convert (g) to (lbs): Wt. (g) + 453.59 = Wt. (lbs)
			WET SOIL + MOLD g	MOLD g	WET SOIL g	WET SOIL lbs	COMPACTED SOIL WET PCF	MAX DENSITY PCF	OPTIMUM MOISTURE %		
A	B	C	D	E	F	G	H	I	J	CHART STANDARDS	
3	13.9	1.0364	4751	2602	2449	4.74	130.2	115.4	14.5	DENSITY	
										1874	
										1912	
										593	
										617	
										OPERATING STANDARDS	
										DENSITY	
										1904	
										596	

REMARKS
 1. West pond Center of Middle Y3
 2. East Pond Center of North Y3

20/10 Weights	1st	2nd	DENSITY INSPECTOR'S SIGNATURE 	AGENCY / COMPANY B.H.S Inc
3rd	4th	5th		

DENSITY REQUIREMENTS

	MINIMUM % OF COMPACTION	ITEM OF WORK	DEPTH
Original Ground			
Road Embankment Areas (if specified on the plans)	90.0	OG	9"
Bridges – as shown on the plans	95.0	OG	9"
Cut Areas			
Cuts requiring Sand Subbase	95.0	CS	9"
Cuts not requiring Sand Subbase	95.0	CN	12"
Subgrade for HMA Base, Aggregate Base and Concrete Widening	95.0	SG	9"
Embankments			
Regular	95.0	E	
Abutments with Piling	95.0	AP	
Abutments without Piling – within the limits for Structure Embankment as shown on the plans	100.0	AN	
Backfill			
Foundation Undercut Backfill for Retaining Walls, Grade Separation or Bridges	100.0	FB	
Backfill for Bridges, Culverts, Sewers, Water Main, Manholes, Catch Basins, Edge Drains and Subgrade Undercuts	95.0	B	
Pavement Structure			
Subbase	95.0	S	
Subbase for Slope Paving	90.0	SP	
Aggregate Base-used under Concrete Pavement	95.0	SS	
Aggregate Base-used under HMA Pavement	98.0	AB	
OGDC – used under Concrete and HMA Pavement	95.0	OGDC	
OGDC – used under Concrete and HMA Pavement (recycled material)	95.0	OGR	
HMA Aggregate Base (pulverized HMA used as Aggregate Base)	98.0	BAB	
Aggregate Base – used under Concrete Pavement (recycled material)	95.0	CAC	
Aggregate Base – used under HMA Pavement (recycled material)	98.0	CAB	
OGDC – Sleeper slab footprint and approach area	95.0	SLO	
OGDC – Sleeper slab footprint and approach area (recycled material)	95.0	SLOR	
Aggregate Base – Sleeper slab footprint and approach area	98.0	SLA	
Trenching – under concrete pavement	95.0	TC	
Trenching – under HMA pavement	98.0	TB	
Shoulders – Class I	98.0	SAA	
Shoulders – Class II and III	95.0	SA	
HMA Stabilization	98.0	BS	
HMA Paving – Base Course	92.0*	BB	
HMA Paving – Leveling Course	92.0*	BL	
HMA Paving – Top Course	92.0*	BT	

See JMF (form 1911) for G_{mm} value for target density value. $TMD = G_{mm} \times 62.4$

*Minimum % compaction of JMF TMD

Appendix E - 4 Earthworks – Backfill Volume

Topo Before Fill -VS- Finish Grade



Appendix F

Project Submittals

Appendix F - 1

Contractor Project Execution Plan



800 Gratiot Blvd.
Marysville, Michigan 48040
(810) 364-6881 Fax (810) 364-6450

DTE

Bottom Ash Pond Closures PMP Number: 17033
St. Clair Power Plant (STCPP), East China Township, St. Clair County, Michigan
Execution Plan
Portland Cement Slurry Method

Raymond Excavating Company is pleased to provide the following Execution Plan for the above-referenced project for your review.

Executive Summary

Raymond excavating will provide construction services to complete the removal and relocation of the existing Bottom Ash Material as per the design plans and specifications provided dated February 15, 2022. The scope of work is essentially the removal of standing free water, mixing/stabilizing, excavation and hauling to Range Road Landfill of the existing Coal Combustion Residuals (CCRs) and 6" of the underlying soils. Also included in the scope is the isolation of the Basins from current discharges, Capping/filling and isolating all pipes discharging into the BABs. Temporary water management, incidental work to control rain water via pumping and channels. Final completion incorporates the restoration of disturbed areas.

Overall Project Plan

Raymond Excavating will provide equipment and labor as required to perform work such as Installation of erosion and Site control measures, temporary water management, capping/filling and isolating all pipes discharging into the BABs, removal of all CCR material from within the BABs, transportation and disposal of all excavated material to the Range Road Landfill, backfill and grade each BAB with clean common fill and restore all disturbed areas.

Upon establishing the required soil erosion and sedimentation controls, we will begin dewatering the basins.

Dewatering and removal of standing surface water will commence as soon as possible. Sump pits will be constructed as needed to control run off and standing water and facilitate removal, filtering and discharge compliant with the STCPP NPDES permit (MI0001686) discharge requirements and Section 312319. (See Sheet Dewatering Plan")

Concurrent to the ongoing water removal and control, we will begin operations related to capping/filling and isolating all pipes discharging into the BABs as well as erection of the reagent mixing plant on site and commence mixing operations in the basins. It is our intent to alternate from basin to basin as the material condition dictates.

The existing basins will be divided into predetermined cells utilizing GPS equipment to accurately track the mixed areas. (See Attachment A) The onboard GPS and computers on the specialized reagent delivery system and mixers will determine and track the volume of Bottom Ash material to be mixed in each cell, and the predetermined required volume of Portland cement reagent introduced into each cell. The blender operator is able to view the limits of the

cell utilizing an onboard computer. The plant operator views the same information, and is able to adjust the rate of reagent delivery to match the mixing progress of the blender.

Survey control points have been established in the project area to facilitate accurate tracking of Bottom Ash volumes in each cell. The anticipated bottom elevation of the in-place-stabilization (ISS) work has been provided in the Barr Engineering drawings. Utilizing GPS, the mixing operator will establish the average top elevation of each cell, as it varies substantially across the project. If changes in the bottom elevation are encountered, the soil volume calculations will be based on the elevations determined in the field. Reports indicating the soil volume for cement delivery and payment will be based on the top of sludge figures. Reports indicating this information and verification will be provided to the owner.

An Excel workbook will calculate the quantity of reagent required for each cell based on soil volume and the mix design for each cell. Changes can be made in the field quickly as conditions warrant. An onboard computer monitors the volume of reagent required for each cell, and automatically shuts off delivery of reagent when the designated volume has been delivered preventing any inadvertent overdosing. A color-coded map showing the cells can be downloaded that verifies the cells have been mixed to the horizontal and vertical limits specified. The plant computer also records the cell designation, the quantity of reagent delivered to each cell and the time that cell was completed.

The solidified treated sludge will be removed by in a separate operation and delivered to the Range Road landfill for disposal. The removal operations will follow behind the mixing operations with sufficient lag to allow a buffer of mixed material to act as a separation wall between the excavated areas and the unmixed CCR material.

Removal of the solidified treated sludge and placement of the clean fill will be a three-phase operation for each basin. First the solidified treated sludge in the center portions of each basin will be removed to within 15 feet from the sheeting and replaced with clean compacted fill to an elevation of approximately 572. These interior areas will be excavated in sectors of approximately 20' x 40' and filled incrementally to approximately elevation 572 to minimize upheaval. The outer perimeter (15') will then be excavated to clean soil using a braced excavation.

The outer perimeter will be treated as a continuous braced excavation, as the soil is removed a hydraulic Mega-Brace system will be utilized to shore the existing sheeting against the new compacted fill. (See Sheet Pile Support Plan") The Mega-Brace will be installed at or about elevation 571 or 570. The braced excavation will be approximately 15' wide and 27' long. The soil will be excavated, sheeting cleaned and clean backfill placed before the shoring is removed. We will utilize two complete bracing systems and leapfrog them to facilitate a productive effort.

After the edges have been completed and filled to elevation 572, final fill operations will commence to fill the balance of the basins to approximately elevation 583.

Upon completion of the proposed storm sewer and grading work, the disturbed areas and pond slopes will be restored with a minimum of 4 inches of topsoil, hydro-seed and mulch per the specifications.

Existing BAB Sheet Pile Support Plan

It is our intent to utilize a four-sided Hydraulic Mega Brace shoring system as depicted in the attached drawing. The system will be utilized to secure the existing sheeting during excavations below the 572 Elevation.

After the center CCR material has been removed and replaced with compacted clay to an elevation at or above 572, we will begin the perimeter excavation work. It will commence using a leap frog method. One cell will be excavated while the last is being filled with clay and the shoring will be moved.

The shoring system will be comprised of the hydraulic Mega Brace Unit expanded in place to push against the existing sheet pile walls and the previously compacted clay. The three movable sides will be 1" steel plates.

We will start each excavation by installing the shoring system at or about Elevation 566. Or approximately 50% of the intended depth to find clean clay at that location. We will excavate a cell of 15 x 27 to the clean clay, verify with inspection, clean the sheeting walls and begin filling with compactable clay. The shoring will be removed as the fill rises above it and moved to the next location.

We anticipate a potential over dig on the previously placed clay to confirm that no seams of CCR material missed.

A full detailed design and calculation sheet will be supplied in a separate pdf.

Engineering Conceptual Design

Date: 3/8/2022

Designer: CP

Customer: Raymond Excavating Co

Salesperson: Matthew Edwards

Project: DTE Bottom Ash Closure

Branch: 15D Detroit

Project Location: East China, MI

Engineering Fee: \$ 2,100.00 ENG_SBW16

Shoring System:

- System Type: 4-Sided Braced Sheet Piling & Bracing System
- System Dimensions: 15' wide x 27' long x 12' deep; sheet to sheet.
- Phasing Required: No
- Bracing Required: Yes, (1) ring of hydraulic brace.
- Sheet Piling Required: Yes, 1" thick steel plates.
- Benching/Sloping Required: No.
- Soil Description: Soil is Loose Sand over Med Stiff Clay based on boring MW-16-03 by TRC, dated 3/24/16.
- Dewatering Required: Base of excavation on interior and exterior of excavation.
- Surcharge Setback: HS20-44 vehicular traffic 50', Waterway 40', Abutting Permanent sheeted walls of pit, Structures 50' (see Note #5 below).
- Additional Notes: The proposed system is based on information available, adverse site or soil conditions may affect design and engineering.

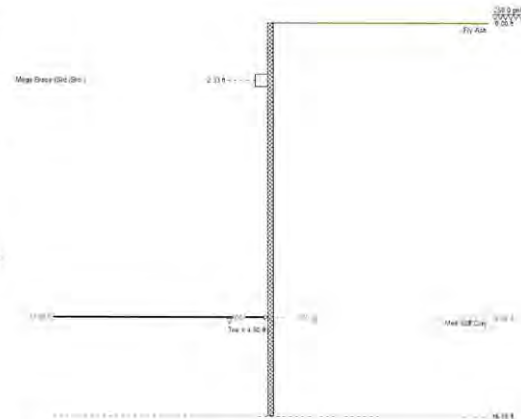
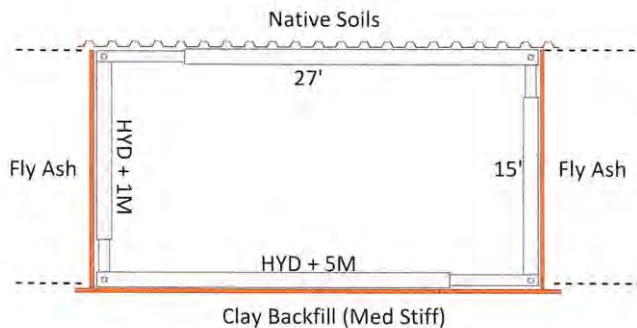

- (4) HYD
- (2) 5m Ext
- (2) 1m Ext
- (8) 8'x16' - 1" Thick Steel Plates
- (1) Power Pack
- (16) Hanging Chains
- (1) Job Box

Design Details:

- Rankine Earth Theory :: See SupportIT (Soil parameters vary per side)
- 250 psf ground surcharge

Notes:

- Backfill assumed to be Medium Stiff Clay (or stiffer)
- Shoring system to abut existing AZ-26 sheet pile wall
 - $Z = 57.1 \text{ in}^3/\text{ft}$
 - 7' Minimum Embed
- Check of existing steel sheet pile wall by others
- Steel plates to be embedded 4', minimum

Existing BAB Dewatering Plan

BAB dewatering will commence as soon as the existing 48" storm lines have been plugged with inflatable pipe balls. The existing water will be collected from the point closest to the existing outlet in the North corner of the West pond. A stone sump/wet well will be established as a point for the dewatering system to collect from.

At that point, (2) DV100C 4" Diesel Powered Trash Pumps with high/low float automatic operation will be utilized to feed the filter system. A Sandfilter/ Bagfilter Water Treatment System- 400 GPM Max will be used. It is a trailer mounted treatment system consisting of (1) two pod sand filter and (5) single stage bag filters plumbed in parallel with a flow meter. Two (2) 18,000 Gallon Weir Tanks will be incorporated for sediment settling.

Dewatering will be a continuous operation with TSS sampling (Weekly), Oil & Grease (Twice per Mth) and Total Flow (Twice per Week) per outfall 001D. One sampling event on start-up, weekly there after for total of 3 events if needed.

To prepare in the East pond, should there be a need to restart the plant, we will block the existing channel with steel street plates backed with clay to prevent flow into the West pond. We will also build another collection point at a low point in the East pond. As water collects in the East pond it will be transferred to the sump on the West pond via a 4" diesel pump at which point it can be treated and discharged.

BAB CCR Excavation, and CCR Transportation and Hauling plan

Per the overall project plan, the CCR material will be cement stabilized after dewatering and therefore excavated and transported in a solid state. This will allow for the use of standard trucks and trailers. We intend to use leads for transporting approximately 24 cyd per load to the RRLF.

The use of public roads will be minimal with only two crossing points. One on M-29 and one on Puttygut Rd. with the balance of travel on DTE property. We intend to have sweeping equipment on site for potential clean ups and a water truck will be available for dust control when needed.

Quality Plan.

Raymond Excavating acknowledges and intends to adhere to the previously established Construction Quality Control Plan published with the DTE bid documents referred to as "Attachment A" pages 1 & 2.

We and our subcontractors will work closely with onsite DTE personnel to record daily results for water discharge, exposed sheet pile depths, CCR removal and clay backfill density.

We will have testing technicians from BMJ Engineers onsite to confirm proper fill compaction and record findings.

Confined Space

We intend to limit any activity that requires confined space entry. With regard to the BAB, we will be entering via earth ramps constructed for equipment and manpower to access freely.

If confined space entry is required, we do have our subcontractor Commercial Diving and Marine Services, Inc. prepared to supply a confined space entry team if needed. Any entry will be executed utilizing a full body harness, tripod and personal 4-gas air monitor.

With regard to Diving activity, a space that would be considered a PRCS by an entrant if it were dry, is executed under OSHA diving regulations and is not considered a confined space entry. DTE safety has evaluated this with Commercial Diving and Marine Services, Inc. numerous times.

Attachment A

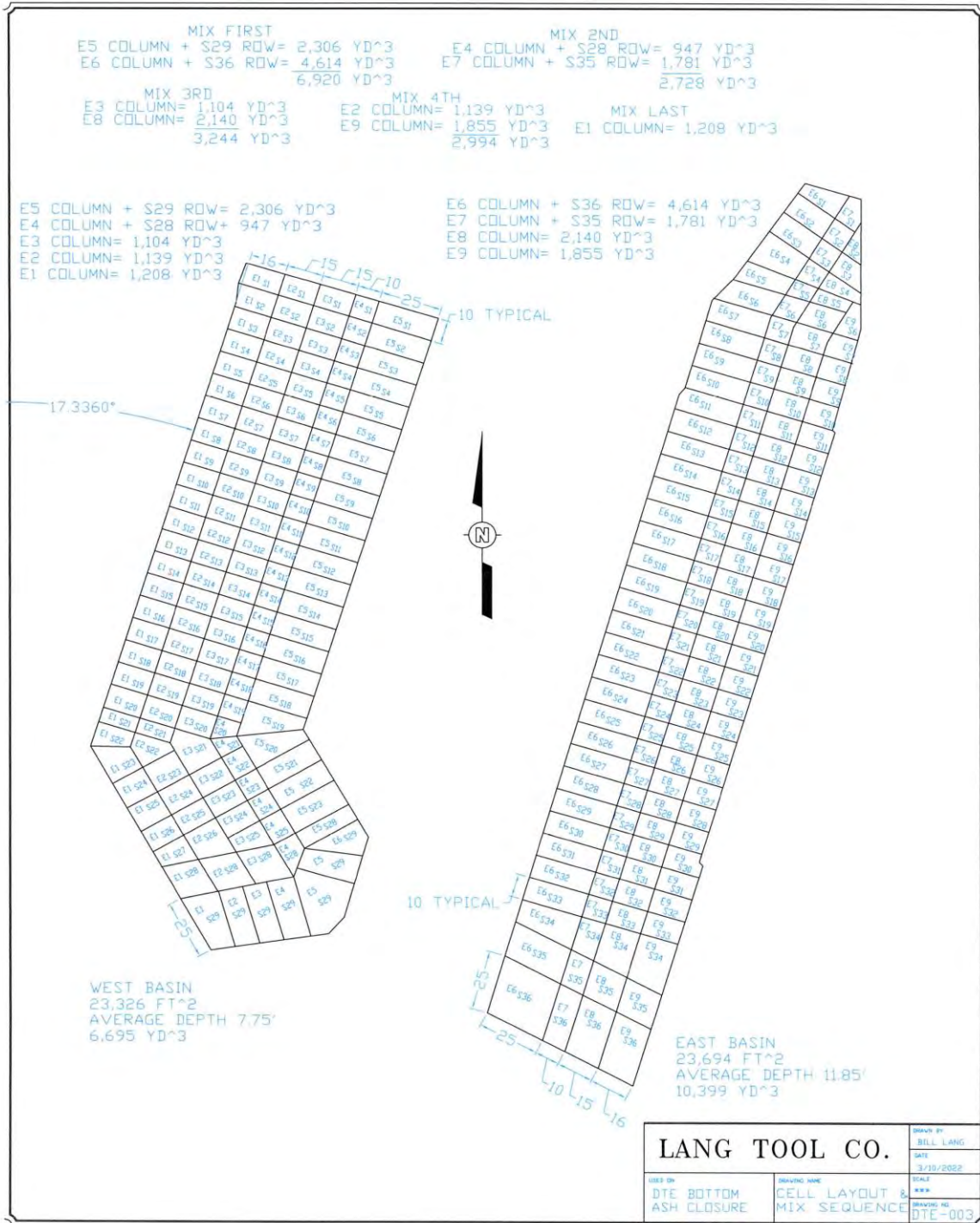

Appendix F - 2

RCP Pipe & MH and PVC Pipe and Seal

DTE ENERGY BOTTOM ASH BASIN CLOSURE EAST CHINA, MI

BARR ENGINEERING CO.
SHOP DRAWING / SUBMITTAL REVIEW

APPROVED
 APPROVED AS NOTED
 RESUBMITTAL NOT REQUIRED
 REVISE AND RESUBMIT
 NOT APPROVED (RESUBMIT)
 NOT REVIEWED

Review by Engineer is limited to information expressly required for submittal and is for general conformance with the Contract Documents only. Contractor is responsible for any deviations, errors or omissions on the submittal, confirmation and correlation of dimensions, for quantities, construction techniques, fabrication processes, and compliance with contract requirements. The requirements of the Contract Documents shall govern notwithstanding approval by Engineer.

DATE: _____ BY: _____

BARR Barr Engineering Co. notes and revisions are in color

Note: No sump requirement for catch basin. But inclusion of sump is OK as long as it does not interfere with install.

CONTRACTOR:
NATIMOND EXCAVATING

September 1, 2022

SUBMITTED BY:
ETNA SUPPLY COMPANY
4901 CLAY AVENUE SW
GRAND RAPIDS, MI 49548
PHONE: (616) 241-5414
FAX: (616) 241-5485





Northern Concrete Pipe, Inc.

Bay City
401 Kelton Street
Bay City, MI 48706
989 892 3545
989 892 3533 fax

Clarkston
4750 White Lake Road
Clarkston, MI 48346
248 795 2431
248 795 2463 fax

Grand Rapids
2701 Chicago Drive SW
Wyoming, MI 49519
616 608 6025
616 608 7807 fax

Lansing
5281 Lansing Road
Charlotte, MI 48813
517 645 2777
571 645 7774 fax

Toledo
3756 Centennial Road
Sylvania, OH 43560
419 841 3361
419 841 3321 fax

8/31/2022

Project: DTE Energy St. Clair Power Plant Bottom Ash Basin
Location: St Clair Power Plant
St. Clair County (MI)

ETNA SUPPLY COMPANY

This letter is to certify that Northern Concrete Pipe, Inc. manufactures these products to meet or exceed the current version of the ASTM specifications listed below:

- Concrete Pipe and End Sections: (elliptical) ASTM C-507 or C-508, class as specified
- Concrete Pipe and End Sections: (round) ASTM C-76, class as specified
- Manholes & Gatewells: ASTM C-478
- Pipe and Manhole Joints: ASTM C-361 and/ or C-443

The accessory items furnished, but not manufactured by Northern, meet or exceed the ASTM specifications listed below:

- Pipe & Manhole Gasket Material: ASTM C-443 & ASTM C-361
- Manhole Steps: ASTM C-478, ASTM D-4101, ASTM A-615 & AASHTO M-199
- Kor-N-Seal, Kor-N-Tee and A-Lok flexible Connections: ASTM C-923
- Pipe & Manhole Soap: N.S.F.
- Concrete Block - Drainage Structures: ASTM C-139
- Concrete Brick - Drainage Structures: ASTM C-55 Grade S-II
- Portland Cement Type I : ASTM C-150
- Masonry Cement (Mortar) Type N : ASTM C-91

If you have any questions or need any additional information, please feel free to call.

Sincerely,

Northern Concrete Pipe, Inc.

Standard 48" Storm Catch Basin Cones

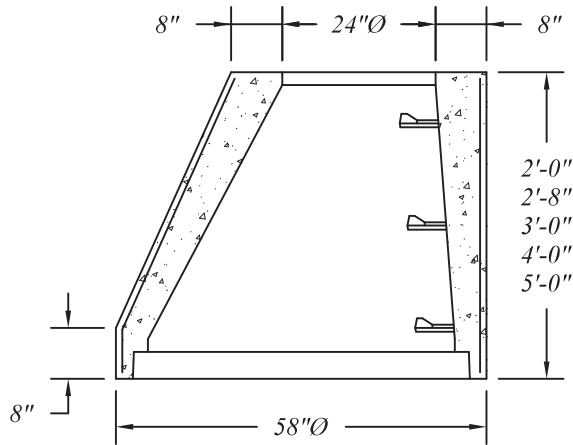

Standard 48" Storm Catch Basin Riser Cones

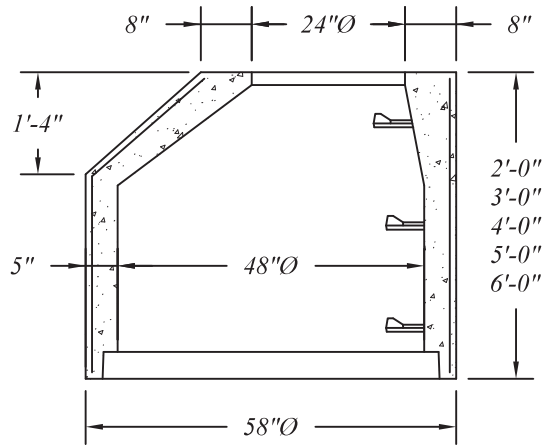

Standard 48" Storm Catch Basin Risers

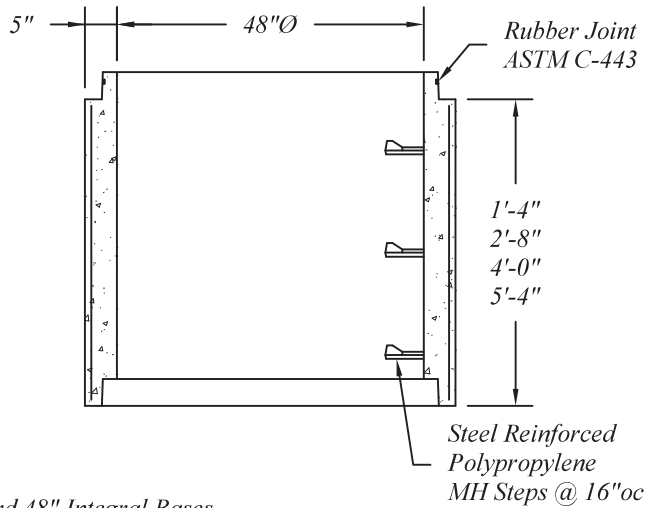

48" Storm Catch Basin Flat Covers
For Fill Less Than 2.5' Over Pipe

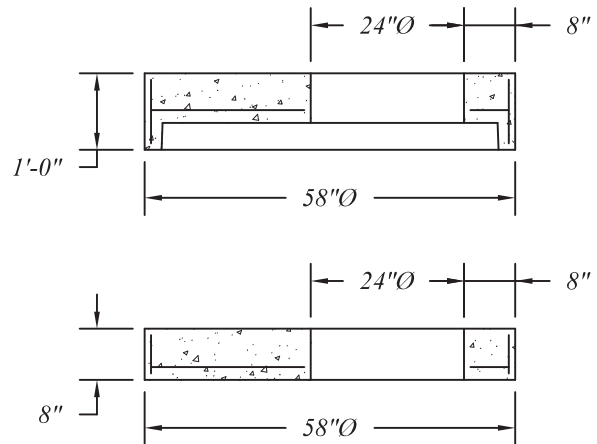

Standard 48" Integral Bases

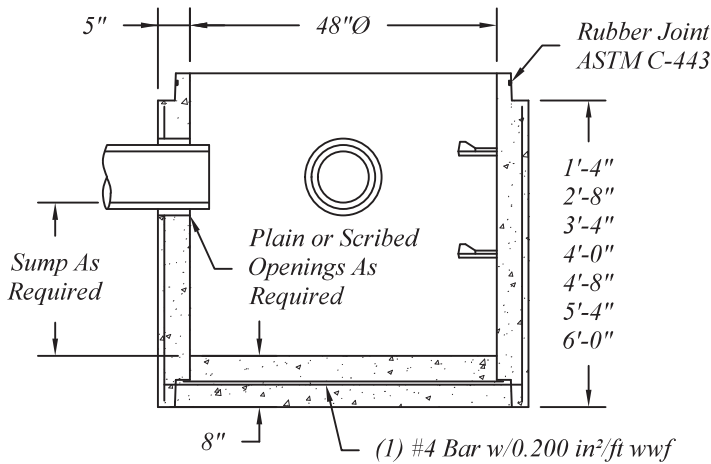

Standard Separate Bases

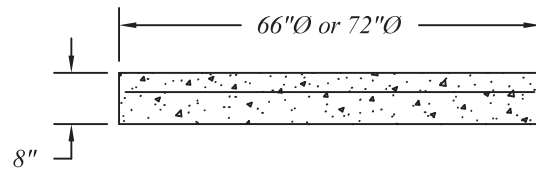

48" Catch Basin Pipe, Cones and Bases Are Manufactured To ASTM C-478 Specifications.

Reinforcing Shown For Schematic Only.

Standard 48"Ø Precast Concrete Storm Catch Basin Sections



401 Kelton St Bay City, MI 48706

Date 11 May 16

5281 Lansing Rd
Charlotte, MI 48813

2701 Chicago Dr SW
Wyoming, MI 49519

Drawn By
BmG

4950 White Lake Rd
Clarkston, MI 48346

3756 Centennial Rd
Sylvania, OH 43560

Scale
NTS

02.02

TYPE 4G

CONCRETE PIPE AND MANHOLE GASKETS



What It Is

The Type 4G & 4F profile gaskets were developed to specifically meet the needs of contemporary concrete pipe joint designs.

With the accurate profile dimensions and designs for a complete line of standard and specially designed concrete joint configurations.

How It Works

- The gasket is stretched over the spigot.
- The gasket is equalized around the entire circumference of the spigot.
- Bell joint is covered liberally with lubricant.
- Bell and spigot are homed creating a watertight seal.

Why It's Better

- Optimized profile designs for a wide variety of joint configurations.
- Accurate profile designs covering a variety of applications.
- Wide range of compounds that can be applied in multiple applications.
- Simple installation methods.

Where To Use

- Manholes
- Wet wells
- Square pump and lift stations
- Stormwater structures
- On-site treatment structures
- Junction chambers
- Grease interceptors

Product Performance

- ASTM C1619 Standard Specification for Elastomeric Seals for Joining Concrete Structures
- ASTM C443 Standard Specification for Joints for Concrete Pipe and Manholes, Using Rubber Gaskets



CARE & STORAGE

PAGE 5



TYPE 4G

SELECTION GUIDE

FOR SINGLE-STEP PIPE AND MANHOLE JOINTS

Available for Concrete Pipe, Manholes and Box Culverts.

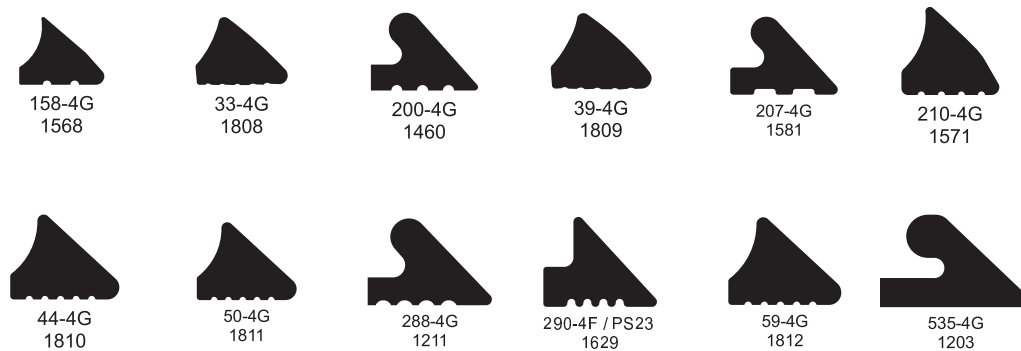
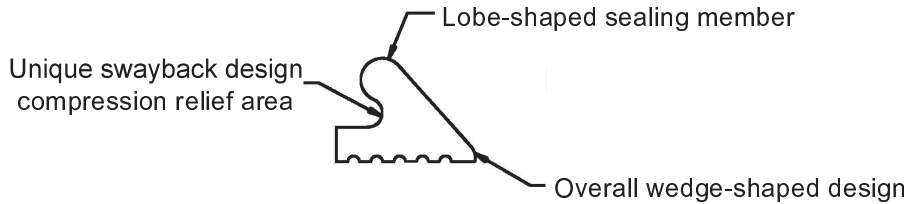

Gasket Type	Gasket Height (Inch)	Gasket Height (mm)	Typ. Annular Space (Inch)	Typ. Annular Space (mm)
158-4G	.608	15.4 mm	.326	8.3 mm
33-4G	.610	15.5 mm	.326	8.3 mm
39-4G	.685	17.4 mm	.380	9.6 mm
200-4G	.681	17.8 mm	.400	10.2 mm
207-4G	.817	20.8 mm	.446	11.3 mm
210-4G	.791	21.0 mm	.446	11.3 mm
44-4G	.750	18.6 mm	.446	11.3 mm
50-4G	.826	20.3 mm	.500	12.7 mm
288-4G	.908	23.1 mm	.500	12.7 mm
290-4F (PS-23)	.927	23.3 mm	.500	12.7 mm
59-4G	.916	22.6 mm	.600	15.2 mm
535-4G	.970	24.6 mm	.525	13.3 mm
1016-4G	1.063	26.4 mm	.640	16.3 mm



Press-Seal believes all information is accurate as of its publication date. Information, specifications, and prices are all subject to change without notice. Press-Seal is not responsible for any inadvertent errors. Copyright 2022.

Phone: 800-348-7325
Fax: (260) 436-1908

PRESS-SEAL CORPORATION
Protecting Our Planet's Clean Water Supply
ISO 9001: Registered • Version 04.27.22.3.22

Email: sales @press-seal.com
Web: www.press-seal.com

TYPE 4G INSTALLATION INSTRUCTIONS

PIPE INSTALLATION

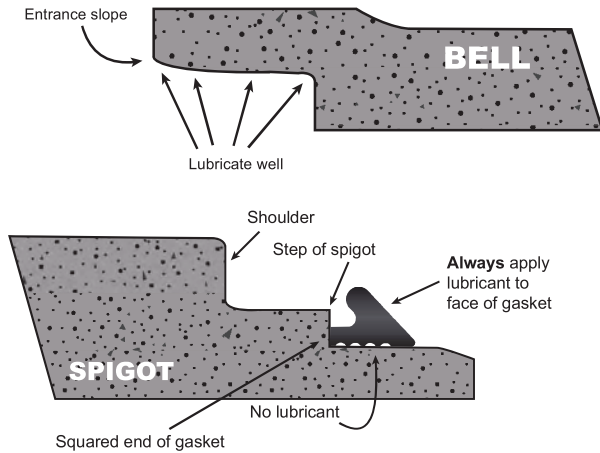

MANHOLE INSTALLATION

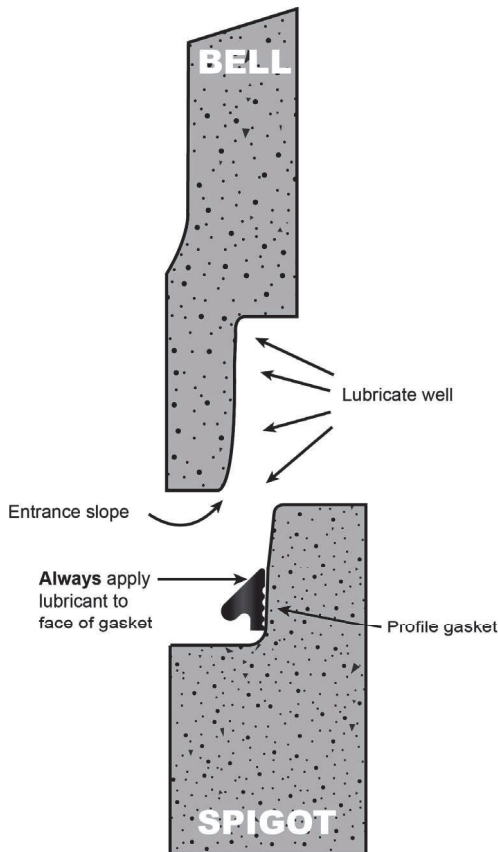

Type 4G and 4F gaskets manufactured by Press-Seal Corporation have proved to be one of the most reliable gasket systems ever developed for concrete pipe. It is easy to ensure the best performance of the 4G and 4F gaskets by following these simple installation steps.

1. The pipe should be handled with extreme caution to avoid chipping of the spigots or bell grooves.
2. Check for and remove any loose dirt, debris or foreign material from the inside surface of the bell, spigot and gasket.
3. Stretch the gasket over the spigot end of the pipe and move it back until it is seated against the step of the spigot. Always place squared area of gasket against pipe and step.
4. The gasket should be equalized by inserting a clean round metal object between the gasket and manhole and making at least 1 -1/2 revolutions around the manhole. The gasket can also be equalized by slightly tugging/ pinching the gasket at different points around the manhole.
5. After equalization, ensure the rear of the gasket is seated firmly against the spigot step, around the full circumference of the spigot.
6. Remove all dirt and other foreign matter from the inside surface of the bell. Using Press-Seal lubricant formulated especially for concrete pipe, lubricate the entire bell area of the joint. Be sure to coat the entrance slope of the bell thoroughly with lubricant. It is important that the gasket grips the spigot during installation, so that it is not displaced from the step.
7. Carefully align pipe sections squarely and bring home slowly, so that the gasket makes contact with the bell entrance slope evenly around the entire pipe joint.
8. Complete installation by following pipe manufacturer's recommended bedding and backfilling practices.





Structure Detail

Project: 3489 DTE Energy St. Clair Power Plant Bottom Ash Basin
Structure: CB
Type: 48" Storm MH RJ
Rim: 581.95'
Sump: 2.00'

Customer: ETNA SUPPLY COMPANY
Height: 9.42'
Precast: 8.00'
Casting/Adjust: 1.42'

Structure Specific Notation Below Requires Review / Approval

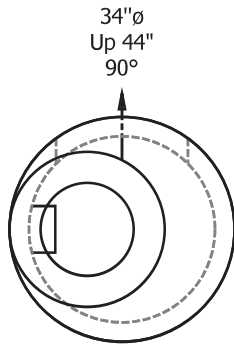

Max Lift: 3.30 Tons

Angle	Invert	Pipe	Connection	Up To Center
90	575.20	24 RCP-B	34"∅	44

Seq	Description	Height
1	48" x 6'-0" MH Base WH w/8" IB	6.00
2	48" x 2'-0" Manhole Cone	2.00

CONFIRM 2'-0" MINIMUM SUMP REQUIRED

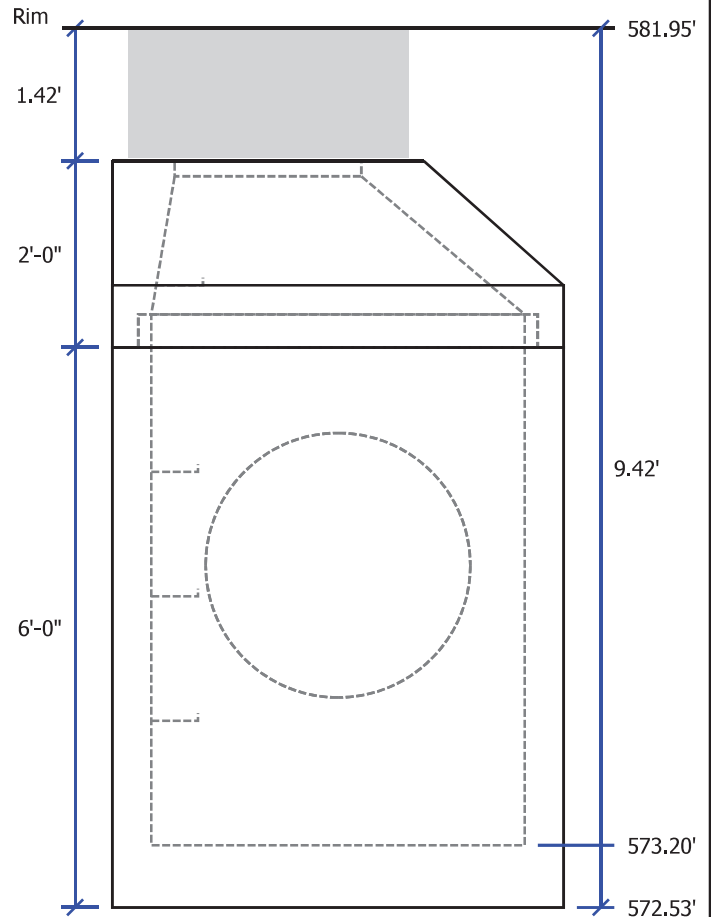

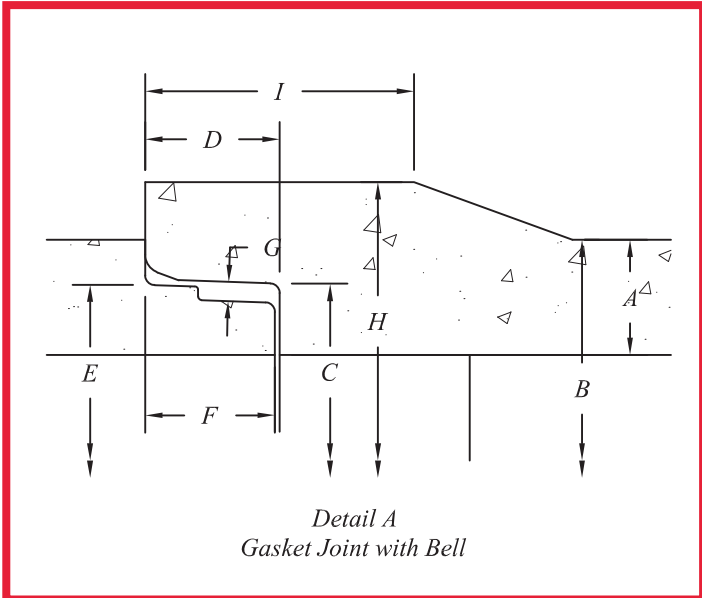

Detail A
Gasket Joint with Bell

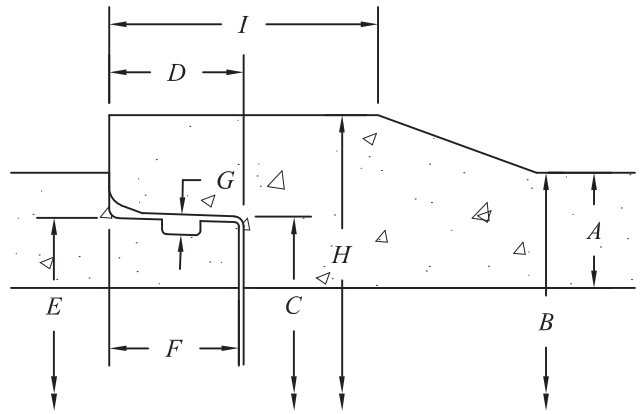

Detail B
O-Ring Joint with Bell

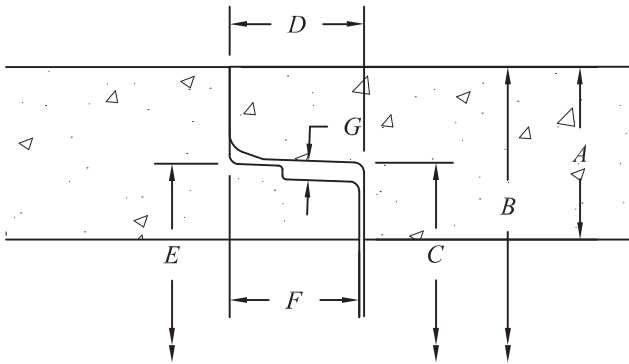

Detail C
Gasket Joint with Straight Wall

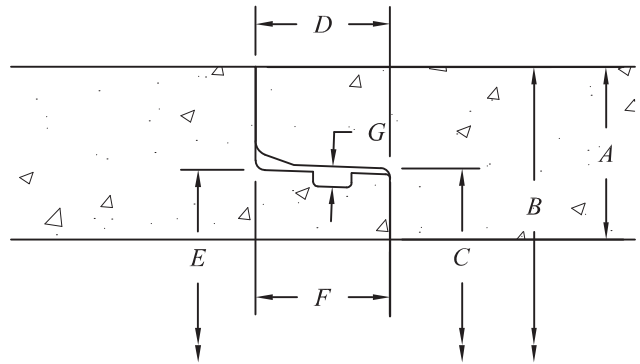

Detail D
O-Ring Joint with Straight Wall

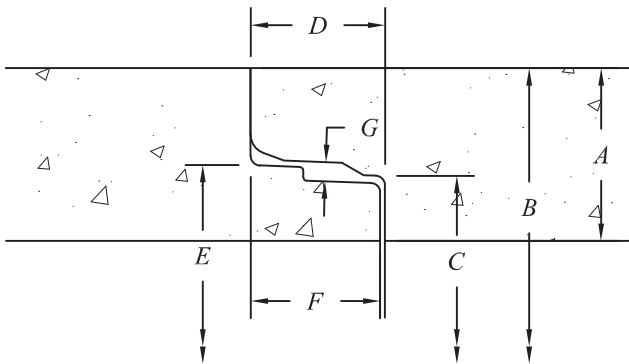

Detail E
Confined Gasket Joint with Straight Wall

All Pipe Is Manufactured And Tested In Accordance With Current Required ASTM and AASHTO Specifications w/ASTM C-443 Joints.

ASTM C-14 / AASHTO M-86 for Non-Reinforced Concrete Pipe.
 ASTM C-76 / AASHTO M-170 for Reinforced Concrete Pipe.
 ASTM C-655 / AASHTO M-242 for Reinforced D-Load Concrete Pipe.

All Gaskets and O-Rings Meet ASTM C-443 Requirements.
 All Gasket and O-Ring Materials Meet ASTM C-361 Requirements.

Install Reinforced Concrete Pipe per ASTM C-1479 - Standard Practice for Installation of Precast Concrete Sewer.



401 Kelton St Bay City, MI 48706		12"Ø - 144"Ø Reinforced Concrete Pipe Joint Details		
5281 Lansing Rd Charlotte, MI 48813	2701 Chicago Dr SW Wyoming, MI 49519			
4950 White Lake Rd Clarkston, MI 48346	3756 Centennial Rd Sylvania, OH 43560	Date 01 Aug 22	Revised	Rev. No. Drawn By BmG Scale NTS 01.01a

Pipe I.D.		Joint Detail	Gasket Type	Wall Class	A	B	C	D	E	F	G	H	I	Joint Taper	Section Length	Lbs / Section	Joint Style
(in)	(mm)				Wall (in)	Pipe O.D.	Bell I.D.	Bell Depth	Spigot O.D.	Spigot Length	Annular Space	Bell O.D.	Bell Length				
12	300	A	288-4G	B+	2.25	16.50	15.258	3.5	15.210	3.375	0.500	19.63	6.50	2°	8.2'	975	H
12	300	A	PS-23	B+	2.13	16.25	15.252	3.563	15.296	3.563	0.500	20.00	5.125	1.83°	8.0'	950	P
12	300	A	288-4G	C	2.75	18.00	15.258	3.5	15.210	3.375	0.500	19.63	6.50	2°	8.2'	1186	H
15	375	A	288-4G	B	2.25	19.50	18.709	3.5	18.661	3.375	0.500	23.50	6.50	2°	8.2'	1285	H
15	375	A	PS-23	B+	2.50	20.00	18.751	3.563	18.796	3.563	0.500	23.88	5.25	1.83°	8.0'	1250	P
18	450	A	288-4G	B	2.50	23.00	21.709	3.5	21.661	3.375	0.500	27.00	6.50	2°	8.2'	1555	H
18	450	A	PS-23	B+	2.75	23.50	22.375	3.75	22.444	3.750	0.500	27.63	5.25	1.83°	8.0'	1760	P
21	525	A	288-4G	B	2.75	26.50	24.709	3.5	24.661	3.375	0.500	30.00	7.0	2°	8.2'	2000	H
21	525	A	PS-23	B	2.75	26.50	25.875	3.75	25.944	3.750	0.500	31.63	5.25	1.83°	8.0'	2224	P
24	600	A	288-4G	B	3.00	30.00	27.709	3.5	27.661	3.375	0.500	33.00	7.0	2°	8.2'	2390	H
24	600	A													8.0'	2568	P
27	675	C													8.2'	3495	H
27	675	A													8.0'	3680	P
30	750	A													8.2'	3955	H
30	750	C													8.0'	4352	P
36	900	B													8.0'	4340	Q
36	900	C													8.2'	5240	H
36	900	C													8.0'	5744	P
36	900	E													8.2'	5240	H
42	1050	A													8.2'	5668	H
42	1050	B													8.2'	5668	Q
42	1050	C													8.2'	6657	H
42	1050	A													8.0'	7512	P
42	1050	B													8.0'	7512	G
42	1050	D													8.0'	6494	Q
48	1200	C													8.2'	7111	H
48	1200	D													8.2'	7111	Q
48	1200	C													8.2'	8294	H
48	1200	A													8.0'	8091	P
48	1200	B													8.0'	8091	G
48	1200	D													8.2'	8294	Q

NORTHERN CONCRETE PIPE WILL SUPPLY:
2 PCS OF 24" C76 ; CL-IV PREMIUM JOINT PIPE
ONE BUCKET OF JOINT LUBE

All Pipe Is Manufactured And Tested In Accordance With Current Required ASTM and AASHTO Specifications w/ASTM C-443 Joints.

ASTM C-14 / AASHTO M-86 for Non-Reinforced Concrete Pipe.
ASTM C-76 / AASHTO M-170 for Reinforced Concrete Pipe.
ASTM C-655 / AASHTO M-242 for Reinforced D-Load Concrete Pipe.

All Gaskets and O-Rings Meet ASTM C-443 Requirements.
All Gasket and O-Ring Materials Meet ASTM C-361 Requirements.

Install Reinforced Concrete Pipe per ASTM C-1479 - Standard Practice for Installation of Precast Concrete Sewer.



401 Kelton St Bay City, MI 48706		12"Ø - 144"Ø Reinforced Concrete Pipe Joint Details	
5281 Lansing Rd Charlotte, MI 48813	2701 Chicago Dr SW Wyoming, MI 49519		
4950 White Lake Rd Clarkston, MI 48346	3756 Centennial Rd Sylvania, OH 43560	Date 01 Aug 22	Revised
		Rev. No.	Drawn By BmG
		Scale NTS	01.01b



JTM Products

Phoenix 713-A Sub Aqueous Pipe Joint Lubricant

Product Data Sheet

Description:

Phoenix 713-A Sub Aqueous Pipe Joint Lubricant is a soft, non-water dispersible paste. Phoenix 713-A is a stable blend of vegetable oils, soaps, surfactants and water. Mating of abutting pipes force the paste into the cavity, thus providing the needed lubrication to complete the coupling and seal the joint. Phoenix 713-A is a specially formulated soap and surfactant lubricant that does not dry out when gaskets are stored.

The temperature operating range of Phoenix 713-A is 10° to 110°F. It can be used on all types of pipe including asbestos cement, cast iron, concrete, plastic and clay pipe. Phoenix 713-A Sub Aqueous Pipe Joint Lubricant will not deteriorate natural rubber, synthetic rubber or plastic gaskets.

Phoenix 713-A Sub Aqueous Pipe Joint Lubricant is certified to meet NSF/ANSI Standard 61 requirements for use in potable water systems. Phoenix 713-A is a water insoluble formula and is excellent for underwater pipe assembly.

Features:

- Certified by the Water Quality Association (WQA)
- Meets NSF/ANSI Standard 61
- Water insoluble
- Contains no petroleum
- Contains no phosphates
- Will not support bacteria
- Non-toxic
- Biodegradable
- Designed for applying in wet or dry conditions
- Will not swell gaskets

Product Data:

- Form: Soft paste
- Color: Tan
- Odor: Bland
- Bulk density: Approx. 12 lb./gallon
- Non volatile materials: Approx. 88%
- Total alkalinity: 10-30 mg KOH/g equivalent
- Penetration: 300-350 1/10 mm @ 77° F

DRAIN BASIN SHOP DRAWING

PO#	<input type="text"/>
Part Number	2812AG5
Customer approval	<input type="text"/>

Project Name	DTE Energy SF-284419	Dia.	12	Structure No.	DB#1	Qty.	1
Prepared By	Melissa Hickson Nyloplast 678-745-6037 melissa.hickson@ads-pipe.com	Grate	12: Solid:				
		Accessories	<input type="text"/>				

Rim Elev.	583.00 ft.	Basin Height	52.2 in.	Sump Depth	6.00 in.
-----------	------------	--------------	----------	------------	----------

	Stub size	Anale	Pipe Type	Invert Elev. ft. AMSL	Production Depth inches
Stub #1	12 in.	0 °	PVC SCH.40	579.15 ft.	46.20 in.
Stub #2					
Stub #3					
Stub #4					
Stub #5					
Stub #6					

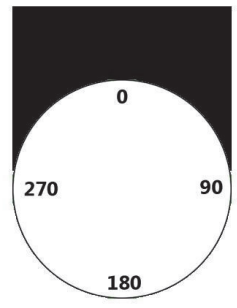
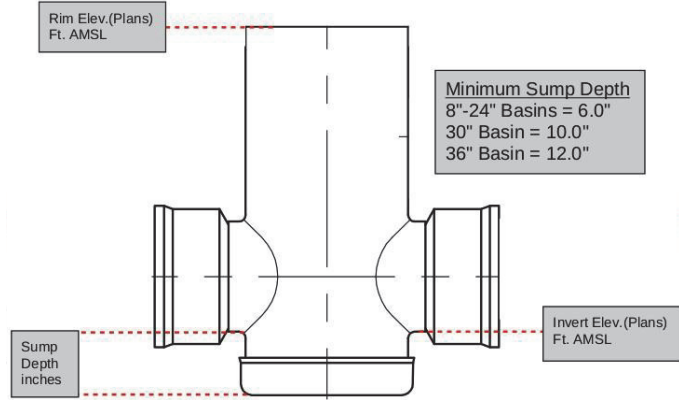

CUSTOMER NOTES	PART CODES	PRODUCTION NOTES
Customer to confirm sump depth of assumed std 6"	1299CGC:	**NO Bottom CAP**

This product is made to order and non-Refundable
 Nyloplast. 3130 Verona Ave. Buford, GA 30518. (866) 888-8479
Nyloplast® is a registered trademark of Advanced Drainage Systems®

Nyloplast® is not responsible for accuracy of shop drawings submitted by customer through Basin Configurator. Submission of shop drawings for purchase and fabrication constitute an approval for production as designed by customer.

43424002 - 1 B8

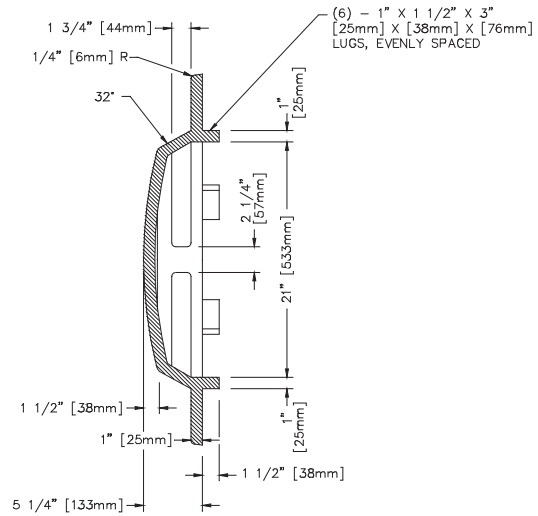
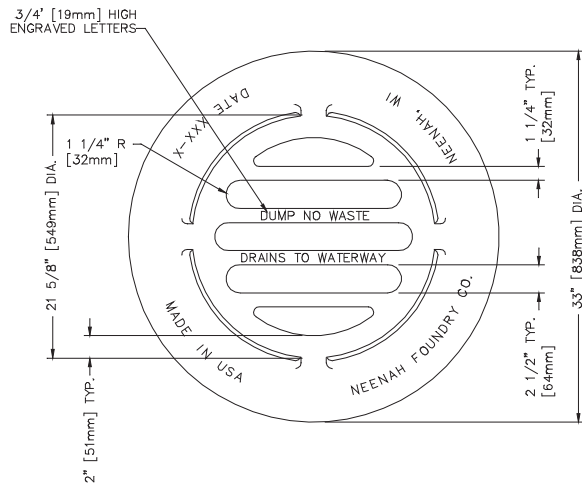

NOTE: ALL DIMENSIONS SHOWN ARE IN ENGLISH AND [METRIC]
 FREE OPEN AREA: 278 SQUARE INCHES
 MATERIAL: CAST GRAY IRON ASTM A-48, CLASS 35B
 FINISH: NO PAINT
 WEIGHT: 196#

WAS 4342-T01

DR.	MAG	SCALE	TITLE:
CH.		1/8"=1"	R-4342
APP.		DIM. CHK.	GRATE
DATE	10-28-2004		NEENAH FOUNDRY COMPANY NEENAH WISCONSIN 54956
			NF- 43424002 B

SUBMITTAL FOR CHARLOTTE PIPE® PVC SCHEDULE 40 PRESSURE PIPE AND FITTING SYSTEM

Date: _____

Job Name: _____

Location: _____

Engineer: _____

Contractor: _____

► Scope:

This specification covers PVC Schedule 40 pipe and fittings for pressure applications. This system is intended for pressure applications where the operating temperature will not exceed 140° F.

► Specification:

Pipe and fittings shall be manufactured from virgin rigid PVC (polyvinyl chloride) vinyl compounds with a cell class of 12454 as identified in ASTM D 1784.

PVC Schedule 40 pipe shall be Iron Pipe Size (IPS) conforming to ASTM D 1785. Injection molded PVC Schedule 40 fittings shall conform to ASTM D 2466. Pipe and fittings shall be manufactured as a system and be the product of one manufacturer. All pipe and fittings shall be manufactured in the United States. Pipe and fittings shall conform to NSF International Standard 61 and the health-effects portion of NSF Standard 14.

► Installation:

Installation shall comply with the latest installation instructions published by Charlotte Pipe and Foundry and shall conform to all applicable plumbing, fire, and building code requirements. Buried pipe shall be installed in accordance with ASTM F 1668. Solvent cement joints shall be made in a two-step process with primer conforming to ASTM F 656 and solvent cement conforming to ASTM D 2564. The system shall be protected from chemical agents, fire-stopping materials, thread sealant, plasticized-vinyl products or other aggressive chemical agents not compatible with PVC compounds. The system shall be hydrostatically tested after installation. **WARNING!** Never test with or transport/store compressed air or gas in PVC pipe or fittings. Doing so can result in explosive failures and cause severe injury or death.

► Referenced Standards:

ASTM D 1784: Rigid Vinyl Compounds
 ASTM D 1785: PVC Plastic Pipe, Schedule 40
 ASTM D 2466: PVC Plastic Fittings, Schedule 40
 ASTM D 2564: Solvent Cements for PVC
 Pipe and Fittings

ASTM F 1668: Procedures for Buried Plastic Pipe
 NSF Standard 14: Plastic Piping Components & Related Materials
 NSF Standard 61: Drinking Water System Components –
 Health Effects



Schedule 40 Tapered Socket Dimensions

PVC SCHEDULE 40 - ASTM D 2466

Nominal Size	Schedule 80 and Schedule 40 Socket Diameter			Schedule 80	Schedule 40
	Entrance A	Bottom B	Tolerance	Socket Length C (Minimum)	Socket Length C (Minimum)
1/2	0.848	0.836	±0.004	0.875	0.688
3/4	1.058	1.046	±0.004	1.000	0.719
1	1.325	1.310	±0.005	1.125	0.875
1 1/4	1.670	1.655	±0.005	1.250	0.938
1 1/2	1.912	1.894	±0.006	1.375	1.094
2	2.387	2.369	±0.006	1.500	1.156
2 1/2	2.889	2.868	±0.007	1.750	1.750
3	3.516	3.492	±0.008	1.875	1.875
4	4.518	4.491	±0.009	2.250	2.000
6	6.647	6.614	±0.011	3.000	3.000
8	8.655	8.610	±0.015	4.000	4.000
10	10.780	10.735	±0.015	5.000	5.000
12	12.780	12.735	±0.015	6.000	6.000

PIPE REFERENCE GUIDE

Product	Sizes Available															
	1/2	3/4	1	1 1/4	1 1/2	2	2 1/2	3	4	5	6	8	10	12	14	16
PVC Schedule 40	•	•	•	•	•	•	•	•	•	•	•	•	•	•	•	•

Not all fitting patterns shown

SUBMITTAL FOR CHARLOTTE PIPE® PVC SCHEDULE 40 SOLID WALL PIPE AND PVC DWV FITTING SYSTEM



Date: _____

Job Name: _____

Location: _____

Engineer: _____

Contractor: _____

► Scope:

This specification covers PVC Schedule 40 solid wall pipe and **PVC DWV fittings** used in sanitary drain, waste and vent (DWV), sewer and storm drainage applications. This system is intended for use in non-pressure applications where the operating temperature will not exceed 140° F.

► Specification:

Pipe shall be manufactured from virgin rigid PVC (polyvinyl chloride) vinyl compounds with a cell class of 12454 as identified in ASTM D 1784. PVC Schedule 40 pipe shall be Iron Pipe Size (IPS) conforming to ASTM D 1785 and ASTM D 2665. Injection molded PVC DWV fittings shall conform to ASTM D 2665. Fabricated PVC DWV fittings shall conform to ASTM F 1866. All pipe and fittings shall be manufactured in the United States. All systems shall utilize a separate waste and vent system. Pipe and fittings shall conform to NSF International Standard 14.

► Installation:

Installation shall comply with the latest installation instructions published by Charlotte Pipe and Foundry and shall conform to all applicable plumbing, fire, and building code requirements. Buried pipe shall be installed in accordance with ASTM D 2321 and ASTM F 1668. Solvent cement joints shall be made in a two-step process with primer conforming to ASTM F 656 and solvent cement conforming to ASTM D 2564. The system shall be protected from chemical agents, fire-stopping materials, thread sealant, plasticized-vinyl products or other aggressive chemical agents not compatible with PVC compounds. The system shall be hydrostatically tested after installation.

WARNING! Never test with or transport/store compressed air or gas in PVC pipe or fittings. Doing so can result in explosive failures and cause severe injury or death.

► Referenced Standards:

- ASTM D 1784: Rigid Vinyl Compounds
- ASTM D 1785: PVC Plastic Pipe, Schedule 40
- ASTM D 2665: PVC Drain, Waste and Vent Pipe and Fittings
- ASTM D 2564: Solvent Cements for PVC Pipe and Fittings
- ASTM D 2321: Underground Installation of Thermoplastic Pipe (non-pressure applications)
- ASTM F 656: Primers for PVC Pipe and Fittings
- ASTM F 1668: Procedures for Buried Plastic Pipe
- ASTM F 1866: Fabricated PVC DWV Fittings
- NSF Standard 14: Plastic Piping Components and Related Materials



PVC Schedule 40 DWV Pipe						
PVC Schedule 40 DWV Pipe (NSF)						
PVC SCHEDULE 40 (WHITE)		PLAIN END		PVC 1120		ASTM D 2665
PART NO.	NOM. SIZE	UPC #	QTY. PER SKID	AVG. OD (IN.)	MIN. WALL (IN.)	WT. PER 100 FT. (LBS.)
PVC 7100*	1 1/4" x 10'	03945	2120'	1.660	.140	42.4
PVC 7100*	1 1/4" x 20'	03946	4240'	1.660	.140	42.4
PVC 7112*	1 1/2" x 10'	03947	1650'	1.900	.145	51.8
PVC 7112*	1 1/2" x 20'	03948	3300'	1.900	.145	51.8
PVC 7200*	2" x 10'	03949	1110'	2.375	.154	69.5
PVC 7200*	2" x 20'	03950	2220'	2.375	.154	69.5
PVC 7300*	3" x 10'	03951	1040'	3.500	.216	144.2
PVC 7300*	3" x 20'	03952	920'	3.500	.216	144.2
PVC 7400†	4" x 10'	03953	600'	4.500	.237	205.5
PVC 7400†	4" x 20'	03954	1200'	4.500	.237	205.5
PVC 7500†	5" x 20'	04837	760'	5.563	.258	272.5
PVC 7600†	6" x 10'	03955	280'	6.625	.280	361.2
PVC 7600†	6" x 20'	03956	560'	6.625	.280	361.2
PVC 7800†	8" x 10'	13087	180'	8.625	.322	543.6
PVC 7800†	8" x 20'	03958	360'	8.625	.322	543.6
PVC 7910†	10" x 20'	03959	220'	10.750	.365	770.7
PVC 7912†	12" x 20'	03961	120'	12.750	.406	1019.0
PVC 7914†	14" x 20'	04862	60'	14.000	.437	1205.0
PVC 7916†	16" x 20'	04918	60'	16.000	.500	1575.7

* Dual Marked ASTM D 1785 & ASTM D 2665.
† Triple Marked ASTM D 1785 & ASTM D 2665 & ASTM F 480.

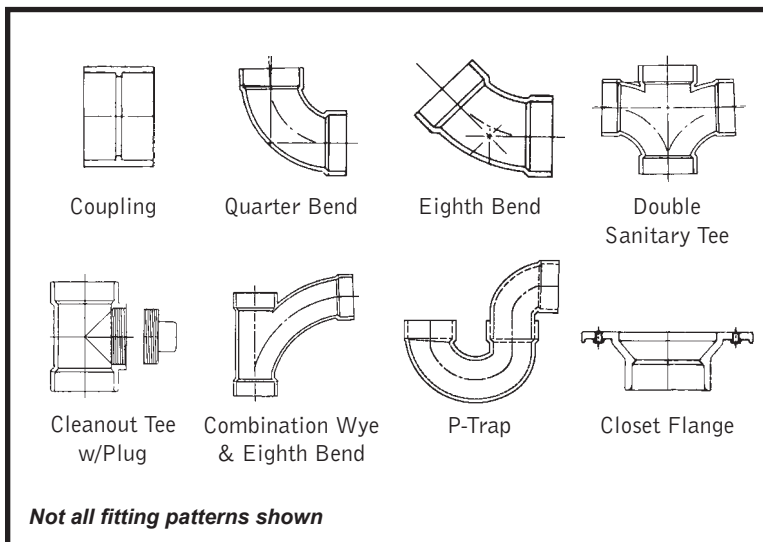

\$8.00

PIPESEAL PENETRATION SEAL APPLICATION & DESIGN GUIDE

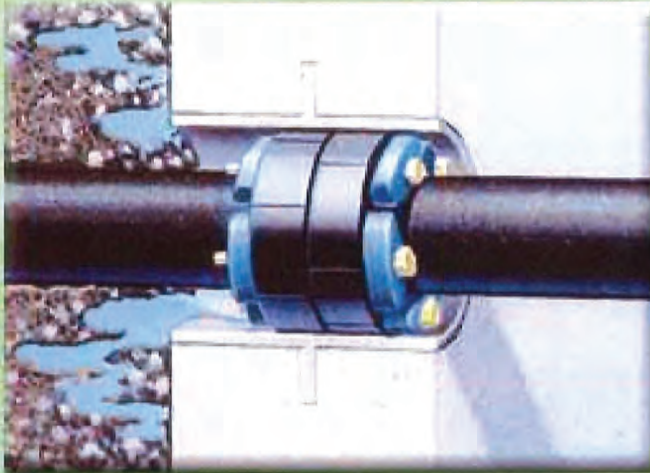

WATER SEALS

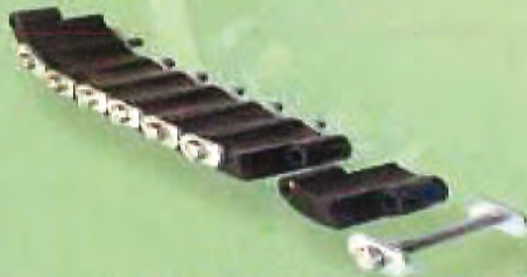

FIRE SEALS 

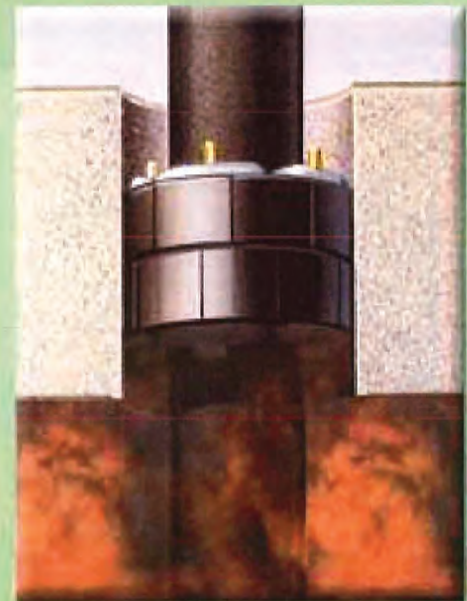

FLEXICRAFT 

2315 W. HUBBARD ST. • CHICAGO, IL 60612 • 800-533-1024 • 312-738-3588 • FAX 312-421-6327



INSTALLATION

The PipeSeal forms a water-tight mechanical seal between the pipe and the hole through which it passes.

Easy as One, Two, Three

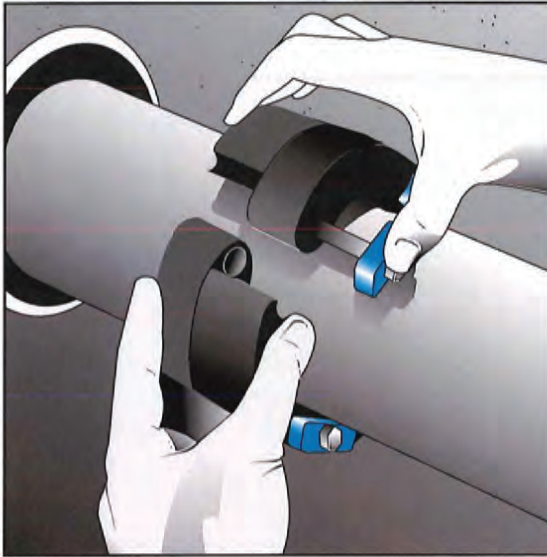

1. Wrap the belt around the pipe. Then connect the first and last links. The proper size and number of links can be found in the catalog.

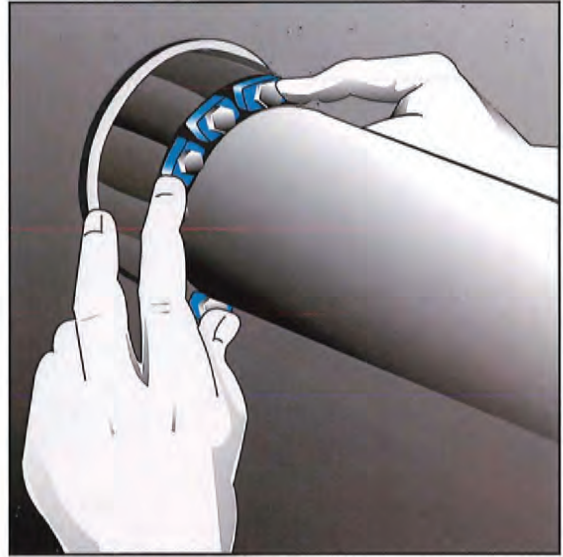

2. Slide the assembly into the space between the pipe and wall.

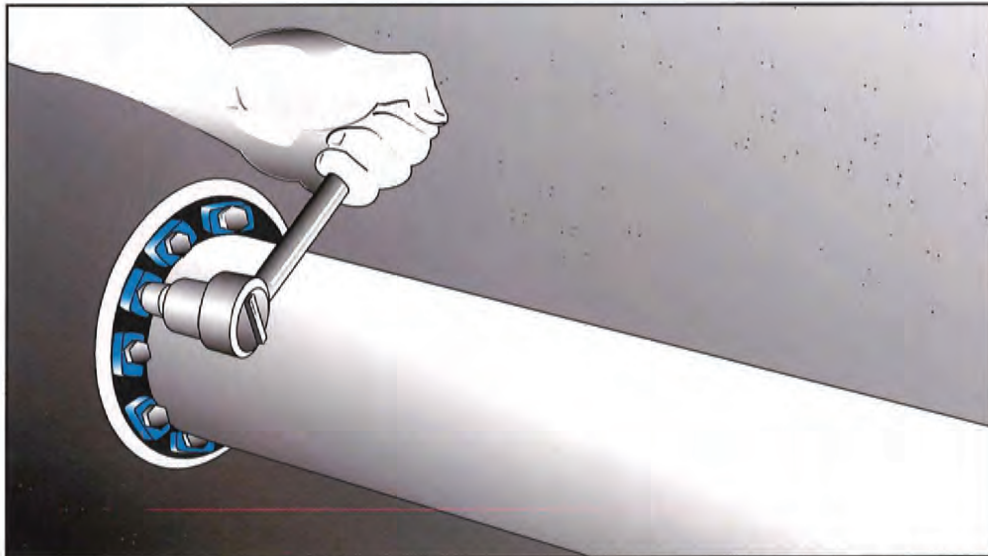

3. Gradually and sequentially tighten the bolts. Tighten each bolt 2-3 turns making 5 to 9 passes completely around the pipe. Do not cross tighten. The PipeSeal links expand to create a gas and water tight seal.



INTRODUCTION

The *PipeSeal* from Flexicraft is the fast and economical way to seal piping and conduit in wall and floor penetrations. Whether using the water seal or the fire stop seal, the benefits are clear.

Quick Installation

The PipeSeal installs in minutes compared to the other alternatives

Long Life

Designed as a permanent seal, it resists sunlight, ozone, water, and a range of chemicals.

Pressure Rated

The PipeSeal can withstand 20 psi of pressure.

Vibration and Shock Protection

Transfer of vibration and shock in a pipeline is greatly reduced by the rubber seal.

Versatile

Three types of elastomers and a choice of plated carbon steel or 316 stainless steel hardware are provided for the water seals.

And the UL classified **F2HR Fire Seal** fire stop device, shown in the included submittals for various configuration systems, provides additional benefits.

2 Hour Fire Rating

Matched with the type of installation, the F2HR provides up to 2 hours of protection with an intumescent seal.

Verifiable Seal

The seal is easy to identify for inspectors, who can verify that the stop is in place at a glance.

No Curing Time or Waste

There is no 10-14 days of curing time required, as with caulks. Again unlike caulk, there is no wasted material with the F2HR PipeSeal.

PipeSeals come in a variety of model sizes. Choosing the right model and number of links for your penetration is covered in the following pages.

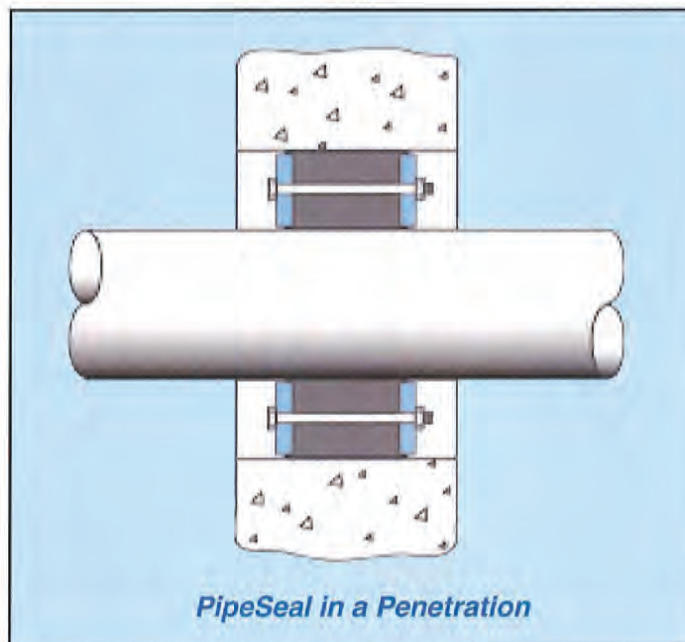



SELECTION

For most applications the appropriate PipeSeal can be selected from the charts on the subsequent pages. If your pipe and wall opening dimensions do not appear on these charts, use the methods in the calculations shown later, or go to the Flexicraft web site and use the sizing calculator.

Specifically:

1. Find the chart that applies to your pipe material. Next locate your pipe size on the chart.
2. Determine your wall opening. Select either a wall sleeve or a core drilled hole, depending on which you plan to use.
3. Find your "Nominal Pipe Size", and read across to determine the appropriate PipeSeal model and number of links required.
4. Select the PipeSeal Type from the table below.
5. Order as follows for an example of a PS-475 size, 10 links, Type ES: **PS475ES10**.

SEAL TYPE CHART

TYPE	MATERIALS			TEMP RANGE (°F)	APPLICATION
	SEAL	PRESSURE PLATES	BOLTS/METAL		
E	EPDM	GLASS REINFORCED PLASTIC	STEEL ZINC DICHOROMATE	-40 to +250	Suitable for most applications in water, both above ground and direct burial. Provides electrical insulation where cathodic protection is required.
ES	EPDM	GLASS REINFORCED PLASTIC	316 STAINLESS STEEL	-40 to +250	Suitable for environments where the corrosion resistance of stainless steel hardware is required.
N	NITRILE	GLASS REINFORCED PLASTIC	STEEL ZINC DICHOROMATE	-40 to +210	Resistant to most hydrocarbons, oil, gas, jet fuel, and many solvents.
NS	NITRILE	GLASS REINFORCED PLASTIC	316 STAINLESS STEEL	-40 to +210	Same as above but with corrosion resistance of stainless steel hardware.
S	SILICONE	STEEL ZINC DICHOROMATE	STEEL ZINC DICHOROMATE	-40 to +400	Suitable for high temperature pipelines up to 400° F.
F	IMPREGNATED EPDM	STEEL ZINC DICHOROMATE	STEEL ZINC DICHOROMATE	-40 to +250	Suitable for an intumescent fire stop.



SELECTION CHARTS

Standard Weight Steel, PVC and CPVC Pipe

NOMINAL PIPE SIZE	ACTUAL PIPE O.D	STANDARD WEIGHT STEEL PIPE SLEEVE				CORE DRILL OR CAST HOLE*		
		SLEEVE NOMINAL PIPE SIZE	SLEEVE ACTUAL I.D	PIPE SEAL MODEL NO.	NO. OF LINKS NEEDED	HOLE I.D.	PIPE SEAL MODEL NO.	NO. OF LINKS NEEDED
1/2 "	0.840 "	2"	2.067 "	PS 200	4	2.000 "	PS 200	4
3/4"	1.050 "	2-1/2"	2.469 "	PS 275	6	2.500 "	PS 275	6
1"	1.315 "	2-1/2"	2.469 "	PS 200	5	3.000 "	PS 315	4
1-1/4"	1.660 "	3"	3.068 "	PS 275	8	3.000 "	PS 275	8
1-1/2"	1.900 "	3"	3.068 "	PS 200	7	3.500 "	PS 300	5
2"	2.375 "	3-1/2"	3.548 "	PS 200	8	4.000 "	PS 300	6
2-1/2"	2.875 "	4"	4.026 "	PS 200	9	4.000 "	PS 200	9
3"	3.500 "	5"	5.047 "	PS 300	8	5.000 "	PS 300	8
3-1/2"	4.000 "	6"	6.065 "	PS 315	10	6.000 "	PS 315	10
4"	4.500 "	6"	6.065 "	PS 300	10	6.000 "	PS 300	10
5"	5.563 "	8"	7.981 "	PS 340	13	8.000 "	PS 340	13
6"	6.625 "	10"	10.020 "	PS 475	10	10.000 "	PS 475	10
8"	8.625 "	12"	12.000 "	PS 475	12	12.000 "	PS 475	12
10"	10.750 "	14"	13.250 "	PS 425	10	14.000 "	PS 475	14
12"	12.750 "	16"	15.250 "	PS 425	12	16.000 "	PS 475	17
14"	14.000 "	18"	17.250 "	PS 475	18	18.000 "	PS 575	16
16"	16.000 "	20"	19.250 "	PS 475	21	20.000 "	PS 575	18
18"	18.000 "	22"	21.250 "	PS 475	23	22.000 "	PS 575	20
20"	20.000 "	24"	23.250 "	PS 475	25	24.000 "	PS 575	22
22"	22.000 "	26"	25.250 "	PS 475	28	26.000 "	PS 575	24
24"	24.000 "	28"	27.250 "	PS 475	30	28.000 "	PS 575	26
26"	26.000 "	30"	29.250 "	PS 475	33	30.000 "	PS 575	28
28"	28.000 "	32"	31.250 "	PS 475	35	32.000 "	PS 575	30
30"	30.000 "	34"	33.250 "	PS 475	37	34.000 "	PS 575	32
32"	32.000 "	36"	35.250 "	PS 475	40	36.000 "	PS 575	34
34"	34.000 "	40"	39.250 "	PS 500	29	38.000 "	PS 575	36
36"	36.000 "	42"	41.250 "	PS 500	31	40.000 "	PS 575	38
42"	42.000 "	48"	47.250 "	PS 500	36	46.000 "	PS 575	44
48"	48.000 "	54"	53.250 "	PS 500	41	52.000 "	PS 575	50

* Min. recommended sleeve length or wall thickness is 4" for PipeSeal Model 325 and 6" for models 400 and larger. PVC sleeves are sch. 40, and have a different I.D. at 12" and above.



-sizing CALCULATION

Use the following calculation method if you can't find your pipe size or pipe sleeve on the preceding selection charts.

Step 1: Calculate the Annular Space

The annular space is the gap between the outside diameter (O.D.) of the pipe and the inside diameter (I.D.) of the wall opening (sleeve or core).

$$\text{Annular Space} = \frac{(\text{Wall Opening I.D.} - \text{Pipe O.D.})}{2}$$

Step 2: Select PipeSeal Model

The proper PipeSeal model can be found in the PipeSeal dimensional chart. The annular space calculated in Step 1 must fall between the free state and expanded state thickness. Choose the seal with the free state thickness closest to, but not greater than the annular space calculated in Step 1.

Step 3: Calculate the Number of Links

First, calculate the Bolt Circle.

$$\text{Bolt Circle} = \frac{(\text{Wall Opening I.D.} + \text{Pipe O.D.})}{2}$$

Then determine the number of links

$$\text{No. of Links} = \frac{(\text{Bolt Circle} \times 3.14)}{\text{Chord Length}}$$

Finally, if the number of links is equal to or greater than 4 and less than 10 and the decimal portion is 0.9 or greater, round up to the next whole number. Otherwise, round down to the next whole number.

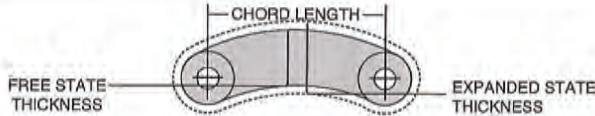

PipeSeal Dimensional Chart

SIZE	SEALING RANGE		CHORD LENGTH
	FREE STATE THICKNESS	EXPANDED STATE THICKNESS	
PS-200	0.500"	0.640"	1.125"
PS-275	0.620"	0.800"	0.910"
PS-300	0.710"	0.920"	1.510"
PS-315	0.820"	1.100"	1.470"
PS-325	0.940"	1.140"	3.100"
PS-340	1.050"	1.330"	1.570"
PS-360	1.290"	1.650"	2.106"
PS-400	1.430"	1.870"	3.625"
PS-410	1.480"	1.910"	2.600"
PS-425	1.130"	1.430"	3.625"
PS-475	1.620"	2.080"	2.625"
PS-500	2.370"	2.810"	3.860"
PS-525	2.180"	2.580"	3.860"
PS-575	1.880"	2.350"	3.100"
PS-600	3.200"	4.000"	6.000"

Examples:

- 5.92 → round up to 6
- 5.75 → round down to 5
- 15.92 → round down to 15

A sizing spreadsheet can also be found on our website at:
www.flexicraft.com/pipeseals/main/



INSTALLATION

PipeSeal installation can be just as important as PipeSeal selection. Follow these easy steps to ensure a good seal.

1. Make sure pipe is centered through out the sleeve or core opening. Plan on supporting the pipe at both ends as PipeSeals are not meant to act as supports and you should be able to adjust the pipe during seal installation.
2. Wrap the belt over the pipe as you begin installation. Make sure the bolt heads are facing the installer.
3. Connect the ends by passing the last bolt through the seal holes. Thread the bolt into the last pressure plate and tighten bolt head until snug.

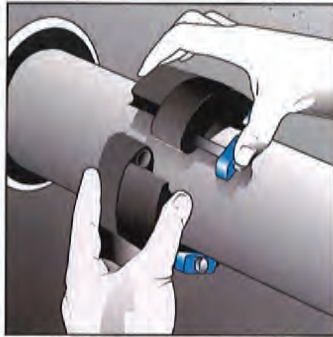

4. For larger sizes, begin inserting the assembly at the 6 O'clock position and push the remaining seal in on both sides as you move up towards the 12 O'clock position.

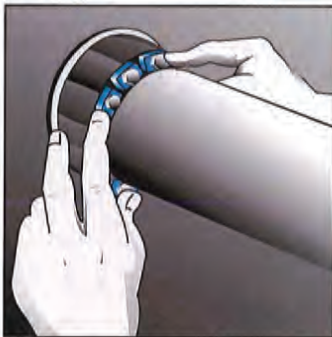

Use a light solution of soapy water as lubricant if needed.

5. Using a ratchet wrench, tighten each bolt moving about the belt in a clock-wise direction. Starting at the 12 o'clock position, tighten each bolt no more than 4 turns at a time until you start to see a slight bulge between each pressure plate. Expect to repeat this at least 3 times around the seal.

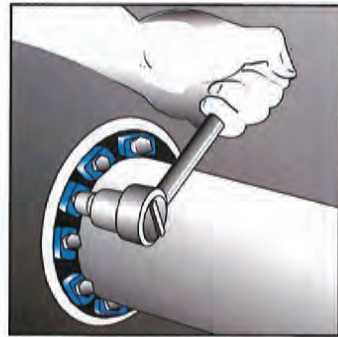

6. If the seal doesn't appear to be installed properly, contact Flexicraft.

MODEL	MIN. REQUIRED SEATING WIDTH
200	2.25
275	2.25
300	3
315	3
325	4
340	4
360	4
400	5
410	5
425	5
475	5
500	5
525	5
600	6

ATTENTION

- Always make sure the pipe and opening are clean and free of any irregularities.
- Using high speed power tools can lead to over torqueing.

PIPESEAL - WATERSEAL

PipeSeal forms a mechanical rubber seal between pipes going through walls, floors, vaults, tanks, and pipeline casings. PipeSeal makes a watertight seal between a pipe and a wall hole. It can also seal the gap between an inner pipe and an outer pipe sleeve or pipeline casing. It seals the gap between electrical conduit and the outer conduit, or between electrical conduit and the wall hole it passes through.

PipeSeal is designed to make a hydrostatic seal of up to 20 psig and up to 40 feet of head. The PipeSeal, in addition to its sealing properties, helps absorb vibrations, shocks, and sound waves. It also insulates the inner pipe from all other outer structures, including outer pipe sleeves, pipeline casings, walls and tanks.

PipeSeals are made from synthetic rubber with heavy-duty plastic or steel pressure plates, which are resistant to sunlight and ozone. All bolts and nuts are plated with an anti-corrosive coating. 316 Stainless steel bolts and nuts are also available.

- IPS** = Schd. 40 or Std. Weight Pipe Size
Plastic Pipe Size
API Pipe Size
Electrical Conduit Size
Or any pipe with same O.D.
- CI (SW)** = Cast Iron (Service Weight)
- CI (EH)** = Cast Iron (Extra Heavy)
- EMT** = Electrical Metallic Tubing
- CT** = Copper Tubing
Or any pipe with same O.D.
- LP** = Pipeline Pipe with coating of 50 mils approximately
- DI** = Ductile Iron Pipe Size
Plastic Pipe Size
Or any pipe with same O.D.

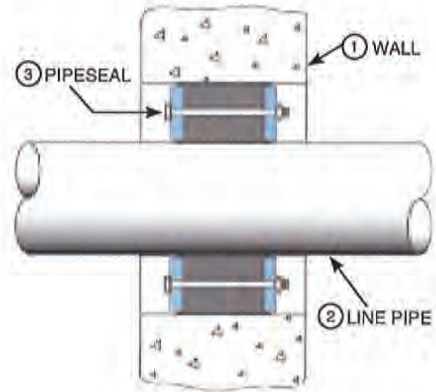
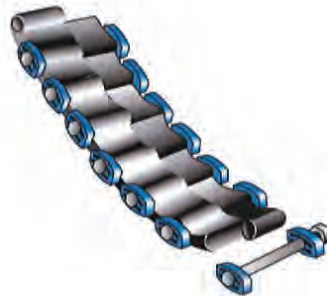

Qty.	Nominal Pipe Size & Type of Pipe	Pipe O.D.	Inner Pipe Through a Core Drilled Hole			Inner Pipe Through a Wall Sleeve			Notes
			Hole Dia.	Model No.	Qty. of Links	Sleeve I.D.	Model No.	Qty. of Links	

CUSTOMER _____
 PROJECT _____
 ENGINEER _____
 ARCHITECT _____
 PRO. OR P.O. NO _____



"Flexible Piping Solutions"

DESCRIPTION:

PIPESEAL



DRAWN BY:
P.B.

DATE:
1-1-02

DRAWING NO:
SEAL

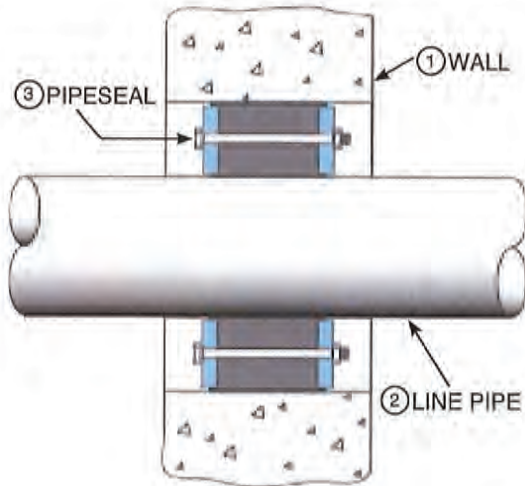

**PVC, CPVC, Rigid
Non-Metallic Conduit,
Core Drilled & Sleeved Hole**

**SYSTEM C-AJ-2369
FIRE SEAL**

**Additional Systems
C-AJ-1424 Metallic Pipe & Copper
Tubing Sleeved Hole**

**C-AJ-1423 Metallic Pipe &
Copper Tubing Core Drilled Hole**

1. Floor or Wall Assembly - Minimum 4-1/2" thick reinforced lightweight or normal weight (100-150 pcf) concrete. Wall may also be constructed of any UL Classified Concrete Blocks*. Max diameter of opening is 4 in.

See Concrete Block (CAZT) category in the Fire Resistance Directory for names of manufacturers.

2. Metallic Sleeve - (Optional) Nominal 4 in. diameter (or smaller) min .060 in. (or heavier) steel sleeve cast or grouted into floor or wall assembly, flush with floor or wall surfaces. If the firestop device (Item 4) is installed in a concrete block wall, the steel sleeve is required.



3. Through Penetrants - One nonmetallic pipe or conduit to be centered within the firestop system. The nominal annular space between the pipe, conduit or tubing and the periphery of the opening shall be minimum 5/8 in. to a max 13/16 in. The pipe or conduit to be rigidly supported on both sides of floor or wall. The following types and sizes of pipes or conduits may be used:

- A. Polyvinyl Chloride (PVC) Pipe** - Nominal 2 in. diameter (or smaller) Schedule 40 solid core PVC pipe for use in closed (process or supply) or vented (drain, waste, or vent) piping systems.
- B. Chlorinated Polyvinyl Chloride (CPVC) Pipe** - Nominal 2 in. diameter (or smaller) SDR 13.5 CPVC pipe for use in closed (process or supply) piping systems.
- C. Rigid NonMetallic Conduit +** - Nominal 2 in. diameter (or smaller) Schedule 40 PVC conduit installed in accordance with Article 347 of the National Electrical Code, (NFPA No. 70).

The F Rating of the firestop system is dependent upon the nominal diameter of the penetrant within the firestop system. If the nominal diameter of the penetrant within the firestop system is a nominal 1-1/4 in. or less, the F Rating is 2 hr. If the nominal diameter of the penetrant within the firestop system is greater than 1-1/4 in., the F Rating is 1 hr.

4. Firestop Device - The firestop device consists of rubber plugs, steel plates and steel bolts sized to fit within the annular space of the firestop system. The device to be wrapped around the outer circumference of the penetrant and installed to completely seal the annular space within the firestop system in accordance with the installation instructions. In floors, device to be installed within opening in such a manner that the device to be recessed a nominal 1/2 in. from the bottom surface of the floor. For walls having a nominal thickness of 8 in. or less, the device to be installed within the opening in such a manner that the device shall be recessed at minimum 1/2 in. to a max 1-1/2 in. from either surface. For walls having a nominal thickness greater than 8 in., a device to be installed on each side of the wall.

* Bearing the UL Classification Marking + Bearing the UL Listing Mark

CUSTOMER _____ PROJECT _____ ENGINEER _____ ARCHITECT _____ PRO. OR P.O. NO _____	 "Flexible Piping Solutions"
DESCRIPTION: PIPESEAL F2HR PVC, CPVC, RIGID NON-METALLIC CONDUIT 	
F-RATING: 2 HRS. & 1-1/2 HRS. T-RATING: 0 HRS.	
DRAWN BY: P.B. DATE: 1-1-02 DRAWING NO: C-AJ-2369	

Terms and Conditions

1. All quotations are subject to approval, acceptance and correction at the home office. Any errors in quotations resulting in orders will be corrected and re-submitted to the customer for their acceptance or refusal.

No prices may be made up from information other than that shown in the tables.

2. All prices are F.O.B. factory, Chicago, Illinois, are quoted exclusive of any taxes.

Shipments boxed for trans-ocean export add 10% to total trade price.

Terms: Net 30 days from date of invoice.

3. Cancellation or alteration of an order or return of any product by Buyer may not be made without advance written consent of manufacturer and shall be subjected to a cancellation charge.

A 35% minimum restocking charge shall be placed on any returned goods of stocked items. Fabricated items are not returnable.

4. We will not be responsible for delays in shipping due to conditions beyond our control such as strikes, fires, or accidents.

5. Any claims for shortages or damaged products must be made in writing within 10 days after receipt of shipment.

6. Prices subject to change without notice.

Design and Dimensional Specifications

The products illustrated reflect the design characteristics at time of printing.

Flexicraft reserves the right to change dimensions, materials, or methods of construction without notice. Please contact the factory for certified prints (exact dimensions) when necessary.

Limited Warranty

All products are warranted to be free of defects in material and workmanship for a period of one year from the date of shipment, subject to the limitations below.

If the purchaser believes a product is defective the purchaser shall: (a) Notify the manufacturer, state the alleged defect and request permission to return the product. (b) If permission given, return the product with transportation prepaid. If the product is accepted for return and found to be defective, the manufacturer will, at its discretion, either repair or replace the product F.O.B. factory, within 60 days of receipt, or refund the purchase price. Other than to repair, replace or refund as described above, purchaser agrees that manufacturer shall not be liable for any loss,

costs, expenses or damages of any kind arising out of the product, its use, installation or replacement, labeling, instructions, information or technical data of any kind, description of product or use, sample or model, warnings or lack of any of the foregoing. NO OTHER WARRANTIES, WRITTEN OR ORAL, EXPRESS OR IMPLIED, INCLUDING THE WARRANTIES OF FITNESS FOR A PARTICULAR PURPOSE AND MERCHANTABILITY, ARE MADE OR AUTHORIZED. NO AFFIRMATION OF FACT, PROMISE, DESCRIPTION OF PRODUCT OF USE OR SAMPLE OR MODEL SHALL CREATE ANY WARRANTY FROM THE MANUFACTURER, UNLESS SIGNED BY THE PRESIDENT OF MANUFACTURER. These products are not manufactured, sold or intended for personal, family or household purposes.

ETNA SUPPLY COMPANY RESERVES THE RIGHT TO FURNISH ANOTHER
MANUFACTURER WHOSE MATERIAL CONFORMS TO THE ENCLOSED
SPECIFICATIONS ON THE FOLLOWING ITEMS:

PVC SDR-35 SANITARY SEWER PIPE

PVC SDR-35/26 HEAVYWALL SEWER PIPE

PVC SDR-21 GASKETED PRESSURE PIPE

PVC SDR-26 GASKETED PRESSURE PIPE

AWWA C900 DR-18 PVC WATERMAIN

AWWA C900 DR-14 PVC WATERMAIN

PVC SCHEDULE 40 PIPE

PVC SCHEDULE 80 PIPE

AWWA C-905 DR-18 PVC WATERMAIN

AWWA C-905 DR-25 PVC WATERMAIN

HDPE PIPE AND FITTINGS

COPPER TUBING

FOR FURTHER QUESTIONS OR SPECIFICATIONS ON THE ABOVE
MATERIALS, PLEASE CONTACT US AT:

ETNA SUPPLY COMPANY
4901 CLAY AVE SW
GRAND RAPIDS, MI 49548
PHONE: (616) 241-5414
FAX: (616) 241-5485